

Brought to you by Eris Studios
NOT FOR RESALE

WIPER AND WASHER SYSTEMS

WIPER AND WASHER SYSTEMS

WIPER AND WASHER SYSTEMS

Brought to you by Eris Studios
NOT FOR RESALE

1. Wiper and Washer Systems

A: GENERAL

1. FRONT WIPER

- 1) The front wiper is of a tandem type featuring a wide wiping area. The blade is installed to the arm by means of U-hook joint to improve serviceability.
- 2) The front wiper operates in the HI and LOW speed modes and the INTERMITTENT mode. The operation modes can be selected by turning the wiper switch incorporated in the combination switch.
- 3) In the INTERMITTENT mode, the intermittent unit installed behind the combination switch controls the front wiper operation interval.
- 4) The front wiper system uses a modular construction in which the wiper motor forms an integral part of the linkage. The motor is installed on the body through rubber mounting.

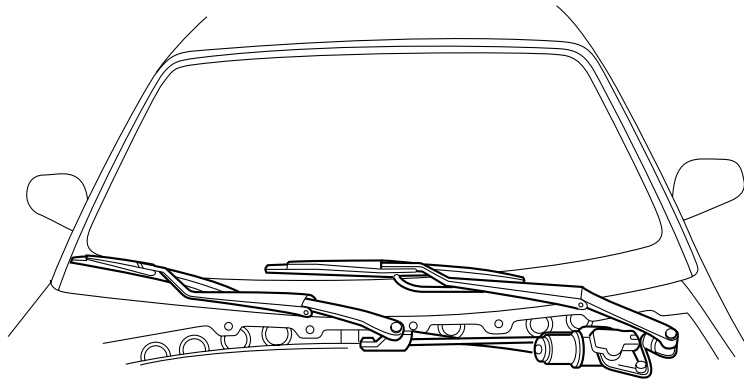

WW-00159

- 5) The size of the motor is minimized by changing the stator shape, coil windings and the magnet.

WIPER AND WASHER SYSTEMS

WIPER AND WASHER SYSTEMS

Brought to you by [unreadable] Studios
NOT FOR SALE

6) The mounting bracket is modified. The bracket of the wiper link assembly bracket area breaks if it receives a force exceeding a certain level to absorb the impact in case of a traffic accident, etc.

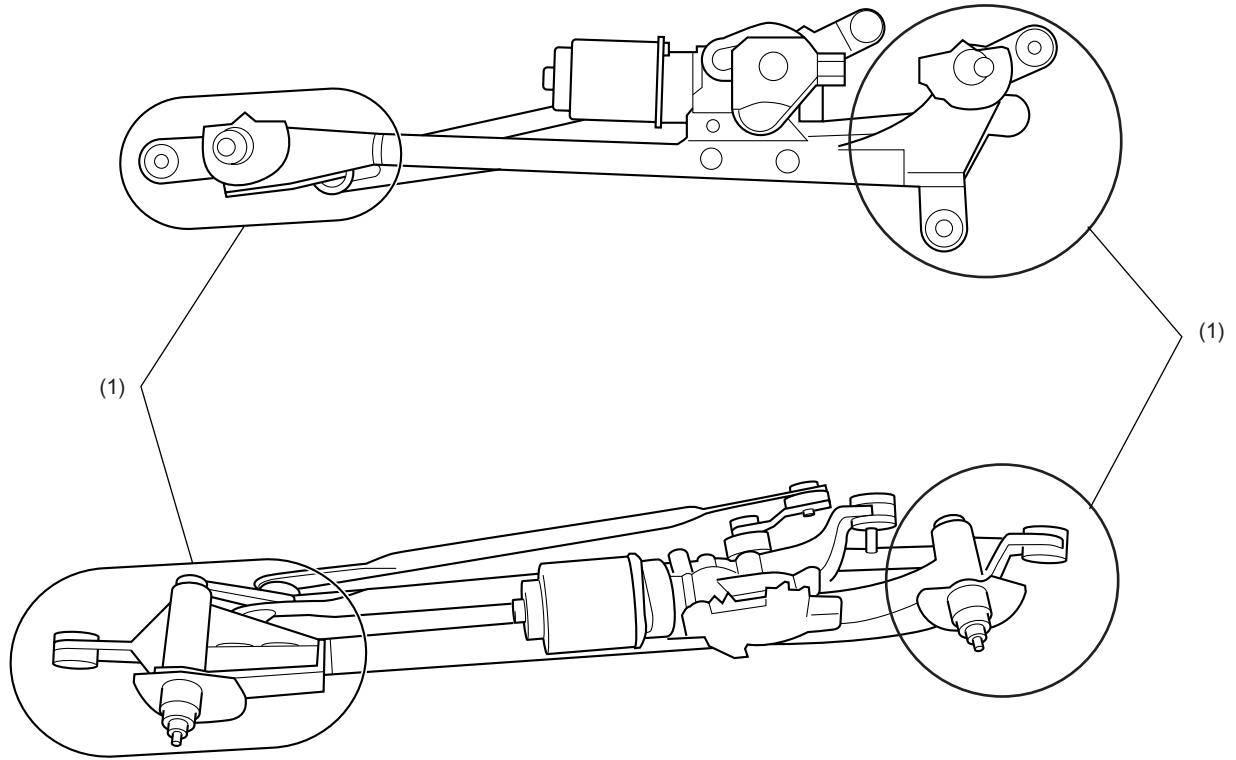

WW-00228

(1) Bracket

WIPER AND WASHER SYSTEMS

WIPER AND WASHER SYSTEMS

Brought to you by Eris Studios
NOT FOR RESALE

7) The driver's side wiper arm is angled to disperse the force applied to the wiper arm by the airflow. A part of the dispersed force acts to press the wiper blade against the windshield helping to prevent the wiper blade being lifted up.

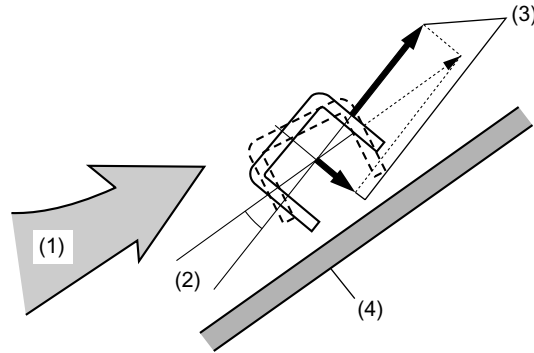

WW-00043

(1) Airflow

(2) Angle of twist

(3) Dispersed force

(4) Windshield

8) When wiper arms are raised in cases such as washing the car, always raise the driver's seat side wiper arm first and then raise the passenger's seat side wiper arm. If the passenger's seat side wiper arm is raised first, this will obstruct the way for the driver's side wiper arm. If forcibly raised in the wrong way, the passenger's side wiper arm may be damaged. When lowering the wiper arms, lower the passenger's side arm first.

WIPER AND WASHER SYSTEMS

WIPER AND WASHER SYSTEMS

Brought to you by  Studios
NOT FOR SALE

2. FRONT WASHER SYSTEM

- 1) The front washer system consists of a washer tank, motor and pump unit, and a pair of nozzles.
- 2) The washer tank is installed behind the front bumper under the left headlight.
- 3) The washer motor and pump unit is installed at the bottom of the washer tank.
- 4) The washer nozzles are installed to the front hood at its rear end and from the under side. Each nozzle has a spray hole.
- 5) Each washer nozzle has a check valve at a location approximately 100 mm (3.94 in) from the nozzle.
- 6) The washer tank is filled to its specified capacity when the fluid level is at the “FULL” mark on the filling pipe. Do not fill washer fluid until its level exceeds the “FULL” mark. The fluid may spill during driving or when replacing the head light bulb.

3. SPECIFICATIONS

Washer tank	Capacity	4.0 ℓ (4.2 US qt, 3.5 Imp qt)		
Wiper motor	Rated voltage	12 V		
	No-load current	4 A or less		
	Speed [at 2.0 N·m (20 kg-cm, 17 in-lb)]	HIGH	56 — 68 rpm	
		LOW	35 — 45 rpm	
	Motor characteristics when bound	HIGH	Torque	25.5 N·m (260 kg-cm, 1.88 ft-lb) or more
			Current	33 A or less
LOW		Torque	31.4 N·m (320 kg-cm, 2.31 ft-lb) or more	
		Current	29.0 A or less	
Wiper blade	Length	Driver side	600 mm (23.62 in)	
		Passenger side	450 mm (17.72 in)	

REAR WIPER AND WASHER

2. Rear Wiper and Washer

A: GENERAL

1. REAR WIPER

1) The rear wiper operates over an angle of 168°.

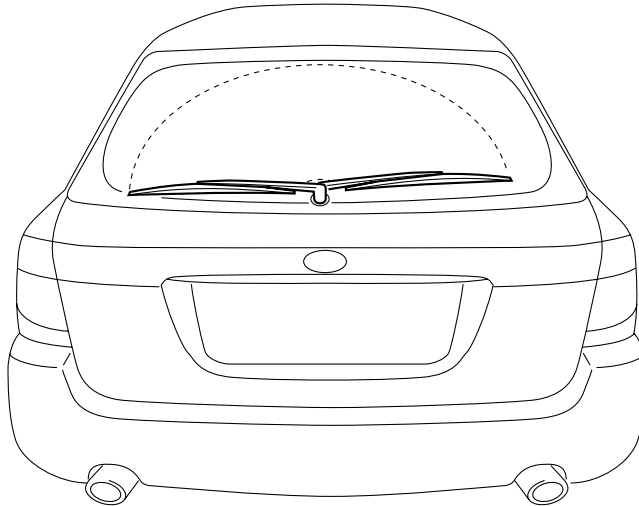

WW-00291

2) The rear wiper operates intermittently as shown in the following table only when the wiper switch is in the INT position on AT models.

Selector lever position (AT models only)	Vehicle speed km/h (MPH)	Interval (sec)
		Wagon
Reverse (R)	—	Continuous operation
Other than reverse (R)	0 — 20 (0 — 12.4)	12
	20 — 50 (12.4 — 31.1)	9
	50 — 80 (31.1 — 49.7)	6
	over 80 (49.7)	3

REAR WIPER AND WASHER

WIPER AND WASHER SYSTEMS

Brought to you by
NOT FOR SALE
Audios

2. REAR WASHER SYSTEM

- 1) The front and rear washers share the same washer tank.
- 2) The washer motor and pump unit is installed at the bottom of the washer tank.
- 3) The washer nozzle is installed to the lower part of the roof spoiler. The nozzle has two spray holes.
- 4) The washer nozzle is provided with a check valve, which is located just below it.

3. SPECIFICATIONS

Wiper motor	Rated voltage	12 V	
	No-load current	2 A or less	
	Speed [at 0.5 N·m (5 kg·cm, 4.3 in·lb)]	25 rpm or more	
	Motor characteristics when bound	Torque	8.8 N·m (0.90 kgf·m, 6 ft·lb) or more
Current		13 A or more	
Wiper blade	Length	350 mm (13.78 in)	

VEHICLE SPEED SENSITIVE INTERMITTENT WIPERS (FROM '06MY)

WIPER AND WASHER SYSTEMS

3. Vehicle Speed Sensitive Intermittent Wipers (From '06MY)

A: GENERAL

When the intermittent wiper is selected, the intermittent stop time is adjusted according to the vehicle speed to effectively secure visibility.

The control module built into the wiper switch assembly controls the intermittent stop time according to the vehicle speed signal provided from the body integrated unit.

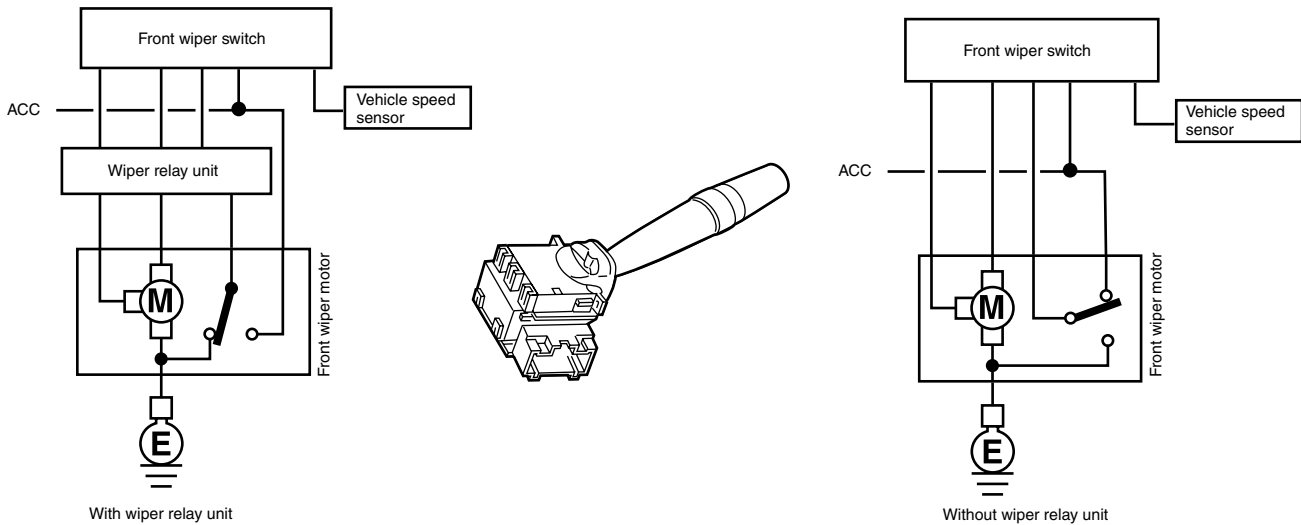

WW-00468

The intermittent stop time will change according to the selected position of the intermittent volume switch.

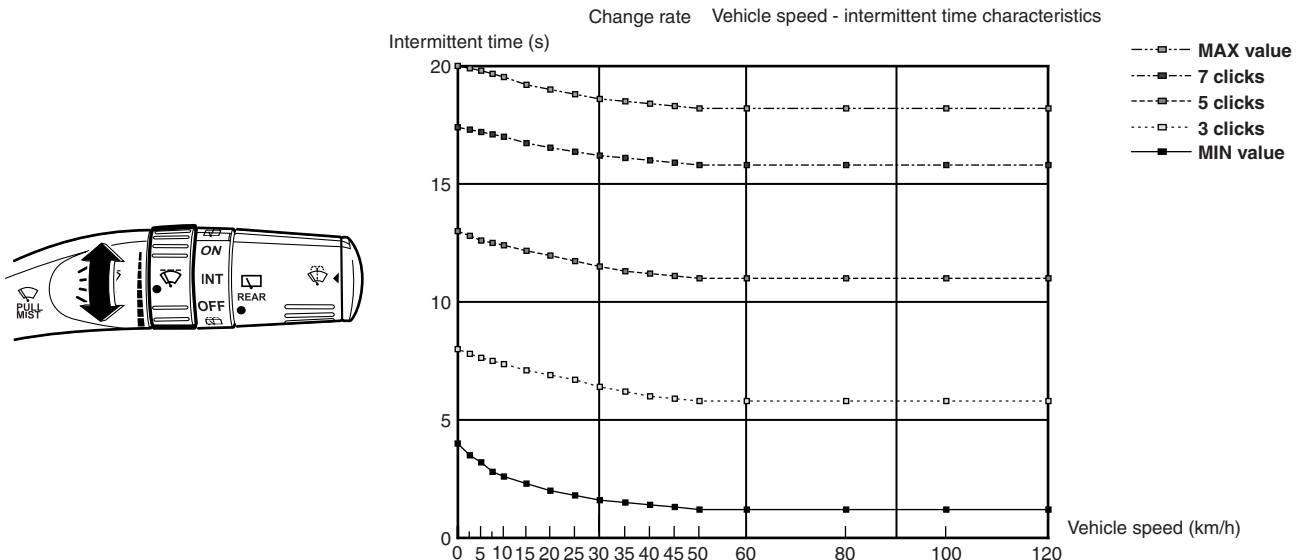

WW-00467

NOTE:

- The intermittent stop time in relation to vehicle speed is as shown in the figure, but this may differ from the actual speed.
- Only 5 levels are shown here, but in actual use, it will operate at all positions of the intermittent volume switch.