

Brought to you by Eris Studios
NOT FOR RESALE

TIRE PRESSURE MONITORING SYSTEM (DIAGNOSTICS)

Basic Diagnostic Procedure

TIRE PRESSURE MONITORING SYSTEM (DIAGNOSTICS)

Brought to you by Eris Studios
NOT FOR RESALE

1. Basic Diagnostic Procedure

A: PROCEDURE

CAUTION:

Remove foreign matter (dust, water, oil etc.) from the tire pressure monitoring control module connector when removing or installing.

NOTE:

To check harness for open or short circuits, shake the suspected trouble spot or connector.

Step	Check	Yes	No
1 CHECK PRE-INSPECTION. 1) Check with the user regarding when the warning light lit or started blinking. 2) Before performing diagnostics, check all components which may adversely affect the tire pressure monitor system. <Ref. to TPM(diag)-3, INSPECTION, General Description.>	Is the component that might affect the tire pressure monitor system normal?	Go to step 2.	Repair or replace each component.
2 CHECK DIAGNOSTIC TROUBLE CODE (DTC). 1) Turn the ignition switch to OFF. 2) Connect the Subaru Select Monitor to the data link connector. 3) Turn the ignition switch and run the Subaru Select Monitor. NOTE: If the communication function of the Subaru Select Monitor cannot be executed normally, check the communication circuit. <Ref. to TPM(diag)-11, COMMUNICATION FOR INITIALIZING IMPOSSIBLE, INSPECTION, Subaru Select Monitor.> 4) Read the DTC. <Ref. to TPM(diag)-16, OPERATION, Read Diagnostic Trouble Code (DTC).>	Is DTC displayed?	Go to step 4.	Go to step 3.
3 PERFORM GENERAL DIAGNOSTICS. 1) Perform the inspection by referring to "General Diagnostic Table". <Ref. to TPM(diag)-38, General Diagnostic Table.> 2) Perform the Clear Memory Mode. <Ref. to TPM(diag)-10, CLEAR MEMORY, OPERATION, Subaru Select Monitor.> 3) Perform the Inspection Mode. <Ref. to TPM(diag)-17, Inspection Mode.> 4) Read the DTC. <Ref. to TPM(diag)-8, READ DIAGNOSTIC TROUBLE CODE (DTC), OPERATION, Subaru Select Monitor.> Check that there is no DTC displayed.	Does the tire pressure warning light illuminates for about 2 seconds and then goes off after turning on the ignition switch, and then go out?	Finish the diagnosis.	Check by referring to "Diagnostic Procedure for TPM". <Ref. to TPM(diag)-14, WITHOUT DTC, INSPECTION, Subaru Select Monitor.>
4 PERFORM DIAGNOSIS. 1) Refer to "List of Diagnostic Trouble Code (DTC)". 2) Correct the cause of trouble. 3) Perform the Clear Memory Mode. <Ref. to TPM(diag)-10, CLEAR MEMORY, OPERATION, Subaru Select Monitor.> 4) Perform the drive test. Drive the vehicle at 40 km/h (25 MPH) or faster for at least 10 minutes. 5) Read the DTC. <Ref. to TPM(diag)-8, READ DIAGNOSTIC TROUBLE CODE (DTC), OPERATION, Subaru Select Monitor.>	Is DTC displayed?	Repeat steps 1 to 4 until DTC is not shown.	Finish the diagnosis.

General Description

TIRE PRESSURE MONITORING SYSTEM (DIAGNOSTICS)

Brought to you by Eris Studios
NOT FOR SALE

2. General Description

A: CAUTION

1. SUPPLEMENTAL RESTRAINT SYSTEM “AIRBAG”

Airbag system wiring harness is routed near the TPM control module.

CAUTION:

- All airbag system wiring harnesses are yellow. Do not use the electrical test equipment on these circuits.
- Be careful not to damage the airbag system wiring harness when servicing the tire pressure monitoring control module.

2. TIRE PRESSURE MONITORING CONTROL MODULE

- If the transmitter is replaced, ID registration for the transmitter is required. <Ref. to TPM(diag)-10, REGISTER TRANSMITTER ID, OPERATION, Subaru Select Monitor.>
- When adjusting tire pressure indoors in winter, there is a big temperature difference between the indoor facilities and outside. Once the car is outside where the temperature is lower, the air pressure in the tires will drop, causing the tire pressure warning light to illuminate, even if the pressure in the tires was adjusted to standard values indoors. To avoid this, it is necessary to adjust the tire pressure to the high side in consideration of the difference in temperature between inside and outside according to the following table.

235/45R17 and 245/40R18

Temperature °C (°F)	Indoor temperature	15.5 (60)		
	Ambient temperature	-1 (30)	-12 (10)	-23 (-10)
Air pressure kPa (psi)	Front	250 (36)	265 (38)	280 (40)
	Rear	240 (35)	255 (37)	270 (39)

B: INSPECTION

Before performing diagnosis, check the following item which might affect the quality of the tire pressure monitoring system.

1. TIRE

- Inspect that the tire pressure is within the specification while the tire is cool. (Refer to Tire Caution Label.)
- Check the tires for damage or the insertion of foreign matters.

2. BATTERY

Check that amount of battery fluid, gravity and voltage are within the specifications.

Standard voltage: 12 V or more

Specific gravity: 1.260 or more

General Description

TIRE PRESSURE MONITORING SYSTEM (DIAGNOSTICS)

Brought to you by Eris Studios
NOT FOR RESALE

C: PREPARATION TOOL

1. SPECIAL TOOL

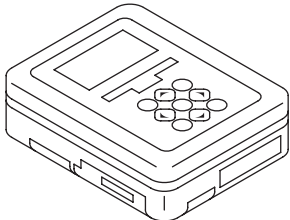
ILLUSTRATION	TOOL NUMBER	DESCRIPTION	REMARKS
 ST1B021XU0	1B021XU0	SUBARU SELECT MONITOR III KIT	Used for troubleshooting the electrical system.

2. GENERAL TOOL

TOOL NAME	REMARKS
Circuit tester	Used for measuring resistance, voltage and current.
Transmitter registration tool	Used to register the transmitter ID. Manufacturer: Kent-Moore Item number: J45295

Electrical Component Location

TIRE PRESSURE MONITORING SYSTEM (DIAGNOSTICS)

Brought to you by Eris Studios
NOT FOR SALE

3. Electrical Component Location

A: LOCATION

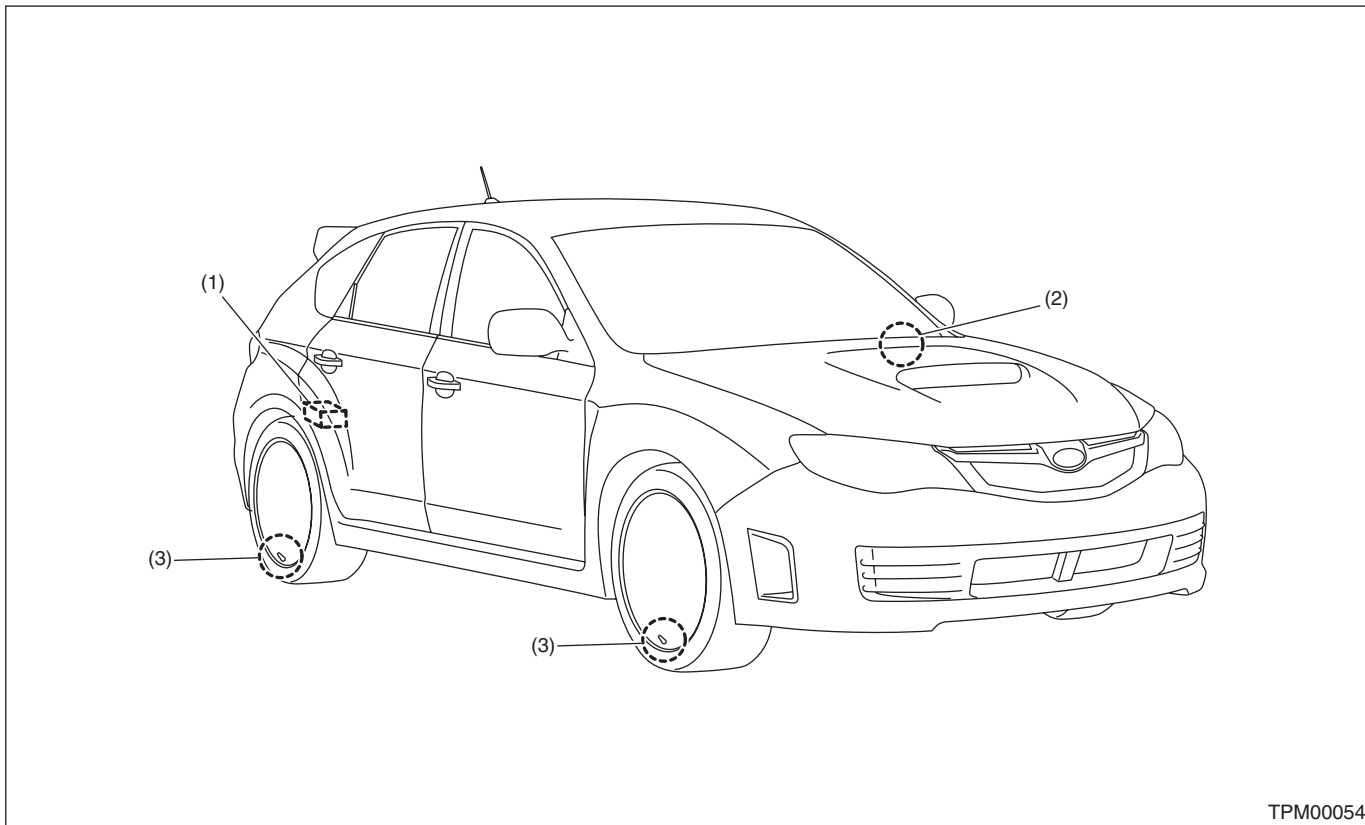

TPM00054

- (1) Tire pressure monitoring control module
- (2) Tire pressure warning light
- (3) Snap-in type transmitter

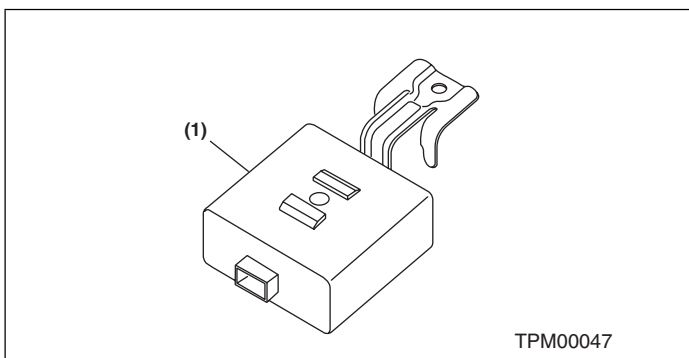

TPM00047

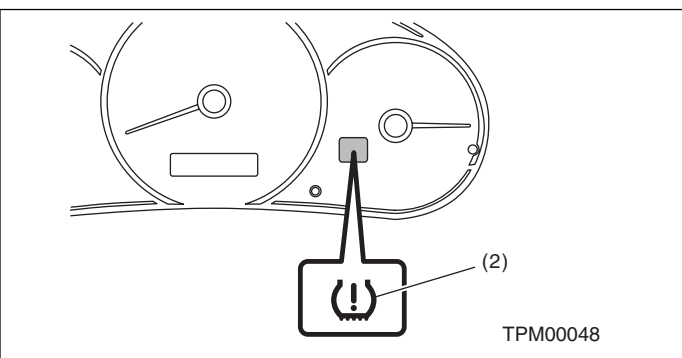

TPM00048

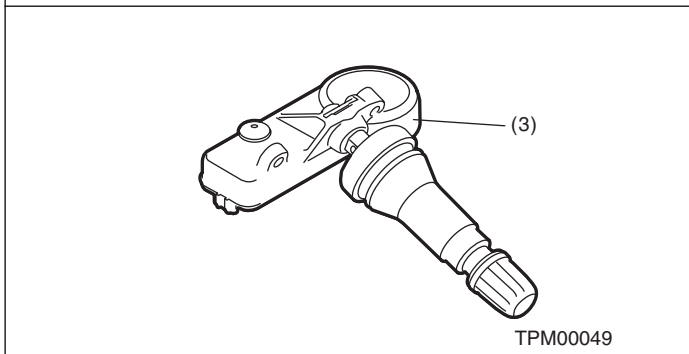

TPM00049

SUBARU.

Control Module I/O Signal

TIRE PRESSURE MONITORING SYSTEM (DIAGNOSTICS)

Brought to you by Eris Studios
NOT FOR RESALE

4. Control Module I/O Signal

A: ELECTRICAL SPECIFICATION

Terminal No.	Measured value	Measuring condition	Remarks
1	Select monitor communication	Serial communication	—
2	Tire pressure warning light output	Illuminate when malfunction occurs, or tire pressure decreases	System failure: blinks 25 times → illuminates Tire pressure decreases: turns on
4	Speed sensor signal	While driving (Pulse signal)	Change according to vehicle speed
5	Ignition power supply	IG switch ON (Battery voltage)	—
6	Battery power supply	Battery voltage	Always
8	Body integrated unit (Hazard output signal)	—	When hazard turns on
9	GND	0 V (Always)	Always

Control Module I/O Signal

TIRE PRESSURE MONITORING SYSTEM (DIAGNOSTICS)

Brought to you by Eris Studios
NOT FOR SALE

B: WIRING DIAGRAM

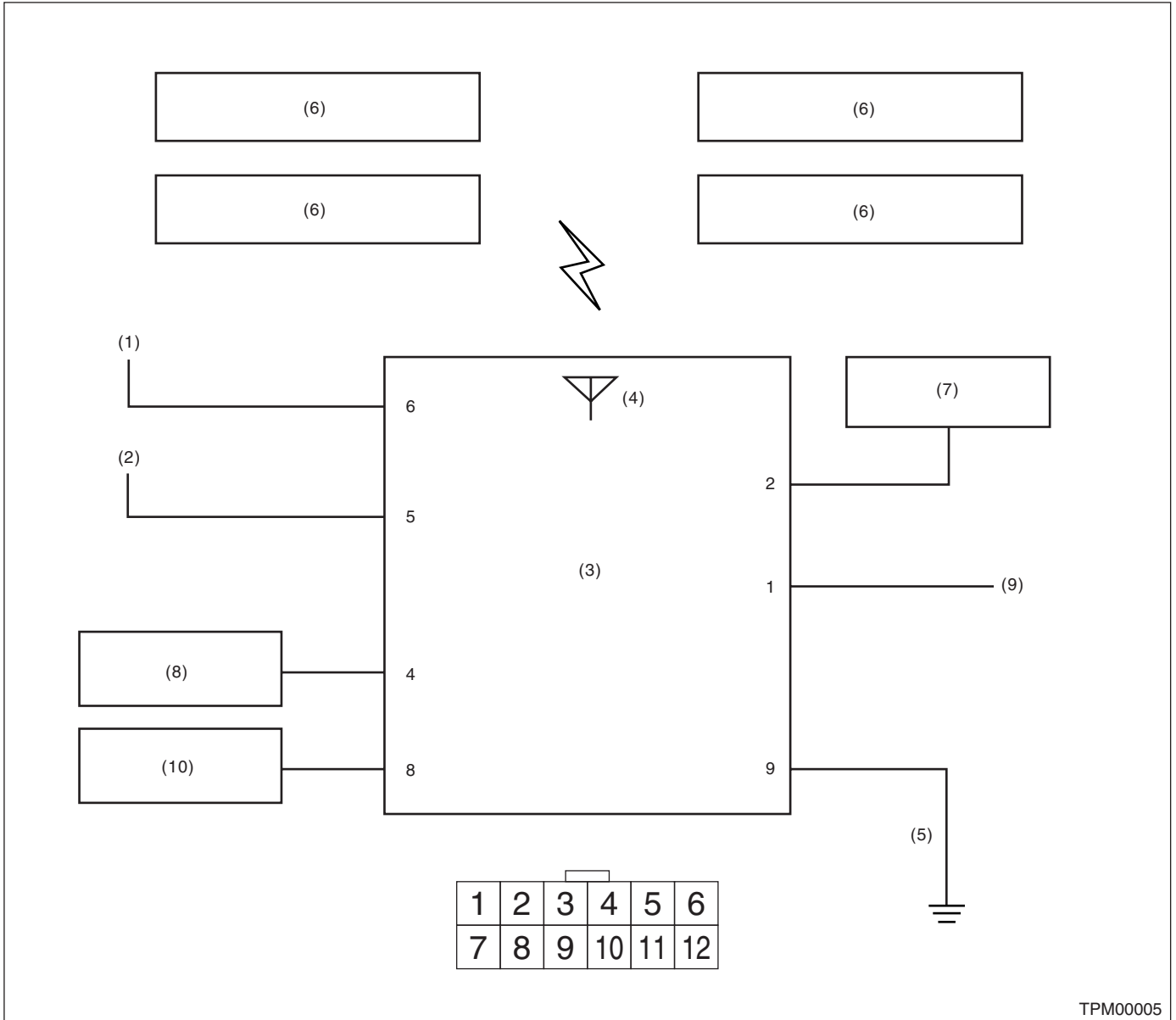

TPM00005

- | | | |
|---|-----------------------|---------------------------|
| (1) Battery power supply | (4) Antenna | (8) Vehicle speed signal |
| (2) Ignition power supply | (5) GND | (9) Subaru Select Monitor |
| (3) Tire pressure monitoring control module | (6) Transmitter | (10) Body integrated unit |
| | (7) Combination meter | |

5. Subaru Select Monitor

A: OPERATION

1. READ DIAGNOSTIC TROUBLE CODE (DTC)

1) Prepare the Subaru Select Monitor kit. <Ref. to TPM(diag)-4, SPECIAL TOOL, PREPARATION TOOL, General Description.>

2) Connect the diagnosis cable to the Subaru Select Monitor.

3) Connect the Subaru Select Monitor to the data link connector.

(1) The data link connector is located in the lower portion of the instrument panel (on the driver's side).

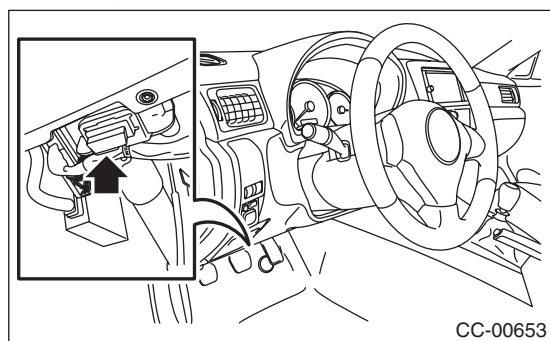

(1) Data link connector

(2) Connect the diagnosis cable to the data link connector.

CAUTION:

Do not connect the scan tools other than the Subaru Select Monitor.

4) Turn the ignition switch to ON (engine OFF) and run the Subaru Select Monitor.

5) On the «Main Menu» display screen, select {Each System Check}.

6) On the «System Selection Menu», select {Tire pressure monitor}.

7) After the {Tire pressure monitor} is displayed, select [OK].

8) On the «Tire pressure monitor diagnosis», select {Diagnostic Code(s) Display}.

NOTE:

- For details concerning the operation procedure, refer to the “PC application help for Subaru Select Monitor”.

- For details concerning DTCs, refer to List of Diagnostic Trouble Codes (DTC). <Ref. to TPM(diag)-26, List of Diagnostic Trouble Code (DTC).>

- All DTCs detected will be displayed.

- If a particular DTC is not properly stored in memory (due to a voltage drop of the tire air pressure monitor control module power supply, etc.) when a problem occurs, a DTC suffixed with a question mark will appear on the Subaru Select Monitor display. This shows it may be an unreliable reading.

9) If communication is not possible between the tire pressure monitoring control module and the Subaru Select Monitor, check the communication circuit. <Ref. to TPM(diag)-11, COMMUNICATION FOR INITIALIZING IMPOSSIBLE, INSPECTION, Subaru Select Monitor.>

10) When DTC is not displayed, check the indicator circuit and communication circuit. <Ref. to TPM(diag)-14, WITHOUT DTC, INSPECTION, Subaru Select Monitor.>

Subaru Select Monitor

TIRE PRESSURE MONITORING SYSTEM (DIAGNOSTICS)

Brought to you by Eris Studios
NOT FOR SALE

2. DATA DISPLAY

- 1) On the «Main Menu» display, select {Each System Check}.
 - 2) On the «System Selection Menu», select {Tire pressure monitor}.
 - 3) After the {Tire pressure monitor} is displayed, select [OK].
 - 4) On the «Tire pressure monitor diagnosis», select the {Data Display}, and then necessary data will be displayed.
- A list of the support data is shown in the following table.

1. Data monitor (Analog)

Display	Contents to be monitored	Unit of measure
Tire 1 FN code	LEARN, LOW BAT, OFF, WAKE, RE ME, NORMAL	LEARN: Transmitted transmitter ID using the transmitter registration tool LOW BAT: Transmitter battery voltage running low OFF: Transmitter function stops (no data transmission) RE ME: Tire air changes ± 8.4 kPa WAKE: When data transmission is started from a stopped state. NORMAL: Conditions other than above
Tire 2 FN code		
Tire 3 FN code		
Tire 4 FN code		
Tire 1 air pressure	Value converted to tire pressure from data delivered from transmitter is displayed. (The figure may differ from the actual measured values.)	kPa, psig, mmHg, inHg
Tire 2 air pressure		kPa, psig, mmHg, inHg
Tire 3 air pressure		kPa, psig, mmHg, inHg
Tire 4 air pressure		kPa, psig, mmHg, inHg
Vehicle Speed	Vehicle speed signal which is input in control module.	km/h, MPH
Pressure warning	Threshold where tire pressure warning light illuminates	kPa, psig, mmHg, inHg
Return pressure	Threshold where tire pressure warning light goes out	kPa, psig, mmHg, inHg

Subaru Select Monitor

TIRE PRESSURE MONITORING SYSTEM (DIAGNOSTICS)

Brought to you by Eris Studios
NOT FOR RESALE

3. CLEAR MEMORY

- 1) On the «Main Menu» display screen, select the {2. Each System Check}.
- 2) On the «System Selection Menu», select {Tire pressure monitor}.
- 3) After the {Tire pressure monitor} is displayed, select [OK].
- 4) On the «Tire pressure monitor diagnosis», select {Clear Memory}.
- 5) When “Done” and “Turn OFF the ignition switch” are shown on the display screen, end the Subaru Select Monitor and turn the ignition switch to OFF.

NOTE:

For details concerning the operation procedure, refer to the “PC application help for Subaru Select Monitor”.

4. REGISTER TRANSMITTER ID

Perform the procedures below to register the transmitter.

- Transmitter replaced.
- Replaced the tire pressure monitoring control module.

NOTE:

- If registration of the transmitter ID is not possible after 2 attempts, replace the tire pressure monitoring control module. <Ref. to WT-10, TIRE PRESSURE MONITORING CONTROL MODULE, REMOVAL, Tire Pressure Monitoring System.> <Ref. to WT-11, TIRE PRESSURE MONITORING CONTROL MODULE, INSTALLATION, Tire Pressure Monitoring System.>
- During the registration, turn the ignition switch to OFF and end the Subaru Select Monitor. Or if the registration is not performed for 5 minutes or more, the registration mode is cancelled.

- 1) Adjust all tire pressures to the specifications.
- 2) Connect Subaru Select Monitor and select {2. Each System Check} on the «Main Menu».
- 3) On the «System Selection Menu», select {Tire pressure monitor}.
- 4) After the {Tire pressure monitor} is displayed, select [OK].
- 5) On the «Tire pressure monitor diagnosis», select {Transmitter ID regist confirm}.
- 6) {ID registration mode when execute, Registered ID is deleted. Continue?} is displayed, select [OK].

- 7) Touch the transmitter registration tool to the side wall area near the air valve on tire, and press the switch. The transmitter ID is sent to the tire pressure monitoring control module. (At that time, the tire pressure warning light blinks to confirm that the registration has started.)

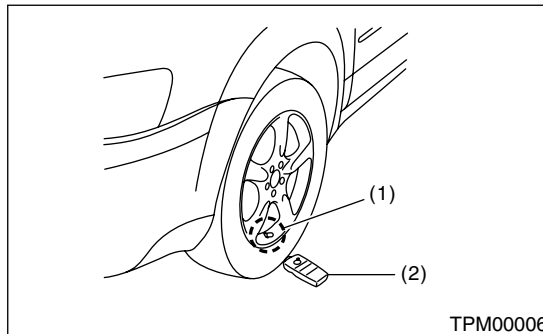

- (1) Air valve (transmitter)
- (2) Transmitter registration tool

NOTE:

- The registration order of transmitter ID is not specified.
 - The transmitter registration tool is used by touching the side wall area near the transmitter.
 - When registration of each tire is completed, the hazard light will blink and {ID registration completed} is displayed on the Select Monitor screen.
 - If registration procedure stop in the halfway (turning ignition switch to OFF, wrong registration order, etc), proceed from step 5).
- 8) When ID registration is completed, the tire pressure warning light remains lit for approximately 2 seconds, to end the registration. Switch to the screen displaying the transmitter ID on the Subaru Select Monitor display. <Ref. to TPM(diag)-10, DISPLAY TRANSMITTER (ID), OPERATION, Subaru Select Monitor.>
 - 9) Check the transmitter ID that was registered, then perform a driving test. <Ref. to TPM(diag)-17, PROCEDURE, Inspection Mode.>

5. DISPLAY TRANSMITTER (ID)

- 1) On the «Main Menu» display, select {Each System Check}.
- 2) On the «System Selection Menu», select {Tire pressure monitor}.
- 3) After the {Tire pressure monitor} is displayed, select [OK].
- 4) On the «Tire pressure monitor diagnosis», select {Transmitter ID regist confirm}.
- 5) Select the {Transmitter ID data monitor} and then select [OK] to display the transmitter ID.

Subaru Select Monitor

TIRE PRESSURE MONITORING SYSTEM (DIAGNOSTICS)

Brought to you by Eris Studios
NOT FOR SALE

B: INSPECTION

1. COMMUNICATION FOR INITIALIZING IMPOSSIBLE

DETECTING CONDITION:

Defective harness connector

TROUBLE SYMPTOM:

Communication is impossible between the tire pressure monitoring control module and the Subaru Select Monitor.

WIRING DIAGRAM:

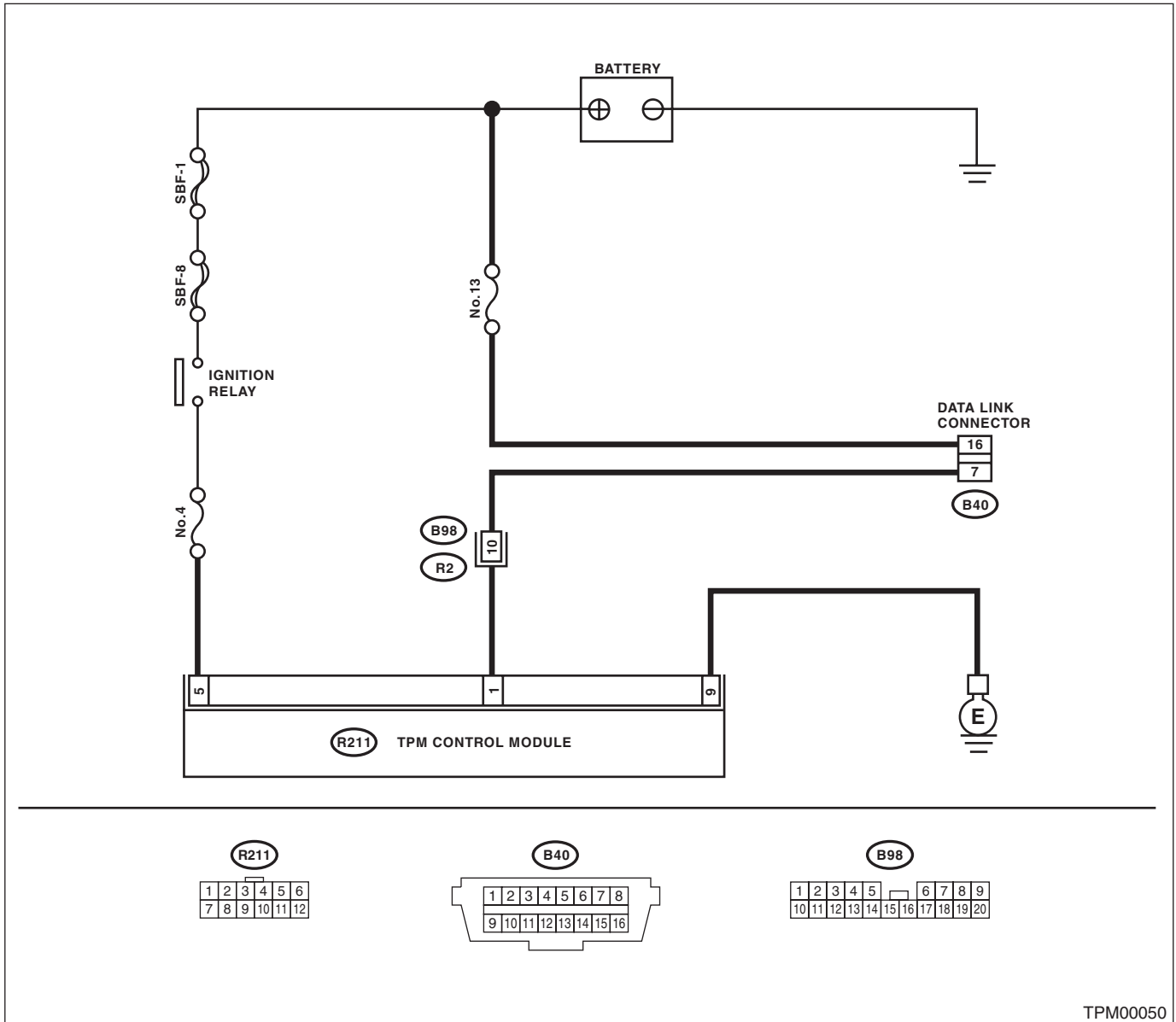

Subaru Select Monitor

TIRE PRESSURE MONITORING SYSTEM (DIAGNOSTICS)

Brought to you by Eris Studios
NOT FOR RESALE

	Step	Check	Yes	No
1	CHECK IGNITION SWITCH.	Is the ignition switch ON?	Go to step 2.	Turn the ignition switch to ON, and select TPM mode using Subaru Select Monitor.
2	CHECK BATTERY.	Is the voltage 11 V or more?	Go to step 3.	Charge or replace the battery.
3	CHECK BATTERY TERMINAL.	Is there poor contact at battery terminal?	Repair or tighten the battery terminal.	Go to step 4.
4	CHECK SUBARU SELECT MONITOR COMMUNICATION. 1) Turn the ignition switch to ON. 2) Using the Subaru Select Monitor, check whether communication to other systems can be performed normally.	Is the system name displayed on Subaru Select Monitor?	Go to step 8.	Go to step 5.
5	CHECK SUBARU SELECT MONITOR COMMUNICATION. 1) Turn the ignition switch to OFF. 2) Disconnect the tire pressure monitoring control module connector. 3) Turn the ignition switch to ON. 4) Check whether communication to other systems can be executed normally.	Is the system name displayed on Subaru Select Monitor?	Replace the tire pressure monitoring control module. <Ref. to WT-10, TIRE PRESSURE MONITORING CONTROL MODULE, REMOVAL, Tire Pressure Monitoring System.>	Go to step 6.
6	CHECK HARNESS CONNECTOR BETWEEN EACH CONTROL MODULE AND DATA LINK CONNECTOR. 1) Turn the ignition switch to OFF. 2) Disconnect the tire pressure monitoring control module. 3) Measure the resistance between data link connector and chassis ground. Connector & terminal (B40) No. 7 — Chassis ground:	Is the resistance 1 M Ω or more?	Go to step 7.	Repair the harness and connector between each control module and data link connector.
7	CHECK THE TIRE PRESSURE MONITORING CONTROL MODULE OUTPUT SIGNAL. 1) Turn the ignition switch to ON. 2) Measure the voltage between tire pressure monitoring control module and chassis ground. Connector & terminal (B40) No. 7 (+) — Chassis ground (-):	Is the voltage less than 1 V?	Go to step 8.	Repair the harness and connector between each control module and data link connector.
8	CHECK HARNESS CONNECTOR BETWEEN TIRE PRESSURE MONITORING CONTROL MODULE AND DATA LINK CONNECTOR. Measure the resistance between tire pressure monitoring control module and data link connector. Connector & terminal (R211) No. 1 — (B40) No. 7:	Is resistance less than 0.5 Ω ?	Go to step 9.	Repair the harness and connector between tire pressure monitoring control module and data link connector.
9	CHECK TIRE PRESSURE MONITORING CONTROL MODULE CONNECTOR. Turn the ignition switch to OFF.	Is the tire pressure monitoring control module connector inserted in the tire pressure monitoring control module until it locks?	Go to step 10.	Insert the tire pressure monitoring control module connector into the tire pressure monitoring control module.

Subaru Select Monitor

TIRE PRESSURE MONITORING SYSTEM (DIAGNOSTICS)

Brought to you by Eris Studios
 NOT FOR SALE

Step	Check	Yes	No
10 CHECK POWER SUPPLY CIRCUIT. 1) Turn the ignition switch to ON. (engine OFF) 2) Measure the ignition power voltage between tire pressure monitoring control module connector and chassis ground. Connector & terminal (R211) No. 5 (+) — Chassis ground (-):	Is the voltage 10 — 15 V?	Go to step 11.	Repair open circuit of the harness between the tire pressure monitoring control module and battery.
11 CHECK HARNESS CONNECTOR BETWEEN TIRE PRESSURE MONITORING CONTROL MODULE AND CHASSIS GROUND. 1) Turn the ignition switch to OFF. 2) Disconnect the connector from the tire pressure monitoring control module. 3) Measure the resistance of harness between tire pressure monitoring control module and chassis ground. Connector & terminal (R211) No. 9 — Chassis ground:	Is the resistance less than 0.5 Ω?	Go to step 12.	Repair open circuit of the harness of the tire pressure monitoring control module.
12 CHECK POOR CONTACT OF CONNECTOR.	Is there poor contact in tire pressure monitoring control module power supply, ground circuit and data link connector?	Repair the connector.	Replace the tire pressure monitoring control module. <Ref. to WT-10, TIRE PRESSURE MONITORING CONTROL MODULE, REMOVAL, Tire Pressure Monitoring System.>

Subaru Select Monitor

TIRE PRESSURE MONITORING SYSTEM (DIAGNOSTICS)

Brought to you by Eris Studios
NOT FOR RESALE

2. WITHOUT DTC

DETECTING CONDITION:

- Defective combination meter
- Defective harness

TROUBLE SYMPTOM:

- Tire pressure warning light does not go off.
- "NO TROUBLE CODE" will be displayed on the Subaru Select Monitor.

NOTE:

When the tire pressure warning light is OFF and "NO TROUBLE CODE" is displayed on Subaru Select Monitor, the system is in a normal condition.

WIRING DIAGRAM:

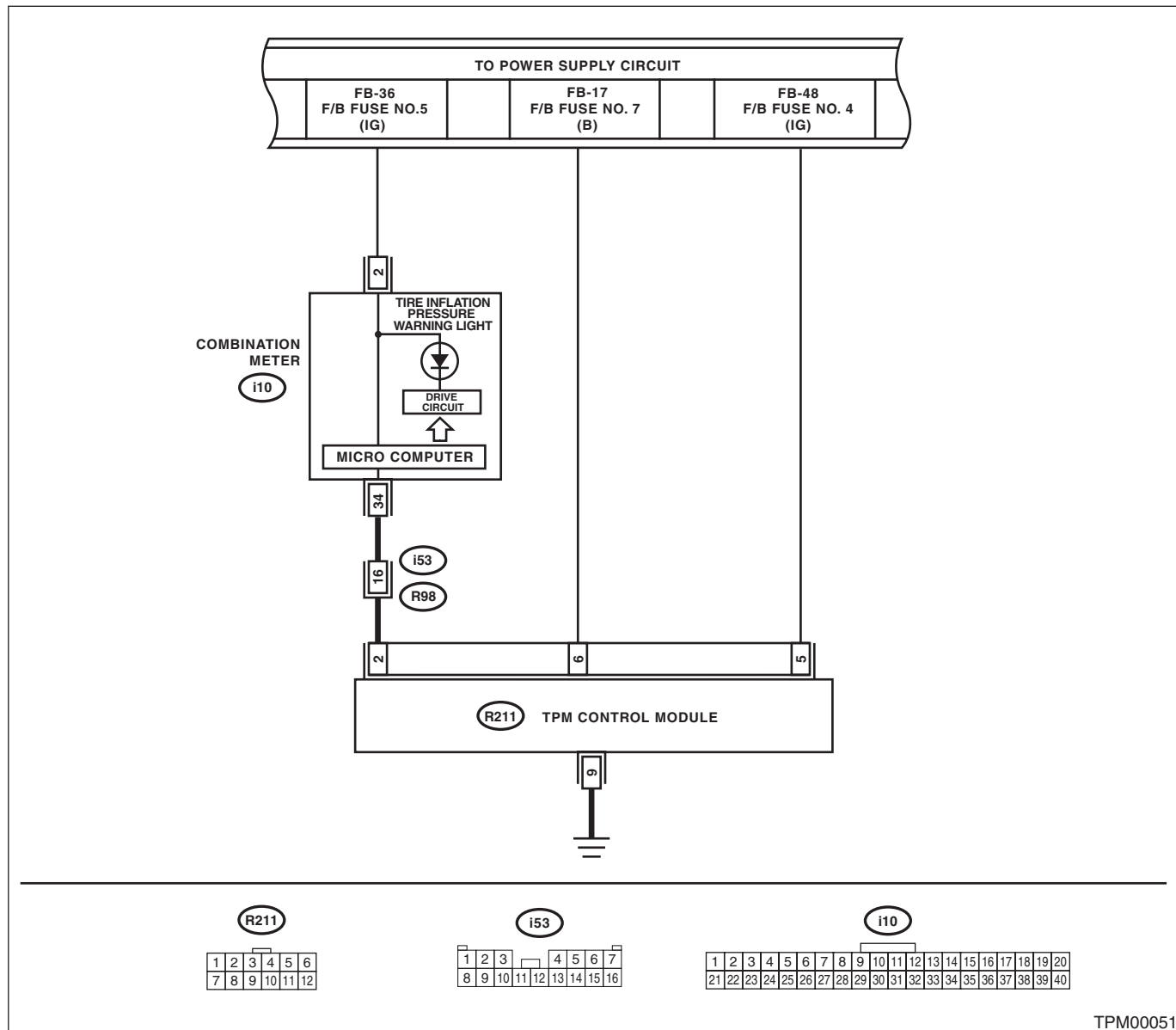

Subaru Select Monitor

TIRE PRESSURE MONITORING SYSTEM (DIAGNOSTICS)

Brought to you by Eris Studios
 NOT FOR SALE

Step	Check	Yes	No
1 CHECK SUBARU SELECT MONITOR DATA. 1) Select {Current Data Display & Save} in Subaru Select Monitor. 2) Read the data of the "Tire pressure warning light".	Is "ON" indicated?	Replace the tire pressure monitoring control module. <Ref. to WT-10, TIRE PRESSURE MONITORING CONTROL MODULE, REMOVAL, Tire Pressure Monitoring System.>	Go to step 2.
2 CHECK WIRING HARNESS. Measure the resistance between tire pressure monitoring control module and combination meter connector. <i>Connector & terminal (i10) No. 34 — (R211) No. 2:</i>	Is the resistance less than 0.5 Ω?	Go to step 3.	Repair the harness and connector between tire pressure monitoring control module and combination meter.
3 CHECK POOR CONTACT OF CONNECTOR.	Is there poor contact in the tire pressure monitoring control module connector and combination meter connector?	Repair the connector.	Check the combination meter.

Read Diagnostic Trouble Code (DTC)

TIRE PRESSURE MONITORING SYSTEM (DIAGNOSTICS)

6. Read Diagnostic Trouble Code (DTC)

A: OPERATION

For details concerning DTC reading procedure, refer to "Subaru Select Monitor". <Ref. to TPM(diag)-8, Subaru Select Monitor.>

Brought to you by Eris Studios
NOT FOR RESALE

Brought to you by Eris Studios
NOT FOR SALE

7. Inspection Mode

A: PROCEDURE

Reproduce the malfunction occurrence condition as much as possible. Drive the vehicle at 40 km/h (25 MPH) or faster for at least ten minutes.

Clear Memory Mode

TIRE PRESSURE MONITORING SYSTEM (DIAGNOSTICS)

8. Clear Memory Mode

A: OPERATION

For details concerning DTC clear operation, refer to "Subaru Select Monitor". <Ref. to TPM(diag)-8, Subaru Select Monitor.>

Brought to you by Eris Studios
NOT FOR RESALE

Bring us your
 NO. 1000
 SALE
 Eris Studios

9. Tire Pressure Warning Light / Trouble Indicator Light Illumination Pattern

A: INSPECTION

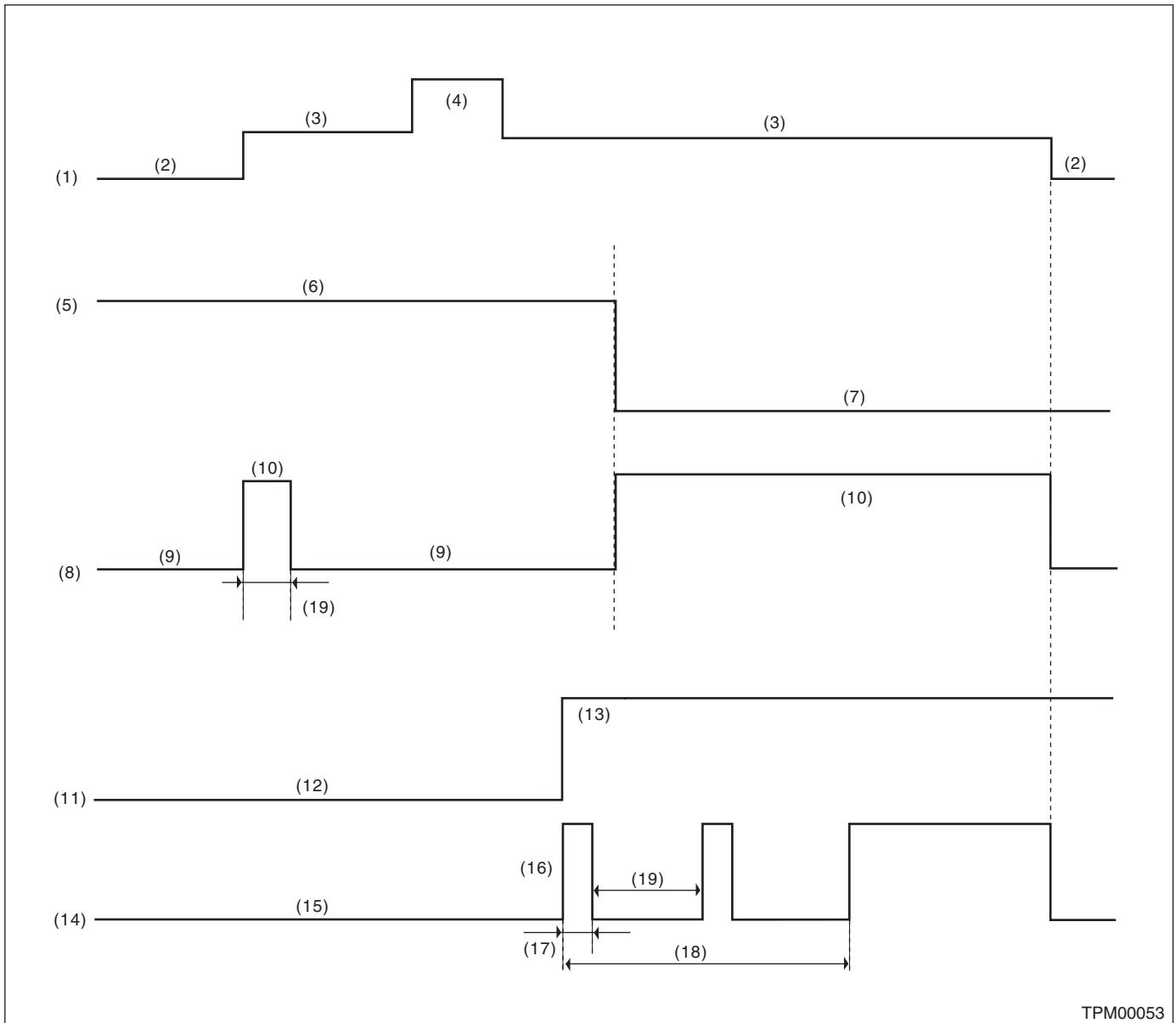

TPM00053

- | | | |
|---|---------------------------------|----------------------|
| (1) Ignition switch | (8) Tire pressure warning light | (15) Light OFF |
| (2) OFF | (9) Light OFF | (16) Blink |
| (3) ON | (10) Light ON | (17) 1 second |
| (4) Start | (11) System status | (18) Blinks 25 times |
| (5) Tire pressure | (12) Normal | (19) 2 seconds |
| (6) Meet the specification | (13) Malfunction | |
| (7) 186 kPa (1.86 kgf/cm ² , 27 psi) or less | | |

Tire Pressure Warning Light / Trouble Indicator Light Illumination Pattern

TIRE PRESSURE MONITORING SYSTEM (DIAGNOSTICS)

1) When the tire pressure warning light does not illuminate in accordance with this illumination pattern, there must be an electrical malfunction.

2) If the tire pressure warning light does not go off, check the tire pressure monitoring control module/warning light circuit and the combination meter circuit. <Ref. to TPM(diag)-22, TIRE PRESSURE WARNING LIGHT DOES NOT COME OFF, Tire Pressure Warning Light / Trouble Indicator Light Illumination Pattern.>

NOTE:

If the problem is fixed while driving at approximately 40 km/h (25 MPH) after the tire pressure warning light blinks/lights, the warning light goes out and the tire pressure monitor system operates normally. (If there is a decrease in tire pressure, or a malfunction of the system, the malfunction history is displayed.)

Tire Pressure Warning Light / Trouble Indicator Light Illumination Pattern

TIRE PRESSURE MONITORING SYSTEM (DIAGNOSTICS)

B: TIRE PRESSURE WARNING LIGHT DOES NOT COME ON

DETECTING CONDITION:

Defective combination meter

TROUBLE SYMPTOM:

When the ignition switch is turned to ON (engine OFF), the tire pressure warning light does not come on (for approximately 2 seconds).

WIRING DIAGRAM:

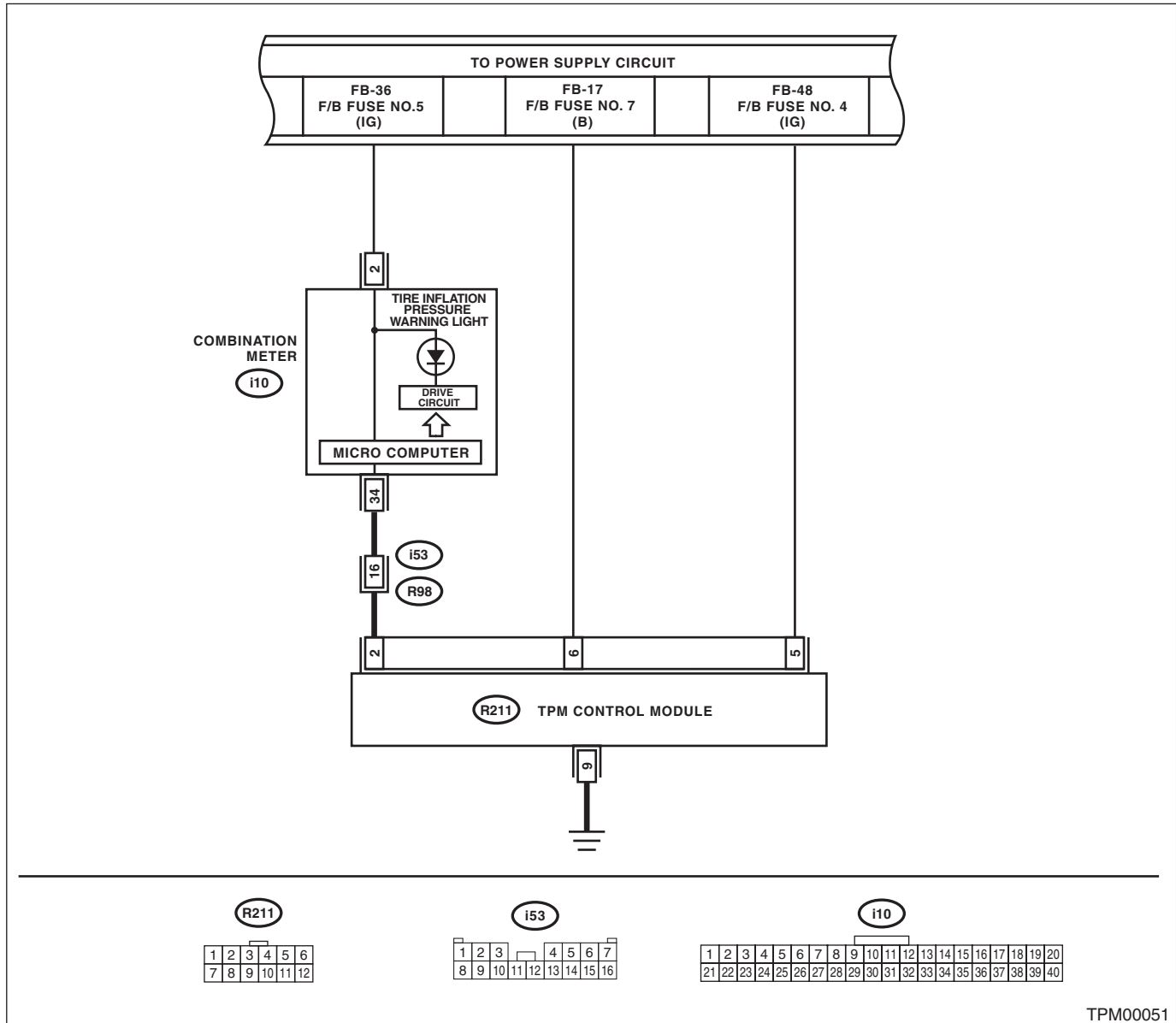

TPM00051

Step	Check	Yes	No	
1	<p>CHECK DIAGNOSTIC TROUBLE CODE (DTC). Connect the Subaru Select Monitor, and read the Diagnostic Trouble Code. <Ref. to TPM(diag)-8, READ DIAGNOSTIC TROUBLE CODE (DTC), OPERATION, Subaru Select Monitor.></p>	<p>Is diagnostics code (DTC) displayed?</p>	<p>Perform the diagnosis according to the DTC. <Ref. to TPM(diag)-26, List of Diagnostic Trouble Code (DTC).></p>	<p>Replace the combination meter. <Ref. to IDI-13, REMOVAL, Combination Meter.></p>

Tire Pressure Warning Light / Trouble Indicator Light Illumination Pattern

TIRE PRESSURE MONITORING SYSTEM (DIAGNOSTICS)

Brought to you by Eris Studios
NOT FOR RESALE

C: TIRE PRESSURE WARNING LIGHT DOES NOT COME OFF

DETECTING CONDITION:

- Defective combination meter
- Tires pressure drop
- Transmitter ID not registered

TROUBLE SYMPTOM:

Tire pressure warning light remains illuminating after engine starts.

WIRING DIAGRAM:

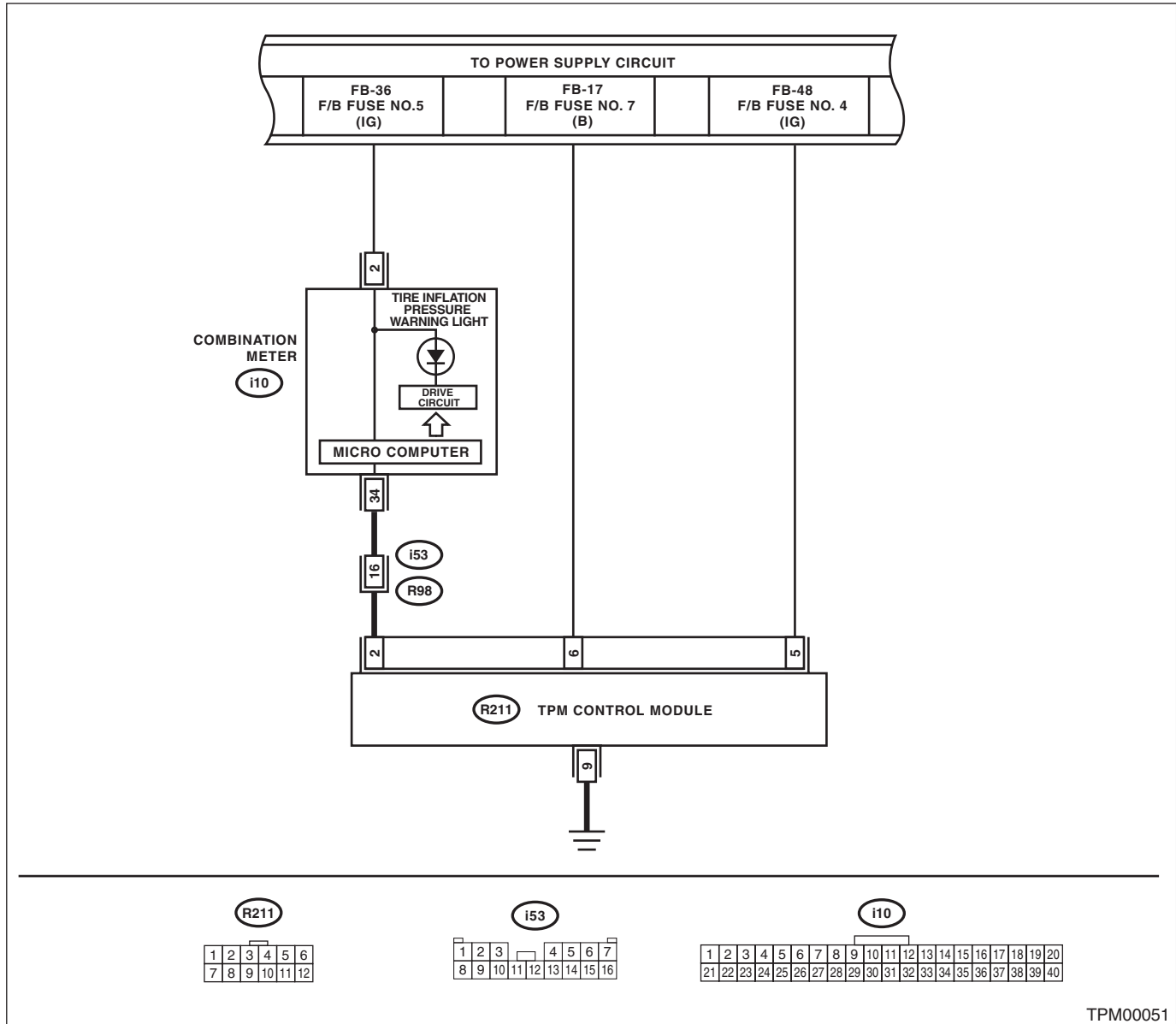

TPM00051

Tire Pressure Warning Light / Trouble Indicator Light Illumination Pattern

TIRE PRESSURE MONITORING SYSTEM (DIAGNOSTICS)

Step	Check	Yes	No
1 CHECK DIAGNOSTIC TROUBLE CODE (DTC). Connect the Subaru Select Monitor, and read the Diagnostic Trouble Code. <Ref. to TPM(diag)-8, READ DIAGNOSTIC TROUBLE CODE (DTC), OPERATION, Subaru Select Monitor.>	Is DTC displayed?	Perform the diagnosis according to the DTC. <Ref. to TPM(diag)-26, List of Diagnostic Trouble Code (DTC).>	Go to step 2.
2 CHECK TRANSMITTER (ID). Display the transmitter ID of the tire pressure monitor system.	Is the transmitter ID registered?	Go to step 3.	Register the transmitter ID. <Ref. to TPM(diag)-10, REGISTER TRANSMITTER ID, OPERATION, Subaru Select Monitor.>
3 CHECK TRANSMITTER DATA OUTPUT. 1) Select data display of the tire pressure monitoring. 2) Start the engine and check the tire pressure warning light output.	Is the warning light output ON?	Replace the tire pressure monitoring control module. <Ref. to WT-10, TIRE PRESSURE MONITORING CONTROL MODULE, REMOVAL, Tire Pressure Monitoring System.>	Replace the combination meter. <Ref. to IDI-13, REMOVAL, Combination Meter.>

Tire Pressure Warning Light / Trouble Indicator Light Illumination Pattern

TIRE PRESSURE MONITORING SYSTEM (DIAGNOSTICS)

Brought to you by Eris Studios
NOT FOR RESALE

D: TIRE PRESSURE WARNING LIGHT IS 25 TIMES BLINKING AND TURN ON DETECTING CONDITION:

- Tire pressure monitoring control module is faulty.
- Defective harness
- Transmitter is faulty.

TROUBLE SYMPTOM:

Every time the engine starts, tire pressure warning light blinks 25 times and then illuminates.

WIRING DIAGRAM:

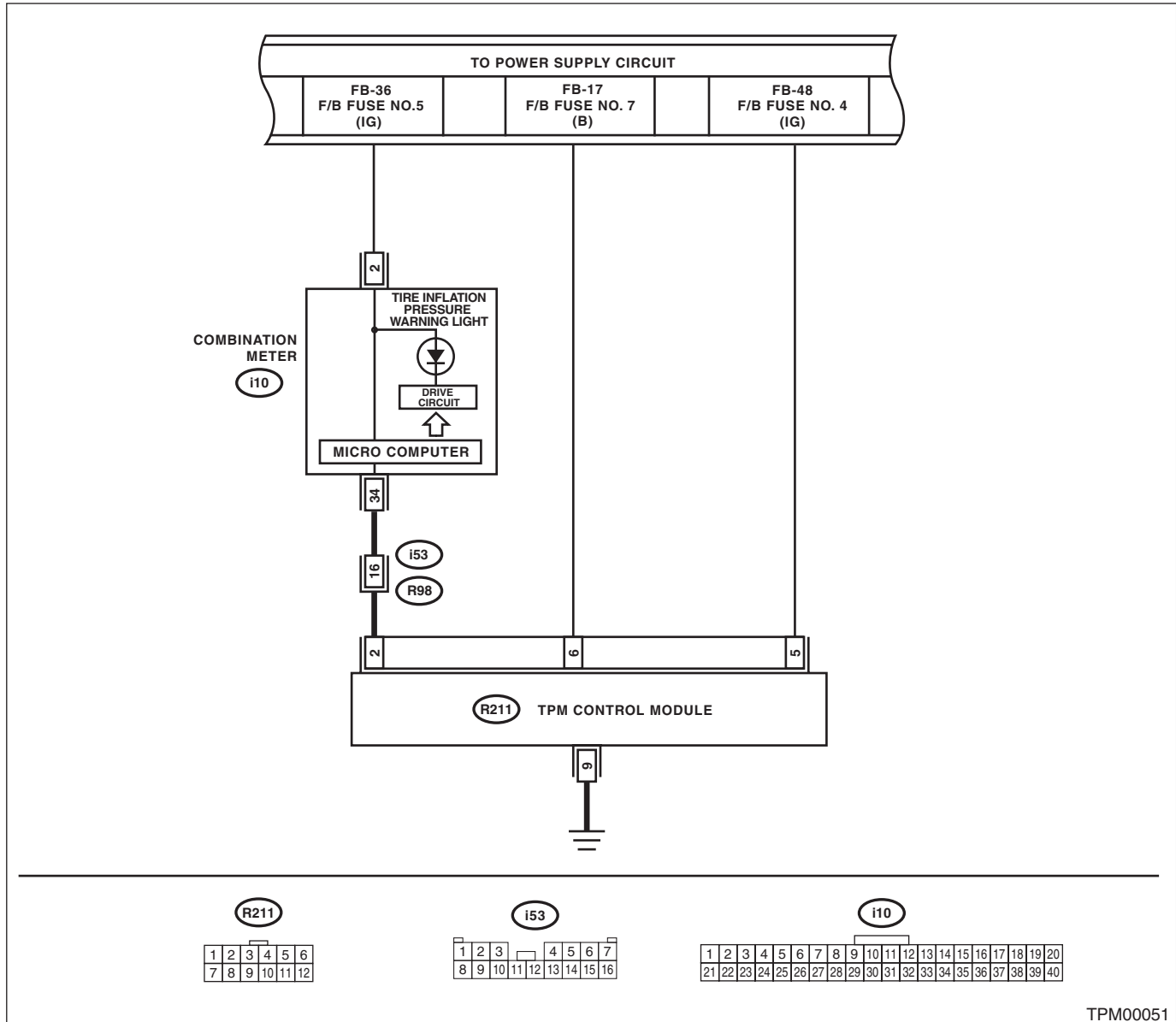

TPM00051

Tire Pressure Warning Light / Trouble Indicator Light Illumination Pattern

TIRE PRESSURE MONITORING SYSTEM (DIAGNOSTICS)

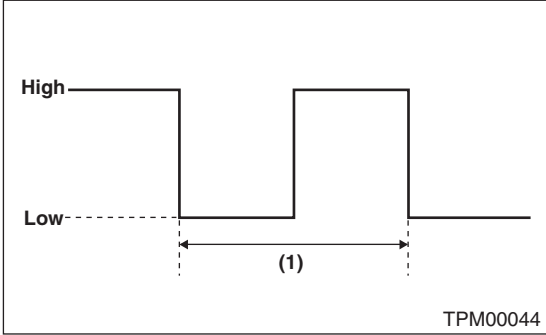
Step	Check	Yes	No
1 CHECK DIAGNOSTIC TROUBLE CODE (DTC). Connect the Subaru Select Monitor, and read the Diagnostic Trouble Code. <Ref. to TPM(diag)-8, READ DIAGNOSTIC TROUBLE CODE (DTC), OPERATION, Subaru Select Monitor.>	Is diagnostics code (DTC) displayed?	Perform the diagnosis according to the DTC. <Ref. to TPM(diag)-26, List of Diagnostic Trouble Code (DTC).>	Go to step 2.
2 CHECK HARNESS. 1) Connect the Subaru Select Monitor to the terminal No. 2 of the tire pressure monitoring control module connector (R211). Connector & terminal (R211) No. 2 (+) — Chassis ground (-): 2) Turn the ignition switch to ON, and select "Oscilloscope" from the Main Menu of Subaru Select Monitor. 3) Check the voltage displayed.	Is the voltage 10 V or more?	Go to step 3.	Go to step 4.
3 CHECK HARNESS. 1) Check the output waveform displayed in the oscilloscope of Subaru Select Monitor. 	Is the pattern the same output waveform as shown in the figure? (1) 400±20 ms Duty 50 % High: Battery voltage Low: 1.5 V or less	Check the combination meter.	Replace the tire pressure monitoring control module. <Ref. to WT-10, REMOVAL, Tire Pressure Monitoring System.>
4 CHECK HARNESS. 1) Disconnect the tire pressure monitoring control module connector. 2) Connect the Subaru Select Monitor to the terminal No. 2 of the tire pressure monitoring control module connector (R211). Connector & terminal (R211) No. 2 (+) — Chassis ground (-): 3) Turn the ignition switch to ON, and select "Oscilloscope" from the Main Menu of Subaru Select Monitor. 4) Check the voltage displayed.	Is the voltage 10 V or more?	Replace the tire pressure monitoring control module. <Ref. to WT-10, REMOVAL, Tire Pressure Monitoring System.>	The harness between the combination meter connector and the tire pressure monitoring control module connector is shorted or open. Repair or replace the harness.

List of Diagnostic Trouble Code (DTC)

TIRE PRESSURE MONITORING SYSTEM (DIAGNOSTICS)

Brought to you by Eris Studios
NOT FOR RESALE

10. List of Diagnostic Trouble Code (DTC)

A: LIST

DTC	Item	Contents of diagnosis	Remarks
11	Tire 1 Air Pressure Decrease	Tire pressure of tire 1 is reduced.	<Ref. to TPM(diag)-28, DTC 11 TIRE 1 AIR PRESSURE DECREASE, Diagnostic Procedure with Diagnostic Trouble Code (DTC).>
12	Tire 2 Air Pressure Decrease	Tire pressure of tire 2 is reduced.	<Ref. to TPM(diag)-28, DTC 12 TIRE 2 AIR PRESSURE DECREASE, Diagnostic Procedure with Diagnostic Trouble Code (DTC).>
13	Tire 3 Air Pressure Decrease	Tire pressure of tire 3 is reduced.	<Ref. to TPM(diag)-28, DTC 13 TIRE 3 AIR PRESSURE DECREASE, Diagnostic Procedure with Diagnostic Trouble Code (DTC).>
14	Tire 4 Air Pressure Decrease	Tire pressure of tire 4 is reduced.	<Ref. to TPM(diag)-28, DTC 14 TIRE 4 AIR PRESSURE DECREASE, Diagnostic Procedure with Diagnostic Trouble Code (DTC).>
21	Transmitter 1 No Data	Data cannot be received from transmitter 1.	<Ref. to TPM(diag)-29, DTC 21 TRANSMITTER 1 NO DATA, Diagnostic Procedure with Diagnostic Trouble Code (DTC).>
22	Transmitter 2 No Data	Data cannot be received from transmitter 2.	<Ref. to TPM(diag)-29, DTC 22 TRANSMITTER 2 NO DATA, Diagnostic Procedure with Diagnostic Trouble Code (DTC).>
23	Transmitter 3 No Data	Data cannot be received from transmitter 3.	<Ref. to TPM(diag)-29, DTC 23 TRANSMITTER 3 NO DATA, Diagnostic Procedure with Diagnostic Trouble Code (DTC).>
24	Transmitter 4 No Data	Data cannot be received from transmitter 4.	<Ref. to TPM(diag)-30, DTC 24 TRANSMITTER 4 NO DATA, Diagnostic Procedure with Diagnostic Trouble Code (DTC).>
31	Transmitter 1 Pressure Data Abnormal	Transmitter 1 data contents are abnormal.	<Ref. to TPM(diag)-31, DTC 31 TRANSMITTER 1 PRESSURE DATA ABNORMAL, Diagnostic Procedure with Diagnostic Trouble Code (DTC).>
32	Transmitter 2 Pressure Data Abnormal	Transmitter 2 data contents are abnormal.	<Ref. to TPM(diag)-31, DTC 32 TRANSMITTER 2 PRESSURE DATA ABNORMAL, Diagnostic Procedure with Diagnostic Trouble Code (DTC).>
33	Transmitter 3 Pressure Data Abnormal	Transmitter 3 data contents are abnormal.	<Ref. to TPM(diag)-31, DTC 33 TRANSMITTER 3 PRESSURE DATA ABNORMAL, Diagnostic Procedure with Diagnostic Trouble Code (DTC).>
34	Transmitter 4 Pressure Data Abnormal	Transmitter 4 data contents are abnormal.	<Ref. to TPM(diag)-32, DTC 34 TRANSMITTER 4 PRESSURE DATA ABNORMAL, Diagnostic Procedure with Diagnostic Trouble Code (DTC).>
41	Transmitter 1 Function Code Abnormal	Function code has error.	<Ref. to TPM(diag)-33, DTC 41 TRANSMITTER 1 FUNCTION CODE ABNORMAL, Diagnostic Procedure with Diagnostic Trouble Code (DTC).>
42	Transmitter 2 Function Code Abnormal	Function code has error.	<Ref. to TPM(diag)-33, DTC 42 TRANSMITTER 2 FUNCTION CODE ABNORMAL, Diagnostic Procedure with Diagnostic Trouble Code (DTC).>
43	Transmitter 3 Function Code Abnormal	Function code has error.	<Ref. to TPM(diag)-33, DTC 43 TRANSMITTER 3 FUNCTION CODE ABNORMAL, Diagnostic Procedure with Diagnostic Trouble Code (DTC).>

List of Diagnostic Trouble Code (DTC)

TIRE PRESSURE MONITORING SYSTEM (DIAGNOSTICS)

DTC	Item	Contents of diagnosis	Remarks
44	Transmitter 4 Function Code Abnormal	Function code has error.	<Ref. to TPM(diag)-34, DTC 44 TRANSMITTER 4 FUNCTION CODE ABNORMAL, Diagnostic Procedure with Diagnostic Trouble Code (DTC).>
51	Transmitter 1 Battery Voltage Decrease	Transmitter battery voltage is low.	<Ref. to TPM(diag)-35, DTC 51 TRANSMITTER 1 BATTERY VOLTAGE DECREASE, Diagnostic Procedure with Diagnostic Trouble Code (DTC).>
52	Transmitter 2 Battery Voltage Decrease	Transmitter battery voltage is low.	<Ref. to TPM(diag)-35, DTC 52 TRANSMITTER 2 BATTERY VOLTAGE DECREASE, Diagnostic Procedure with Diagnostic Trouble Code (DTC).>
53	Transmitter 3 Battery Voltage Decrease	Transmitter battery voltage is low.	<Ref. to TPM(diag)-35, DTC 53 TRANSMITTER 3 BATTERY VOLTAGE DECREASE, Diagnostic Procedure with Diagnostic Trouble Code (DTC).>
54	Transmitter 4 Battery Voltage Decrease	Transmitter battery voltage is low.	<Ref. to TPM(diag)-35, DTC 54 TRANSMITTER 4 BATTERY VOLTAGE DECREASE, Diagnostic Procedure with Diagnostic Trouble Code (DTC).>
61	Vehicle Speed is Abnormal	Vehicle speed signal is not input to the control module when the vehicle speed is 6 km/h (3.7 MPH) or more.	<Ref. to TPM(diag)-36, DTC 61 VEHICLE SPEED IS ABNORMAL, Diagnostic Procedure with Diagnostic Trouble Code (DTC).>

Diagnostic Procedure with Diagnostic Trouble Code (DTC)

TIRE PRESSURE MONITORING SYSTEM (DIAGNOSTICS)

Brought to you by Eris Studios
NOT FOR RESALE

11. Diagnostic Procedure with Diagnostic Trouble Code (DTC)

A: DTC 11 TIRE 1 AIR PRESSURE DECREASE

NOTE:

Refer to DTC 14 for diagnostic procedure. <Ref. to TPM(diag)-28, DTC 14 TIRE 4 AIR PRESSURE DECREASE, Diagnostic Procedure with Diagnostic Trouble Code (DTC).>

B: DTC 12 TIRE 2 AIR PRESSURE DECREASE

NOTE:

Refer to DTC 14 for diagnostic procedure. <Ref. to TPM(diag)-28, DTC 14 TIRE 4 AIR PRESSURE DECREASE, Diagnostic Procedure with Diagnostic Trouble Code (DTC).>

C: DTC 13 TIRE 3 AIR PRESSURE DECREASE

NOTE:

Refer to DTC 14 for diagnostic procedure. <Ref. to TPM(diag)-28, DTC 14 TIRE 4 AIR PRESSURE DECREASE, Diagnostic Procedure with Diagnostic Trouble Code (DTC).>

D: DTC 14 TIRE 4 AIR PRESSURE DECREASE

DTC DETECTING CONDITION:

Inflation pressure of tires dropped under specifications (186 kPa (1.86 kgf/cm², 27 psi) or less).

TROUBLE SYMPTOM:

Tire pressure warning light illuminates.

	Step	Check	Yes	No
1	CHECK THE TIRES. Lift up the vehicle and check for damage in the tires.	Are there cracks or damage?	Replace the tire. <Ref. to WT-5, Tire.>	Go to step 2.
2	CHECK THE TIRES. Check the tire air pressure.	Is the tire pressure in the specifications?	Go to step 3.	Adjust the air pressure.
3	CHECK TRANSMITTER. Drive the vehicle at 40 km/h (25 MPH) or faster and compare the data from the transmitter on the four wheels.	Is there a transmitter with different data?	Replace the transmitter (tire pressure sensor). <Ref. to WT-10, Tire Pressure Monitoring System.>	Go to step 4.
4	PERFORM DRIVING TEST. 1) Perform the Clear Memory Mode. <Ref. to TPM(diag)-10, CLEAR MEMORY, OPERATION, Subaru Select Monitor.> 2) Perform a driving test. <Ref. to TPM(diag)-17, PROCEDURE, Inspection Mode.> 3) Read the DTC. <Ref. to TPM(diag)-8, READ DIAGNOSTIC TROUBLE CODE (DTC), OPERATION, Subaru Select Monitor.>	Is DTC displayed?	Inspect using the "Diagnostic Procedure with Diagnostic Trouble Code (DTC)". <Ref. to TPM(diag)-28, Diagnostic Procedure with Diagnostic Trouble Code (DTC).>	Finish the diagnosis.

CAUTION:

When driving vehicle to perform driving test, there should be always 2 persons (driver and checker) to check.

Diagnostic Procedure with Diagnostic Trouble Code (DTC)

TIRE PRESSURE MONITORING SYSTEM (DIAGNOSTICS)

Brought to you by Eris Studios
NOT FOR SALE

E: DTC 21 TRANSMITTER 1 NO DATA

NOTE:

Refer to DTC 24 for diagnostic procedure. <Ref. to TPM(diag)-30, DTC 24 TRANSMITTER 4 NO DATA, Diagnostic Procedure with Diagnostic Trouble Code (DTC).>

F: DTC 22 TRANSMITTER 2 NO DATA

NOTE:

Refer to DTC 24 for diagnostic procedure. <Ref. to TPM(diag)-30, DTC 24 TRANSMITTER 4 NO DATA, Diagnostic Procedure with Diagnostic Trouble Code (DTC).>

G: DTC 23 TRANSMITTER 3 NO DATA

NOTE:

Refer to DTC 24 for diagnostic procedure. <Ref. to TPM(diag)-30, DTC 24 TRANSMITTER 4 NO DATA, Diagnostic Procedure with Diagnostic Trouble Code (DTC).>

Diagnostic Procedure with Diagnostic Trouble Code (DTC)

TIRE PRESSURE MONITORING SYSTEM (DIAGNOSTICS)

Brought to you by Eris Studios
NOT FOR RESALE

H: DTC 24 TRANSMITTER 4 NO DATA

DTC DETECTING CONDITION:

Data from each transmitter is not received for 8 minutes.

TROUBLE SYMPTOM:

Tire pressure warning light blinks 25 times and then illuminates.

Step	Check	Yes	No
1 START FL TRANSMITTER. 1) Connect the Subaru Select Monitor and then turn the ignition switch to ON. 2) Select Transmitter ID. <Ref. to TPM(diag)-10, DISPLAY TRANSMITTER (ID)., OPERATION, Subaru Select Monitor.> 3) Use the transmitter registration tool and transmit the ID from the FL transmitter to check "Latest Received ID".	Is "Latest Received ID" updated?	Go to step 2.	Replace front left transmitter.
2 CHECK FL TRANSMITTER ID. Check the ID displayed in the updated ID display and the tire 1 registered ID.	Are the two IDs same?	Go to step 3.	Record the received ID update as the FL transmitter. Go to step 3.
3 START FR TRANSMITTER. Use the transmitter registration tool and transmit the ID from the FR transmitter to check "Latest Received ID".	Is "Latest Received ID" updated?	Go to step 4.	Replace the front right transmitter.
4 CHECK FR TRANSMITTER ID. Check the ID displayed in the updated ID display and the tire 2 registered ID.	Are the two IDs same?	Go to step 5.	Record the received ID update as the FR transmitter. Go to step 5.
5 START RR TRANSMITTER. Use the transmitter registration tool and transmit the ID from the RR transmitter to check "Latest Received ID".	Is "Latest Received ID" updated?	Go to step 6.	Replace the RR transmitter.
6 CHECK RR TRANSMITTER ID. Check the ID displayed in the updated ID display and the tire 3 registered ID.	Are the two IDs same?	Go to step 7.	Record the received ID update as the RR transmitter. Go to step 7.
7 START RL TRANSMITTER. Use the transmitter registration tool and transmit the ID from the RL transmitter to check "Latest Received ID".	Is "Latest Received ID" updated?	Go to step 8.	Replace the RL transmitter.
8 CHECK RL TRANSMITTER ID. Check the ID displayed in the updated ID display and the tire 4 registered ID.	Are the two IDs same?	Go to step 9.	Record the received ID update as the RL transmitter. Go to step 9.
9 CHECK MALFUNCTION TRANSMITTER.	Is ID recorded by this procedure?	Go to step 10.	Go to step 1.
10 CHECK MALFUNCTION TRANSMITTER. Check the registered ID of the transmitter indicated by DTC.	Is there checked ID in the record?	Replace the transmitter of the recorded position.	Replace the transmitter showing the latest ID that is not included in the registered IDs.

CAUTION:

When driving vehicle to perform driving test, there should be always 2 persons (driver and checker) to check.

Diagnostic Procedure with Diagnostic Trouble Code (DTC)

TIRE PRESSURE MONITORING SYSTEM (DIAGNOSTICS)

I: DTC 31 TRANSMITTER 1 PRESSURE DATA ABNORMAL

NOTE:

Refer to DTC 34 for diagnostic procedure. <Ref. to TPM(diag)-32, DTC 34 TRANSMITTER 4 PRESSURE DATA ABNORMAL, Diagnostic Procedure with Diagnostic Trouble Code (DTC).>

J: DTC 32 TRANSMITTER 2 PRESSURE DATA ABNORMAL

NOTE:

Refer to DTC 34 for diagnostic procedure. <Ref. to TPM(diag)-32, DTC 34 TRANSMITTER 4 PRESSURE DATA ABNORMAL, Diagnostic Procedure with Diagnostic Trouble Code (DTC).>

K: DTC 33 TRANSMITTER 3 PRESSURE DATA ABNORMAL

NOTE:

Refer to DTC 34 for diagnostic procedure. <Ref. to TPM(diag)-32, DTC 34 TRANSMITTER 4 PRESSURE DATA ABNORMAL, Diagnostic Procedure with Diagnostic Trouble Code (DTC).>

Diagnostic Procedure with Diagnostic Trouble Code (DTC)

TIRE PRESSURE MONITORING SYSTEM (DIAGNOSTICS)

Brought to you by Eris Studios
NOT FOR RESALE

L: DTC 34 TRANSMITTER 4 PRESSURE DATA ABNORMAL

DTC DETECTING CONDITION:

- When comparing the data from each transmitter to the previous data, the change is large.
- The pressure exceeds what the transmitter can measure. (Excessive pressure)

TROUBLE SYMPTOM:

Tire pressure warning light blinks 25 times and then illuminates.

	Step	Check	Yes	No
1	START FL TRANSMITTER. 1) Connect the Subaru Select Monitor and then turn the ignition switch to ON. 2) Select Transmitter ID. <Ref. to TPM(diag)-10, DISPLAY TRANSMITTER (ID)., OPERATION, Subaru Select Monitor.> 3) Use the transmitter registration tool and transmit the ID from the FL transmitter to check "Latest Received ID".	Is "Latest Received ID" updated?	Go to step 2.	Replace front left transmitter.
2	CHECK FL TRANSMITTER ID. Check the ID displayed in the updated ID display and the tire 1 registered ID.	Are the two IDs same?	Go to step 3.	Record the received ID update as the FL transmitter. Go to step 3.
3	START FR TRANSMITTER. Use the transmitter registration tool and transmit the ID from the FR transmitter to check "Latest Received ID".	Is "Latest Received ID" updated?	Go to step 4.	Replace the front right transmitter.
4	CHECK FR TRANSMITTER ID. Check the ID displayed in the updated ID display and the tire 2 registered ID.	Are the two IDs same?	Go to step 5.	Record the received ID update as the FR transmitter. Go to step 5.
5	START RR TRANSMITTER. Use the transmitter registration tool and transmit the ID from the RR transmitter to check "Latest Received ID".	Is "Latest Received ID" updated?	Go to step 6.	Replace the RR transmitter.
6	CHECK RR TRANSMITTER ID. Check the ID displayed in the updated ID display and the tire 3 registered ID.	Are the two IDs same?	Go to step 7.	Record the received ID update as the RR transmitter. Go to step 7.
7	START RL TRANSMITTER. Use the transmitter registration tool and transmit the ID from the RL transmitter to check "Latest Received ID".	Is "Latest Received ID" updated?	Go to step 8.	Replace the RL transmitter.
8	CHECK RL TRANSMITTER ID. Check the ID displayed in the updated ID display and the tire 4 registered ID.	Are the two IDs same?	Go to step 9.	Record the received ID update as the RL transmitter. Go to step 9.
9	CHECK MALFUNCTION TRANSMITTER.	Is ID recorded by this procedure?	Go to step 10.	Go to step 1.
10	CHECK MALFUNCTION TRANSMITTER. Check the registered ID of the transmitter indicated by DTC.	Is there checked ID in the record?	Replace the transmitter of the recorded position.	Replace the transmitter showing the latest ID that is not included in the registered IDs.

Diagnostic Procedure with Diagnostic Trouble Code (DTC)

TIRE PRESSURE MONITORING SYSTEM (DIAGNOSTICS)

M: DTC 41 TRANSMITTER 1 FUNCTION CODE ABNORMAL

NOTE:

Refer to DTC 44 for diagnostic procedure. <Ref. to TPM(diag)-34, DTC 44 TRANSMITTER 4 FUNCTION CODE ABNORMAL, Diagnostic Procedure with Diagnostic Trouble Code (DTC).>

N: DTC 42 TRANSMITTER 2 FUNCTION CODE ABNORMAL

NOTE:

Refer to DTC 44 for diagnostic procedure. <Ref. to TPM(diag)-34, DTC 44 TRANSMITTER 4 FUNCTION CODE ABNORMAL, Diagnostic Procedure with Diagnostic Trouble Code (DTC).>

O: DTC 43 TRANSMITTER 3 FUNCTION CODE ABNORMAL

NOTE:

Refer to DTC 44 for diagnostic procedure. <Ref. to TPM(diag)-34, DTC 44 TRANSMITTER 4 FUNCTION CODE ABNORMAL, Diagnostic Procedure with Diagnostic Trouble Code (DTC).>

Brought to you by Eris Studios
NOT FOR SALE

Diagnostic Procedure with Diagnostic Trouble Code (DTC)

TIRE PRESSURE MONITORING SYSTEM (DIAGNOSTICS)

Brought to you by Eris Studios
NOT FOR RESALE

P: DTC 44 TRANSMITTER 4 FUNCTION CODE ABNORMAL

DTC DETECTING CONDITION:

Unexpected function codes received from each transmitter.

TROUBLE SYMPTOM:

Tire pressure warning light blinks 25 times and then illuminates.

Step	Check	Yes	No
1 START FL TRANSMITTER. 1) Connect the Subaru Select Monitor and then turn the ignition switch to ON. 2) Select Transmitter ID. <Ref. to TPM(diag)-10, DISPLAY TRANSMITTER (ID)., OPERATION, Subaru Select Monitor.> 3) Use the transmitter registration tool and transmit the ID from the FL transmitter to check "Latest Received ID".	Is "Latest Received ID" updated?	Go to step 2.	Replace front left transmitter.
2 CHECK FL TRANSMITTER ID. Check the ID displayed in the updated ID display and the tire 1 registered ID.	Are the two IDs same?	Go to step 3.	Record the received ID update as the FL transmitter. Go to step 3.
3 START FR TRANSMITTER. Use the transmitter registration tool and transmit the ID from the FR transmitter to check "Latest Received ID".	Is "Latest Received ID" updated?	Go to step 4.	Replace the front right transmitter.
4 CHECK FR TRANSMITTER ID. Check the ID displayed in the updated ID display and the tire 2 registered ID.	Are the two IDs same?	Go to step 5.	Record the received ID update as the FR transmitter. Go to step 5.
5 START RR TRANSMITTER. Use the transmitter registration tool and transmit the ID from the RR transmitter to check "Latest Received ID".	Is "Latest Received ID" updated?	Go to step 6.	Replace the RR transmitter.
6 CHECK RR TRANSMITTER ID. Check the ID displayed in the updated ID display and the tire 3 registered ID.	Are the two IDs same?	Go to step 7.	Record the received ID update as the RR transmitter. Go to step 7.
7 START RL TRANSMITTER. Use the transmitter registration tool and transmit the ID from the RL transmitter to check "Latest Received ID".	Is "Latest Received ID" updated?	Go to step 8.	Replace the RL transmitter.
8 CHECK RL TRANSMITTER ID. Check the ID displayed in the updated ID display and the tire 4 registered ID.	Are the two IDs same?	Go to step 9.	Record the received ID update as the RL transmitter. Go to step 9.
9 CHECK MALFUNCTION TRANSMITTER.	Is ID recorded by this procedure?	Go to step 10.	Check again. Go to step 1.
10 CHECK MALFUNCTION TRANSMITTER. Check the registered ID of the transmitter indicated by DTC.	Is there checked ID in the record?	Replace the transmitter of the recorded position.	Replace the transmitter showing the latest ID that is not included in the registered IDs.

Diagnostic Procedure with Diagnostic Trouble Code (DTC)

TIRE PRESSURE MONITORING SYSTEM (DIAGNOSTICS)

Q: DTC 51 TRANSMITTER 1 BATTERY VOLTAGE DECREASE

NOTE:

Refer to DTC 54 for diagnostic procedure. <Ref. to TPM(diag)-35, DTC 54 TRANSMITTER 4 BATTERY VOLTAGE DECREASE, Diagnostic Procedure with Diagnostic Trouble Code (DTC).>

R: DTC 52 TRANSMITTER 2 BATTERY VOLTAGE DECREASE

NOTE:

Refer to DTC 54 for diagnostic procedure. <Ref. to TPM(diag)-35, DTC 54 TRANSMITTER 4 BATTERY VOLTAGE DECREASE, Diagnostic Procedure with Diagnostic Trouble Code (DTC).>

S: DTC 53 TRANSMITTER 3 BATTERY VOLTAGE DECREASE

NOTE:

Refer to DTC 54 for diagnostic procedure. <Ref. to TPM(diag)-35, DTC 54 TRANSMITTER 4 BATTERY VOLTAGE DECREASE, Diagnostic Procedure with Diagnostic Trouble Code (DTC).>

T: DTC 54 TRANSMITTER 4 BATTERY VOLTAGE DECREASE

DTC DETECTING CONDITION:

Low battery signals received 20 times from each transmitter.

TROUBLE SYMPTOM:

Tire pressure warning light blinks 25 times and then illuminates.

	Step	Check	Yes	No
1	CHECK TRANSMITTER. 1) Replace all transmitters and register their IDs. <Ref. to TPM(diag)-10, REGISTER TRANSMITTER ID, OPERATION, Subaru Select Monitor.> 2) Perform the Clear Memory Mode, and perform driving test.	Is the fault eliminated?	Internal battery of the transmitter had worn out.	Replace the tire pressure monitoring control module. <Ref. to WT-10, TIRE PRESSURE MONITORING CONTROL MODULE, REMOVAL, Tire Pressure Monitoring System.>

Diagnostic Procedure with Diagnostic Trouble Code (DTC)

TIRE PRESSURE MONITORING SYSTEM (DIAGNOSTICS)

Brought to you by Eris Studios
NOT FOR RESALE

U: DTC 61 VEHICLE SPEED IS ABNORMAL

DTC DETECTING CONDITION:

Vehicle speed function codes were received from the transmitter, but the vehicle speed signal was not input to the module.

TROUBLE SYMPTOM:

Tire pressure warning light blinks 25 times and then illuminates.

WIRING DIAGRAM:

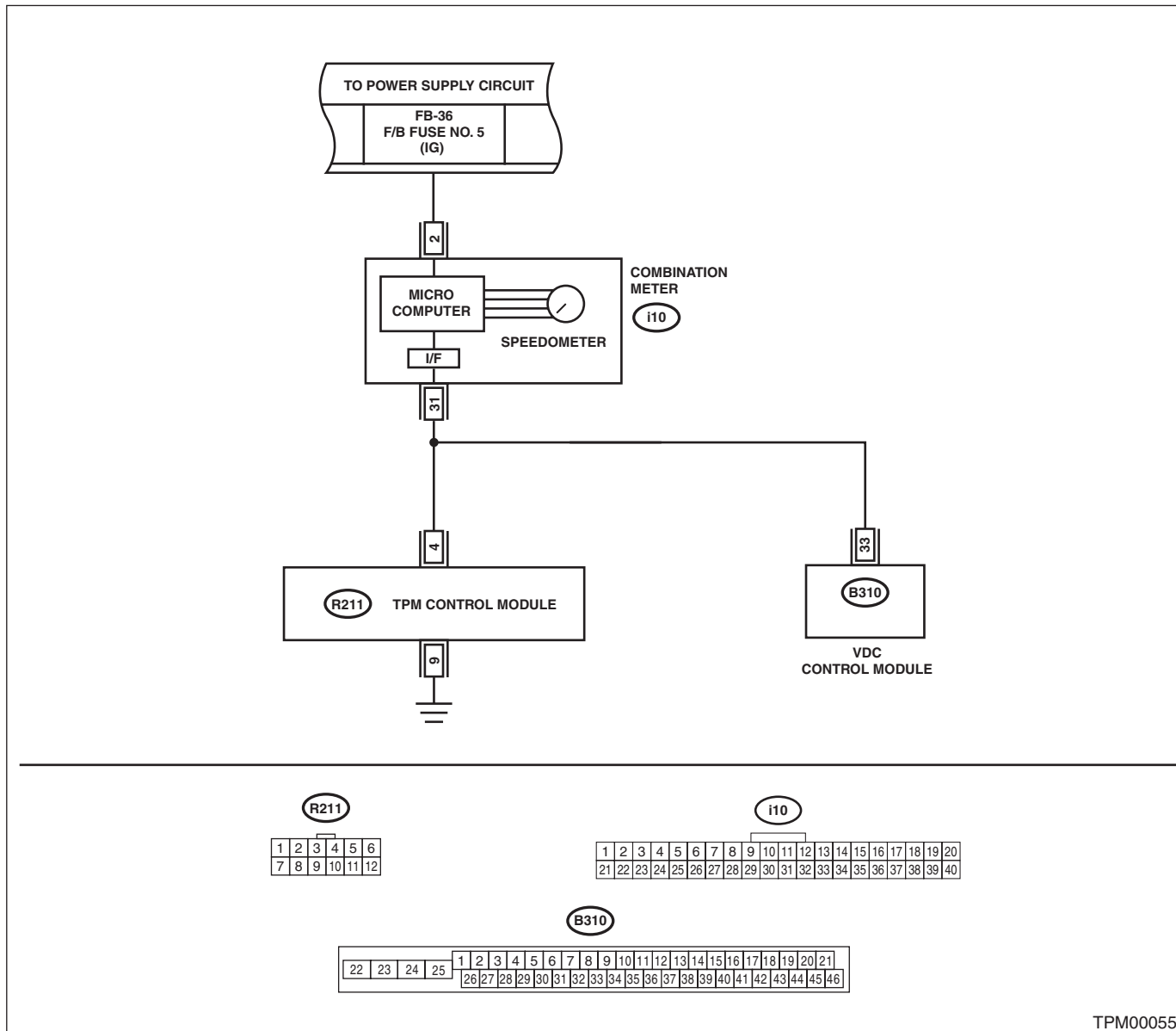

TPM00055

Diagnostic Procedure with Diagnostic Trouble Code (DTC)

TIRE PRESSURE MONITORING SYSTEM (DIAGNOSTICS)

Brought to you by Eris Studios
NOT FOR SALE

	Step	Check	Yes	No
1	CHECK TIRE PRESSURE MONITORING CONTROL MODULE. 1) Connect an oscilloscope to the terminal No. 4 of the tire pressure monitoring control module connector (R211). 2) Lift up the vehicle and then drive the vehicle at 40 km/h (25 MPH) and check the vehicle speed signal at that time.	Is the vehicle speed being input?	Replace the tire pressure monitoring control module. <Ref. to WT-10, TIRE PRESSURE MONITORING CONTROL MODULE, REMOVAL, Tire Pressure Monitoring System.>	Go to step 2.
2	CHECK HARNESS. 1) Disconnect the combination meter connector (i10). 2) Connect the tire pressure monitoring control module connector (R211) and combination meter connector (i10) and measure the resistance.	Is the resistance less than 0.5 Ω ?	Check the combination meter. <Ref. to IDI-13, REMOVAL, Combination Meter.>	Repair or replace the open circuit of the harness.

General Diagnostic Table

TIRE PRESSURE MONITORING SYSTEM (DIAGNOSTICS)

Brought to you by Eris Studios
NOT FOR RESALE

12. General Diagnostic Table

A: INSPECTION

Symptoms		Problem parts
Tire pressure warning light illuminates.	Tire pressure is reduced.	<ul style="list-style-type: none">• Improper tire pressure adjustment• Punctured tire
Tire pressure warning light blinks 25 times and then illuminates.	Tire pressure monitoring system has malfunction.	<ul style="list-style-type: none">• Air pressure sensor malfunction• Air pressure sensor is out of battery.• Tire pressure monitoring control module is faulty.• Defective vehicle harness• Defective combination meter
Tire pressure is dropping but the warning light does not illuminate.	Tire pressure warning light does not illuminate.	<ul style="list-style-type: none">• Air pressure sensor is faulty.• Tire pressure monitoring control module is faulty.• Defective combination meter