

Brought to you by Eris Studios
NOT FOR RESALE

TECHNICAL SERVICE BULLETINS

ATTENTION:

GENERAL MANAGER PARTS MANAGER
CLAIMS PERSONNEL SERVICE MANAGER

IMPORTANT - All Service Personnel Should Read and Initial



SERVICE BULLETIN

APPLICABILITY: STi Vehicles, All Model Years
SUBJECT: Towing Recommendations

NUMBER: 01-162-05
DATE: 06/28/05

INTRODUCTION

AWD Subaru vehicles with manual transmissions can be towed with all four wheels on the ground and the transmission in neutral. STi vehicles with 6 Speed Manual Transmissions can also be towed with all four wheels on the ground and the transmission in neutral. In addition, STi vehicles with 6 Speed Manual Transmissions require that the Driver's Control Center Differential (DCCD) is set in manual mode and the DCCD control dial set to the furthest rearward position.

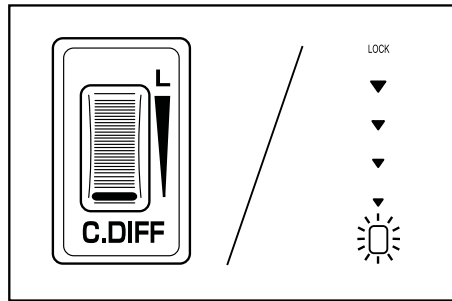
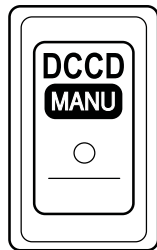

Please refer to the owner's manual for additional important information on towing Subaru vehicles.



CAUTION: VEHICLE SERVICING PERFORMED BY UNTRAINED PERSONS COULD RESULT IN SERIOUS INJURY TO THOSE PERSONS OR TO OTHERS.

Subaru Service Bulletins are intended for use by professional technicians ONLY. They are written to inform those technicians of conditions that may occur in some vehicles, or to provide information that could assist in the proper servicing of the vehicle. Properly trained technicians have the equipment, tools, safety instructions, and know-how to do the job correctly and safely. If a condition is described, DO NOT assume that this Service Bulletin applies to your vehicle, or that your vehicle will have that condition.



ATTENTION:
GENERAL MANAGER
CLAIMS PERSONNEL

PARTS MANAGER
SERVICE MANAGER



SUBARU

Brought to you by Eris Studios
מביא לך עריס סטודיו
למכירה

SERVICE BULLETIN

APPLICABILITY: All Models
SUBJECT: Cylinder Head Gasket (residual carbon deposits and rubber coating removal)
NUMBER: 02-100-06R
DATE: 10/31/06

INTRODUCTION

The purpose of this bulletin is to provide Subaru's recommended procedure of removing the residual carbon deposits and the rubber coating after the cylinder head/gaskets are removed. If not removed properly, the new cylinder head gaskets may not seat properly when installed. There are two approved methods, using a scraper as illustrated or using 3M™ Roloc™ Bristle Discs, part # 051131-07528, Size 2 inch, Grade 120, Color White. Subaru does not recommend any other cleaning method.

Note: Using any other method which results in damage to the surface of the cylinder heads or block is not a matter for warranty.

REPAIR PROCEDURE/INFORMATION:

For demonstration purposes the photos are of a 2.5L SOHC engine, however the procedure applies to all engine types.



Removed Cylinder Head



Cylinder Block after Head Removal

Continued on Next Page



CAUTION: VEHICLE SERVICING PERFORMED BY UNTRAINED PERSONS COULD RESULT IN SERIOUS INJURY TO THOSE PERSONS OR TO OTHERS.

Subaru Service Bulletins are intended for use by professional technicians ONLY. They are written to inform those technicians of conditions that may occur in some vehicles, or to provide information that could assist in the proper servicing of the vehicle. Properly trained technicians have the equipment, tools, safety instructions, and know-how to do the job correctly and safely. If a condition is described, DO NOT assume that this Service Bulletin applies to your vehicle, or that your vehicle will have that condition.



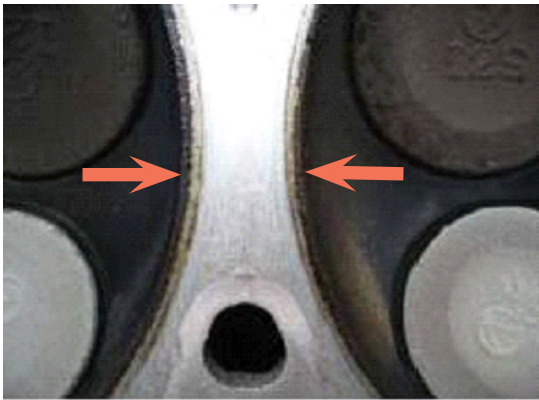

Accumulated carbon deposit on bore sealing portion

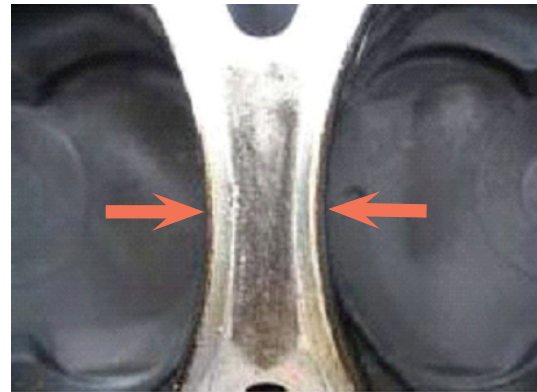

Carbon deposit on cylinder block bore sealing portion

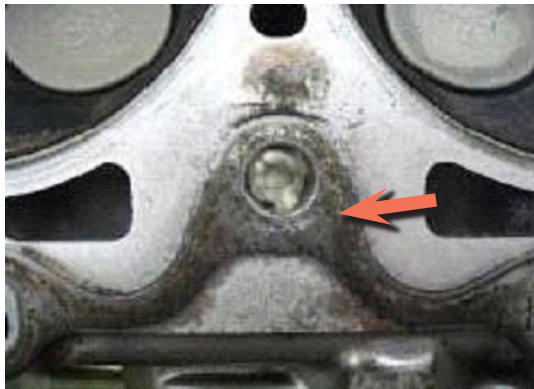

Rubber coating residue on coolant sealing portion

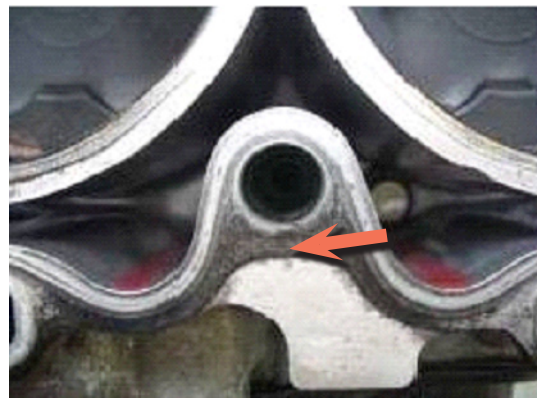

Rubber coating residue on oil sealing portion

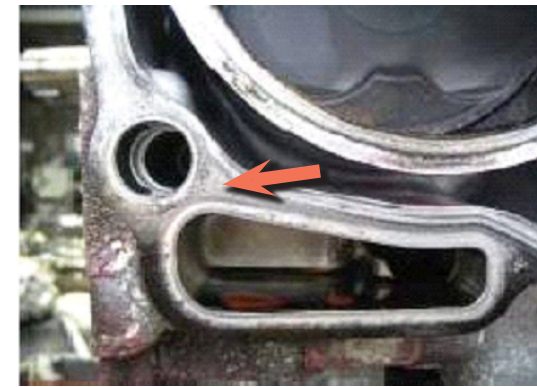

Using a gasket scraper, carefully clean any carbon deposits and rubber coating found on the surface of cylinder block and cylinder head.

CAUTION: Keep the scraper as flush as possible to the surface to avoid damage to the mating surface of cylinder block and cylinder head.

Continued on Next Page

Cylinder Head

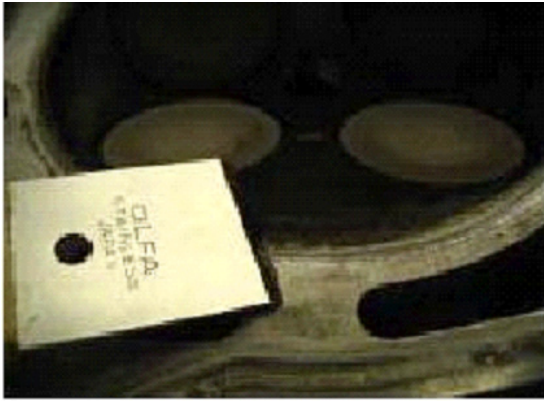

Cylinder Block



Carbon deposits being removed

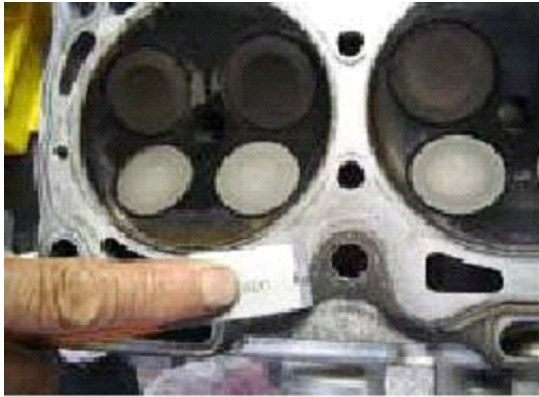

Rubber coating being removed



Rubber coating being removed

Continued on Next Page

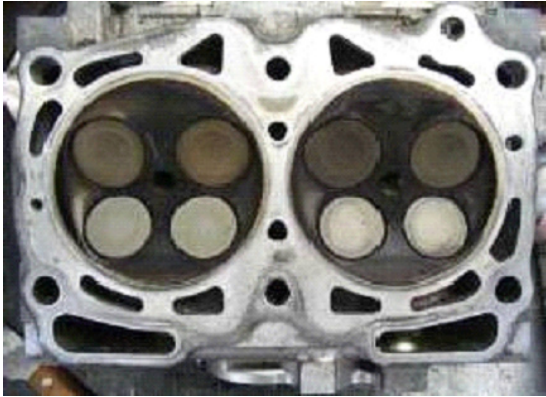

Finished cleaning (head)



Finished cleaning (block)

NOTE: After removing carbon deposit and rubber coating, clean the surfaces using a rag and cleaning solvent.



After cleaning bore sealing portion (head)



After cleaning bore sealing portion (block)



After cleaning coolant sealing portion (head)



After cleaning coolant sealing portion (block)

Continued on Next Page



After cleaning oil sealing portion (head)



After cleaning oil sealing portion (block)

ATTENTION:
GENERAL MANAGER
PARTS MANAGER
CLAIMS PERSONNEL
SERVICE MANAGER

IMPORTANT - All Service Personnel Should Read and Initial in the boxes provided, right.



SUBARU

QUALITY DRIVEN® SERVICE

SERVICE BULLETIN

APPLICABILITY: All Turbo Equipped Models
SUBJECT: Turbo Vehicle Operation and Care

NUMBER: 02-101-07
DATE: 02/28/07

INTRODUCTION

Many Subaru vehicles are equipped with turbo charged engines and are often referred to as performance or enthusiasts' vehicles. Turbo charged engines require some special care and precautions. Special attention should be paid to the following:

(1) MODIFICATIONS

Modifying the engine tuning of a Subaru to increase horse power by Engine Control Unit (ECU) replacement or reprogramming can lead to engine failures. Other external engine modifications, such as intake or exhaust systems, can also lead to failures. Any modifications can reduce engine durability and cause reliability deterioration.



Aftermarket Air Fuel Controller wired to ECM

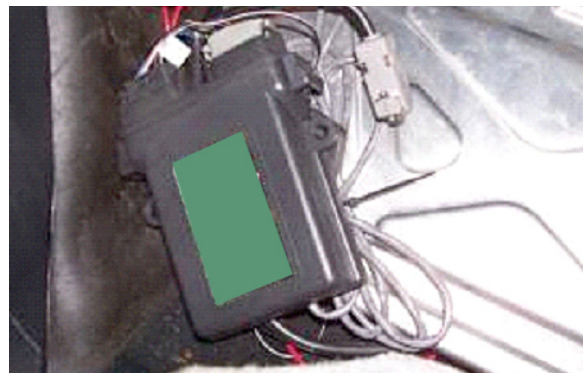

Aftermarket Chip Processor

Intake system

Modifications to the intake systems, including the air cleaner, can cause the following:

- Allow foreign objects to enter the engine.
- Change the Air/Fuel mixture ratio, due to the change of intake air amount.
- System malfunctions due to a contaminated air flow sensor.
- Reduced engine durability due to higher horse power that exceeds engine design specifications.
- Turbo charger internal damage from excessive turbine speed.

continued...

CAUTION: VEHICLE SERVICING PERFORMED BY UNTRAINED PERSONS COULD RESULT IN SERIOUS INJURY TO THOSE PERSONS OR TO OTHERS.

Subaru Service Bulletins are intended for use by professional technicians ONLY. They are written to inform those technicians of conditions that may occur in some vehicles, or to provide information that could assist in the proper servicing of the vehicle. Properly trained technicians have the equipment, tools, safety instructions, and know-how to do the job correctly and safely. If a condition is described, DO NOT assume that this Service Bulletin applies to your vehicle, or that your vehicle will have that condition.





Aftermarket Cold Air Intake

Camshaft

Modifications to the Camshaft can create higher cylinder pressure due to the increase of intake air amount, and may result in engine damage.

Exhaust system

Modifications to the Exhaust System may create a reduction of exhaust resistance. This can lead to similar problems as found in Intake System modifications.



Aftermarket Exhaust System



Aftermarket Exhaust Bypass Valve

Body

Body modifications on vehicles may interfere with the flow of air to the Engine Cooling System, Intercooler, or Exhaust System. This can cause a raise in engine operating temperature which, in turn, would result in a rise in the intake air temperature which will affect the Engine Management System.

continued...

Ignition System

Modifications to the Engine Ignition System, such as “plugs”, can cause abnormal ignition, and result in engine damage.



Ring Land Damage from Detonation

Others

Relocation of any vehicle component may affect the Engine Management System and, in turn, cause potential engine damage.



Aftermarket Blow Off Valve



Ring Land Broken from Over Boosting

(2) MAINTENANCE

Engine Oil and oil filter

- Some brands of oil which are available in the aftermarket may not have enough lubrication ability and durability, regardless the price. (Poor performance oil causes damage on the crankshaft bearing, camshaft bearing, piston ring, cylinder liner, or turbo charger.)
- If the oil complies with the American Petroleum Institute (API) classification of SM (or SL minimum), and is within the recommended viscosity, it will not cause engine problems.
- A lack of oil may cause damage to the crankshaft bearing, camshaft bearing, piston ring, cylinder liner, or turbo charger.
- When the vehicle is used under severe driving conditions, moderate to hard acceleration on a somewhat regular basis, the engine oil and filter should be changed every 3,750 miles (6,000 km) or 3.75 months. For additional examples of severe driving conditions, refer to the Warranty & Maintenance Booklet.

continued...

- The use of a Genuine Subaru oil filter is strongly recommended. Many aftermarket oil filters have different filtration capacity and relief valve opening pressure. Those filters may not meet Subaru's requirements and may cause engine problems.



Aftermarket Oil Filter



Rod Bearing Spun from Lack of Oil

Coolant

- Use only Genuine Subaru Long Life Coolant.
- The use of a silicate type coolant deteriorates the aluminum surface of the radiator, causing loss in cooling performance, and may cause engine overheating.
- Use only Genuine Subaru coolant conditioner. Non-genuine coolant conditioners contain large particles that may clog the coolant passages in the radiator resulting in a loss of cooling performance and may cause engine overheating.

Please refer to Service Bulletin 09-42-05.

Air Cleaner

If the air cleaner element is contaminated, intake air flow is reduced. This condition will create an increase in engine vacuum causing an extra load on the turbo charger.

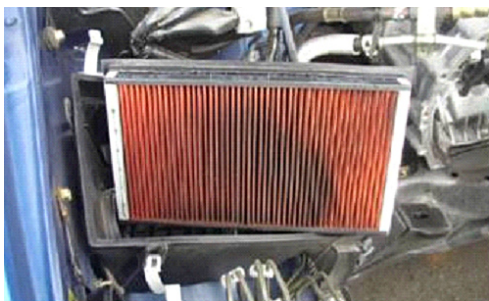

Contaminated Air Cleaner Element

(3) FUEL

Adequate quality and octane number fuel should be always used. The use of poor quality or low octane fuel can cause engine damage. Requirements vary by model, so please see the vehicle's owners manual for more details.

For example: 07MY Impreza WRX STI

Use super-premium unleaded gasoline with an octane rating of 93 AKI or higher. If super-premium unleaded gasoline with an octane rating of 93 AKI is not available, premium unleaded gasoline with an octane rating of 91 AKI or higher may be temporarily used. For optimum engine performance and driveability, it is required that you use super-premium grade unleaded gasoline with an octane rating of 93 AKI or higher.

continued...

(4) DRIVING

Racing / Abusive Driving

The term “racing” refers to all forms of racing whether street, drag, rally, sanctioned or un-sanctioned, etc. Any damage that results from racing is not warrantable.

Some examples of abusive driving are exceeding maximum recommended RPMs, excessive torque transferred to the transmission during acceleration from a complete stop (dumping the clutch), downshifting at high RPMs and missing shifts.

The photos below depict some results of abusive driving:

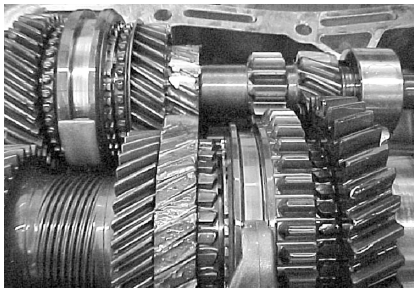

Second Gear Teeth Missing

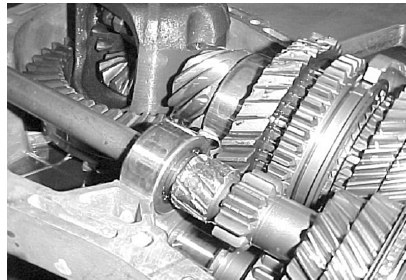

First Gear Teeth Stripped from Mainshaft



Reverse Gear Teeth Stripped

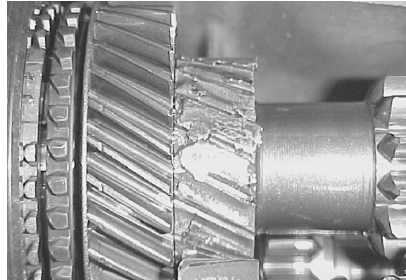

Second Gear Teeth Missing



6-Speed 1-2 Shift Interlock
Arm Broken

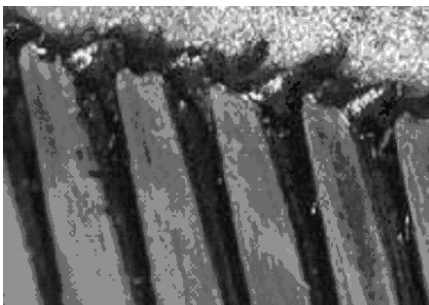

Damaged Land of Baulk Ring

continued...

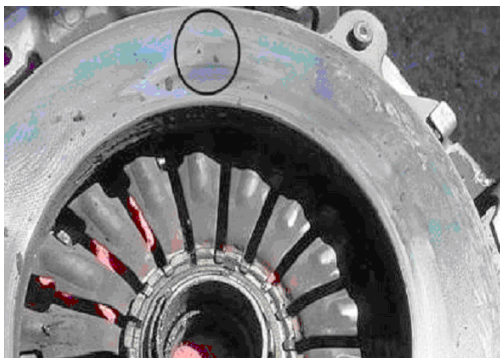

Over Heated Pressure Plate

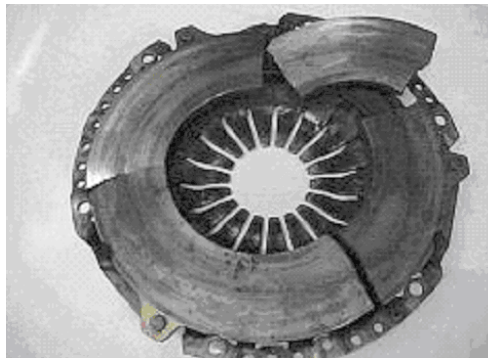

Broken Pressure Plate



Over Heated Flywheel



Over Heated Clutch Disc



Rear Differential Gear Damage



Burnt automatic transmission clutches

continued...

The following 3 photos show an axle shaft that was sheared off at the “Bell Joint” (BJ) as the result of abuse.

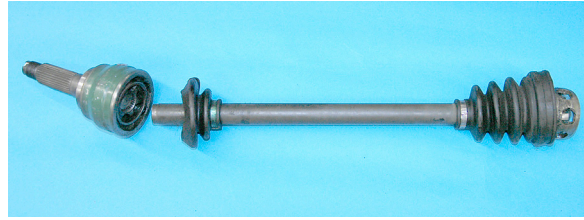

Engine Over-revving

- Subaru engines are equipped with a fuel cut-off device that prevents engine over-revving on acceleration. However, over-revving due to shift-down on MT vehicles can not be prevented.
- Driving under these conditions will also consume engine oil at a much higher rate than consumed during normal driving conditions.
- It is highly recommended that the oil level should be checked at every fill-up, especially if the vehicle is being driven under severe driving conditions or aggressively.
- The fuel cut-off function is an emergency action to protect the engine from damage, therefore continuously revving the engine at the point of fuel cut-off is not recommended. Doing so will cause damage to the engine/catalytic converter from extremely high temperatures.
- In hard turning situations, and with less than a quarter tank of fuel, it is possible that fuel flow can be momentarily interrupted, which will result in intermittent combustion temperature increases. Such temperature increases will deteriorate the engine and affect long term durability.

Brought to you by Eris Studios
NOT FOR RESALE

ATTENTION:

- GENERAL MANAGER
- PARTS MANAGER
- CLAIMS PERSONNEL
- SERVICE MANAGER

IMPORTANT - All Service Personnel Should Read and Initial in the boxes provided, right.

QUALITY DRIVEN® SERVICE



SUBARU®

SERVICE BULLETIN

APPLICABILITY: All Turbo Equipped Vehicles
SUBJECT: Turbocharger Oil Supply Mesh Screen

NUMBER: 02-103-07R
DATE: 10/29/07

INTRODUCTION

This bulletin is for informational purposes only.

Turbocharged engines require proper maintenance especially when the vehicle is used under severe driving conditions, such as moderate to hard acceleration and engine braking on a somewhat regular basis.

In any case, it is recommended that the engine oil and filter be changed every 3,750 miles (6,000 km) or 3-3/4 months.

In addition, the mesh screen which is located inside the banjo bolt that secures the turbocharger oil supply pipe to the back of the right side cylinder head should be checked to make sure it is not clogged or restricted especially if the condition of the oil is questionable or as to when the last oil change was performed. If clogged or restricted, it will reduce or cut off the oil supply to the turbo resulting in failure. The oil supply pipe should also be checked to make sure that there are no obstructions. *Note: The mesh screen is only available with a replacement banjo bolt.*

**Banjo bolt and Mesh Screen
(note direction of screen)**



- Make sure the mesh screen is installed in the proper direction; incorrect installation will cut off oil supply to the turbo.

continued on next page...

CAUTION: VEHICLE SERVICING PERFORMED BY UNTRAINED PERSONS COULD RESULT IN SERIOUS INJURY TO THOSE PERSONS OR TO OTHERS.

Subaru Service Bulletins are intended for use by professional technicians ONLY. They are written to inform those technicians of conditions that may occur in some vehicles, or to provide information that could assist in the proper servicing of the vehicle. Properly trained technicians have the equipment, tools, safety instructions, and know-how to do the job correctly and safely. If a condition is described, DO NOT assume that this Service Bulletin applies to your vehicle, or that your vehicle will have that condition.



- Do not confuse the oil supply mesh screen with the Active Valve Control System (AVCS) union screw filter. Refer to Service Bulletin 02-97-05, dated 10/06/05.
- When the vehicle is used under severe driving conditions, the engine oil is consumed more quickly than under normal driving conditions due to high intake manifold vacuum during engine braking and higher temperatures; the engine oil level should be checked at every fuel fill up. For additional examples of severe driving conditions, refer to the Warranty & Maintenance Booklet.

ATTENTION:

GENERAL MANAGER PARTS MANAGER
CLAIMS PERSONNEL SERVICE MANAGER

IMPORTANT - All Service Personnel Should Read and Initial



Brought to you by Eris Studios
NOT FOR RESALE

SERVICE BULLETIN

APPLICABILITY: All A/T and M/T Vehicles
SUBJECT: Transmission Rear Cross-Member

NUMBER: 03-53-04
16-54-04
DATE: 08/20/04

INTRODUCTION

The purpose of this bulletin is to prevent the possibility of damaging the bolts and/or threads that secure the transmission rear cross member.

REPAIR PROCEDURES/INFORMATION

When performing service work or installing SOA's accessory short throw shifter, it is extremely important that the transmission is supported properly when removing or reinstalling the cross member. If not, damage to the bolts and/or threads will occur. Support the transmission using a transmission jack, regardless if the vehicle is supported by a lift or car ramps (**Figure 1**). It is recommended that hand tools be used for the removal and installation of the bolts. Inspect for bolt thread damage and replace as necessary. Be sure to clean any protective wax from the mating surfaces and be sure to start all bolts several threads by hand before using tightening tools. **Note: If severe damage is evident to the threads, the use of a Heli-coil® type kit is an approved repair method.**

During reinstallation, follow the torque sequence, below (**Figure 2**) and the torque specifications (**Figure 3; next page**).



Figure 1

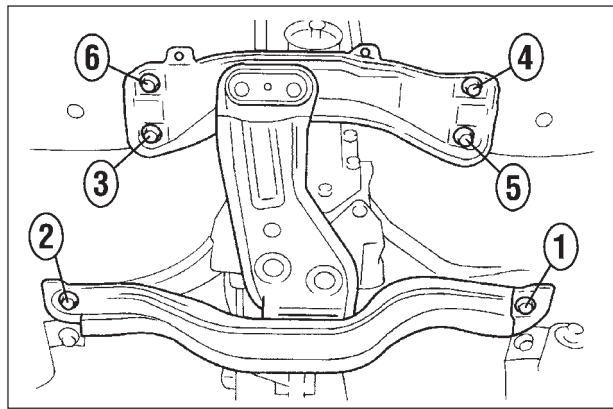

Figure 2

continued on next page...



CAUTION: VEHICLE SERVICING PERFORMED BY UNTRAINED PERSONS COULD RESULT IN SERIOUS INJURY TO THOSE PERSONS OR TO OTHERS.

Subaru Service Bulletins are intended for use by professional technicians ONLY. They are written to inform those technicians of conditions that may occur in some vehicles, or to provide information that could assist in the proper servicing of the vehicle. Properly trained technicians have the equipment, tools, safety instructions, and know-how to do the job correctly and safely. If a condition is described, DO NOT assume that this Service Bulletin applies to your vehicle, or that your vehicle will have that condition.



Bolts must be torqued to the proper specifications (**Figure 3**).

T1: 70 N·m (7.1 kgf-m, 51 ft-lb)

T2: 140 N·m (14.3 kgf-m, 103 ft-lb)

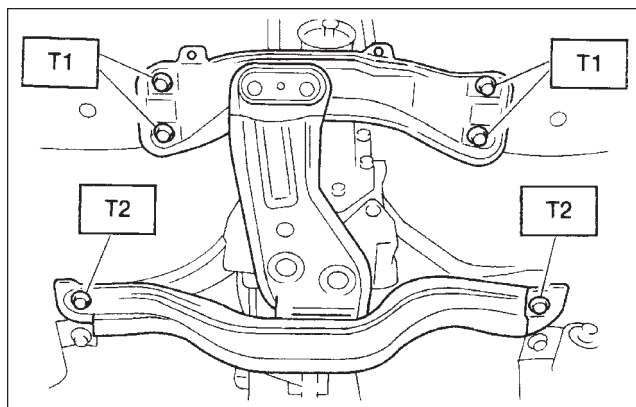

Figure 3

ATTENTION:
GENERAL MANAGER
PARTS MANAGER
CLAIMS PERSONNEL
SERVICE MANAGER

IMPORTANT - All Service Personnel Should Read and Initial in the boxes provided, right.



SUBARU

QUALITY DRIVEN® SERVICE

SERVICE BULLETIN

APPLICABILITY: All Models
SUBJECT: Tire Rotation Pattern

NUMBER: 05-37-07
DATE: 03/12/07

INTRODUCTION

In an effort to further reduce uneven tire wear and prolong tire life, the tire rotation pattern has been changed for non-directional tires. To maximize the life of each tire and ensure that the tires wear uniformly, it is best to rotate the tires every 7,500 miles (12,000 km). Note: The tire rotation pattern for directional tires has not changed.

Reminder: When rotating tires on a vehicle equipped with TPMS (Tire Pressure Monitoring System) make sure to re-register the tires.

Tire Rotation Pattern for Non-Directional Tires

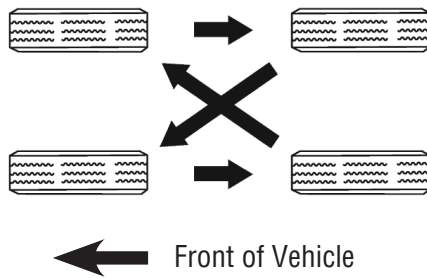

Tire Rotation Pattern for Directional Tires

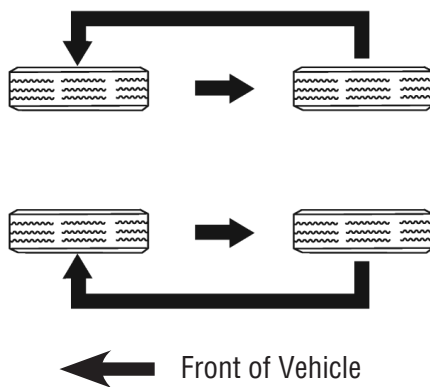

Tire Rotation Branding

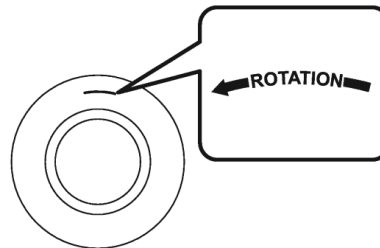

CAUTION: VEHICLE SERVICING PERFORMED BY UNTRAINED PERSONS COULD RESULT IN SERIOUS INJURY TO THOSE PERSONS OR TO OTHERS.

Subaru Service Bulletins are intended for use by professional technicians ONLY. They are written to inform those technicians of conditions that may occur in some vehicles, or to provide information that could assist in the proper servicing of the vehicle. Properly trained technicians have the equipment, tools, safety instructions, and know-how to do the job correctly and safely. If a condition is described, DO NOT assume that this Service Bulletin applies to your vehicle, or that your vehicle will have that condition.



ATTENTION:
 GENERAL MANAGER PARTS MANAGER
 CLAIMS PERSONNEL SERVICE MANAGER
 IMPORTANT - All Service Personnel Should Read and Initial



Brought to you by
 NOVA
 Eris Studios
 SALE

SERVICE BULLETIN

APPLICABILITY: 2001MY and later Impreza WRX
SUBJECT: Modification to Rear Brake Caliper

NUMBER: 06-36-06
DATE: 06/23/06

INTRODUCTION

This bulletin is for informational purposes only.

A production change was made to the rear brake caliper on 01MY and newer Impreza WRX. The washer between the caliper body and the backing plate has been discontinued. A change has been made to the caliper body to maintain the correct geometry, although the part numbers have not changed.

PRODUCTION LINE CHANGE

Production line changes have been incorporated into the following VINs :

MODEL		VIN	STARTING MONTH
Impreza	Sedan	6*521076	April, 2006
	Wagon	6*817076	

PART INFORMATION

Old Disk Brake Kit: 26692FE040/050 (LH/RH)

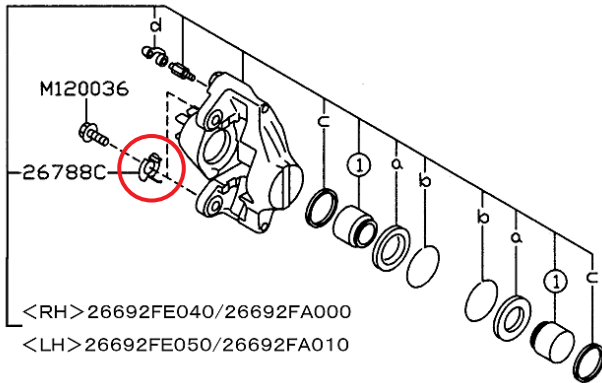

New Disk Brake Kit: 26692FE040/050 (LH/RH)

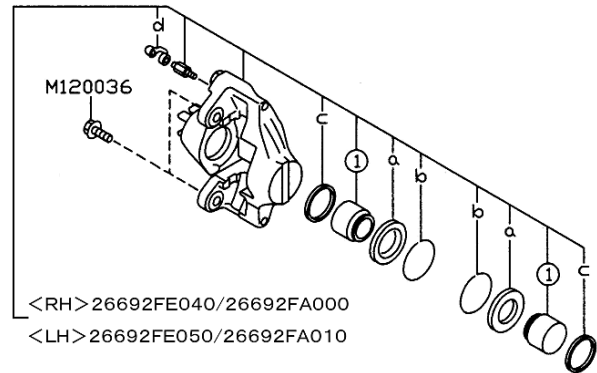

Note: Though there were design changes made to this part, the part numbers remain the same.



CAUTION: VEHICLE SERVICING PERFORMED BY UNTRAINED PERSONS COULD RESULT IN SERIOUS INJURY TO THOSE PERSONS OR TO OTHERS.

Subaru Service Bulletins are intended for use by professional technicians ONLY. They are written to inform those technicians of conditions that may occur in some vehicles, or to provide information that could assist in the proper servicing of the vehicle. Properly trained technicians have the equipment, tools, safety instructions, and know-how to do the job correctly and safely. If a condition is described, DO NOT assume that this Service Bulletin applies to your vehicle, or that your vehicle will have that condition.

REPAIR PROCEDURE/INFORMATION

Refer to the applicable Subaru Service Manual located on the STIS (Subaru Technical Information System) web site.

CLAIM REIMBURSEMENT/WARRANTY INFORMATION

For vehicles within the basic New Car Limited Warranty period, refer to the Subaru Warranty Wizard™ for claim submission information.

ATTENTION:
GENERAL MANAGER
CLAIMS PERSONNEL

PARTS MANAGER
SERVICE MANAGER

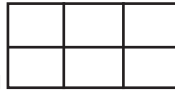

SUBARU

Brought to you by Eris Studios
מביא לך עריס סטודיו
ללא תשלום
מותר לרשום

SERVICE BULLETIN

APPLICABILITY: 2006MY Impreza and Later
SUBJECT: Change in Horn(s)

NUMBER: 07-58-06
DATE: 08/25/06

INTRODUCTION

This bulletin informs of a change in the external diameter of the horns from 76mm (3in) to 70mm (2.75in), and the position of the High and Low frequency-type horns.

PARTS INFORMATION

POSITION	NEW		OLD	
	Tune	Part Number	Tune	Part Number
Center	Low	86012FE040	High	86012FE030
Left side	High	86012FE050	Low	86012FE020

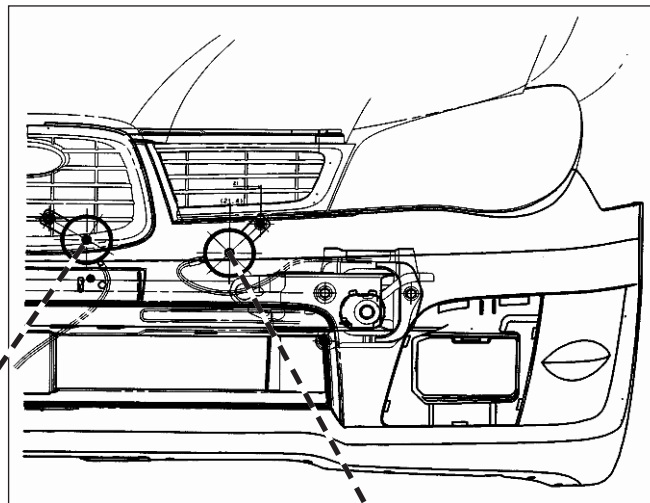

CENTER HORN
New 86012FE040 (Low)
Identification: UCL-202<Inscribed>

Old 86012FE030 (Hi)
Identification: NMH-201<Inscribed>

LEFT HAND HORN
New 86012FE050 (Hi)
Identification: UCH-201<Inscribed>

Old 86012FE020 (Low)
Identification: NML-202<Inscribed>



CAUTION: VEHICLE SERVICING PERFORMED BY UNTRAINED PERSONS COULD RESULT IN SERIOUS INJURY TO THOSE PERSONS OR TO OTHERS.

Subaru Service Bulletins are intended for use by professional technicians ONLY. They are written to inform those technicians of conditions that may occur in some vehicles, or to provide information that could assist in the proper servicing of the vehicle. Properly trained technicians have the equipment, tools, safety instructions, and know-how to do the job correctly and safely. If a condition is described, DO NOT assume that this Service Bulletin applies to your vehicle, or that your vehicle will have that condition.



Horn Selection for Replacement

- 1) If one horn needs to be replaced use New type horn.

New Type

86012FE040 (Low) Center

86012FE050 (High) Left Side

- 2) If both horns need to be replaced, the New type combination or Old type combination may be used.

New Type

86012FE040 (Low) Center

86012FE050 (High) Left Side

Old Type

86012FE030 (High) Center

86012FE020 (Low) Left side

PRODUCTION LINE CHANGE

A change in production was made in February, 2006 starting with the following VINs:

MODEL	BODY	VIN
Impreza	Sedan	6*516584
	Wagon	6*813101

ATTENTION:

GENERAL MANAGER PARTS MANAGER
 CLAIMS PERSONNEL SERVICE MANAGER

IMPORTANT - All Service Personnel Should Read and Initial

SUBARU 

Brought to you by Eris Studios
 NOT FOR RESALE

SERVICE BULLETIN

APPLICABILITY: All Models

NUMBER: 09-42-05

SUBJECT: Cautions Concerning Engine Coolant

DATE: 04/15/05

INTRODUCTION

The purpose of this bulletin is to inform of cautions concerning engine coolant.

REPAIR PROCEDURES/INFORMATION

When adding, replacing or servicing the cooling system always use **Genuine Subaru Long Life Coolant**. Genuine Subaru Long Life Coolant is a phosphate (non-amine) type and is specially formulated for all Subaru vehicles equipped with aluminum engines and radiators. Coolant of other types may not provide the proper protection to aid against corrosion of aluminum parts. If an equivalent must be used, make sure it is a phosphate (non-amine) type. As a reminder, use of Genuine Subaru Long Life Coolant is mandatory on all repairs paid for by Subaru of America, Inc. that require the replenishment of coolant. This holds true for any claim type.

Do not use flushing machines.

If a flushing machine has been used to service other brand vehicles with copper radiators, a chemical reaction between copper ions and Subaru coolant may occur. This could also cause clogging of the radiator.

If regular flushing is required, only use fresh tap water. Do not use hard water. Hard water will create calcium build up which will clog the radiator.

Whenever the coolant is changed, you must add Genuine Subaru Cooling System Conditioner. Genuine Subaru Cooling System Conditioner has been tested and approved for aluminum engines and radiators.

Do not use after-market coolant reinforcement agents, sealers and/or flushing agents as those chemicals could corrode aluminum parts.

This photo shows the condition of a clogged radiator that has been filled with non-genuine coolant. The residue is corroded aluminum.

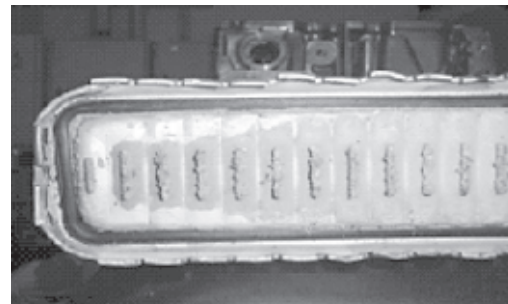

CAUTION: VEHICLE SERVICING PERFORMED BY UNTRAINED PERSONS COULD RESULT IN SERIOUS INJURY TO THOSE PERSONS OR TO OTHERS.

Subaru Service Bulletins are intended for use by professional technicians ONLY. They are written to inform those technicians of conditions that may occur in some vehicles, or to provide information that could assist in the proper servicing of the vehicle. Properly trained technicians have the equipment, tools, safety instructions, and know-how to do the job correctly and safely. If a condition is described, DO NOT assume that this Service Bulletin applies to your vehicle, or that your vehicle will have that condition.





SERVICE BULLETIN

APPLICABILITY: All Models
SUBJECT: Radiator Cap

NUMBER: 09-45-06
DATE: 11/28/06

INTRODUCTION

The purpose of this bulletin is to provide the inspection and cleaning procedure for the radiator cap.

Whenever servicing the coolant/radiator, it is imperative that the filler neck and cap are clean of all contaminants and debris.

If foreign material is left in the filler neck sealing area, it will become embedded in the rubber seal and will prevent the cap from sealing properly. Before making the determination that the radiator cap is faulty, perform the following repair procedure.

REPAIR PROCEDURE/INFORMATION

Caution: The engine cooling system is under pressure and may be extremely hot. To prevent personal injury or vehicle damage, be sure to take appropriate precautions while performing this procedure.

- 1) Wash and clean the rubber seal surface(s) "A" using clean water and a soft bristle brush.
- 2) Carefully open the negative pressure valve. Using clean water and a soft bristle brush wash and clean the mating surface "B" between the valve and the rubber seal.

Note: Clean thoroughly. Failure to do so will prevent the cap from holding pressure.

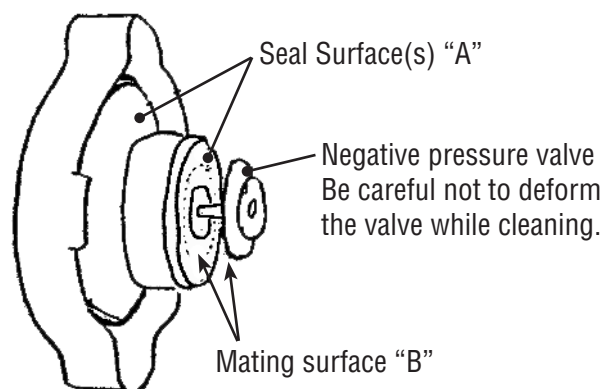

Continued on Next Page



CAUTION: VEHICLE SERVICING PERFORMED BY UNTRAINED PERSONS COULD RESULT IN SERIOUS INJURY TO THOSE PERSONS OR TO OTHERS.

Subaru Service Bulletins are intended for use by professional technicians ONLY. They are written to inform those technicians of conditions that may occur in some vehicles, or to provide information that could assist in the proper servicing of the vehicle. Properly trained technicians have the equipment, tools, safety instructions, and know-how to do the job correctly and safely. If a condition is described, DO NOT assume that this Service Bulletin applies to your vehicle, or that your vehicle will have that condition.



- 3) After cleaning, check valve-opening pressure of cap using a cap tester according to the applicable service manual.
- 4) Clean the filler neck sealing surface of any and all contaminants.

Note: If the valve opening pressure stays within the predetermined specification the cap is reusable. Only replace caps that failed the pressure test.

Special note: If the vehicle has any record of overheating the cap may not be reusable even after cleaning due to the deterioration of the sealing materials.

WARRANTY/CLAIM INFORMATION

For vehicles under the Basic New Car Limited Warranty period, this repair may be claimed using:

LABOR DESCRIPTION	LABOR OPERATION	FAIL CODE	LABOR TIME
Radiator Pressure Cap, R&R	B 228-121	CAH-29	0.2
Cooling System Pressure Testing & Diagnosis (Includes cleaning cap)	C 228-001		0.3

Brought to you by Eris Studios
NOT FOR RESALE

ATTENTION:

- GENERAL MANAGER
- PARTS MANAGER
- CLAIMS PERSONNEL
- SERVICE MANAGER

IMPORTANT - All Service Personnel Should Read and Initial in the boxes provided, right.

QUALITY DRIVEN® SERVICE



SUBARU

SERVICE BULLETIN

APPLICABILITY: All Vehicles

NUMBER: 09-47-07

SUBJECT: Coolant Flushing Machines and Additives

DATE: 08/31/07

INTRODUCTION

The purpose of this bulletin is to reinforce Subaru of America’s policy regarding the use of coolant flushing machines and/or cooling system flushing agents. Subaru does not recommend the use of any flushing machine or flushing agent under any circumstances.

If a flushing machine has been used to service other brand vehicles with copper radiators, a chemical reaction between copper ions and Subaru coolant may occur. This could also cause future clogging of the radiator. If a flushing machine is dedicated to only Subaru vehicles, it is still not recommended as there is no way to know that the coolants being removed and processed through the machine during servicing are / were exclusively Subaru Genuine Coolant.

If regular flushing is required, only use fresh tap water. Do not use hard water. Hard water will create calcium build up which will clog the radiator.

- When adding, replacing or servicing the cooling system, always use Genuine Subaru Long Life Coolant. Genuine Subaru Long Life Coolant is a phosphate (non-Amine) type and is specially formulated for all Subaru vehicles with aluminum engines and radiators. Coolant of other types may not provide the proper protection to aid against corrosion of aluminum parts.
- Whenever the coolant is changed, you must add Genuine Subaru Cooling System Conditioner. Genuine Subaru Cooling System Conditioner has been tested and approved for aluminum engines and radiators.
- Do not use after-market coolant reinforcement agents, sealers and/or flushing agents as those chemicals could corrode aluminum parts.

WARRANTY INFORMATION

Any coolant system failure and/or damage resulting from that failure that is a direct result of using a coolant flushing machine is not a matter for warranty.

CAUTION: VEHICLE SERVICING PERFORMED BY UNTRAINED PERSONS COULD RESULT IN SERIOUS INJURY TO THOSE PERSONS OR TO OTHERS.

Subaru Service Bulletins are intended for use by professional technicians ONLY. They are written to inform those technicians of conditions that may occur in some vehicles, or to provide information that could assist in the proper servicing of the vehicle. Properly trained technicians have the equipment, tools, safety instructions, and know-how to do the job correctly and safely. If a condition is described, DO NOT assume that this Service Bulletin applies to your vehicle, or that your vehicle will have that condition.



Brought to you by Eris Studios
NOT FOR RESALE

- ATTENTION:**
- GENERAL MANAGER
 - PARTS MANAGER
 - CLAIMS PERSONNEL
 - SERVICE MANAGER

IMPORTANT - All Service Personnel Should Read and Initial in the boxes provided, right.



SUBARU®

QUALITY DRIVEN® SERVICE

SERVICE BULLETIN

APPLICABILITY: 2007MY Impreza STI 2.5L Turbo

NUMBER: 11-83-07

DATE: 03/23/07

SUBJECT: Reprogramming Files for Surge on Hard Acceleration

INTRODUCTION

This is to announce that ECM reprogramming files are now available to rectify surge on hard acceleration between 3,000rpm and 4,000rpm.

PRODUCTION LINE CHANGE

The new logic was used in production starting in February, 2007 approximately with VIN 7L521848.

PACK FILE APPLICABILITY

PACK FILE NAME	PART # AFTER REPROGRAMMING	OLD PART #	MODEL/ENGINE/SPEC
22611AM411.pak	22611AM411	22611AM410	07MY Impreza STI, 2.5L Turbo (FED & CAL)

CAUTION: VEHICLE SERVICING PERFORMED BY UNTRAINED PERSONS COULD RESULT IN SERIOUS INJURY TO THOSE PERSONS OR TO OTHERS.

Subaru Service Bulletins are intended for use by professional technicians ONLY. They are written to inform those technicians of conditions that may occur in some vehicles, or to provide information that could assist in the proper servicing of the vehicle. Properly trained technicians have the equipment, tools, safety instructions, and know-how to do the job correctly and safely. If a condition is described, DO NOT assume that this Service Bulletin applies to your vehicle, or that your vehicle will have that condition.



Brought to you by Eris Studios
NOT FOR RESALE

ATTENTION:

- GENERAL MANAGER
- PARTS MANAGER
- CLAIMS PERSONNEL
- SERVICE MANAGER

IMPORTANT - All Service Personnel Should Read and Initial in the boxes provided, right.

QUALITY DRIVEN® SERVICE



SUBARU®

SERVICE BULLETIN

APPLICABILITY: 2005 and Later Naturally Aspirated (Non-Turbo) PZEV (Partial Zero Emission) models

NUMBER: 11-84-07
DATE: 10/15/07

SUBJECT: PZEV Idle Fluctuation after Cold Start

INTRODUCTION

This bulletin is for informational purposes only.

If you encounter a customer complaint about an idle fluctuation (“hunting”) during cold starts which generally last about 20 to 30 seconds the cause is a combination of factors.

Some of these are:

- Fuel blends
- Percentage of Ethanol content of the fuel being used
- Temperature
- Narrow operating range of the Air Fuel Ratio Sensor

The main cause of this idle fluctuation is fuel related and not the vehicle.

PZEV engines are designed to run on fuel blended for distribution within certain areas of the U.S. (such as the state of California). Fuels available in other markets, that may have adopted California emission standards, may be a slightly different blend. If you live in any other state than California, your vehicle will operate on gasoline meeting Federal specifications. However, PZEV vehicles may experience this issue especially during the summer months when summer blend fuels are distributed. There is no effect on vehicle emissions, and no short or long term damage will occur due to this issue.

The condition may be reduced or eliminated by changing to a fuel that contains a lesser percentage or no Ethanol. Also, a light throttle application while the vehicle is exhibiting this condition will stabilize the idle. As we move towards cooler weather many areas of the country will be changing to a winter blend of fuel which may also alleviate the condition.

If this condition is confirmed, no repair attempts should be performed beyond confirmation and checking all other systems are operating within design parameters.

CAUTION: VEHICLE SERVICING PERFORMED BY UNTRAINED PERSONS COULD RESULT IN SERIOUS INJURY TO THOSE PERSONS OR TO OTHERS.

Subaru Service Bulletins are intended for use by professional technicians ONLY. They are written to inform those technicians of conditions that may occur in some vehicles, or to provide information that could assist in the proper servicing of the vehicle. Properly trained technicians have the equipment, tools, safety instructions, and know-how to do the job correctly and safely. If a condition is described, DO NOT assume that this Service Bulletin applies to your vehicle, or that your vehicle will have that condition.



ATTENTION:

GENERAL MANAGER
CLAIMS PERSONNEL

PARTS MANAGER
SERVICE MANAGER



SUBARU

Brought to you by Eris Studios
מביא לך עריס סטודיו
למכירה בלבד

SERVICE BULLETIN

APPLICABILITY: 2007MY Subaru Vehicles
SUBJECT: Paint Code Information

NUMBER: 13-85-06
DATE: 07/13/06

INTRODUCTION

Note: This is the most accurate information available at the time of printing.

Various paint manufacturers designate their own stock numbers and coding information although many of the major suppliers now use the SOA paint codes to help eliminate confusion. Their color formulations are updated on a continual basis. Some vendors may have different color names than those provided by SOA. Be sure to double-check the codes and formulas to insure an accurate color match. If discrepancies arise, please refer your Body Shop contact inquiries to the specific paint vendor or jobber for the most updated formula information.

The paint coding information can be found on the vehicle's VIN plate which on Forester and Impreza models is located on top of the right front strut tower. For 2007, the information label on Legacy/Outback and B9 Tribeca has been re-located to the rear jamb edge of the right front door. The color codes will be three characters for solid colors and, three characters for a two-tone code.

EXAMPLES:

32J - Obsidian Black Pearl (monotone)

6B6 - Obsidian Black Pearl / Urban Gray Metallic (two-tone)



CAUTION: VEHICLE SERVICING PERFORMED BY UNTRAINED PERSONS COULD RESULT IN SERIOUS INJURY TO THOSE PERSONS OR TO OTHERS.

Subaru Service Bulletins are intended for use by professional technicians ONLY. They are written to inform those technicians of conditions that may occur in some vehicles, or to provide information that could assist in the proper servicing of the vehicle. Properly trained technicians have the equipment, tools, safety instructions, and know-how to do the job correctly and safely. If a condition is described, DO NOT assume that this Service Bulletin applies to your vehicle, or that your vehicle will have that condition.



2007 FORESTER PAINT CODES

EXTERIOR PAINT COLOR	PAINT CODE	TWO-TONE CODE
Obsidian Black Pearl	32J	--
Crystal Gray Metallic	48W	--
Champagne Gold Opal	39J	--
Garnet Red Pearl	33J	--
Aspen White	51E	--
*Newport Blue	64Z	--
*Urban Gray Metallic	45A	--
Obsidian Black Pearl / Urban Gray Metallic	32J / 45A	6B6
Newport Blue Pearl / Urban Gray Metallic	64Z / 45A	6H1
Crystal Grey Metallic / Urban Gray Metallic	48W / 45A	BR1
Evergreen Metallic / Urban Gray Metallic	55M / 45A	6B4
Garnet Red Pearl / Urban Gray Metallic	33J / 45A	6B7
Satin White / Platinum Silver Metallic	37J / 01G	BS2

* Indicates new color

2007 IMPREZA PAINT CODES

EXTERIOR PAINT COLOR	PAINT CODE	TWO-TONE CODE
Obsidian Black Pearl	32J	--
Crystal Grey Metallic	48W	--
*Urban Gray Metallic	26D	--
Garnet Red Pearl	33J	--
Satin White Pearl	37J	--
*Newport Blue Pearl	64Z	--
WR Blue Pearl	02C	--
Obsidian Black Pearl / Urban Gray Metallic	32J / 45A	6B6
Newport Blue Pearl / Urban Gray Metallic	64Z / 45A	6H1
Evergreen Metallic / Urban Gray Metallic	55M / 45A	6B4
Garnet Red Pearl / Urban Gray Metallic	33J / 45A	6B7
Urban Gray Metallic / Crystal Gray Metallic	45A / 48W	BR6

* Indicates new color

2007 LEGACY/OUTBACK PAINT CODES

EXTERIOR PAINT COLOR	PAINT CODE	TWO-TONE CODE
Brilliant Silver Metallic	39D	--
Champagne Gold Opal	39J	--
*Diamond Gray Metallic	65Z	--
*Newport Blue Pearl	64Z	--
Obsidian Black Pearl	32J	--
Regal Blue Pearl	35J	--
Satin White Pearl	37J	--
Brilliant Silver Metallic / Granite Gray Opal	39D/35S	3K3
Willow Green Opal / Moss Green Metallic	34W/38G	3U5
Newport Blue Pearl / Granite Gray Opal	64Z/35S	6S7

* Indicates new color

2007 B9 TRIBECA PAINT CODES

EXTERIOR PAINT COLOR	PAINT CODE	TWO-TONE CODE
Obsidian Black Pearl	32J	--
*Newport Blue Pearl	64Z	--
Seacrest Green Metallic	59E	--
*Harvest Gold Metallic	69K	--
*Diamond Gray Metallic	65Z	--
Titanium Silver Metallic	58E	--
Satin White Pearl	37J	--

* Indicates new color

2007 FORESTER PAINT CODES

CODE	COLOR NAME	DUPONT	SHERWIN- WILLIAMS/ MARTIN SENOUR	PPG	SPIES-HECKER	BASF-R/M GLASURIT	AKZO NOBEL	STANDOX
51E	Aspen White	51E	51E	91525	51E	51E	SUB4504	51E
33J	Garnet Red Pearl	33J	33J	904539	33J	33J	SUB9839	33J
32J	Obsidian Black Pearl	32J	32J	904540	32J	32J	SUB9841	32J
64Z*	Newport Blue Pearl	64Z	64Z	913969	64Z	64Z	SUB9532	64Z
01G	Platinum Silver Metallic	01G	01G	300064	01G	01G	SUB9106	01G
39J	Champagne Gold Pearl	39J	39J	29353	39J	39J	SUB9836	39J
48W	Crystal Gray Metallic	48W	48W	906935	48W	48W	SUB9869	48W
45A*	Urban Gray Metallic	45A	45A	906936	45A	45A	SUB9871	45A
37J	Satin White Pearl	37J	37J	907371	37J	37J	SUB9830	37J
55M	Evergreen Metallic	55M	55M	910428	55M	55M	SUB9833	55M

2007 IMPREZA PAINT CODES

CODE	COLOR NAME	DUPONT	SHERWIN- WILLIAMS/ MARTIN SENOUR	PPG	SPIES-HECKER	BASF-R/M GLASURIT	AKZO NOBEL	STANDOX
37J	Satin White Pearl	37J	37J	907371	37J	37J	SUB9830	37J
32J	Obsidian Black Pearl	32J	32J	904540	32J	32J	SUB9841	32J
64Z*	Newport Blue Pearl	64Z	64Z	913969	64Z	64Z	SUB9532	64Z
33J	Garnet Red Pearl	33J	33J	904539	33J	33J	SUB9839	33J
45A*	Urban Gray Metallic	45A	45A	906936	45A	45A	SUB9871	45A
26D	Steel Gray Metallic	26D	26D	301538	26D	26D	SUB9126	26D
02C	WR Blue Pearl	02C	02C	194512	02C	02C	SUB9105	02C
55M	Evergreen Metallic	55M	55M	910428	55M	55M	SUB9833	55M
48W	Crystal Gray Metallic	48W	48W	906935	48W	48W	SUB9869	48W

2007 LEGACY PAINT CODES

CODE	COLOR NAME	DUPONT	SHERWIN- WILLIAMS/ MARTIN SENOUR	PPG	SPIES-HECKER	BASF-R/M GLASURIT	AKZO NOBEL	STANDOX
64Z*	Newport Blue Pearl	64Z	64Z	913969	64Z	64Z	SUB9532	64Z
39D	Brilliant Silver Metallic	39D	39D	904537	39D	39D	SUB9842	39D
39J	Champagne Gold Opal	39J	39J	904459	39J	39J	SUB9836	39J
65Z*	Diamond Gray Metallic	65Z	65Z	913968	65Z	65Z	SUB9705	65Z
32J	Obsidian Black Pearl	32J	32J	904540	32J	32J	SUB9841	32J
35J	Regal Blue Pearl	35J	35J	904538	35J	35J	SUB9838	35J
37J	Satin White Pearl	37J	37J	907371	37J	37J	SUB9830	37J
34W	Willow Green Opal	34W	34W	907372	34W	34W	SUB9831	34W
38G	Moss Green Metallic	38G	38G	907370	38G	38G	SUB9832	38G
35S	Granite Gray Opal	35S	35S	904543	35S	35S	SUB9837	35S

007 B9 TRIBECA PAINT CODES

CODE	COLOR NAME	DUPONT	SHERWIN- WILLIAMS/ MARTIN SENOUR	PPG	SPIES-HECKER	BASF-R/M GLASURIT	AKZO NOBEL	STANDOX
32J	Obsidian Black Pearl	32J	32J	904540	32J	32J	SUB9841	32J
64Z*	Newport Blue Pearl	64Z	64Z	913969	64Z	64Z	SUB9532	64Z
69K*	Harvest Gold Metallic	69K	69K	914020	69K	69K	SUB9807	69K
59E	Seacrest Green Metallic	59E	59E	909545	59E	59E	SUB9618	59E
58E	Titanium Silver Metallic	58E	58E	909546	58E	58E	SUB9704	58E
65Z*	Diamond Gray Metallic	65Z	65Z	913968	65Z	65Z	SUB9705	65Z
37J	Satin White Pearl	37J	37J	907371	37J	37J	SUB9830	37J



SERVICE BULLETIN

APPLICABILITY: 2002MY and Later Impreza

NUMBER: 15-119-06

SUBJECT: Chattering/Vibration from
Front Door Speakers

DATE: 11/29/06

INTRODUCTION

If you encounter a customer complaint that the front door speaker(s) chatter and/or vibrate when the volume is set high, refer to the following repair procedure.

PARTS/MATERIAL INFORMATION

Countermeasure 1

3M™ Heavy Drip–Chek™ Sealer 08531

Countermeasure 2

SOA part # 61244FE100, Sealing Cover (with urethane) F Door, RH

SOA part # 61244FE110, Sealing Cover (with urethane) F Door, LH

3M™ Windo-Weld™ Round Ribbon Sealer 08625 or butyl tape as an equivalent.

Caution: Make sure to read and follow the directions, precautions, warnings, etc of the 3M™ products.

REPAIR PROCEDURE/INFORMATION

Verify the customer’s complaint by playing a commercially purchased CD and/or the radio.

Note: It is not advisable to play a burned (home made) CD, due to the fact the recording levels may have been set extremely high, which may cause undesirable chattering, vibration and/or distortion.

- 1) Check to make sure there is nothing in the door pockets that could cause chattering and/or vibrations. If there is, remove the objects.
- 2) Remove the door trim (refer to the applicable service manual) and check for loose or missing screws, broken or missing clips. Replace if necessary.
- 3) Check to make sure that the sealing cover is properly applied (no peeling, no misalignment, no breakage). Repair and/or replace as necessary.

Continued on Next Page



CAUTION: VEHICLE SERVICING PERFORMED BY UNTRAINED PERSONS COULD RESULT IN SERIOUS INJURY TO THOSE PERSONS OR TO OTHERS.

Subaru Service Bulletins are intended for use by professional technicians ONLY. They are written to inform those technicians of conditions that may occur in some vehicles, or to provide information that could assist in the proper servicing of the vehicle. Properly trained technicians have the equipment, tools, safety instructions, and know-how to do the job correctly and safely. If a condition is described, DO NOT assume that this Service Bulletin applies to your vehicle, or that your vehicle will have that condition.



If the speakers still chatter and/or vibrate, perform the following countermeasure(s):

- [A] Standard speaker, perform Countermeasure 1 & 2.
- [B] High-grade speaker, perform Countermeasure 1.

- Sealing covers with urethane are used with high-grade speakers; therefore countermeasure 2 does not need to be performed.

How to distinguish between Standard speaker and High-grade speaker

Vehicles equipped with standard speakers use a sealing cover **without** urethane.
Vehicles equipped with high-grade speakers use a sealing cover **with** urethane.

[A] Standard audio with standard speaker



1 DIN Radio (02MY and After)

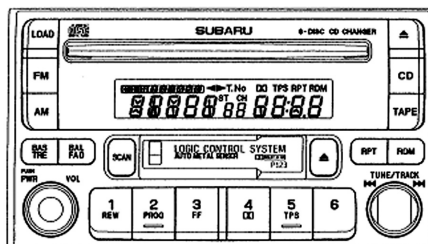

2 DIN Radio (02MY through 05MY)

[B] High-grade audio with high-grade speaker

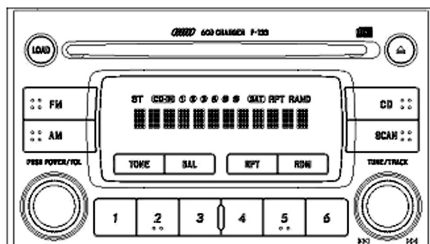

2 DIN Radio (05MY through 07MY)

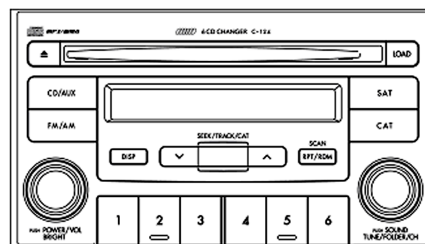

2 DIN Radio (07MY)

Continued on Next Page

Countermeasure 1

- 1) Remove the door trim, speaker and sealing cover (see figure 1, below).



- 2) Apply 3M™ Heavy Drip–Chek™ Sealer 08531 to the gap of the seam of the inner door panel (See figure 2, below).

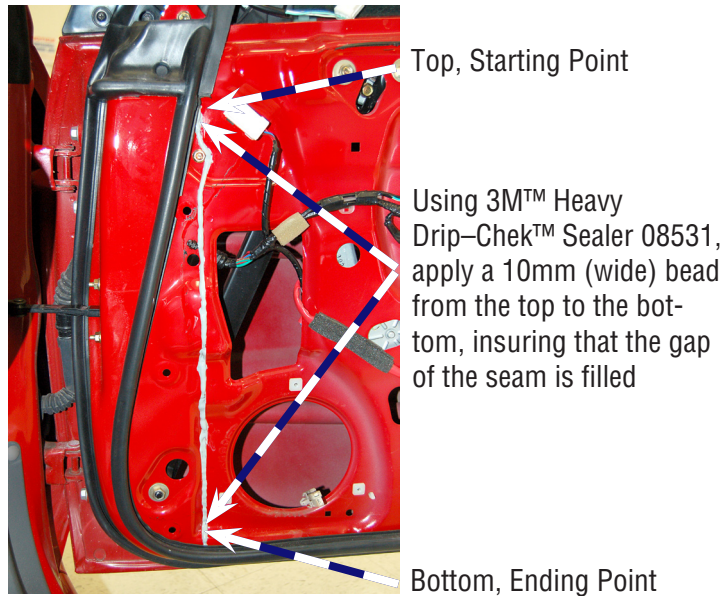

- 3) Reinstall the sealing cover (if equipped with standard speakers perform countermeasure 2), speaker and door trim.
- 4) Verify that the chatter and/or vibration is eliminated.

Countermeasure 2

- 1) Remove the door trim, speaker and sealing cover.

Continued on Next Page

- 2) Install a new sealing cover using 3M™ Windo-Weld™ Round Ribbon Sealer 08625 (See figure 3, below). Make sure to use a uniform bead and press firmly to insure the sealing cover stays in place. **Note:** Breaks in the bead will allow water leakage and contamination.

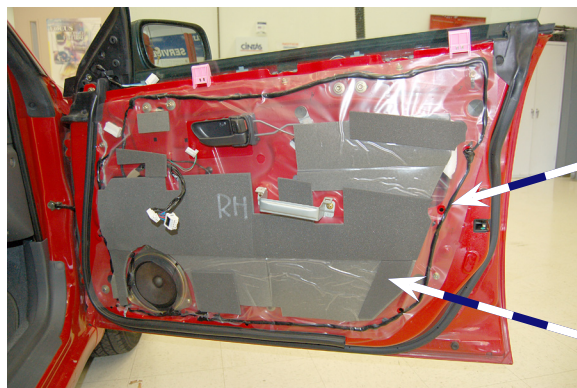

3M™ Windo-Weld™ Round Ribbon Sealer 08625

Sealing cover with urethane

- Reinstall the speaker and door trim.
- Verify that the chatter and/or vibration is eliminated.

WARRANTY/CLAIM INFORMATION

For vehicles under the Basic New Car Limited Warranty period, this repair may be claimed using:

LABOR DESCRIPTION	LABOR OPERATION	FAIL CODE	LABOR TIME
Front Door Speaker Vibration Modification - One Door (Includes diagnostics)	B 915 - 212	YMK - 48	0.6
Front Door Speaker Vibration Modification - Both Doors – ADD	C 915 - 225	YMK - 48	0.3

ATTENTION:
GENERAL MANAGER
PARTS MANAGER
CLAIMS PERSONNEL
SERVICE MANAGER

IMPORTANT - All Service Personnel Should Read and Initial in the boxes provided, right.



SUBARU

QUALITY DRIVEN® SERVICE

SERVICE BULLETIN

APPLICABILITY: All Models Equipped with an In-dash CD Changer/Player
SUBJECT: In-dash CD Changer/Player Discs

NUMBER: 15-120-07
DATE: 03/07/07

INTRODUCTION

The purpose of this bulletin is to inform of cautions concerning compact discs. There have been an increasing number of changers/players being replaced under warranty. We have found that the majority of all failures are the result of the use of damaged CDs, non-compatible user-created CDs and labels, or multiple CDs inserted at the same time jamming the player or damaging the CD. The resultant damage to the player is generally not detected until after the audio exchange has been completed.

Customers coming in with CD changer/player issues should be reminded at the time of the unit exchange that the use of CDs as described above are the potential causes of problems.

We encourage you to make a copy of page 3 of this bulletin and provide it to your customers when an exchange unit is installed.

EXAMPLES OF PEELING LABELS

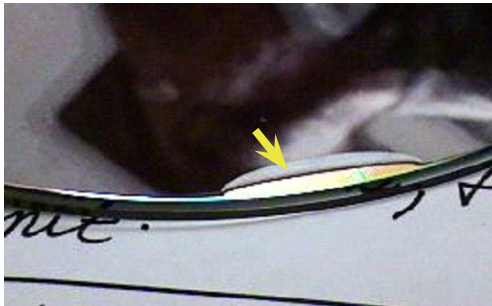

continued...

CAUTION: VEHICLE SERVICING PERFORMED BY UNTRAINED PERSONS COULD RESULT IN SERIOUS INJURY TO THOSE PERSONS OR TO OTHERS.
Subaru Service Bulletins are intended for use by professional technicians ONLY. They are written to inform those technicians of conditions that may occur in some vehicles, or to provide information that could assist in the proper servicing of the vehicle. Properly trained technicians have the equipment, tools, safety instructions, and know-how to do the job correctly and safely. If a condition is described, DO NOT assume that this Service Bulletin applies to your vehicle, or that your vehicle will have that condition.



EXAMPLES OF BROKEN/CRACKED DISCS

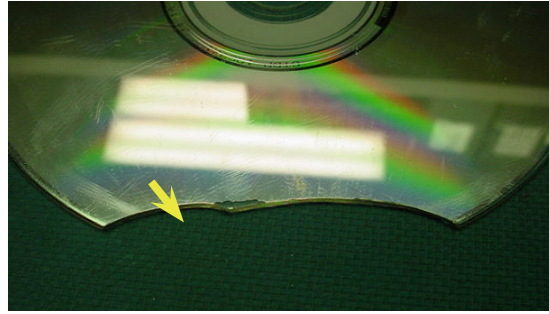
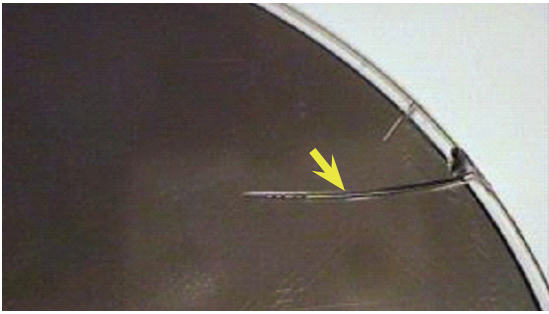

EXAMPLE OF DOUBLE-DISC INSERTION

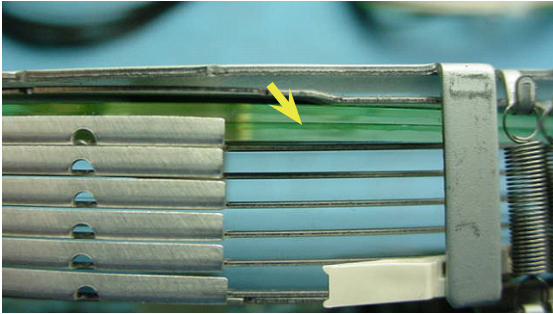

EXAMPLE OF ODD-SHAPED DISC





PLEASE USE CAUTION WHEN USING YOUR GENUINE SUBARU IN-DASH CD CHANGER/PLAYER

In-dash compact disc (CD) players are a great way to enjoy crystal-clear music in your Subaru. Subaru CD players are designed to play standard 4 3/4 inch diameter CDs, which carry the “Compact Disc Digital Audio” logo.



The following CDs may cause problems when loading, playing, or ejecting due to the complexity of your CD player’s internal mechanisms.

1. Small size, irregularly shaped discs.

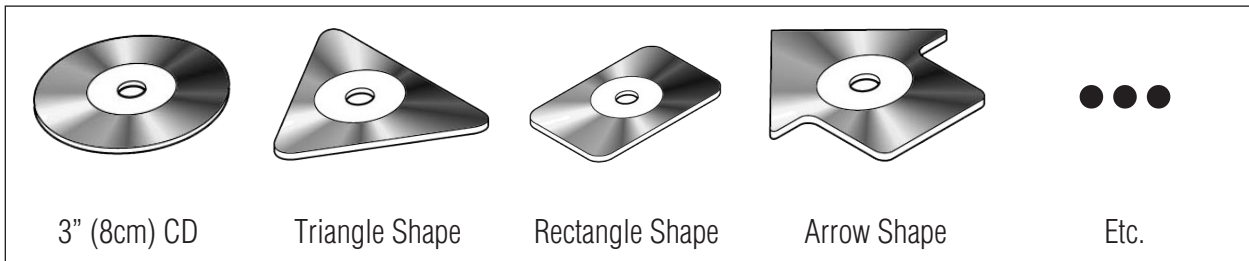

2. Excessively thick discs.

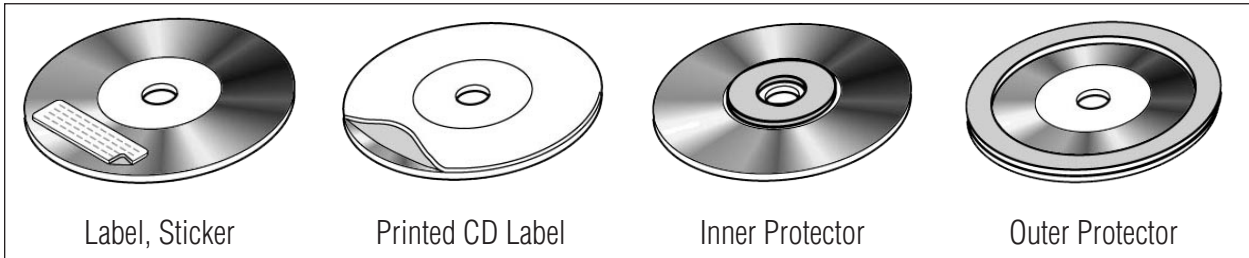

3. Damaged Discs

4. Poor quality discs.

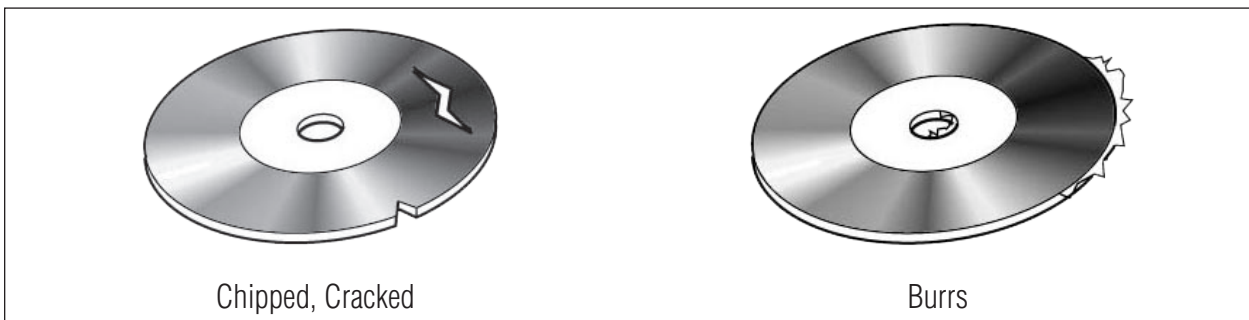

Brought to you by Eris Studios
NOT FOR RESALE

ATTENTION:

- GENERAL MANAGER
- PARTS MANAGER
- CLAIMS PERSONNEL
- SERVICE MANAGER

IMPORTANT - All Service Personnel Should Read and Initial in the boxes provided, right.

QUALITY DRIVEN® SERVICE



SUBARU

SERVICE BULLETIN

APPLICABILITY: All 2007MY Subaru Vehicles
SUBJECT: Exchange Component Identification and Procedures

NUMBER: 15-124-07
DATE: 07/31/07

INTRODUCTION

This bulletin contains illustrations of exchange components and their manufacturer as well as a description of the proper exchange procedure. The exchange program policy can also be found in Section 8.4.9 of your CDS Policies and Procedures Manual.

AUDIO EXCHANGE PROGRAM

Within the terms of the Basic New Car Warranty, the Exchange Program provides for replacement of a defective audio chassis and/or faceplate with an exchange unit from the manufacturer. The manufacturer will supply an exchange unit, or a new unit in the case of a “New” and “In-stock” vehicle.

Note: DO NOT disassemble an In-Dash CD Changer to retrieve any lodged CD(s) prior to returning to the manufacturer. See Section 8.4.9.4 for the policy on returning the CD(s) to the customers.

Genuine Subaru audio systems are manufactured by Panasonic and Clarion. In the event an audio chassis/faceplate requires an exchange, it is not necessary to remove the unit from the vehicle. The procedures listed below should be followed:

- 1) The defective chassis should remain in the vehicle until the exchange unit is installed.
- 2) The applicable Service Center should be contacted. Panasonic Service Center is open from 8 AM to 8 PM Eastern Time. Clarion Service Center is open from 7 AM to 5 PM Pacific Time:

PANASONIC	CLARION
1-800-228-0473	1-800-347-8933

NOTE: In the event the vehicle is “New” and “In-stock”, inform the Service Center. A new unit will be supplied rather than an exchange unit. If the Service Center is unable to provide a new unit, immediately contact your Subaru Service Representative for further instructions.

Continued on next page...

CAUTION: VEHICLE SERVICING PERFORMED BY UNTRAINED PERSONS COULD RESULT IN SERIOUS INJURY TO THOSE PERSONS OR TO OTHERS.

Subaru Service Bulletins are intended for use by professional technicians ONLY. They are written to inform those technicians of conditions that may occur in some vehicles, or to provide information that could assist in the proper servicing of the vehicle. Properly trained technicians have the equipment, tools, safety instructions, and know-how to do the job correctly and safely. If a condition is described, DO NOT assume that this Service Bulletin applies to your vehicle, or that your vehicle will have that condition.



Vehicles that have been placed in demo service should use exchange units only.

Replacement of an audio chassis/faceplate with a new unit, other than units supplied through the exchange program, requires authorization from your Subaru Service Representative. An authorization code will be provided and must be included upon claim submission.

3) Provide the Service Center with the following information:

- Dealer Code
- Dealer Name and Address
- VIN - All 17 Characters
- Date of Vehicle Sale
- Vehicle Mileage
- Caller's Name and Telephone Number
- Claim Number
- ID Code and/or the Subaru Part Number
- Customer Complaint
- Customer Last Name

At this time, the Service Center will issue an exchange number. It is required that this number be provided upon claim submission.

Panasonic Exchange Number Example....S0000001
Clarion Exchange Number Example...(ERS#)...0000000001

An exchange chassis along with an exchange form will be shipped within 72 hours. If the exchange chassis is not received within 5 days, call the Service Center. Provide the operator with the exchange number when making inquiries.

- 4) Install the exchange unit as soon as possible upon receipt. Return the defective chassis to the manufacturer within 30 days. Return freight charges may be claimed as sublet, provided the repair was performed under the terms of the Basic New Car Warranty. Copies of the freight invoice should be attached to the repair order.

If the exchange unit has not been installed or the failed chassis returned within 30 days, contact the Service Center. Reference the exchange number and explain the circumstances causing the delay. An extension will be granted or the dealer will be instructed to return the exchange unit. Failure to comply will result in a "charge back" to the dealer for the cost of the exchange unit.

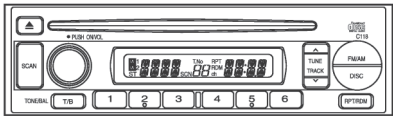
ILLUSTRATION	DESCRIPTION	MANUFACTURER	PART NUMBER
	Impreza Type A AM/FM Single Disc CD player (C122)	Clarion	86201FE131 Audio Unit Only

Continued on next page...

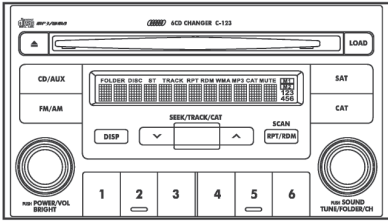
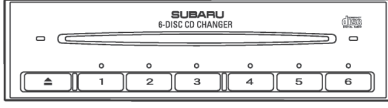
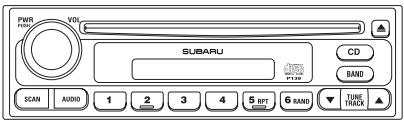
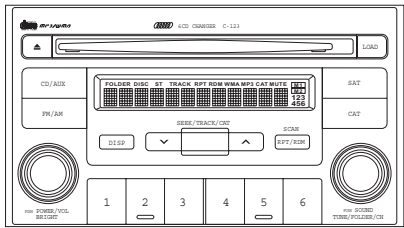
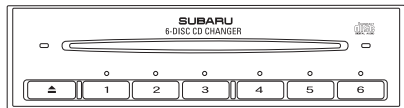
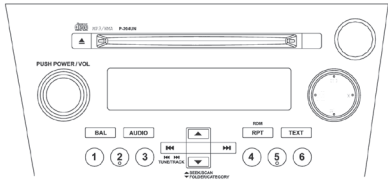
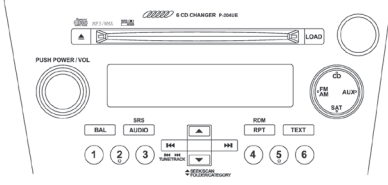
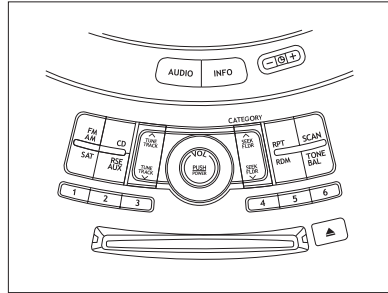
ILLUSTRATION	DESCRIPTION	MANUFACTURER	PART NUMBER
	Impreza 6 CD-GIX Combi with SAT Control	Clarion	86201FE250 Audio Unit Only
	Impreza Optional 6 Disc CD Changer	Clarion	H6240SS301 Audio Unit Only
	Forester Type A AM/FM Single Disc CD Player (P139)	Panasonic	86201SA360 Audio Unit Only
	Forester 6CD-GIX Combi with SAT Control	Clarion	86201SA350 Audio Unit Only
	Forester Optional 6 Disc CD Changer	Clarion	H6240SS301 Audio Unit Only
	Legacy/Outback AM/FM Single Disc CD Player / Face Plate (P204UN)	Panasonic	86201AG69A* Audio / Face Plate Assembly
	Legacy/Outback AM/FM 6 Disc CD Changer / Face Plate (P204UH)	Panasonic	86201AG67A* Audio / Face Plate Assembly
	Tribeca AM/FM Single Disc CD Player MP3 XM SAT	Panasonic	86213XA16A Face Plate Only

* For either audio or face plate failures, order the assembly.

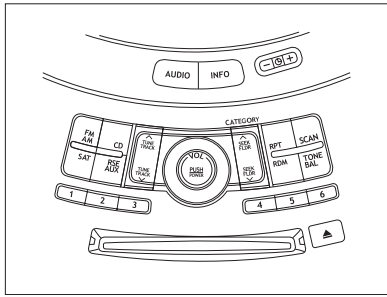
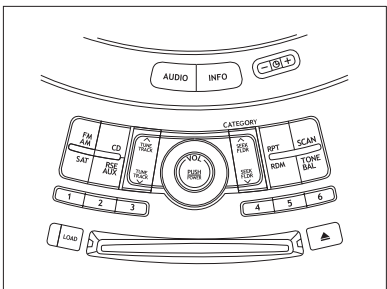
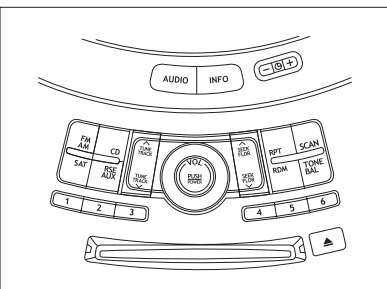
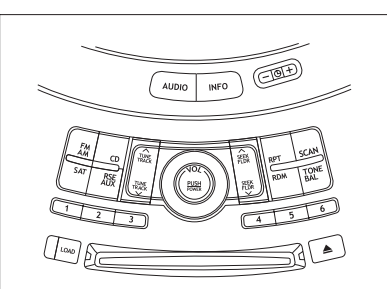
ILLUSTRATION	DESCRIPTION	MANUFACTURER	PART NUMBER
	Tribeca AM/FM Single Disc CD Player MP3 XM SAT; Heated Seats;	Panasonic	86213XA15A Face Plate Only
	Tribeca AM/FM 6 Disc CD Player MP3 XM SAT (P141)	Panasonic	86213XA04A Face Plate Only
	Tribeca AM/FM Single Disc CD Player MP3 XM SAT	Panasonic	86213XA14A Audio Unit Only
	Tribeca AM/FM 6 Disc CD Player MP3 XM SAT (P141)	Panasonic	86213XA15A Audio Unit Only

REAR SEAT ENTERTAINMENT EXCHANGE PROGRAM

Within the terms of the Basic New Car Warranty, the Audio / Rear Seat Entertainment Exchange Program provides for replacement of a defective rear seat entertainment unit (DVD player only) with an exchange unit from the manufacturer. Headphones and Rear Seat Entertainment remote control units are orderable through the Subaru Parts Dept. and not covered by this exchange program. The manufacturer will supply an exchange unit, or a new unit in the case of a “New” and “In-stock” vehicle.

Note: DO NOT disassemble a Rear Seat Entertainment Unit to retrieve a lodged DVD prior to returning to the manufacturer. See Section 8.4.9.4 for the policy on returning the DVDs to the customers.

The B9 Tribeca rear seat entertainment system is manufactured by Panasonic. In the event a rear seat entertainment unit requires an exchange, it is not necessary to remove the unit from the vehicle. The procedures listed below should be followed:

- 1) The defective chassis should remain in the vehicle until the exchange unit is installed.
- 2) The applicable Service Center should be contacted. The Service Center is open from 7 AM - 7 PM Eastern Time.



NOTE: In the event the vehicle is “New” and “In-stock”, inform the Service Center. A new unit will be supplied rather than an exchange unit. If the Service Center is unable to provide a new unit, immediately contact your Subaru Service Representative for further instructions.

Vehicles that have been placed in demo service should use exchange units only.

Replacement of a rear seat entertainment unit with a new unit, other than units supplied through the exchange program, requires authorization from your Subaru Service Representative (see Section 8.4.10). An authorization code will be provided and must be included upon claim submission.

- 3) Provide the Service Center with the following information:

- Dealer Code
- Dealer Name and Address
- VIN - All 17 Characters
- Date of Vehicle Sale
- Vehicle Mileage
- Caller’s Name and Telephone Number
- Claim Number
- Chassis Model Number, ID Code and/or the Subaru Part Number
- Customer Complaint
- Customer Last Name

At this time, the Service Center will issue an exchange number. It is required that this number be provided upon claim submission.

PANASONIC EXCHANGE NUMBER EXAMPLE..... S0000001

An exchange chassis along with an exchange form will be shipped within 72 hours. If the

exchange chassis is not received within 5 days, call the Service Center. Provide the operator with the exchange number when making inquiries.

- 4) Install the exchange unit as soon as possible upon receipt. Return the defective chassis to the manufacturer within 30 days. Return freight charges may be claimed as sublet, provided the repair was performed under the terms of the Basic New Car Warranty. Copies of the freight invoice should be attached to the repair order.

If the exchange unit has not been installed or the failed chassis returned within 30 days, contact the Service Center. Reference the exchange number and explain the circumstances causing the delay. An extension will be granted or the dealer will be instructed to return the exchange unit. Failure to comply will result in a “charge back” to the dealer for the cost of the exchange unit.

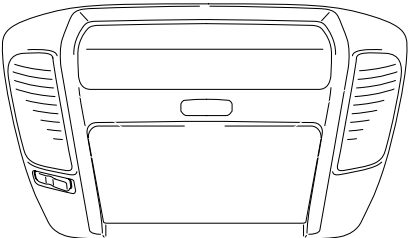
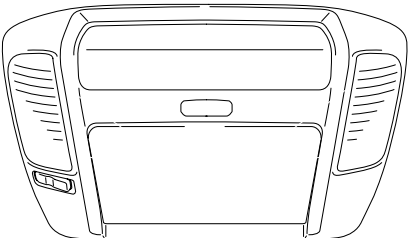
ILLUSTRATION	DESCRIPTION	MANUFACTURER	PART NUMBER
	Rear Seat DVD Unit Gray	Panasonic	86255XA00AMV
	Rear Seat DVD Unit Beige	Panasonic	86255XA00AEU

NAVIGATION SYSTEM EXCHANGE PROGRAM

Within the terms of the Basic New Car Warranty, the Navigation System Exchange Program provides for replacement of a defective navigation assembly and/or display screen with an exchange unit from the manufacturer. The manufacturer will supply an exchange unit, or a new unit in the case of a “New” and “In-stock” vehicle.

Genuine Subaru navigation systems are manufactured by Kenwood Corporation. In the event a navigation unit or display screen requires an exchange, it is not necessary to remove the unit from the vehicle. The procedures listed below must be followed:

- 1) The failure must be confirmed and diagnosed utilizing the Kenwood Exchange Request Form Diagnostic Checklist (See Section 17.9) and the applicable Subaru Service Manual section(s).
- 2) Fax the completed Kenwood Exchange Request Form to Kenwood Service Center West. The Service Center is open from 9 AM – 5:30 PM Pacific Time.

FAX TELEPHONE NUMBER	SERVICE CENTER TELEPHONE NUMBER
1-562-483-8749	1-562-483-8740

- 3) The form must be properly and legibly completed to receive an exchange unit. Kenwood will return incomplete request forms and no exchange unit will be shipped. Requests arriving after 2:00 PM PST are processed the following business day.

Note: In the event the vehicle is “New” and “In-stock”, indicate this on the exchange form. A new unit will be supplied rather than an exchange unit.

Vehicles that have been placed in demo service should use exchange units only.

- 4) Kenwood will either ship an exchange unit or reject the request by the next business day.

Upon acceptance of the Exchange Request, Kenwood will ship the exchange unit directly to the dealer via second day air. An invoice will be included with the exchange unit. It is required that the 6 digit “invoice number” be provided upon claim submission.

KENWOOD EXCHANGE NUMBER EXAMPLE... (Invoice #)... 000000

If rejected, Kenwood will promptly notify the dealer of reason for rejection. Kenwood may reject the request if the Exchange Request Form has not been properly and legibly completed.

- 5) The dealer must return the failed component to Kenwood in the same approved packaging that the exchange unit arrived in. A hard copy of the original Exchange Request Form and the Diagnostic Checklist (See Section 17.9) must be included in the core return package. Return freight charges may be claimed as sublet, provided the repair was performed under the terms of the Basic New Car Warranty. Copies of the freight invoice should be attached to the repair order.

If replacement DVDs were supplied, then the vehicle’s two (2) original navigation DVDs must accompany the returned unit or a charge will be incurred.

Failure to use proper packaging could result in a “charge back” for the cost of the exchange unit and shipping.

If the exchange component has not been installed or returned to Kenwood within 30 days from the receipt of the exchange unit, the dealer will receive a “charge back” for the cost of the exchange unit and shipping.

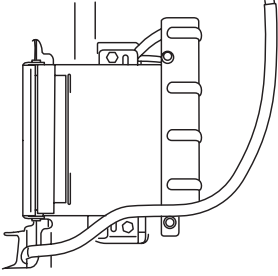
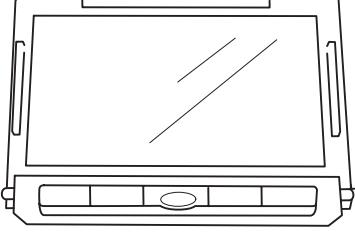
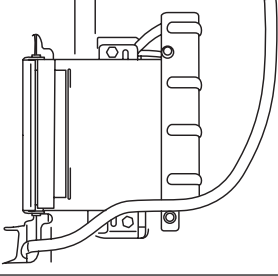
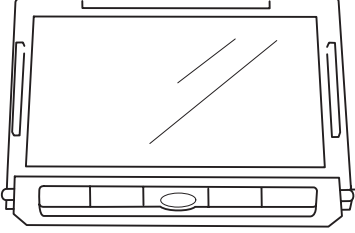
ILLUSTRATION	DESCRIPTION	MANUFACTURER	PART NUMBER
	Tribeca Navigation Unit	Kenwood	86271XR00AR1
	Tribeca Navigation Display	Kenwood	86281XA05AR1
	Legacy Outback Navigation Unit	Kenwood	86271AG04AR1
	Legacy Outback Navigation Display	Kenwood	86281AG12AR1

SATELLITE RADIO EXCHANGE PROGRAM

Within the terms of the Basic New Car Warranty, the Satellite Radio Exchange Program provides for replacement of a defective control module with an exchange module from the manufacturer. The manufacturer will supply an exchange unit, or a new unit in the case of a “New” and “In-stock” vehicle.

Genuine Subaru Satellite Radio Accessories are manufactured by Clarion. In the event the control module requires an exchange, it is not necessary to remove the unit from the vehicle. The procedures listed below should be followed:

- 1) The defective module should remain in the vehicle until the exchange unit is installed.
- 2) The applicable Service Center should be contacted. The Service Center is open from 7 AM - 5 PM Pacific Time:

CLARION

1-800-347-8933

Brought to you by Eris Studios
NOT FOR RESALE

NOTE: In the event the vehicle is “New” and “In-stock”, inform the Service Center. A new unit will be supplied rather than an exchange unit. If the Service Center is unable to provide a new unit, immediately contact your Subaru Service Representative for further instructions.

Vehicles that have been placed in demo service should use exchange units only.

Replacement of the control module with a new unit, other than units supplied through the exchange program, requires authorization from your Subaru Service Representative (see section 8.4.10). An authorization code will be provided and must be included upon claim submission.

3) Provide the Service Center with the following information:

Dealer Code
Dealer Name and Address
VIN - All 17 Characters
Vehicle Year
Vehicle Model
Date of Vehicle Sale
Vehicle Mileage
Subaru Part Number
Customer Complaint
Customer Last Name

At this time, the Service Center will issue an exchange number. It is required that this number be provided upon claim submission.

Clarion Exchange Number Example...(ERS#)... 000000001

An exchange module along with an exchange form will be shipped within 72 hours. If the exchange module is not received within 5 days, call the Service Center. Provide the operator with the exchange number when making inquiries.

4) Install the exchange unit as soon as possible upon receipt. Return the defective module to the manufacturer within 30 days. Return freight charges may be claimed as sublet, provided the repair was performed under the terms of the Basic New Car Warranty. Copies of the freight invoice should be attached to the repair order.

If the exchange unit has not been installed or the failed module returned within 30 days, contact the Service Center. Reference the exchange number and explain the circumstances causing the delay. An extension will be granted or the dealer will be instructed to return the exchange unit. Failure to comply will result in a “charge back” to the dealer for the cost of the exchange unit.

Note: Activation of all subscription based services is the responsibility of the vehicle owner.

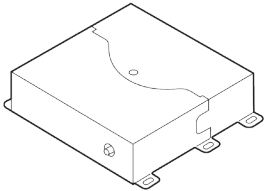
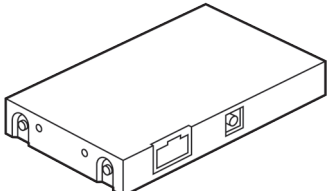
ILLUSTRATION	DESCRIPTION	MANUFACTURER	PART NUMBER
	Impreza / Forester Sirius Satellite Tuner	Clarion	H621SSA110
	Legacy / Tribeca XM Satellite Tuner	Clarion	H621SXA010

8.4.9.4. RETURN OF CD/DVD(S) LODGED IN AN IN-DASH CD CHANGER OR REAR SEAT ENTERTAINMENT UNIT

In the event that DVD/ CD(s) become lodged in the In-Dash CD Changer or Rear Seat Entertainment Unit, do not disassemble the unit to retrieve the DVD/ CD(s). Please use the following procedure:

- 1) Follow the normal exchange procedures for requesting a replacement changer.
- 2) Record a daytime telephone number where the customer can be reached and retain in customer's file.
- 3) Remove the defective unit from the vehicle and return it to the manufacturer.
 DVD/ CD(s) that have been successfully removed by the manufacturer will be returned directly to the dealer within 10 calendar days. It is the dealer's responsibility to notify the customer when the DVD/CD(s) are returned.

In the event a DVD/ CD(s) has been damaged, the manufacturer will reimburse the customer through the dealer at \$15.00 per damaged CD or \$20.00 per damaged DVD. Panasonic will forward a check for this reimbursement to the dealer. The dealer must in turn reimburse the customer. Only commercially produced DVD/ CD(s) can be included in the reimbursement program.

ATTENTION:

- GENERAL MANAGER
- PARTS MANAGER
- CLAIMS PERSONNEL
- SERVICE MANAGER

IMPORTANT - All Service Personnel Should Read and Initial in the boxes provided, right.

QUALITY DRIVEN® SERVICE



SUBARU®

SERVICE BULLETIN

APPLICABILITY: All Vehicles
SUBJECT: Subaru Wheel Locks

NUMBER: 15-125-07
DATE: 08/29/07

INTRODUCTION

The purpose of this bulletin is to provide the proper procedure for removing and installing Subaru wheel locks. Failure to follow this procedure can cause damage to the wheel locks and/or wheels.

REPAIR PROCEDURE/INFORMATION

- 1) Remove one lug nut from each wheel. If wheel studs are dirty, clean with a wire brush prior to installing locks. Use extreme care to prevent damage to the wheel.
- 2) By hand, install one wheel lock on each wheel.
- 3) Using the special wheel lock key and a torque wrench, tighten each wheel lock to the proper lug nut torque specification (refer to the applicable Subaru Service Manual).

NOTE: For ease of installation and removal, the wheel lock should always be the last lug nut tightened on each wheel and should always be the first one removed.

WARNING: Use of an impact wrench may cause permanent damage to the wheel lock and key.



WARRANTY INFORMATION

Wheel locks and/or keys that are damaged due to improper installation and/or removal is not a matter for warranty.

CAUTION: VEHICLE SERVICING PERFORMED BY UNTRAINED PERSONS COULD RESULT IN SERIOUS INJURY TO THOSE PERSONS OR TO OTHERS.

Subaru Service Bulletins are intended for use by professional technicians ONLY. They are written to inform those technicians of conditions that may occur in some vehicles, or to provide information that could assist in the proper servicing of the vehicle. Properly trained technicians have the equipment, tools, safety instructions, and know-how to do the job correctly and safely. If a condition is described, DO NOT assume that this Service Bulletin applies to your vehicle, or that your vehicle will have that condition.



ATTENTION:

GENERAL MANAGER PARTS MANAGER
CLAIMS PERSONNEL SERVICE MANAGER

IMPORTANT - All Service Personnel Should Read and Initial



Brought to you by Eris Studios
NOT FOR RESALE

SERVICE BULLETIN

APPLICABILITY: All A/T and M/T Vehicles
SUBJECT: Transmission Rear Cross-Member

NUMBER: 03-53-04
16-54-04
DATE: 08/20/04

INTRODUCTION

The purpose of this bulletin is to prevent the possibility of damaging the bolts and/or threads that secure the transmission rear cross member.

REPAIR PROCEDURES/INFORMATION

When performing service work or installing SOA's accessory short throw shifter, it is extremely important that the transmission is supported properly when removing or reinstalling the cross member. If not, damage to the bolts and/or threads will occur. Support the transmission using a transmission jack, regardless if the vehicle is supported by a lift or car ramps (**Figure 1**). It is recommended that hand tools be used for the removal and installation of the bolts. Inspect for bolt thread damage and replace as necessary. Be sure to clean any protective wax from the mating surfaces and be sure to start all bolts several threads by hand before using tightening tools. **Note: If severe damage is evident to the threads, the use of a Heli-coil® type kit is an approved repair method.**

During reinstallation, follow the torque sequence, below (**Figure 2**) and the torque specifications (**Figure 3; next page**).



Figure 1

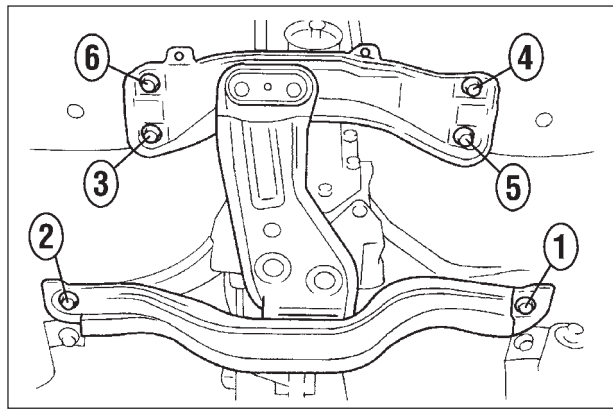

Figure 2

continued on next page...



CAUTION: VEHICLE SERVICING PERFORMED BY UNTRAINED PERSONS COULD RESULT IN SERIOUS INJURY TO THOSE PERSONS OR TO OTHERS.

Subaru Service Bulletins are intended for use by professional technicians ONLY. They are written to inform those technicians of conditions that may occur in some vehicles, or to provide information that could assist in the proper servicing of the vehicle. Properly trained technicians have the equipment, tools, safety instructions, and know-how to do the job correctly and safely. If a condition is described, DO NOT assume that this Service Bulletin applies to your vehicle, or that your vehicle will have that condition.



Bolts must be torqued to the proper specifications (**Figure 3**).

T1: 70 N·m (7.1 kgf-m, 51 ft-lb)

T2: 140 N·m (14.3 kgf-m, 103 ft-lb)

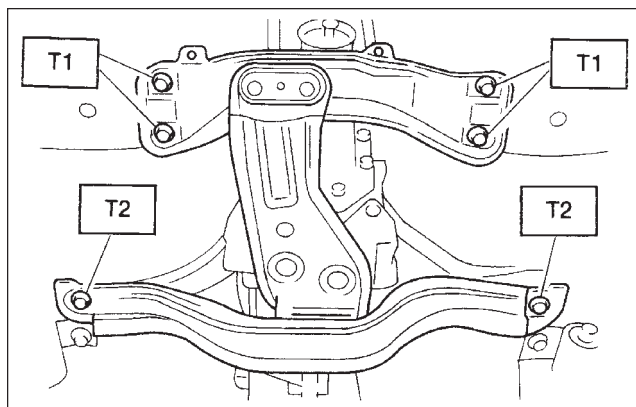

Figure 3

ATTENTION:

GENERAL MANAGER
CLAIMS PERSONNEL

PARTS MANAGER
SERVICE MANAGER

IMPORTANT - All Service Personnel Should Read and Initial



SUBARU

Brought to you by Eris Studios
מביא לך עריס סטודיו
למכירה בלבד

SERVICE BULLETIN

APPLICABILITY: 2005~08MY Legacy, Outback, Impreza and Forester Vehicles Equipped with 4EAT
SUBJECT: Diagnostic procedures for P0851/P0852
NUMBER: 16-68-06
DATE: 10/09/06

INTRODUCTION

The purpose of this bulletin is to assist when diagnosing P0851 (Neutral Switch Input Circuit Low) and P0852 (Neutral Switch Input Circuit High). If you encounter a vehicle with P0851 and/or P0852, use the following repair procedure.

REPAIR PROCEDURE/INFORMATION

Using the Subaru Select Monitor, check for diagnostic trouble codes stored in memory. If P0851 and/or P0852 are stored in memory, adjust the inhibitor switch and select cable.

Note: Refer to the applicable Subaru Service Manual found on the STIS web-site for component removal to gain access to the inhibitor switch and select cable. It is critical that the following adjustments are performed correctly.

Adjustment for inhibitor switch

- 1) Set the select lever to "N" range.
- 2) Loosen the three inhibitor switch securing bolts.
- 3) Insert ST (special tool) 499267300 Stopper Pin as vertical as possible into the holes in the inhibitor switch lever and switch body.

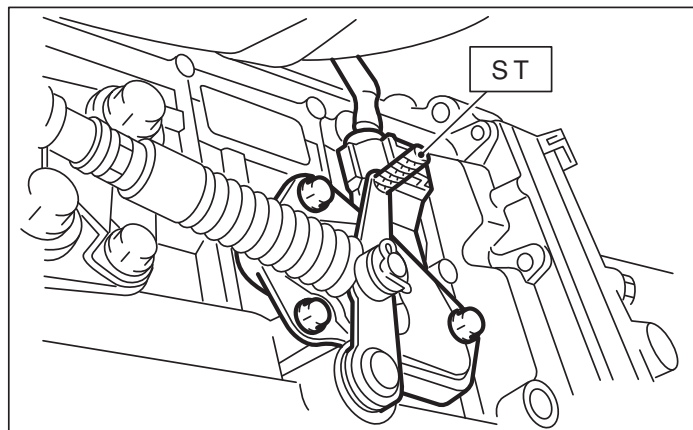

CAUTION: VEHICLE SERVICING PERFORMED BY UNTRAINED PERSONS COULD RESULT IN SERIOUS INJURY TO THOSE PERSONS OR TO OTHERS.

Subaru Service Bulletins are intended for use by professional technicians ONLY. They are written to inform those technicians of conditions that may occur in some vehicles, or to provide information that could assist in the proper servicing of the vehicle. Properly trained technicians have the equipment, tools, safety instructions, and know-how to do the job correctly and safely. If a condition is described, DO NOT assume that this Service Bulletin applies to your vehicle, or that your vehicle will have that condition.



- 4) Tighten the three inhibitor switch securing bolts then remove special tool.
Tightening torque: 3.4 N-m (0.35 kgf-m, 2.5 ft-lb)

Adjustment for select cable

- 1) With the select lever already in the “N” range, loosen the adjusting nuts A and B on both sides.

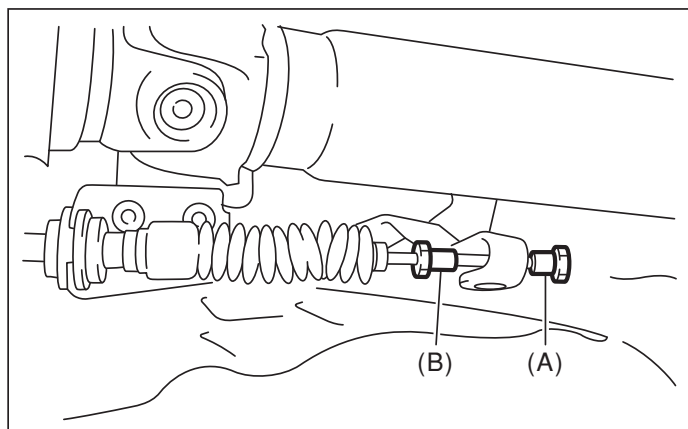

(A) Adjusting Nut A (B) Adjusting Nut B

- 2) Turn the adjusting nut B until it lightly touches the connector.

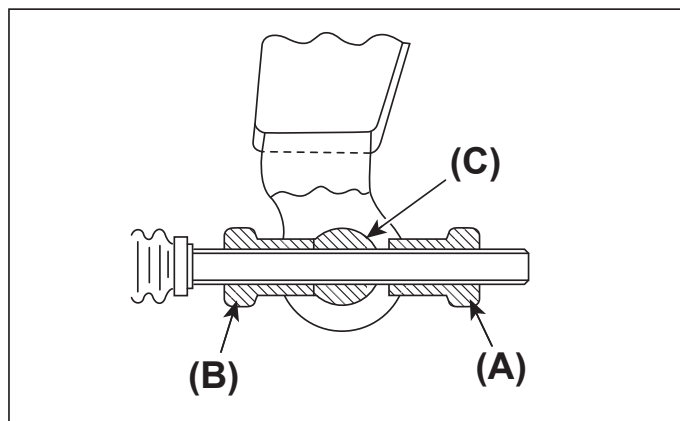

(A) Adjusting Nut A
(B) Adjusting Nut B
(C) Connector

- 3) Use a spanner wrench to hold nut B so that it does not rotate and then tighten the adjusting nut A.

Tightening torque: 7.5 N-m (0.76 kgf-m, 5.5 ft-lb)

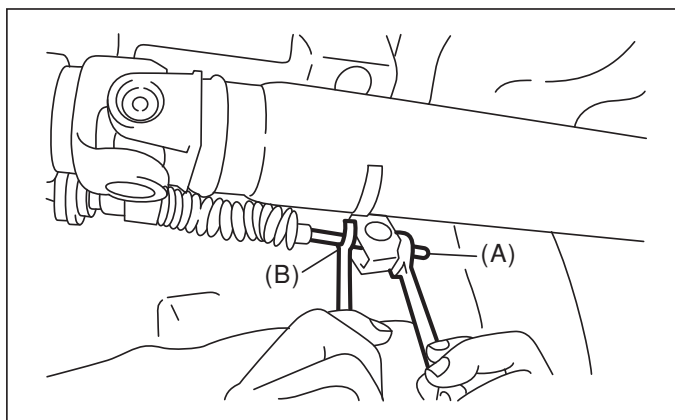

(A) Adjusting Nut A (B) Adjusting Nut B

- 4) After the completion of adjustment, confirm that the select lever operates normally at all ranges:
 - Move the select lever from “P” to “D” range. Check that the detents could be felt in each range. If the detents cannot be felt or the position pointer (dash indicator) is improperly aligned, re-adjust the cable.
 - Check if the starter motor rotates when the select lever is set to “P” range.
 - Check the back-up light illumination when the select lever is in “R” range.
 - Check the parking lock operation when the select lever is in “P” range.
- 5) Using the Subaru Select Monitor, clear the diagnostic trouble codes stored in memory. If the codes return after the correct adjustments, refer to the diagnostic procedure found in the applicable Subaru Service Manual.

WARRANTY/CLAIM INFORMATION

For vehicles within the Basic New Car Limited Warranty period, refer to the Subaru Warranty Wizard for claim submission information.

ATTENTION:GENERAL MANAGER
CLAIMS PERSONNELPARTS MANAGER
SERVICE MANAGER

IMPORTANT - All Service Personnel Should Read and Initial

Brought to you by Eris Studios
NOT FOR RESALE

SERVICE BULLETIN

APPLICABILITY: 1995MY and after Legacy
1998MY and after Forester
1993MY and after Impreza
2003MY and after Baja

NUMBER: 17-06-01R
DATE: 05/11/05

SUBJECT: Seat Belt Latch Slides to the Lower Seat Belt Anchor

DESCRIPTION

In the event you encounter a customer complaint of the seat belt latch sliding down the webbing to the lower seat belt anchor, it may be caused by the latch web stop button separating from the belt webbing. This stop button may become loose and fall off if the belt webbing is jammed between the body panel and door when the door is closed.

Use the chart below to locate and order the correct repair kit for your application.

Button Kit	Button Color
64780AC500EW	Beige (use with Beige Belt)
64780AC500VB	Black (use with Black Belt)

REPAIR PROCEDURES

- 1) Inspect the belt webbing for damage. If damaged replace the seat belt assembly.
- 2) Remove any piece of broken stopper button from the belt webbing.
- 3) Lift the belt latch up and beyond the original stopper button location and hold in place using adhesive tape.
- 4) Locate the original stopper hole (about 500mm up from bottom anchor) in the webbing and insert the new male stopper button from the backside of the belt. Push the other part of the button over the pin sticking through the front belt webbing.
- 5) Using a suitable tool, crimp the two parts together until the new button thickness is 4.5~5.0mm.
- 6) Remove the adhesive tape from the latch and confirm the stopper button holds the latch in the proper position.

continued...



CAUTION: VEHICLE SERVICING PERFORMED BY UNTRAINED PERSONS COULD RESULT IN SERIOUS INJURY TO THOSE PERSONS OR TO OTHERS.

Subaru Service Bulletins are intended for use by professional technicians ONLY. They are written to inform those technicians of conditions that may occur in some vehicles, or to provide information that could assist in the proper servicing of the vehicle. Properly trained technicians have the equipment, tools, safety instructions, and know-how to do the job correctly and safely. If a condition is described, DO NOT assume that this Service Bulletin applies to your vehicle, or that your vehicle will have that condition.

For vehicles within the Basic New Car Limited Warranty period, this repair can be claimed using:

Item Description/Fail Code	Operation Number	Labor Description	Flat Rate Time
Front seat belt stopper button YEF-01, 02, 05, 08	A913-722	Front seat belt stopper button R&R	One or Both sides 0.2

Brought to you by Eris Studios
NOT FOR RESALE

- ATTENTION:**
- GENERAL MANAGER
 - PARTS MANAGER
 - CLAIMS PERSONNEL
 - SERVICE MANAGER

IMPORTANT - All Service Personnel Should Read and Initial in the boxes provided, right.

QUALITY DRIVEN® SERVICE



SUBARU

SERVICE BULLETIN

APPLICABILITY: 2006~07MY Impreza

NUMBER: 17-13-07

SUBJECT: False DTC 26 – “Passenger’s Airbag Indicator Failure”

DATE: 10/15/07

INTRODUCTION

The purpose of this bulletin is to assist when diagnosing DTC 26. As indicated in the Service Manual, there are several conditions that can cause DTC 26 to be stored in memory. One of the items which should not be overlooked when diagnosing is the clock.

Even though the airbag system, including the Passenger Airbag ON/OFF status indicator light is functioning properly, a false DTC 26 code could be set in the following situation:

Since the passenger airbag status indicator is using Accessory power supply when the ignition is turned to the “START” position, power to the airbag ON/OFF status indicator shuts off during engine cranking. When the power supply to the airbag status indicator shuts off for more than 2 seconds, the Airbag Control Module diagnostic logic concludes that communication between the Airbag Control Module and the passenger airbag ON/OFF status indicator has failed. DTC 26 is incorrectly set and the malfunction indication lamp (MIL) for the airbag system is turned on.

To correct this misjudgment condition, the circuit logic in the clock has been modified so that power will be supplied to the passenger airbag status indicator during cranking.

COUNTERMEASURE

If diagnosis determines that there is no communications failure and DTC 26 was incorrectly set because of the cranking time situation above, the following procedure can be followed.

PART INFORMATION

PART DESCRIPTION	OLD PART NUMBER	NEW PART NUMBER
Auto Clock Assembly	85201FE000	85201FE001

CAUTION: VEHICLE SERVICING PERFORMED BY UNTRAINED PERSONS COULD RESULT IN SERIOUS INJURY TO THOSE PERSONS OR TO OTHERS.
 Subaru Service Bulletins are intended for use by professional technicians ONLY. They are written to inform those technicians of conditions that may occur in some vehicles, or to provide information that could assist in the proper servicing of the vehicle. Properly trained technicians have the equipment, tools, safety instructions, and know-how to do the job correctly and safely. If a condition is described, DO NOT assume that this Service Bulletin applies to your vehicle, or that your vehicle will have that condition.



REPAIR PROCEDURE/INFORMATION

Check the part number of the clock currently installed in the vehicle. If equipped with the old style, replace it with the new style.

- 1) Record radio stations.
- 2) Disconnect negative battery cable
- 3) Remove the clock by carefully lifting up on the clock cover and disengage the 2 front clips.

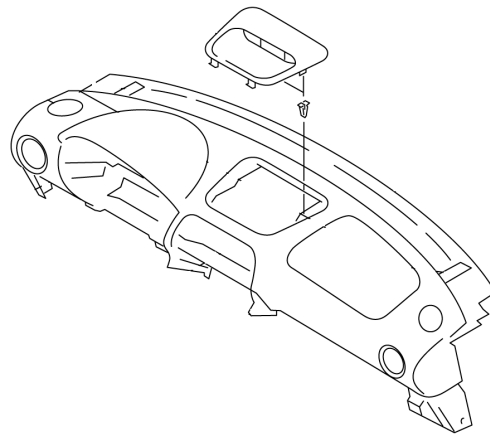

- 4) Disconnect the wiring harness and remove the 2 screws which secure the clock to the cover.

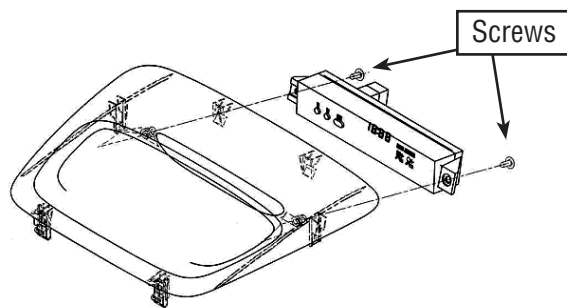

- 5) Install new clock in reverse order of removal.
- 6) Reconnect negative battery cable.
- 7) Reset radio stations and clock.
- 8) Confirm that the condition is corrected.

WARRANTY/CLAIM INFORMATION

For vehicles within the Basic New Car Limited Warranty period, refer to the Subaru Warranty Wizard for claim information.

ATTENTION:
GENERAL MANAGER
CLAIMS PERSONNEL

PARTS MANAGER
SERVICE MANAGER

IMPORTANT - All Service Personnel Should Read and Initial



SUBARU

Brought to you by Eris Studios
SALE

SERVICE BULLETIN

APPLICABILITY: 2007MY Legacy, B9 Tribeca, & Impreza Vehicles
SUBJECT: Service Manual Corrections

NUMBER: 18-112-06
DATE: 12/01/06

INTRODUCTION

The purpose of this bulletin is to provide a description of current changes to Service Manuals available via the Subaru Technical Information System (STIS) web site. The tables contained within this bulletin are to be used as guides for becoming aware of the latest changes. We advise you to always refer to the STIS web site when looking for the latest Service information. Printed pages will **not** be made available to update printed Service Manuals.

Paper manuals may have different page numbering then what is reflected below, based on multiple new and revised pages. Please refer to the information contained on the STIS web site for all future, updated service manual information.

YEAR	MODEL	BOOK/ VOL#	MSA#	SECTION	PAGE(S)	DESCRIPTION OF CHANGE
2007	B9 Tribeca	2	MSA5T0741A	Engine (H6DO)	EN(H6DO)(diag)-35	“LED OPERATION MODE OF ENGINE” and the content are deleted.
					EN(H6DO)(diag)-87, 89, 161, 164, 167, 180, 207, 240, 243, 257, 261, 263, 274-276, 278, 280, 286, 287, 292, 294, 296, 321, 334, 335, 337, 381, 382, 384, 387, 390, 392, 394, 396, 398, 401-403, 406	Part or all of the diagnostic steps for the following DTCs have been modified: P0026, 28, 122, 123, 126, 134, 154, 222, 223, 328, 333, 335, 420, 442, 447, 452, 456, 457, 458, 1443, 1602, 2101, 2102, 2103, 2122, 2123, 2127, 2128, 2135, 2138.
		3	MSA5T0742A	Transmission	5AT(diag)-67, 72, 77, 82	Diagnostic steps for the following DTCs have changed P0756, P0761, P0766, P0771
		4	MSA5T0743A	Chassis	PS-11 & 26	Special Tool numbers modified.
		5	MSA5T0744A	Body	SE-34	Power Seat initialization process modified.
		6	MSA5T0745A	Wiring System	WI-35	Engine schematic updated.
WI-85	Remote Engine Start schematic updated.					
WI-98	Clearance Light schematic updated.					



CAUTION: VEHICLE SERVICING PERFORMED BY UNTRAINED PERSONS COULD RESULT IN SERIOUS INJURY TO THOSE PERSONS OR TO OTHERS.

Subaru Service Bulletins are intended for use by professional technicians ONLY. They are written to inform those technicians of conditions that may occur in some vehicles, or to provide information that could assist in the proper servicing of the vehicle. Properly trained technicians have the equipment, tools, safety instructions, and know-how to do the job correctly and safely. If a condition is described, DO NOT assume that this Service Bulletin applies to your vehicle, or that your vehicle will have that condition.



YEAR	MODEL	BOOK/ VOL#	MSA#	SECTION	PAGE(S)	DESCRIPTION OF CHANGE
2007	Legacy	1	MSA5T0700A	General Information	SPC-4 & 11	Tire specifications modified.
		2	MSA5T0701A	Engine (H4SO)	FU(H4SO)-3-4	Illustration and torque spec modified.
					FU(H4SO)-16	Disassembly and assembly steps added.
					EN(H4SO)(diag)-42	"LED OPERATION MODE OF ENGINE" and the content are deleted.
					EN(H4SO)(diag)-88, 90, 96, 100, 134, 137, 146, 157, 173, 195-197, 200, 202, 204, 213, 216, 218, 220, 228, 233, 236, 248, 250, 252, 260, 262, 273-274, 289, 291, 293, 295, 299, 303, 305, 308	Part or all of the diagnostic steps for the following DTCs have been modified: P0026, 28, 32, 38, 0123, 126, 134, 172, 223, 420, 442, 447, 448, 456, 457, 458, 459, 512, 607, 851(MT&AT), 852(MT&AT), 1400, 1420, 1443, 1499, 1518, 1602, 2101, 2102, 2103, 2123, 2128, 2135, 2138.
		3	MSA5T0702A	Engine (H4DOTC)	EN(H4DOTC)(diag)-43	"LED OPERATION MODE OF ENGINE" and the content are deleted.
					EN(H4DOTC)(diag)-37	TGV refernce values modified.
					EN(H4DOTC)(diag)-98, 102, 128, 131, 139, 151, 161, 168, 170, 180, 186, 188, 192, 195, 201, 207, 212-214, 215, 218, 220, 222, 231, 234, 236, 238, 246, 251, 254, 256, 262, 270, 272, 276, 286, 287, 329, 332, 334, 336, 340, 344, 346, 349, 351, 353, 366, 367, 371, 372	Part or all of the diagnostic steps for the following DTCs have been modified: P0032, 38, 123, 126, 134, 172, 223, 245, 246, 328, 340, 345, 410, 411, 414, 417, 420, 441, 442, 447, 448, 456, 457, 458, 459, 512, 607, 851, 852, 1400, 1420, 1443, 1518, 1602, 2101, 2102, 2103, 2123, 2128, 2135, 2138, 2419, 2420, 2440, 2442.
		4	MSA5T0703A	Engine (H6DO)	EN(H6DO)(diag)-17,19	ECM Input Output information added.
					EN(H6DO)(diag)-41	"LED OPERATION MODE OF ENGINE" and the content are deleted.
					EN(H6DO)(diag)-93, 95, 101, 105, 111, 115, 149, 152, 160, 177, 188, 204, 218, 222, 228, 230, 232-234, 237, 239, 241, 250, 253, 255, 257, 266, 271, 282, 284, 286, 288, 298, 299, 322-324, 326, 328, 332, 336, 338, 341.	Part or all of the diagnostic steps for the following DTCs have been modified: P0026, 28, 32, 38, 52, 58, 0123, 126, 134, 154, 175, 223, 328, 333, 340, 345, 420, 442, 447, 448, 456-459, 512, 607, 1400, 1420, 1443, 1518, 1602, 2101, 2102, 2103, 2123, 2128, 2135, 2138
		6	MSA5T0705A	Chassis	WT-2	Tire and Wheel specifications modified.
		7	MSA5T0706A	Body	SE-37	Power Seat initialization process modified.

YEAR	MODEL	BOOK/ VOL#	MSA#	SECTION	PAGE(S)	DESCRIPTION OF CHANGE
2007	Impreza		MSA5T0713A	Engine (STI)	EN(STI)(diag)-34	TGV refernce values modified.
					GD(STI)-117-120	Detecting Criteria for DTC P0410 are modified.

Brought to you by Eris Studios
NOT FOR RESALE

ATTENTION:

- GENERAL MANAGER
- PARTS MANAGER
- CLAIMS PERSONNEL
- SERVICE MANAGER

IMPORTANT - All Service Personnel Should Read and Initial in the boxes provided, right.



SUBARU

QUALITY DRIVEN® SERVICE

SERVICE BULLETIN

APPLICABILITY: 2007 Impreza, Legacy, and B9 Tribeca;
2006 Legacy, B9 Tribeca;
2005 Forester, Baja, Legacy

NUMBER: 18-115-07
DATE: 03/16/07

SUBJECT: Service Manual Corrections

INTRODUCTION

The purpose of this bulletin is to provide a description of current changes to Service Manuals available via the Subaru Technical Information System (STIS) web site. The tables contained within this bulletin are to be used as guides for becoming aware of the latest changes. We advise you to always refer to the STIS web site when looking for the latest Service information. Printed pages will **not** be made available to update printed Service Manuals.

Paper manuals may have different page numbering then what is reflected below, based on multiple new and revised pages. Please refer to the information contained on the STIS web site for all future, updated service manual information.

YEAR	MODEL	BOOK/VOL#	MSA#	SECTION	PAGE(S)	DESCRIPTION OF CHANGE
2007	Impreza	8	MSA5T0717A	Wiring System	WI-90	Illustration ABS-02 changed.
					WI-188, 189	Bulk head harness illustration and connector chart changed.
	Legacy	5	MSA5T0704A	Transmission	5AT-10	Page added for new illustration of Short AT Assembly.
					5AT-94,95	5AT Main Case steps added.
	B9 Tribeca	1	MSA5T0740A	General Information	PM-3	A/C filter change interval corrected.
					3	MSA5T0742A
				5AT-96,97		
2006	Legacy	5	MSA5T0604A	Transmission	5AT-9	Page added for new illustration of Short AT Assembly.
					5AT-95, 96	5AT Main Case steps added.
		7	MSA5T0606A	Body	LAN (diag)-61-64	Illustration and steps modified for DTC B0221.
	B9 Tribeca	3	MSA5T0642A	Transmission	5AT-9	Page added for new illustration of Short AT Assembly.
					5AT-94, 95	5AT Main Case steps added.

YEAR	MODEL	BOOK/ VOL#	MSA#	SECTION	PAGE(S)	DESCRIPTION OF CHANGE
2005	Forester	2	MSA5T0521A	Engine (H4SO)	GD(H4SO)-96, 98, 100, 102	Component Description illustration changed for DTCs P0335, 0336, 0340, 0341
		7	MSA5T0526A	Wiring System	WI-164, 166	Bulk head harness illustration and connector chart changed.
	Baja	1	MSA5T0531A	General Information	PM-4, 5	A/C filter change interval corrected.
	Legacy	6	MSA5T0505A	Transmission	5AT-9	New illustration is added for 5AT Short AT Assembly.
					5AT-96, 97	5AT Main Case steps added.
		8	MSA5T0507A	Body	LAN(diag)-28	New DTC (B0105) added to DTC chart.
					LAN(diag)-42-43	Diagnostic procedure added for new DTC B0105.
					LAN(diag)-68-75	The diagnosis procedures and illustrations of DTC B0300 to B0302 are changed.

Brought to you by Eris Studios
NOT FOR RESALE

ATTENTION:

- GENERAL MANAGER
- PARTS MANAGER
- CLAIMS PERSONNEL
- SERVICE MANAGER

IMPORTANT - All Service Personnel Should Read and Initial in the boxes provided, right.



SUBARU

QUALITY DRIVEN® SERVICE

SERVICE BULLETIN

APPLICABILITY: 2007 B9 Tribeca, Legacy, Forester, and Impreza
SUBJECT: Service Manual Corrections

NUMBER: 18-118-07
DATE: 04/19/07

INTRODUCTION

The purpose of this bulletin is to provide a description of current changes to Service Manuals available via the Subaru Technical Information System (STIS) web site. The tables contained within this bulletin are to be used as guides for becoming aware of the latest changes. We advise you to always refer to the STIS web site when looking for the latest Service information. Printed pages will **not** be made available to update printed Service Manuals.

Paper manuals may have different page numbering then what is reflected below, based on multiple new and revised pages. Please refer to the information contained on the STIS web site for all future, updated service manual information.

YEAR	MODEL	BOOK/VOL#	MSA#	SECTION	PAGE(S)	DESCRIPTION OF CHANGE
2007	Forester	1	MSA5T0720A	General Information	PM - 19	Illustration updated
		2	MSA5T0721A	Engine (H4SO)	FU(H4SO)-44	Procedure for Releasing Fuel Pressure changed
					FU(H4SO)-52	Fuel Pump Removal procedure changed
					EN(H4SO)(diag)-272	Diagnostic step 2 has changed for DTC P1443
		3	MSA5T0722A	Engine (H4DOTC)	FU(H4DOTC)-49	Procedure for Releasing Fuel Pressure changed
					FU(H4DOTC)-57	Fuel Pump Removal procedure changed
					EN(H4DOTC)(diag)-293	Diagnostic step 2 has changed for DTC P1443
		6	MSA5T0725A	Body	SB - 7	Connector used for testing in step 2 is corrected
		7	MSA5T0726A	Wiring System	WI - 20 & 21	Additions and changes for FB-8 & FB-31
					WI-86	Update wiring diagram
WI-148-165	Additional wiring diagrams added for Keyless Entry and Security System					

YEAR	MODEL	BOOK/ VOL#	MSA#	SECTION	PAGE(S)	DESCRIPTION OF CHANGE
2007	Legacy	2	MSA5T0701A	Engine (H4SO)	EN(H4SO)(diag)-252	Diagnostic step 2 has changed for DTC P1443
					EN(H4DOTC)(diag)-81,82	Changed reference information for DTCs P0016, 0018, 0140
						EN(H4DOTC)(diag)-226,228
		3	MSA5T0702A	Engine (H4DOTC)	EN(H4DOTC)(diag)-272	Diagnostic step 2 has changed for DTC P1443
					EN(H6DO)(diag)-245,247	Changed diagnostic steps for DTCs P0452 & P0453
		4	MSA5T0703A	Engine (H6DO)	EN(H6DO)(diag)-286	Diagnostic step 2 has changed for DTC P1443
					5	MSA5T0704A
		6	MSA5T0705A	Chassis	FS - 2	Front & Rear Toe-in Specifications changed
					FS - 12	Rear Toe-in specification added
7	MSA5T0706A	Body	WW - 16	Rear Wiper Motor testing corrected		
2007	Impreza	2	MSA5T0711A	Engine (H4SO)	FU(H4SO)-43	Procedure for Releasing Fuel Pressure changed
					FU(H4SO)-51	Fuel Pump Removal procedure changed
					EN(H4SO)(diag)-257	Diagnostic step 2 has changed for DTC P1443
		3	MSA5T0712A	Engine (H4DOTC)	FU(H4DOTC)-55	Procedure for Releasing Fuel Pressure changed
					FU(H4DOTC)-63	Fuel Pump Removal procedure changed
					EN(H4DOTC)(diag)-282	Diagnostic step 2 has changed for DTC P1444
4	MSA5T0713A	Engine (Sti)	EN(STI)(diag)-273	Diagnostic step 2 has changed for DTC P1445		
2007	B9 Tribeca	2	MSA5T0741A	Engine (H4DO)	EN(H6DO)(diag)-321	Diagnostic step 2 has changed for DTC P1443
		4	MSA5T073A	Chassis	FS-2	Rear Toe-in specification corrected
		5	MSA5T0744A	Body	SL-35	Door Latch Removal steps corrected/changed
		6	MSA5T0745A	Wiring System	WI-123	Wiring diagram changed

Brought to you by Eris Studios
NOT FOR RESALE

ATTENTION:

- GENERAL MANAGER
- PARTS MANAGER
- CLAIMS PERSONNEL
- SERVICE MANAGER

IMPORTANT - All Service Personnel Should Read and Initial in the boxes provided, right.



SUBARU

QUALITY DRIVEN® SERVICE

SERVICE BULLETIN

APPLICABILITY: 2007 B9 Tribeca, Legacy, Forester, and Impreza
SUBJECT: Service Manual Corrections

NUMBER: 18-119-07
DATE: 10/11/07

INTRODUCTION

The purpose of this bulletin is to provide a description of current changes to Service Manuals available via the Subaru Technical Information System (STIS) web site. The tables contained within this bulletin are to be used as guides for becoming aware of the latest changes. We advise you to always refer to the STIS web site when looking for the latest Service information. Printed pages will **not** be made available to update printed Service Manuals.

Paper manuals may have different page numbering then what is reflected below, based on multiple new and revised pages. Please refer to the information contained on the STIS web site for all future, updated service manual information.

YEAR	MODEL	MSA#	SECTION	PAGE(S)	DESCRIPTION OF CHANGE
2007	B9 Tribeca	MSA5T0741A	Engine (H6DO)	FU(H6DO) - 11	Tool Chart updated
				FU(H6DO) - 38, 39	Fuel Draining process updated
				FU(H6DO) - 48	Steps updated for A. Removal
				EN(H6DO)(diag) - 32, 33	OBD Read Current Data Chart updated
				EN(H6DO)(diag) - 380, 387	Diagnostic steps update for DTCs P2101 and P2102.
		MSA5T0743A	Chassis	BVC(diag) - 15, 17, 20, 23, 26, 28	Diagrams updated
MSA5T0744A	Body	SE - 20	Seat Heater Diag. information added		
2007	Legacy	MSA5T0700A	General Information	RM - 4	Fluid Chart updated
		MSA5T0701A	Engine (H4SO)	FU(H4SO) - 10	Tool Chart updated
				FU(H4SO) - 39, 40	Fuel Draining process updated
				FU(H4SO) - 50, 53	Steps updated for A. Removal
		MSA5T0702A	Engine (H4DOTC)	FU(H4DOTC) - 10, 11	Tool Chart updated
				FU(H4DOTC) - 49, 50	Fuel Draining process updated
				FU(H4DOTC) - 60, 63	Steps updated for A. Removal
EN(H4DOTC)(diag) - 39	OBD Read Current Data Chart updated				

YEAR	MODEL	MSA#	SECTION	PAGE(S)	DESCRIPTION OF CHANGE
2007	Legacy	MSA5T0703A	Engine (H6DO)	ME(H6DO) - 3, 57, 67	Cylinder Head Specifications updated
				FU(H6DO) - 11	Tool Chart updated
				FU(H6DO) - 38, 39	Fuel Draining process updated
				FU(H6DO) - 49, 51, 52	Steps updated for A. Removal
		MSA5T0704A	Transmission	4AT - 3, 25, 42, 54	Fluid Charts updated
				5AT - 3, 28, 46	Fluid Charts updated
		MSA5T0705A	Chassis	DS - 18, 20	Torque Specifications added
				BR - 4	Illustration updated
				BR - 5, 16, 17, 18, 24	Torque Specifications updated
				BR - 16, 22	Rotor Resurface instead of replacement added
		MSA5T0706A	Body	SE - 22, 23	Seat Heater Diag. information added
				LAN(diag) - 45	Diagnostic steps updated for DTC B1106
		MSA5T0707A	Wiring System	WI - 91, 99, 182, 184, 222	Diagrams updated
				WI - 220	Connector locator chart updated
2007	Forester	MSA5T0720A	General Information	RM - 4	Fluid Chart updated
		MSA5T0721A	Engine (H4SO)	EN(H4SO)(diag) - 30	OBD Read Current Data Chart updated
				EN(H4SO)(diag) - 313, 315, 318, 331	Diagnostic steps update for DTC P2101, P2102 & P2135.
		MSA5T0722A	Engine (H4DOTC)	EN(H4DOTC)(diag) - 33	OBD Read Current Data Chart updated
				EN(H4DOTC)(diag) - 352, 354, 358, 371	Diagnostic steps update for DTCs P2101, P2102 & P2135.
		MSA5T0723A	Transmission	4AT - 3	Fluid Chart updated
				4AT - 28, 58	Fluid Charts updated
MSA5T0725A	Body	SE - 19	Seat Heater Diag. information added		
2007	Impreza	MSA5T0710A	General Information	RM - 3	Fluid Chart updated
		MSA5T0714A	Transmission	4AT - 3	Fluid Chart updated
		MSA5T0716A	Body	SE - 16	Seat Heater Diag. information added