

17.Crank Sprocket

A: REMOVAL

NOTE:

When replacing a single part, perform the work with the engine assembly installed to body.

- 1) Remove the chain cover. <Ref. to ME(H4DO)-92, REMOVAL, Chain Cover.>
- 2) Remove the timing chain. <Ref. to ME(H4DO)-108, REMOVAL, Timing Chain Assembly.>
- 3) Remove the crank sprocket.

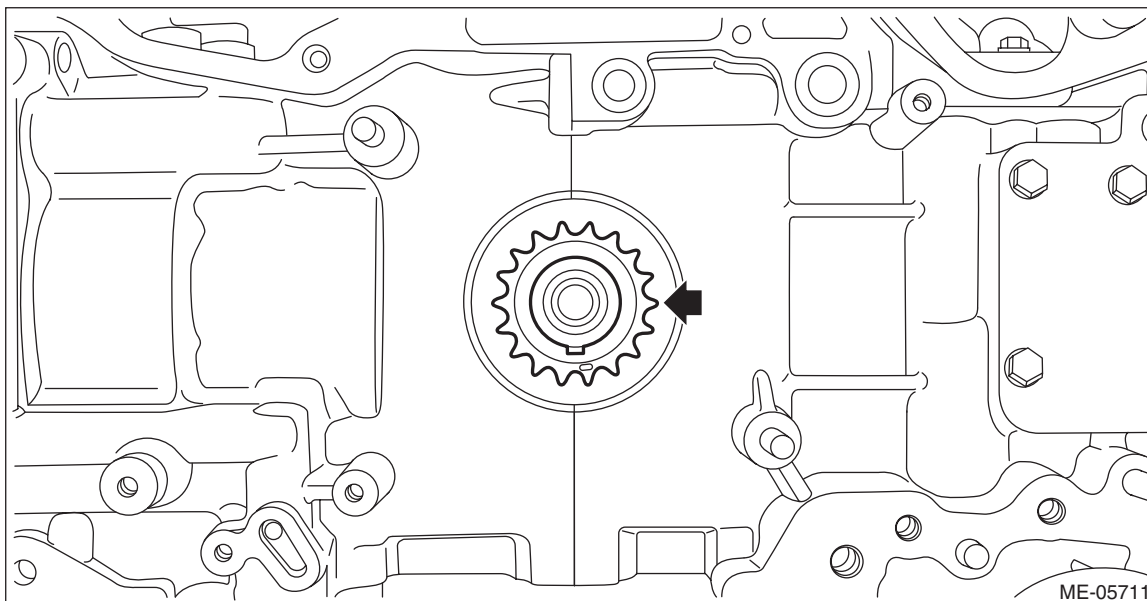

B: INSTALLATION

- 1) Install the crank sprocket.

NOTE:

The direction of installation is not specified for the crank sprocket.

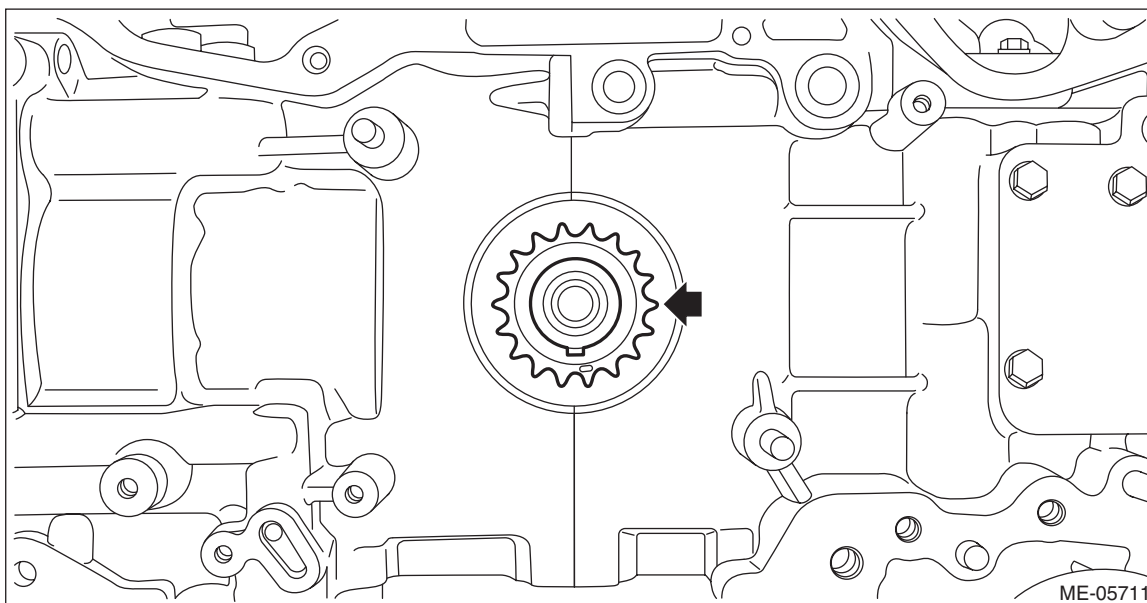

- 2) Install the timing chain. <Ref. to ME(H4DO)-116, INSTALLATION, Timing Chain Assembly.>
- 3) Install the chain cover. <Ref. to ME(H4DO)-97, INSTALLATION, Chain Cover.>

Crank Sprocket

MECHANICAL

C: INSPECTION

- 1) Check the crank sprocket teeth for abnormal wear and scratches.
- 2) Make sure there is no free play between crank sprocket and key.