

Diagnostic Procedure with Diagnostic Trouble Code (DTC)

HVAC SYSTEM (AUTO A/C) (DIAGNOSTICS)

13. Diagnostic Procedure with Diagnostic Trouble Code (DTC)

A: DTC B1430 ROOM TEMPERATURE SENSOR CIRCUIT WIRE BREAK

DTC DETECTING CONDITION:

In-vehicle sensor circuit is open.

TROUBLE SYMPTOM:

In-vehicle air temperature is falsely recognized as 25°C (77°F), and the compartment temperature is adjusted.

WIRING DIAGRAM:

Air Conditioning System <Ref. to WI-35, WIRING DIAGRAM, Air Conditioning System.>

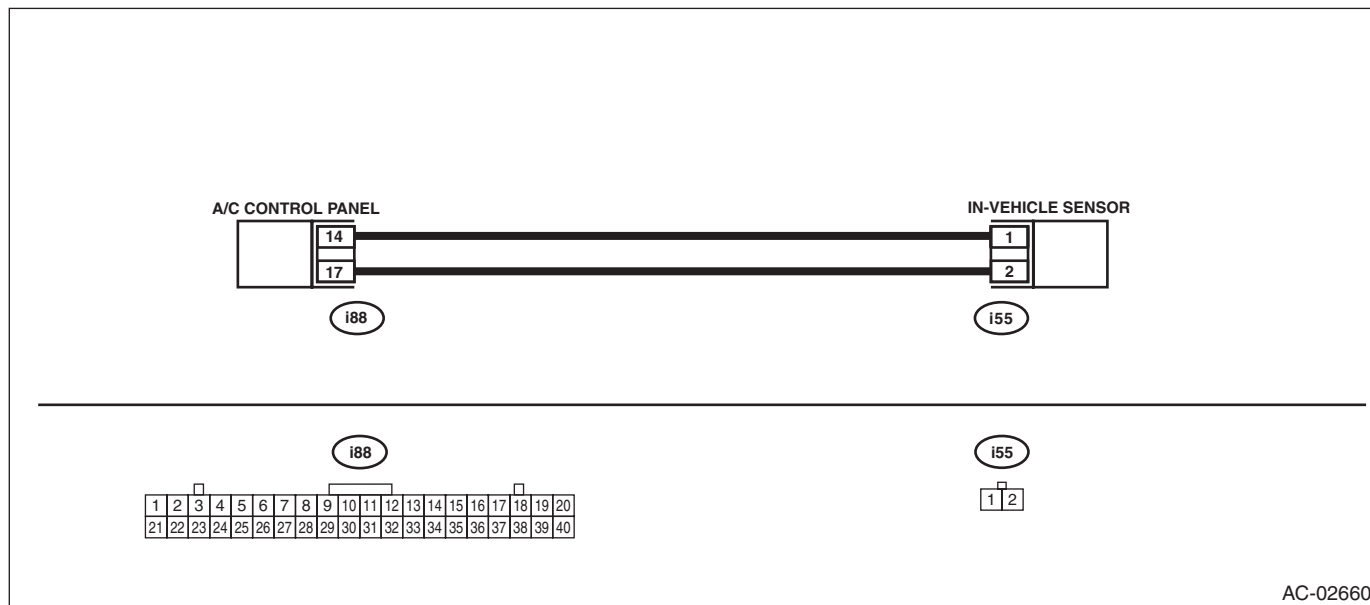

AC-02660

Step	Check	Yes	No
1 CHECK CONNECTOR. 1) Check the condition of connector connection. 2) Read the DTC using Subaru Select Monitor.	Is B1430 displayed?	Go to step 2.	Check the connection of the in-vehicle sensor circuit.
2 CHECK IN-VEHICLE SENSOR. 1) Disconnect the in-vehicle sensor. 2) Short the connector. 3) Read the DTC relating the ECM using the Subaru Select Monitor.	Is B1431 displayed?	Replace the in-vehicle sensor. <Ref. to AC-78, REMOVAL, In-Vehicle Sensor (Auto A/C Model).>	Go to step 3.
3 CHECK HARNESS. 1) Turn the ignition switch to ON. 2) Using the tester, measure the voltage between terminals. Connector & terminal (i55) No. 2 (+) — No. 1 (-):	Is the voltage 4.5 — 5.0 V?	Go to step 4.	Repair or replace the open circuit of harness.
4 CHECK HARNESS. 1) Disconnect the connector from the A/C control panel. 2) Using a tester, check continuity between terminals. Connector & terminal (i55) No. 1 — (i88) No. 14: (i55) No. 2 — (i88) No. 17:	Is there continuity?	Replace the A/C control panel. <Ref. to AC-47, REMOVAL, Control Panel.>	Repair or replace the open circuit of harness.

Diagnostic Procedure with Diagnostic Trouble Code (DTC)

HVAC SYSTEM (AUTO A/C) (DIAGNOSTICS)

B: DTC B1431 ROOM TEMPERATURE SENSOR CIRCUIT SHORT-CIRCUIT

DTC DETECTING CONDITION:

In-vehicle sensor circuit is shorted.

TROUBLE SYMPTOM:

In-vehicle air temperature is falsely recognized as 25°C (77°F), and the compartment temperature is adjusted.

WIRING DIAGRAM:

Air Conditioning System <Ref. to WI-35, WIRING DIAGRAM, Air Conditioning System.>

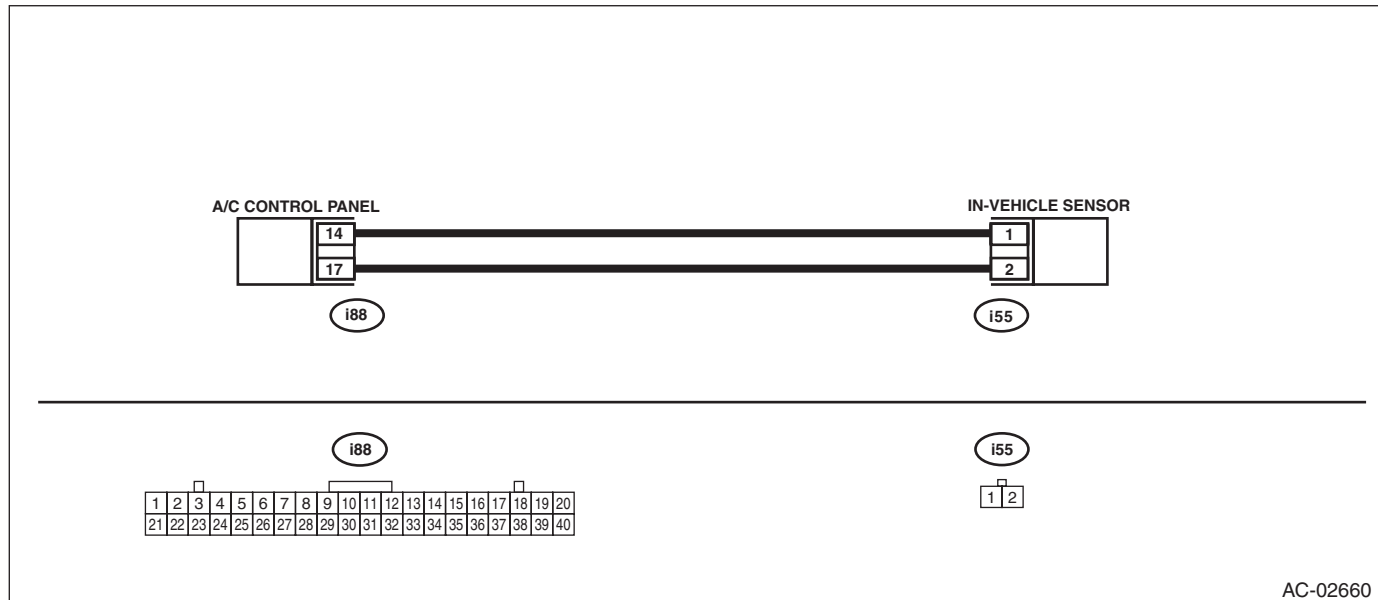

AC-02660

Step	Check	Yes	No
1 CHECK CONNECTOR. 1) Check the condition of connector connection. 2) Read the DTC using Subaru Select Monitor.	Is B1431 displayed?	Go to step 2.	Check the connection of the in-vehicle sensor circuit.
2 CHECK IN-VEHICLE SENSOR. 1) Disconnect the in-vehicle sensor. <Ref. to AC-78, REMOVAL, In-Vehicle Sensor (Auto A/C Model).> 2) Read the DTC using Subaru Select Monitor.	Is B1430 displayed?	Replace the in-vehicle sensor. <Ref. to AC-78, REMOVAL, In-Vehicle Sensor (Auto A/C Model).>	Go to step 3.
3 CHECK HARNESS. 1) Turn the ignition switch to ON. 2) Using the tester, measure the voltage between terminals. Connector & terminal <i>(i55) No. 2 (+) — No. 1 (-):</i>	Is the voltage 4.5 — 5.0 V?	Check the connection of the in-vehicle sensor circuit.	Go to step 4.
4 CHECK HARNESS. 1) Disconnect the connector from the A/C control panel. 2) Using a tester, check continuity between terminals. Connector & terminal <i>(i55) No. 1 — No. 2:</i>	Is there continuity?	Repair or replace the short circuit of the harness.	Replace the A/C control panel. <Ref. to AC-47, REMOVAL, Control Panel.>

Diagnostic Procedure with Diagnostic Trouble Code (DTC)

HVAC SYSTEM (AUTO A/C) (DIAGNOSTICS)

C: DTC B1432 OUTSIDE AIR SENSOR CIRCUIT WIRE BREAK (AIR-CONDITIONING)

DTC DETECTING CONDITION:

Ambient sensor circuit is open.

TROUBLE SYMPTOM:

Ambient temperature is falsely recognized, and the compartment temperature is adjusted.

WIRING DIAGRAM:

Air Conditioning System <Ref. to WI-35, WIRING DIAGRAM, Air Conditioning System.>

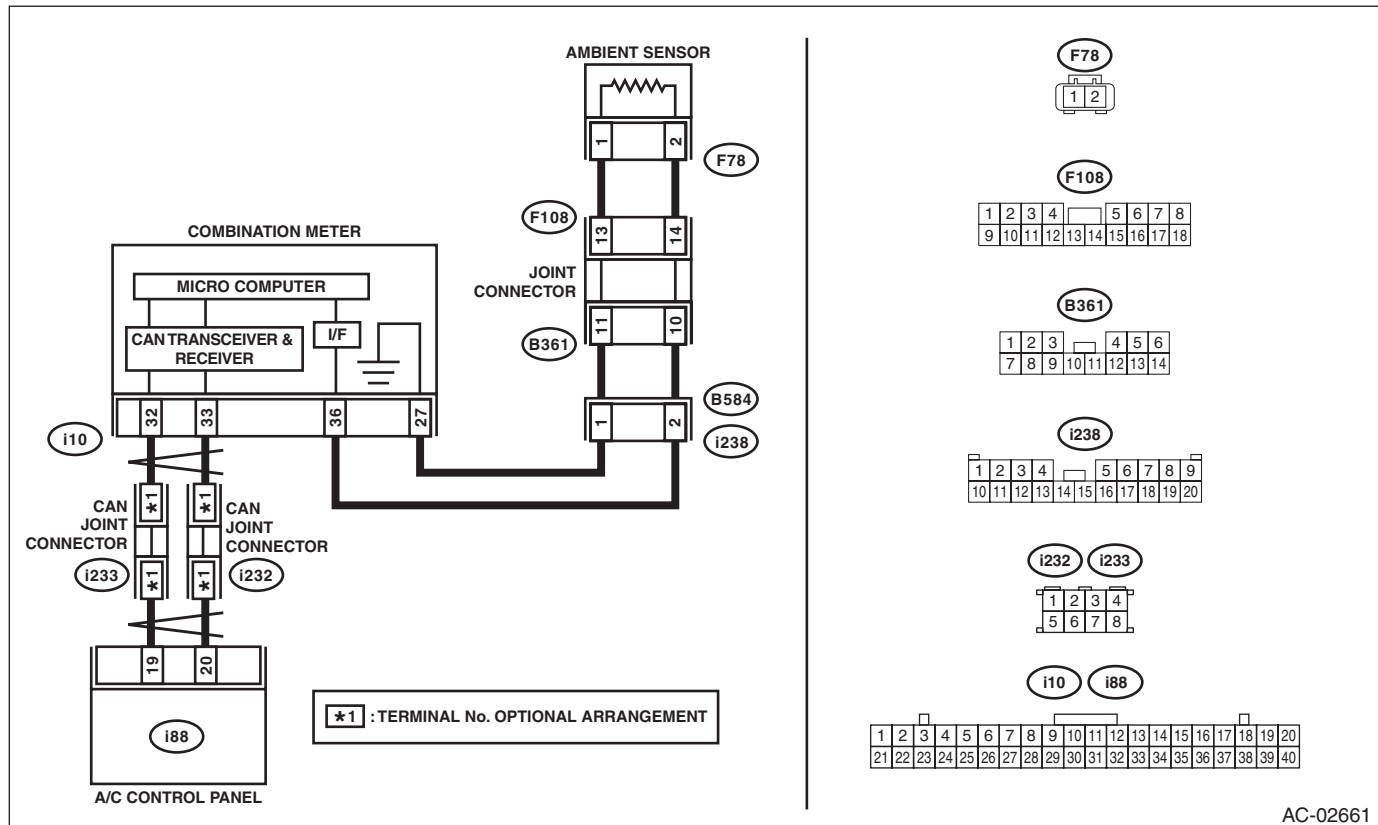

Step	Check	Yes	No
1 CHECK AMBIENT SENSOR. Perform the inspection of ambient sensor unit. <Ref. to AC-75, INSPECTION, Ambient Sensor.>	Is the sensor normal?	Go to step 2.	Replace the ambient sensor. <Ref. to AC-73, REMOVAL, Ambient Sensor.>
2 CHECK HARNESS. 1) Turn the ignition switch to ON. 2) Using the tester, measure the voltage between terminals. Connector & terminal (F78) No. 2 (+) — No. 1 (-):	Is the voltage 4.5 — 5.0 V?	Replace the combination meter. <Ref. to IDI-17, REMOVAL, Combination Meter.>	Go to step 3.
3 CHECK COMBINATION METER OUTPUT SIGNAL. 1) Turn the ignition switch to OFF. 2) Pull out the combination meter. 3) Disconnect the connector from the combination meter. 4) Turn the ignition switch to ON. 5) Measure the voltage between the combination meter connector terminals. Connector & terminal (i10) No. 36 (+) — No. 27 (-):	Is the voltage 4.5 — 5.0 V?	Go to step 4.	Replace the combination meter. <Ref. to IDI-17, REMOVAL, Combination Meter.>

Diagnostic Procedure with Diagnostic Trouble Code (DTC)

HVAC SYSTEM (AUTO A/C) (DIAGNOSTICS)

Step	Check	Yes	No
4 CHECK HARNESS. 1) Disconnect the connector from the A/C control panel. 2) Using a tester, check continuity between terminals. Connector & terminal (F78) No. 1 — (i10) No. 27: (F78) No. 2 — (i10) No. 36:	Is there continuity?	Go to step 5.	Repair or replace the open circuit of harness.
5 CHECK FOR POOR CONTACT. Check for poor contact of combination meter connector.	Is there poor contact of connector?	Repair the connector.	Replace the combination meter. <Ref. to IDI-17, REMOVAL, Combination Meter.>

Diagnostic Procedure with Diagnostic Trouble Code (DTC)

HVAC SYSTEM (AUTO A/C) (DIAGNOSTICS)

D: DTC B1433 OUTSIDE AIR SENSOR CIRCUIT SHORT-CIRCUIT (AIR-CONDITIONING)

DTC DETECTING CONDITION:

Ambient sensor circuit is shorted.

TROUBLE SYMPTOM:

Ambient temperature is falsely recognized, and the compartment temperature is adjusted.

WIRING DIAGRAM:

Air Conditioning System <Ref. to WI-35, WIRING DIAGRAM, Air Conditioning System.>

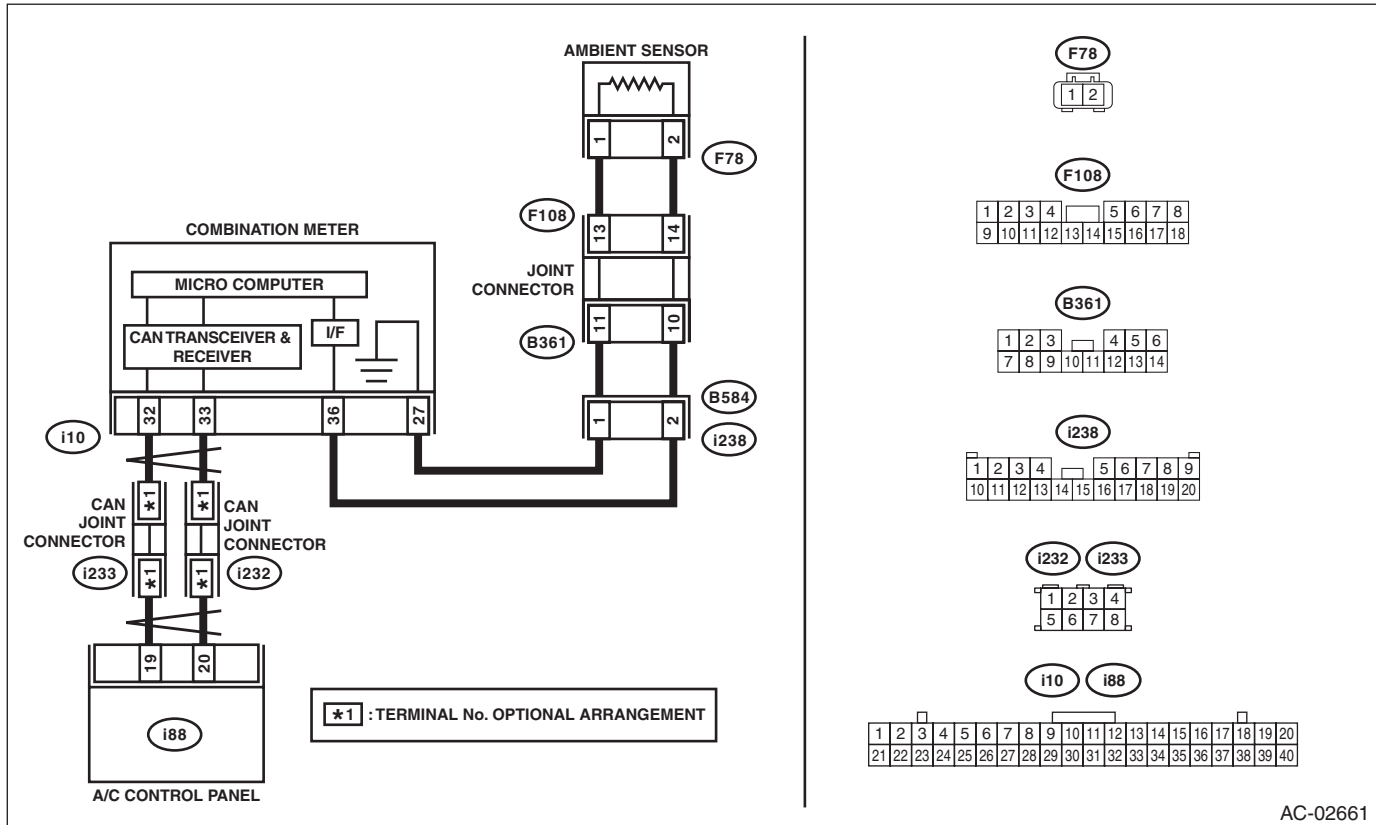

Step	Check	Yes	No
1 CHECK AMBIENT SENSOR. Perform the inspection of ambient sensor unit. <Ref. to AC-75, INSPECTION, Ambient Sensor.>	Is the sensor normal?	Go to step 2.	Replace the ambient sensor. <Ref. to AC-73, REMOVAL, Ambient Sensor.>
2 CHECK HARNESS. 1) Turn the ignition switch to ON. 2) Using the tester, measure the voltage between terminals. <i>Connector & terminal</i> (F78) No. 2 (+) — No. 1 (-):	Is the voltage 4.5 — 5.0 V?	Replace the combination meter. <Ref. to IDI-17, REMOVAL, Combination Meter.>	Go to step 3.
3 CHECK COMBINATION METER OUTPUT SIGNAL. 1) Turn the ignition switch to OFF. 2) Pull out the combination meter. 3) Disconnect the connector from the combination meter. 4) Turn the ignition switch to ON. 5) Measure the voltage between the combination meter connector terminals. <i>Connector & terminal</i> (i10) No. 36 (+) — No. 27 (-):	Is the voltage 4.5 — 5.0 V?	Go to step 4.	Replace the combination meter. <Ref. to IDI-17, REMOVAL, Combination Meter.>

Diagnostic Procedure with Diagnostic Trouble Code (DTC)

HVAC SYSTEM (AUTO A/C) (DIAGNOSTICS)

	Step	Check	Yes	No
4	CHECK HARNESS. 1) Disconnect the connector from the A/C control panel. 2) Using a tester, check continuity between terminals. Connector & terminal (F78) No. 1 — (F78) No. 2:	Is there continuity?	Repair or replace the short circuit of the harness.	Replace the combination meter. <Ref. to IDI-17, REMOVAL, Combination Meter.>

Diagnostic Procedure with Diagnostic Trouble Code (DTC)

HVAC SYSTEM (AUTO A/C) (DIAGNOSTICS)

E: DTC B1434 AMBIENT TEMPERATURE SENSOR CIRCUIT WIRE BREAK

DTC DETECTING CONDITION:

Evaporator sensor circuit is open.

TROUBLE SYMPTOM:

Evaporator temperature is falsely recognized as low, and the compartment temperature is adjusted.

WIRING DIAGRAM:

Air Conditioning System <Ref. to WI-35, WIRING DIAGRAM, Air Conditioning System.>

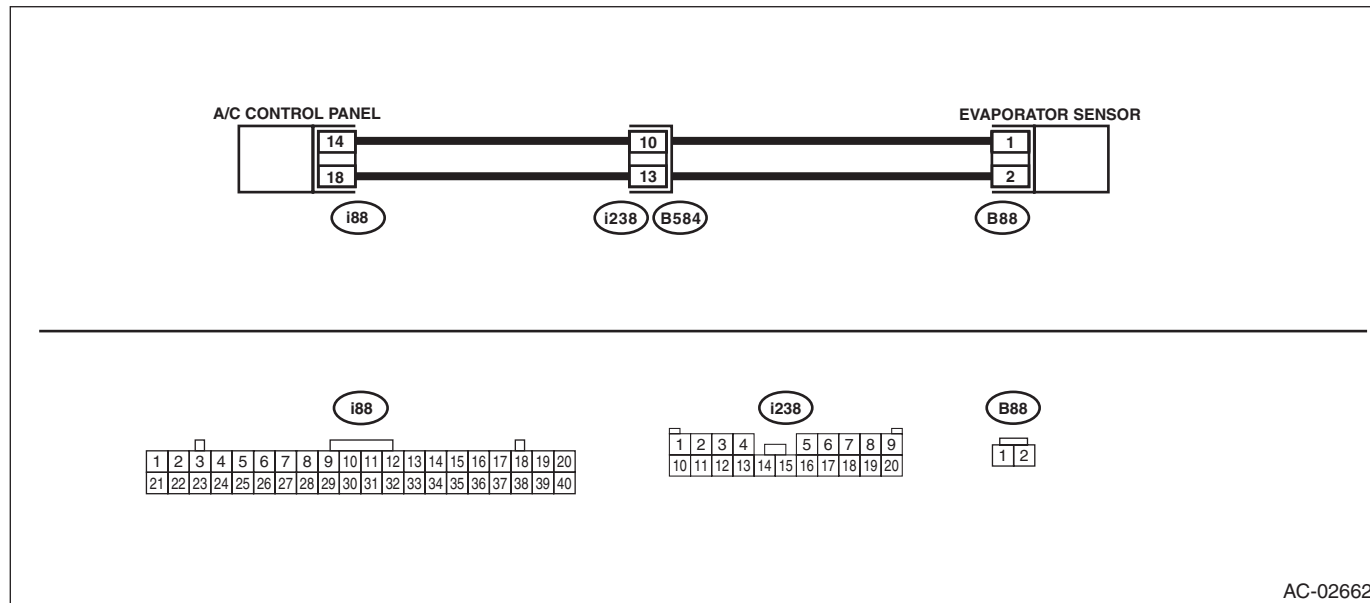

AC-02662

Step	Check	Yes	No
1 CHECK CONNECTOR. 1) Check the condition of connector connection. 2) Read the DTC using Subaru Select Monitor.	Is B1434 displayed?	Go to step 2.	Check the connection of the evaporator sensor circuit.
2 CHECK EVAPORATOR SENSOR. 1) Disconnect the evaporator sensor. 2) Short the evaporator sensor connector (B88). 3) Read the DTC using Subaru Select Monitor.	Is B1435 displayed?	Replace the evaporator sensor. <Ref. to AC-63, REMOVAL, Evaporator.>	Go to step 3.
3 CHECK HARNESS. 1) Turn the ignition switch to ON. 2) Using the tester, measure the voltage between terminals. Connector & terminal (B88) No. 2 (+) — No. 1 (-):	Is the voltage 4.5 — 5.0 V?	Go to step 4.	Repair or replace the open circuit of harness.
4 CHECK HARNESS. 1) Disconnect the connector from the A/C control panel. 2) Using a tester, check continuity between terminals. Connector & terminal (B88) No. 1 — (i88) No. 18: (B88) No. 2 — (i88) No. 14:	Is there continuity?	Replace the A/C control panel. <Ref. to AC-47, REMOVAL, Control Panel.>	Repair or replace the open circuit of harness.

Diagnostic Procedure with Diagnostic Trouble Code (DTC)

HVAC SYSTEM (AUTO A/C) (DIAGNOSTICS)

F: DTC B1435 EVAPORATOR SENSOR CIRCUIT SHORT-CIRCUIT

DTC DETECTING CONDITION:

Evaporator sensor circuit is shorted.

TROUBLE SYMPTOM:

Evaporator temperature is falsely recognized as high, and the compartment temperature is adjusted.

WIRING DIAGRAM:

Air Conditioning System <Ref. to WI-35, WIRING DIAGRAM, Air Conditioning System.>

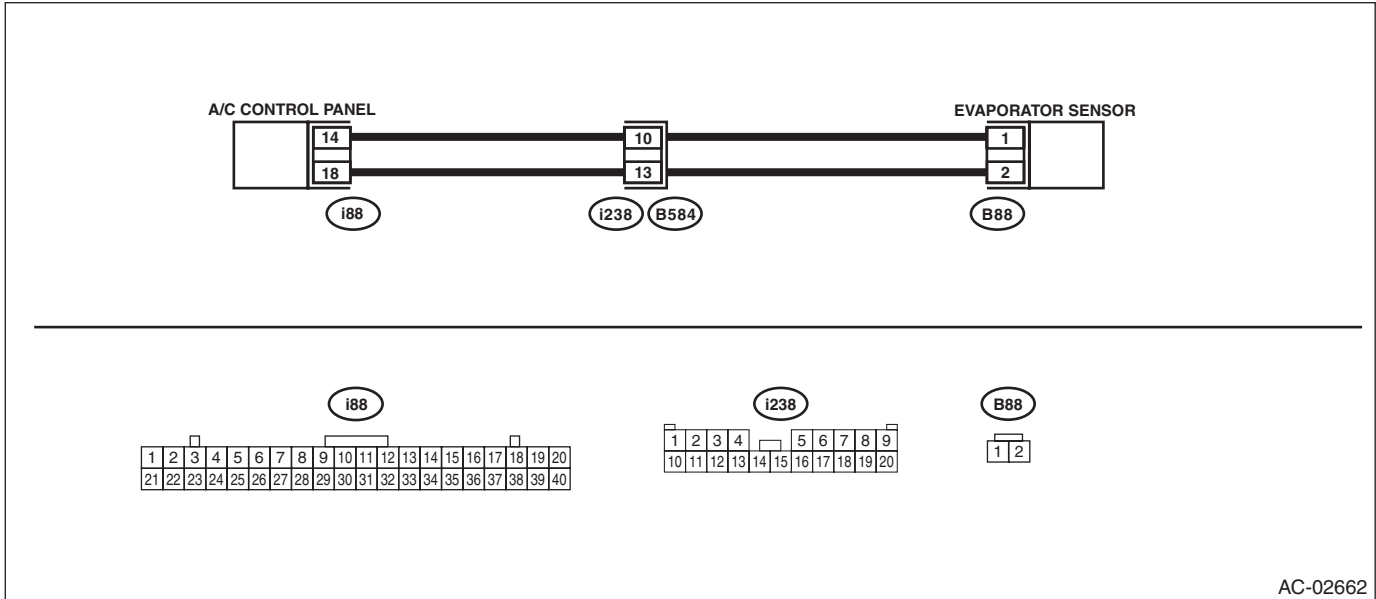

AC-02662

Step	Check	Yes	No
1 CHECK CONNECTOR. 1) Check the condition of connector connection. 2) Read the DTC using Subaru Select Monitor.	Is B1435 displayed?	Go to step 2.	Check the connection of the evaporator sensor circuit.
2 CHECK EVAPORATOR SENSOR. 1) Disconnect the evaporator sensor. 2) Read the DTC using Subaru Select Monitor.	Is B1434 displayed?	Replace the evaporator sensor. <Ref. to AC-63, REMOVAL, Evaporator.>	Go to step 3.
3 CHECK HARNESS. 1) Turn the ignition switch to ON. 2) Using the tester, measure the voltage between terminals. Connector & terminal (B88) No. 2 (+) — No. 1 (-):	Is the voltage 4.5 — 5.0 V?	Check the connection of the evaporator sensor circuit.	Go to step 4.
4 CHECK HARNESS. 1) Disconnect the connector from the A/C control panel. 2) Using a tester, check continuity between terminals. Connector & terminal (B88) No. 1 — No. 2:	Is there continuity?	Repair or replace the short circuit of the harness.	Replace the A/C control panel. <Ref. to AC-47, REMOVAL, Control Panel.>

Diagnostic Procedure with Diagnostic Trouble Code (DTC)

HVAC SYSTEM (AUTO A/C) (DIAGNOSTICS)

G: DTC B14A1 SUNLOAD SENSOR CIRCUIT OPEN

DTC DETECTING CONDITION:

Sunload sensor circuit is open. (Displayed for current malfunction)

NOTE:

When the sunload sensor check is performed indoors or in the shade, it could be diagnosed as having an open circuit. Always check the sunload sensor in direct sunlight.

TROUBLE SYMPTOM:

Operation is performed as no sunload.

WIRING DIAGRAM:

Air Conditioning System <Ref. to WI-35, WIRING DIAGRAM, Air Conditioning System.>

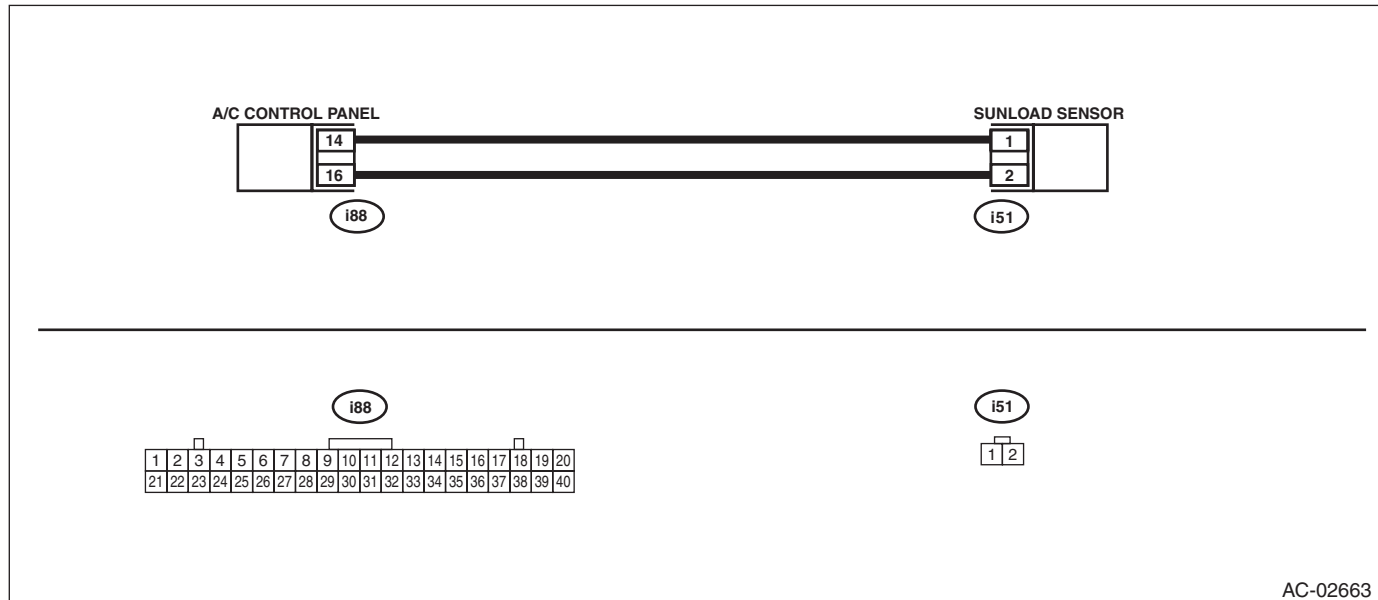

AC-02663

Step	Check	Yes	No
1 CHECK CONNECTOR. 1) Check the condition of connector connection. 2) Read the DTC using Subaru Select Monitor.	Is B14A1 displayed?	Go to step 2.	Check the connection of the sunload sensor circuit.
2 CHECK SUNLOAD SENSOR. 1) Disconnect the sunload sensor. 2) Short the connector. 3) Read the DTC using Subaru Select Monitor.	Is B14A2 displayed?	Replace the sunload sensor. <Ref. to AC-76, REMOVAL, Sunload Sensor (Auto A/C Model).>	Go to step 3.
3 CHECK HARNESS. 1) Turn the ignition switch to ON. 2) Using the tester, measure the voltage between terminals. Connector & terminal (i51) No. 2 (+) — No. 1 (-):	Is the voltage 4.5 — 5.0 V?	Go to step 4.	Repair or replace the open circuit of the harness.
4 CHECK HARNESS. 1) Disconnect the connector from the A/C control panel. 2) Using a tester, check continuity between terminals. Connector & terminal (i51) No. 1 — (i88) No. 14: (i51) No. 1 — (i88) No. 16:	Is there continuity?	Replace the A/C control panel. <Ref. to AC-47, REMOVAL, Control Panel.>	Repair or replace the short circuit of the harness.

Diagnostic Procedure with Diagnostic Trouble Code (DTC)

HVAC SYSTEM (AUTO A/C) (DIAGNOSTICS)

H: DTC B14A2 SUNLOAD SENSOR CIRCUIT SHORT

DTC DETECTING CONDITION:

Sunload sensor circuit is shorted.

TROUBLE SYMPTOM:

Operation is performed as no sunload.

WIRING DIAGRAM:

Air Conditioning System <Ref. to WI-35, WIRING DIAGRAM, Air Conditioning System.>

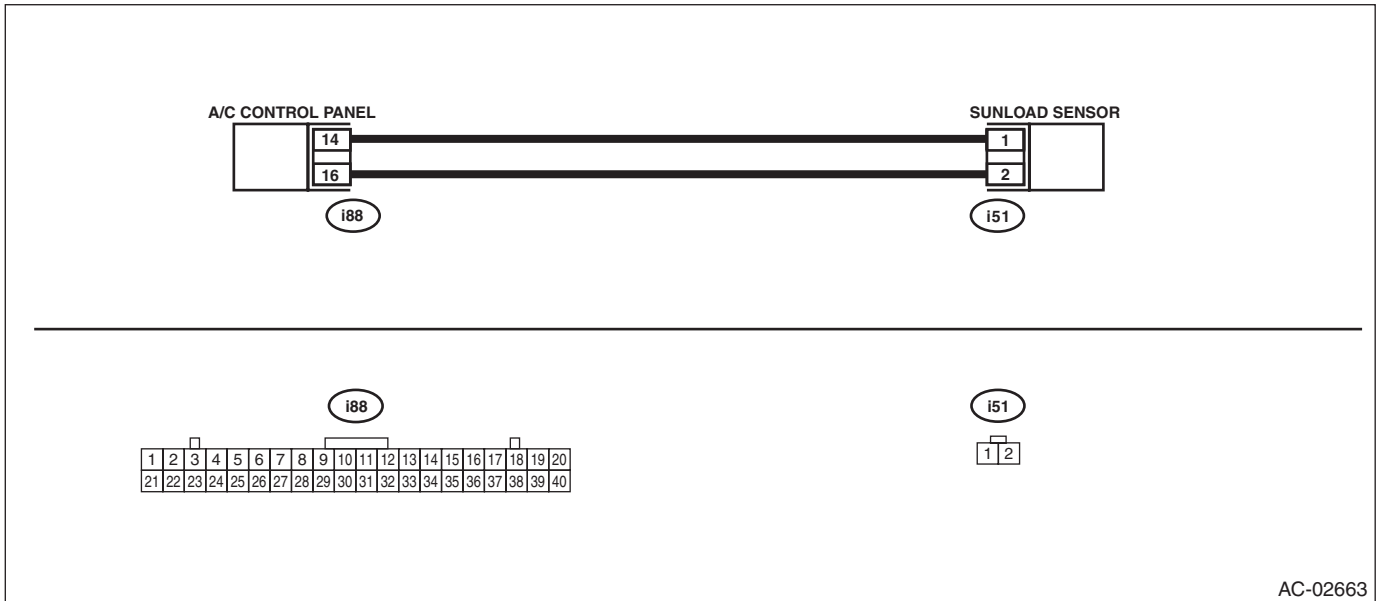

AC-02663

Step	Check	Yes	No
1 CHECK CONNECTOR. 1) Check the condition of connector connection. 2) Read the DTC using Subaru Select Monitor.	Is B14A2 displayed?	Go to step 2.	Check the connection of the sunload sensor circuit.
2 CHECK SUNLOAD SENSOR. 1) Disconnect the sunload sensor. 2) Read the DTC using Subaru Select Monitor.	Is B14A1 displayed?	Replace the sunload sensor. <Ref. to AC-76, REMOVAL, Sunload Sensor (Auto A/C Model).>	Go to step 3.
3 CHECK HARNESS. 1) Turn the ignition switch to ON. 2) Using the tester, measure the voltage between terminals. Connector & terminal (i51) No. 2 (+) — No. 1 (-):	Is the voltage 4.5 — 5.0 V?	Check the connection of the sunload sensor circuit.	Go to step 4.
4 CHECK HARNESS. 1) Disconnect the connector from the A/C control panel. 2) Using a tester, check continuity between terminals. Connector & terminal (i51) No. 1 — No. 2:	Is there continuity?	Repair or replace the short circuit of the harness.	Replace the A/C control panel. <Ref. to AC-47, REMOVAL, Control Panel.>

Diagnostic Procedure with Diagnostic Trouble Code (DTC)

HVAC SYSTEM (AUTO A/C) (DIAGNOSTICS)

I: DTC B14E1 AIR MIX DOOR ACTUATOR STEPPING MOTOR CIRCUIT WIRE BREAK (DRIVER'S SEAT)

DTC DETECTING CONDITION:

Air mix door actuator stepping motor circuit is open.

TROUBLE SYMPTOM:

Temperature cannot be adjusted.

WIRING DIAGRAM:

Air Conditioning System <Ref. to WI-35, WIRING DIAGRAM, Air Conditioning System.>

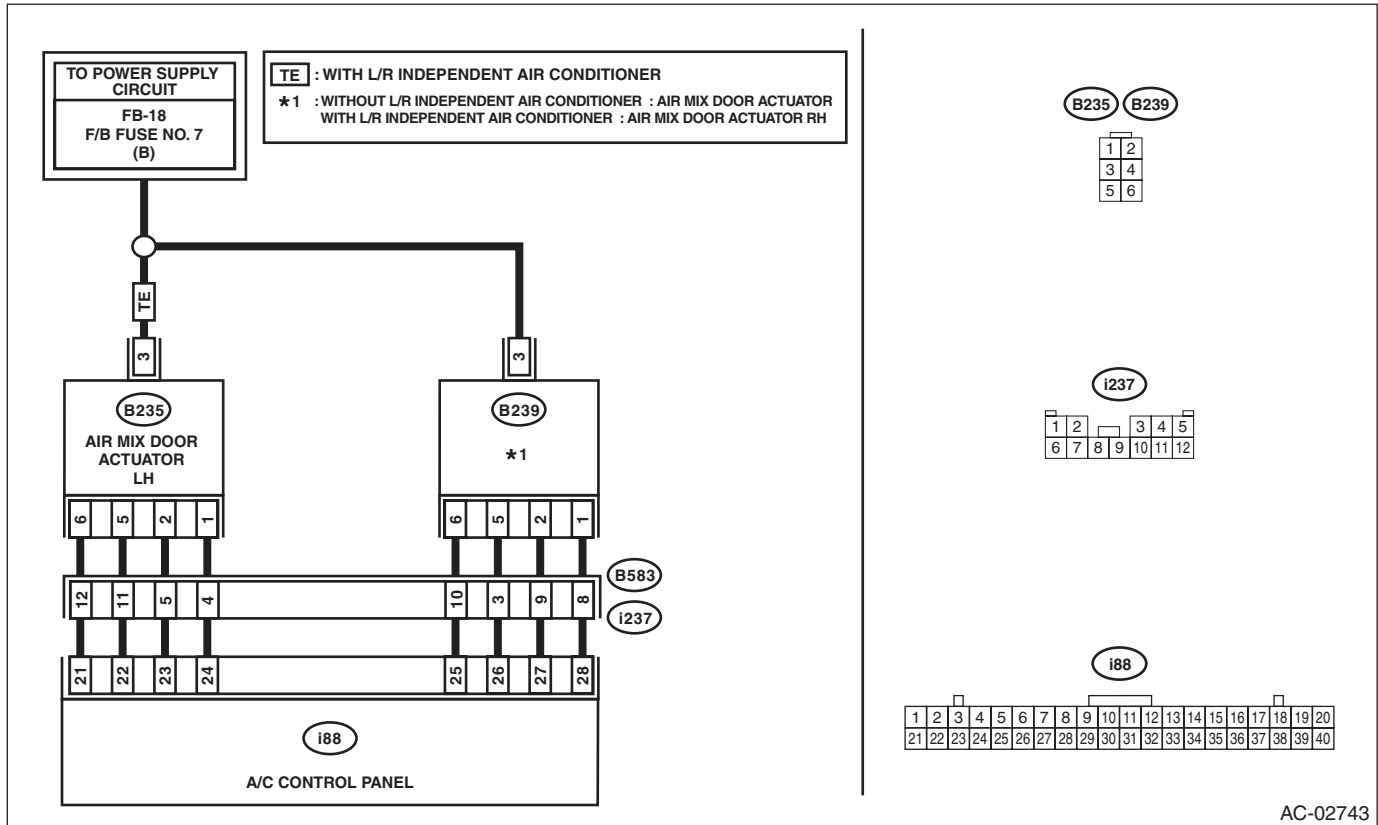

AC-02743

Step	Check	Yes	No
1 CHECK CONNECTOR. 1) Check the condition of connector connection. 2) Read the DTC using Subaru Select Monitor.	Is B14E1 displayed?	Go to step 2.	Repair the poor contact of connector.
2 CHECK ACTUATOR. 1) Turn the ignition switch to OFF. 2) Disconnect the air mix door actuator connector. 3) Turn the ignition switch to ON. 4) Measure the voltage between the air mix door actuator connector terminal and chassis ground. Connector & terminal Without left/right independent air conditioning function (B239) No. 3 (+) — Chassis ground (-): With left/right independent air conditioning function (B235) No. 3 (+) — Chassis ground (-):	Is the voltage approx. 10 V or more?	Go to step 3.	Check the DC power supply circuit.

Diagnostic Procedure with Diagnostic Trouble Code (DTC)

HVAC SYSTEM (AUTO A/C) (DIAGNOSTICS)

Step	Check	Yes	No
<p>3</p> <p>CHECK AIR MIX DOOR ACTUATOR.</p> <p>1) Turn the ignition switch to OFF.</p> <p>2) Measure the resistance between air mix door actuator terminals using a tester.</p> <p>Connector & terminal</p> <p>Without left/right independent air conditioning function</p> <p>(B239) No. 3 — No. 1: (B239) No. 3 — No. 2: (B239) No. 3 — No. 5: (B239) No. 3 — No. 6:</p> <p>With left/right independent air conditioning function</p> <p>(B235) No. 3 — No. 1: (B235) No. 3 — No. 2: (B235) No. 3 — No. 5: (B235) No. 3 — No. 6:</p>	<p>Is the resistance 80 — 100 Ω?</p>	<p>Go to step 4.</p>	<p>Replace the actuator. <Ref. to AC-92, REMOVAL, Air Mix Door Actuator.></p>
<p>4</p> <p>CHECK HARNESS BETWEEN A/C CONTROL PANEL AND AIR MIX DOOR ACTUATOR.</p> <p>1) Disconnect the A/C control panel connector.</p> <p>2) Measure the resistance between A/C control panel and air mix door actuator connector.</p> <p>Connector & terminal</p> <p>Without left/right independent air conditioning function</p> <p>(B239) No. 1 — (i88) No. 28: (B239) No. 2 — (i88) No. 27: (B239) No. 5 — (i88) No. 26: (B239) No. 6 — (i88) No. 25:</p> <p>With left/right independent air conditioning function</p> <p>(B235) No. 1 — (i88) No. 24: (B235) No. 2 — (i88) No. 23: (B235) No. 5 — (i88) No. 22: (B235) No. 6 — (i88) No. 21:</p>	<p>Is there continuity?</p>	<p>Replace the A/C control panel. <Ref. to AC-47, REMOVAL, Control Panel.></p>	<p>Repair or replace the open circuit of harness.</p>

Diagnostic Procedure with Diagnostic Trouble Code (DTC)

HVAC SYSTEM (AUTO A/C) (DIAGNOSTICS)

J: DTC B14E2 AIR MIX DOOR ACTUATOR STEPPING MOTOR CIRCUIT SHORT-CIRCUIT (DRIVER'S SEAT)

DTC DETECTING CONDITION:

Air mix door actuator stepping motor circuit is shorted.

TROUBLE SYMPTOM:

Temperature cannot be adjusted.

WIRING DIAGRAM:

Air Conditioning System <Ref. to WI-35, WIRING DIAGRAM, Air Conditioning System.>

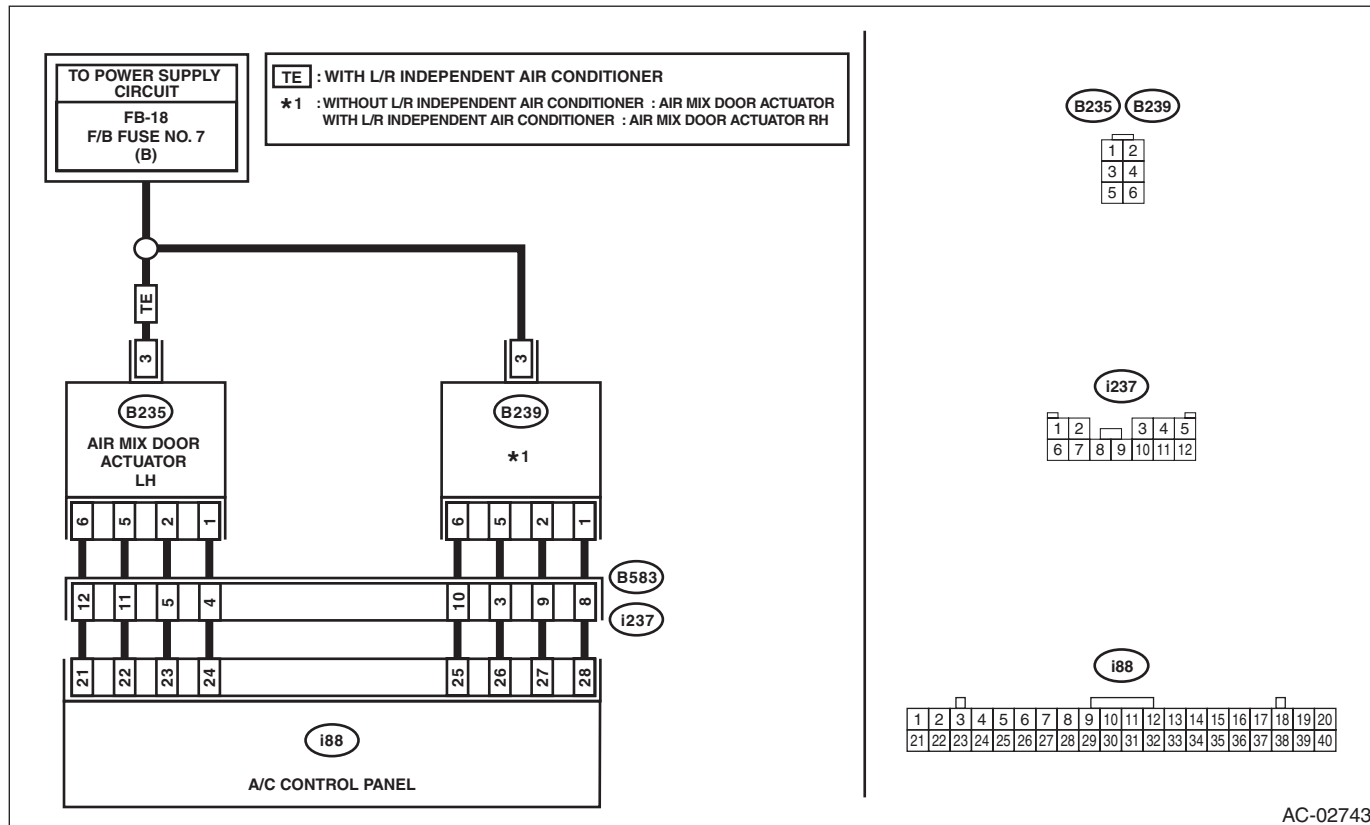

AC-02743

Step	Check	Yes	No
1 CHECK CONNECTOR. 1) Check the condition of connector connection. 2) Read the DTC using Subaru Select Monitor.	Is B14E2 displayed?	Go to step 2.	Repair the poor contact of connector.
2 CHECK POWER SUPPLY OF AIR MIX DOOR ACTUATOR. 1) Turn the ignition switch to OFF. 2) Disconnect the air mix door actuator connector. 3) Turn the ignition switch to ON. 4) Measure the voltage between the air mix door actuator connector terminal and chassis ground. Connector & terminal Without left/right independent air conditioning function (B239) No. 3 (+) — Chassis ground (-): With left/right independent air conditioning function (B235) No. 3 (+) — Chassis ground (-):	Is the voltage approx. 10 V or more?	Go to step 3.	Check the DC power supply circuit.

Diagnostic Procedure with Diagnostic Trouble Code (DTC)

HVAC SYSTEM (AUTO A/C) (DIAGNOSTICS)

Step	Check	Yes	No
<p>3</p> <p>CHECK AIR MIX DOOR ACTUATOR.</p> <p>1) Turn the ignition switch to OFF.</p> <p>2) Measure the resistance between air mix door actuator terminals using a tester.</p> <p>Connector & terminal</p> <p>Without left/right independent air conditioning function</p> <p>(B239) No. 3 — No. 1: (B239) No. 3 — No. 2: (B239) No. 3 — No. 5: (B239) No. 3 — No. 6:</p> <p>With left/right independent air conditioning function</p> <p>(B235) No. 3 — No. 1: (B235) No. 3 — No. 2: (B235) No. 3 — No. 5: (B235) No. 3 — No. 6:</p>	<p>Is the resistance 80 — 100 Ω?</p>	<p>Go to step 4.</p>	<p>Replace the actuator. <Ref. to AC-92, REMOVAL, Air Mix Door Actuator.></p>
<p>4</p> <p>CHECK HARNESS BETWEEN A/C CONTROL PANEL AND AIR MIX DOOR ACTUATOR.</p> <p>1) Disconnect the A/C control panel connector.</p> <p>2) Measure the voltage between air mix door actuator connector and chassis ground.</p> <p>Connector & terminal</p> <p>Without left/right independent air conditioning function</p> <p>(B239) No. 1 (+) — Chassis ground (-): (B239) No. 2 (+) — Chassis ground (-): (B239) No. 5 (+) — Chassis ground (-): (B239) No. 6 (+) — Chassis ground (-):</p> <p>With left/right independent air conditioning function</p> <p>(B235) No. 1 (+) — Chassis ground (-): (B235) No. 2 (+) — Chassis ground (-): (B235) No. 5 (+) — Chassis ground (-): (B235) No. 6 (+) — Chassis ground (-):</p>	<p>Is there any voltage?</p>	<p>Repair or replace the short circuit of the harness.</p>	<p>Replace the A/C control panel. <Ref. to AC-47, REMOVAL, Control Panel.></p>

Diagnostic Procedure with Diagnostic Trouble Code (DTC)

HVAC SYSTEM (AUTO A/C) (DIAGNOSTICS)

K: DTC B14E3 AIR MIX DOOR ACTUATOR STEPPING MOTOR CIRCUIT WIRE BREAK (PASSENGER'S SEAT)

DTC DETECTING CONDITION:

Air mix door actuator stepping motor circuit is open.

TROUBLE SYMPTOM:

Temperature cannot be adjusted.

WIRING DIAGRAM:

Air Conditioning System <Ref. to WI-35, WIRING DIAGRAM, Air Conditioning System.>

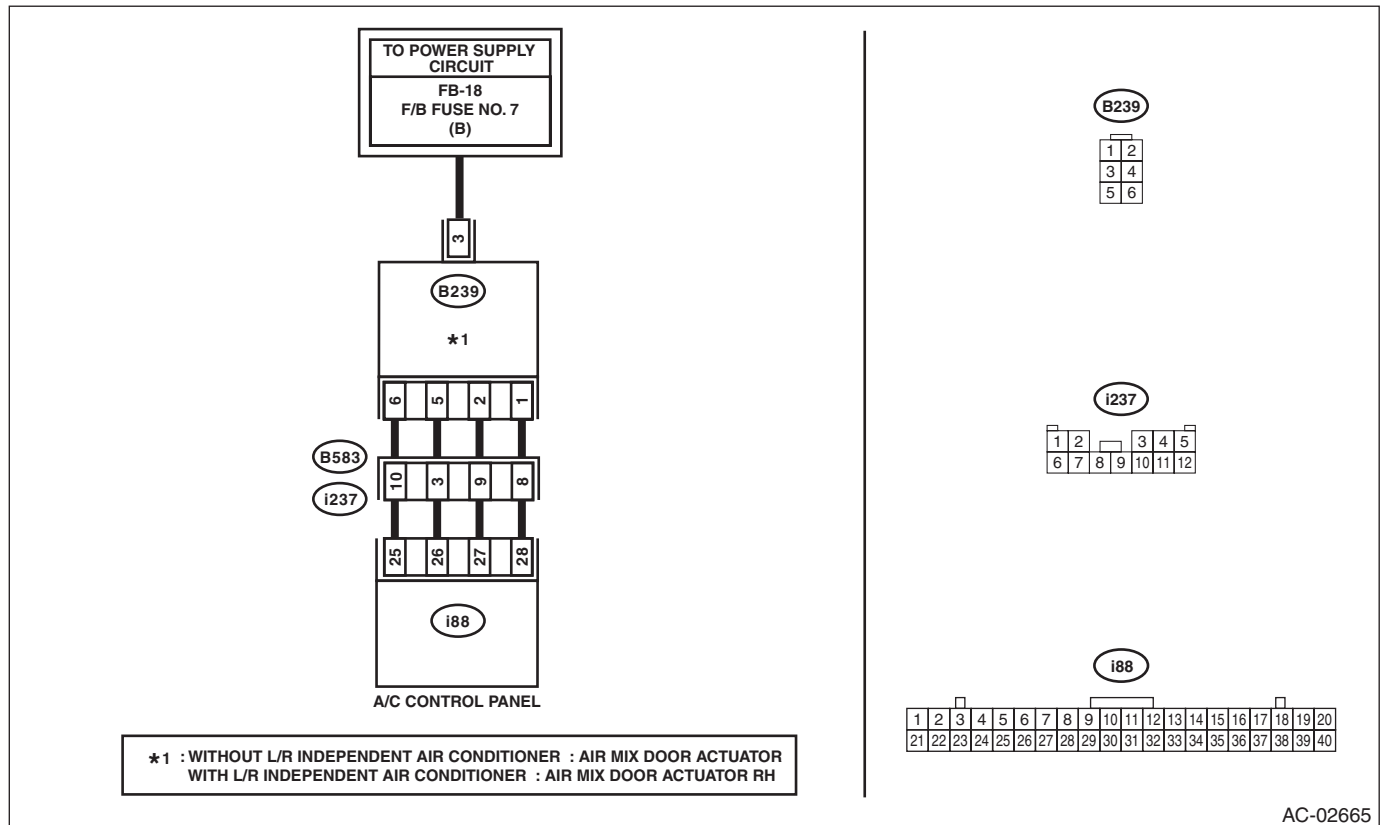

Step	Check	Yes	No
1 CHECK CONNECTOR. 1) Check the condition of connector connection. 2) Read the DTC using Subaru Select Monitor.	Is B14E3 displayed?	Go to step 2.	Repair the poor contact of connector.
2 CHECK ACTUATOR. 1) Turn the ignition switch to OFF. 2) Disconnect the air mix door actuator connector. 3) Turn the ignition switch to ON. 4) Measure the voltage between the air mix door actuator connector terminal and chassis ground. Connector & terminal (B239) No. 3 (+) — Chassis ground (-):	Is the voltage approx. 10 V or more?	Go to step 3.	Check the DC power supply circuit.

Diagnostic Procedure with Diagnostic Trouble Code (DTC)

HVAC SYSTEM (AUTO A/C) (DIAGNOSTICS)

Step	Check	Yes	No
3 CHECK AIR MIX DOOR ACTUATOR. 1) Turn the ignition switch to OFF. 2) Measure the resistance between air mix door actuator terminals using a tester. Connector & terminal (B239) No. 3 — No. 1: (B239) No. 3 — No. 2: (B239) No. 3 — No. 5: (B239) No. 3 — No. 6:	Is the resistance 80 — 100 Ω?	Go to step 4.	Replace the actuator. <Ref. to AC-92, REMOVAL, Air Mix Door Actuator.>
4 CHECK HARNESS BETWEEN A/C CONTROL PANEL AND AIR MIX DOOR ACTUATOR. 1) Disconnect the A/C control panel connector. 2) Measure the resistance between A/C control panel and air mix door actuator connector. Connector & terminal (B239) No. 1 — (i88) No. 28: (B239) No. 2 — (i88) No. 27: (B239) No. 5 — (i88) No. 26: (B239) No. 6 — (i88) No. 25:	Is there continuity?	Replace the A/C control panel. <Ref. to AC-47, REMOVAL, Control Panel.>	Repair or replace the open circuit of harness.

Diagnostic Procedure with Diagnostic Trouble Code (DTC)

HVAC SYSTEM (AUTO A/C) (DIAGNOSTICS)

L: DTC B14E4 AIR MIX DOOR ACTUATOR STEPPING MOTOR CIRCUIT SHORT-CIRCUIT (PASSENGER'S SEAT)

DTC DETECTING CONDITION:

Air mix door actuator stepping motor circuit is shorted.

TROUBLE SYMPTOM:

Temperature cannot be adjusted.

WIRING DIAGRAM:

Air Conditioning System <Ref. to WI-35, WIRING DIAGRAM, Air Conditioning System.>

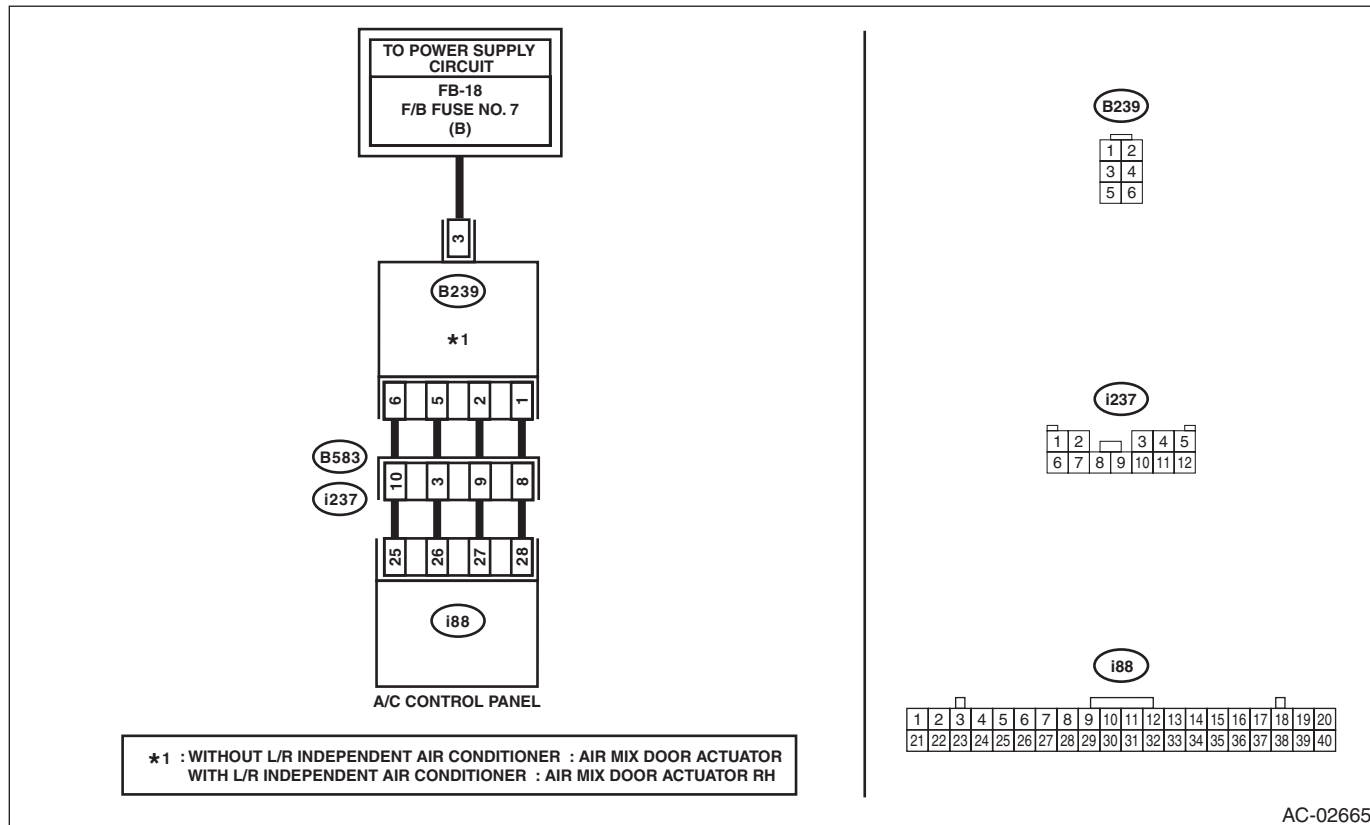

Step	Check	Yes	No
1	CHECK CONNECTOR. 1) Check the condition of connector connection. 2) Read the DTC using Subaru Select Monitor.	Go to step 2.	Repair the poor contact of connector.
2	CHECK POWER SUPPLY OF AIR MIX DOOR ACTUATOR. 1) Turn the ignition switch to OFF. 2) Disconnect the air mix door actuator connector. 3) Turn the ignition switch to ON. 4) Measure the voltage between the air mix door actuator connector terminal and chassis ground. Connector & terminal (B239) No. 3 (+) — Chassis ground (-):	Go to step 3.	Check the DC power supply circuit.

Diagnostic Procedure with Diagnostic Trouble Code (DTC)

HVAC SYSTEM (AUTO A/C) (DIAGNOSTICS)

Step	Check	Yes	No
<p>3</p> <p>CHECK AIR MIX DOOR ACTUATOR.</p> <p>1) Turn the ignition switch to OFF.</p> <p>2) Measure the resistance between air mix door actuator terminals using a tester.</p> <p>Connector & terminal</p> <p>(B239) No. 3 — No. 1:</p> <p>(B239) No. 3 — No. 2:</p> <p>(B239) No. 3 — No. 5:</p> <p>(B239) No. 3 — No. 6:</p>	<p>Is the resistance 80 — 100 Ω?</p>	<p>Go to step 4.</p>	<p>Replace the actuator. <Ref. to AC-92, REMOVAL, Air Mix Door Actuator.></p>
<p>4</p> <p>CHECK HARNESS BETWEEN A/C CONTROL PANEL AND AIR MIX DOOR ACTUATOR.</p> <p>1) Disconnect the A/C control panel connector.</p> <p>2) Measure the voltage between air mix door actuator connector and chassis ground.</p> <p>Connector & terminal</p> <p>(B239) No. 1 (+) — Chassis ground (-):</p> <p>(B239) No. 2 (+) — Chassis ground (-):</p> <p>(B239) No. 5 (+) — Chassis ground (-):</p> <p>(B239) No. 6 (+) — Chassis ground (-):</p>	<p>Is there any voltage?</p>	<p>Repair or replace the short circuit of the harness.</p>	<p>Replace the A/C control panel. <Ref. to AC-47, REMOVAL, Control Panel.></p>

Diagnostic Procedure with Diagnostic Trouble Code (DTC)

HVAC SYSTEM (AUTO A/C) (DIAGNOSTICS)

M: DTC B14E5 MODE DOOR ACTUATOR STEPPING MOTOR CIRCUIT WIRE BREAK

DTC DETECTING CONDITION:

Mode door actuator stepping motor circuit is open.

TROUBLE SYMPTOM:

Vent does not change.

WIRING DIAGRAM:

Air Conditioning System <Ref. to WI-35, WIRING DIAGRAM, Air Conditioning System.>

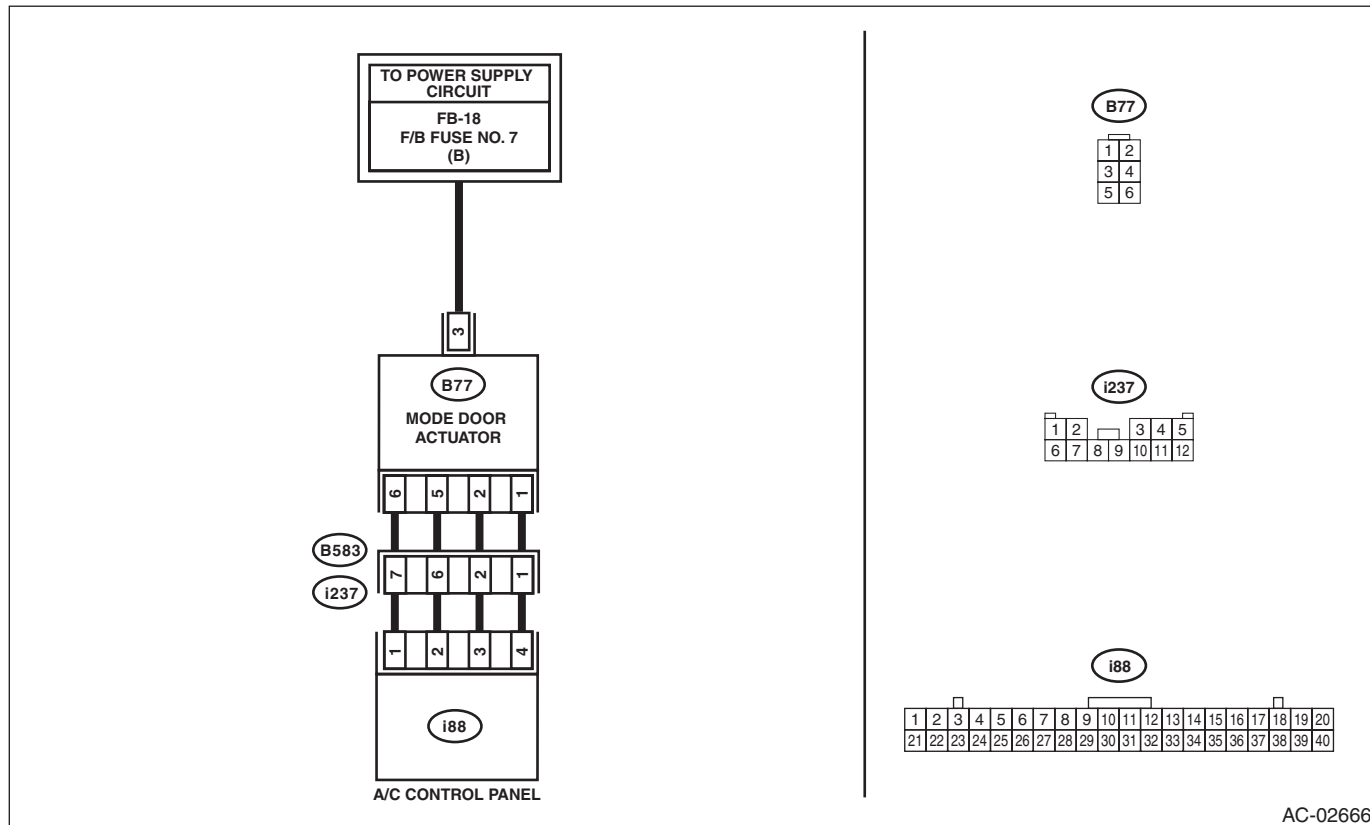

AC-02666

Step	Check	Yes	No
1 CHECK CONNECTOR. 1) Check the condition of connector connection. 2) Read the DTC using Subaru Select Monitor.	Is B14E5 displayed?	Go to step 2.	Repair the poor contact of connector.
2 CHECK ACTUATOR. 1) Turn the ignition switch to OFF. 2) Disconnect the mode door actuator connector. 3) Turn the ignition switch to ON. 4) Measure the voltage between the mode door actuator connector terminal and chassis ground. Connector & terminal (B77) No. 3 (+) — Chassis ground (-):	Is the voltage approx. 10 V or more?	Go to step 3.	Check the DC power supply circuit.

Diagnostic Procedure with Diagnostic Trouble Code (DTC)

HVAC SYSTEM (AUTO A/C) (DIAGNOSTICS)

Step	Check	Yes	No
3 CHECK AIR MIX DOOR ACTUATOR. 1) Turn the ignition switch to OFF. 2) Measure the resistance between mode door actuator terminals using a tester. Connector & terminal <i>(B77) No. 3 — No. 1:</i> <i>(B77) No. 3 — No. 2:</i> <i>(B77) No. 3 — No. 5:</i> <i>(B77) No. 3 — No. 6:</i>	Is the resistance 80 — 100 Ω?	Go to step 4.	Replace the actuator. <Ref. to AC-90, REMOVAL, Mode Door Actuator.>
4 CHECK HARNESS BETWEEN A/C CONTROL PANEL AND MODE DOOR ACTUATOR. 1) Disconnect the A/C control panel connector. 2) Measure the resistance between A/C control panel and air mix door actuator connector. Connector & terminal <i>(B77) No. 1 — (i88) No. 4:</i> <i>(B77) No. 2 — (i88) No. 3:</i> <i>(B77) No. 5 — (i88) No. 2:</i> <i>(B77) No. 6 — (i88) No. 1:</i>	Is there continuity?	Replace the A/C control panel. <Ref. to AC-47, REMOVAL, Control Panel.>	Repair or replace the open circuit of harness.

Diagnostic Procedure with Diagnostic Trouble Code (DTC)

HVAC SYSTEM (AUTO A/C) (DIAGNOSTICS)

N: DTC B14E6 MODE DOOR ACTUATOR STEPPING MOTOR CIRCUIT SHORT-CIRCUIT

DTC DETECTING CONDITION:

Mode door actuator stepping motor circuit is shorted.

TROUBLE SYMPTOM:

Vent does not change.

WIRING DIAGRAM:

Air Conditioning System <Ref. to WI-35, WIRING DIAGRAM, Air Conditioning System.>

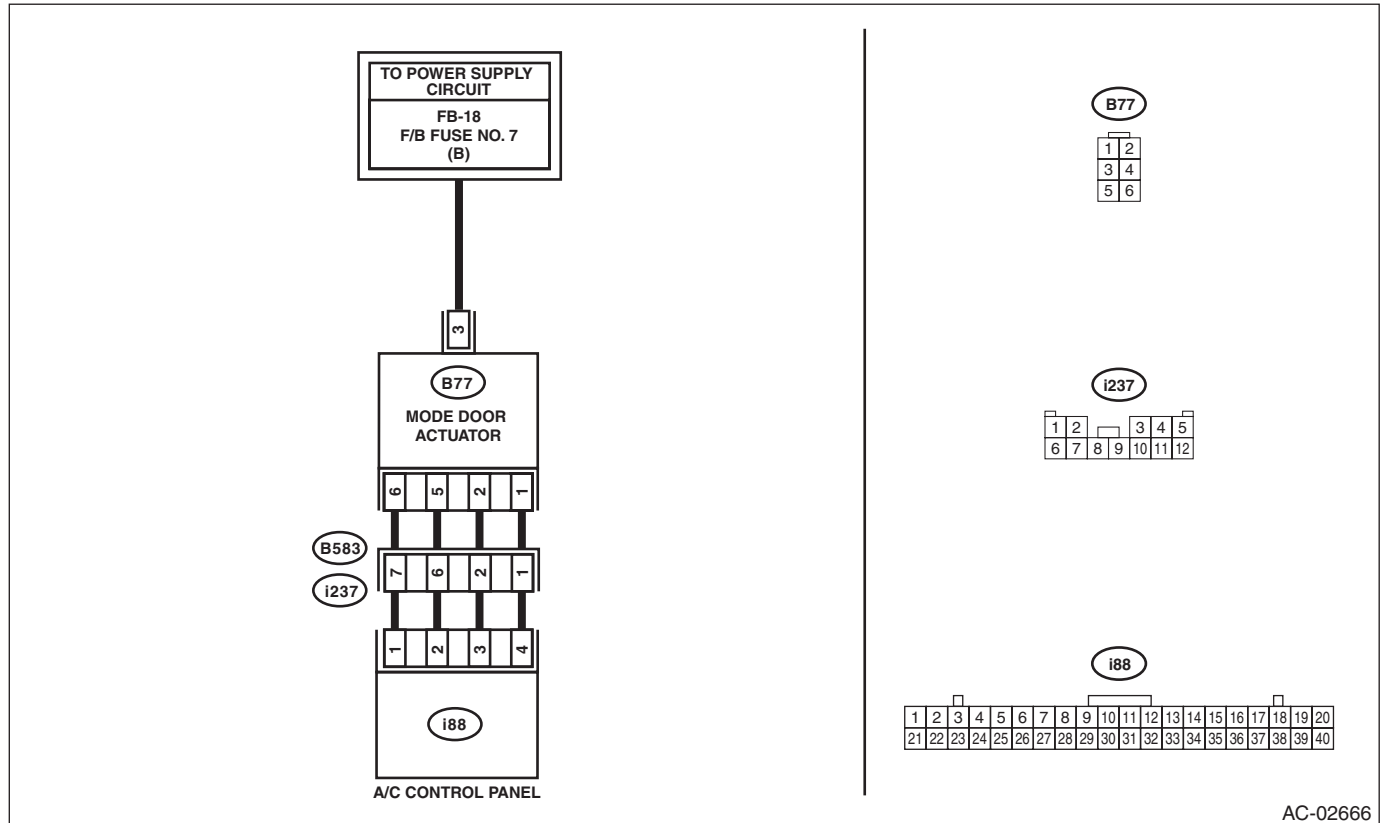

AC-02666

Step	Check	Yes	No
1 CHECK CONNECTOR. 1) Check the condition of connector connection. 2) Read the DTC using Subaru Select Monitor.	Is B14E6 displayed?	Go to step 2.	Repair the poor contact of connector.
2 CHECK POWER SUPPLY FOR MODE DOOR ACTUATOR. 1) Turn the ignition switch to OFF. 2) Disconnect the mode door actuator connector. 3) Turn the ignition switch to ON. 4) Measure the voltage between the mode door actuator connector terminal and chassis ground. Connector & terminal (B77) No. 3 (+) — Chassis ground (-):	Is the voltage approx. 10 V or more?	Go to step 3.	Check the DC power supply circuit.

Diagnostic Procedure with Diagnostic Trouble Code (DTC)

HVAC SYSTEM (AUTO A/C) (DIAGNOSTICS)

Step	Check	Yes	No
<p>3</p> <p>CHECK MODE DOOR ACTUATOR.</p> <p>1) Turn the ignition switch to OFF.</p> <p>2) Measure the resistance between mode door actuator terminals using a tester.</p> <p>Connector & terminal</p> <p>(B77) No. 3 — No. 1:</p> <p>(B77) No. 3 — No. 2:</p> <p>(B77) No. 3 — No. 5:</p> <p>(B77) No. 3 — No. 6:</p>	<p>Is the resistance 80 — 100 Ω?</p>	<p>Go to step 4.</p>	<p>Replace the actuator. <Ref. to AC-90, REMOVAL, Mode Door Actuator.></p>
<p>4</p> <p>CHECK HARNESS BETWEEN A/C CONTROL PANEL AND MODE DOOR ACTUATOR.</p> <p>1) Disconnect the A/C control panel connector.</p> <p>2) Measure the voltage between mode door actuator connector and chassis ground.</p> <p>Connector & terminal</p> <p>(B77) No. 1 (+) — Chassis ground (-):</p> <p>(B77) No. 2 (+) — Chassis ground (-):</p> <p>(B77) No. 5 (+) — Chassis ground (-):</p> <p>(B77) No. 6 (+) — Chassis ground (-):</p>	<p>Is there any voltage?</p>	<p>Repair or replace the short circuit of the harness.</p>	<p>Replace the A/C control panel. <Ref. to AC-47, REMOVAL, Control Panel.></p>

Diagnostic Procedure with Diagnostic Trouble Code (DTC)

HVAC SYSTEM (AUTO A/C) (DIAGNOSTICS)

O: DTC B14E9 INTAKE DOOR ACTUATOR POTENTIOMETER CIRCUIT WIRE BREAK

DTC DETECTING CONDITION:

Intake door actuator potentiometer circuit is open.

TROUBLE SYMPTOM:

FRESH/RECIRC does not operate.

WIRING DIAGRAM:

Air Conditioning System <Ref. to WI-35, WIRING DIAGRAM, Air Conditioning System.>

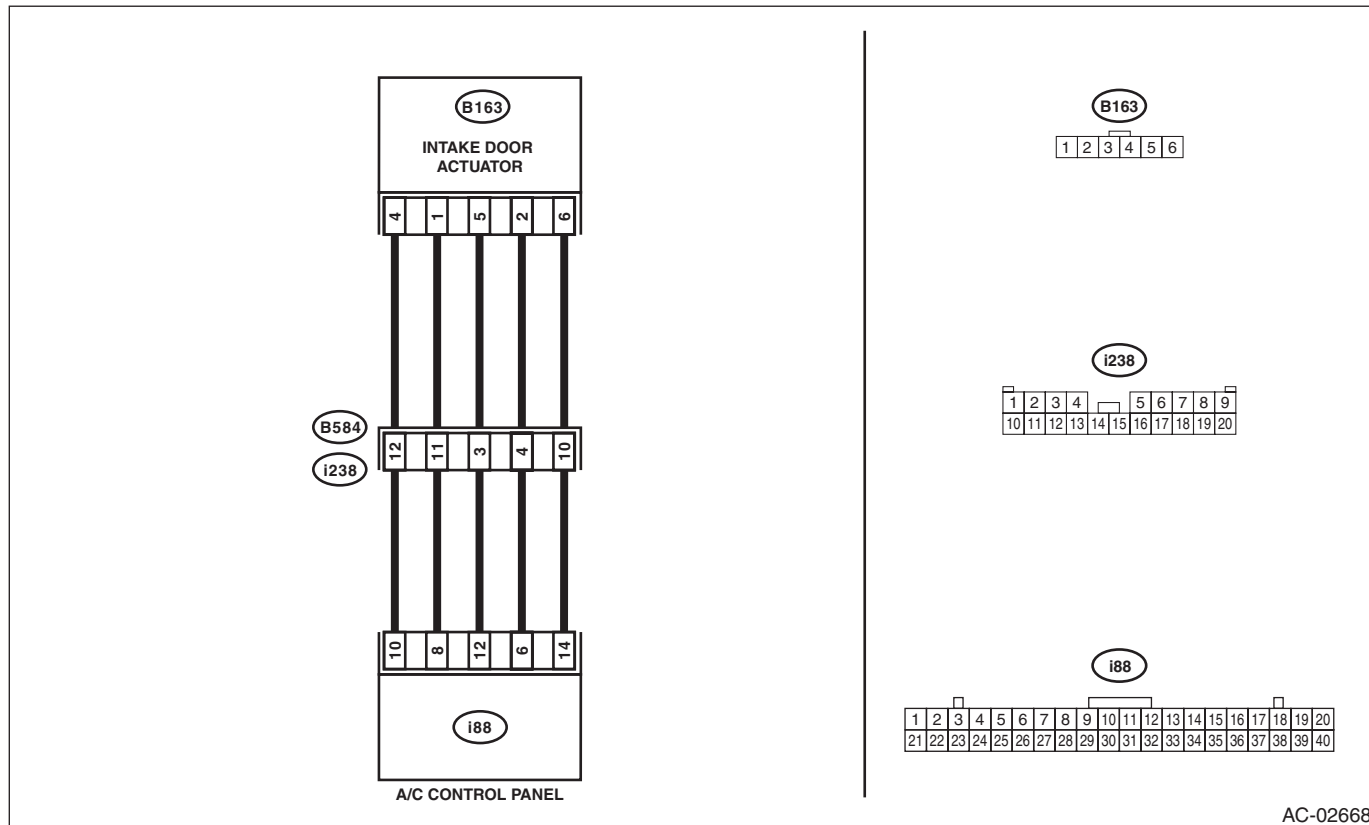

AC-02668

Step	Check	Yes	No
1 CHECK CONNECTOR. 1) Check the condition of connector connection. 2) Read the DTC using Subaru Select Monitor.	Is B14E9 displayed?	Go to step 2.	Repair the poor contact of connector.
2 CHECK HARNESS. 1) Turn the ignition switch to ON. 2) Using the tester, measure the voltage between terminals. <i>Connector & terminal</i> <i>(B163) No. 4 (+) — No. 6 (-):</i>	Is the voltage 4.5 — 5.0 V?	Go to step 3.	Repair or replace the open circuit of harness.
3 CHECK HARNESS. 1) Turn the ignition switch to OFF. 2) Using a tester, check continuity between terminals. <i>Connector & terminal</i> <i>(B163) No. 1 — (i88) No. 8:</i> <i>(B163) No. 2 — (i88) No. 6:</i> <i>(B163) No. 4 — (i88) No. 10:</i> <i>(B163) No. 5 — (i88) No. 12:</i> <i>(B163) No. 6 — (i88) No. 14:</i>	Is there continuity?	Go to step 4.	Repair or replace the open circuit of harness.

Diagnostic Procedure with Diagnostic Trouble Code (DTC)

HVAC SYSTEM (AUTO A/C) (DIAGNOSTICS)

Step	Check	Yes	No
4 CHECK ACTUATOR. 1) Turn the ignition switch to ON. 2) Using the tester, measure the voltage between terminals. Connector & terminal (B163) No. 5 (+) — No. 6 (-):	Is the voltage 0.5 — 4.5 V?	Replace the A/C control panel. <Ref. to AC-47, REMOVAL, Control Panel.>	Go to step 5.
5 CHECK HARNESS. 1) Turn the ignition switch to OFF. 2) Using the tester, measure the resistance between terminals. Connector & terminal (B163) No. 4 — No. 5:	Is the resistance less than 1 Ω ?	Repair or replace the short circuit of the harness.	Replace the actuator. <Ref. to AC-85, REMOVAL, FRESH/RECIRC Door Actuator.>

Diagnostic Procedure with Diagnostic Trouble Code (DTC)

HVAC SYSTEM (AUTO A/C) (DIAGNOSTICS)

P: DTC B14EA INTAKE DOOR ACTUATOR POTENTIOMETER CIRCUIT SHORT-CIRCUIT

DTC DETECTING CONDITION:

Intake door actuator potentiometer circuit is shorted.

TROUBLE SYMPTOM:

FRESH/RECIRC does not operate.

WIRING DIAGRAM:

Air Conditioning System <Ref. to WI-35, WIRING DIAGRAM, Air Conditioning System.>

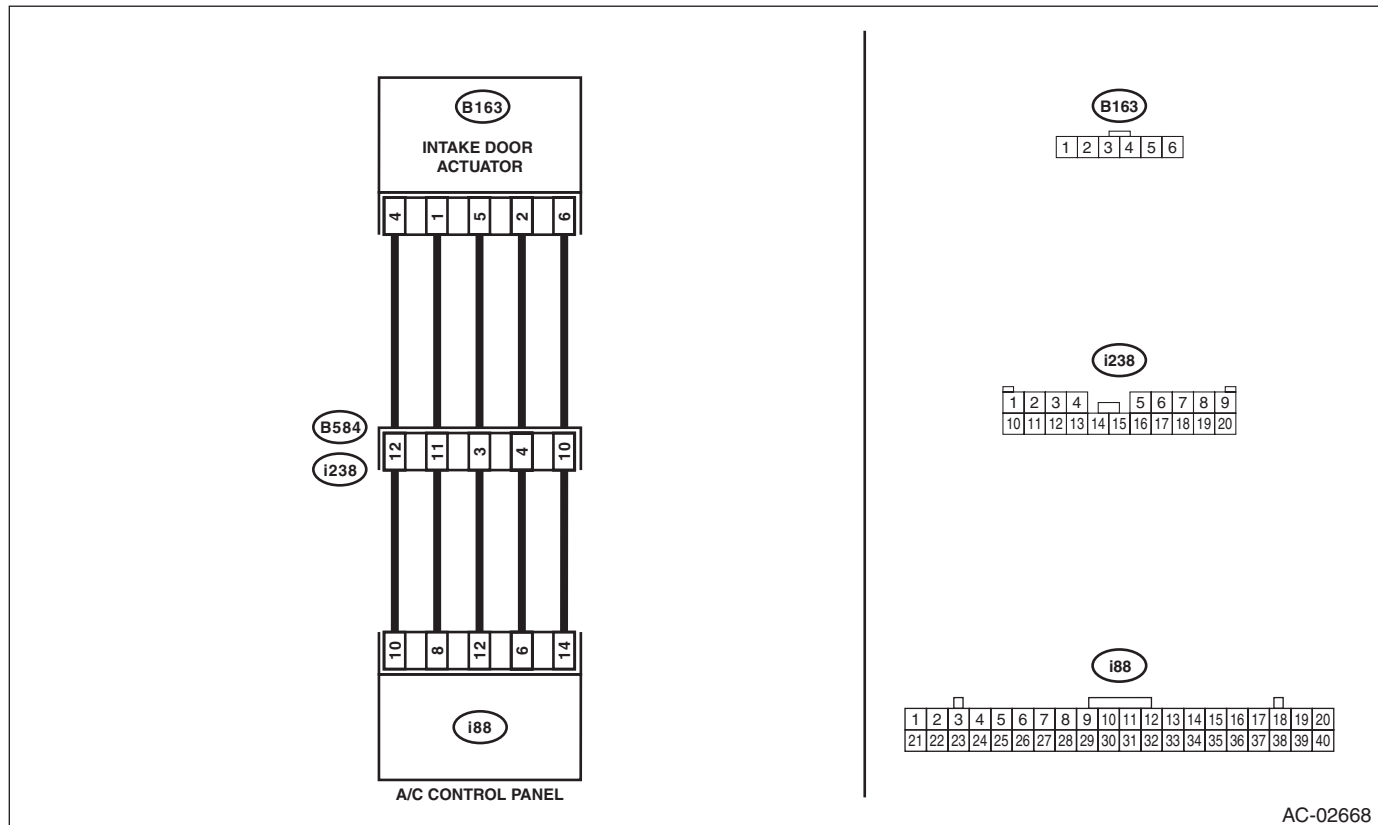

AC-02668

Step	Check	Yes	No
1 CHECK CONNECTOR. 1) Check the condition of connector connection. 2) Read the DTC using Subaru Select Monitor.	Is B14EA displayed?	Go to step 2.	Repair the poor contact of connector.
2 CHECK ACTUATOR. 1) Turn the ignition switch to ON. 2) Using the tester, measure the voltage between terminals. <i>Connector & terminal</i> <i>(B163) No. 4 (+) — No. 6 (-):</i>	Is the voltage 4.5 — 5.0 V?	Go to step 3.	Repair or replace the open circuit of harness.
3 CHECK HARNESS. 1) Turn the ignition switch to OFF. 2) Using a tester, check continuity between terminals. <i>Connector & terminal</i> <i>(B163) No. 4 — (i88) No. 10:</i> <i>(B163) No. 5 — (i88) No. 12:</i> <i>(B163) No. 6 — (i88) No. 14:</i>	Is there continuity?	Go to step 4.	Repair or replace the open circuit of harness.

Diagnostic Procedure with Diagnostic Trouble Code (DTC)

HVAC SYSTEM (AUTO A/C) (DIAGNOSTICS)

Step	Check	Yes	No
4 CHECK ACTUATOR. 1) Turn the ignition switch to ON. 2) Using the tester, measure the voltage between terminals. Connector & terminal (B163) No. 5 (+) — No. 6 (-):	Is the voltage 0.5 — 4.5 V?	Replace the A/C control panel. <Ref. to AC-47, REMOVAL, Control Panel.>	Go to step 5.
5 CHECK HARNESS. 1) Turn the ignition switch to OFF. 2) Using the tester, measure the resistance between terminals. Connector & terminal (B163) No. 5 — No. 6:	Is the resistance less than 1 Ω ?	Repair or replace the short circuit of the harness.	Replace the actuator. <Ref. to AC-85, REMOVAL, FRESH/RECIRC Door Actuator.>

Diagnostic Procedure with Diagnostic Trouble Code (DTC)

HVAC SYSTEM (AUTO A/C) (DIAGNOSTICS)

Q: DTC B14EB INTAKE DOOR ACTUATOR LOCK

DTC DETECTING CONDITION:

- Intake door actuator is locked.
- The potentiometer value of the actuator does not change.

TROUBLE SYMPTOM:

FRESH/RECIRC does not operate.

WIRING DIAGRAM:

Air Conditioning System <Ref. to WI-35, WIRING DIAGRAM, Air Conditioning System.>

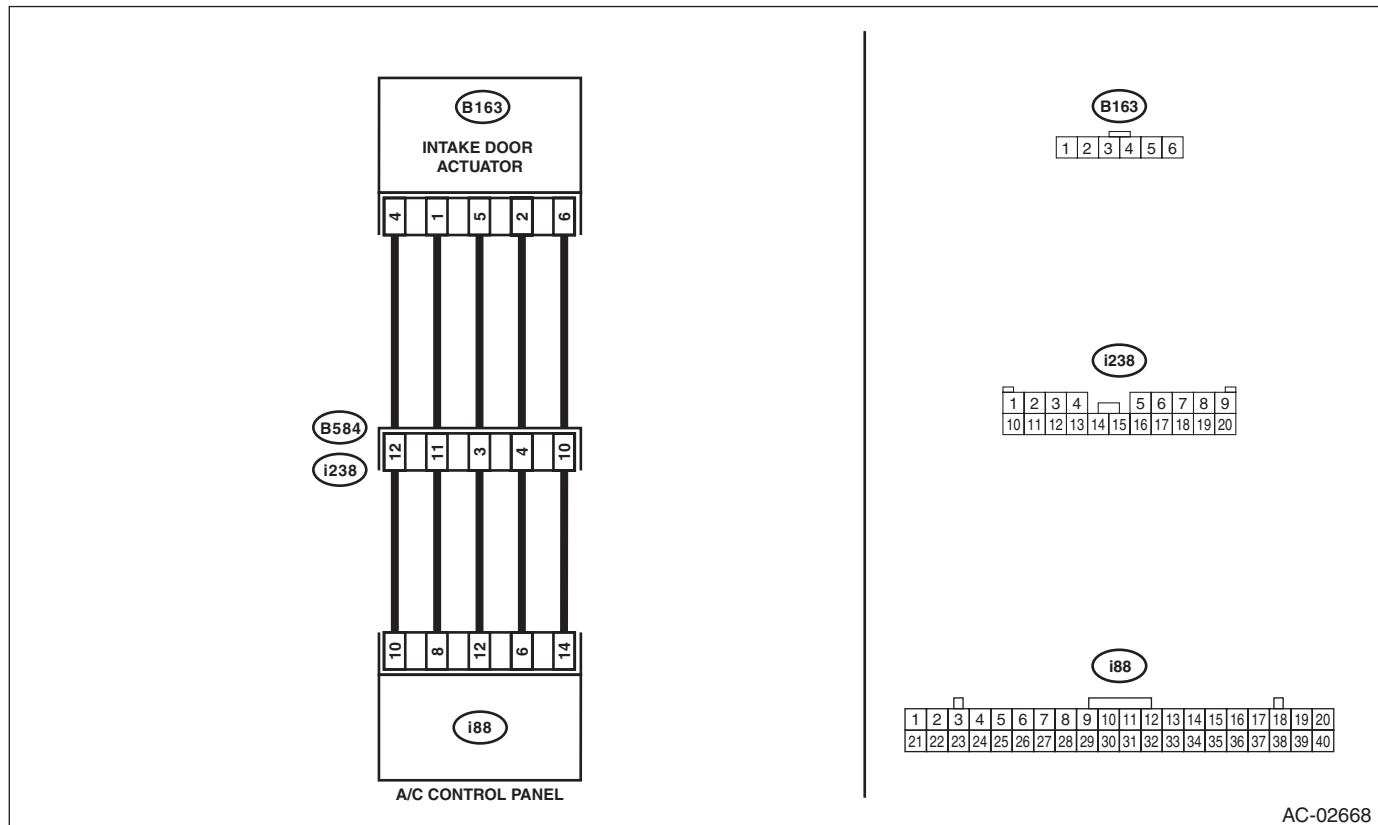

AC-02668

Step	Check	Yes	No
1 CHECK CONNECTOR. 1) Check the condition of connector connection. 2) Read the DTC using Subaru Select Monitor.	Is B14EB displayed?	Go to step 2.	Repair the poor contact of connector.
2 CHECK CURRENT DATA. Using the Subaru Select Monitor, change the setting of "Fresh/Rec Air Dr Act Trgt Open Angle" from Air Conditioning Diagnosis and perform the active test.	Did the actuator move to the specified target opening angle?	Intake door actuator circuit is normal.	Go to step 3.
3 CHECK HARNESS. 1) Turn the ignition switch to ON. 2) Using the tester, measure the voltage between terminals. Connector & terminal (i176) No. 4 (+) — No. 6 (-):	Is the voltage 4.5 — 5.0 V?	Go to step 4.	Repair or replace the open circuit of harness.

Diagnostic Procedure with Diagnostic Trouble Code (DTC)

HVAC SYSTEM (AUTO A/C) (DIAGNOSTICS)

Step	Check	Yes	No
4 CHECK HARNESS. 1) Disconnect the connector from the A/C control panel. 2) Using a tester, check continuity between terminals. Connector & terminal <i>(i163) No. 1 — (i88) No. 8:</i> <i>(i163) No. 2 — (i88) No. 6:</i> <i>(i163) No. 4 — (i88) No. 10:</i> <i>(i163) No. 5 — (i88) No. 12:</i> <i>(i163) No. 6 — (i88) No. 14:</i>	Is there continuity?	Go to step 5.	Repair or replace the open circuit of harness.
5 CHECK INTAKE DOOR ACTUATOR. Check the intake door actuator parts.	Is the actuator normal?	Replace the A/C control panel. <Ref. to AC-47, REMOVAL, Control Panel.>	Replace the actuator. <Ref. to AC-85, REMOVAL, FRESH/RECIRC Door Actuator.>

R: DTC U0073 CONTROL MODULE COMMUNICATION BUS “A” OFF

Detected when defective CAN line is detected.

NOTE:

Perform the diagnosis for LAN system. <Ref. to LAN(diag)-2, PROCEDURE, Basic Diagnostic Procedure.>

S: DTC U0100 LOST COMMUNICATION WITH ECM/PCM “A”

Detected when CAN data is not received from engine control module (ECM).

NOTE:

Perform the diagnosis for LAN system. <Ref. to LAN(diag)-2, PROCEDURE, Basic Diagnostic Procedure.>

T: DTC U0101 LOST COMMUNICATION WITH TCM

Detected when CAN data is not received from TCM.

NOTE:

Perform the diagnosis for LAN system. <Ref. to LAN(diag)-2, PROCEDURE, Basic Diagnostic Procedure.>

U: DTC U0122 LOST COMMUNICATION WITH VEHICLE DYNAMICS CONTROL MODULE

Detected when CAN data is not received from VDC.

NOTE:

Perform the diagnosis for LAN system. <Ref. to LAN(diag)-2, PROCEDURE, Basic Diagnostic Procedure.>

V: DTC U0140 LOST COMMUNICATION WITH BODY CONTROL MODULE

This is detected when CAN signal is not received from BIU.

NOTE:

Perform the diagnosis for LAN system. <Ref. to LAN(diag)-2, PROCEDURE, Basic Diagnostic Procedure.>

Diagnostic Procedure with Diagnostic Trouble Code (DTC)

HVAC SYSTEM (AUTO A/C) (DIAGNOSTICS)

W: DTC U0155 LOST COMMUNICATION WITH INSTRUMENT PANEL CLUSTER (IPC) CONTROL MODULE

This is detected when CAN signal is not received from meter.

NOTE:

Perform the diagnosis for LAN system. <Ref. to LAN(diag)-2, PROCEDURE, Basic Diagnostic Procedure.>

X: DTC U0401 INVALID DATA RECEIVED FROM ECM/PCM “A”

This is detected when CAN data from engine control module (ECM) is abnormal.

NOTE:

Perform the diagnosis for LAN system. <Ref. to LAN(diag)-2, PROCEDURE, Basic Diagnostic Procedure.>

Y: DTC U0402 INVALID DATA RECEIVED FROM TCM

This is detected when CAN data from TCM is abnormal.

NOTE:

Perform the diagnosis for LAN system. <Ref. to LAN(diag)-2, PROCEDURE, Basic Diagnostic Procedure.>

Z: DTC U0416 INVALID DATA RECEIVED FROM VEHICLE DYNAMICS CONTROL MODULE

This is detected when CAN data from VDC is abnormal.

NOTE:

Perform the diagnosis for LAN system. <Ref. to LAN(diag)-2, PROCEDURE, Basic Diagnostic Procedure.>

AA:DTC U0422 INVALID DATA RECEIVED FROM BODY CONTROL MODULE

This is detected when CAN data from BIU is abnormal.

NOTE:

Perform the diagnosis for LAN system. <Ref. to LAN(diag)-2, PROCEDURE, Basic Diagnostic Procedure.>

AB:DTC U0423 INVALID DATA RECEIVED FROM INSTRUMENT PANEL CLUSTER CONTROL MODULE

This is detected when CAN data from meter is abnormal.

NOTE:

Perform the diagnosis for LAN system. <Ref. to LAN(diag)-2, PROCEDURE, Basic Diagnostic Procedure.>

AIRBAG SYSTEM

AB

	Page
1. General Description	2
2. Airbag Connector	20
3. Inspection Locations after a Collision	34
4. Driver's Airbag Module	42
5. Knee Airbag Module	44
6. Passenger's Airbag Module	47
7. Side Airbag Module	66
8. Curtain Airbag Module	74
9. Airbag Control Module	77
10. Front Sub Sensor	81
11. Front Door Impact Sensor	85
12. Side Airbag Sensor	88
13. Curtain Airbag Sensor	93
14. Satellite Safing Sensor	101
15. Roll Connector	104

General Description

AIRBAG SYSTEM

1. General Description

A: COMPONENT

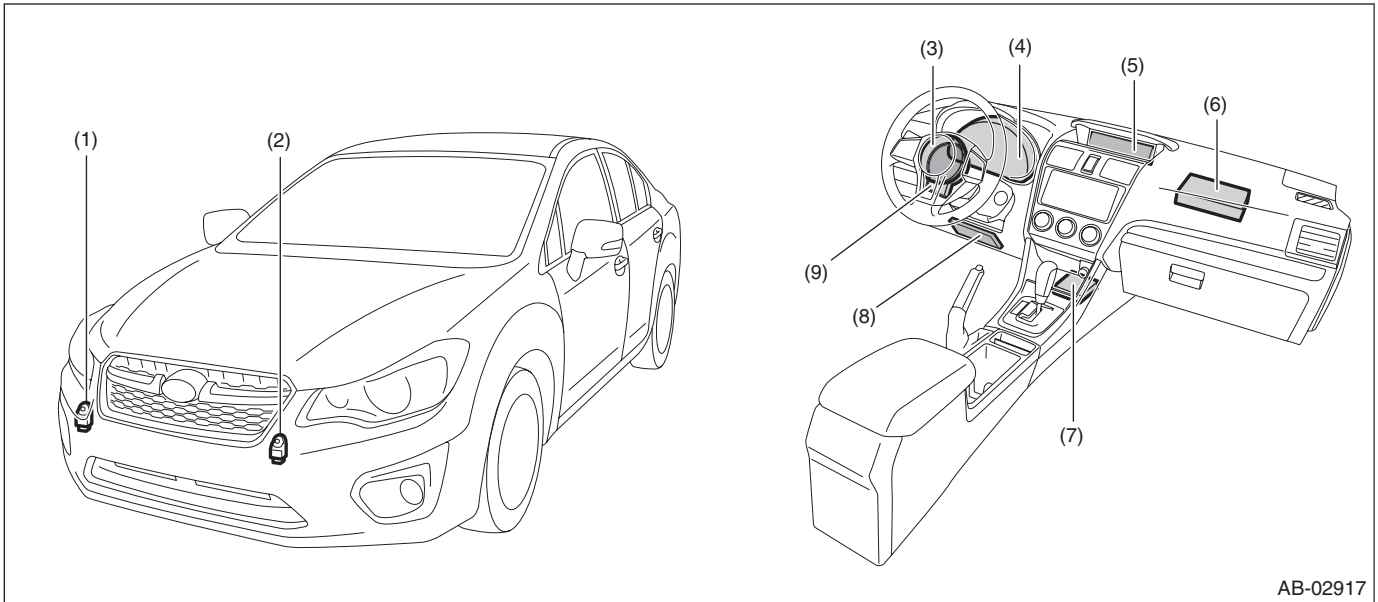

AB-02917

- (1) Front sub sensor RH
- (2) Front sub sensor LH
- (3) Driver's airbag module

- (4) Airbag warning light (in combination meter)
- (5) Airbag ON/OFF indicator light (MFD)
- (6) Passenger's airbag module

- (7) Airbag control module
- (8) Knee airbag module
- (9) Steering roll connector

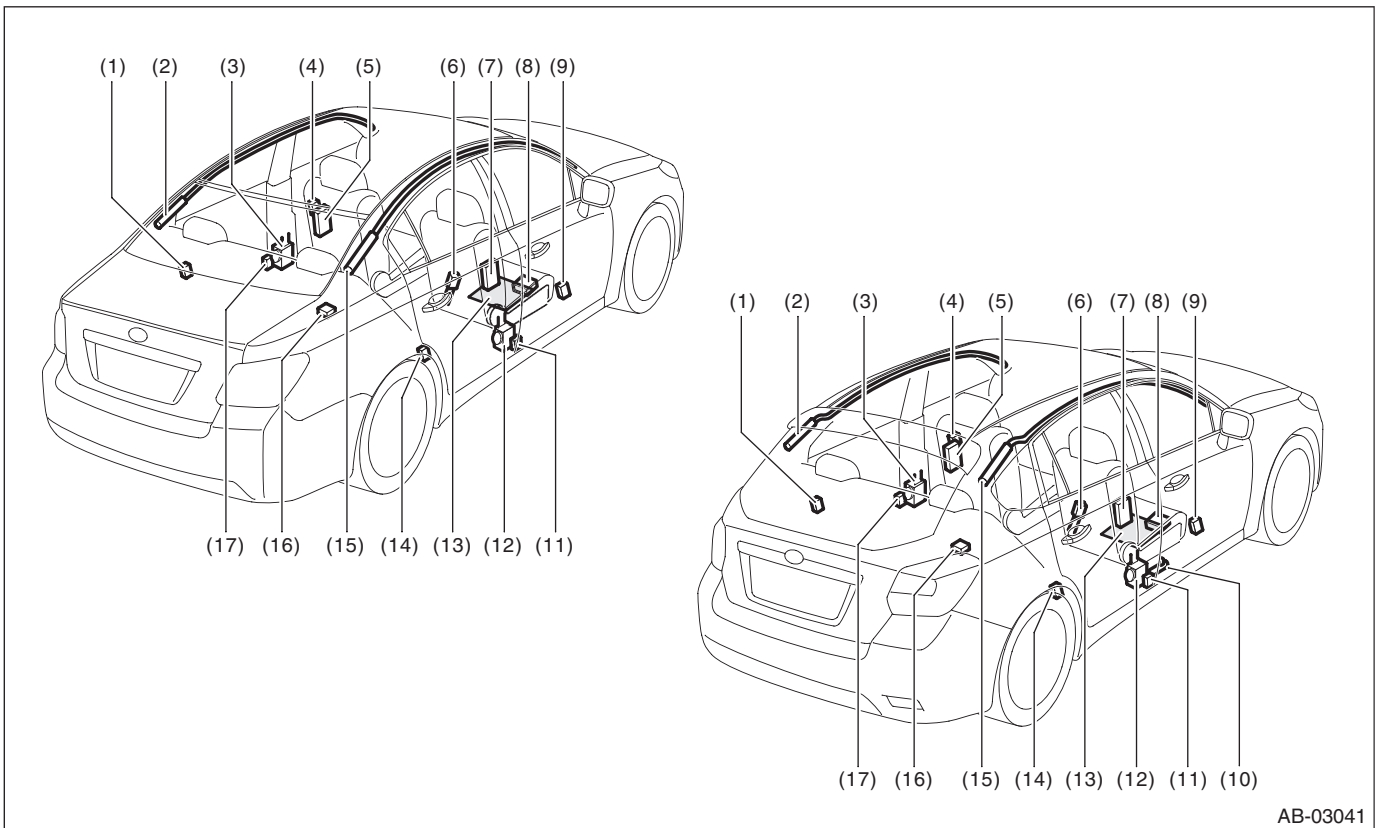

AB-03041

- | | | |
|---------------------------------|---|--------------------------------|
| (1) Curtain airbag sensor LH | (7) Side airbag module RH | (13) Occupant detection sensor |
| (2) Curtain airbag module LH | (8) Occupant detection control module | (14) Curtain airbag sensor RH |
| (3) Seat belt pretensioner LH | (9) Front door impact sensor RH | (15) Curtain airbag module RH |
| (4) Front door impact sensor LH | (10) Lap seat belt pretensioner RH (XV model) | (16) Satellite safing sensor |
| (5) Side airbag module LH | (11) Side airbag sensor RH | (17) Side airbag sensor LH |
| (6) Buckle switch RH | (12) Seat belt pretensioner RH | |