

EGR Pipe

EMISSION CONTROL (AUX. EMISSION CONTROL DEVICES)

7. EGR Pipe

A: REMOVAL

- 1) Disconnect the ground cable from battery.

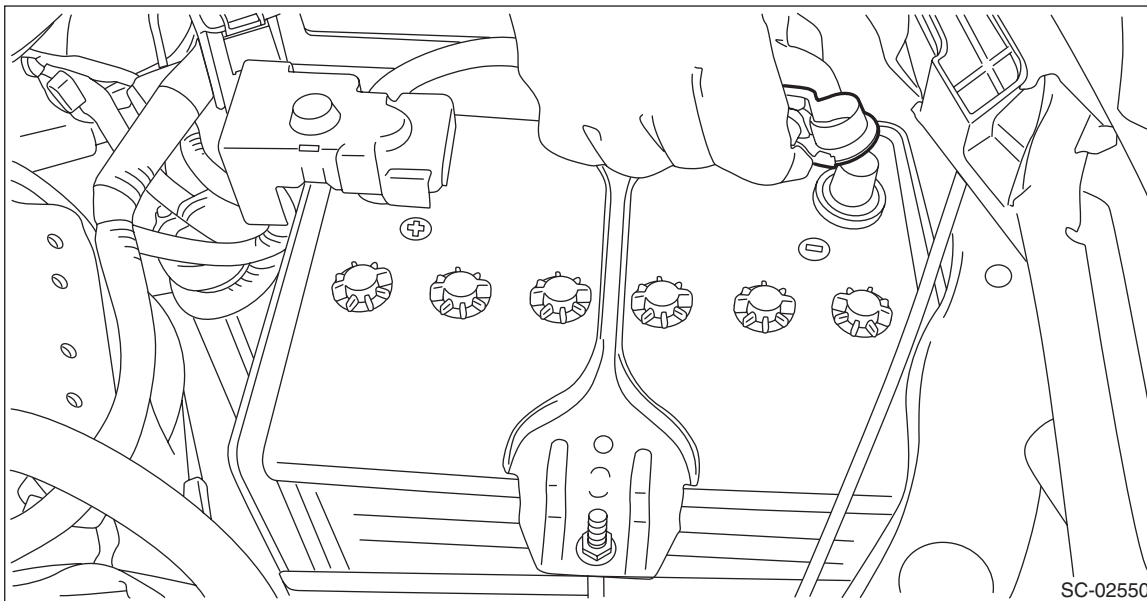

- 2) Remove the clip (A) from the air intake boot.
- 3) Loosen the clamp (B) connecting the air intake boot and air cleaner case (rear).
- 4) Loosen the clamp (C) which connects the air intake boot and throttle body.

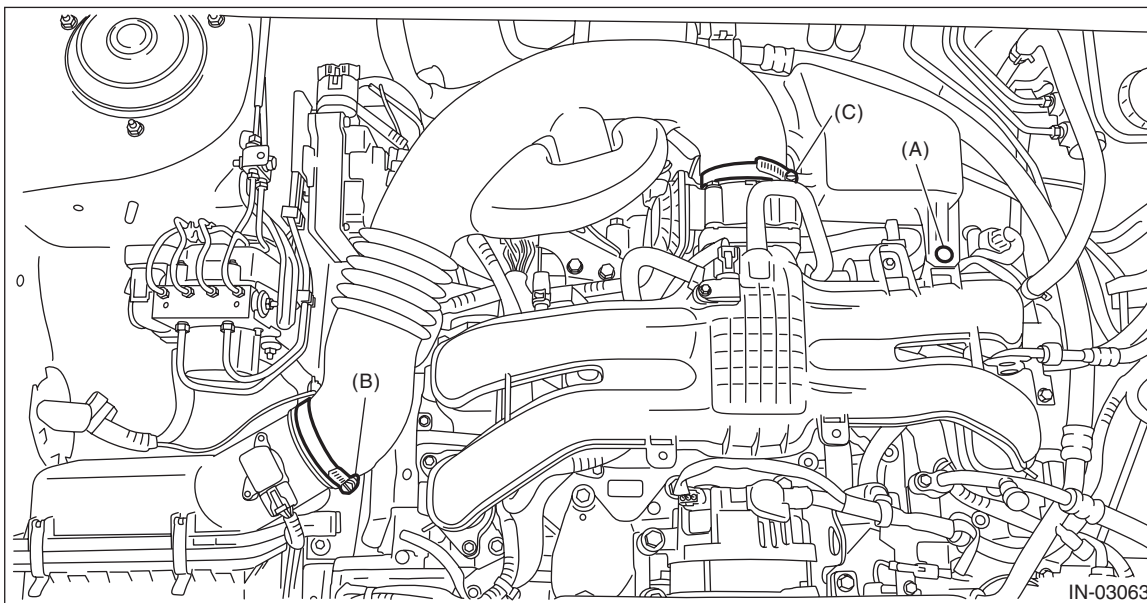

EGR Pipe

EMISSION CONTROL (AUX. EMISSION CONTROL DEVICES)

- 5) Remove the air intake boot from the throttle body, and move the air intake boot to the left side wheel apron.

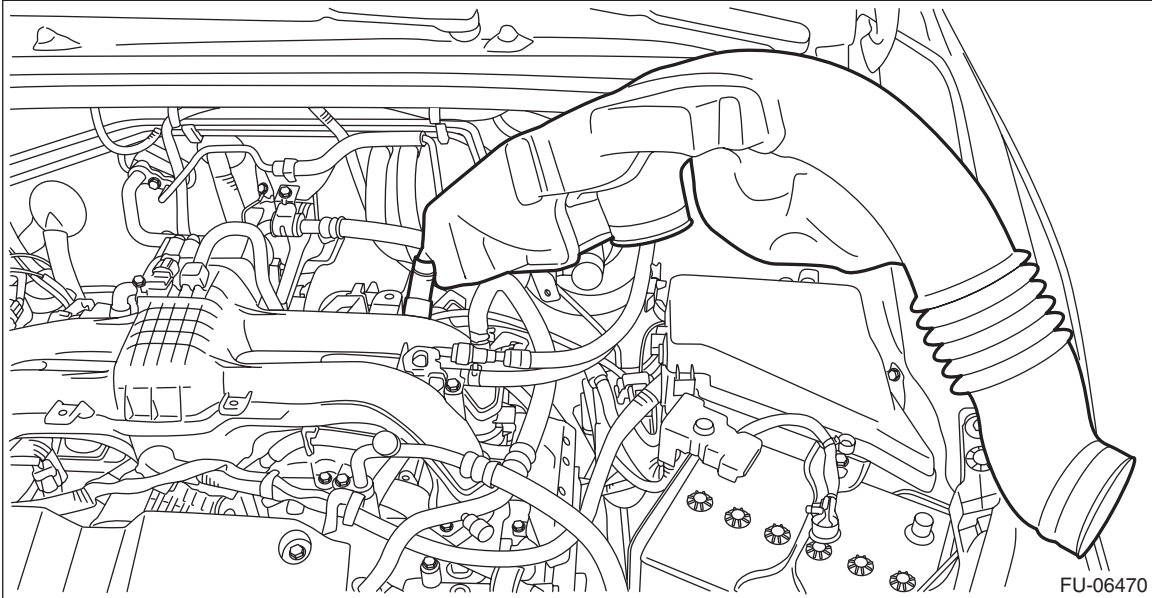

- 6) Remove the EGR pipe assembly from the water pipe assembly and the cylinder head RH.

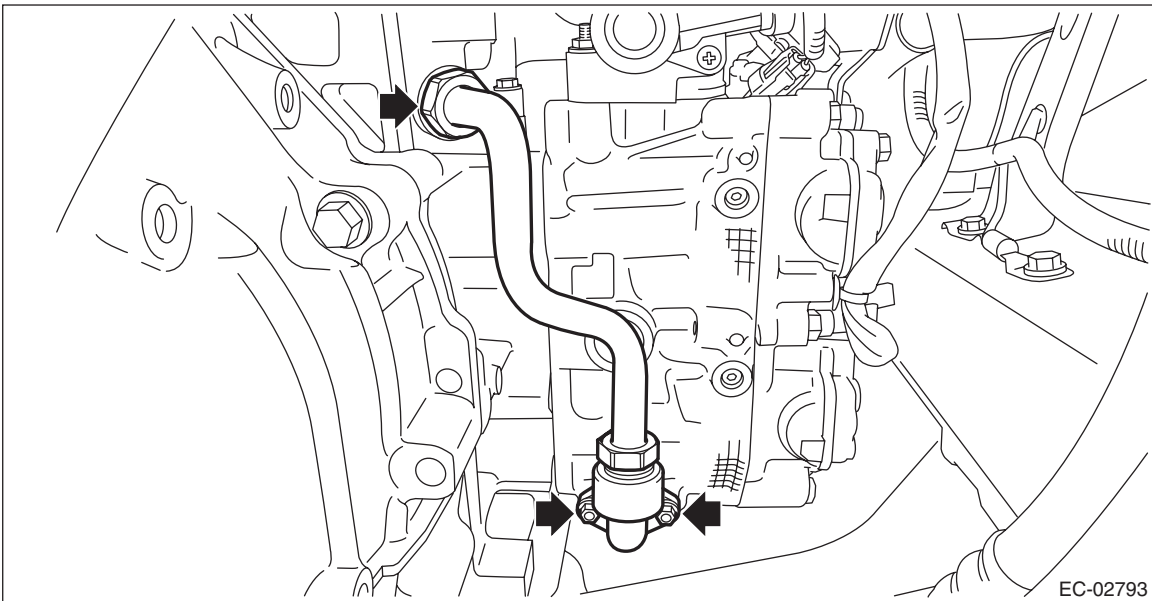

EGR Pipe

EMISSION CONTROL (AUX. EMISSION CONTROL DEVICES)

7) Remove the EGR pipe from EGR pipe adapter.

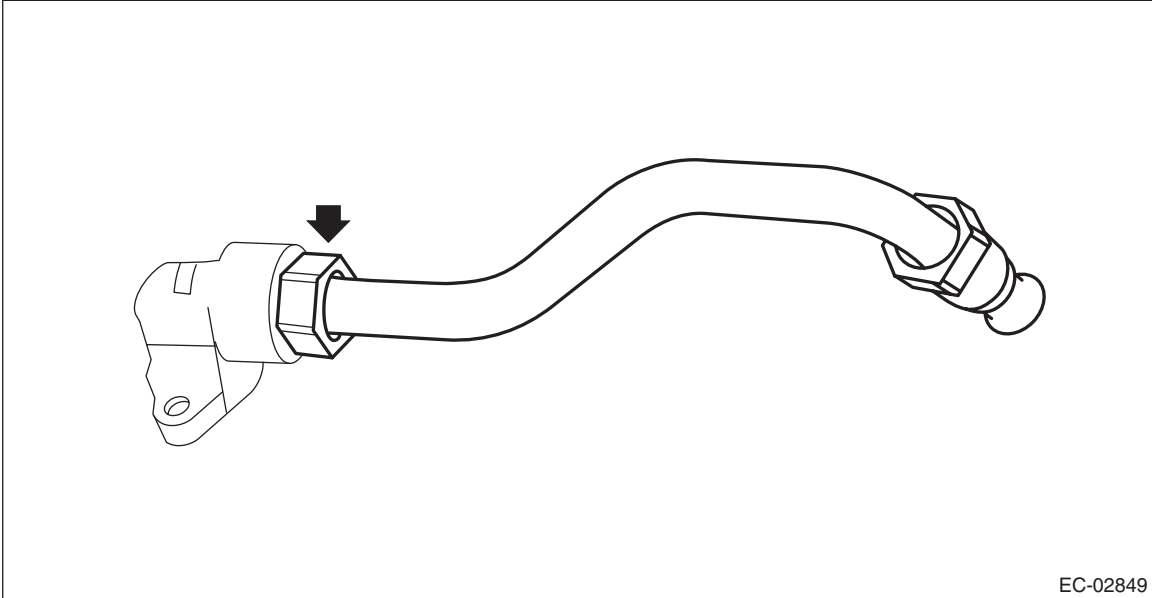

8) Disconnect the connector from the throttle body.

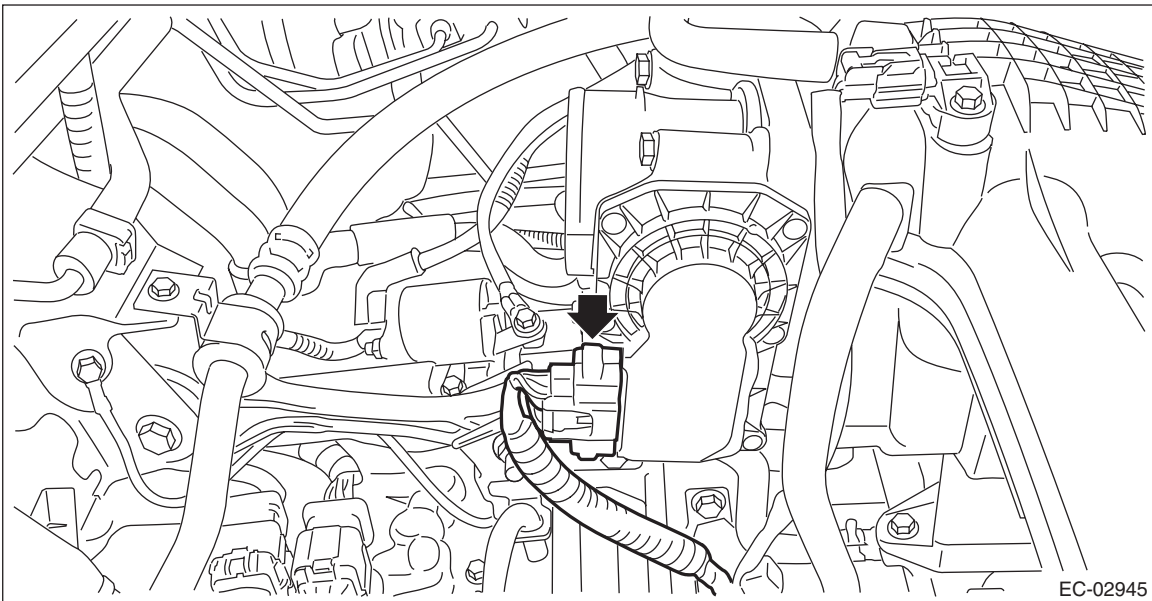

EGR Pipe

EMISSION CONTROL (AUX. EMISSION CONTROL DEVICES)

9) Remove the bolts which secure the throttle body to the intake manifold, and tilt the throttle body to the rear side of vehicle.

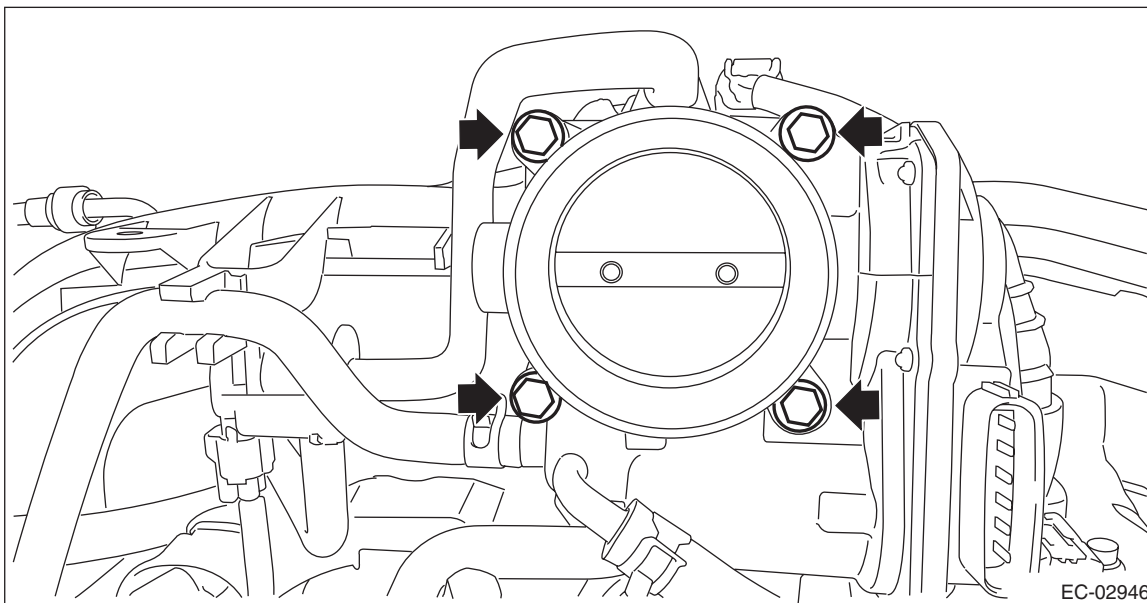

10) Remove the bolts and nuts that hold the EGR pipe to the intake manifold and the water pipe assembly, and remove the EGR pipe.

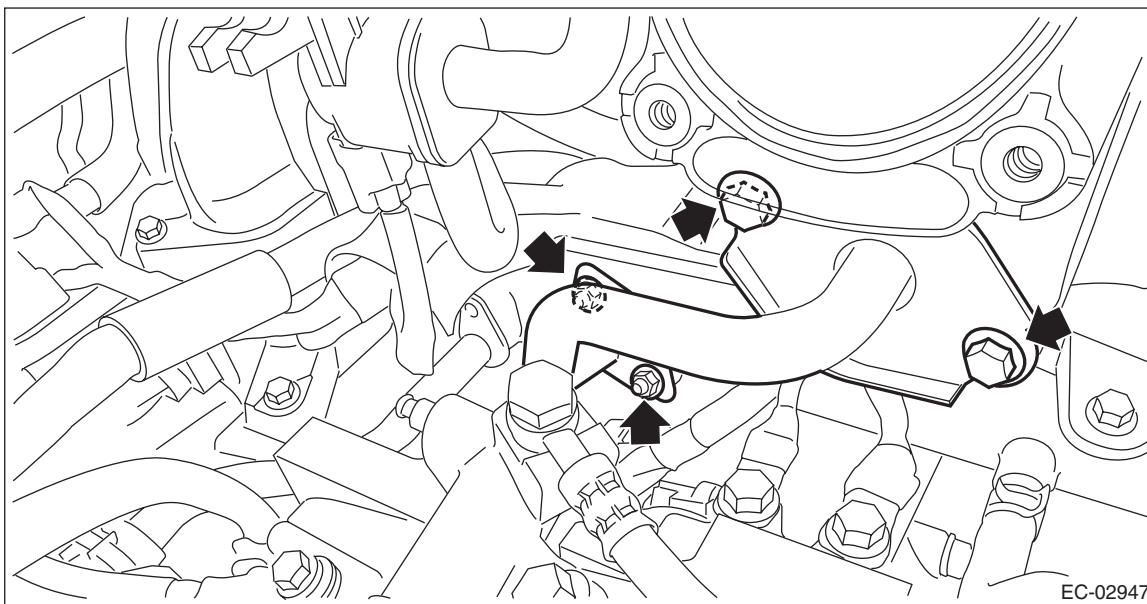

EGR Pipe

EMISSION CONTROL (AUX. EMISSION CONTROL DEVICES)

B: INSTALLATION

1) Temporarily install the EGR pipe to the intake manifold and water pipe assembly, and tighten the EGR pipe in numerical order as shown in the figure.

NOTE:

Use a new gasket.

Tightening torque:

6.4 N·m (0.7 kgf-m, 4.7 ft-lb)

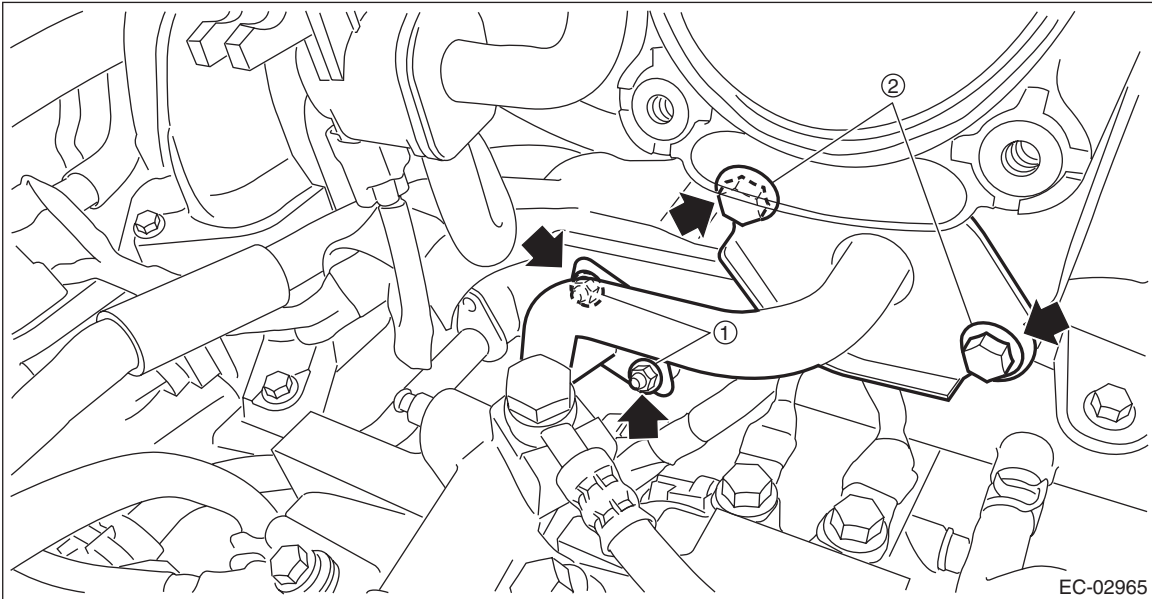

2) Install the throttle body to the intake manifold.

Tightening torque:

8.0 N·m (0.8 kgf-m, 5.9 ft-lb)

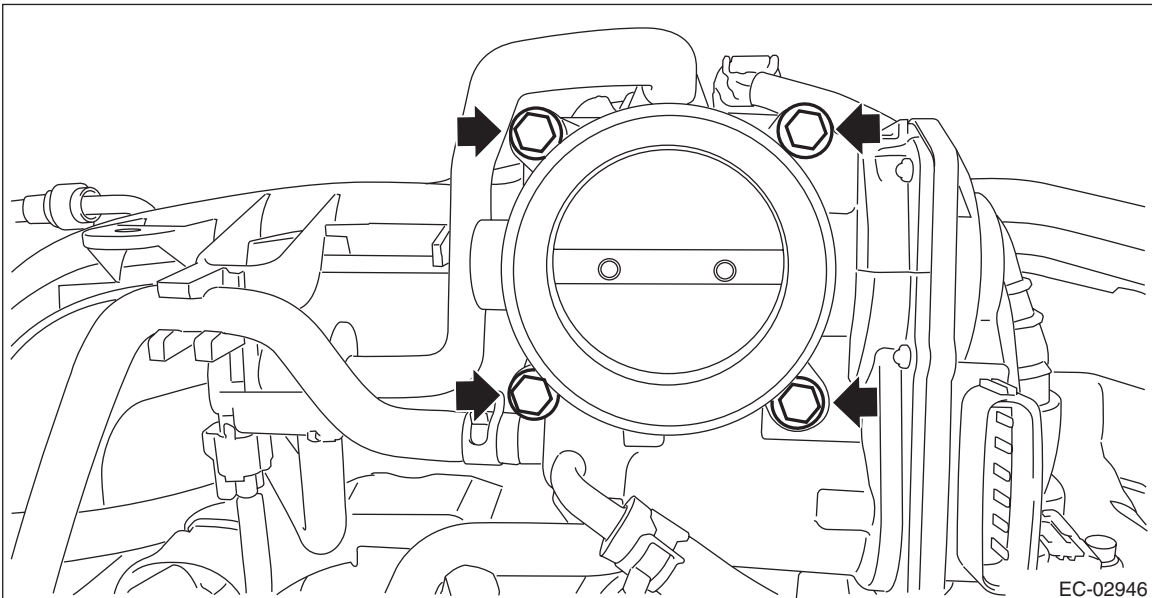

EGR Pipe

EMISSION CONTROL (AUX. EMISSION CONTROL DEVICES)

3) Connect the connector to the throttle body.

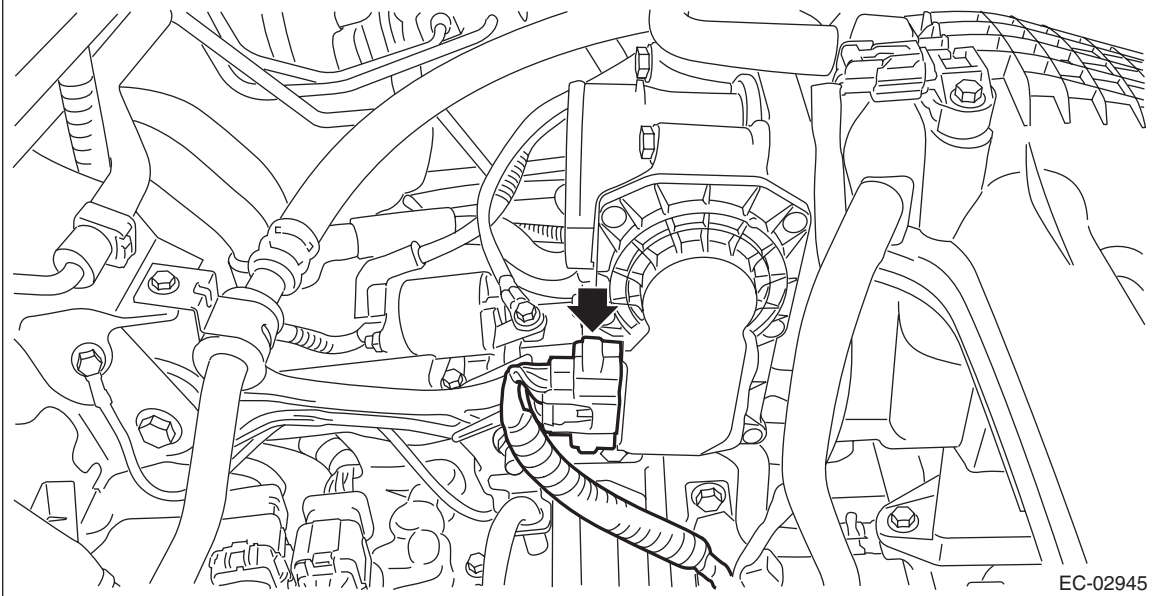

4) Temporarily install the EGR pipe to EGR pipe adapter.

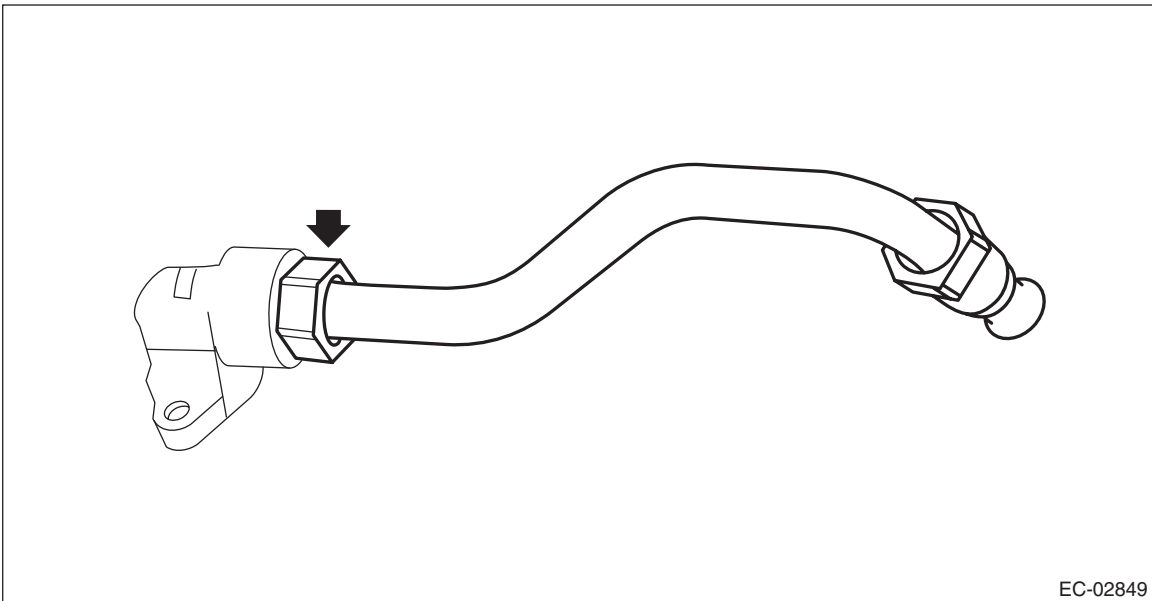

EGR Pipe

EMISSION CONTROL (AUX. EMISSION CONTROL DEVICES)

5) Temporarily install the EGR pipe assembly to the water pipe assembly and cylinder head assembly, and tighten the EGR pipe assembly in numerical order as shown in the figure.

Tightening torque:

T1: 6.4 N·m (0.7 kgf-m, 4.7 ft-lb)

T2: 51 N·m (5.2 kgf-m, 37.6 ft-lb)

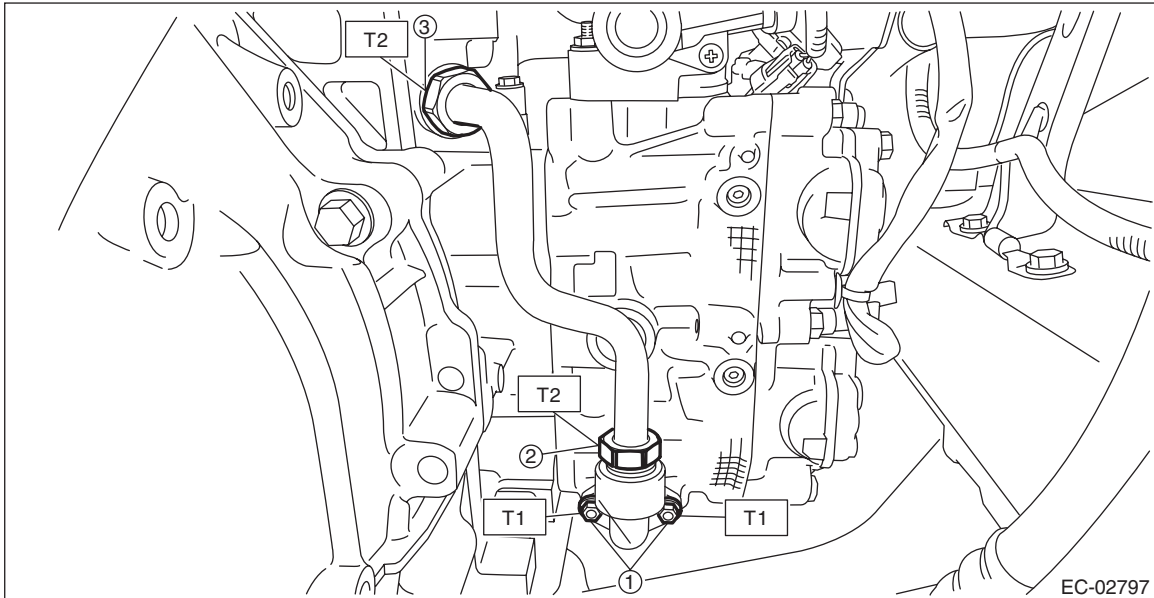

6) Install the air intake boot. <Ref. to IN(H4DO)-12, INSTALLATION, Air Intake Boot.>

7) Connect the battery ground terminal.

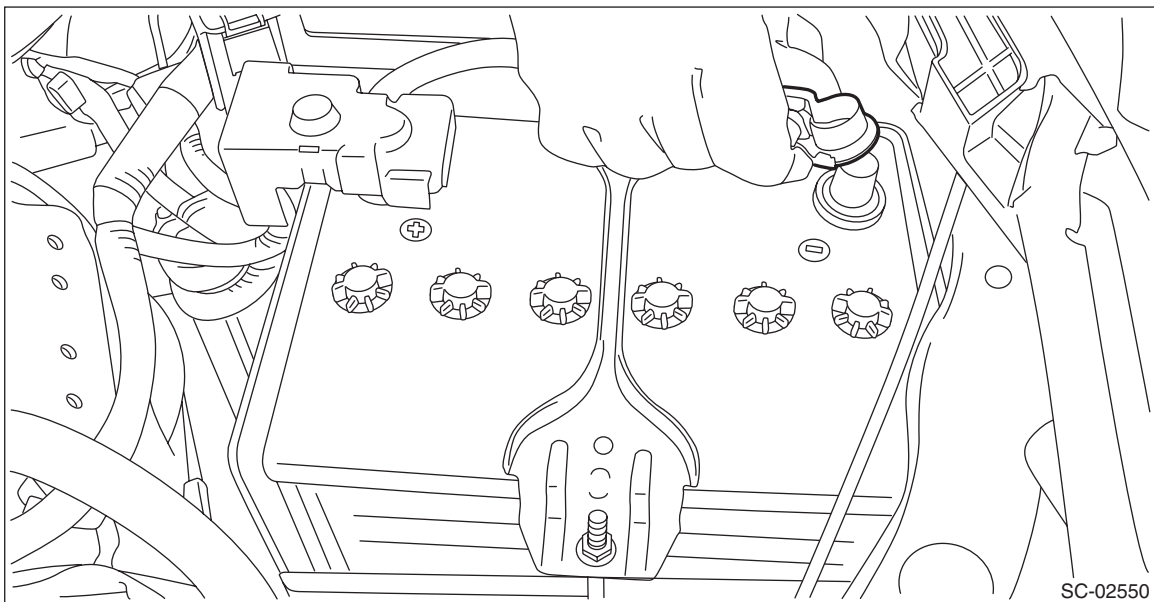

C: INSPECTION

Check that the EGR pipe assembly and EGR pipe have no deformation, cracks or other damages.