

23. Headlight System

A: WIRING DIAGRAM

H/L-01

H/L-01

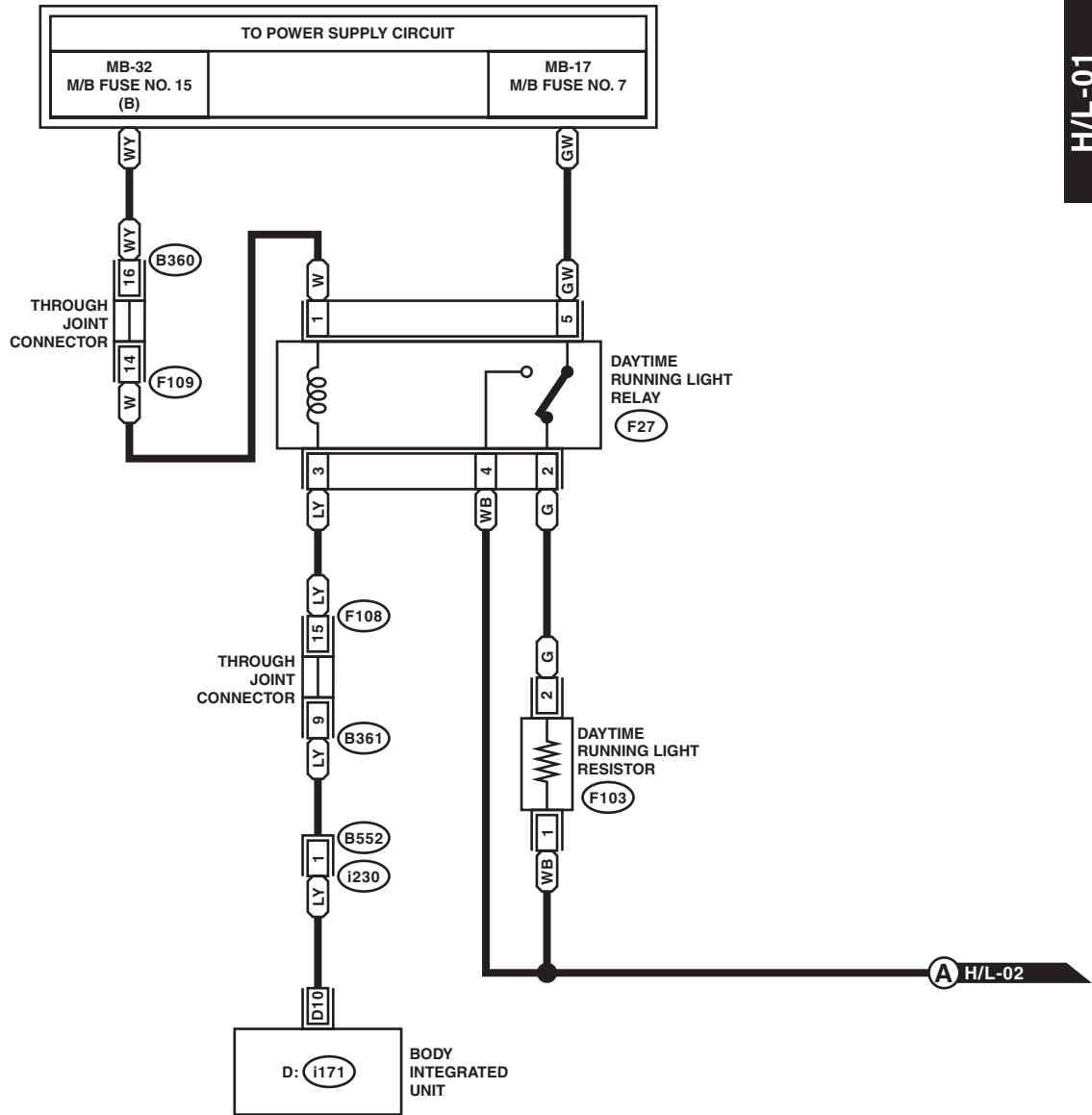

F103 (GRAY)



B361 (GRAY)



B360 (GRAY)

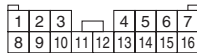

i230

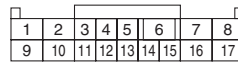

F108 (GRAY)



F109



D: i171

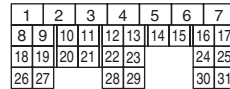

F27

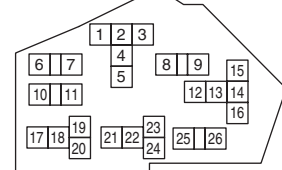

RELAY HOLDER

WI-37838

Headlight System

WIRING SYSTEM

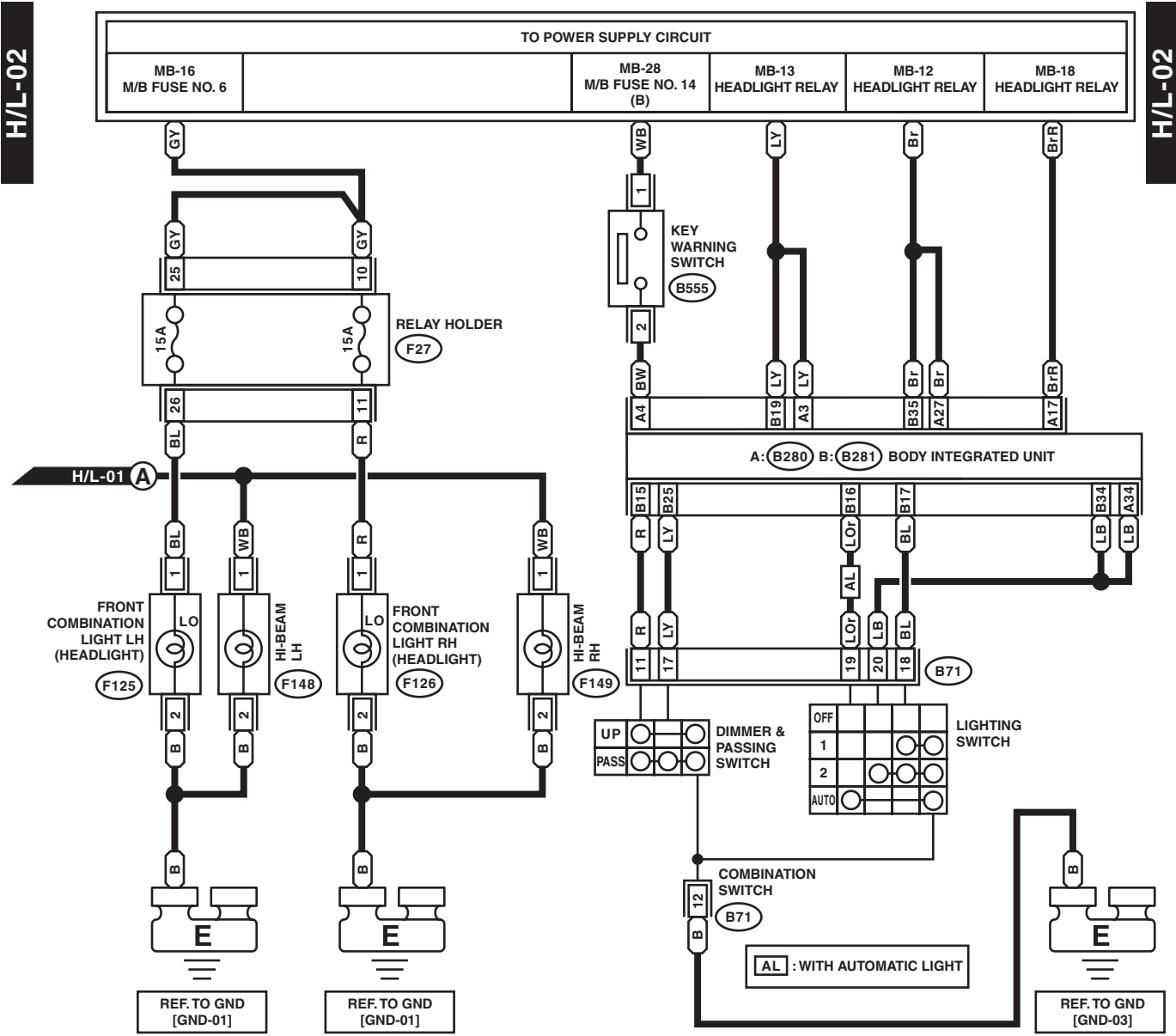

(B555)



(F148)



(F149)

A: (B280)

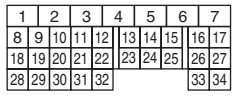

(F125) (LIGHT GRAY)

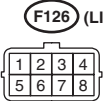

(F126) (LIGHT GRAY)

B: (B281)

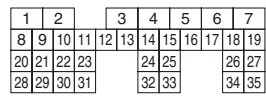

(B71)

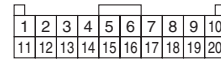

(F27)

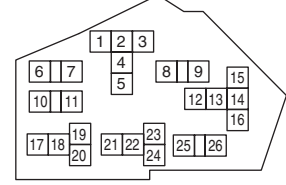

RELAY HOLDER

WI-34215

Headlight System

WIRING SYSTEM

H/L-03

H/L-03

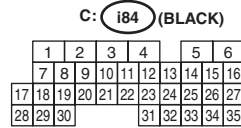
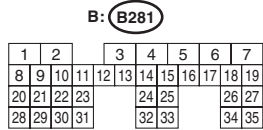
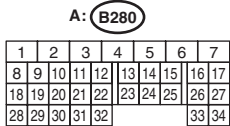
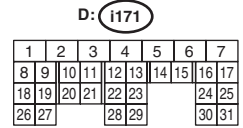
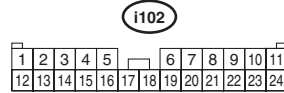
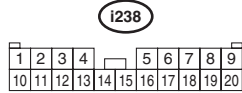
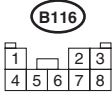
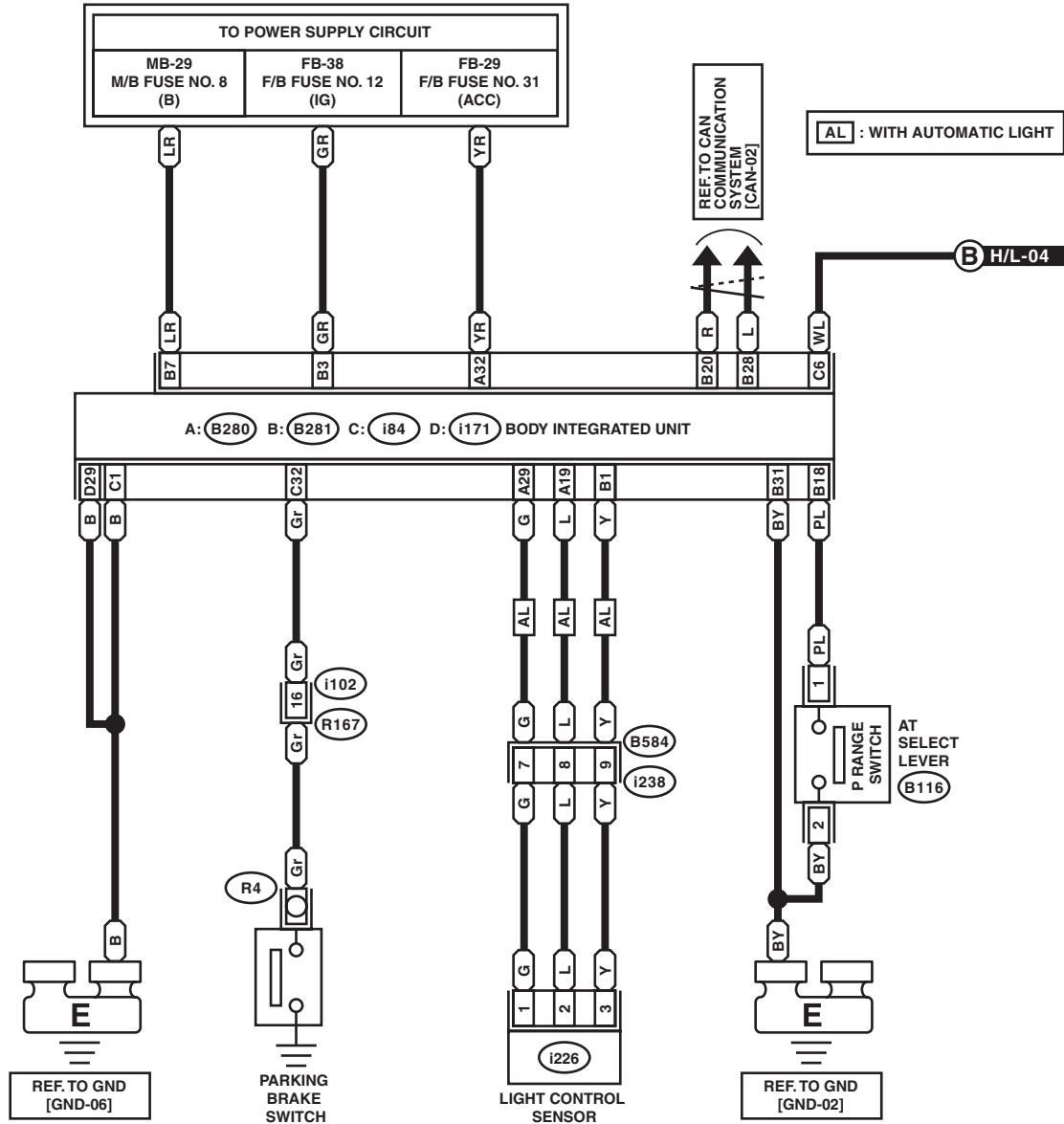

WI-34216

Headlight System

WIRING SYSTEM

H/L-04

H/L-04

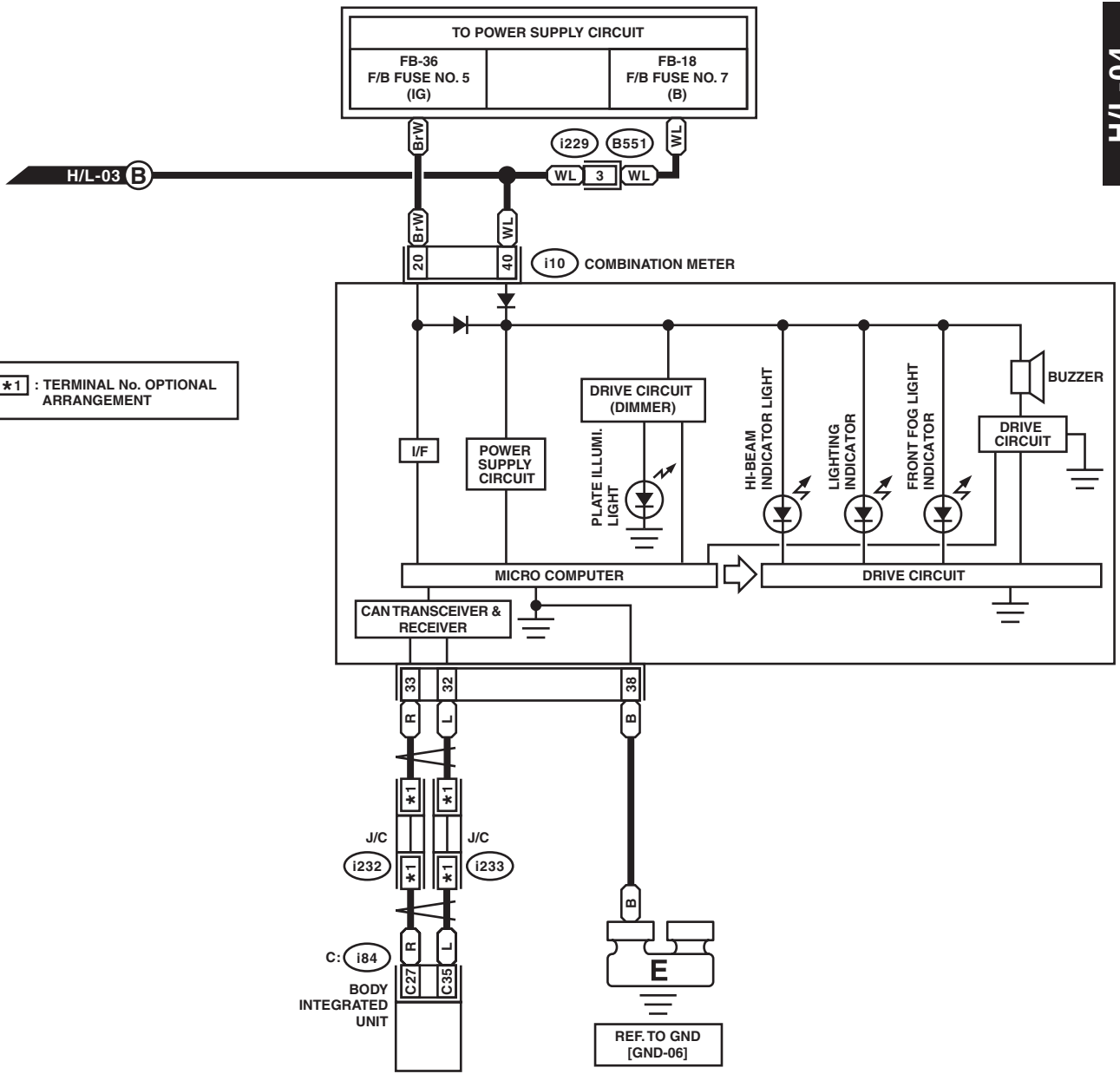

*1 : TERMINAL No. OPTIONAL ARRANGEMENT

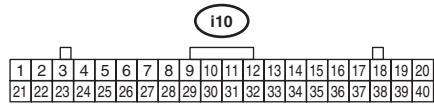
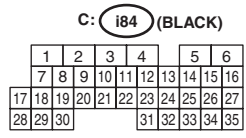
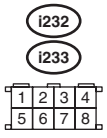

WI-35319