

## 1. Basic Diagnostic Procedure

### A: BASIC PROCEDURES

#### 1. GENERAL DESCRIPTION

The most important purpose of diagnostics is to quickly determine which part is malfunctioning, to save time and labor.

#### 2. IDENTIFICATION OF TROUBLE SYMPTOM

Determine what the problem is based on the symptom.

#### 3. PROBABLE CAUSE OF TROUBLE

Look at the wiring diagram and check the system's circuit. Then check the switch, relay, fuse, ground, etc.

#### 4. LOCATION AND REPAIR OF TROUBLE

- 1) Using the diagnostics, narrow down the causes.
- 2) If necessary, use a voltmeter, ohmmeter, etc.
- 3) Before replacing certain component parts (switch, relay, etc.), check the power supply, ground, for open wiring harness, poor connectors, etc. If no problem is encountered, check the component parts.

#### 5. SYSTEM OPERATION CHECK

After repairing, ensure that the system operates properly.

### B: BASIC INSPECTION

#### 1. VOLTAGE MEASUREMENT

- 1) Using a voltmeter, connect the negative lead to a good ground point or negative battery terminal and the positive lead to the connector or component terminal.
- 2) Contact the positive lead of the voltmeter on connector (A). The voltmeter will indicate a voltage.
- 3) Touch connector (B) with the positive probe. The voltmeter will indicate no voltage.

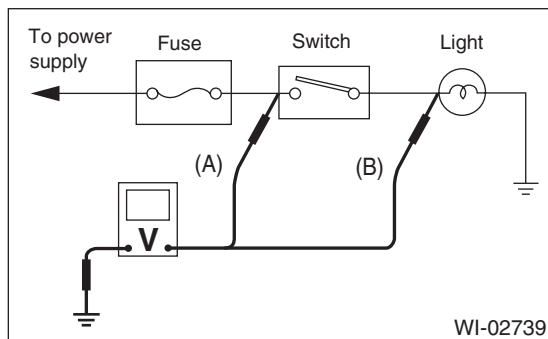

- 4) With the test set-up held as it is, turn the switch to ON. The voltmeter will indicate a voltage and, at the same time, the light will illuminate.

- 5) The circuit is in good order. If a problem such as a light failing to illuminate occurs, use the procedures outlined above to track down the malfunction.

#### 2. CIRCUIT CONTINUITY CHECKS

- 1) Disconnect the battery terminal or connector so there is no voltage between the check points. Contact the two leads of an ohmmeter to each of the check points.

If the circuit has diodes, reverse the two leads and check again.

- 2) Use an ohmmeter to check for diode continuity. When contacting the negative lead to the diode positive side and the positive lead to the negative side, there should be continuity.

When contacting the two leads in reverse, there should be no continuity.

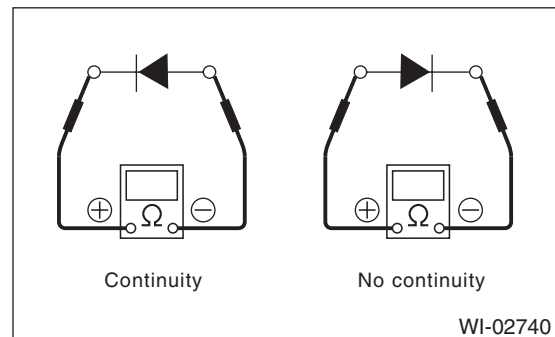

- 3) The symbol "○ — ○" indicates that continuity exists between two points or terminals. For example, when a switch position is at "3", continuity exists among terminals 1, 3 and 6, as shown in the table below.

Terminal	Switch Position					
Switch Position	1	2	3	4	5	6
OFF						
1	○ — ○				○ — ○	
2	○ — ○			○ — ○		
3	○ — ○		○ — ○			○ — ○
4	○ — ○	○ — ○				○ — ○

WI-02741

# Basic Diagnostic Procedure

## WIRING SYSTEM

### 3. HOW TO DETERMINE AN OPEN CIRCUIT

#### 1) WITH VOLTMETER:

An open circuit is determined by measuring the voltage between respective connectors and ground using a voltmeter, starting with the connector closest to the power supply. The power supply must be turned ON so that current flows in the circuit. If voltage is not present between a particular connector and ground, the circuit between that connector and the previous connector is open.

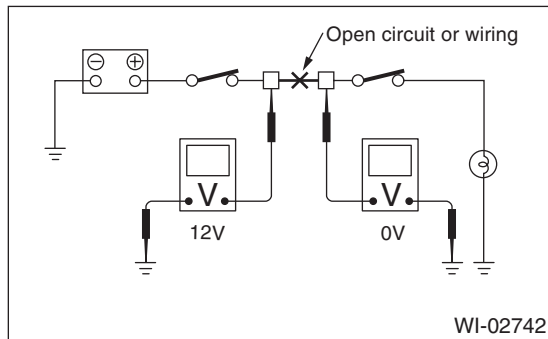

#### 2) WITH OHMMETER:

Disconnect all connectors affected, and check continuity in the wiring between adjacent connectors. When the ohmmeter indicates "infinite", the wiring is open.

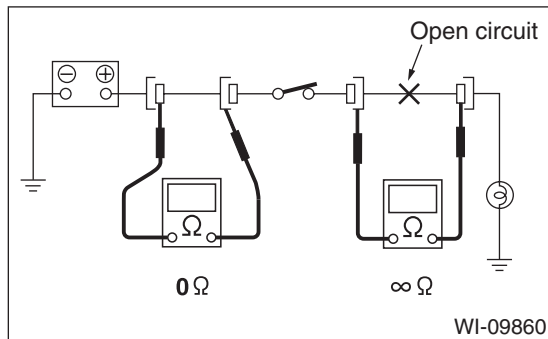

### 4. HOW TO DETERMINE A SHORT CIRCUIT

#### 1) WITH TEST LIGHT:

Connect a test light (rated at approx. 3 watts) in place of the blown fuse and allow current to flow through the circuit. Disconnect one connector at a time from the circuit. Starting with the one located farthest from the power supply. If the test light goes out when a connector is disconnected, the wiring between that connector and the next connector (farther from the power supply) is shorted.

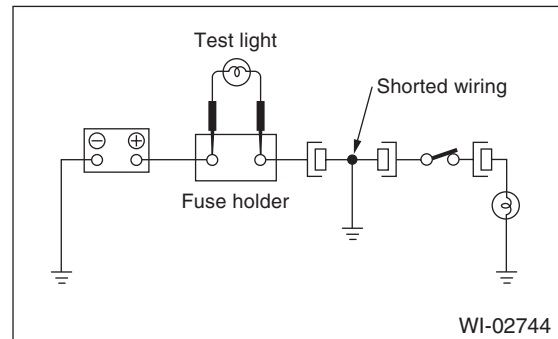

#### 2) WITH OHMMETER:

Disconnect all affected connectors, and check continuity between each connector and ground. When the ohmmeter indicates continuity between a particular connector and a ground, that connector is shorted.

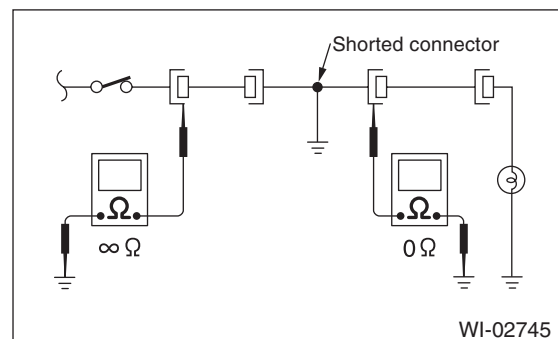

## C: HOW TO READ WIRING DIAGRAMS

### 1. WIRING DIAGRAM

The wiring diagram of each system is illustrated so that you can understand the path through which the electric current flows from the battery.

Sketches and codes are used in the diagrams. They should read as follows:

- Each connector and its terminal position are indicated by a sketch of the connector in a disconnected state which is viewed from the front.

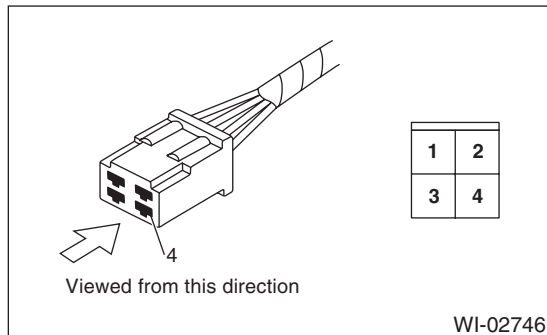

- The number of poles or pins, presence of a lock are indicated in the sketch of each connector. In the sketch, the highest pole number refers to the number of poles which the connector has. For example, the sketch of the connector shown in figure indicates the connector has 9 poles.

Connector used in vehicle	Connector shown in wiring diagram										
	Sketch	Symbol	Number of poles								
	<p>Double frames</p> <p>Indicates a lock is included.</p> <table border="1"> <tr> <td>4</td> <td>3</td> <td>2</td> <td>1</td> </tr> <tr> <td>9</td> <td>8</td> <td>7</td> <td>6</td> </tr> </table> <p>Indicates the number of poles.</p>	4	3	2	1	9	8	7	6		Numbered in order from upper right to lower left.
4	3	2	1								
9	8	7	6								
	<p>Indicates a lock is included.</p> <table border="1"> <tr> <td>1</td> <td>2</td> <td>3</td> <td>4</td> </tr> <tr> <td>5</td> <td>6</td> <td>7</td> <td>8</td> </tr> </table> <p>Single frame</p>	1	2	3	4	5	6	7	8		Numbered in order from upper left to lower right.
1	2	3	4								
5	6	7	8								

WI-02747

# Basic Diagnostic Procedure

## WIRING SYSTEM

- When one set of connectors is viewed from the front side, the pole numbers of one connector are symmetrical to those of the other. When these two connectors are connected as a unit, the poles which have the same number are joined.

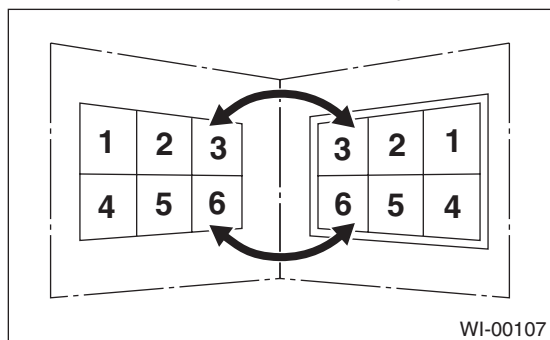

### • WIRING DIAGRAM:

The connectors are numbered along with the number of poles, external colors, and mating connections in the accompanying list.

- The sketch of each connector in the wiring diagram usually shows the (A) side of the connector. The relationship between the wire color, terminal number and connector is described in the figure.

### NOTE:

A wire which runs in one direction from a connector terminal sometimes may have a different color from that which runs in the other direction from that terminal.

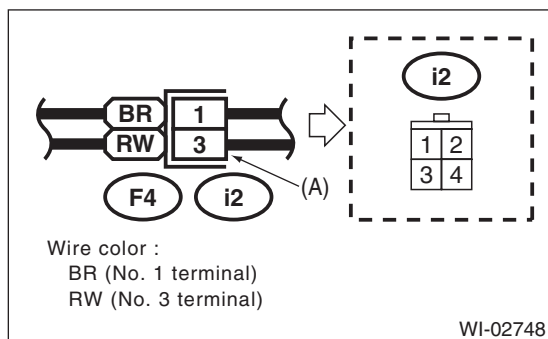

- In the wiring diagram, connectors which have no terminal number refer to one-pole types. Sketches of these connectors are omitted intentionally.

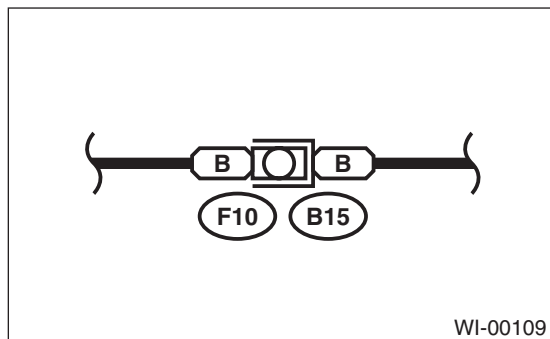

- The following color codes are used to indicate the colors of the wires.

Color code	Color
L	Blue
B	Black
Y	Yellow
G	Green
R	Red
W	White
Br	Brown
Lg	Light green
Gr	Gray
P	Pink
Or	Orange
Sb	Light blue
V	Violet
SA	Sealed (inner)
SB	Sealed (outer)

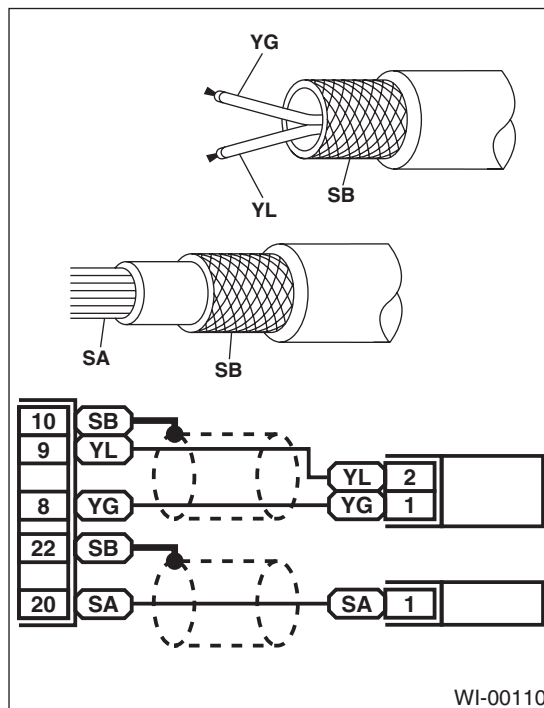

- The wire color code, which consists of two letters (or three letters including Br or Lg), indicates the standard color (base color of the wire covering) by its first letter and the stripe marking by its second letter.

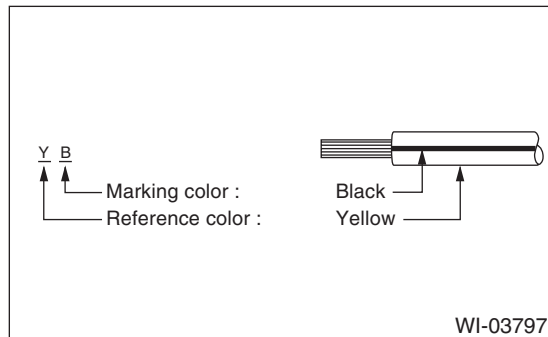

- The table lists the nominal sectional areas and allowable currents of the wires.

### CAUTION:

**When replacing or repairing a wire, be sure to use the same size and type of the wire which was originally used.**

### NOTE:

- The allowable current in the table indicates the tolerable amperage of each wire at an ambient temperature of 40°C (104°F).
- The allowable current changes with ambient temperature. Also, it changes if a bundle of more than two wires is used.

Nominal sectional area mm <sup>2</sup>	No. of strands/ strand diameter	Outside diameter of wiring mm	Allowable current Amps/ 40°C (104°F)
0.3	7/0.26	1.8	7
0.5	7/0.32	2.2 (or 2.0)	12
0.75	30/0.18	2.6 (or 2.4)	16
0.85	11/0.32	2.4 (or 2.2)	16
1.25	16/0.32	2.7 (or 2.5)	21
2	26/0.32	3.1 (or 2.9)	28
3	41/0.32	3.8 (or 3.6)	38
5	65/0.32	4.6 (or 4.4)	51
8	50/0.45	5.5	67

- Each unit is either directly grounded to the body or indirectly grounds through a harness ground terminal. Different symbols are used in the wiring diagram to identify the two grounding systems.

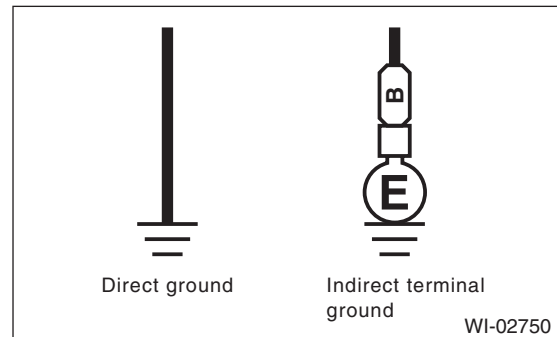

- The ground points shown in the wiring diagram refer to the following:

### NOTE:

All wiring harnesses are provided with a ground point which must be securely connected.

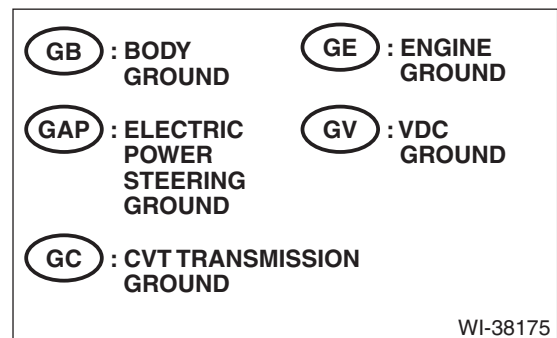

# Basic Diagnostic Procedure

## WIRING SYSTEM

- Relays are classified as normally-open or normally-closed.
- The normally-closed relay has one or more contacts. The wiring diagram shows the relay mode when the energizing circuit is OFF.

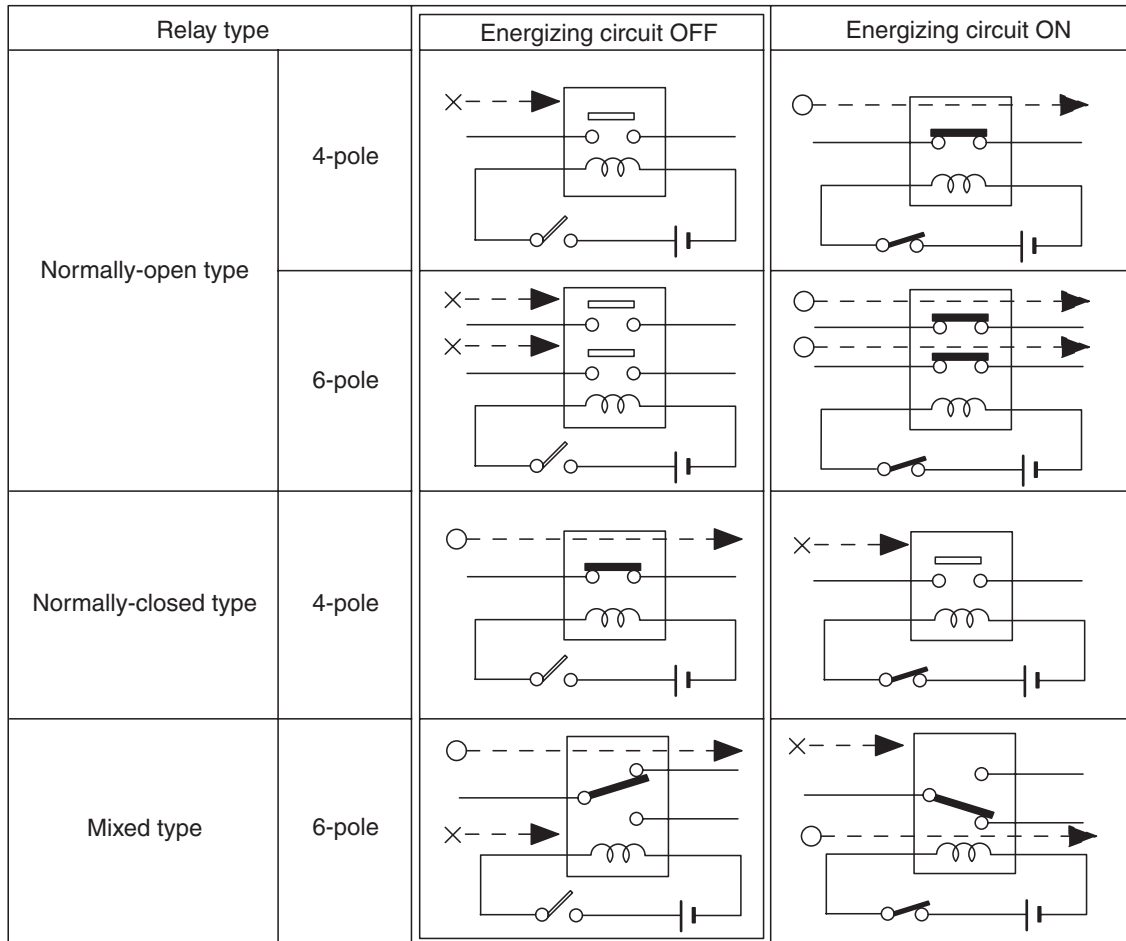

Key to symbols:

○ —▶ : Current flows.

× —▶ : Current does not flow.

WI-16724

- Each connector number shown in the wiring diagram corresponds to that in the wiring harness. The location of each connector in the actual vehicle is determined by reading the first character of the connector (for example, a "F" for F8, "i" for i16, etc.) and the type of wiring harness. The first character of each connector number corresponds to the area or system of the vehicle.

Symbol	Wiring harness and cord
F	Front wiring harness
B	Bulkhead wiring harness
E	Engine wiring harness
T	Transmission cord
D	Door cord LH & RH, Rear gate cord Rear door cord LH & RH, Rear defogger cord
i	Instrument panel wiring harness
R	Rear wiring harness, Fuel tank cord, Roof cord, Rear gate cord
AB	Airbag wiring harness

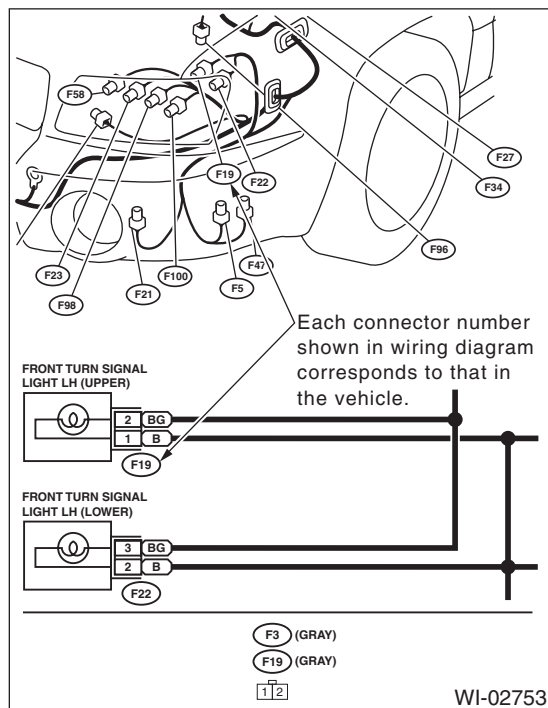

# Basic Diagnostic Procedure

## WIRING SYSTEM

### D: SYMBOLS IN WIRING DIAGRAMS

A number of symbols are used in each wiring diagram to easily identify parts or circuits.

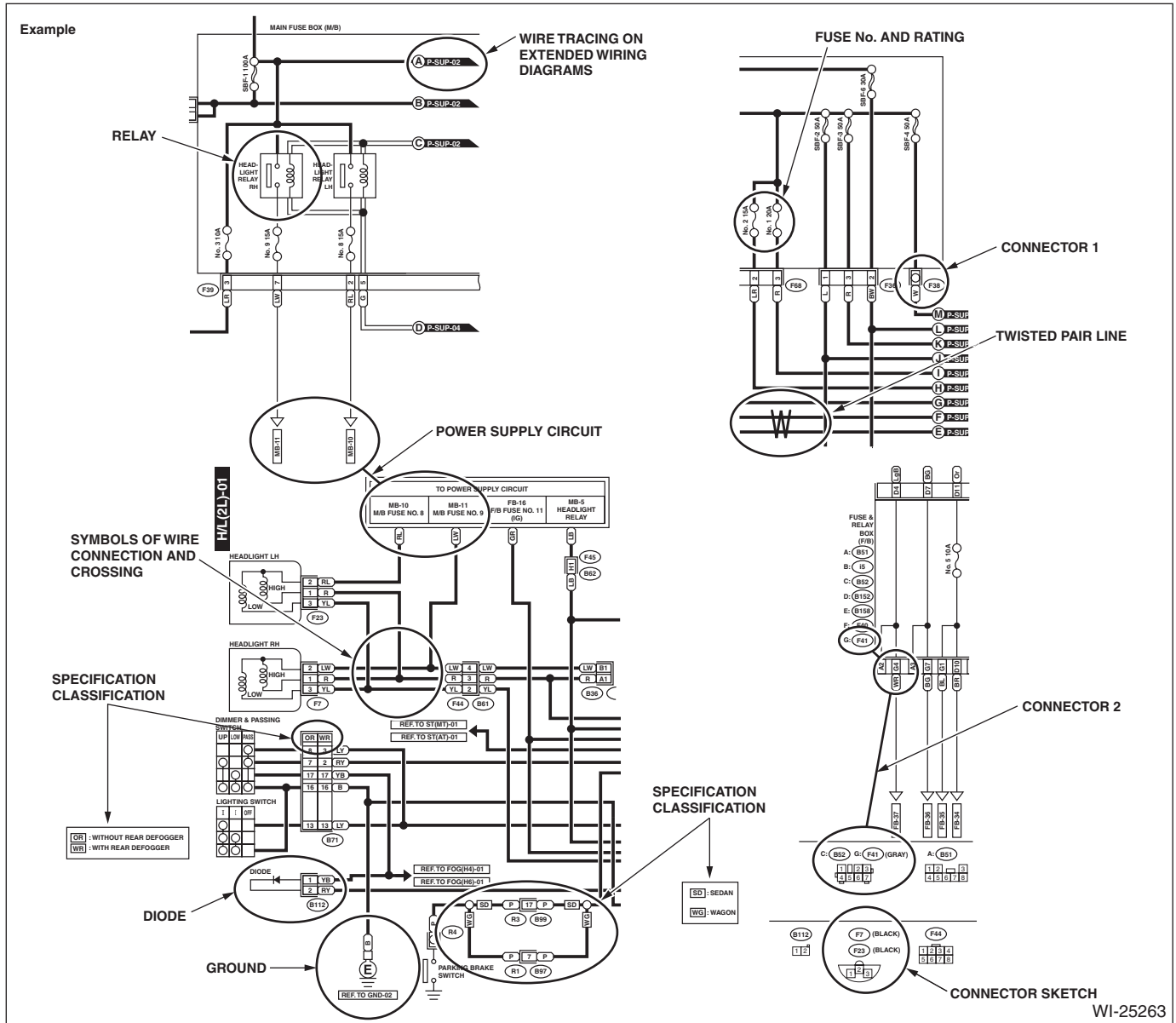



### 1. RELAY

A symbol used to indicate a relay.

### 2. CONNECTOR 1

The sketch of the connector indicates the one-pole types.

### 3. WIRING CONNECTION

Some wiring diagrams are indicated in foldouts for convenience. Wiring destinations are indicated where necessary by corresponding symbols. (When two pages are needed for clear indication)

### 4. FUSE NO. & RATING

The "FUSE No. & RATING" corresponds with that used in the fuse box (main fuse box, fuse and joint box).

### 5. CONNECTOR 2

- Each connector is indicated by a symbol.
- Each terminal number is indicated in the corresponding wiring diagram in an abbreviated form.
- For example, terminal number "G4" refers to No. 4 terminal of connector (G: F41) shown in the connector sketch.

### 6. CONNECTOR SKETCH

- Each connector sketch clearly identifies the shape and color of a connector as well as terminal locations. Non-colored connectors are indicated in natural color.
- When more than two types of connector number are indicated in a connector sketch, it means that the same type connectors are used.

### 7. GROUND

Each grounding point can be located easily by referring to the corresponding wiring harness.

### 8. DIODE

A symbol is used to indicate a diode.

### 9. WIRE TRACING ON EXTENDED WIRING DIAGRAMS

For a wiring diagram extending over at least two pages, a symbol (consisting of the same characters with arrows), facilitates wire tracing from one page to the next.

A ↔ A, B ↔ B

### 10. SYMBOLS OF WIRE CONNECTION AND CROSSING

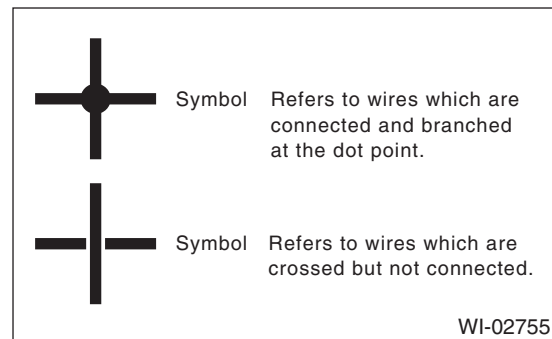

### 11. POWER SUPPLY CIRCUIT

A symbol is used to indicate the power supply in each wiring diagram.

"MB - 5", "MB - 6", etc., which are used as power-supply symbols throughout the text, correspond with those shown in the "DC POWER SUPPLY CIRCUIT" in the wiring diagram.

Accordingly, using the "DC POWER SUPPLY CIRCUIT" and wiring diagrams permits service personnel to understand the entire electrical arrangement of a system.

### 12. CLASSIFICATION BY SPECIFICATION

When the wiring diagram differ according to vehicle specifications, the specification difference is described by using abbreviations.

### 13. TWISTED PAIR LINE

The twisted pair line is indicated by a symbol in the wiring diagrams.

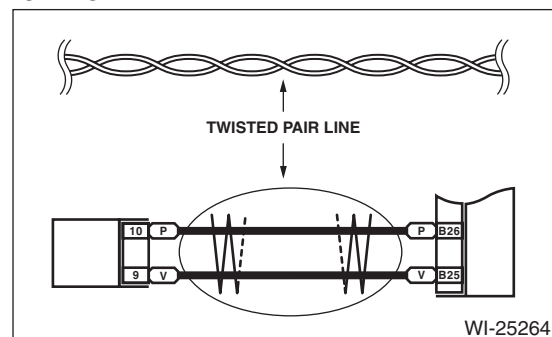











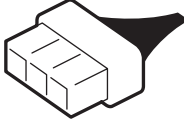

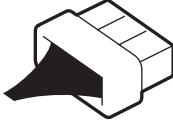
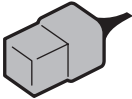
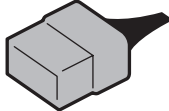
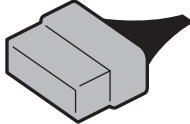

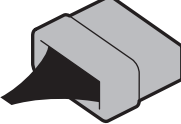



# Basic Diagnostic Procedure

## WIRING SYSTEM

### E: CONNECTOR SYMBOL IN WIRING HARNESS

A number of connector symbols are used in each wiring diagram to easily identify the wiring harness connectors.

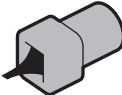
Standard type: Female		
Pole: From 1 to 8	Pole: From 9 to 20	Pole: More than 21
		
		
Standard type: Male		
		
		

Water proof type: Female		
Pole: From 1 to 8	Pole: From 9 to 20	Pole: More than 21
		
		
Water proof type: Male		
		
		

WI-02756

## F: ABBREVIATION IN WIRING DIAGRAMS

Abbr.	Full name
ABS	Anti-lock Brake System
ACC	Accessory
A/C	Air Conditioner
ASSY	Assembly
AT	Automatic Transmission
A/F	Air/Fuel (Air fuel ratio sensor)
ATF	Automatic Transmission Fluid
AUX	Auxiliary Audio Input Terminal
AWD	All Wheel Drive
B	Battery
CAN	Controller Area Network
CM	Control Module
CVT	Continuously Variable Transmission
D	Drive range or Down
DN	Down
E	Ground
ELCM	Evaporative Leak Check Module
ECO	Economy
ECM	Engine Control Module
EEPROM	Electrically Erasable Programmable Read-Only Memory
EGR	Exhaust Gas Recirculation
F/B	Fuse & Relay Box
FL	Front Left
FR	Front Right
G	Gravity (G sensor)
H/L	Headlight
HI	High
I/F	Interface
IG	Ignition
INT	Intermittent
ISO	International Organization for Standardization
J/C	Joint Connector
LCD	Liquid Crystal Display
LH	Left Hand
LO	Low
LWR	Lower
M	Motor
M/B	Main Fuse Box
MFD	Multi Function Display
MT	Manual Transmission
N	Neutral Range
NAVI	Navigation
OP	Open or Optional Parts
P	Parking or Parking range
PASS	Passing
PCV	Positive Crankcase Ventilation Valve
R	Reverse Range

Abbr.	Full name
RH	Right Hand
RL	Rear Left
RR	Rear Right
SBF	Slow Blow Fuse
ST	Starter
SW	Switch
TCM	Transmission Control Module
TFT	Thin Film Transistor
TPMS	Tire Pressure Monitor System
UPR	Upper
VDC	Vehicle Dynamics Control
WASH	Washer