

23. Headlight System

A: WIRING DIAGRAM

H/L-01

H/L-01

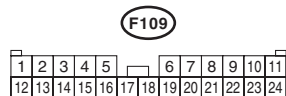
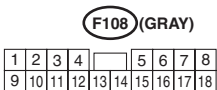
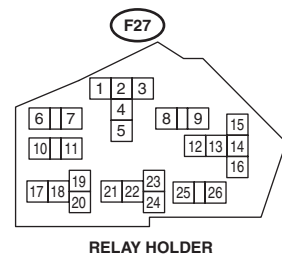
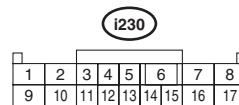
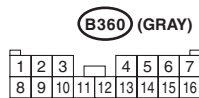
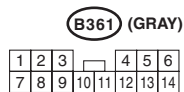
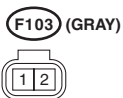
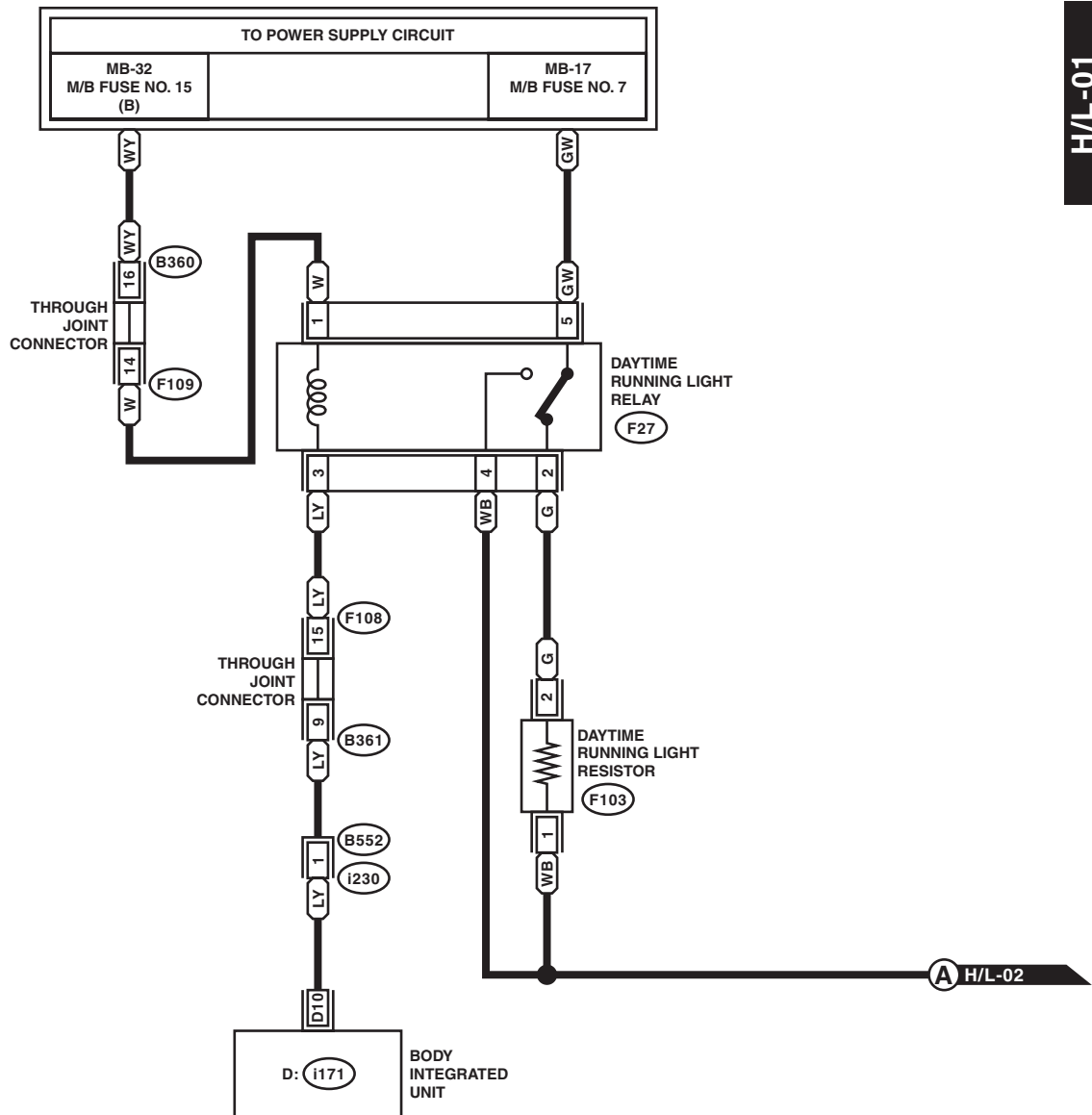

WI-37838

Headlight System

WIRING SYSTEM

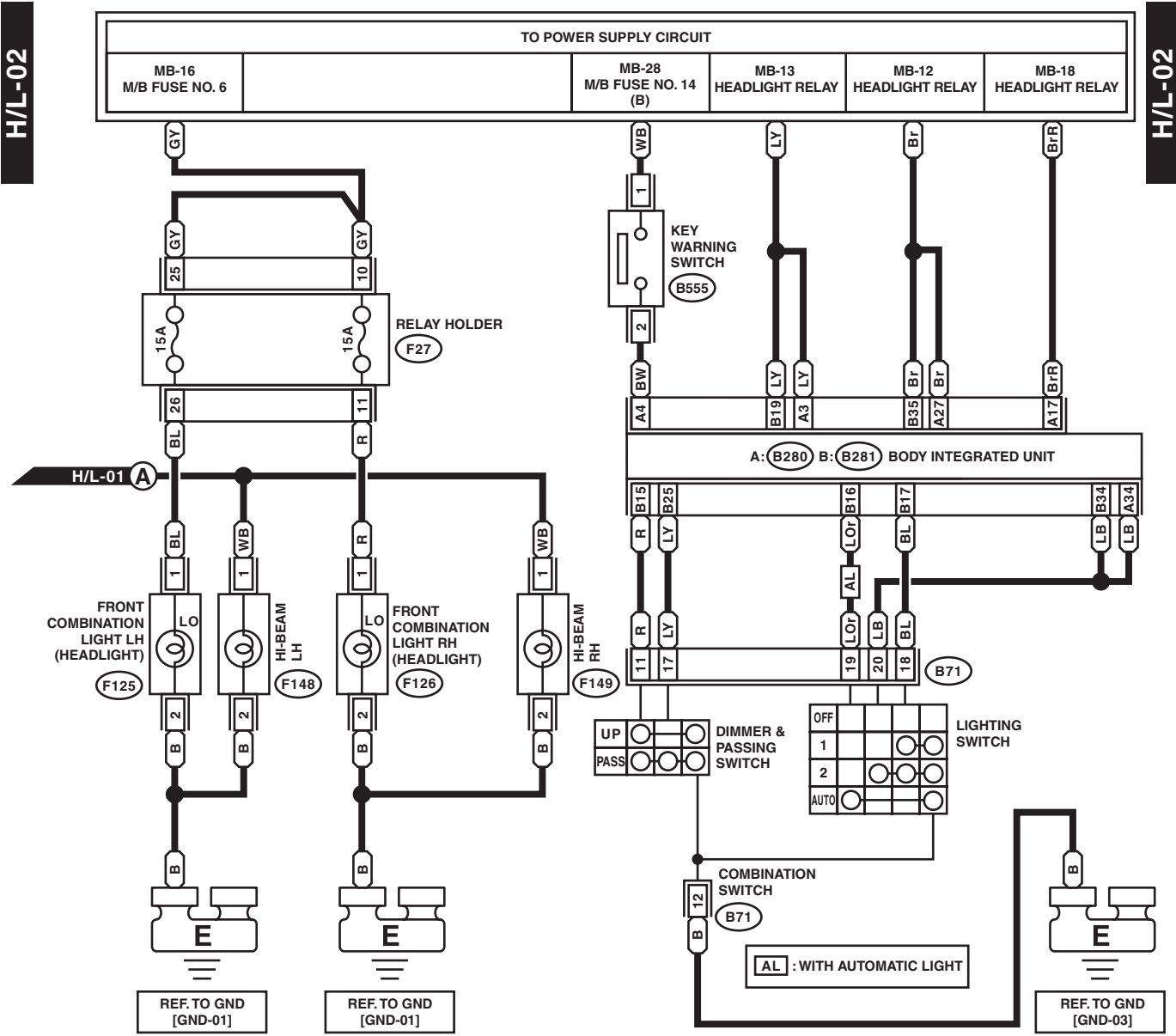

(B555)



(F148)

(F149)



(F125) (LIGHT GRAY)

(F126) (LIGHT GRAY)



(B71)

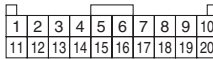

(F27)

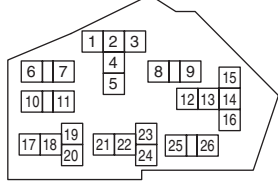

A: (B280)

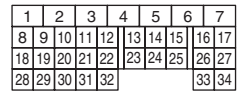

B: (B281)

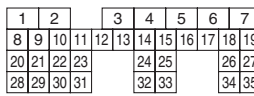

RELAY HOLDER

WI-34215

Headlight System

WIRING SYSTEM

H/L-03

H/L-03

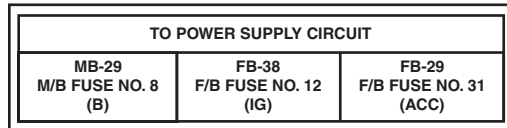

REF. TO CAN COMMUNICATION SYSTEM [CAN-02]

AL : WITH AUTOMATIC LIGHT

B H/L-04

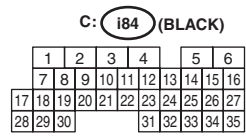
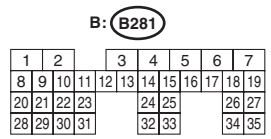
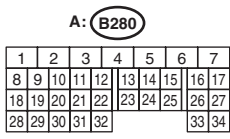
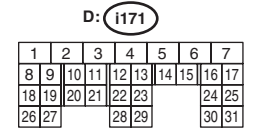
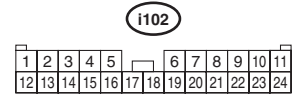
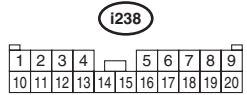
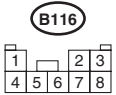
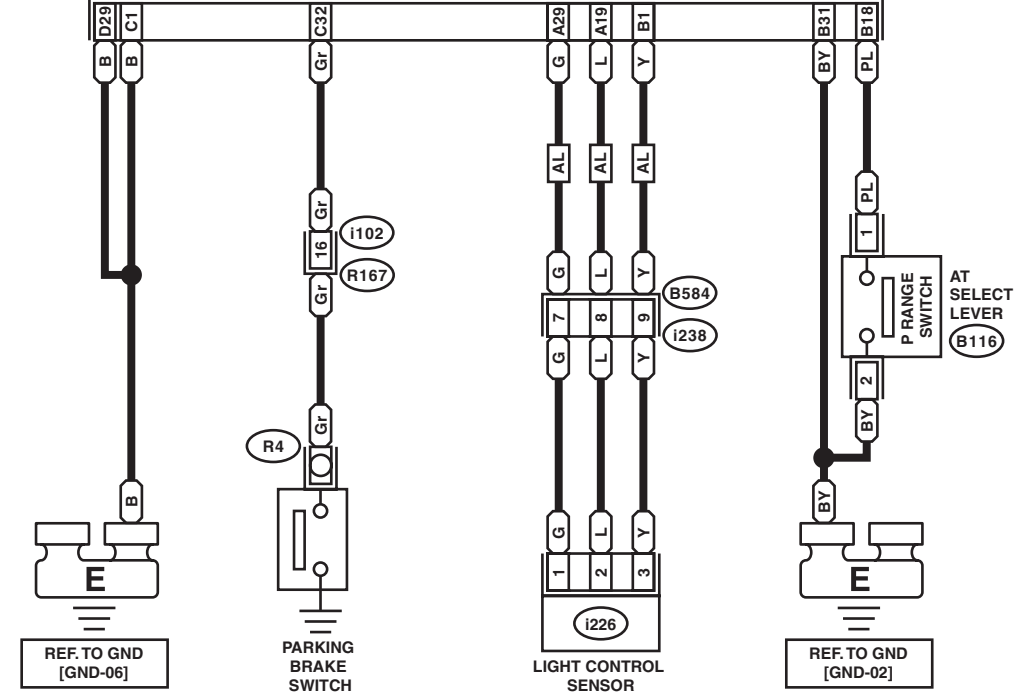

WI-34216

Headlight System

WIRING SYSTEM

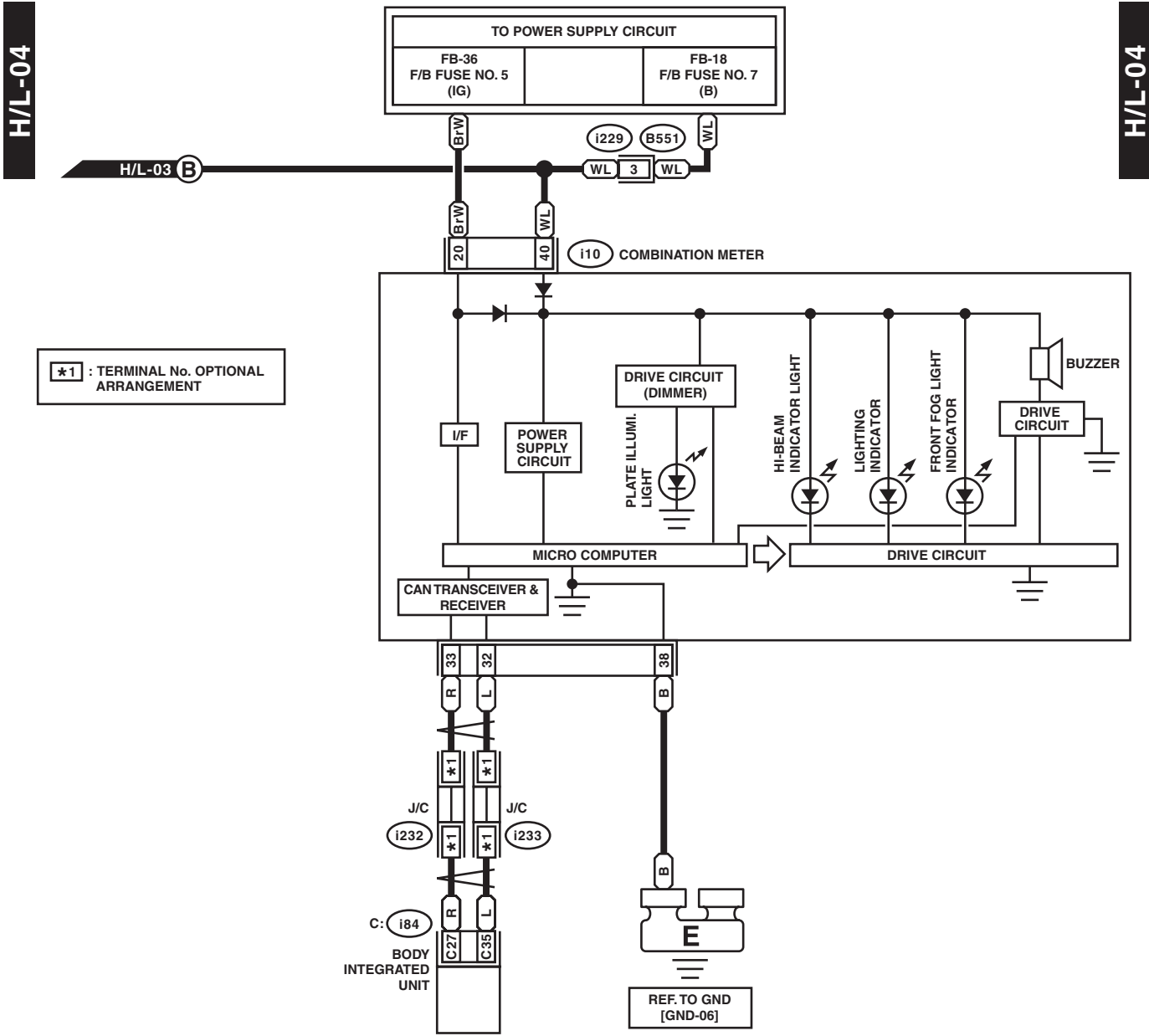

*1 : TERMINAL No. OPTIONAL ARRANGEMENT

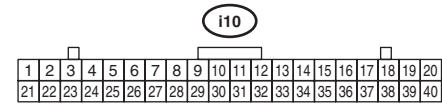
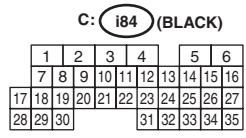
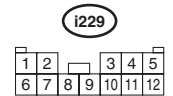
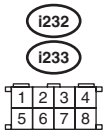

WI-35319