

3. Airbag Module

CAUTION:

- The airbag module (driver side and passenger side) must not be disassembled. The airbag module cannot be used again once inflated.

- When removing and installing the airbag module (driver side and passenger side), the operator should stand, as much as possible, on the side of the airbag module.

- After removal, the airbag module (driver side and passenger side) should be kept away from heat and light sources, and stored on a clean, flat surface to prevent from any damage to its lower structure.

- Do not check airbag module (driver side and passenger side) continuity with airbag removed from the vehicle body.

- Replace airbag module (driver side and passenger side) with a new one, should any of the following conditions develop.

- (1) Pad surface is scratched or cracked.
- (2) Connector harness is damaged.
- (3) Inflator side structure of module is cracked or deformed.
- (4) Module is excessively stained with water, oil, etc.
- (5) Module was accidentally dropped.

- When storing a removed airbag module (driver side and passenger side), be sure to place it in parallel with floor with the pad facing up. Do not place it against a wall, or place anything on the pad; otherwise, a dangerous condition may be created if the module malfunctions.

Driver side

GOOD

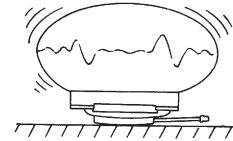
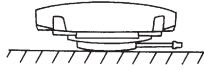

NO GOOD

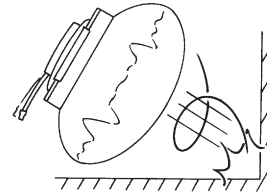
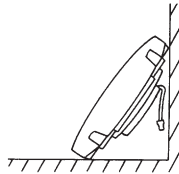

NO GOOD

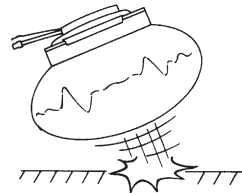
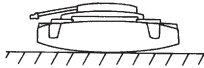

NO GOOD

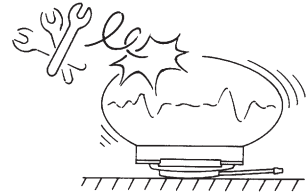
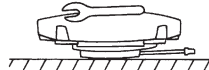

Passenger side

GOOD

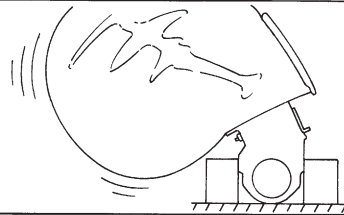
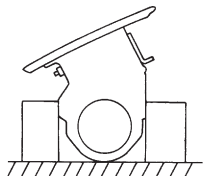

NO GOOD

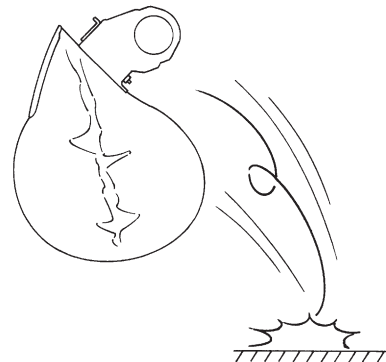
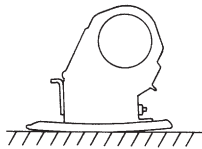

NO GOOD

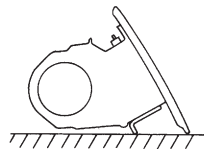

A: REMOVAL**1. DRIVER SIDE**

- 1) Set front wheels in straight ahead position.
- 2) Turn ignition switch off.
- 3) Disconnect ground cable from battery and wait for at least 20 seconds before starting work.

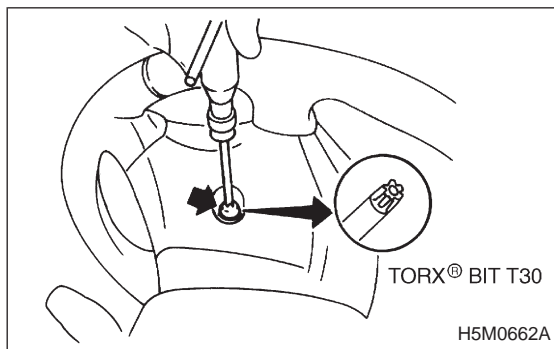

- 4) Using TORX® BIT T30, remove two TORX® bolts.

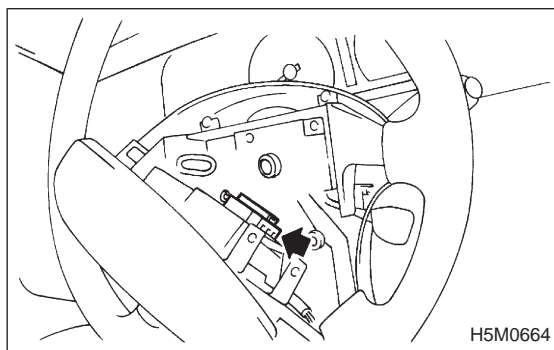

- 5) Disconnect airbag connector on back of airbag module. <Ref. to 5-5 [M2-6].>

- 6) Refer to "**CAUTION**" for handling of a removed airbag module. <Ref. to 5-5 [W300].>

2. PASSENGER SIDE

- 1) Remove instrument panel. <Ref. to 5-4 [W1A0].>

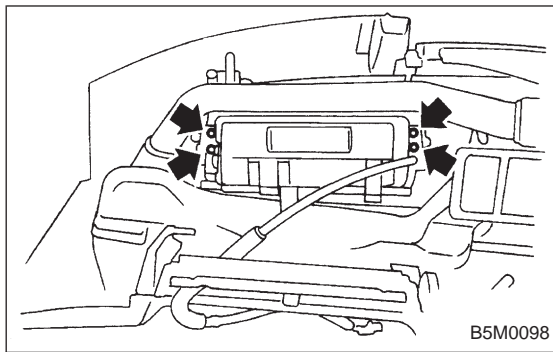

- 2) Remove four bolts and then carefully remove airbag module.
- 3) Refer to “CAUTION” for handling of a removed airbag module.

B: INSTALLATION

Installation is in reverse order of removal procedures. Observe the following: Make sure that ignition switch is off.

CAUTION:

Do not allow harness and connectors to interfere or get caught with other parts.

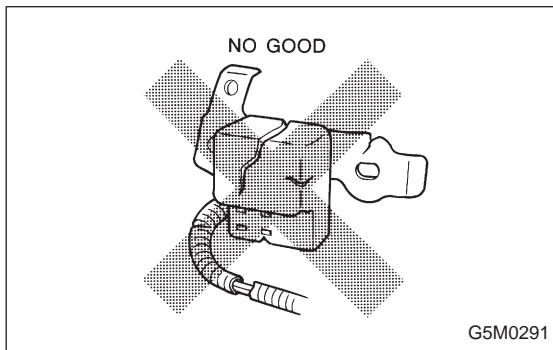

4. Front Sensor

CAUTION:

● If the front end of the vehicle body is damaged by a collision, be sure to check the left and right front sensors, even if the airbag was not inflated. If any damage to the sensor or any deformation of the sensor mount is found, replace with a new genuine part.

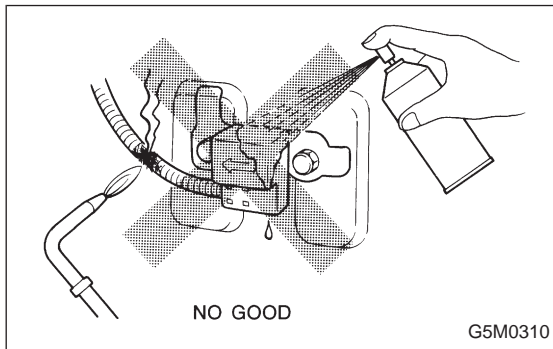

● When painting or performing sheet metal work on the front part of vehicle body, including the front wheel apron, front fender and front side frame, take utmost care not to apply dryer heat, painting mist, or the flame of the welding burner directly to the front sensors and wire harness of the airbag system.

A: REMOVAL

- 1) Turn ignition switch off.
- 2) Disconnect ground cable from battery and wait for at least 20 seconds before starting work.