

A/T CONTROL SYSTEM

Wiring System

10. A/T Control System S903485

A: SCHEMATIC S903485A21

1. 4-CYLINDER ENGINE MODEL S903485A2103

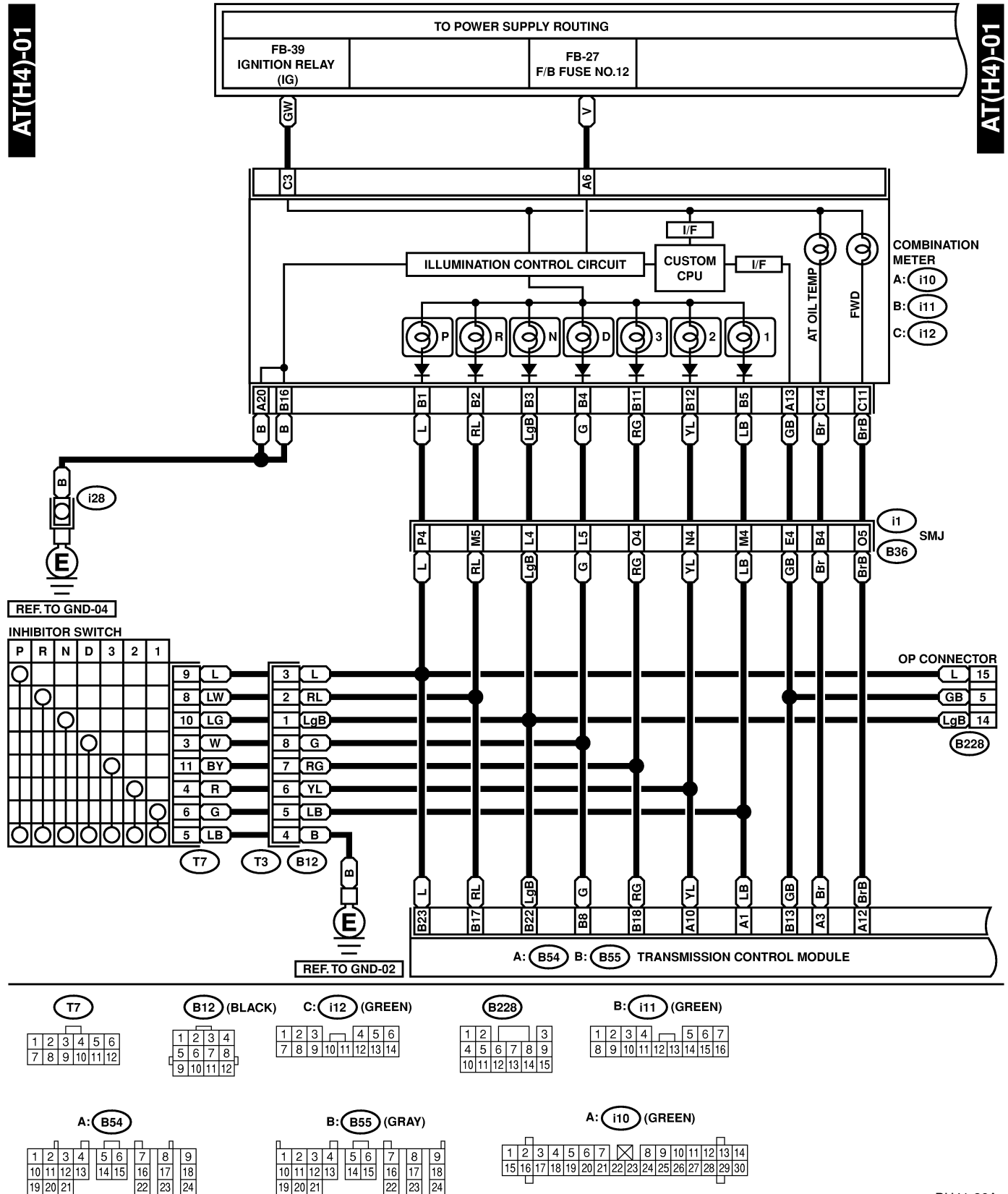

A/T CONTROL SYSTEM

Wiring System

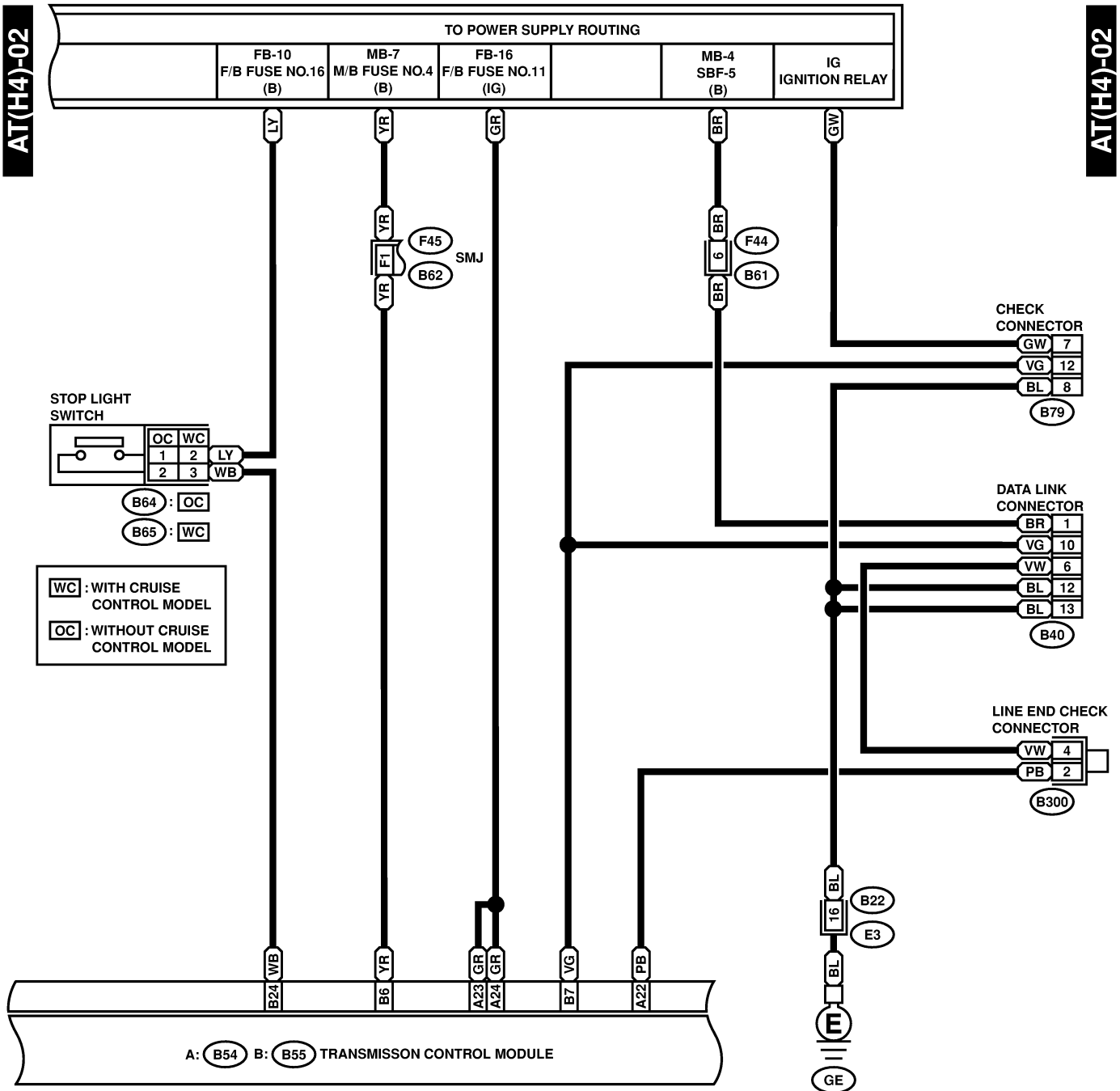

B64 (BLACK)



B65 (BLACK)



B300



F44



B79 (GRAY)

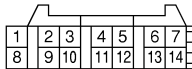

B40

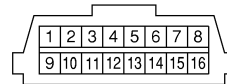

B22 (BROWN)

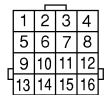

A: B54

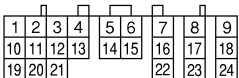

B: B55 (GRAY)

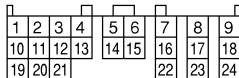

A/T CONTROL SYSTEM

Wiring System

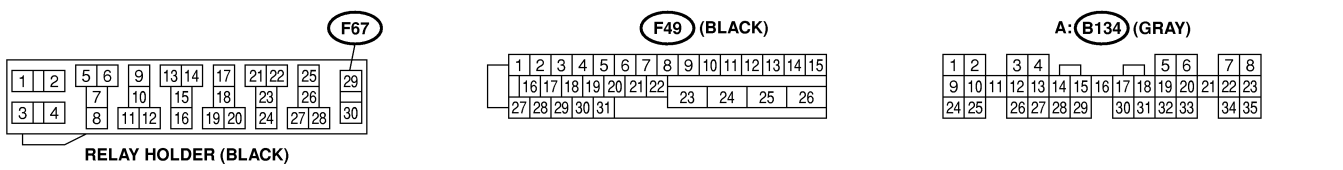
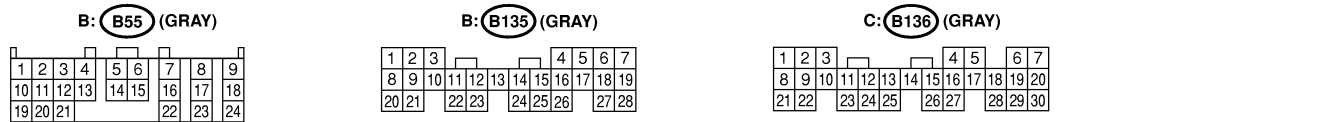
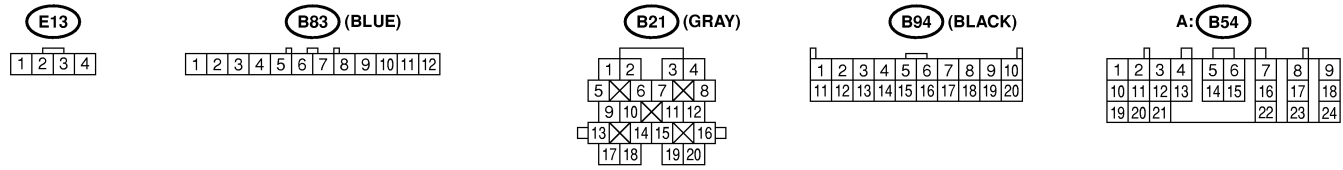
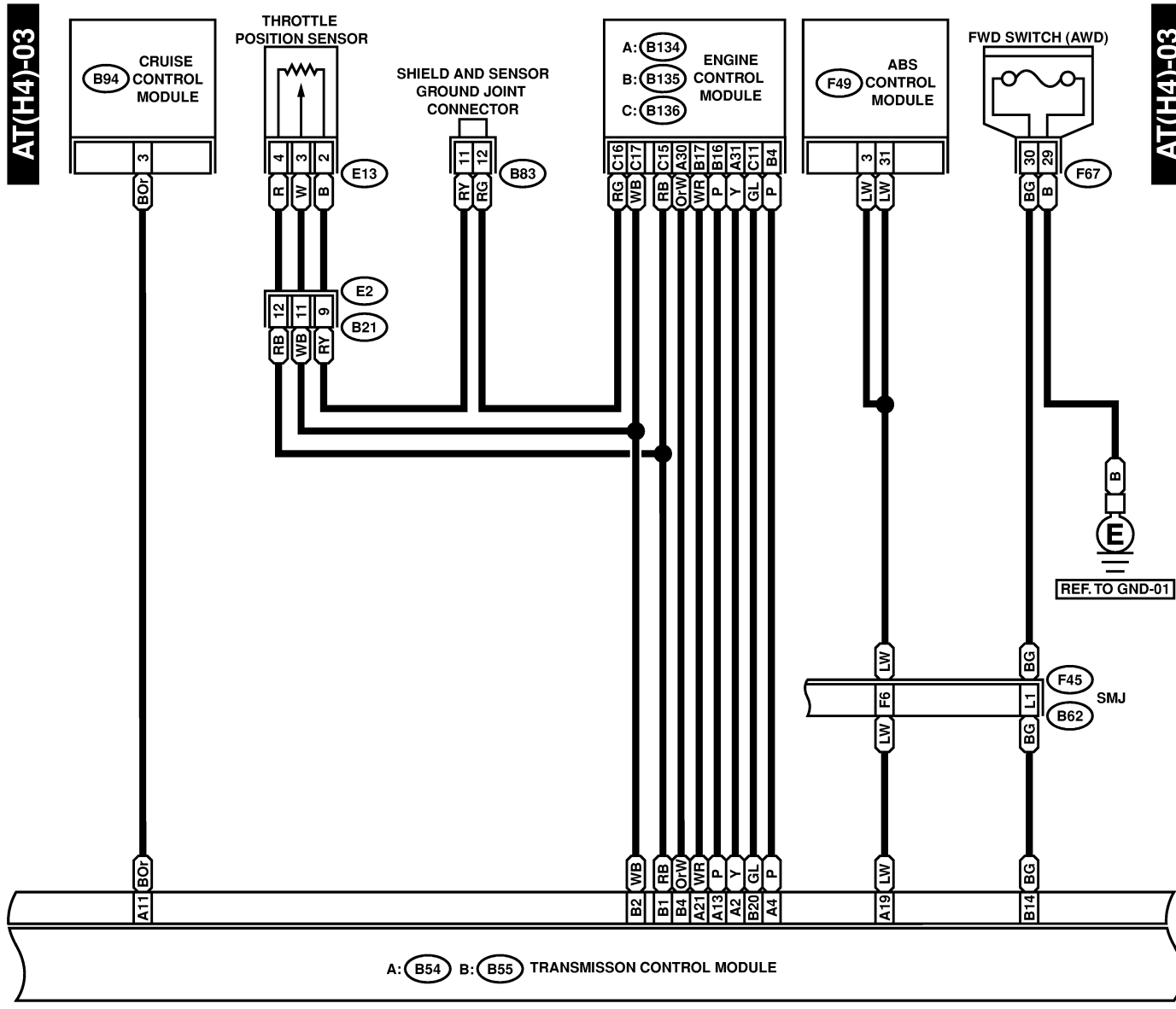

A/T CONTROL SYSTEM

Wiring System

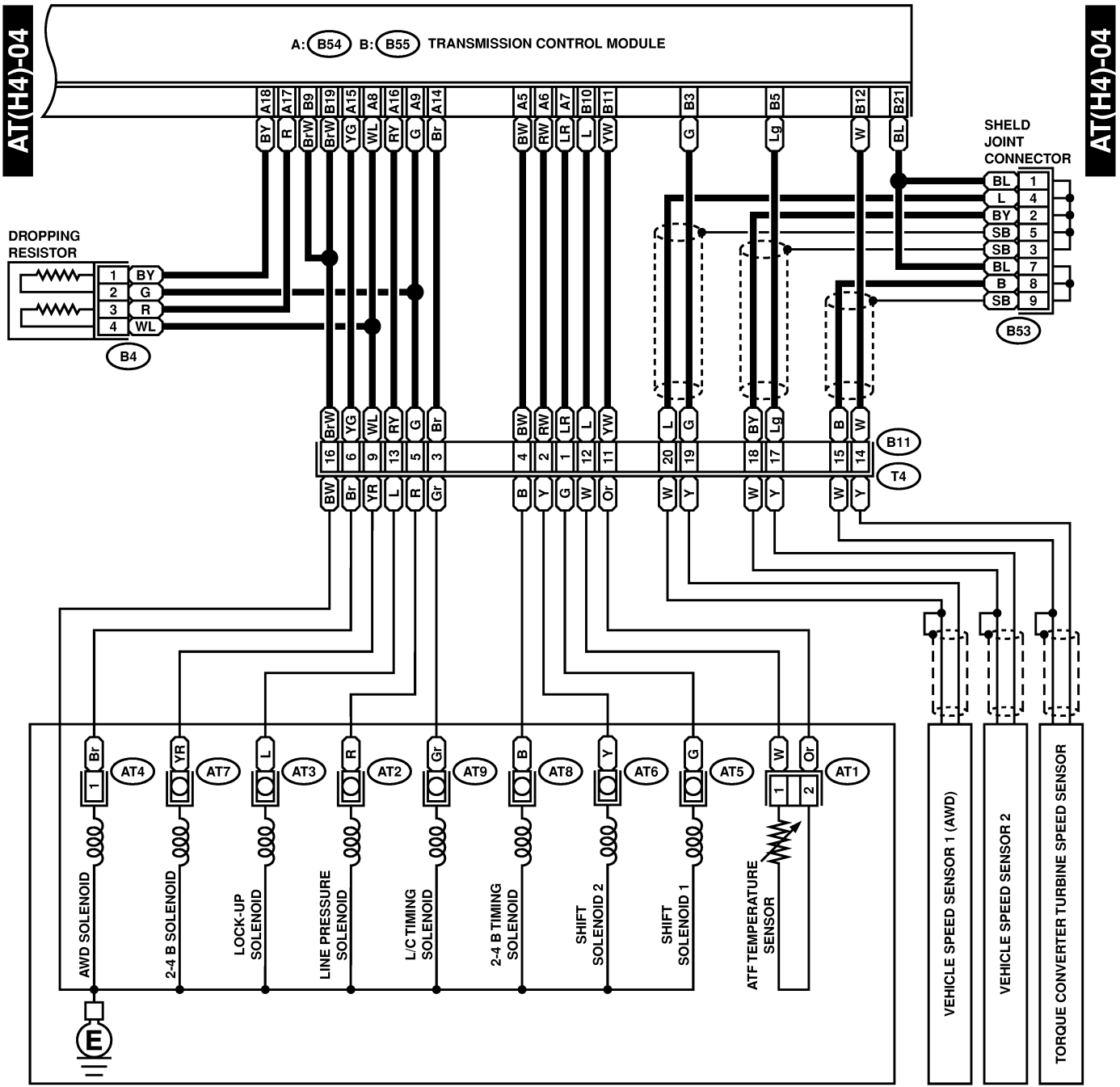

AT4 (BROWN)



AT1 (GRAY)



B4 (GRAY)



B53 (BLUE)

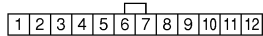

B11 (BLACK)

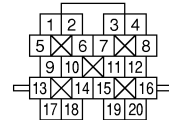

A: B54

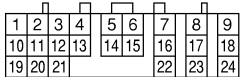

B: B55 (GRAY)

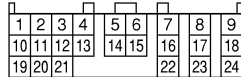

A/T CONTROL SYSTEM

Wiring System

2. 6-CYLINDER ENGINE WITHOUT VDC MODEL S903485A2104

AT(H6)OV-01

AT(H6)OV-01

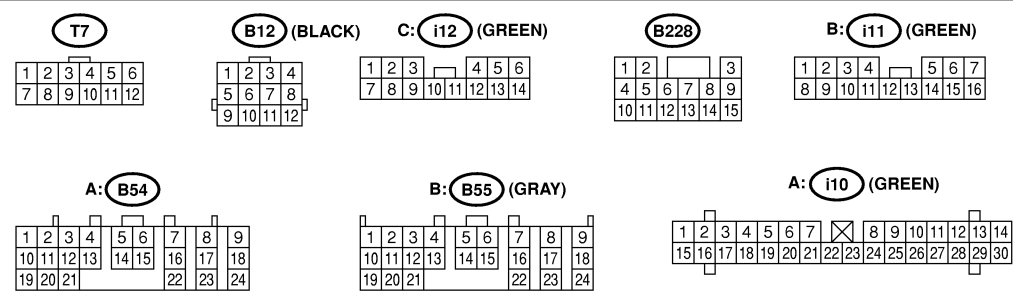
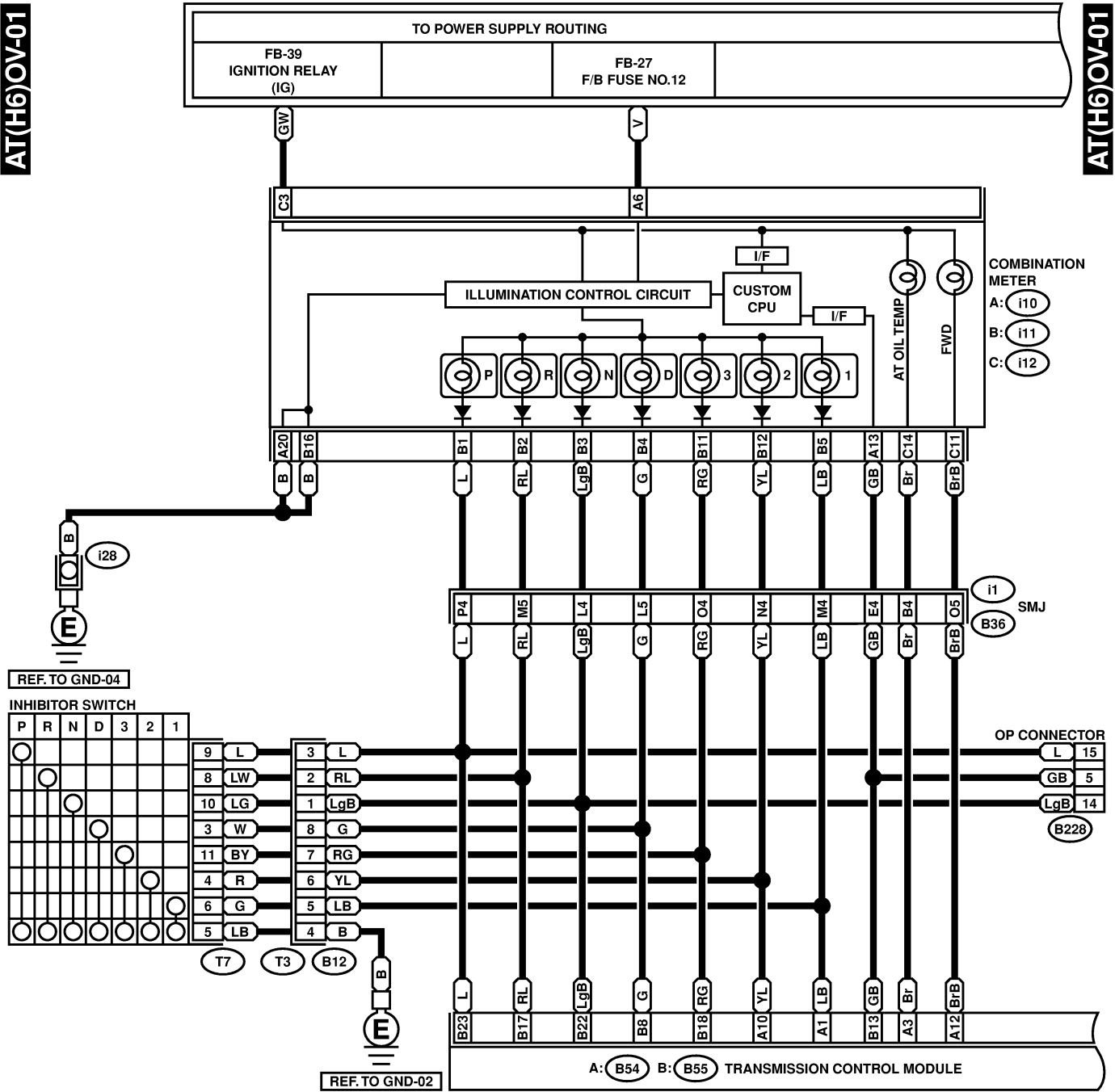

A/T CONTROL SYSTEM

Wiring System

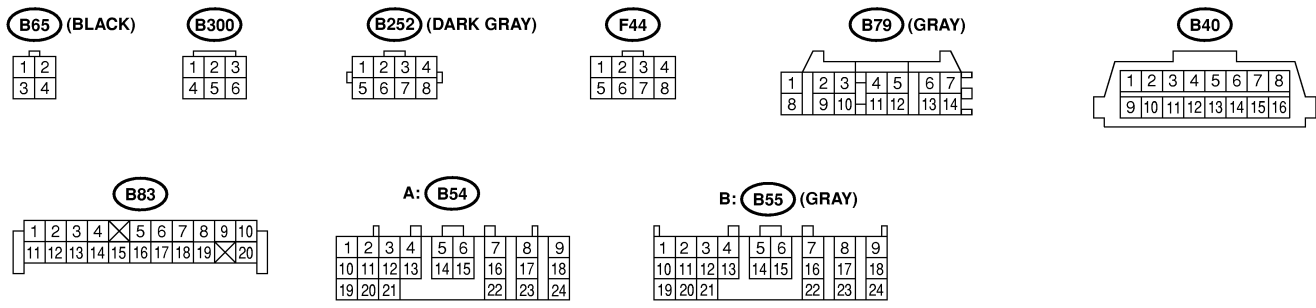
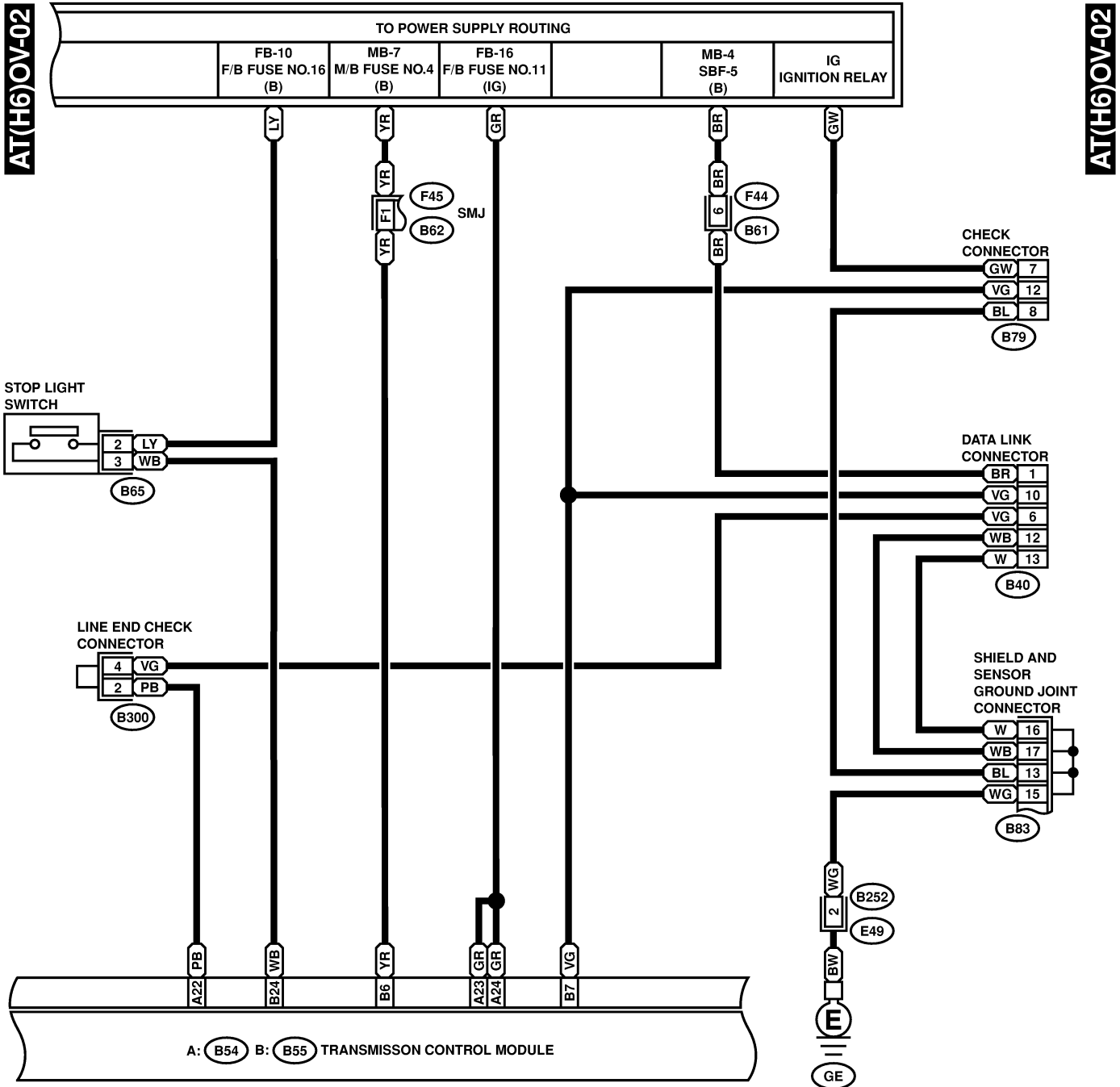

A/T CONTROL SYSTEM

Wiring System

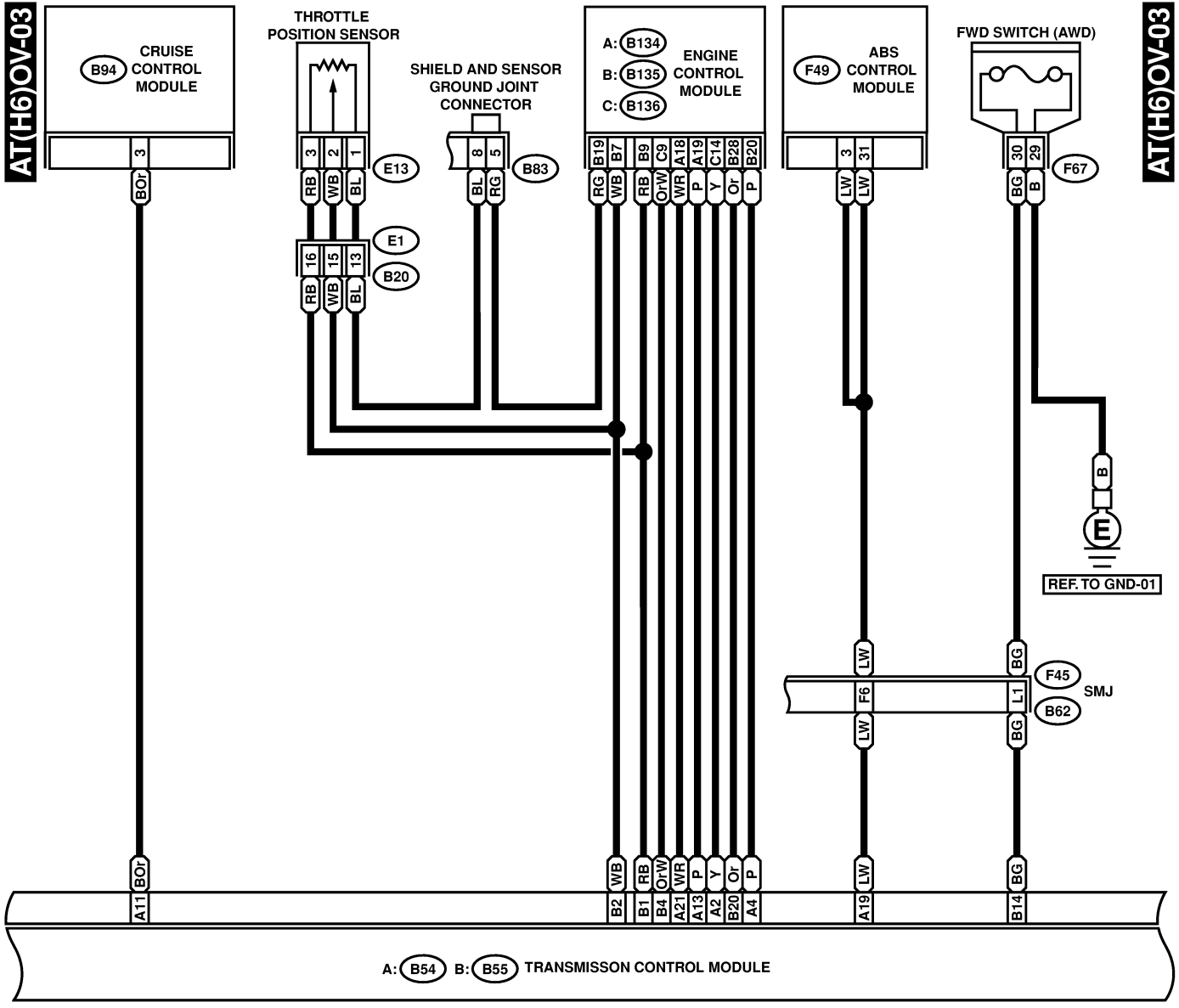

E13 (BLACK)



B20 (GRAY)

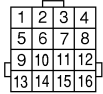

B94 (BLACK)

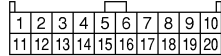

B83

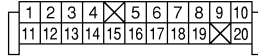

A: B134

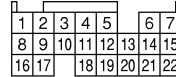

C: B136

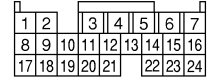

A: B54

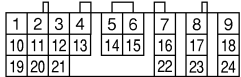

B: B55 (GRAY)

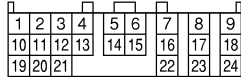

B: B135

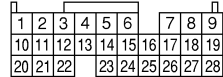

F67

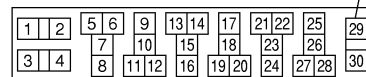

RELAY HOLDER (BLACK)

F49 (BLACK)

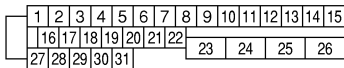

A/T CONTROL SYSTEM

Wiring System

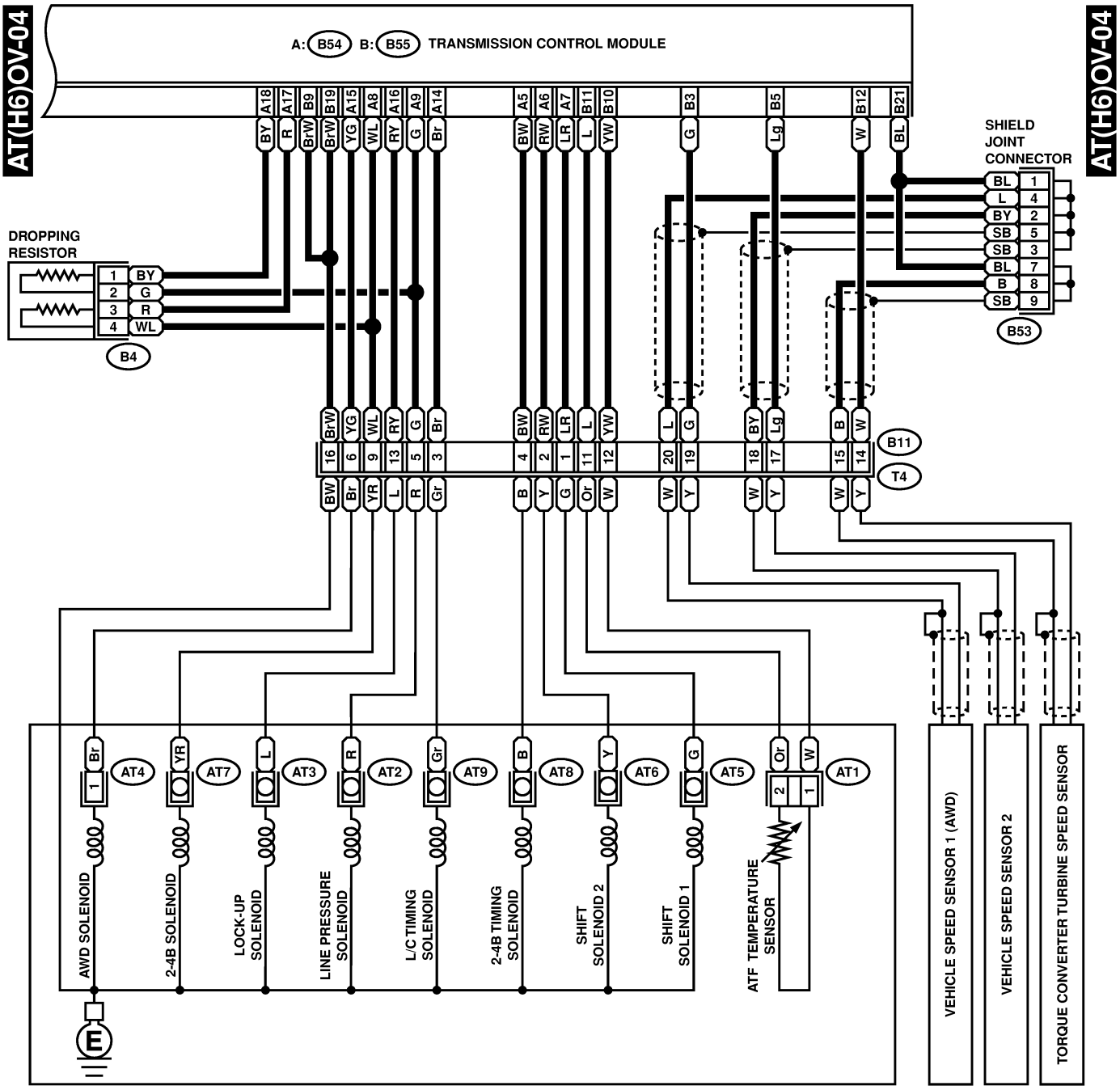

AT4 (BROWN)



AT1 (GRAY)



B4 (GRAY)



B53 (BLUE)

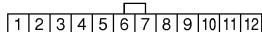

B11 (BLACK)

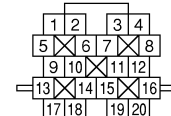

A: B54

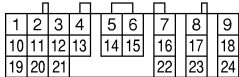

B: B55 (GRAY)

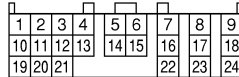

A/T CONTROL SYSTEM

Wiring System

3. 6-CYLINDER ENGINE WITH VDC MODEL S903485A2105

AT(H6)WV-01

AT(H6)WV-01

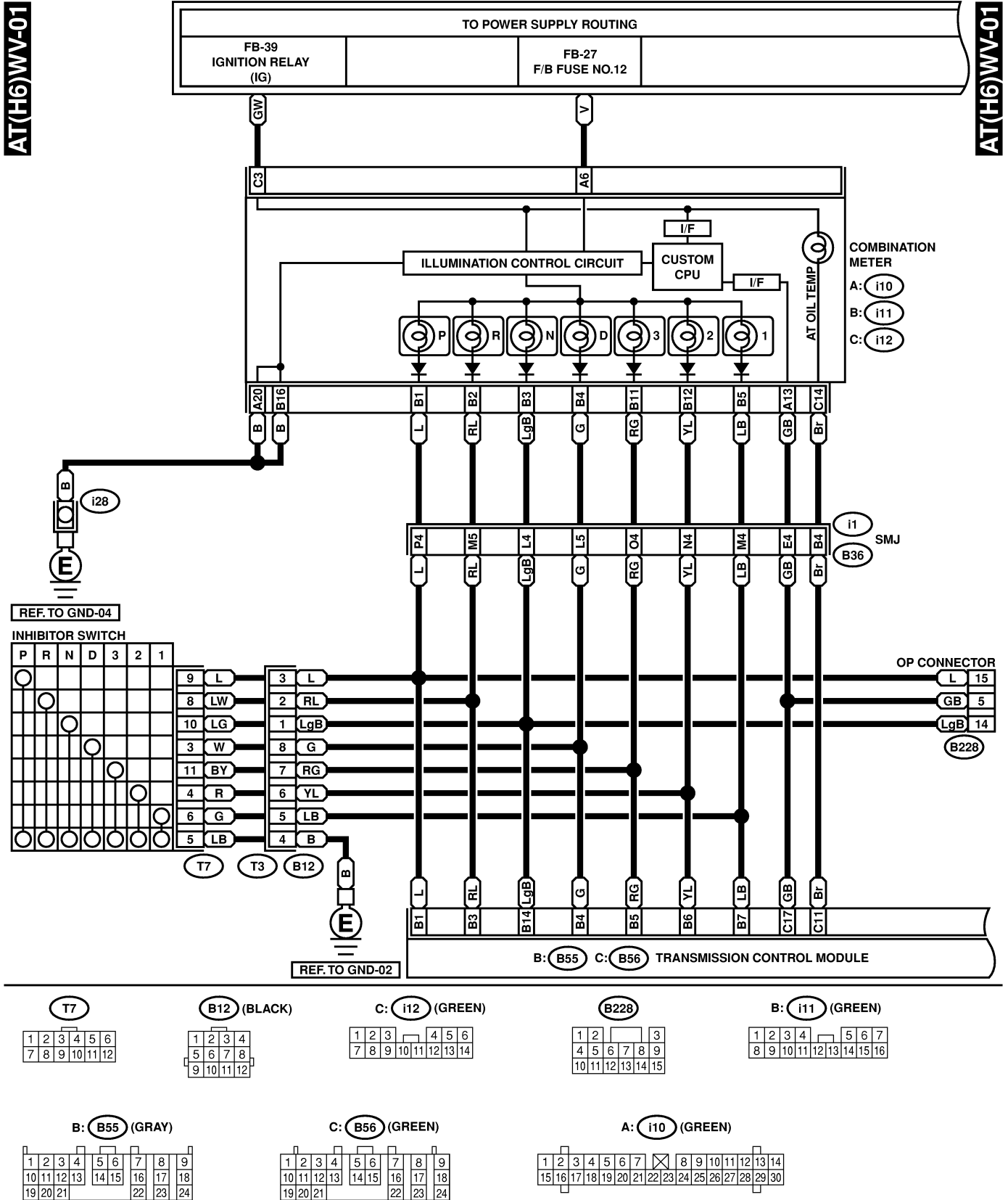

A/T CONTROL SYSTEM

Wiring System

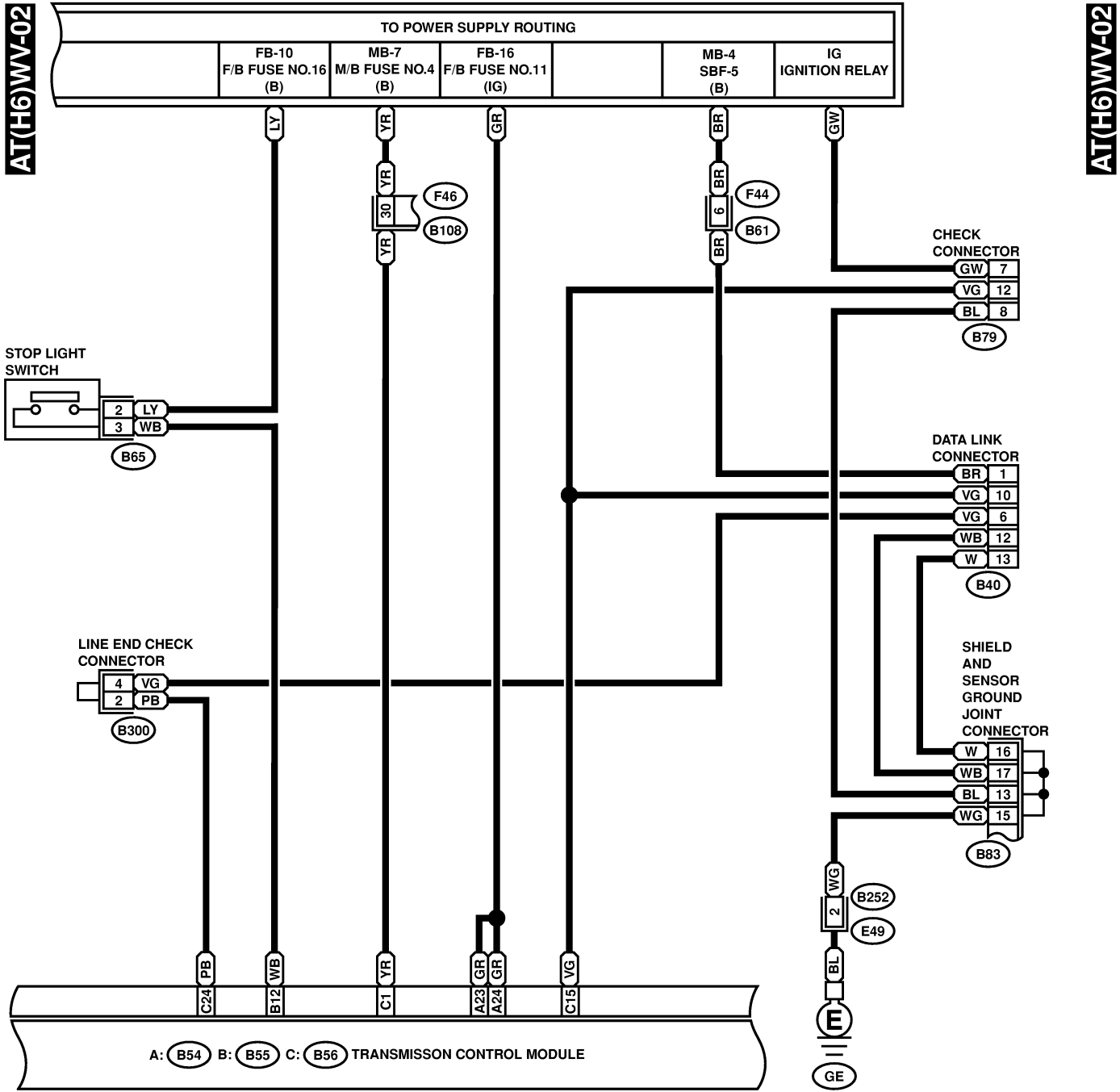

B65 (BLACK)



B300



B252 (DARK GRAY)



F44



B79 (GRAY)

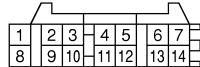

B40

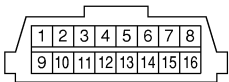

B83

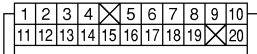

A: B54

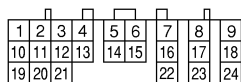

B: B55 (GRAY)

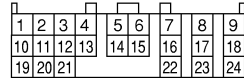

C: B56 (GREEN)

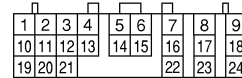

F46



A/T CONTROL SYSTEM

Wiring System

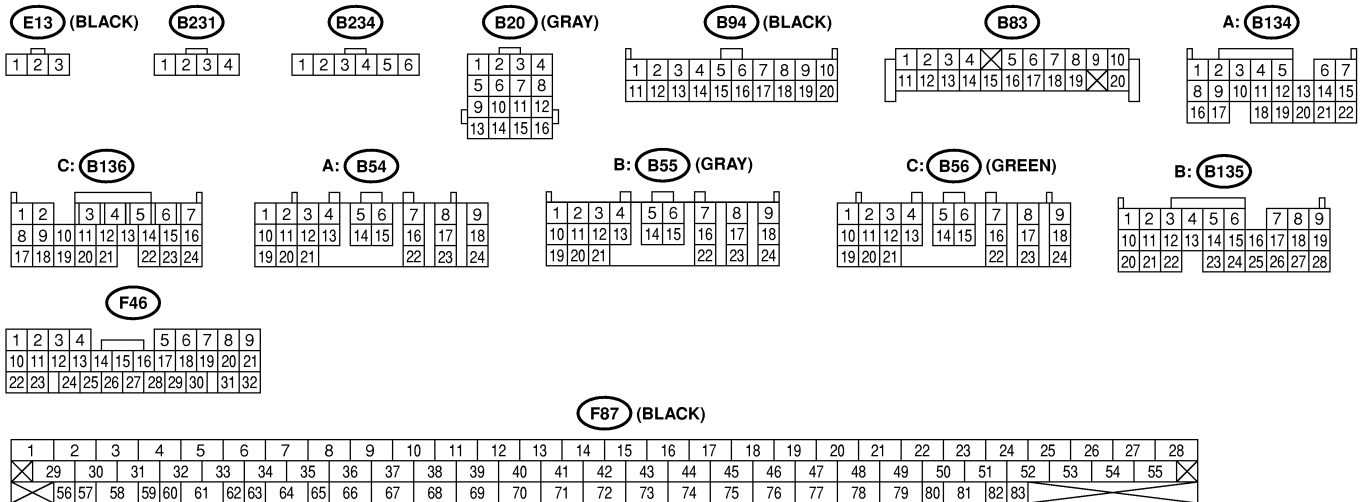
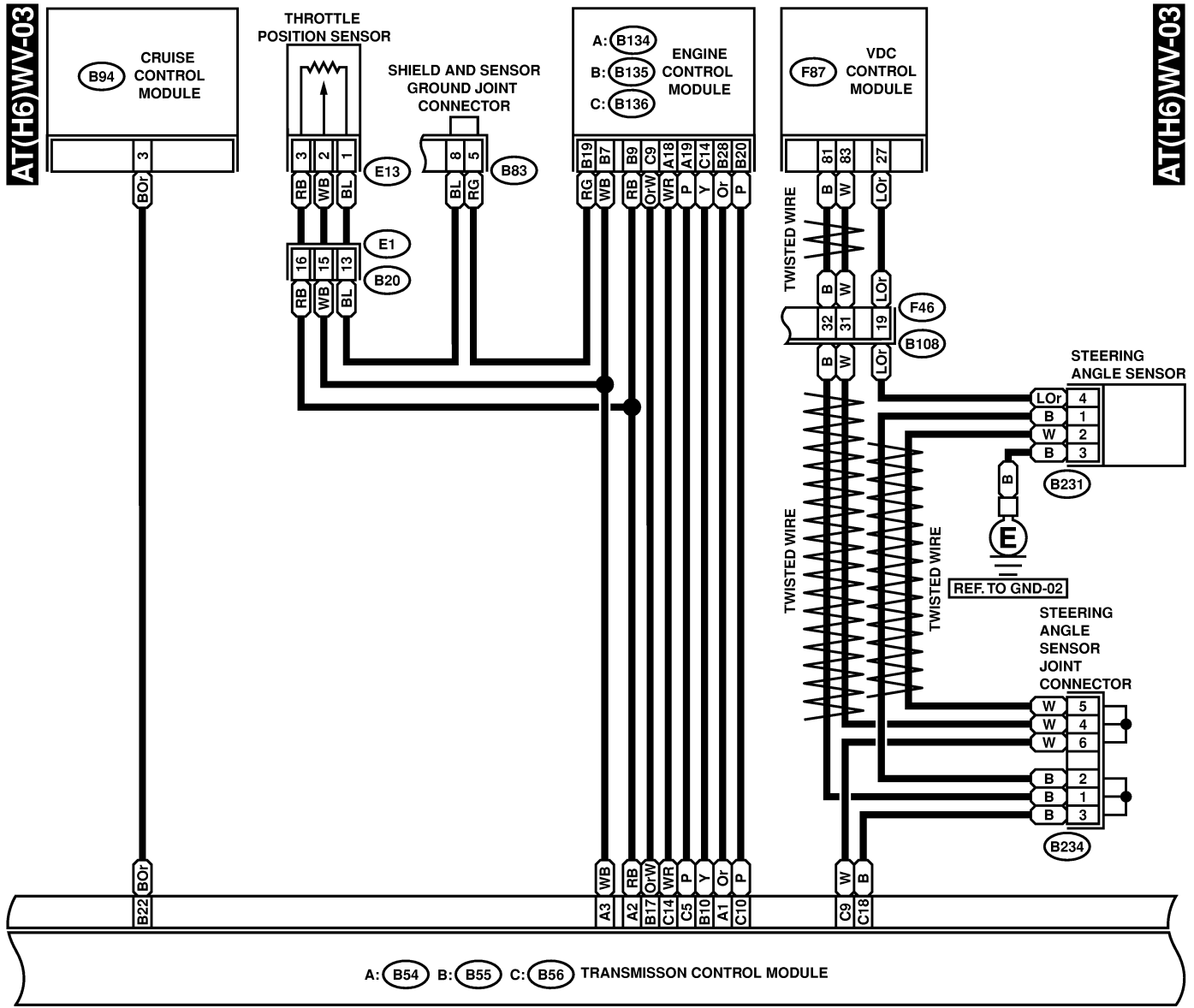

A/T CONTROL SYSTEM

Wiring System

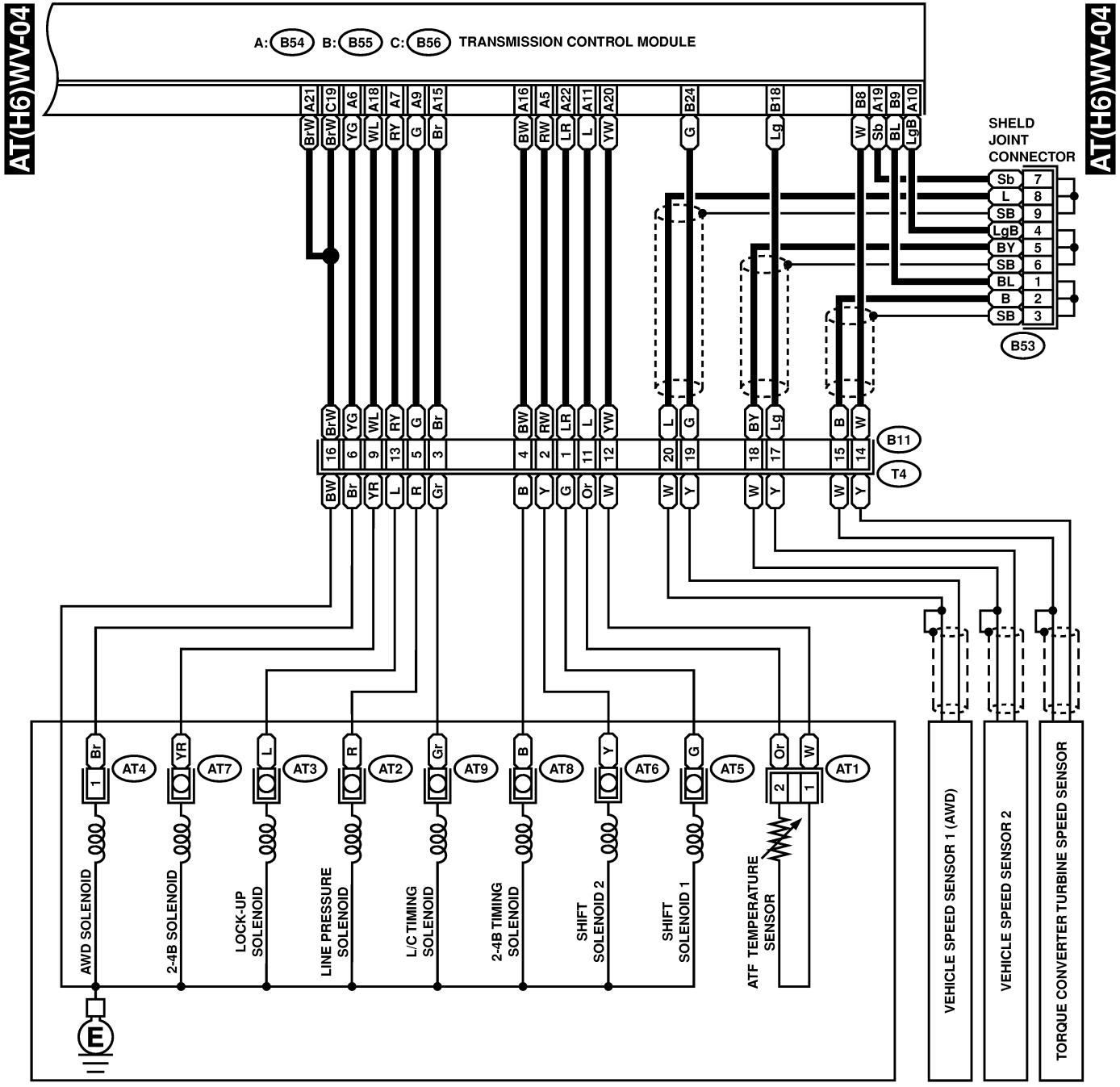

AT4 (BROWN)



AT1 (GRAY)



B53 (BLACK)

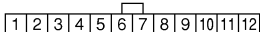

B11 (BLACK)

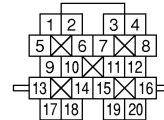

A: B54

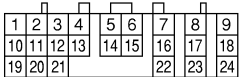

B: B55 (GRAY)

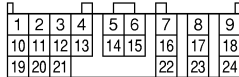

C: B56 (GREEN)

