

## 47. Starter System

### A: WIRING DIAGRAM

#### 1. 2.5 L NON-TURBO MODEL

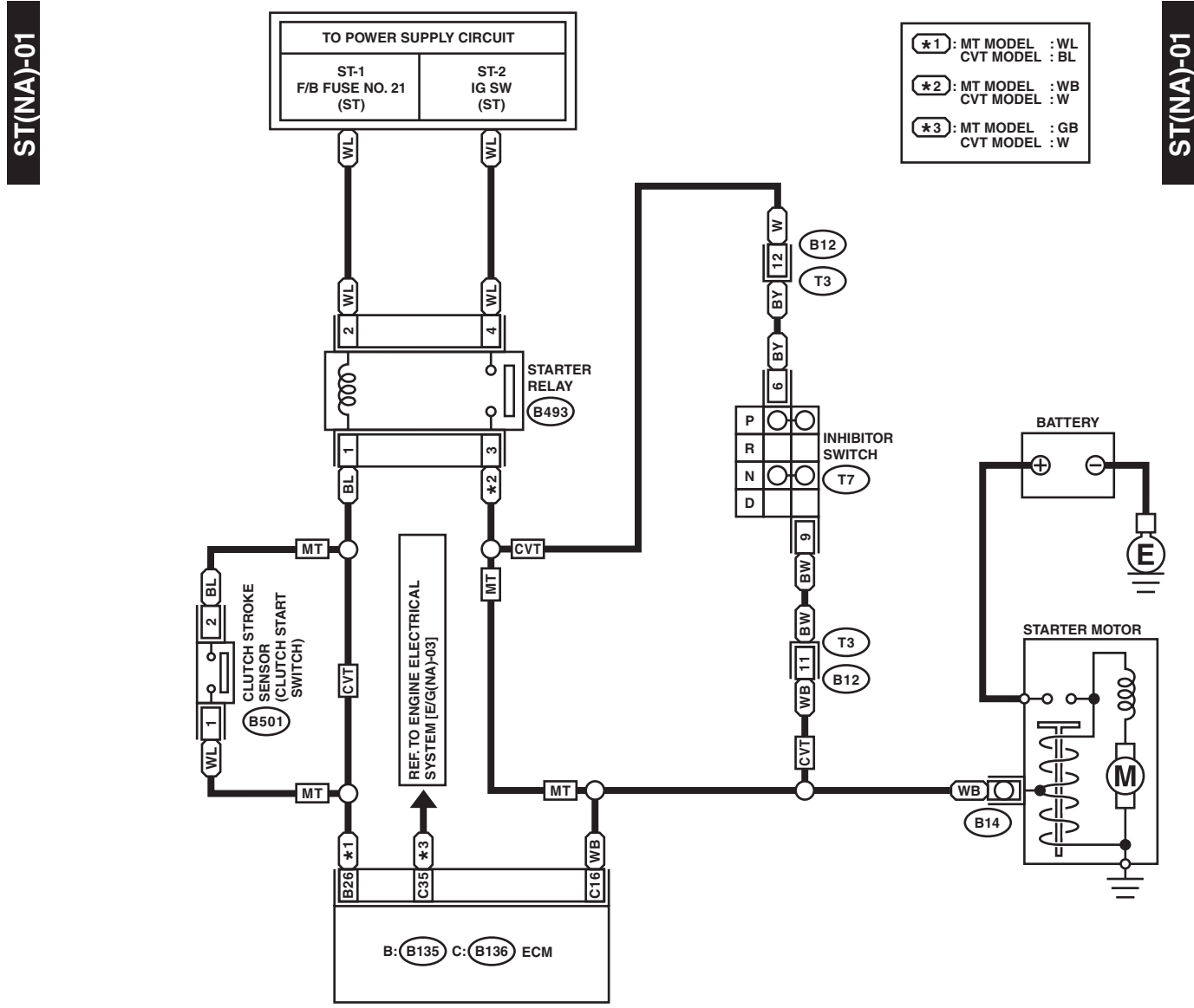

B493 (BLACK)



B501

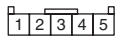

T7 (BLACK)



B12 (LIGHT GRAY)

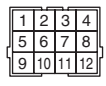

B: B135

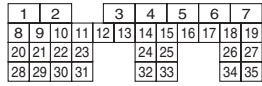

C: B136

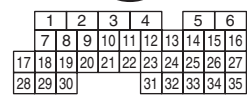

# Starter System

WIRING SYSTEM

## 2. 2.5 L TURBO MODEL

ST(TB)-01

ST(TB)-01

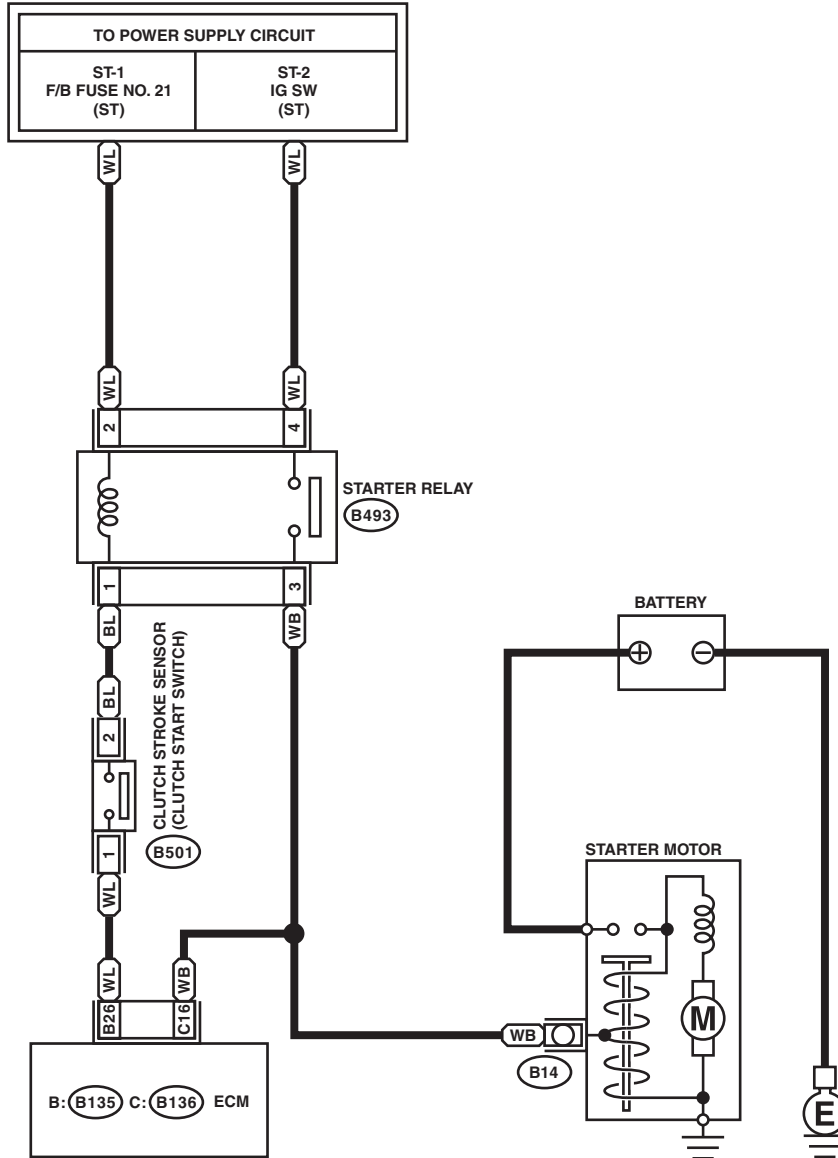

B493 (BLACK)



B501

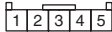

B: B135

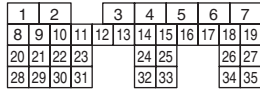

C: B136

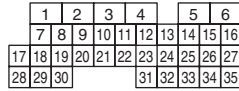

WI-25593

# Starter System

WIRING SYSTEM

## 3. 3.6 L MODEL

ST(H6)-01

ST(H6)-01

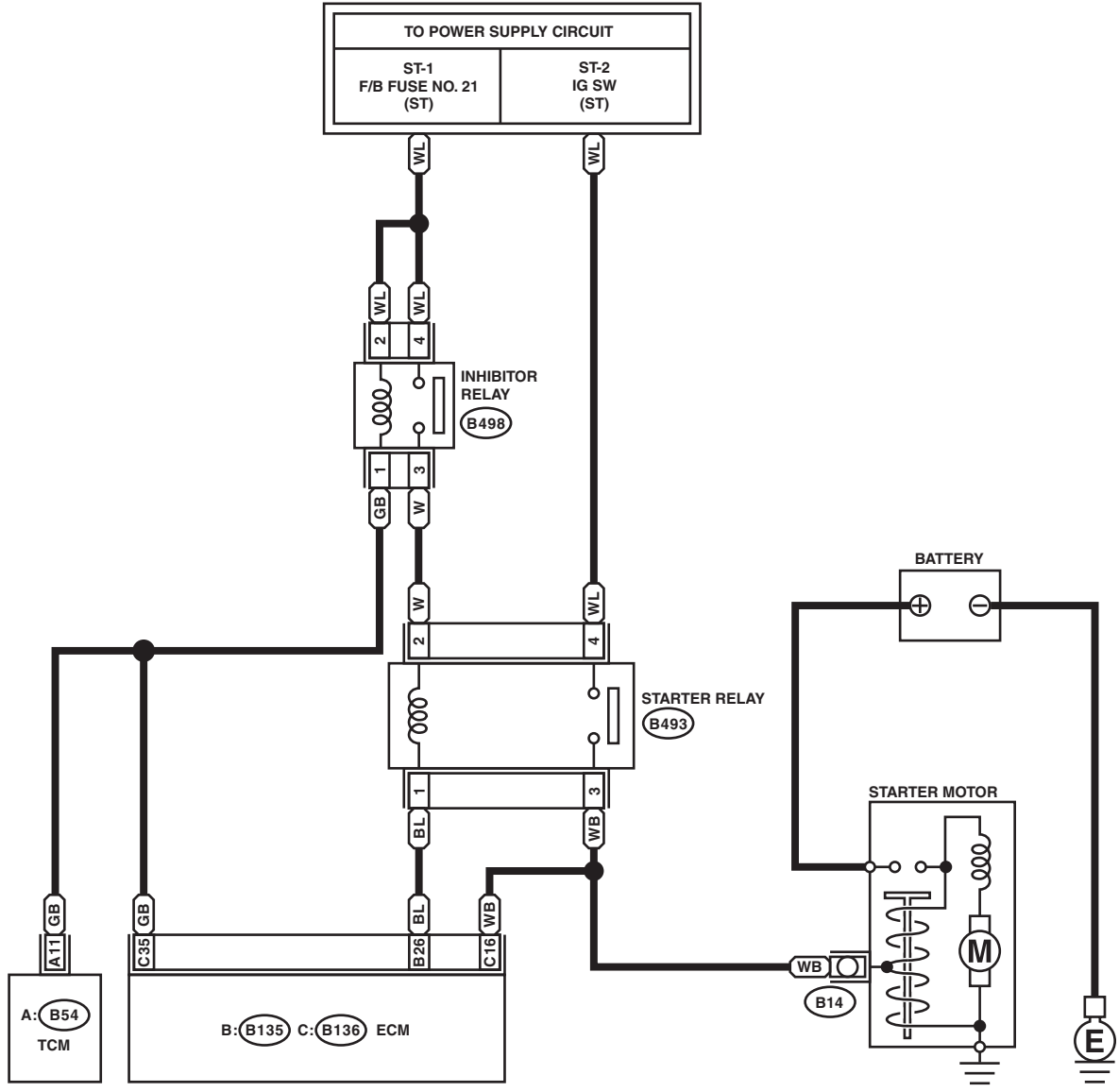

(B493) (BLACK)

A: (B54) B: (B135)

C: (B136)

(B498) (BLACK)

1	2	3	4	5	6	7					
8	9	10	11	12	13	14	15	16	17	18	19
20	21	22	23	24	25	26	27				
28	29	30	31	32	33	34	35				

1	2	3	4	5	6					
7	8	9	10	11	12	13	14	15	16	
17	18	19	20	21	22	23	24	25	26	27
28	29	30		31	32	33	34	35		



WI-25594