

## 6. Air Conditioning System

### A: WIRING DIAGRAM

#### 1. MANUAL A/C

M-A/C-C-01

M-A/C-C-01

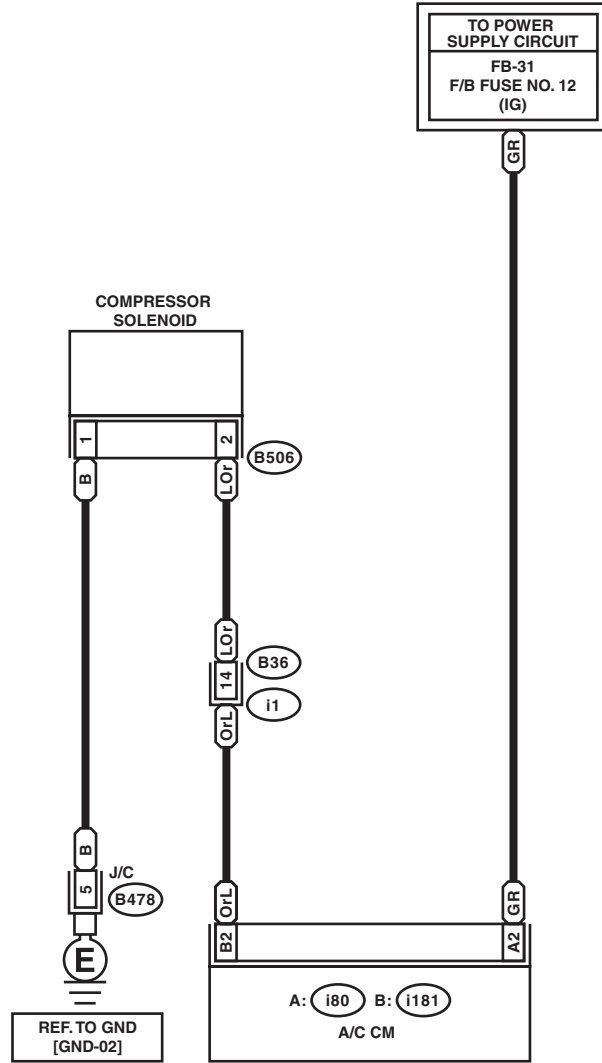

B506 (LIGHT GRAY)

B478

B: i181

A: i80

B36

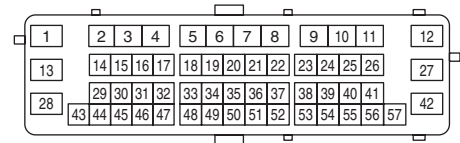
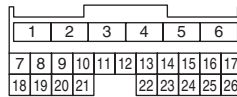
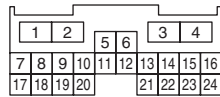
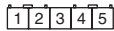

WI-25416

# Air Conditioning System

## WIRING SYSTEM

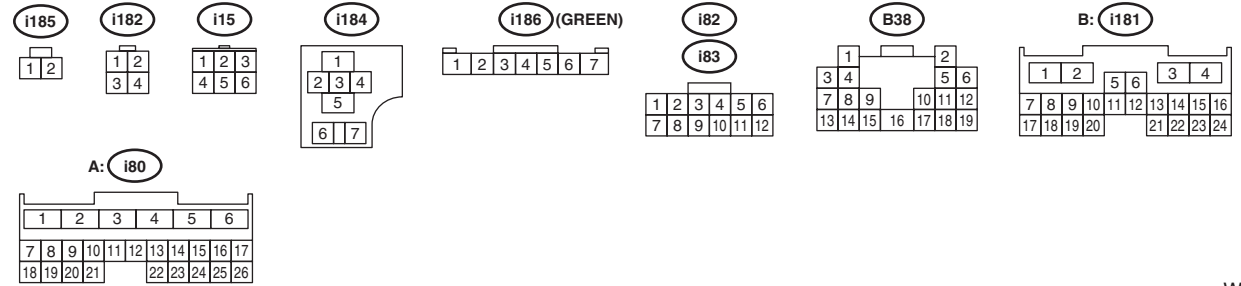
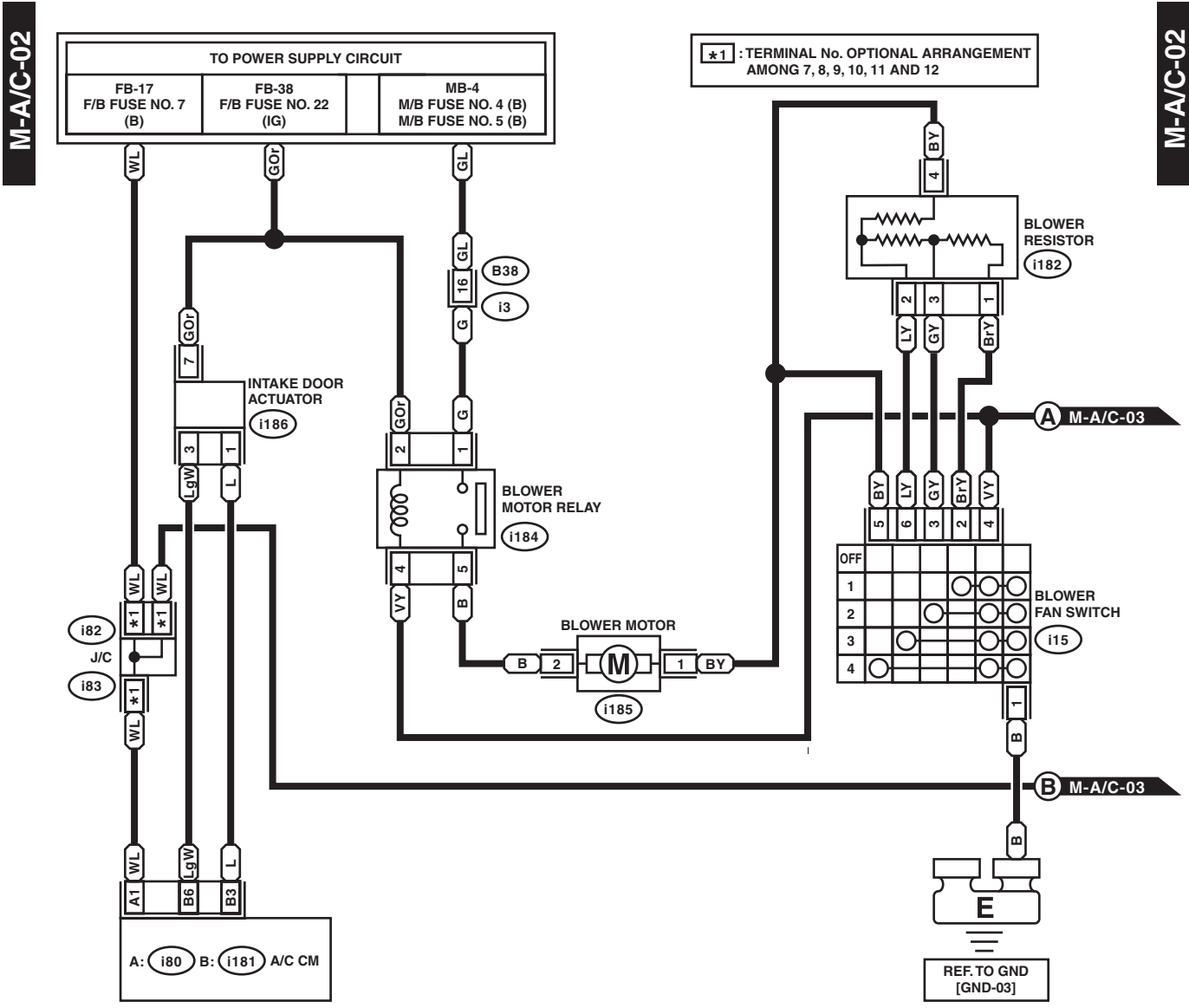

WI-25417

# Air Conditioning System

WIRING SYSTEM

M-A/C-03

M-A/C-03

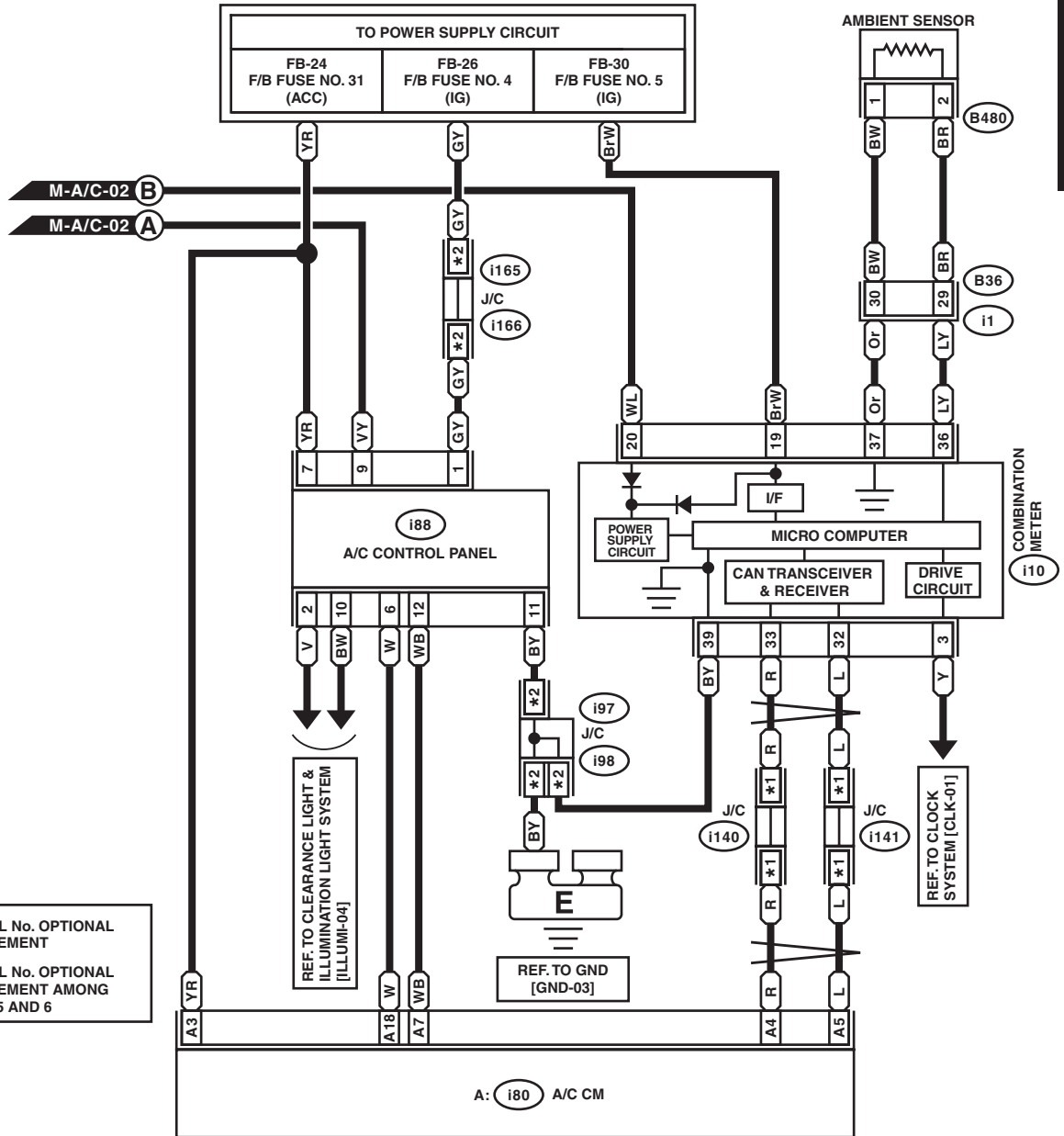

- \*1 : TERMINAL No. OPTIONAL ARRANGEMENT
- \*2 : TERMINAL No. OPTIONAL ARRANGEMENT AMONG 1, 2, 3, 4, 5 AND 6

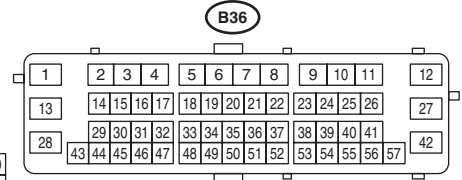
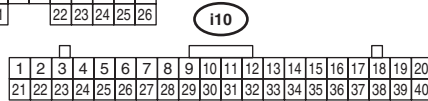
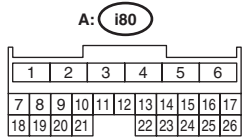
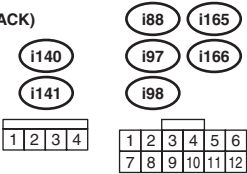
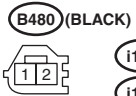

WI-25418

# Air Conditioning System

## WIRING SYSTEM

M-A/C-04

M-A/C-04

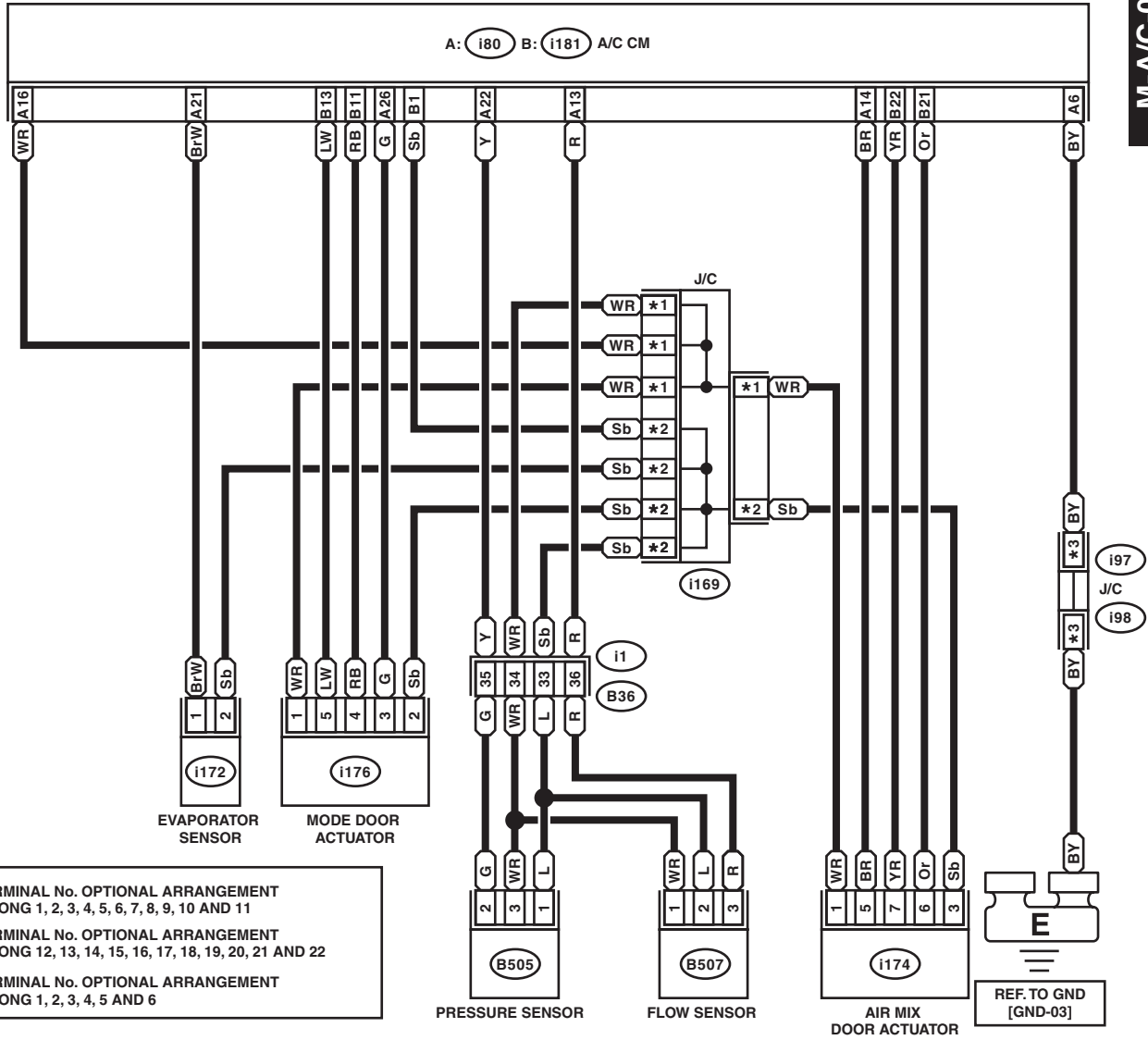

- \*1**: TERMINAL No. OPTIONAL ARRANGEMENT AMONG 1, 2, 3, 4, 5, 6, 7, 8, 9, 10 AND 11
- \*2**: TERMINAL No. OPTIONAL ARRANGEMENT AMONG 12, 13, 14, 15, 16, 17, 18, 19, 20, 21 AND 22
- \*3**: TERMINAL No. OPTIONAL ARRANGEMENT AMONG 1, 2, 3, 4, 5 AND 6

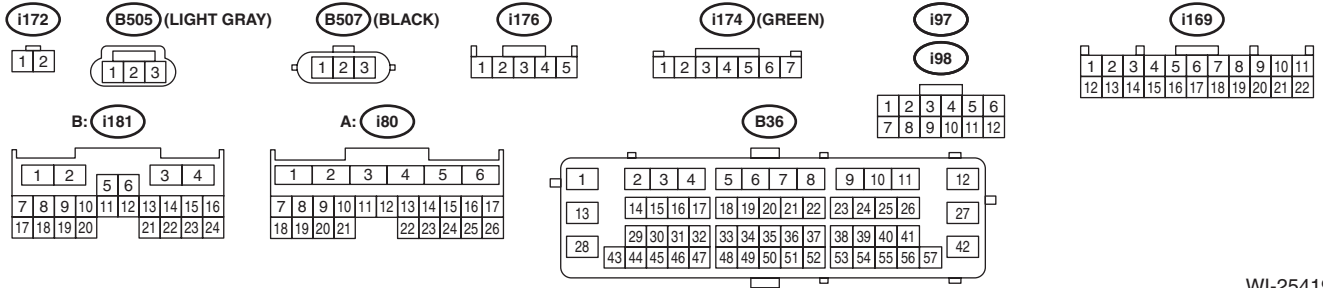

WI-25419

# Air Conditioning System

WIRING SYSTEM

## 2. AUTO A/C

A-A/C-01

A-A/C-01

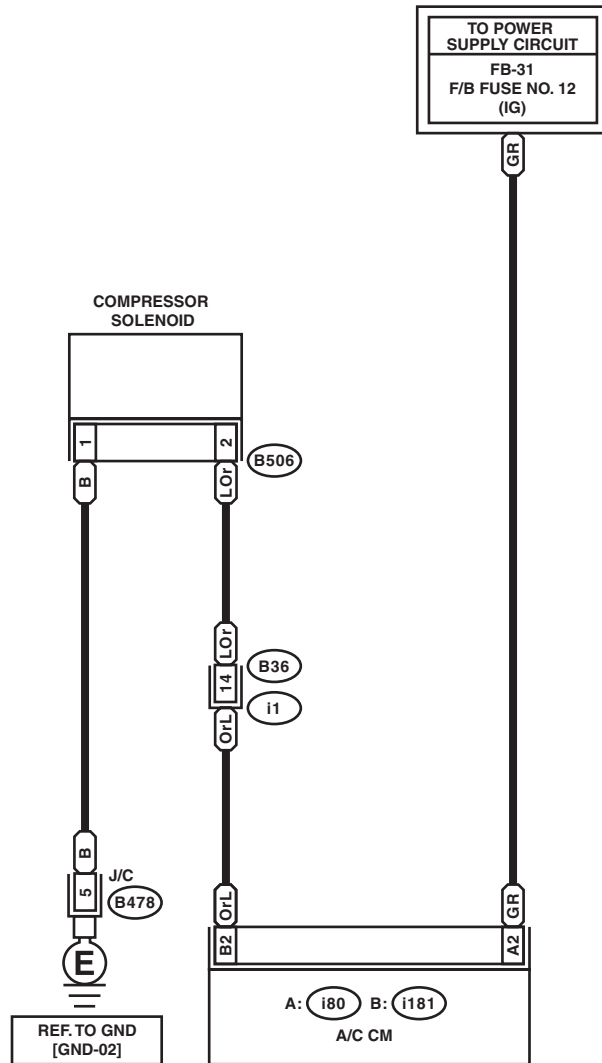

(B506) (LIGHT GRAY)



(B478)

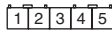

B: (i181)

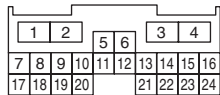

A: (180)

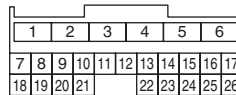

(B36)

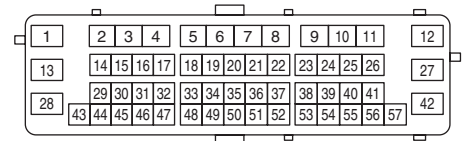

WI-25421

# Air Conditioning System

## WIRING SYSTEM

A-A/C-02

A-A/C-02

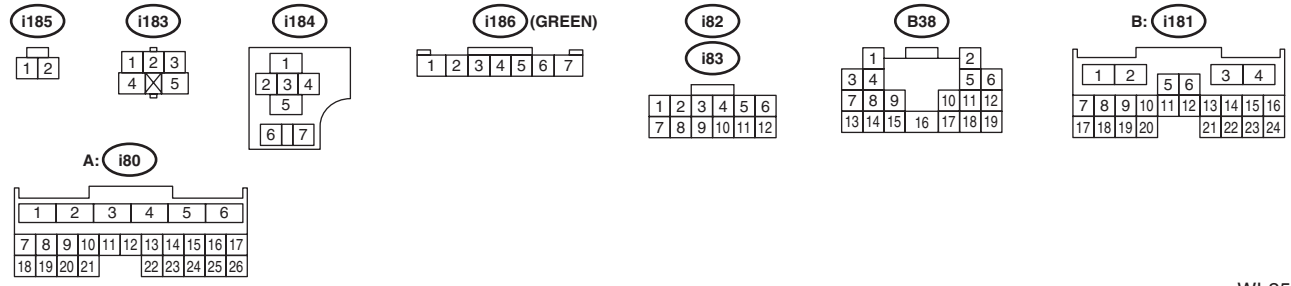
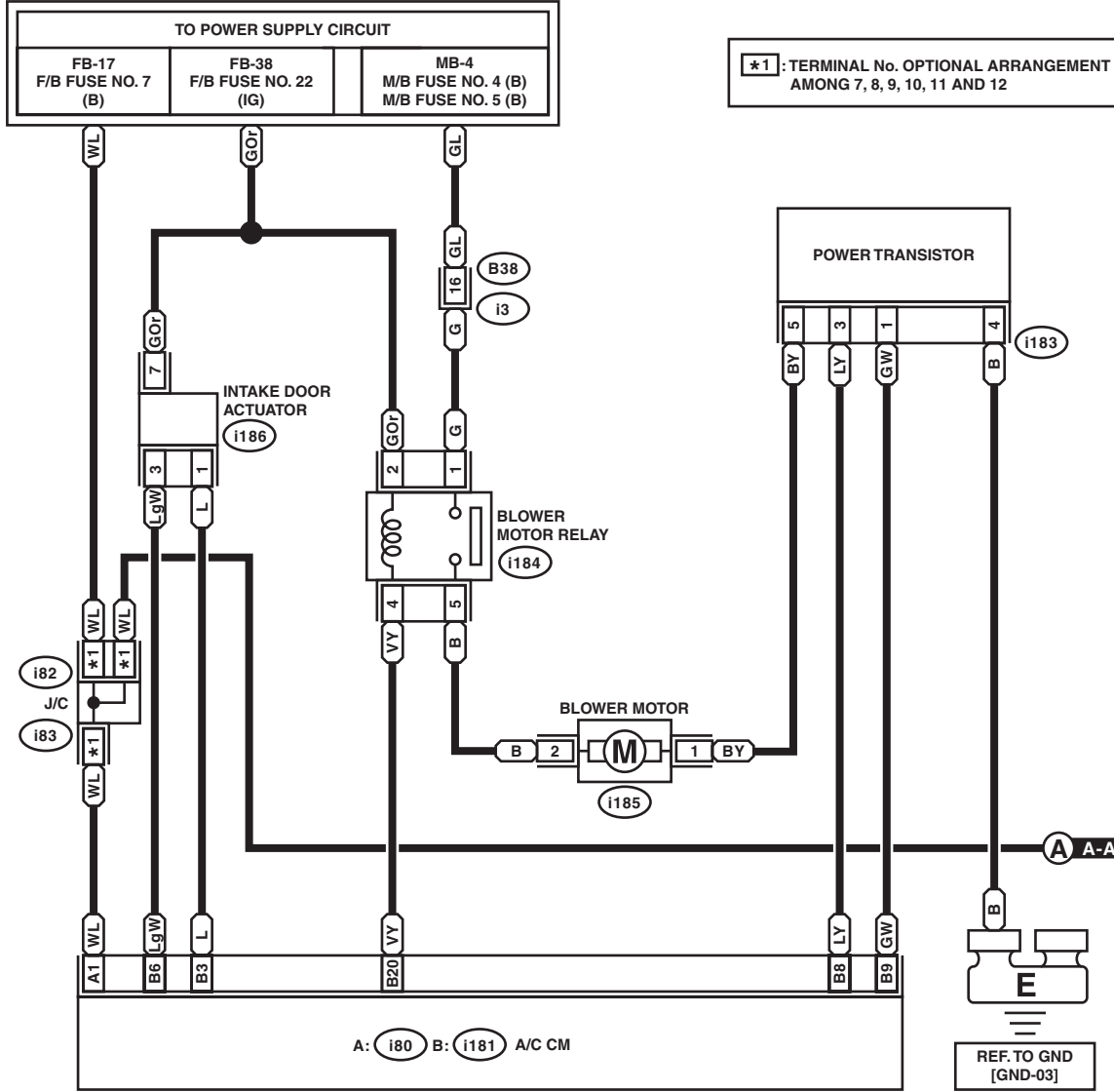

WI-25422

# Air Conditioning System

WIRING SYSTEM

A-A/C-03

A-A/C-03

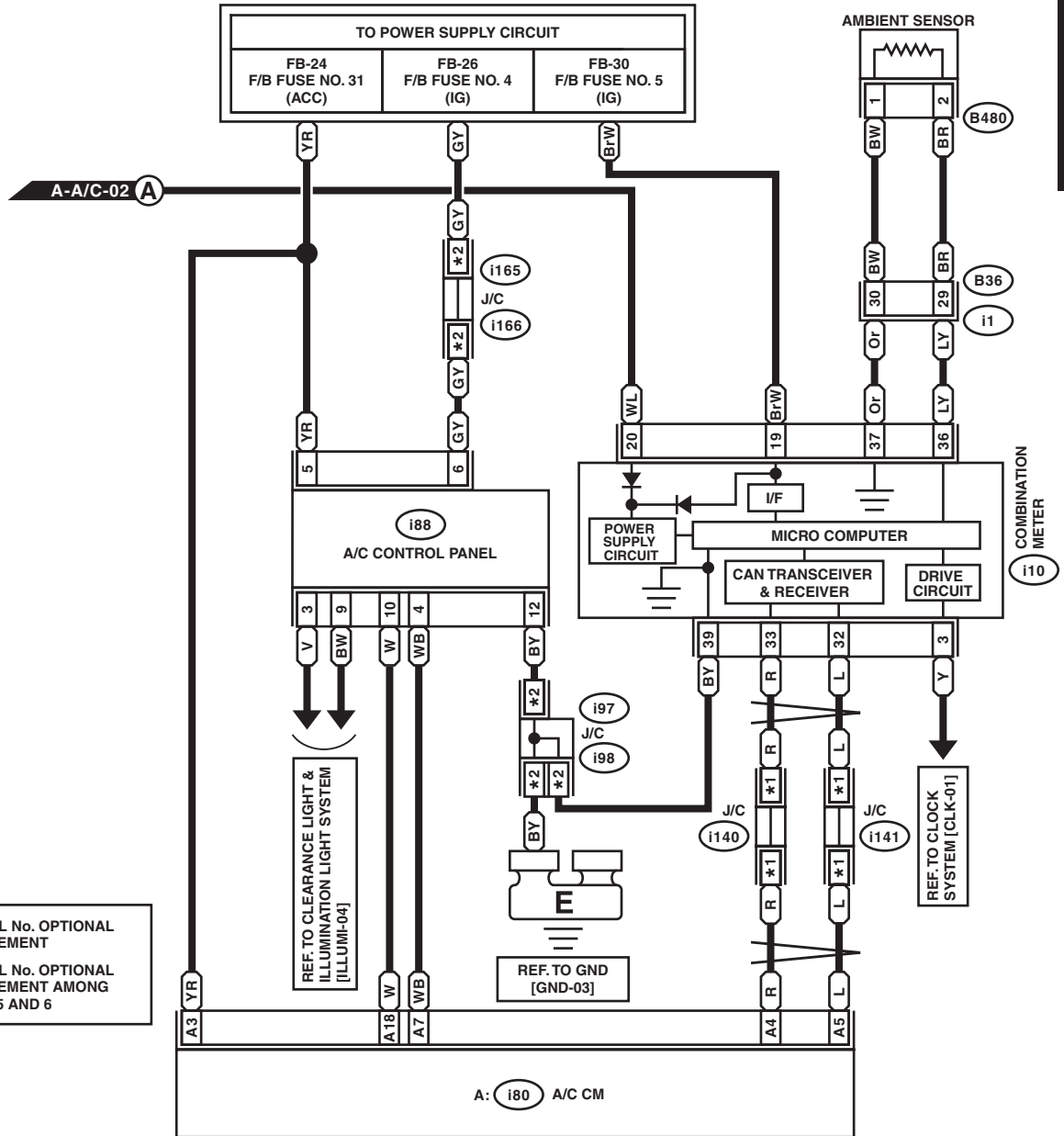

- \*1 : TERMINAL No. OPTIONAL ARRANGEMENT
- \*2 : TERMINAL No. OPTIONAL ARRANGEMENT AMONG 1, 2, 3, 4, 5 AND 6

B480 (BLACK)



i88 i165

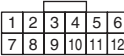
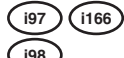

A: i80

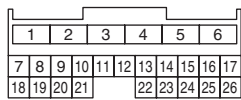

i10

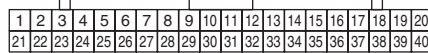

B36

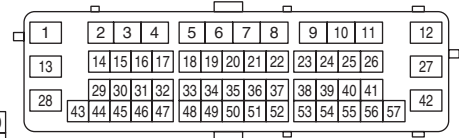

WI-25423

# Air Conditioning System

## WIRING SYSTEM

A-A/C-04

A-A/C-04

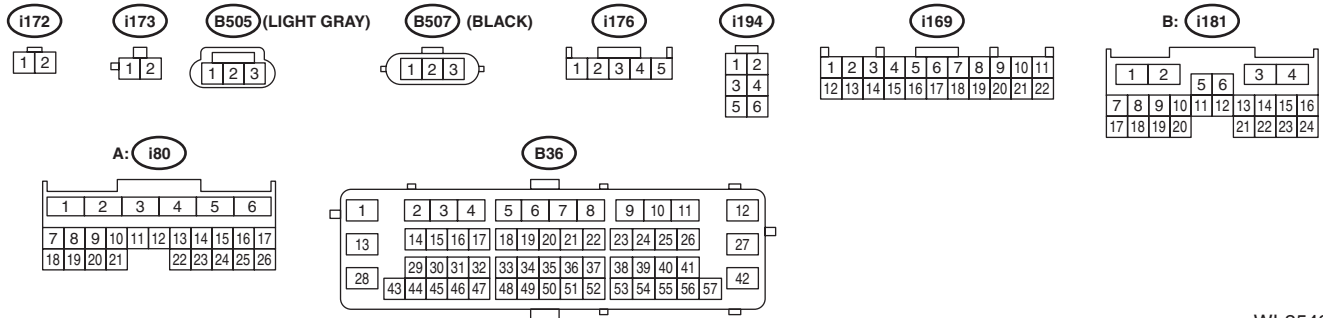
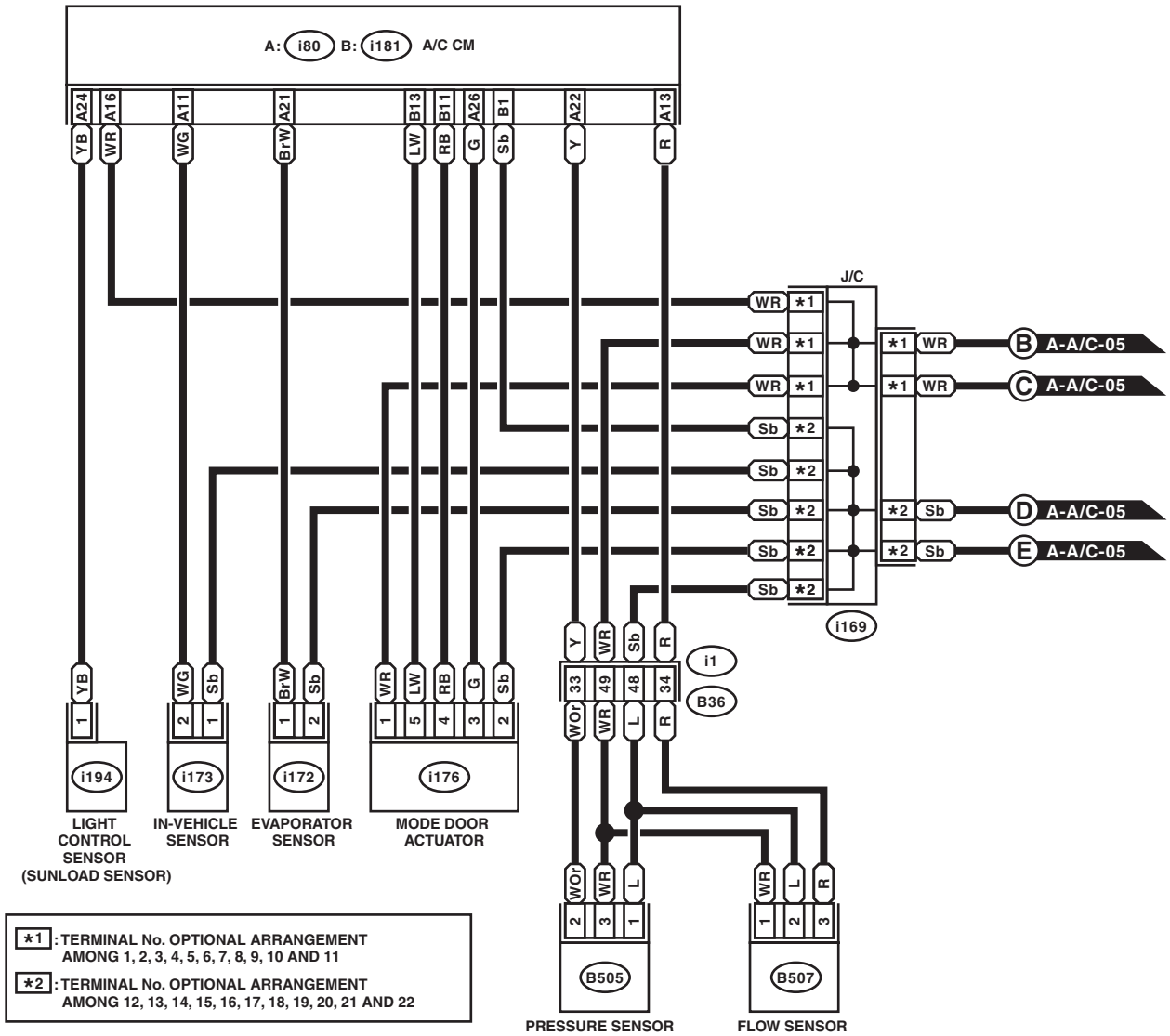

WI-25424



# Air Conditioning System

WIRING SYSTEM

A-A/C-05

A-A/C-05

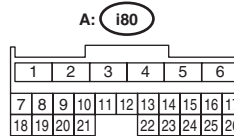
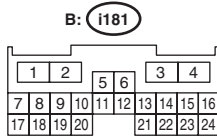
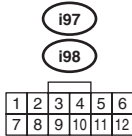
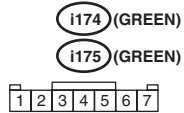
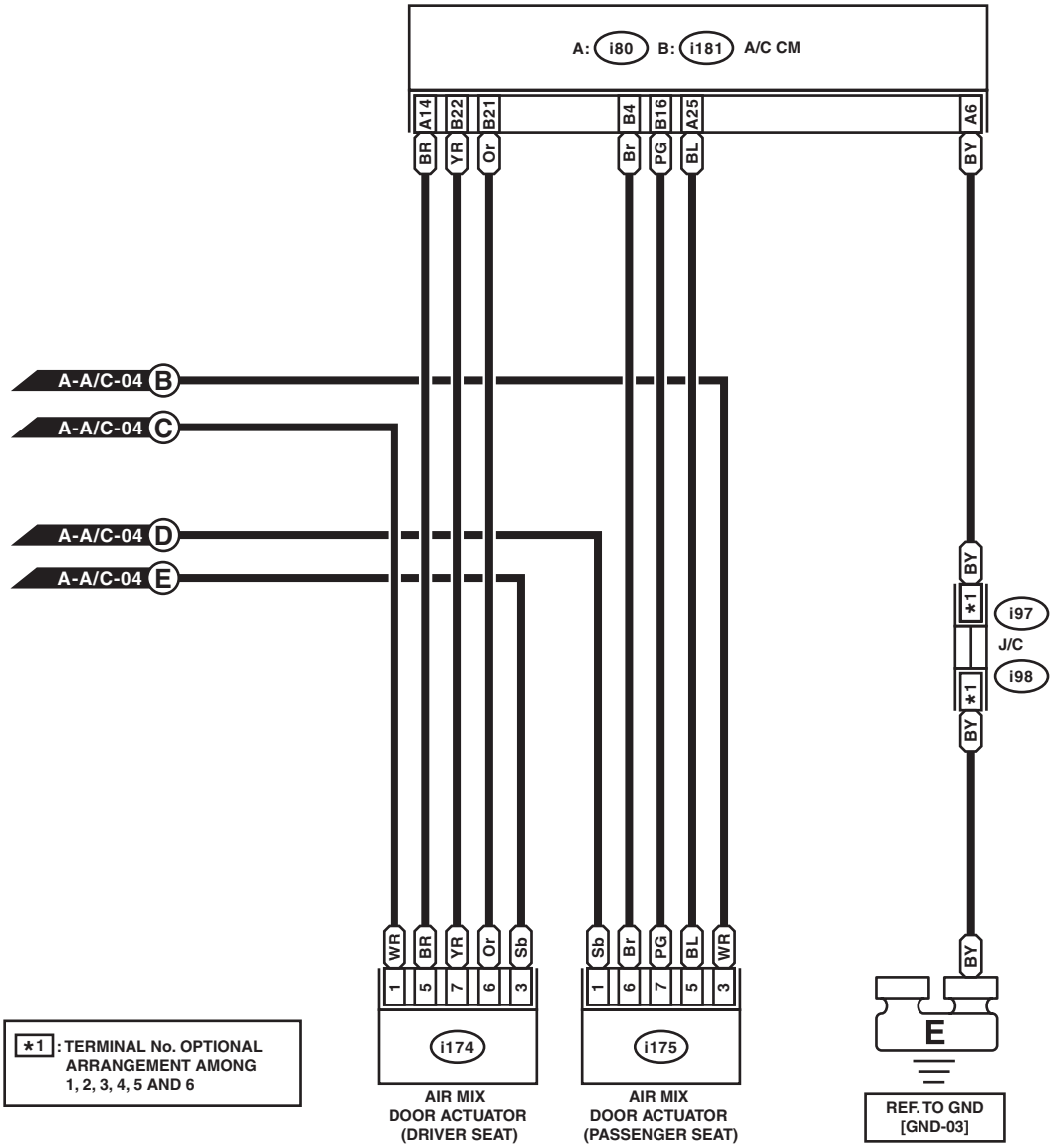

WI-25425