

Power Window System

WIRING SYSTEM

35. Power Window System

A: WIRING DIAGRAM

1. WITHOUT DRIVER'S SEAT AUTO UP FUNCTION

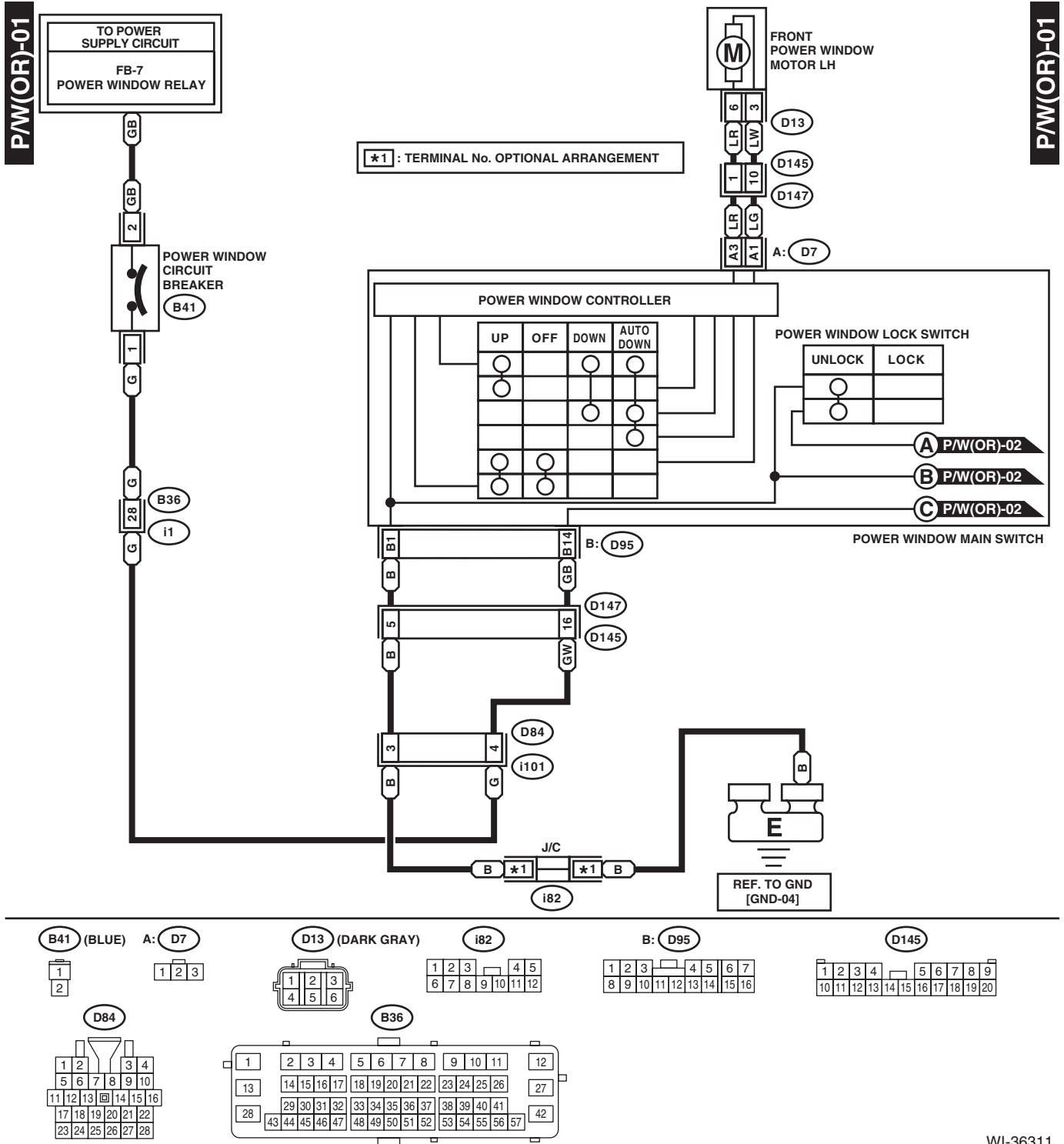

WI-36311

Power Window System

WIRING SYSTEM

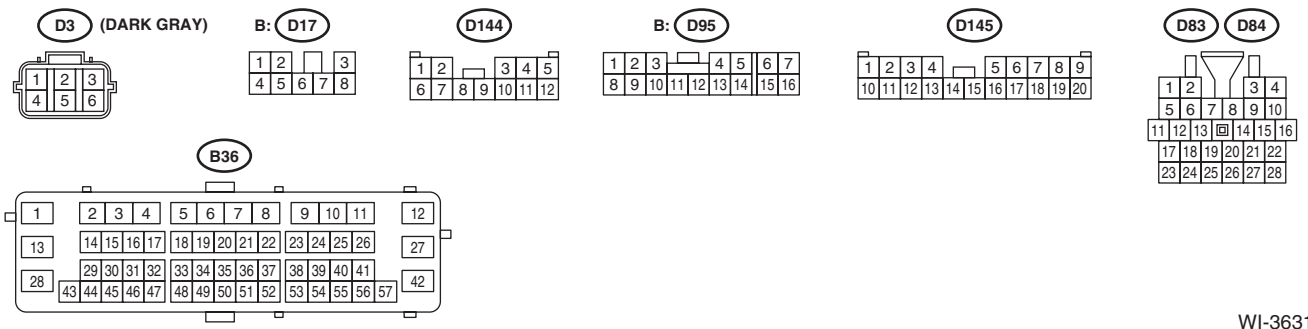
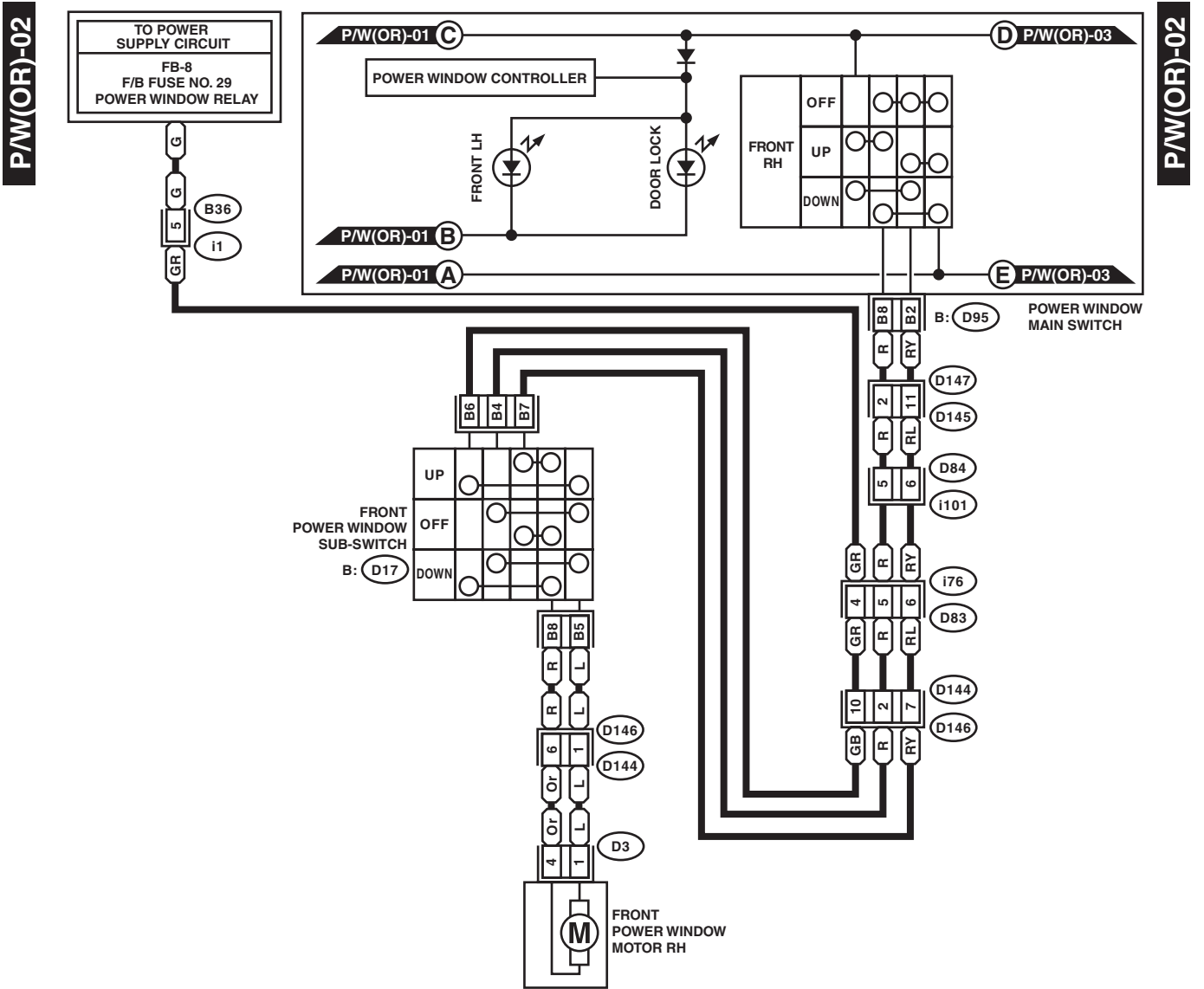

WI-36312

Power Window System

WIRING SYSTEM

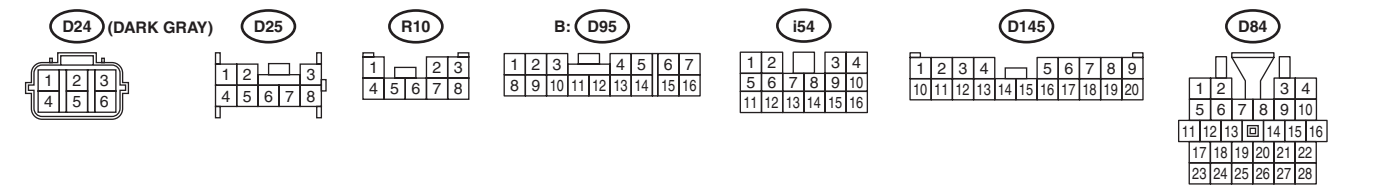
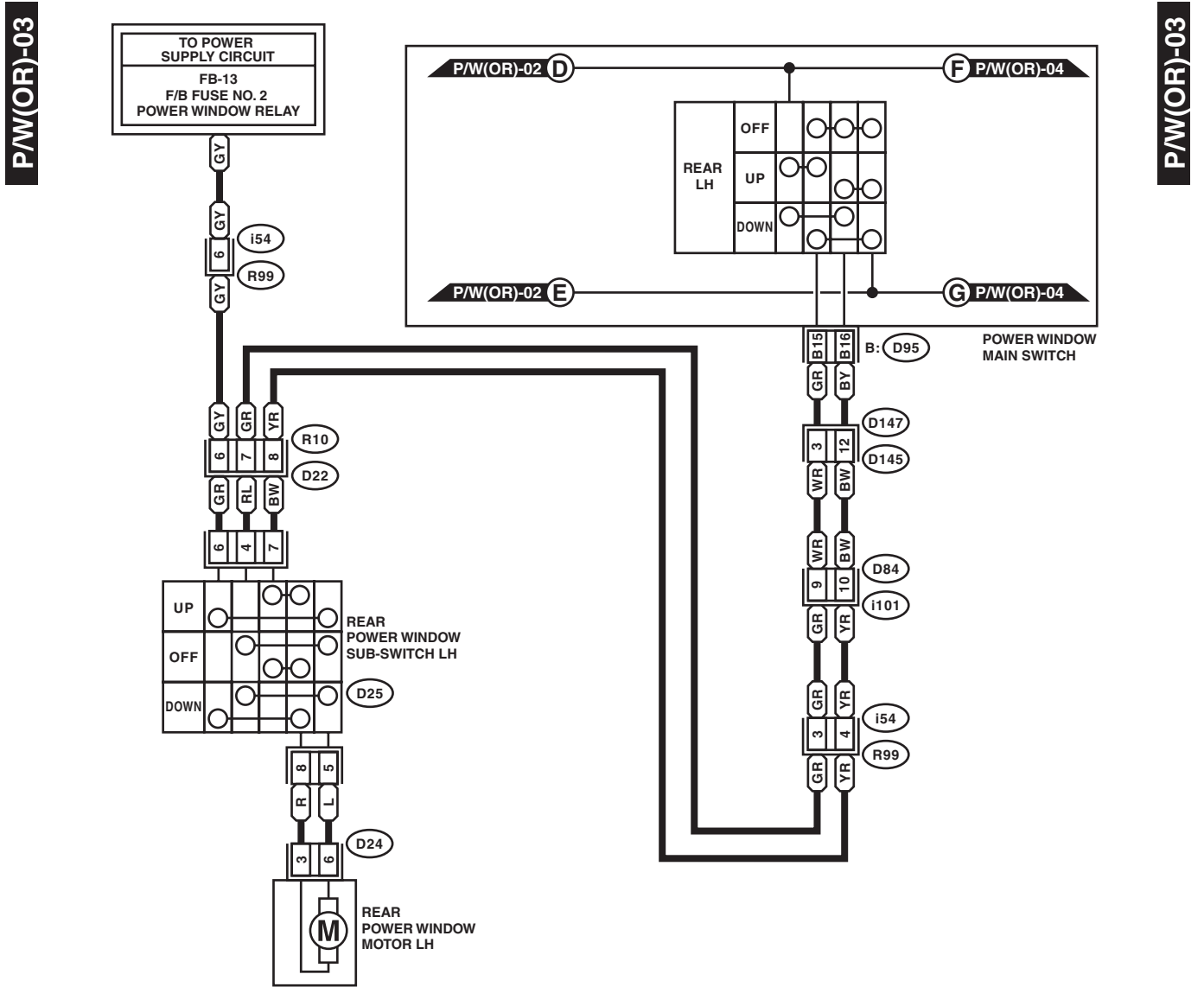

WI-36313

Power Window System

WIRING SYSTEM

P/W(OR)-04

P/W(OR)-04

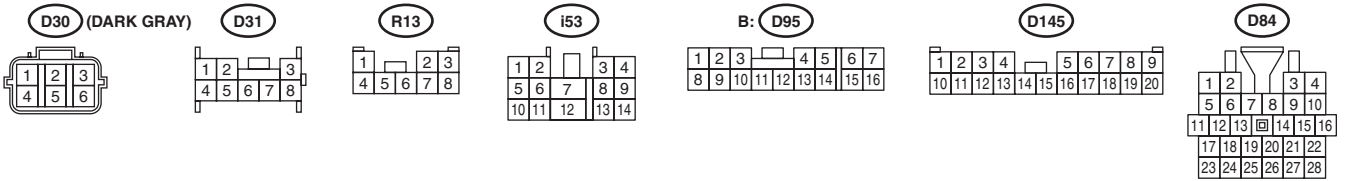
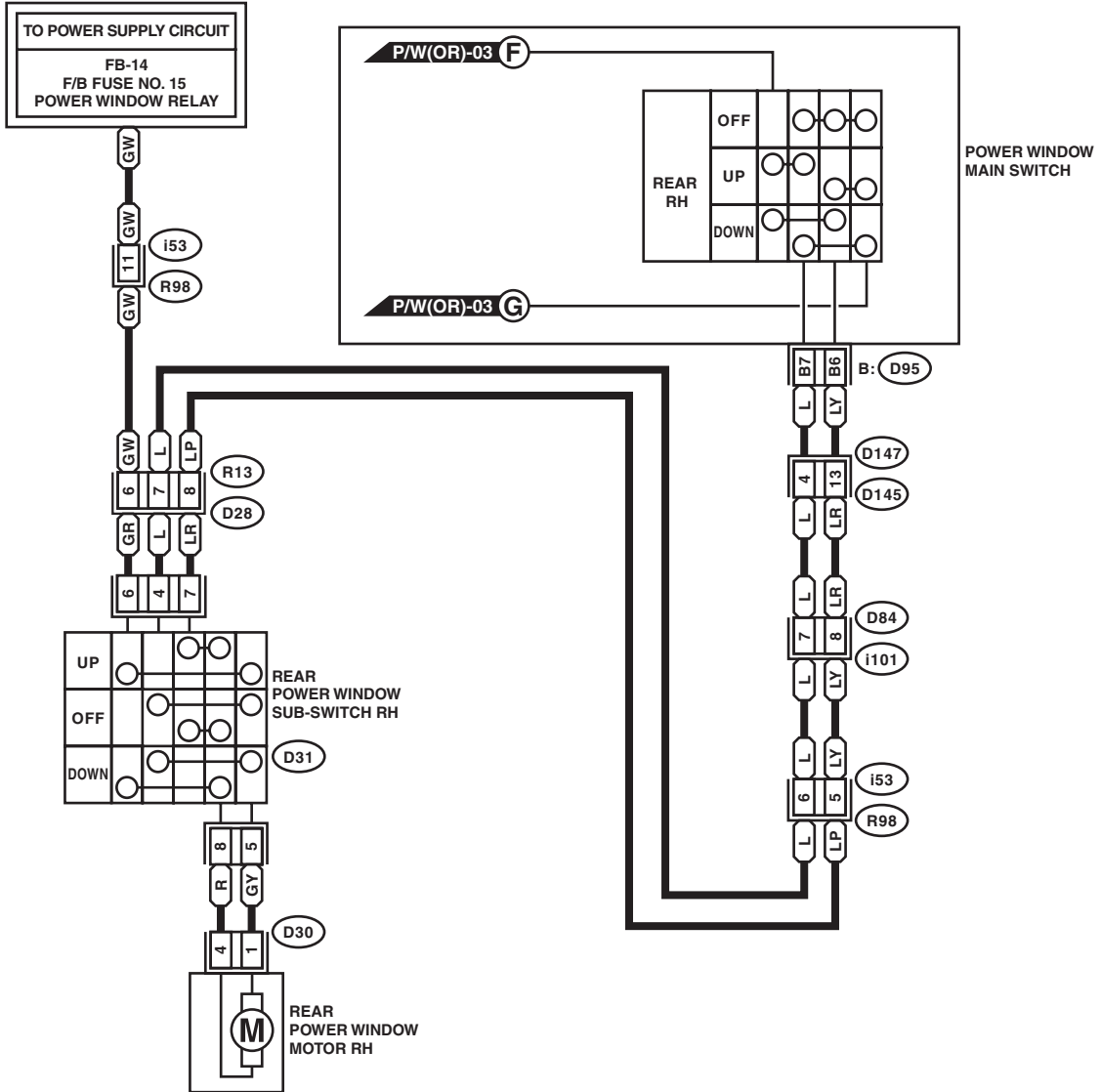

WI-36314

Power Window System

WIRING SYSTEM

2. WITH DRIVER'S SEAT AUTO UP FUNCTION

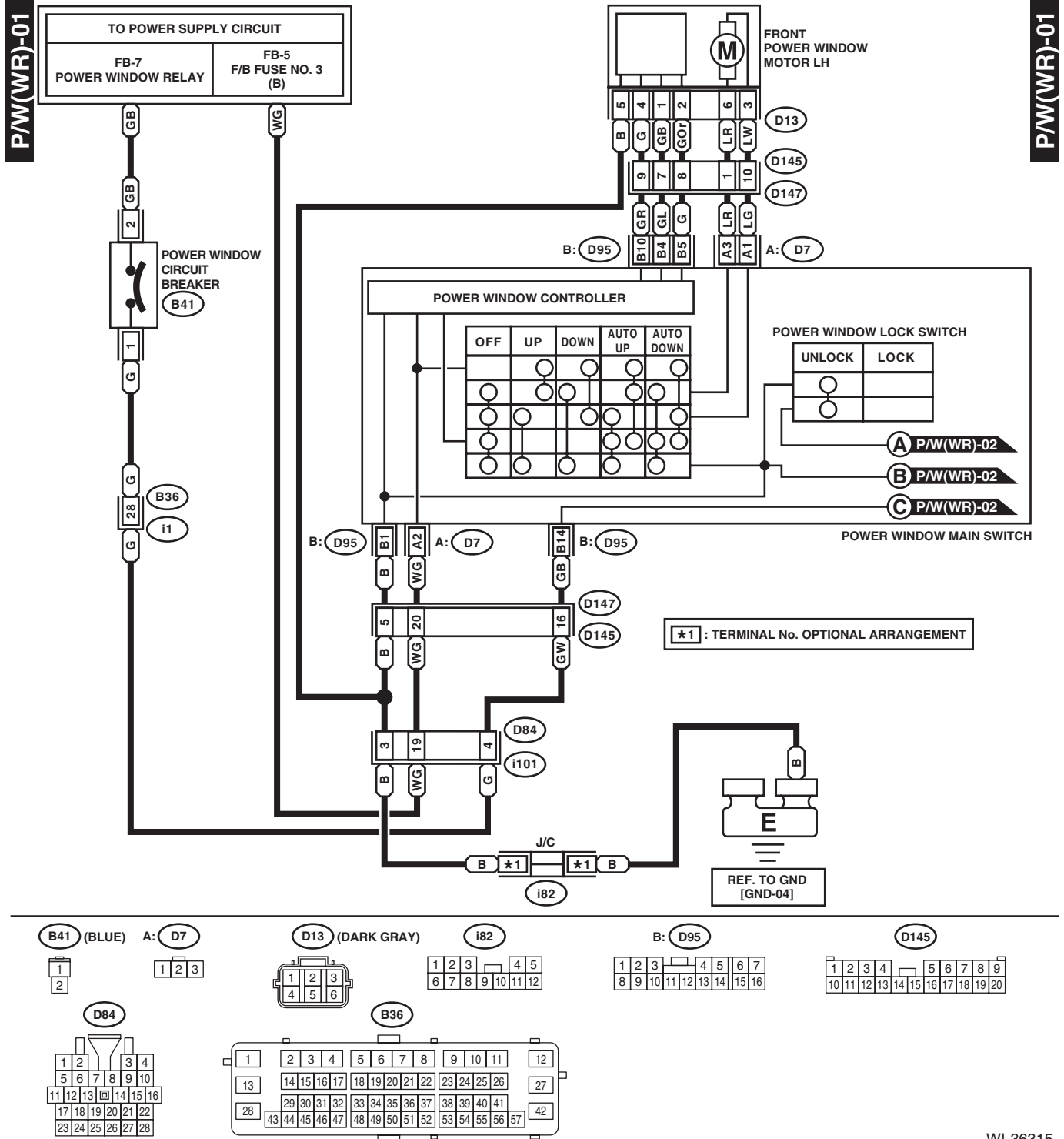

WI-36315

Power Window System

WIRING SYSTEM

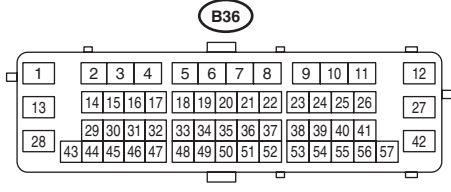
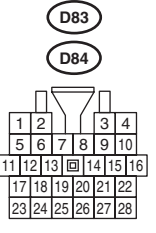
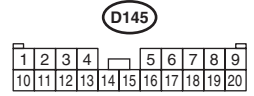
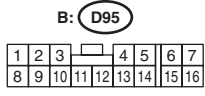
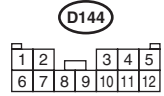
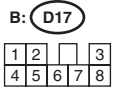
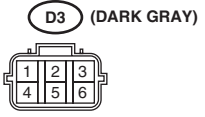
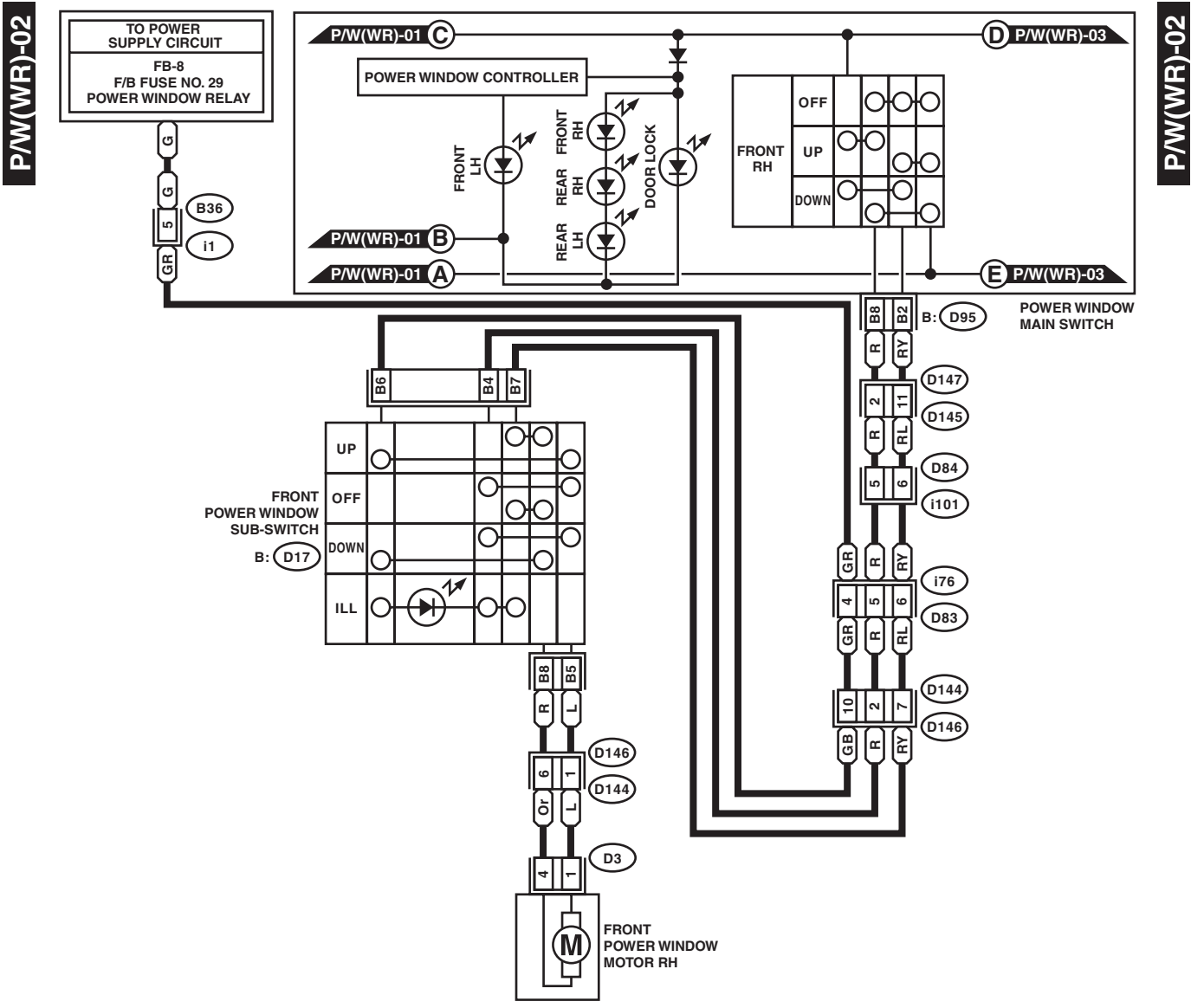

WI-36316

Power Window System

WIRING SYSTEM

P/W(WR)-03

P/W(WR)-03

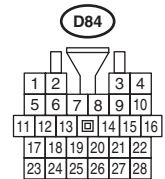
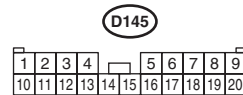
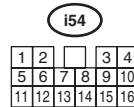
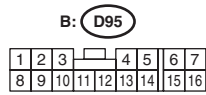
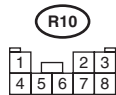
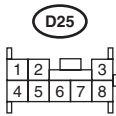
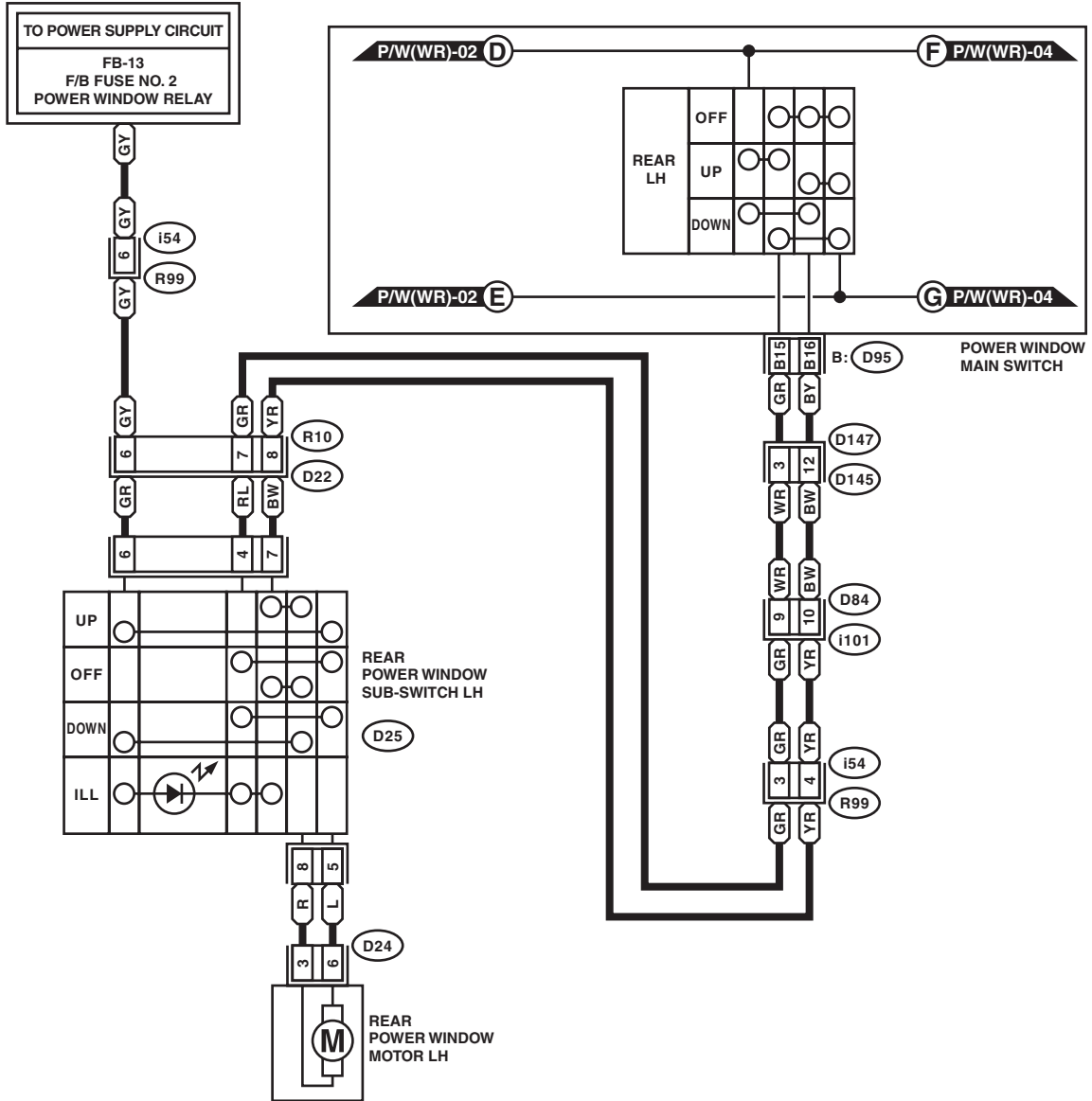

WI-36317

Power Window System

WIRING SYSTEM

P/W(WR)-04

P/W(WR)-04

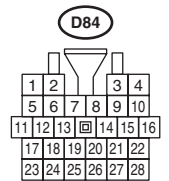
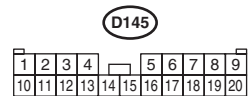
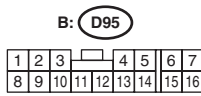
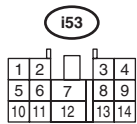
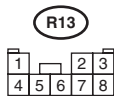
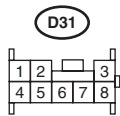
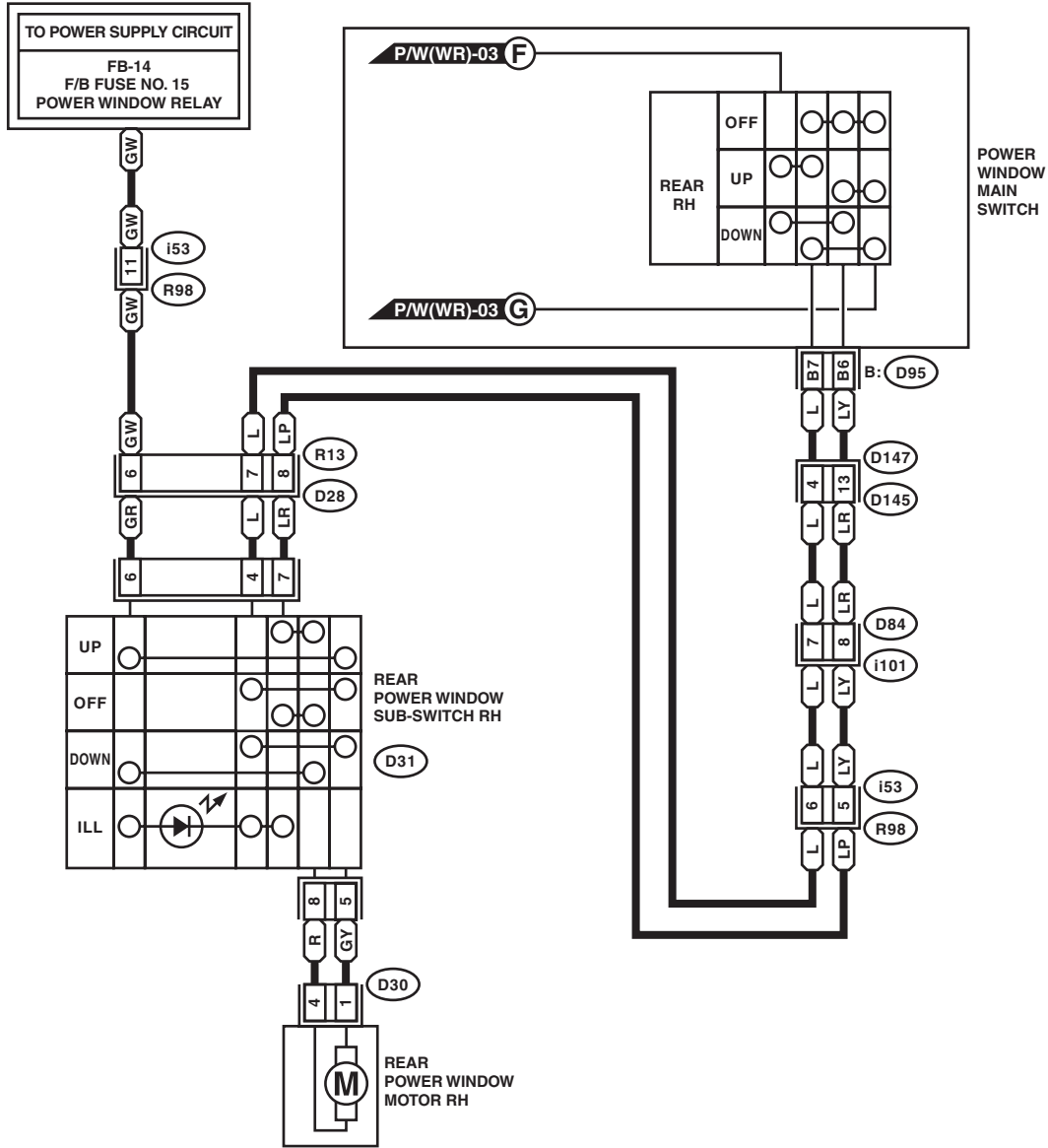

WI-36318