

## 6. Air Conditioning System

### A: WIRING DIAGRAM

#### 1. MANUAL A/C

M-A/C-01

M-A/C-01

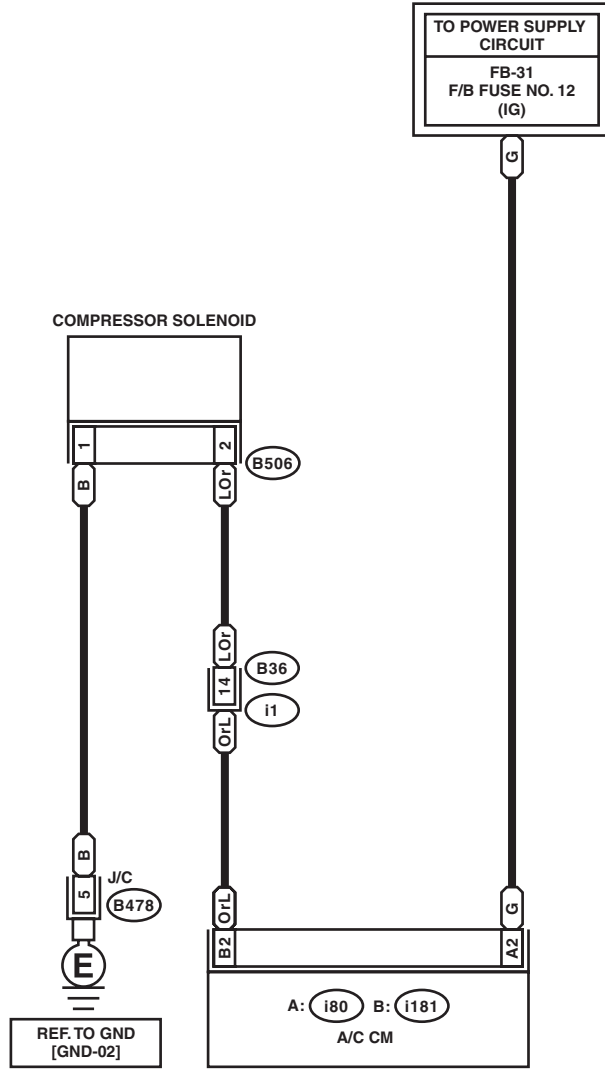

**B506** (LIGHT GRAY)



**B478**

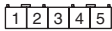

**B: i181**

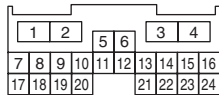

**A: i80**

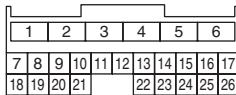

**B36**

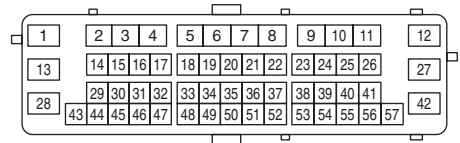

WI-36147

# Air Conditioning System

## WIRING SYSTEM

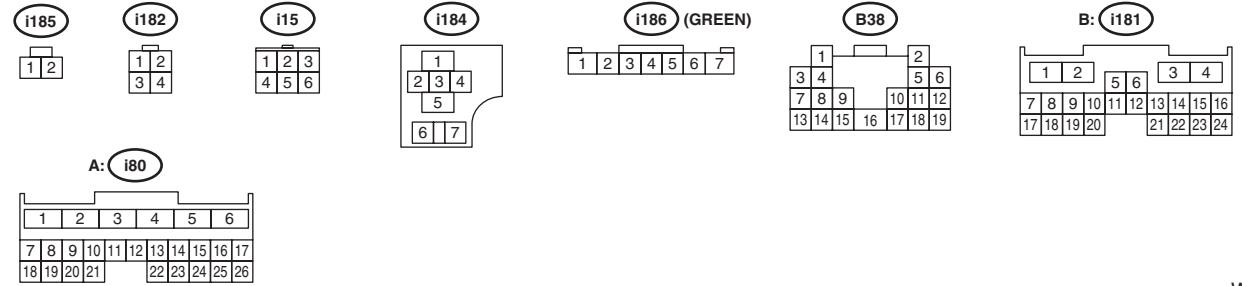
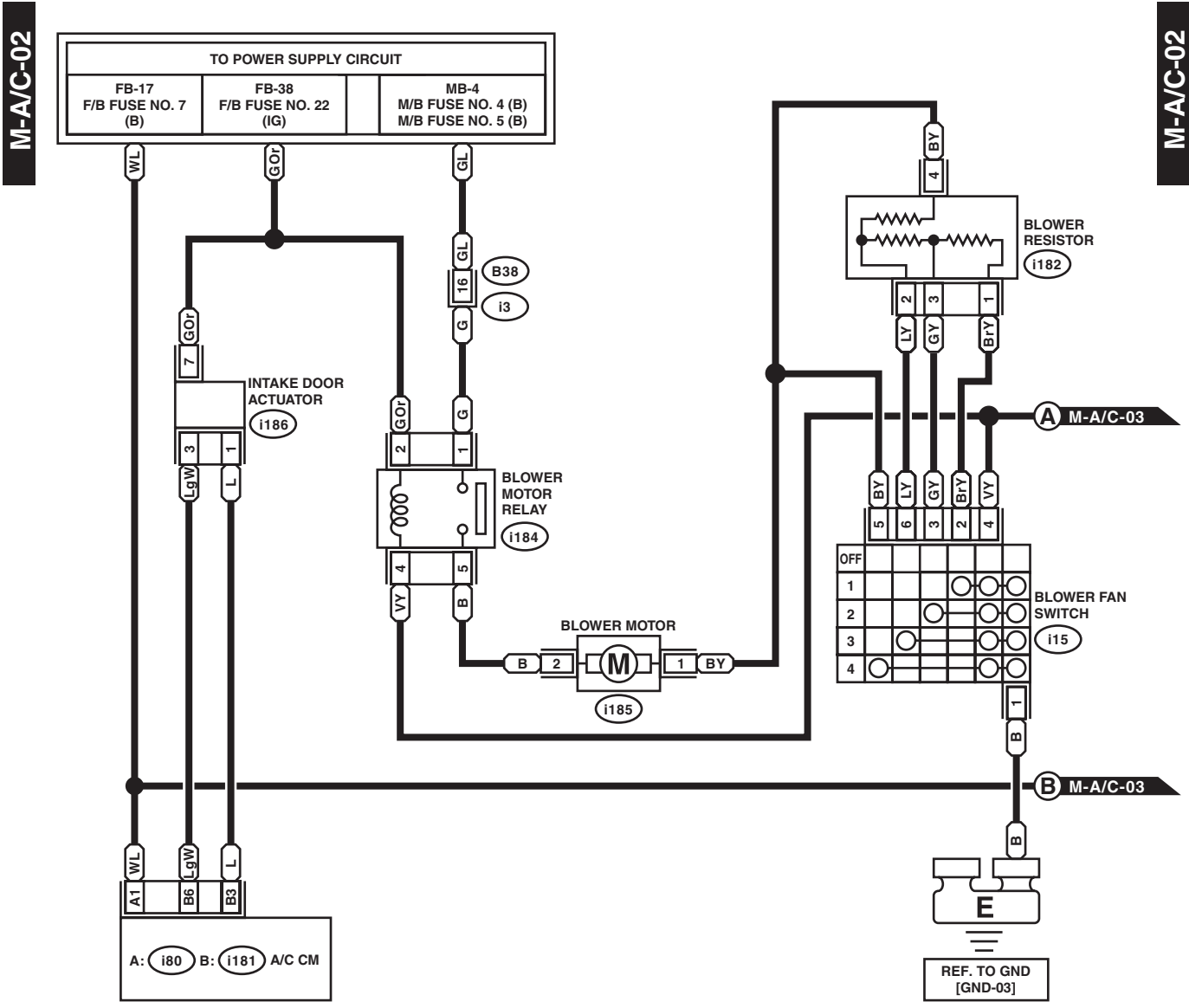

WI-33852

# Air Conditioning System

WIRING SYSTEM

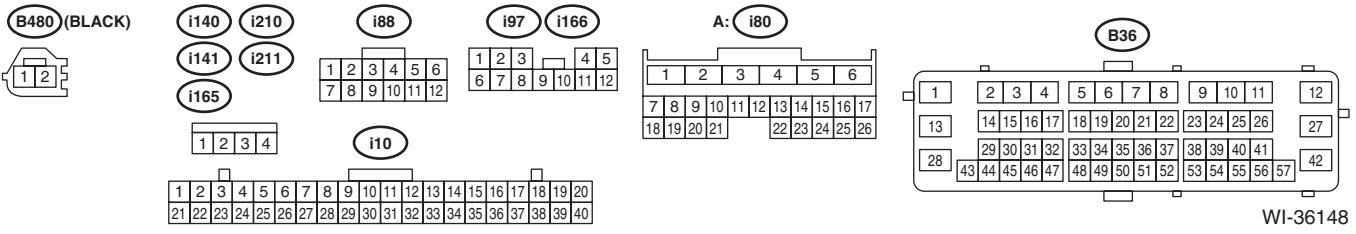
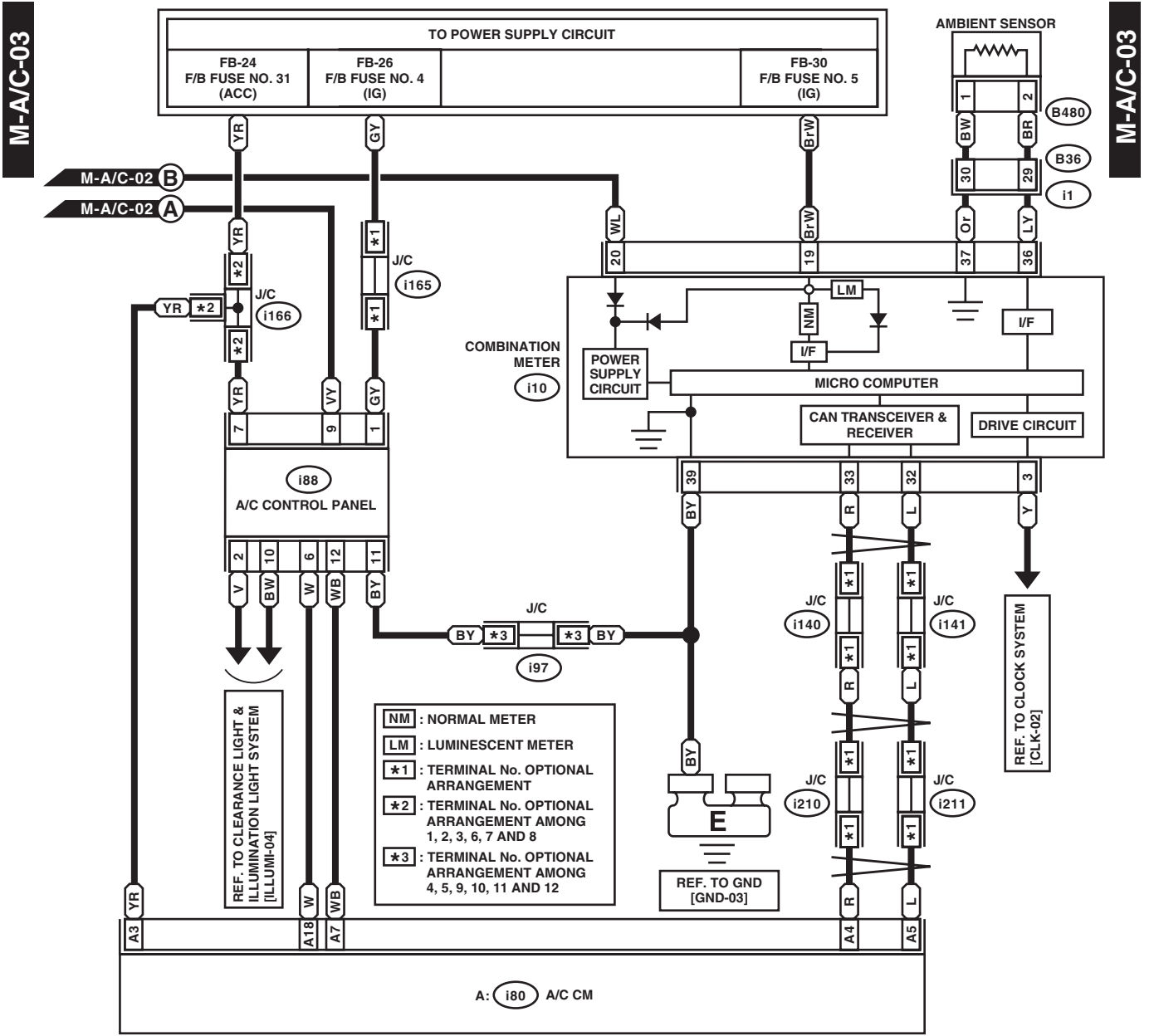

WI-36148

# Air Conditioning System

## WIRING SYSTEM

M-A/C-04

M-A/C-04

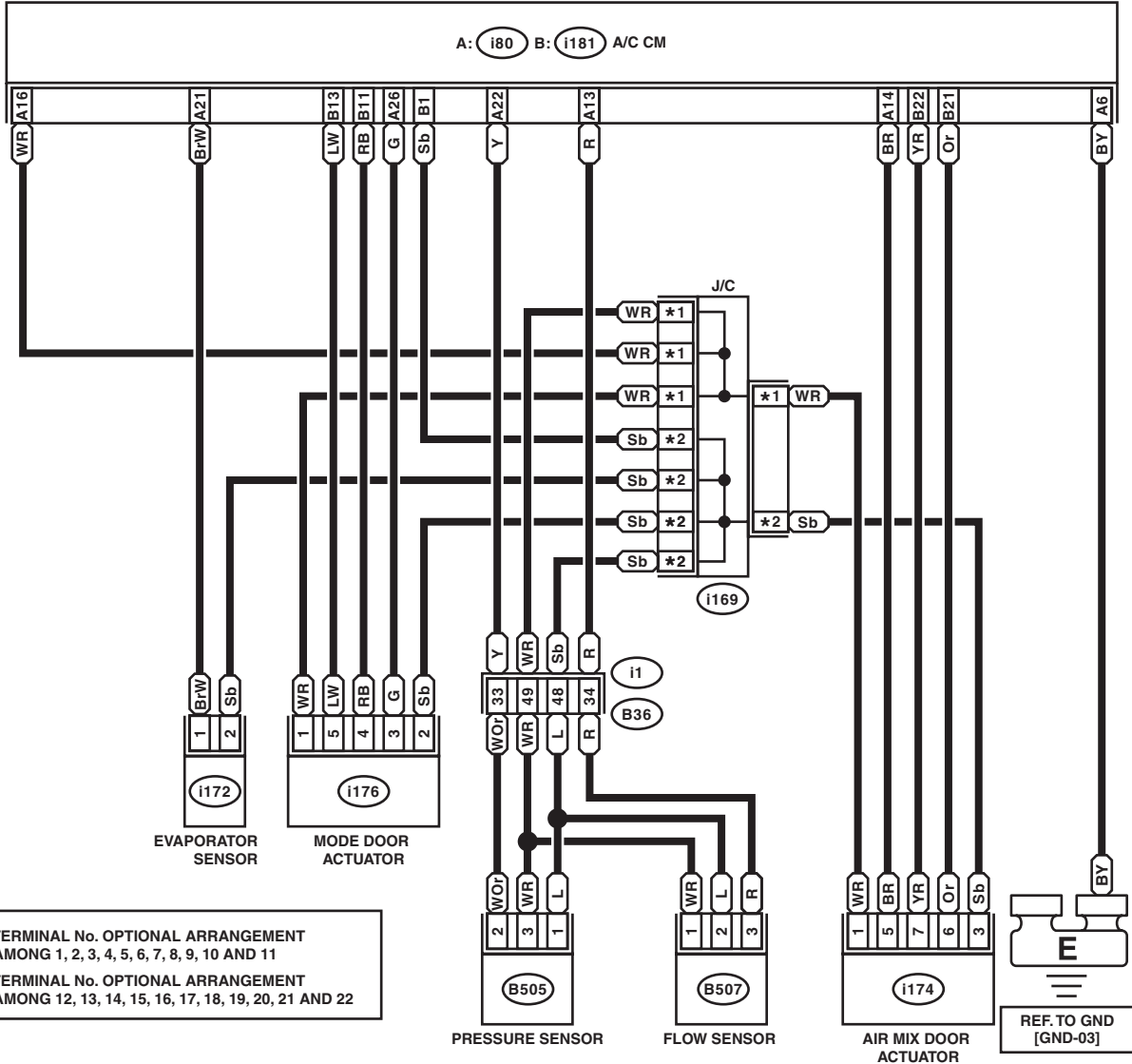

\*1: TERMINAL No. OPTIONAL ARRANGEMENT AMONG 1, 2, 3, 4, 5, 6, 7, 8, 9, 10 AND 11  
 \*2: TERMINAL No. OPTIONAL ARRANGEMENT AMONG 12, 13, 14, 15, 16, 17, 18, 19, 20, 21 AND 22

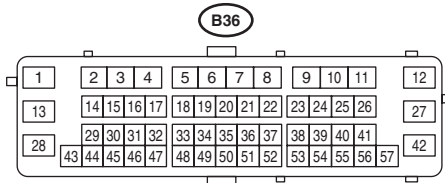
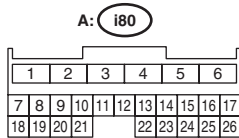
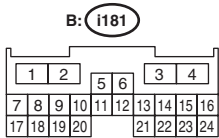
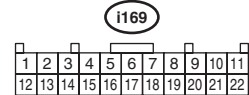
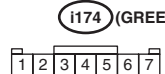
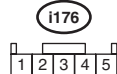
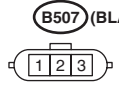

WI-29319

# Air Conditioning System

WIRING SYSTEM

## 2. AUTO A/C

A-A/C-01

A-A/C-01

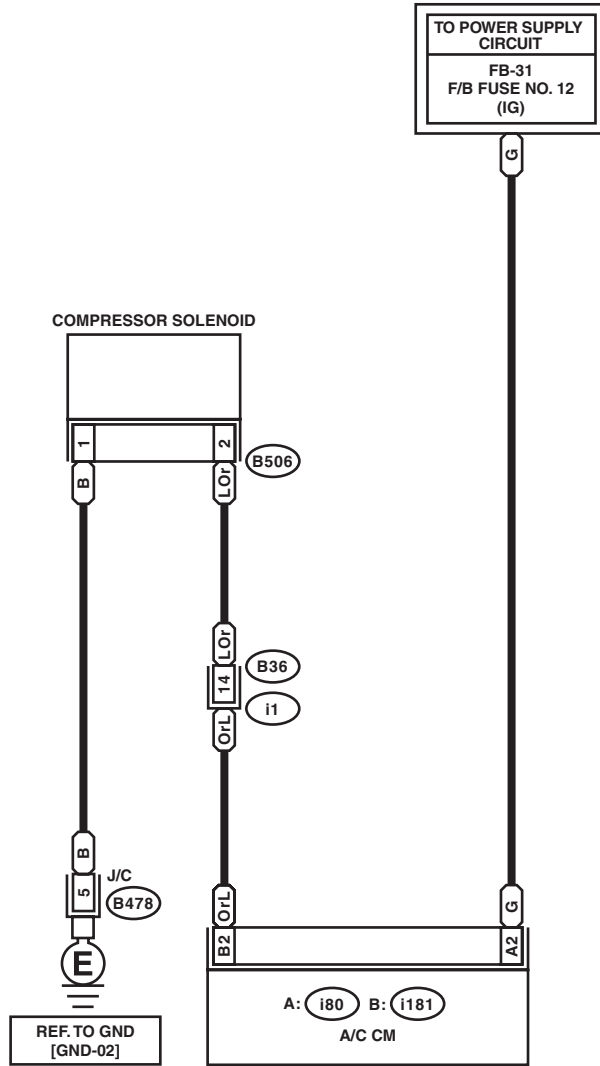

B506 (LIGHT GRAY)



B478

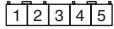

B: i181

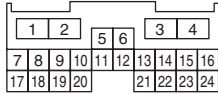

A: 180

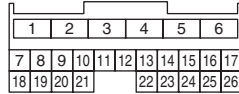

B36

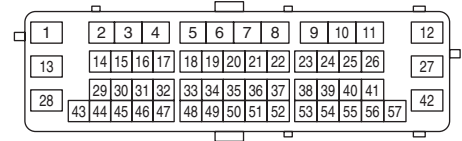

WI-36149

# Air Conditioning System

## WIRING SYSTEM

A-A/C-02

A-A/C-02

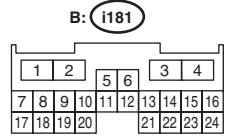
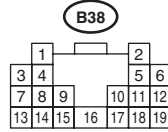
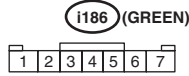
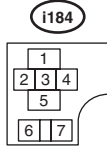
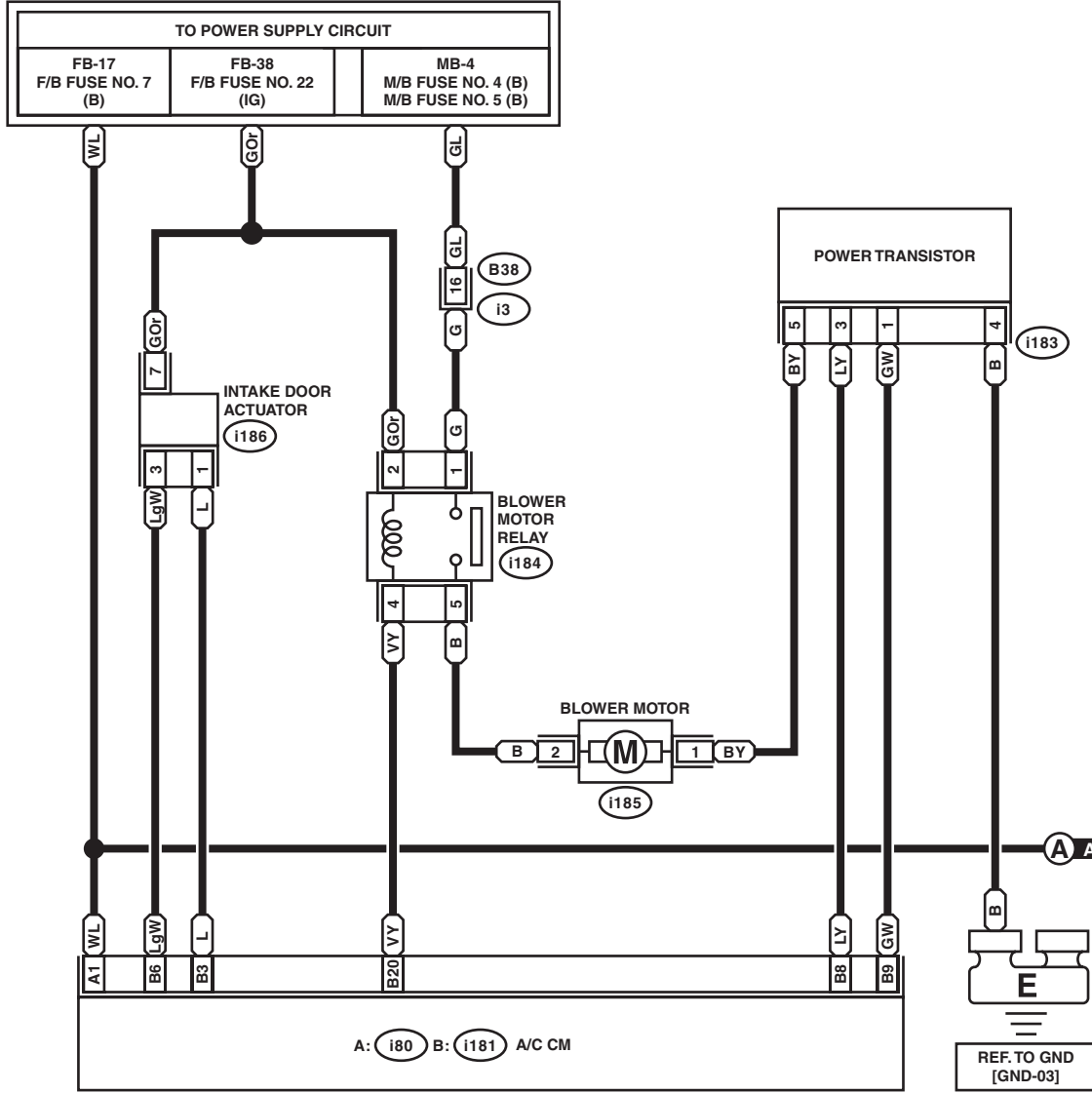

A: i80

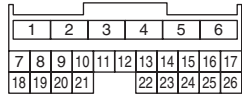

WI-29320

# Air Conditioning System

WIRING SYSTEM

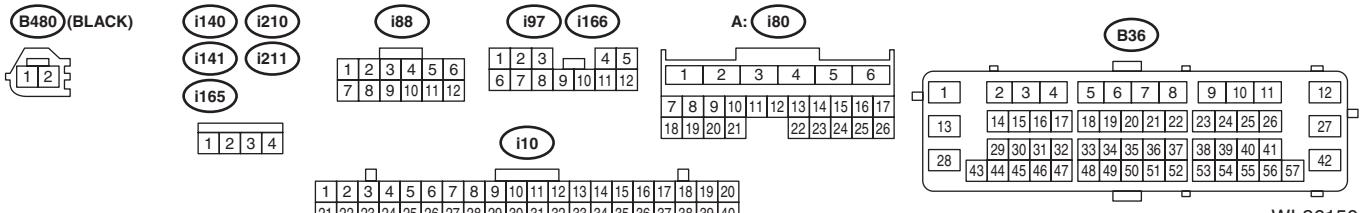
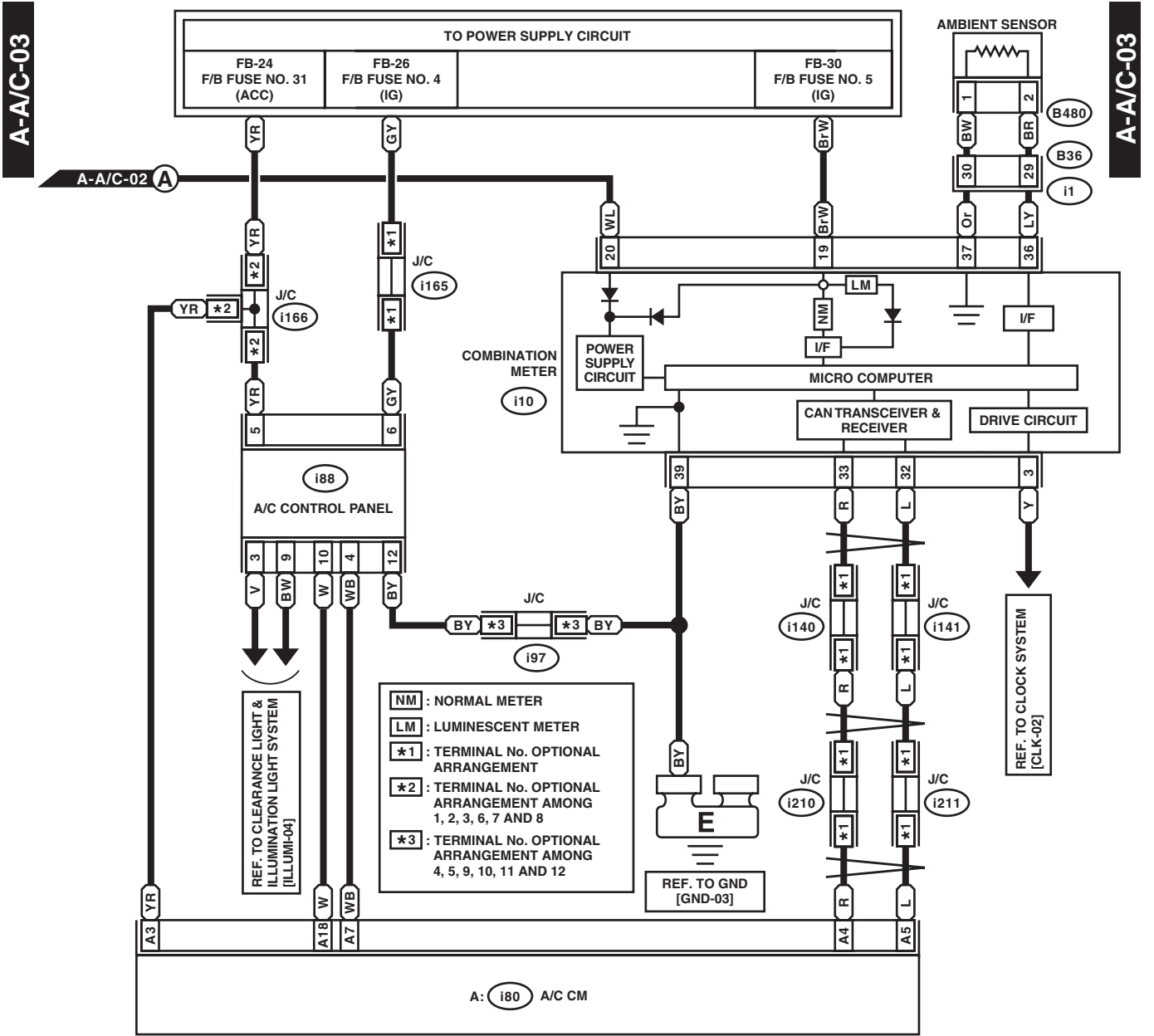

WI-36150

# Air Conditioning System

## WIRING SYSTEM

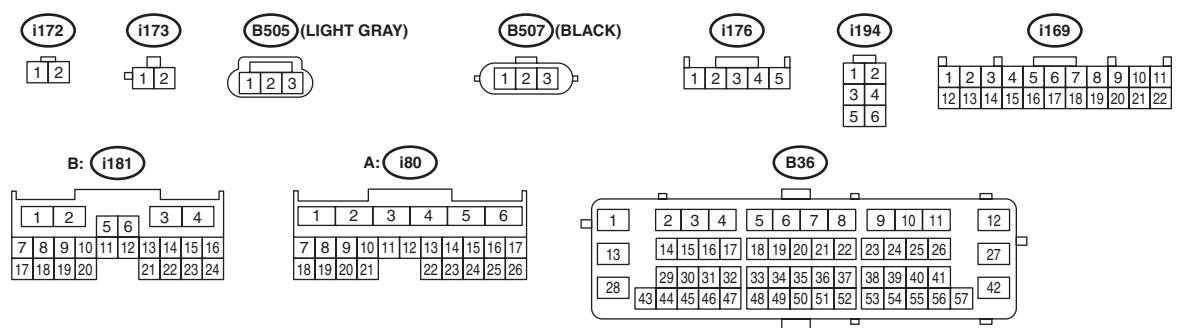
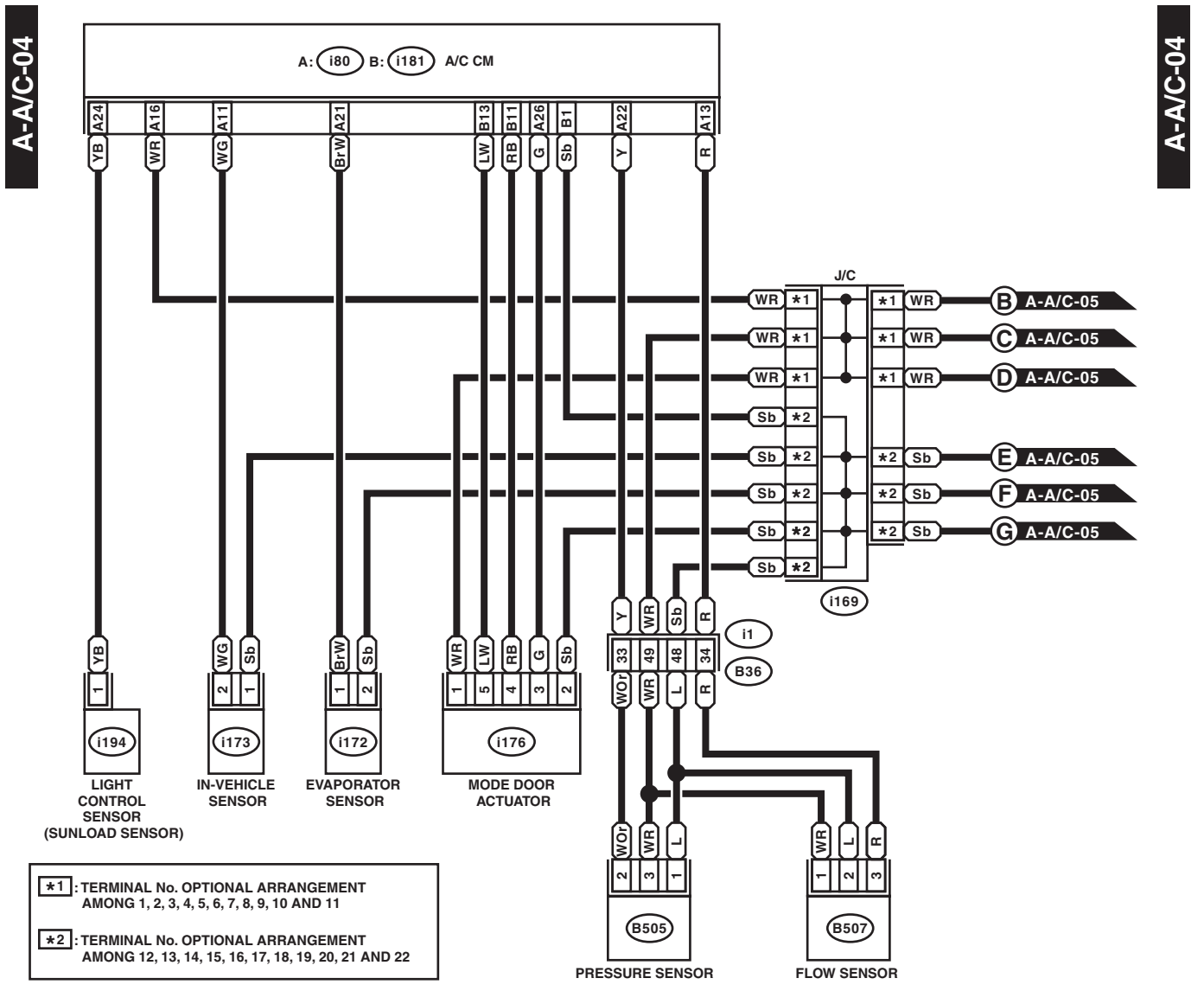

WI-36151



# Air Conditioning System

WIRING SYSTEM

A-A/C-05

A-A/C-05

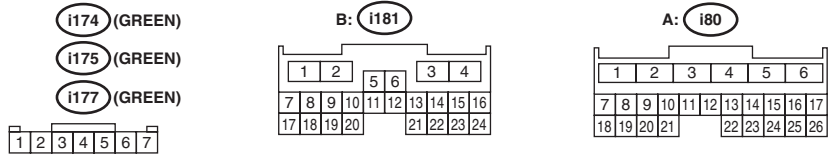
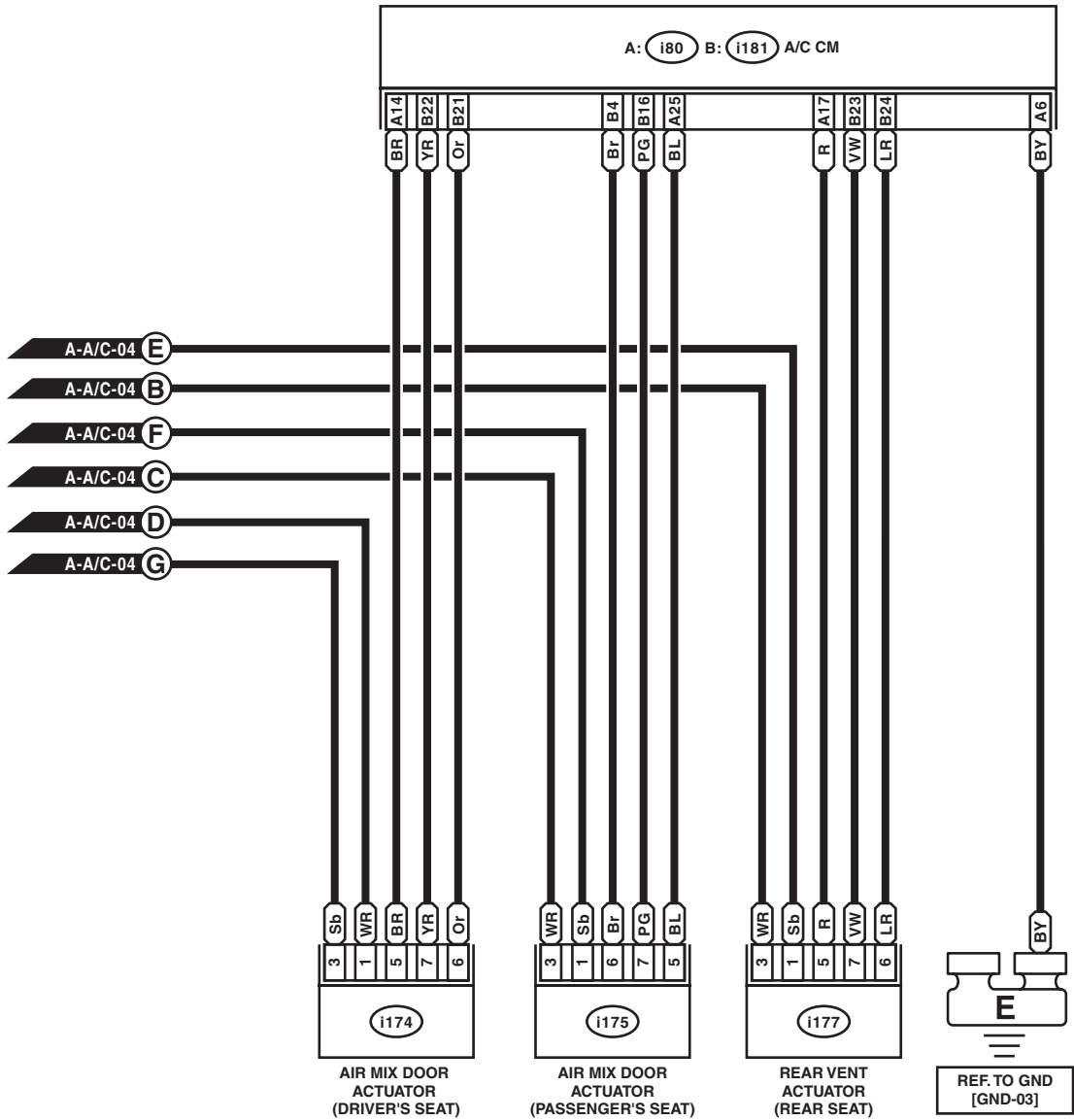

WI-36152