

6. Oil Pressure Switch

A: REMOVAL

CAUTION:

If the engine oil is spilt over exhaust pipe or the under cover, wipe it off with cloth to avoid emitting smoke or causing a fire.

- 1) Disconnect the ground cable from battery.

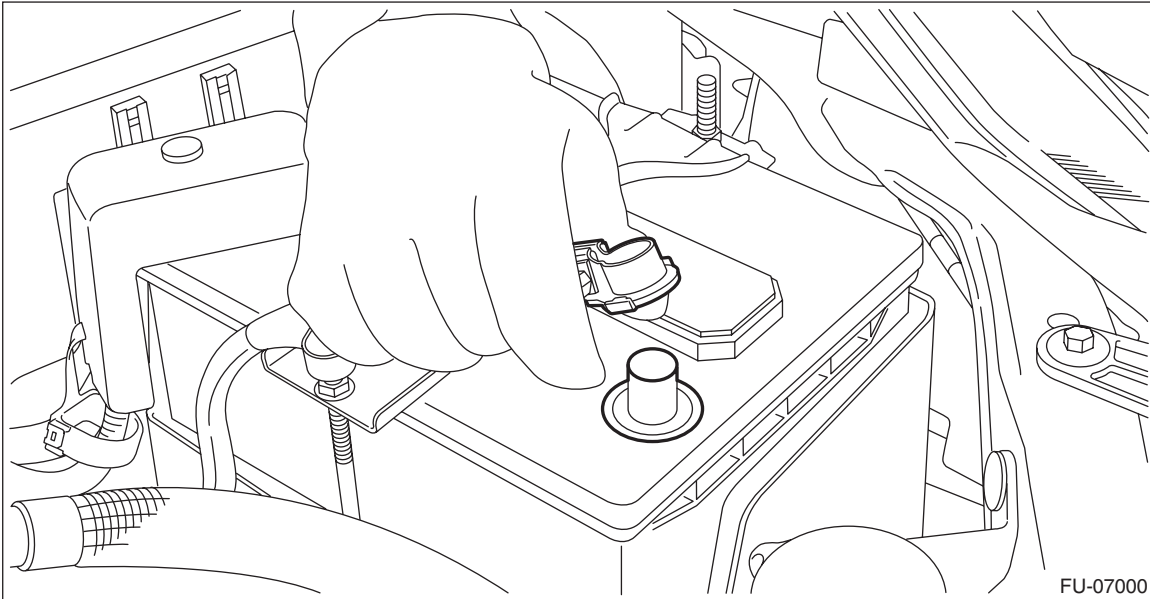

- 2) Disconnect the terminal from oil pressure switch.

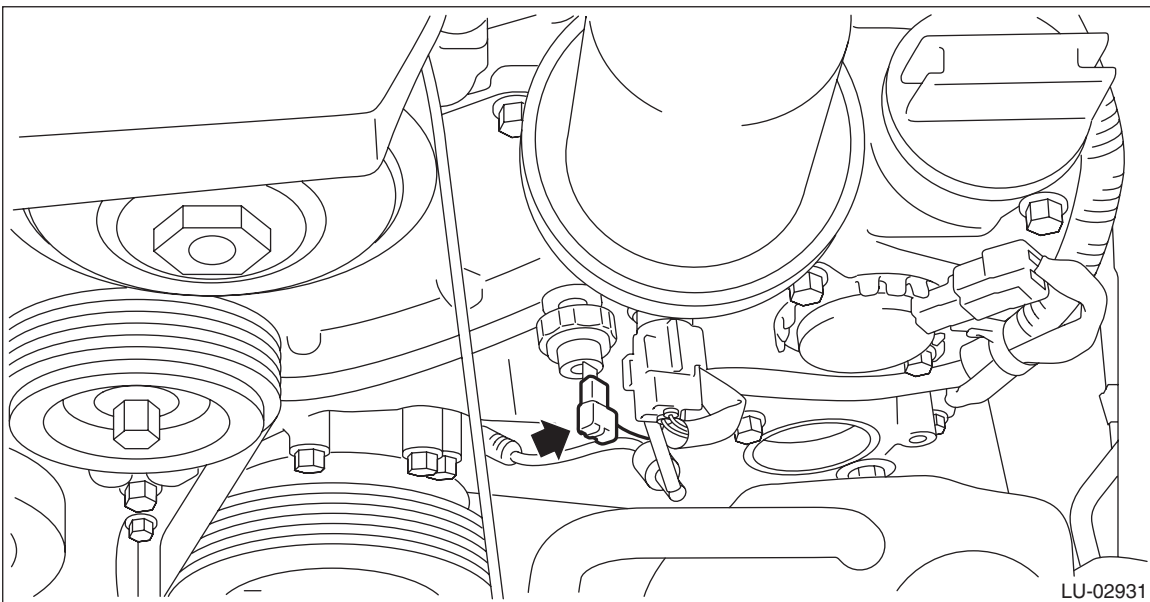

Oil Pressure Switch

LUBRICATION

3) Remove the oil pressure switch.

CAUTION:

Catch the engine oil using cloth to prevent it from splashing.

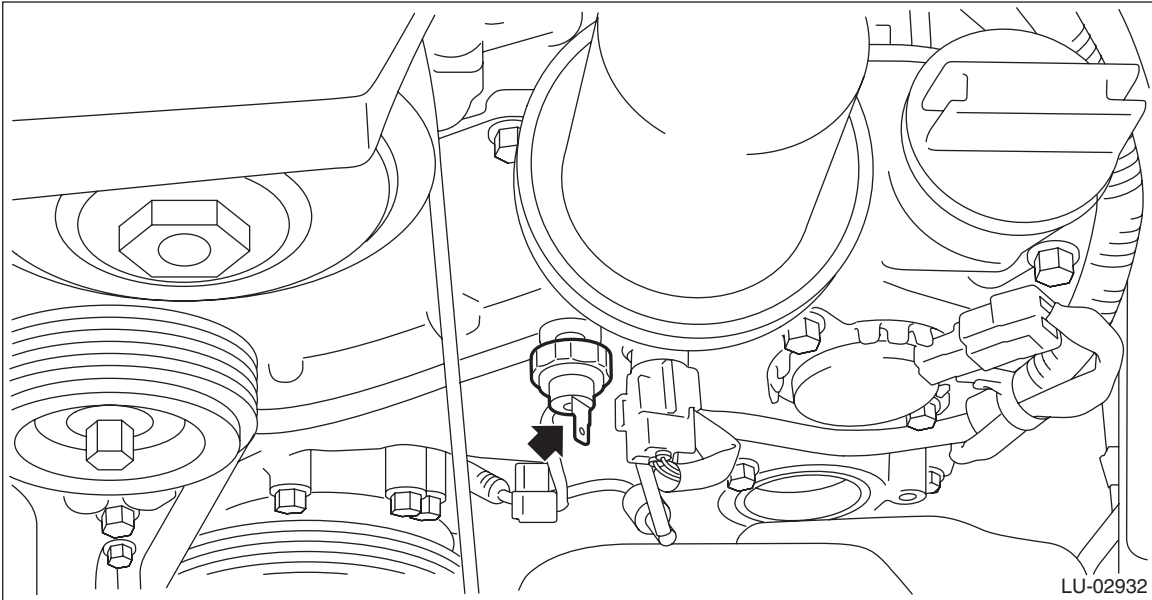

B: INSTALLATION

1) Apply liquid gasket to the oil pressure switch threads.

Liquid gasket:

THREE BOND 1324 (Part No. 004403042) or equivalent

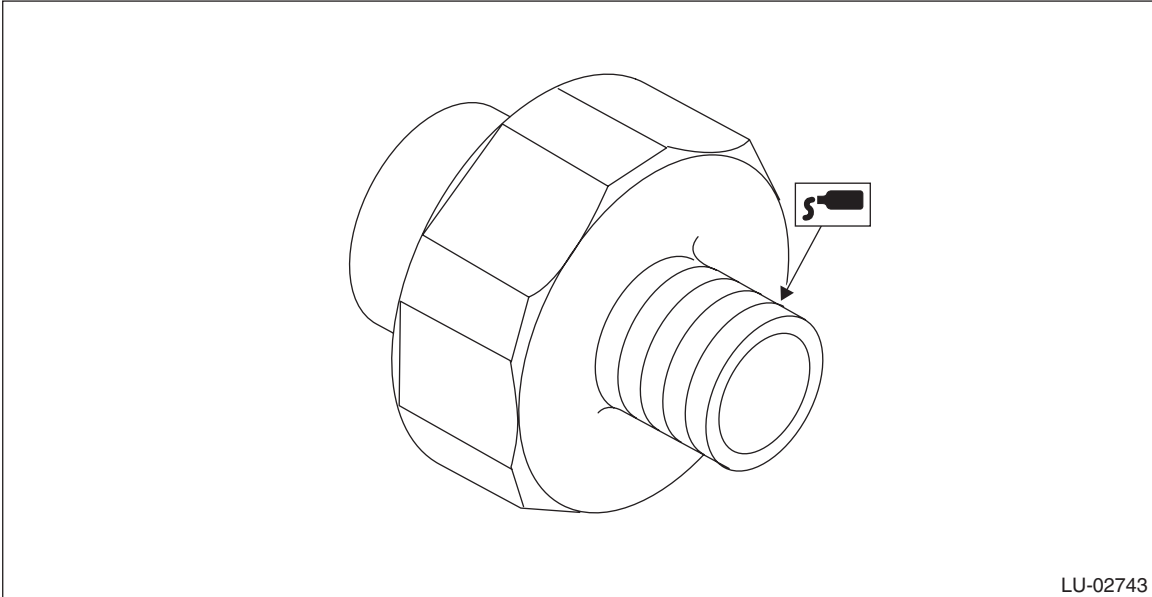

2) Install the oil pressure switch to the chain cover.

Tightening torque:

18 N·m (1.8 kgf·m, 13.3 ft·lb)

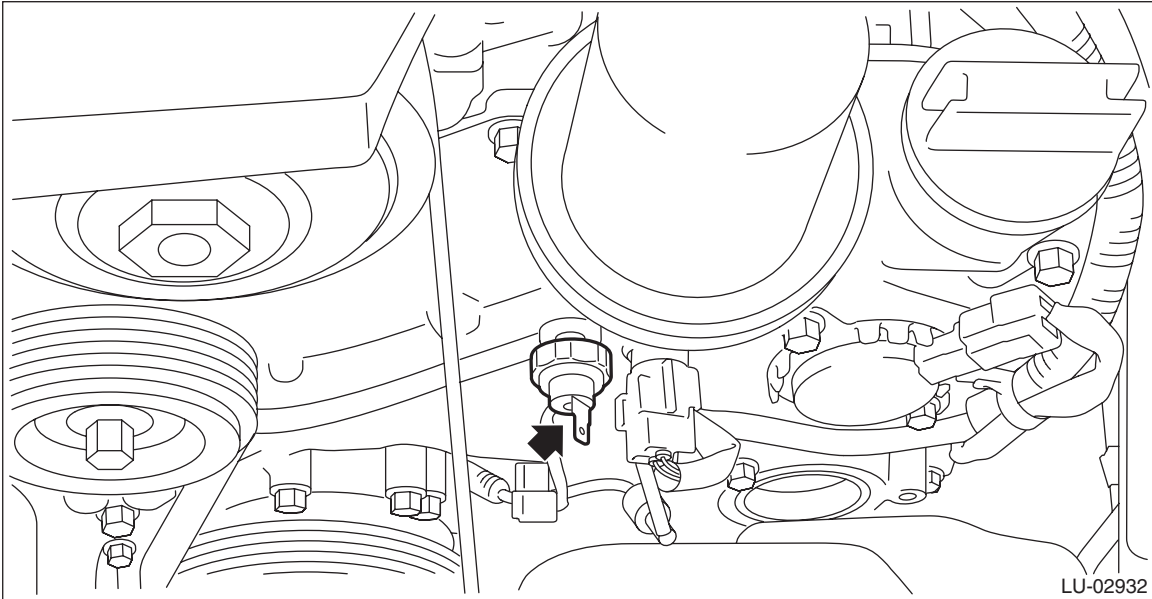

3) Connect the terminal to the oil pressure switch.

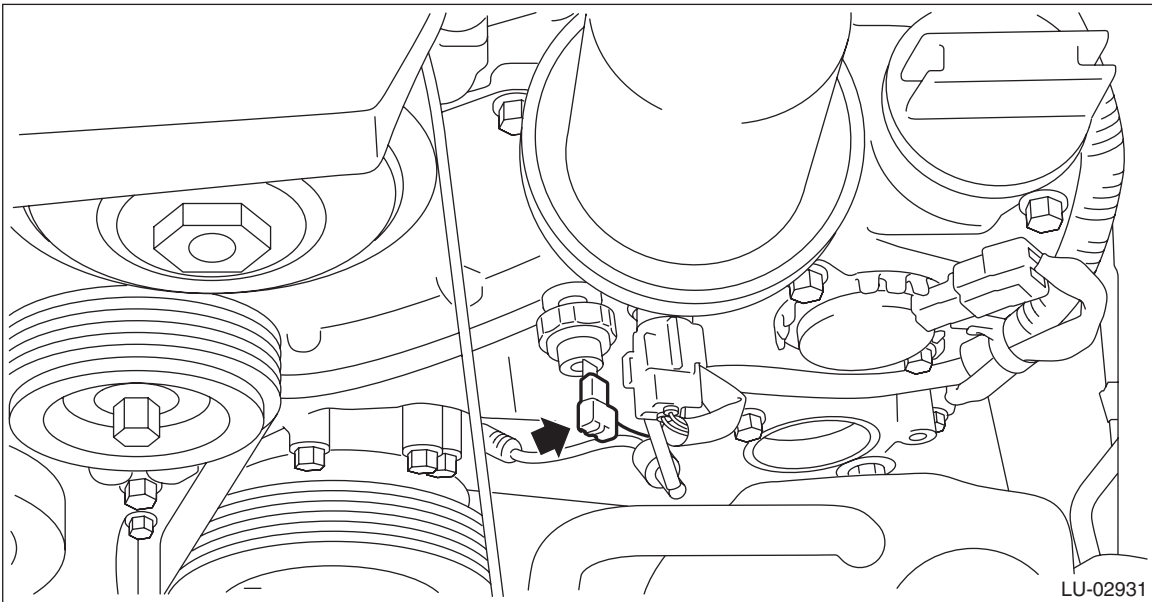

Oil Pressure Switch

LUBRICATION

4) Connect the battery ground terminal.

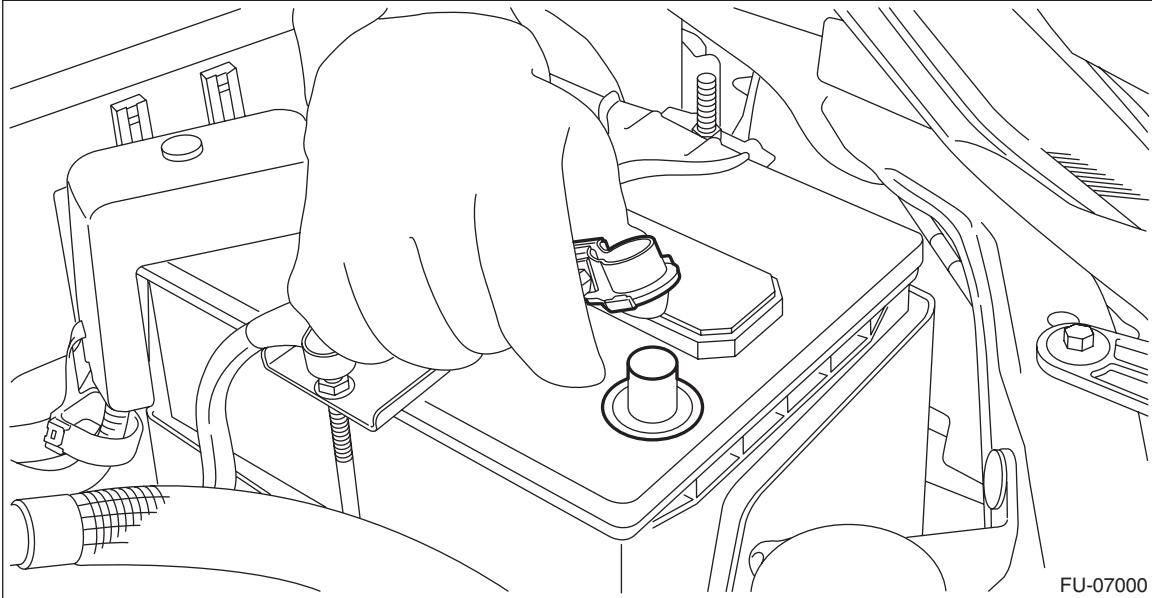

C: INSPECTION

- 1) Check that the oil pressure switch does not have deformation, cracks or damage.
- 2) Check the oil pressure switch installation portion for oil leakage and oil seepage.