

Engine Assembly

MECHANICAL

9. Engine Assembly

A: REMOVAL

1) Change the front hood damper bolt mounting position from (A) to (B), and completely open the front hood.

Tightening torque:

20 N·m (2.0 kgf·m, 14.8 ft·lb)

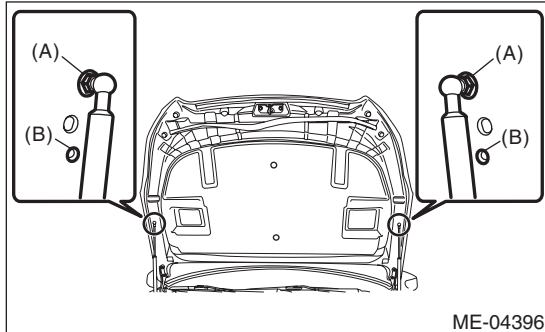

2) Remove the collector cover.

NOTE:

Follow the steps below when removing the collector cover.

- (1) Pull up the two points at the rear (A).
- (2) Pull up the two points at the front (B) while moving them forward.

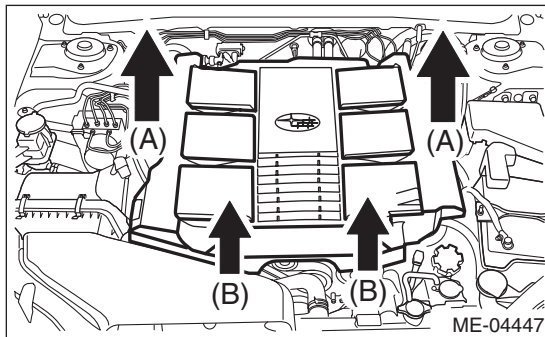

3) Collect the refrigerant from A/C system. <Ref. to AC-26, PROCEDURE, Refrigerant Recovery Procedure.>

4) Release the fuel pressure. <Ref. to FU(H6DO)-59, PROCEDURE, Fuel.>

5) Disconnect the ground cable from battery.

6) Open the fuel filler lid and remove the fuel filler cap.

7) Remove the air intake duct, air cleaner case and air intake boot assembly. <Ref. to IN(H6DO)-8, REMOVAL, Air Intake Duct.> <Ref. to IN(H6DO)-5, REMOVAL, Air Cleaner Case.> <Ref. to IN(H6DO)-7, REMOVAL, Air Intake Boot.>

8) Remove the V-belts. <Ref. to ME(H6DO)-51, REMOVAL, V-belt.>

9) Disconnect the following connector.

- (1) Remove two fixing clips on the fuel pipe protector (LH).

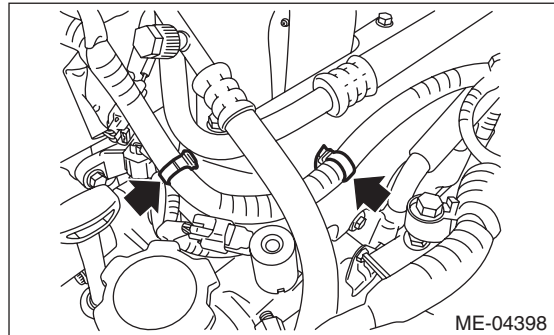

(2) Generator connector

(3) Generator terminal B

(4) Remove the harness cover from collector cover bracket.

(5) A/C compressor solenoid connector

(6) Flow sensor connector

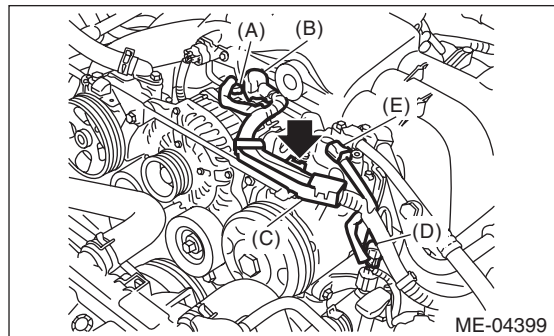

(A) Generator connector

(B) Terminal B

(C) Harness cover

(D) A/C compressor solenoid connector

(E) Flow sensor connector

(7) Slide the harness and connector to the battery side.

10) Remove the power steering pump together with the bracket.

NOTE:

Do not disconnect the hose and pipe from the power steering pump.

(1) Disconnect the manifold absolute pressure sensor connector (A) and power steering pump connector (B).

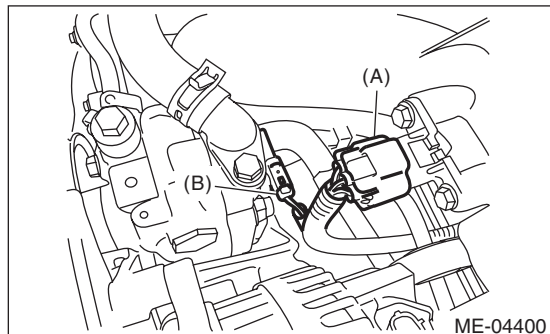

(2) Remove the securing bolts of collector cover bracket and power steering pump bracket.

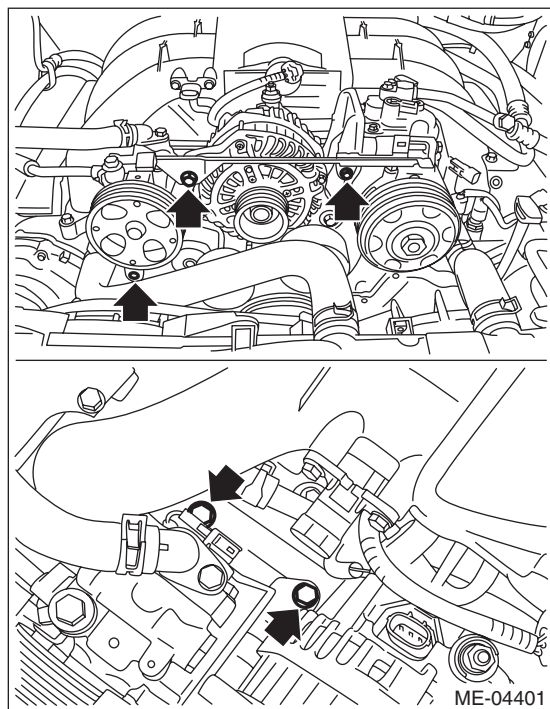

(3) Use a cloth to protect the power steering pump and place it on the RH front strut using a wire.

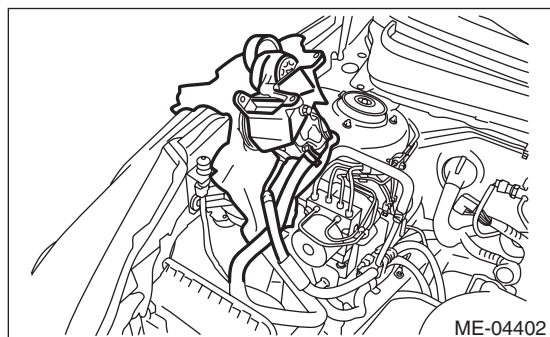

11) Remove the brake booster vacuum hose.

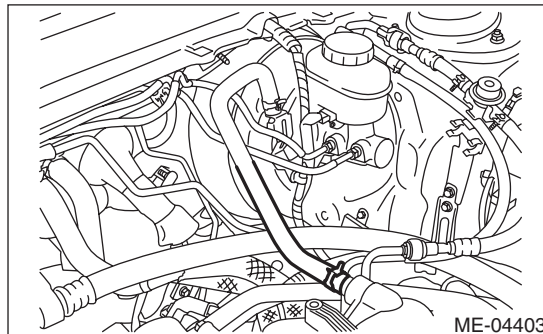

12) Remove the engine ground.

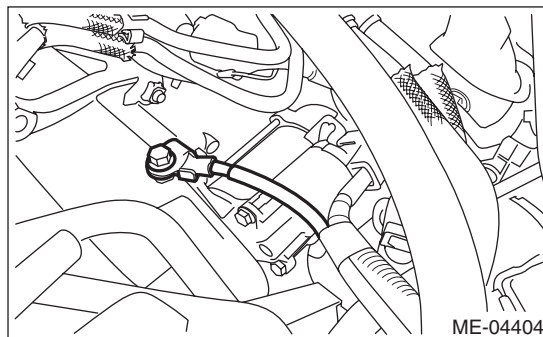

13) Remove the starter harness and engine ground from bracket.

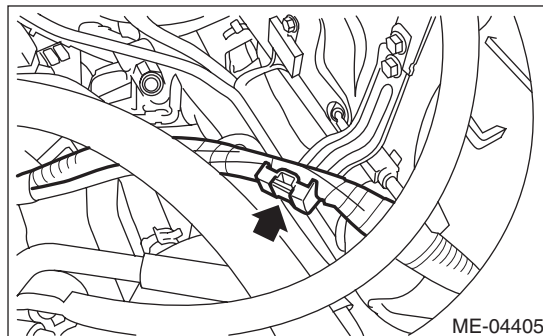

14) Remove the starter. <Ref. to SC(H6DO)-7, REMOVAL, Starter.>

15) Remove the grille bracket.

NOTE:

Remove ten clips when removing the grille bracket.

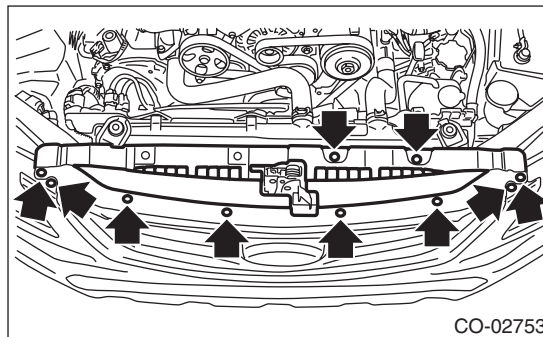

16) Lift up the vehicle.

17) Remove the under cover. <Ref. to EI-33, REMOVAL, Front Under Cover.>

Engine Assembly

MECHANICAL

18) Drain engine coolant completely. <Ref. to CO(H6DO)-12, DRAINING OF ENGINE COOLANT, REPLACEMENT, Engine Coolant.>

19) Remove the front exhaust pipe. <Ref. to EX(H6DO)-5, REMOVAL, Front Exhaust Pipe.>

20) Remove the ground cable from the underside of chain cover.

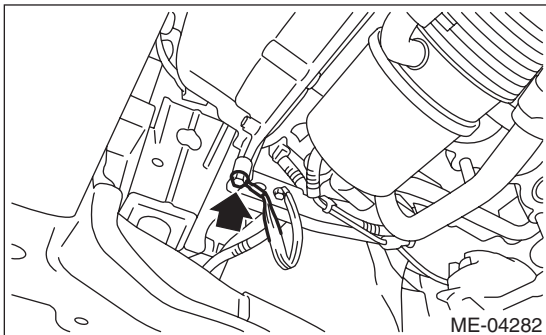
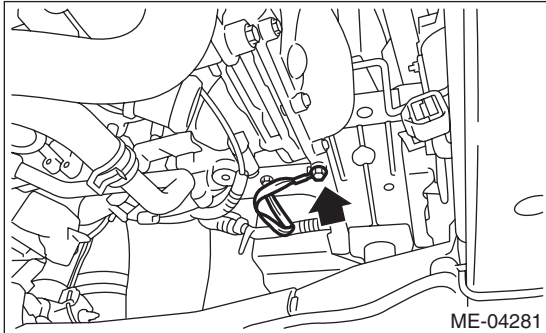

21) Remove the connecting bolts and nuts (lower side) between the engine and transmission.

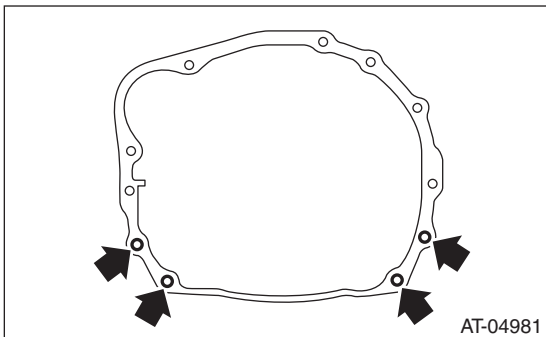

22) Lower the vehicle.

23) Remove the radiator main fan & fan motor and radiator sub fan & fan motor. <Ref. to CO(H6DO)-21, REMOVAL, Radiator Main Fan and Fan Motor.> <Ref. to CO(H6DO)-24, REMOVAL, Radiator Sub Fan and Fan Motor.>

24) Remove the radiator. <Ref. to CO(H6DO)-17, REMOVAL, Radiator.>

25) Remove the heater inlet hose and heater outlet hose.

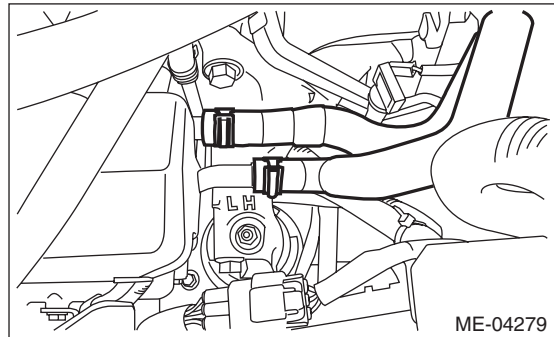

26) Disconnect the engine harness connector.

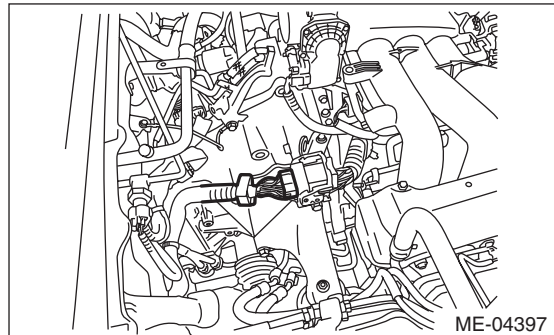

27) Disconnect the connector from the throttle body.

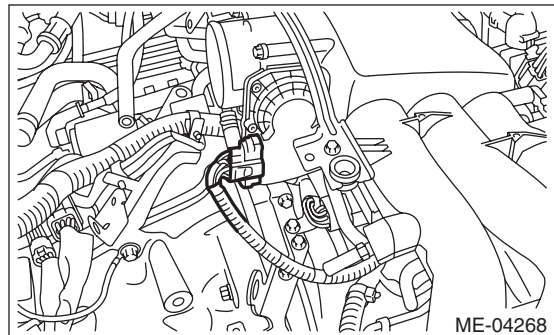

28) Remove the engine harness connector from the engine hanger bracket.

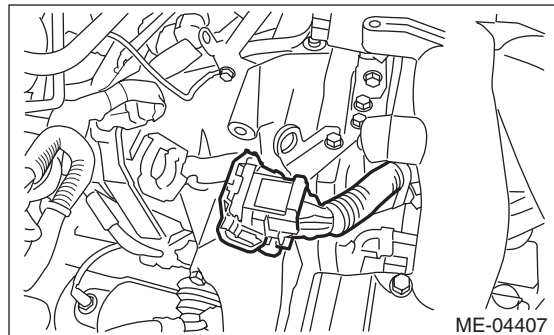

29) Remove the engine hanger bracket.

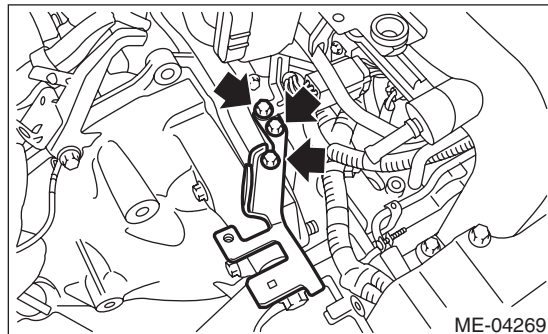

30) Remove the throttle body from the intake manifold.

NOTE:

Do not disconnect the inlet and outlet hoses of engine coolant.

31) Attach the ST.

ST 18360AA020 HANGER

Tightening torque:

19 N·m (1.9 kgf·m, 14.0 ft·lb)

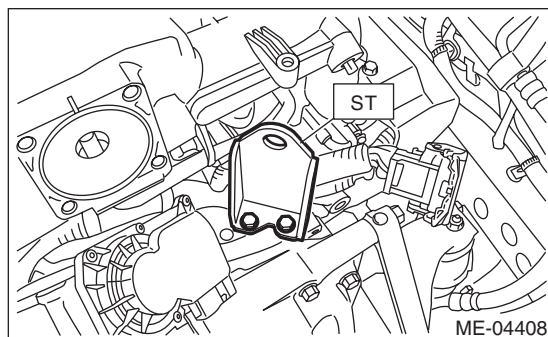

32) Separate the torque converter clutch from drive plate.

(1) Remove the service hole plug.

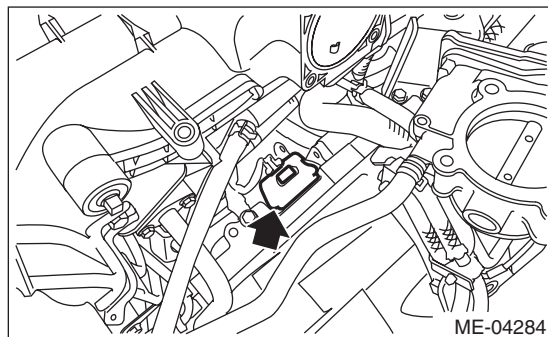

(2) Rotate the crank pulley to align the drive plate to the service hole, and remove four bolts.

33) Disconnect the fuel delivery hose and evaporation hose.

CAUTION:

- Be careful not to spill fuel.
- Catch the fuel from hoses using a container or cloth.

(1) Attach ST to the fuel delivery pipe and push ST in the direction of arrow mark to disconnect the quick connector of the fuel delivery hose.

ST 42099AE000 QUICK CONNECTOR RELEASE

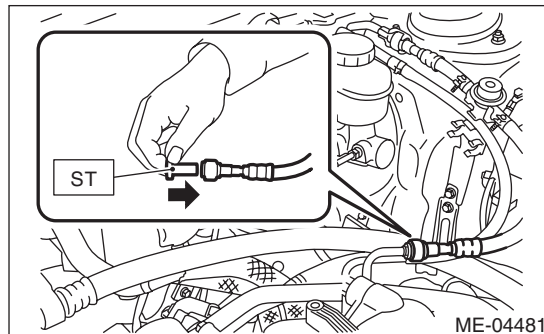

(2) Remove the clip and disconnect the evaporation hose.

34) Disconnect the A/C pressure hoses from A/C compressor. <Ref. to AC-76, REMOVAL, Hose and Pipe.>

35) Remove the connecting bolts (upper side) between engine and transmission.

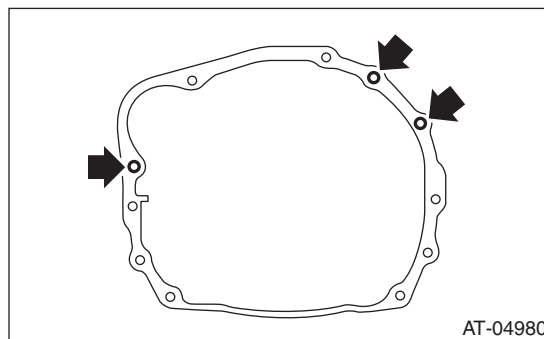

36) Set the ST to torque converter clutch case.

ST 498277200 STOPPER SET

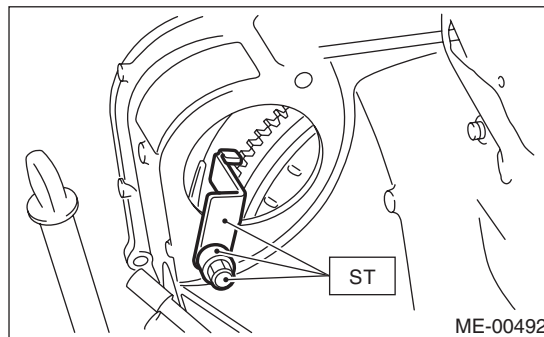

Engine Assembly

MECHANICAL

- 37) Support the engine with a lifting device and wire ropes.

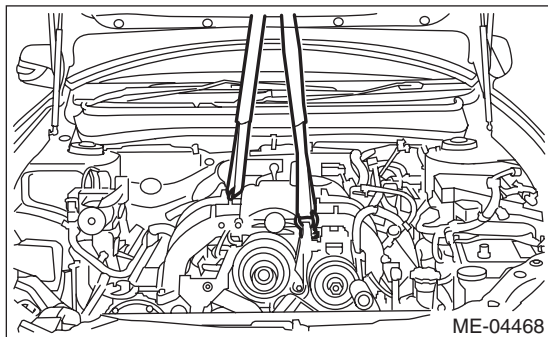

- 38) Remove the front mount.

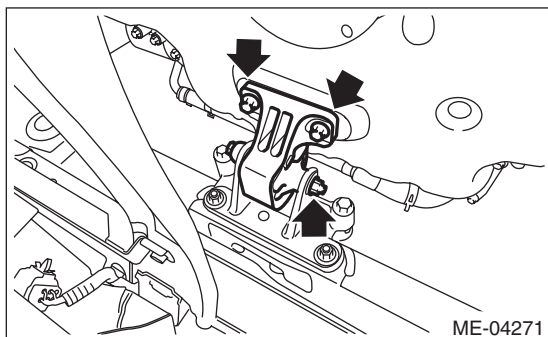

- 39) Remove the front mounting bracket from the cradle.

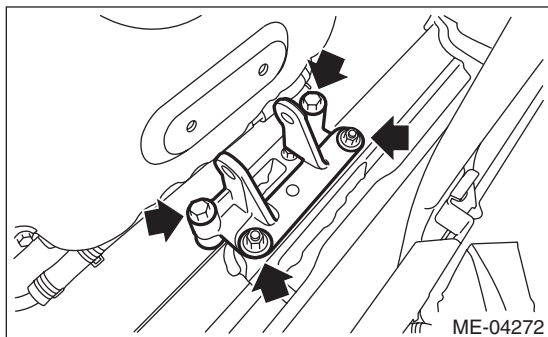

- 40) Remove the engine from the engine compartment.

- (1) Operate the lifter to set the engine horizontally.
- (2) Move the engine towards the front of the vehicle to disconnect it from the torque converter clutch case.
- (3) Operate the lifter to take out the engine from the engine compartment.

NOTE:

Be careful not to damage adjacent parts or body panels with crank pulley, oil level gauge, etc.

B: INSTALLATION

- 1) Install the engine to the vehicle.
 - (1) Operate the lifter to place the engine in the engine compartment.
 - (2) Operate the lifter to set the engine horizontally.
 - (3) Move the engine towards the rear of the vehicle to connect it to the torque converter clutch case.

NOTE:

Be careful not to damage adjacent parts or body panels with crank pulley, oil level gauge, etc.

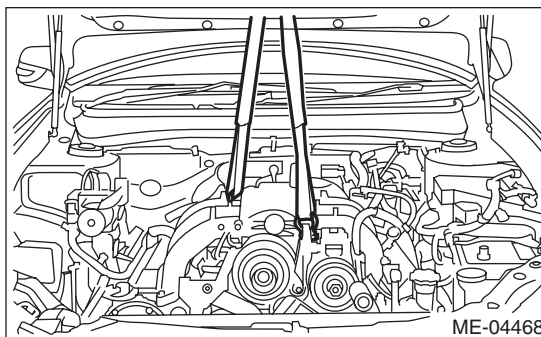

- 2) Install front mounting bracket to the cradle.

Tightening torque:

60 N·m (6.1 kgf-m, 44.3 ft-lb)

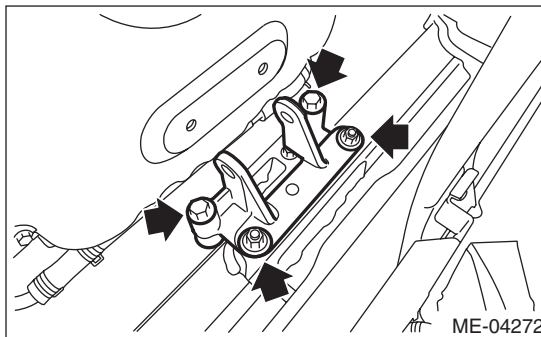

- 3) Install the front mount.

Tightening torque:

T1: 25 N·m (2.5 kgf-m, 18.4 ft-lb)

T2: 45 N·m (4.6 kgf-m, 33.2 ft-lb)

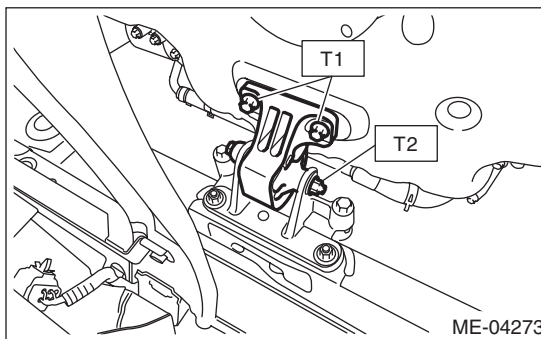

4) Install the connecting bolts (upper side) between engine and transmission.

Tightening torque:

50 N·m (5.1 kgf·m, 36.9 ft-lb)

NOTE:

Make sure there are no gaps in the mating surfaces between engine and transmission. If there are gaps, loosen the connecting bolts, and adjust the position while retightening the bolts.

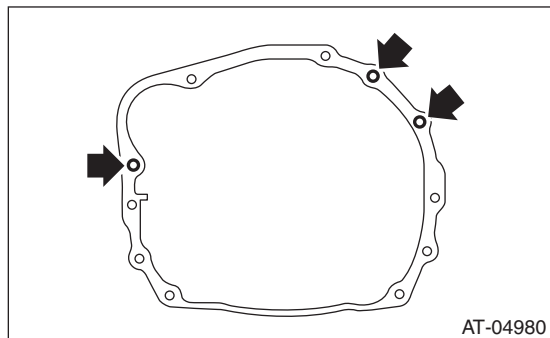

5) Remove the lifting device and wire ropes.

6) Remove the ST from torque converter clutch case.

NOTE:

Be careful not to drop the ST into the torque converter clutch case when removing the ST.

7) Install the radiator. <Ref. to CO(H6DO)-18, INSTALLATION, Radiator.>

8) Install the radiator main fan & fan motor and radiator sub fan & fan motor. <Ref. to CO(H6DO)-22, INSTALLATION, Radiator Main Fan and Fan Motor.> <Ref. to CO(H6DO)-24, INSTALLATION, Radiator Sub Fan and Fan Motor.>

9) Lift up the vehicle.

10) Attach the connecting bolts and nuts (lower side) between the engine and transmission.

Tightening torque:

50 N·m (5.1 kgf·m, 36.9 ft-lb)

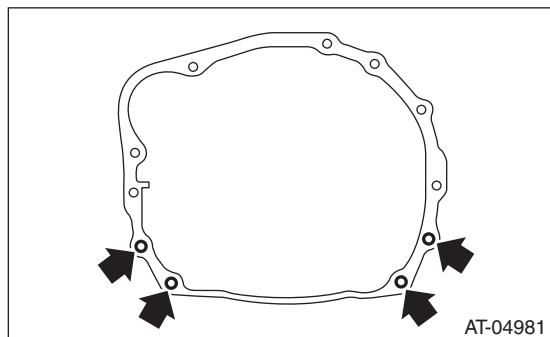

11) Install the ground cable to the underside of chain cover.

Tightening torque:

7.5 N·m (0.8 kgf·m, 5.5 ft-lb)

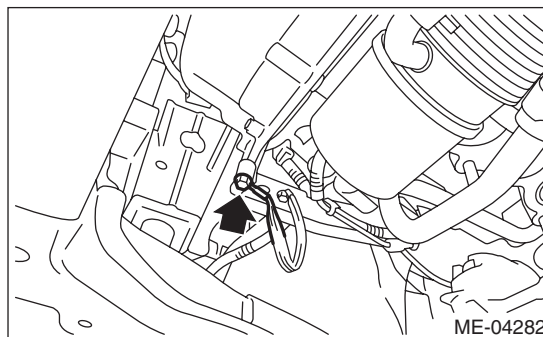
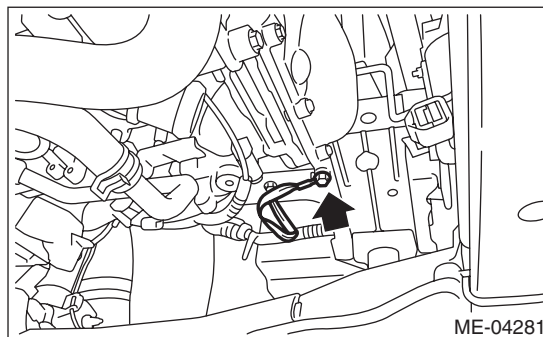

12) Install the front exhaust pipe. <Ref. to EX(H6DO)-6, INSTALLATION, Front Exhaust Pipe.>

13) Install the under cover. <Ref. to EI-33, INSTALLATION, Front Under Cover.>

14) Lower the vehicle.

15) Install the A/C pressure hoses to A/C compressor. <Ref. to AC-76, INSTALLATION, Hose and Pipe.>

16) Connect the fuel delivery hose (A) and evaporation hose (B). <Ref. to FU(H6DO)-85, EVAPORATION HOSE CONNECTION, INSTALLATION, Fuel Delivery and Evaporation Lines.>

NOTE:

If fuel hoses or clamps are damaged, replace them with new parts.

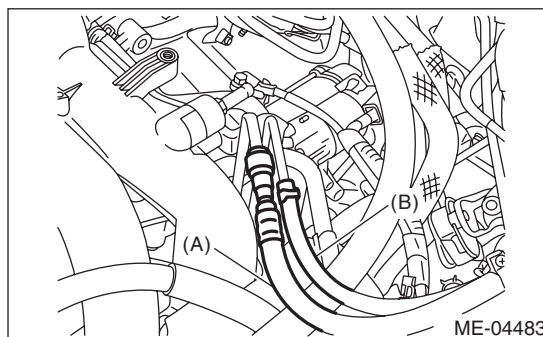

Engine Assembly

MECHANICAL

17) Connect the torque converter clutch to the drive plate.

(1) Rotate the clank pulley to align the drive plate to the service hole, and tighten four bolts.

Tightening torque:

25 N·m (2.5 kgf·m, 18.4 ft·lb)

(2) Install the service hole plug.

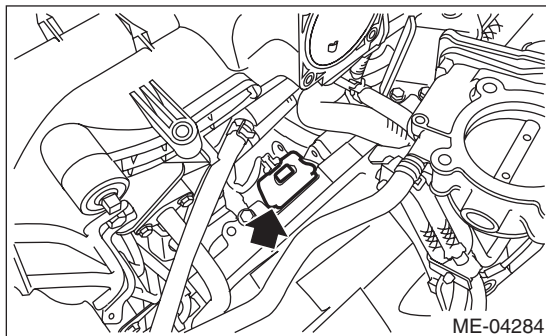

18) Remove the ST.

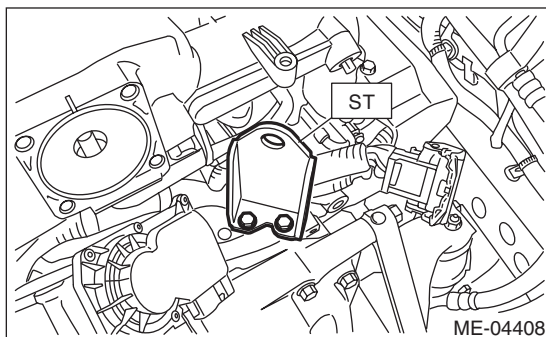

19) Install the throttle body to intake manifold.

NOTE:

Use a new gasket.

Tightening torque:

8 N·m (0.8 kgf·m, 5.9 ft·lb)

20) Install the engine hanger bracket.

Tightening torque:

19 N·m (1.9 kgf·m, 14.0 ft·lb)

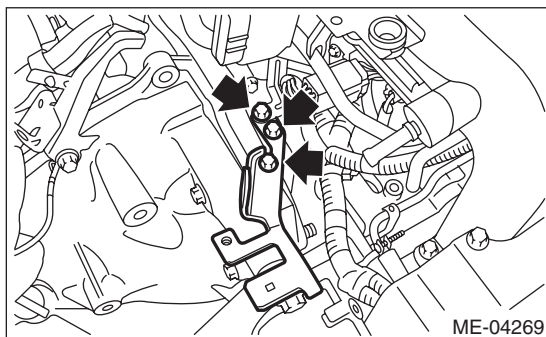

21) Install the engine harness connector to the engine hanger bracket.

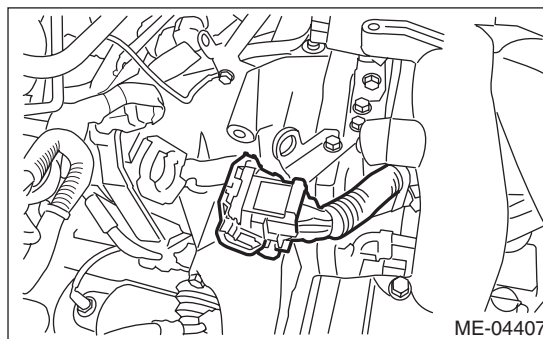

22) Connect the connector to the throttle body.

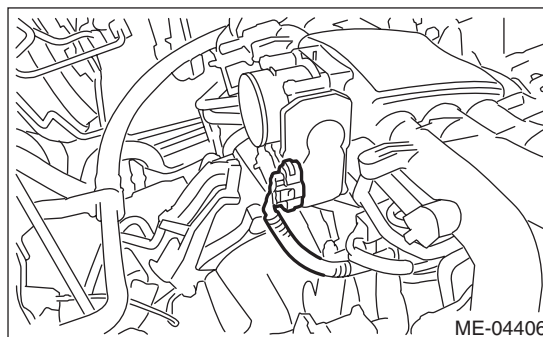

23) Connect the engine harness.

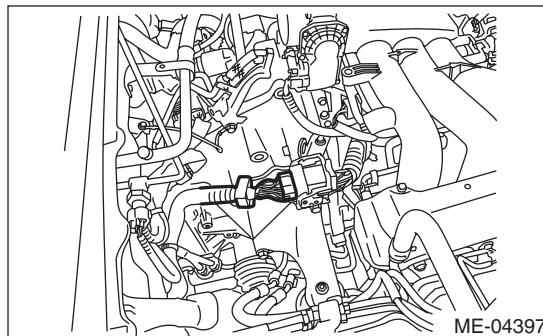

24) Install the heater inlet hose and heater outlet hose.

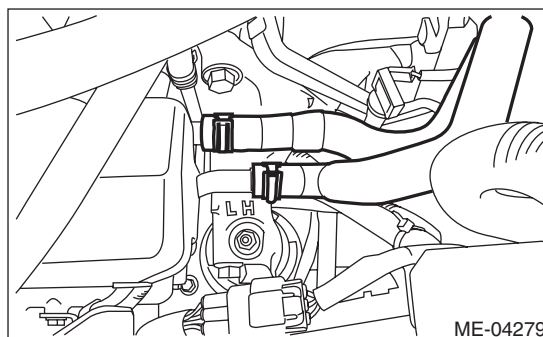

25) Attach the grille bracket.

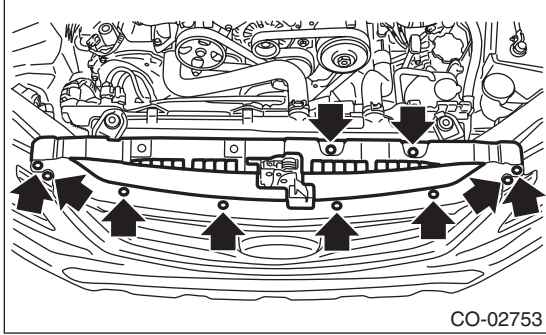

26) Install the starter. <Ref. to SC(H6DO)-7, INSTALLATION, Starter.>

27) Install the starter harness and engine ground to the bracket.

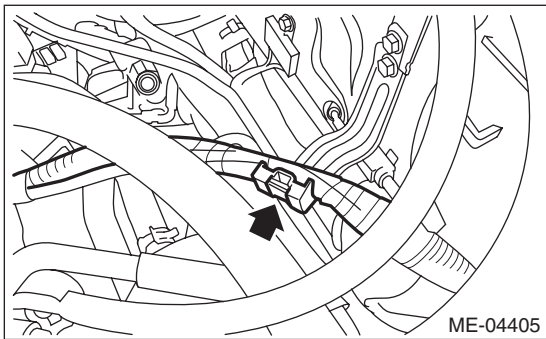

28) Install the engine ground.

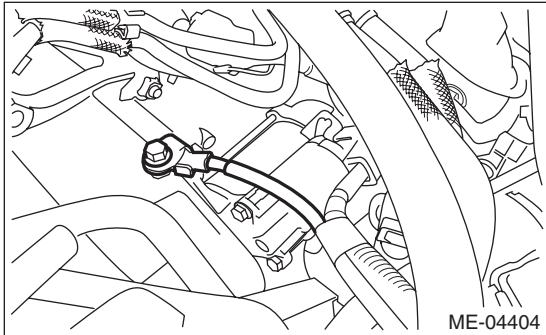

29) Install the brake booster vacuum hose.

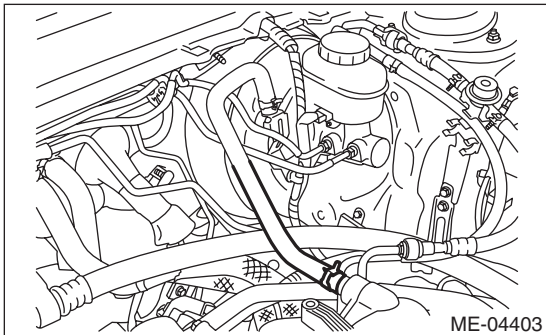

30) Install the power steering pump together with the bracket.

(1) Install the power steering pump and power steering pump bracket to the cylinder block.

(2) Install the collector cover bracket and power steering pump bracket.

Tightening torque:

T1: 6.4 N·m (0.7 kgf-m, 4.7 ft-lb)

T2: 25 N·m (2.5 kgf-m, 18.4 ft-lb)

T3: 33 N·m (3.4 kgf-m, 24.3 ft-lb)

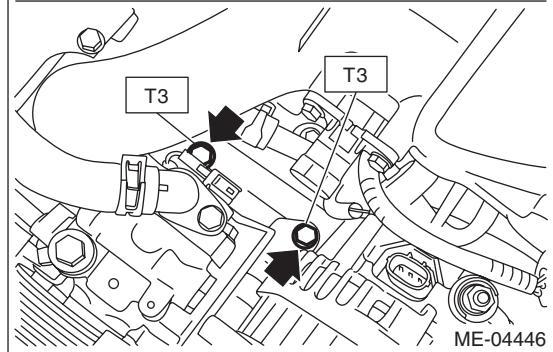
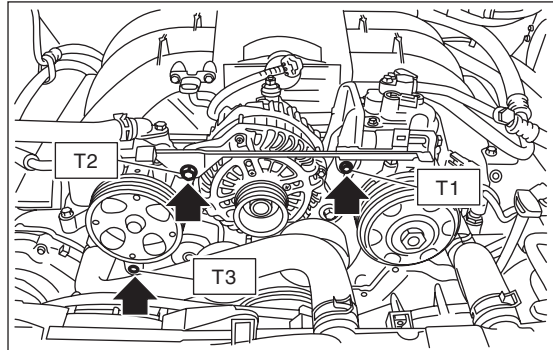

(3) Connect the manifold absolute pressure sensor connector (A) and power steering pump connector (B).

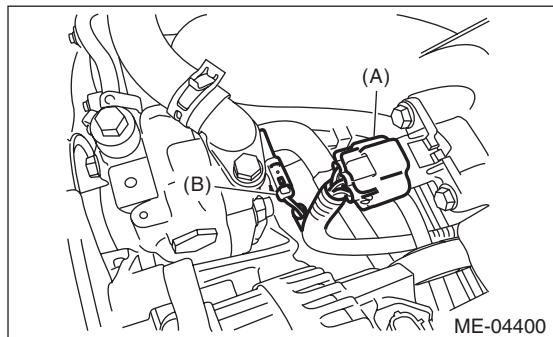

31) Connect the following connectors.

(1) Generator connector

(2) Generator terminal B

Tightening torque:

16 N·m (1.6 kgf-m, 11.8 ft-lb)

(3) Install the harness cover to the collector cover bracket.

(4) A/C compressor solenoid connector

Engine Assembly

MECHANICAL

(5) Flow sensor connector

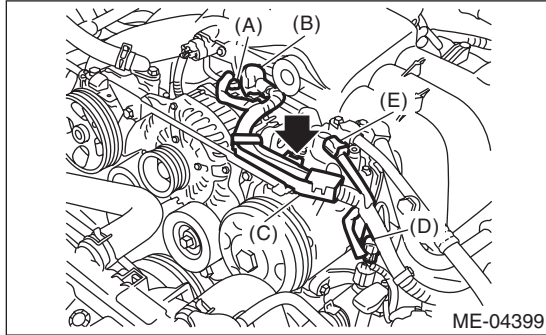

- (A) Generator connector
- (B) Generator terminal B
- (C) Install the harness cover to the collector cover bracket.
- (D) A/C compressor solenoid connector
- (E) Flow sensor connector

(6) Install with the securing clips to the two locations on the fuel pipe protector (LH).

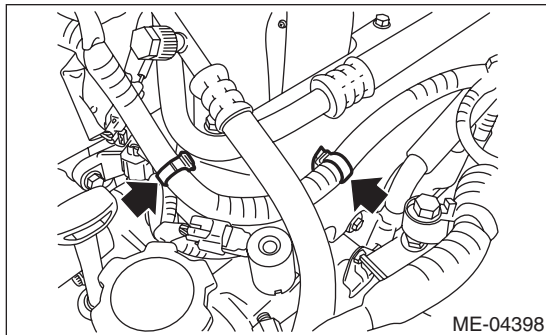

- 32) Install the V-belts. <Ref. to ME(H6DO)-51, INSTALLATION, V-belt.>
- 33) Install the air intake duct, air cleaner case and air intake boot assembly. <Ref. to IN(H6DO)-8, INSTALLATION, Air Intake Duct.> <Ref. to IN(H6DO)-5, INSTALLATION, Air Cleaner Case.> <Ref. to IN(H6DO)-7, INSTALLATION, Air Intake Boot.>
- 34) Connect the ground cable to battery.
- 35) Fill engine coolant. <Ref. to CO(H6DO)-12, FILLING OF ENGINE COOLANT, REPLACEMENT, Engine Coolant.>
- 36) Charge the A/C system with refrigerant. <Ref. to AC-27, PROCEDURE, Refrigerant Charging Procedure.>
- 37) Check the ATF level and replenish it if necessary. <Ref. to 5AT-28, INSPECTION, Automatic Transmission Fluid.>
- 38) Install the collector cover.

39) Change the front hood damper bolt mounting position from (B) to (A), and completely close the front hood.

Tightening torque:
20 N·m (2.0 kgf-m, 14.8 ft-lb)

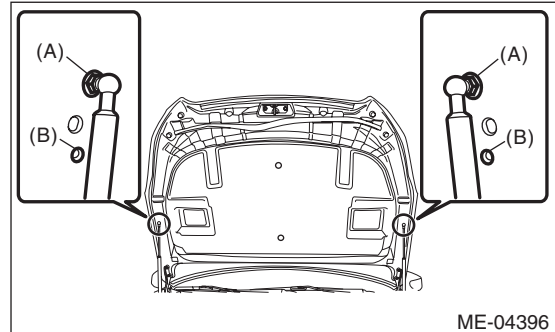

C: INSPECTION

- 1) Check that the pipes, hoses, connectors and clips are securely connected.
- 2) Check that the engine coolant is up to specified level.
- 3) Check that the ATF is up to specified level.
- 4) Start the engine and check for exhaust gas, engine coolant, leaks of fuel, etc. Also check for noise and vibrations.