

8. Door Sash Tape

A: REMOVAL

1. FRONT DOOR

- 1) Disconnect the ground cable from battery.
- 2) Remove the front door trim. <Ref. to EI-59, FRONT DOOR, REMOVAL, Door Trim.>
- 3) Remove the outer mirror assembly. <Ref. to GW-24, REMOVAL, Outer Mirror Assembly.>
- 4) Remove the sealing cover.

CAUTION:

- Carefully remove the butyl tape. Excessive force will easily break the cover.
- If the sealing cover gets broken, replace it with a new part.

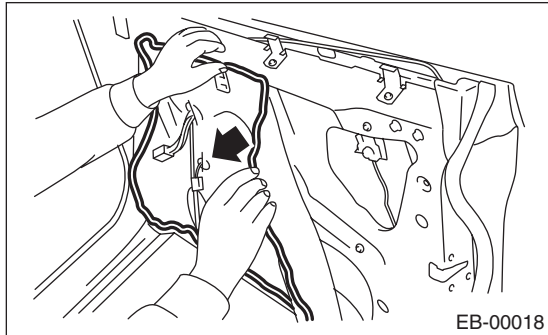

- 5) Remove the front door glass. <Ref. to GW-18, REMOVAL, Front Door Glass.>
- 6) Remove the glass run rubber.
- 7) Release the clips, and remove the inner cover.

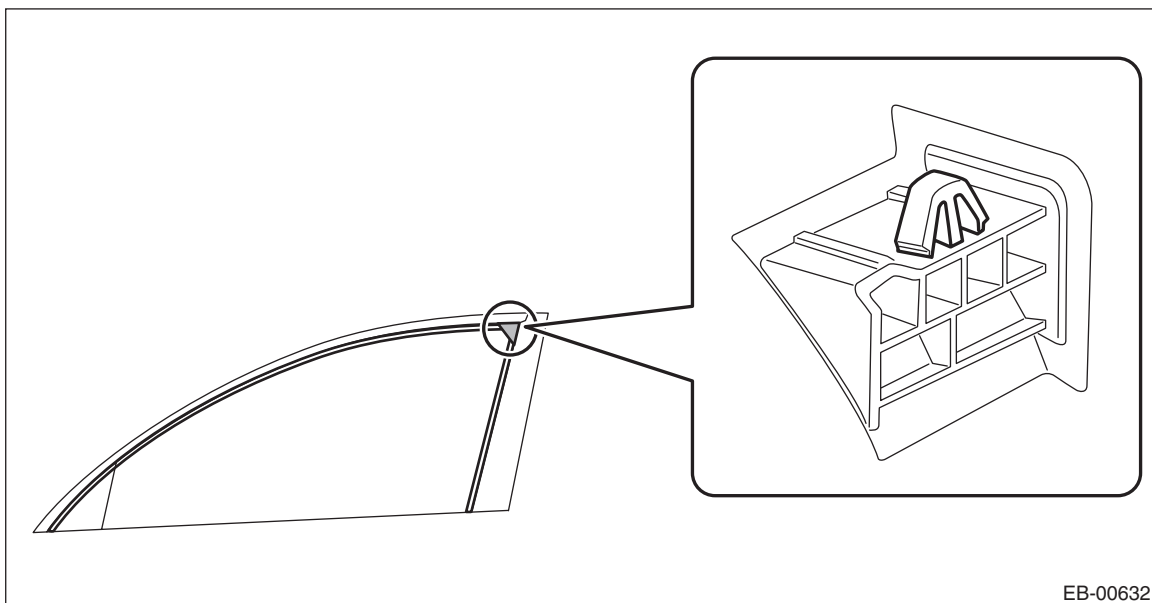

- 8) Detach the inner tape.

NOTE:

- If the tape is difficult to detach, warm it by a hot air drier. Make sure to use a home use drier. Do not use an industrial use drier.
- Wipe away any trace of tape adhesive from the door sash.

Door Sash Tape

EXTERIOR BODY PANELS

2. REAR DOOR

- 1) Disconnect the ground cable from battery.
- 2) Remove the rear door trim. <Ref. to EI-60, REAR DOOR, REMOVAL, Door Trim.>
- 3) Remove the sealing cover.

CAUTION:

- Carefully remove the butyl tape. Excessive force will easily break the cover.
- If the sealing cover gets broken, replace it with a new part.

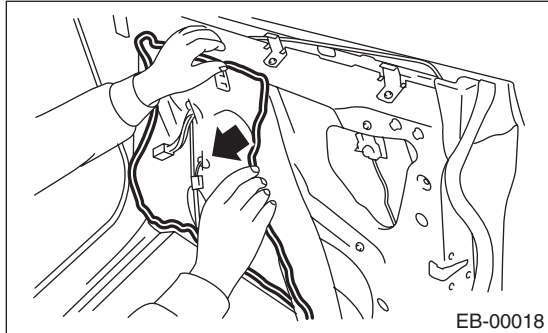

- 4) Remove the door sash and rear door glass. <Ref. to GW-30, REMOVAL, Rear Door Glass.>
- 5) Remove the glass run rubber.
- 6) Release the clips, and remove the inner cover.
 - Sedan model

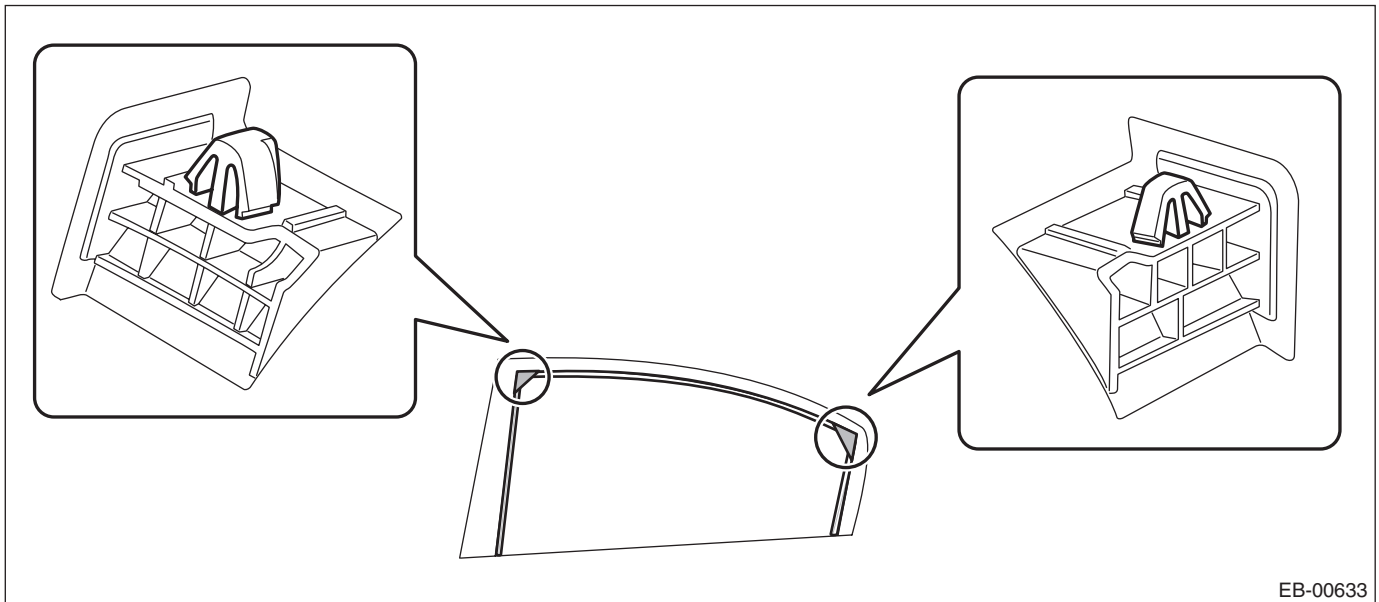

- OUTBACK model

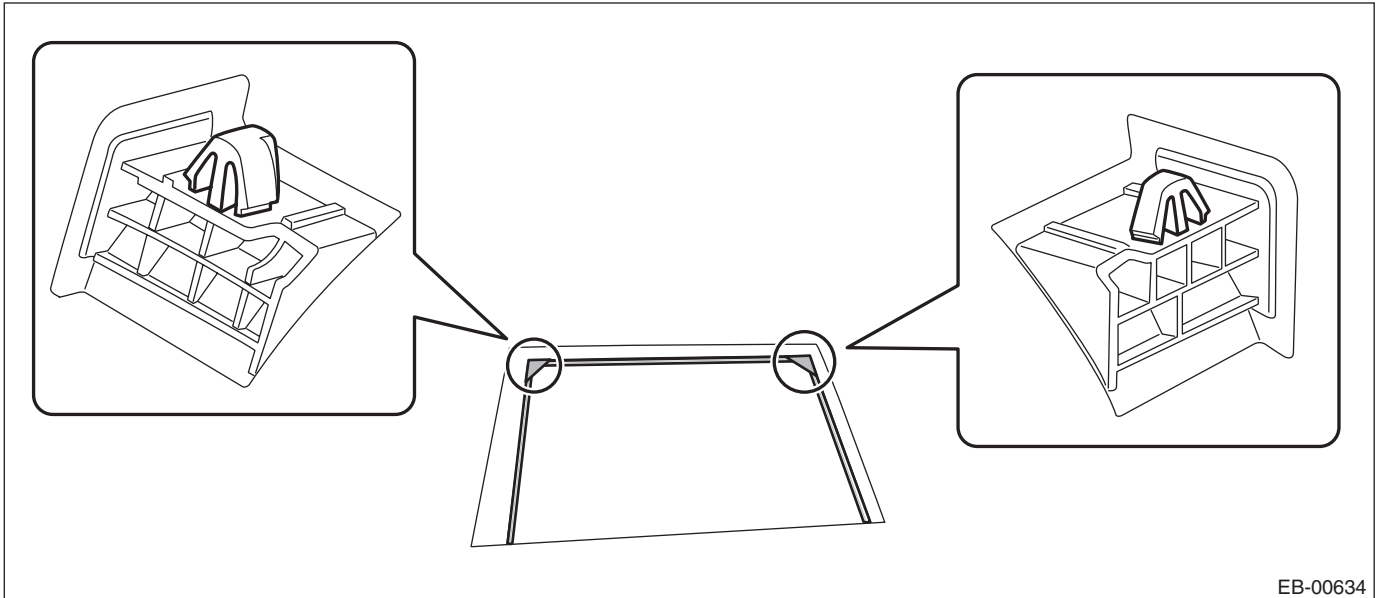

7) Detach the inner tape.

NOTE:

- If the tape is difficult to detach, warm it by a hot air drier. Make sure to use a home use drier. Do not use an industrial use drier.
- Wipe away any trace of tape adhesive from the door sash.

B: INSTALLATION

CAUTION:

- Press evenly along the sash when applying the tape using a spatula or similar object to make sure no bubbles are formed.

If any bubbles are formed, replace the tape.

- If any wrinkles form in the tape while applying, replace the tape with new tape.
- Be sure to press the ends of the tape firmly to adhere securely. If the tape comes off at the ends or where folded, the adhesive strength is weakened and the tape may peel off.

1) Apply the inner tape along the arrow directions.

- Front

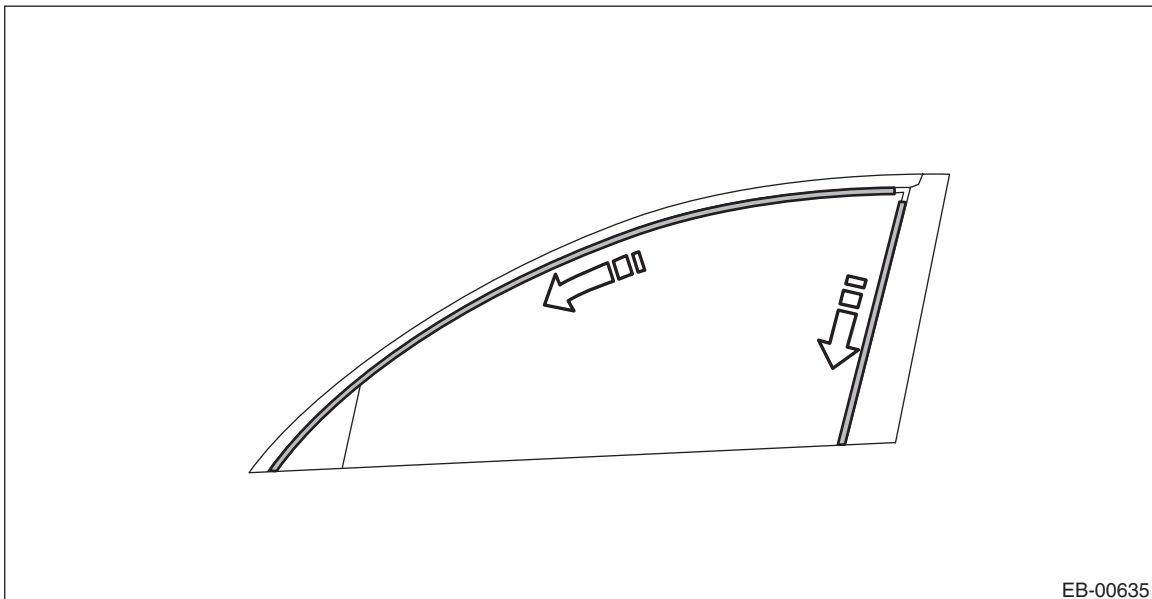

Door Sash Tape

EXTERIOR BODY PANELS

- Rear

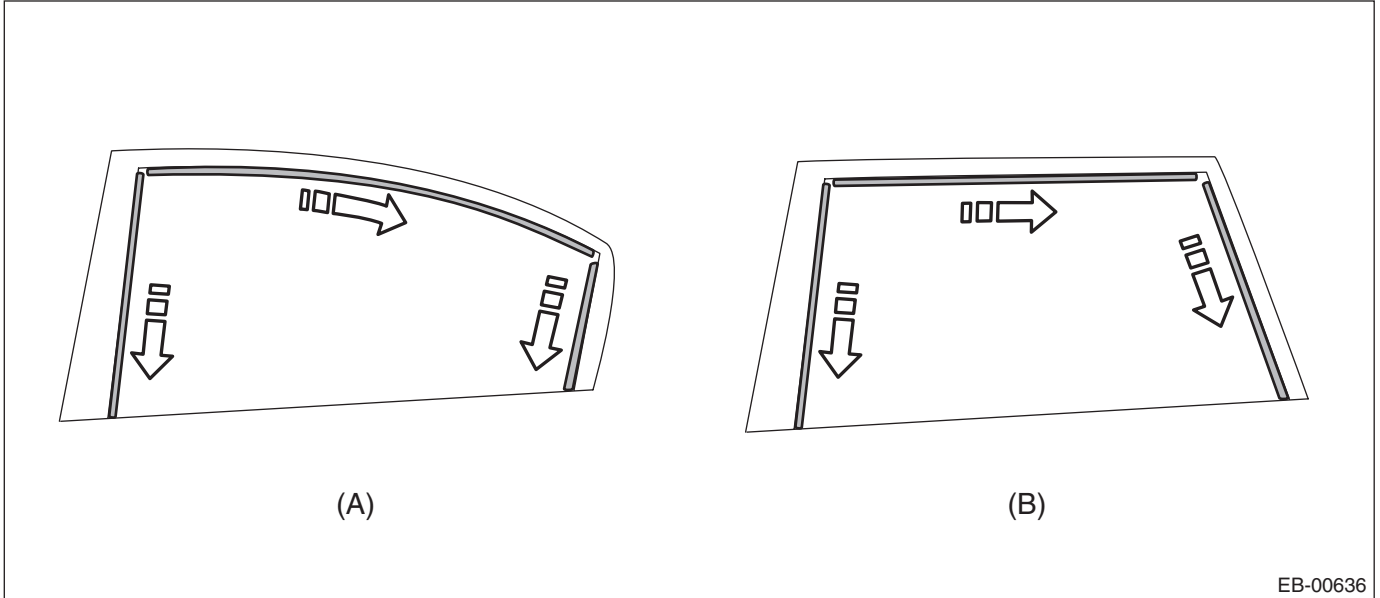

(A) Sedan model

(B) OUTBACK model

2) Install the remaining parts in the reverse order of removal.