

Cruise Control System

WIRING SYSTEM

16. Cruise Control System

A: WIRING DIAGRAM

1. 2.5 L MODEL

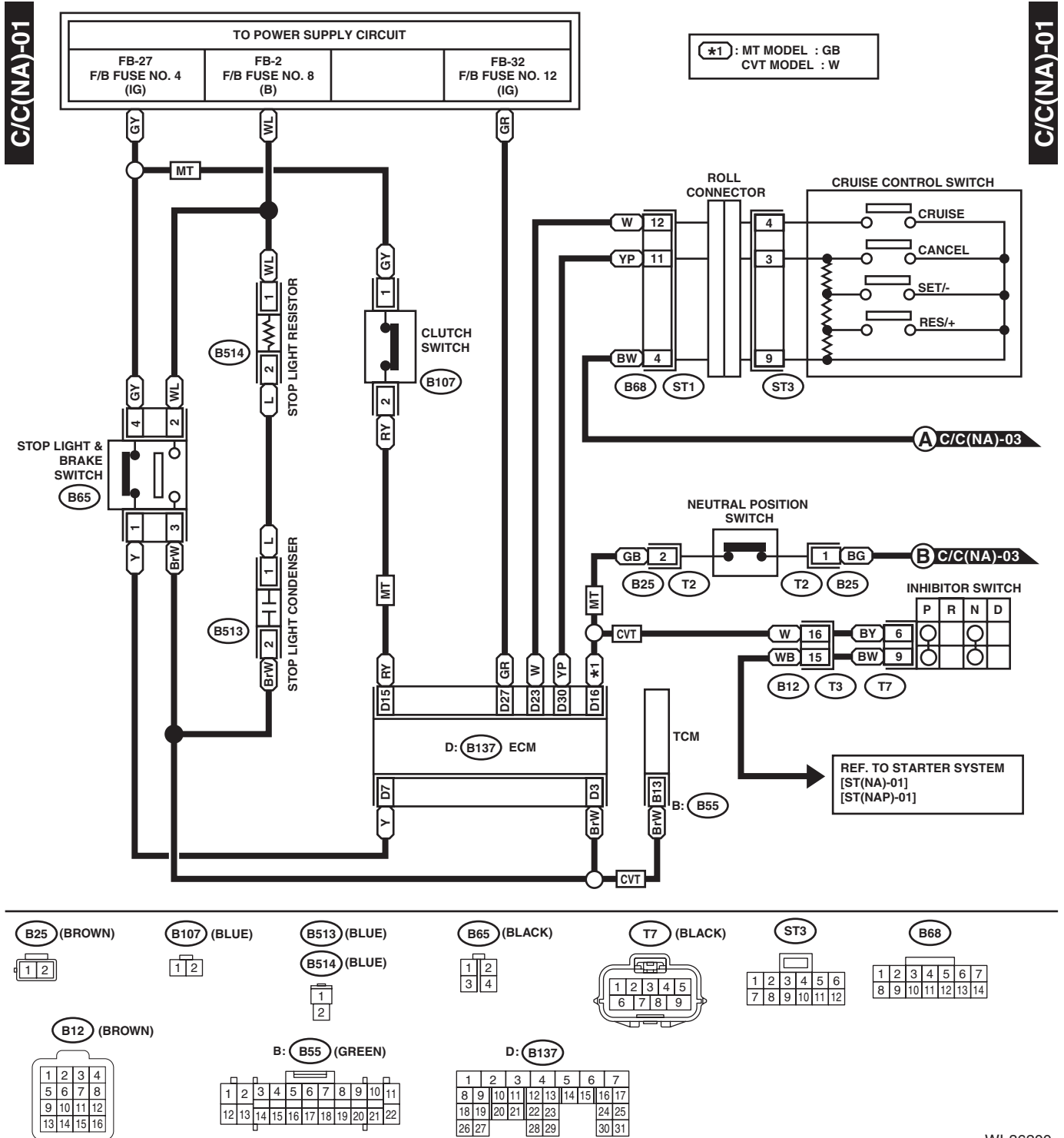

WI-36200

Cruise Control System

WIRING SYSTEM

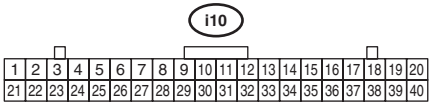
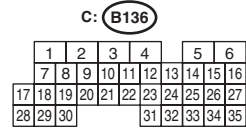
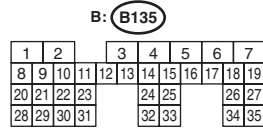
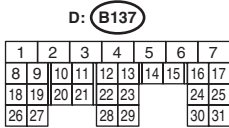
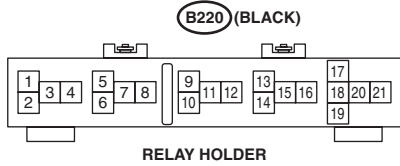
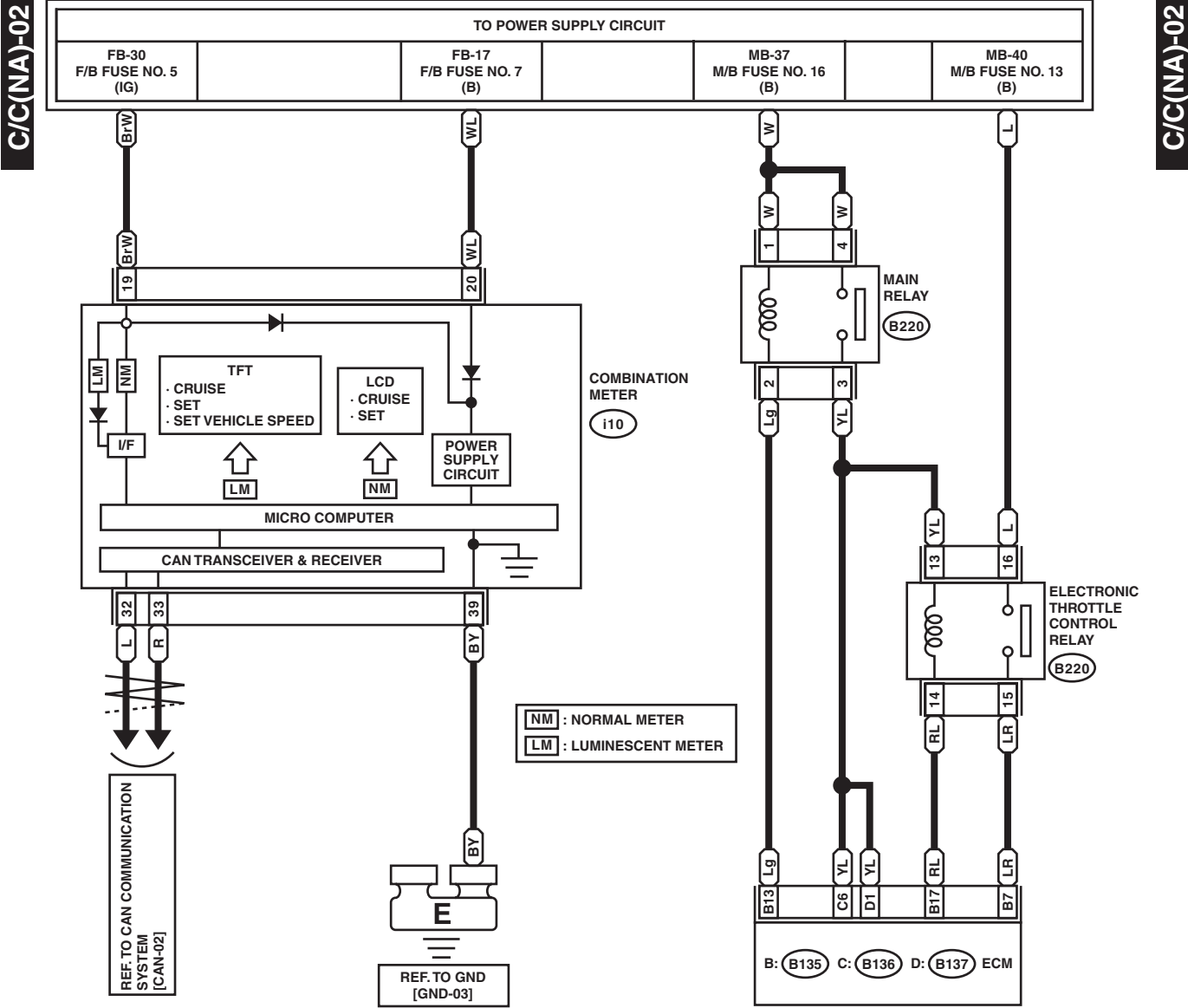

WI-36201

Cruise Control System

WIRING SYSTEM

C/C(NA)-03

C/C(NA)-03

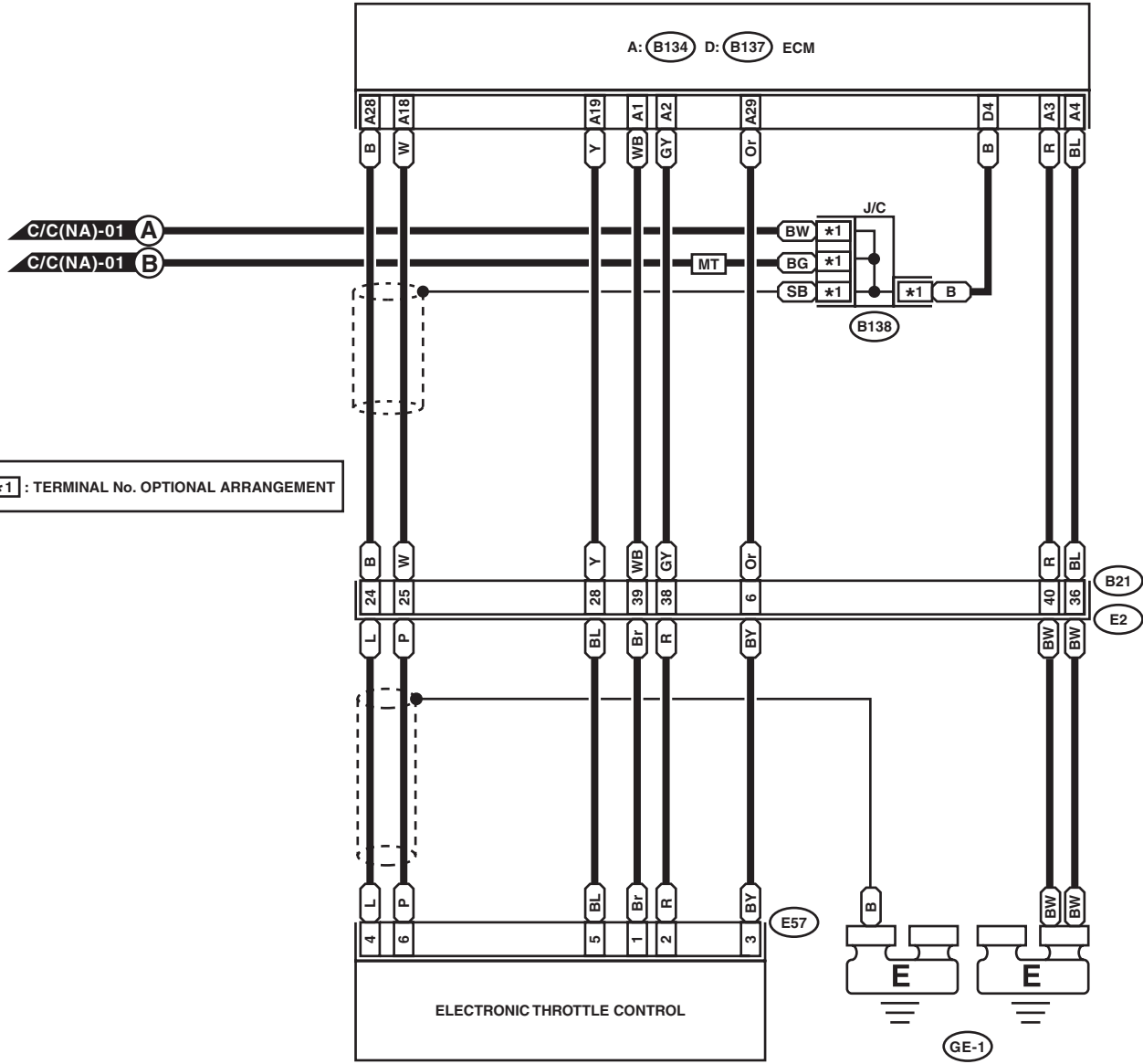

*1 : TERMINAL No. OPTIONAL ARRANGEMENT

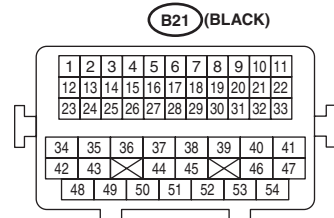
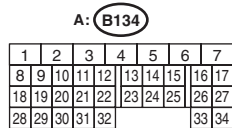
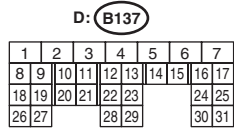
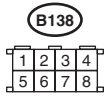
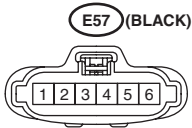

WI-41334

Cruise Control System

WIRING SYSTEM

2. 3.6 L MODEL

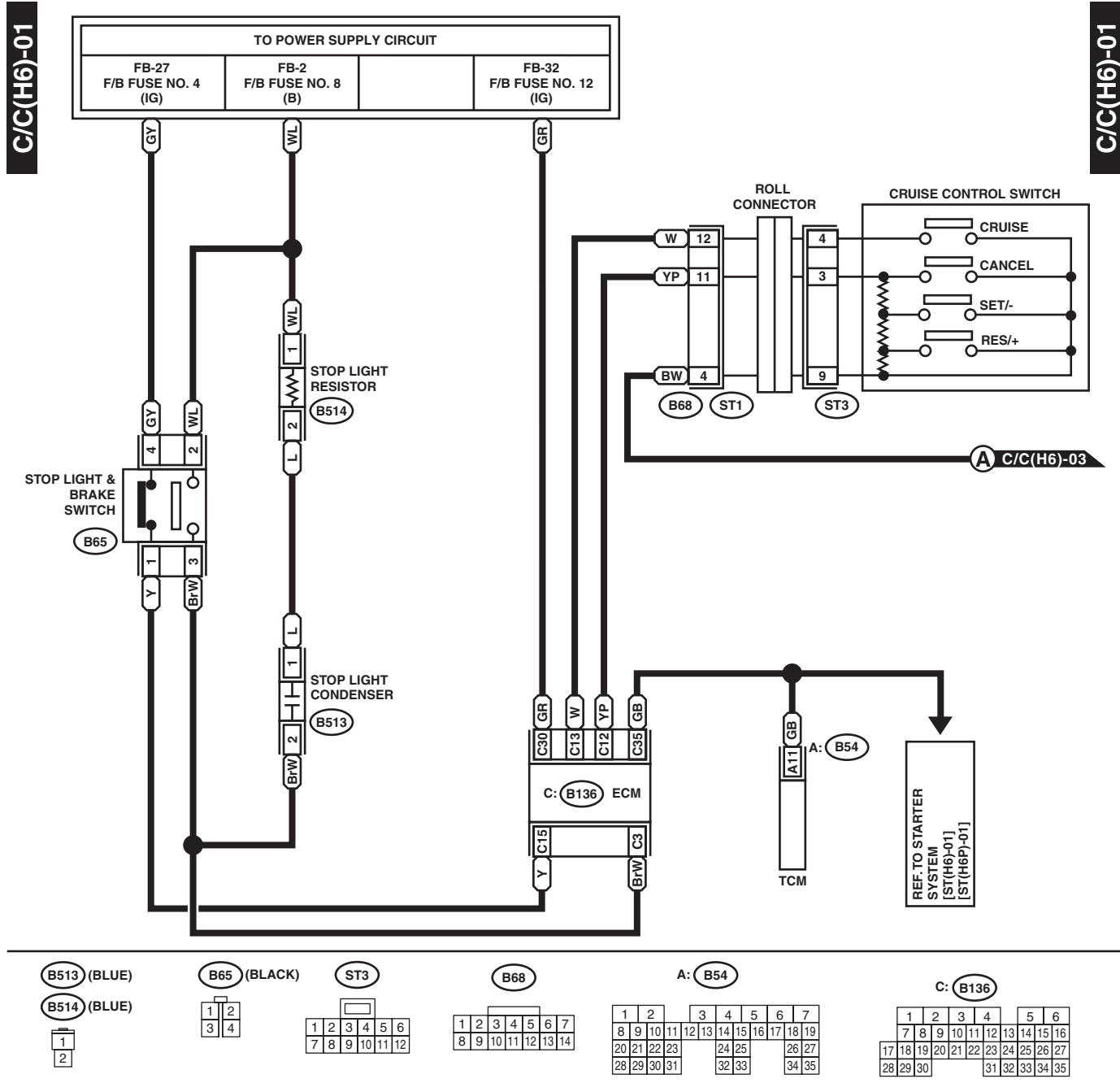

WI-36203

Cruise Control System

WIRING SYSTEM

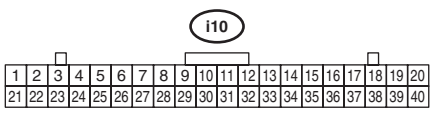
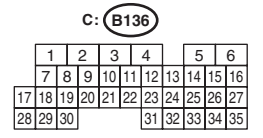
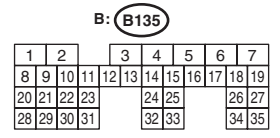
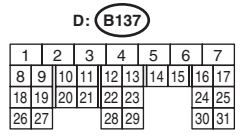
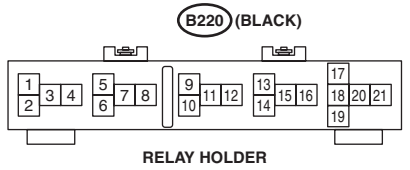
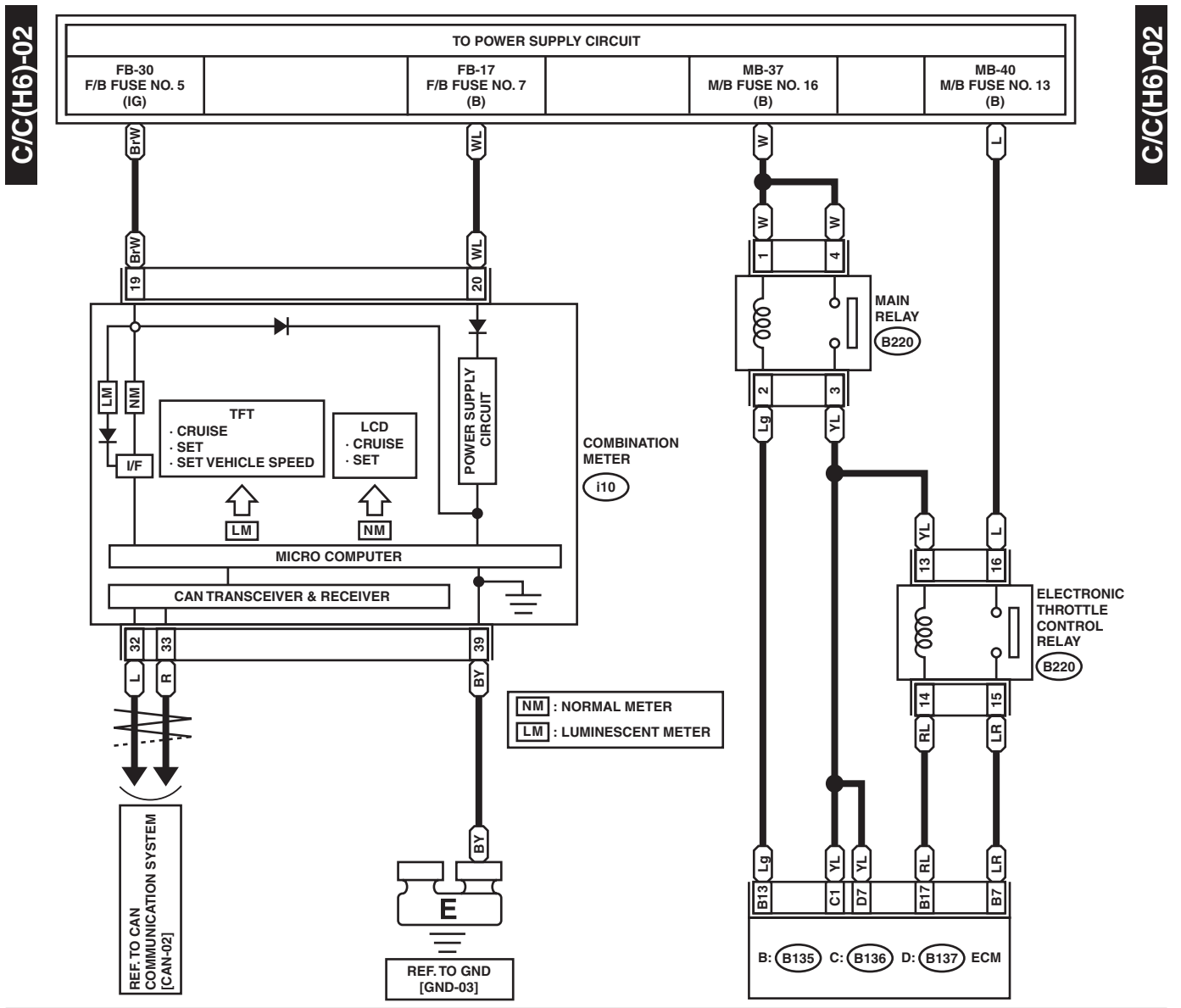

WI-36204

Cruise Control System

WIRING SYSTEM

C/C(H6)-03

C/C(H6)-03

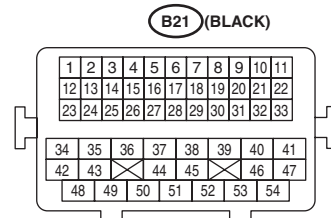
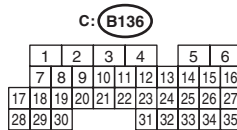
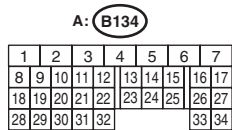
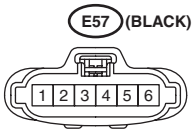
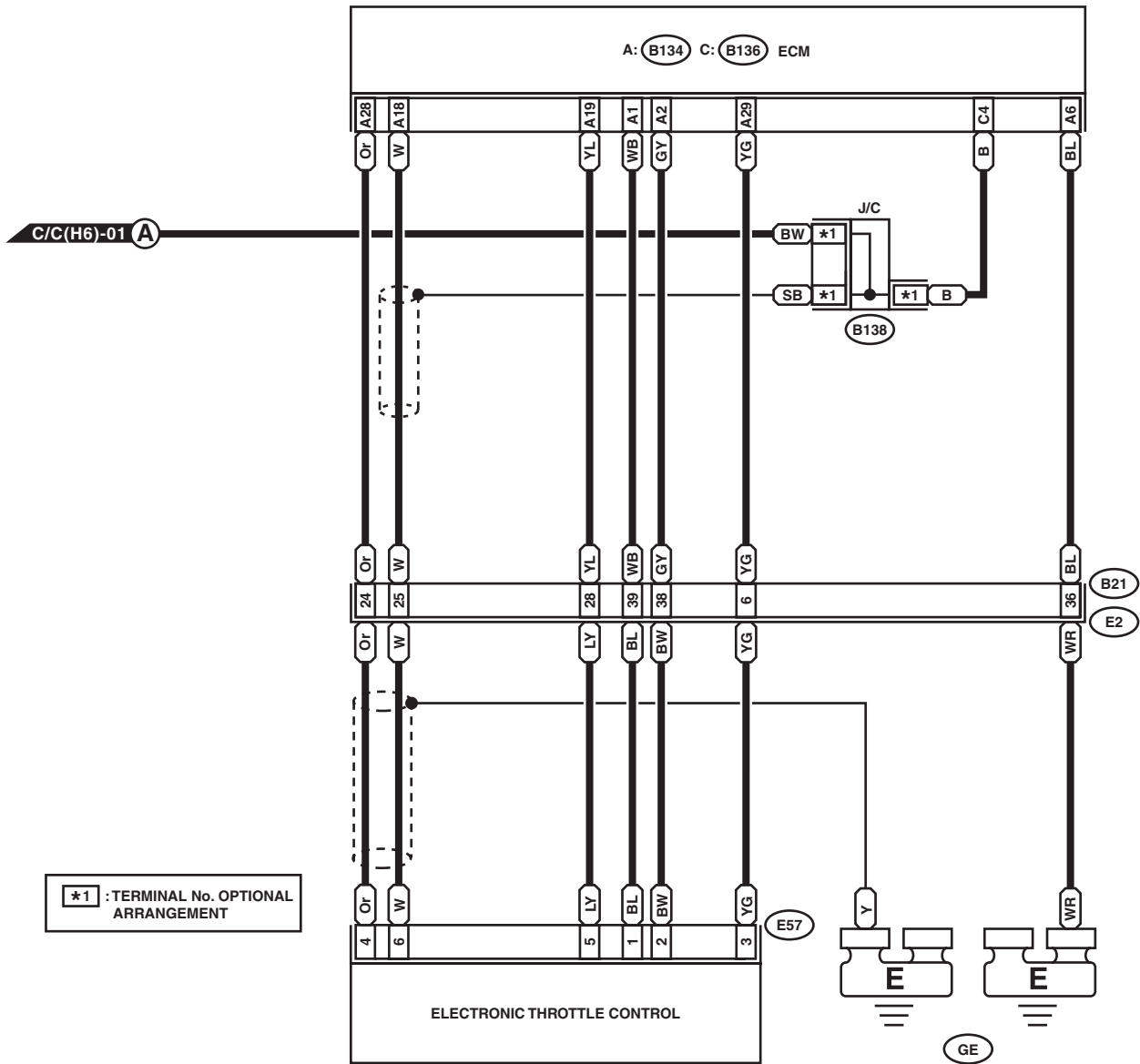

WI-41335