

# EyeSight System

WIRING SYSTEM

## 19. EyeSight System

### A: WIRING DIAGRAM

#### 1. 2.5 L MODEL

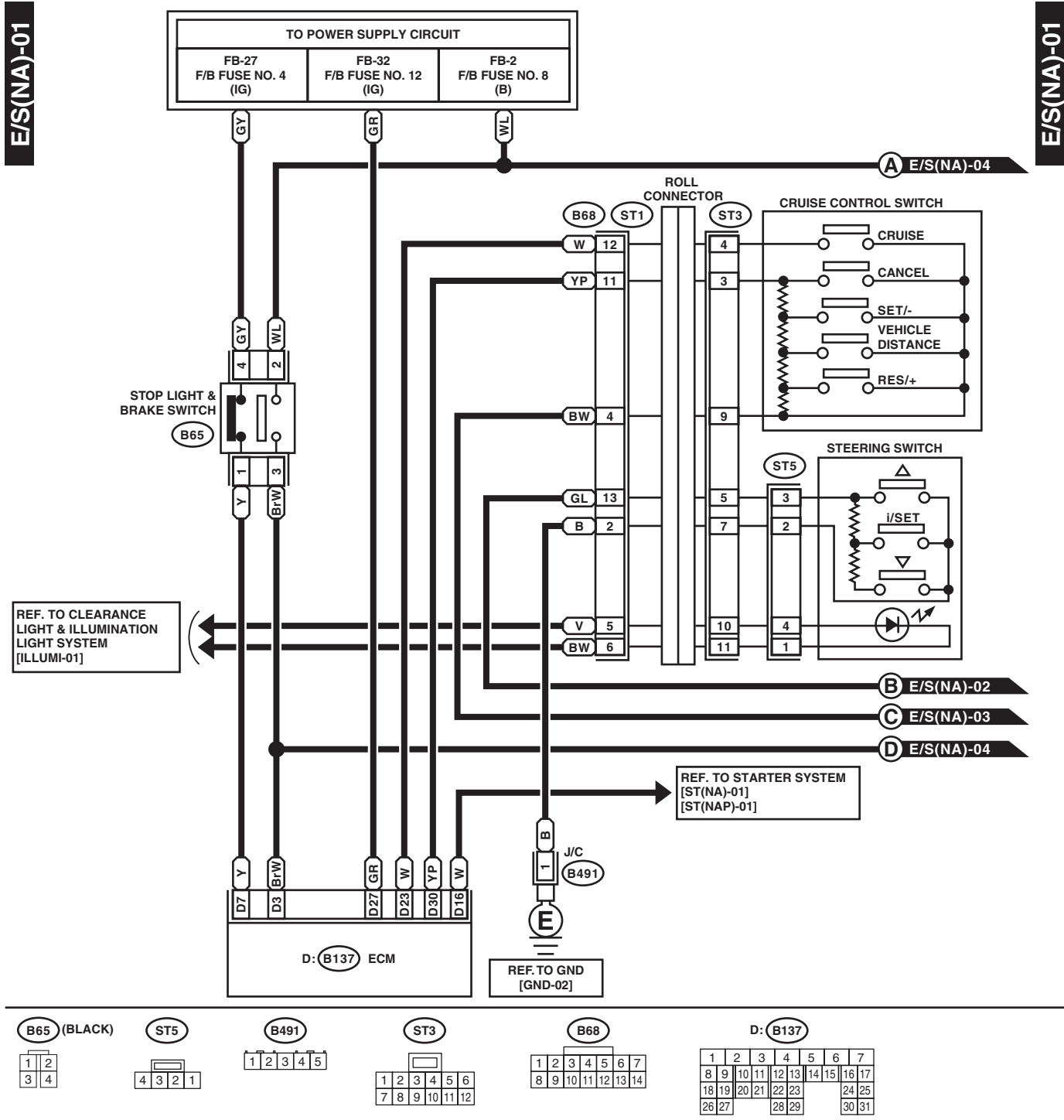

WI-36134

# EyeSight System

## WIRING SYSTEM

E/S(NA)-02

E/S(NA)-02

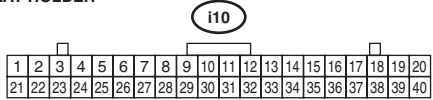
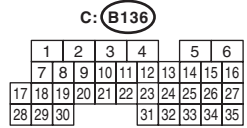
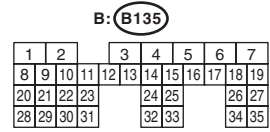
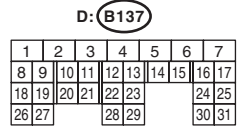
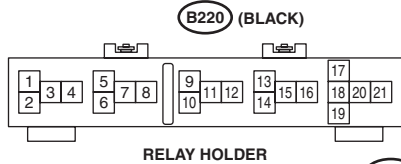
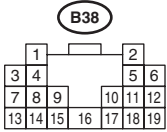
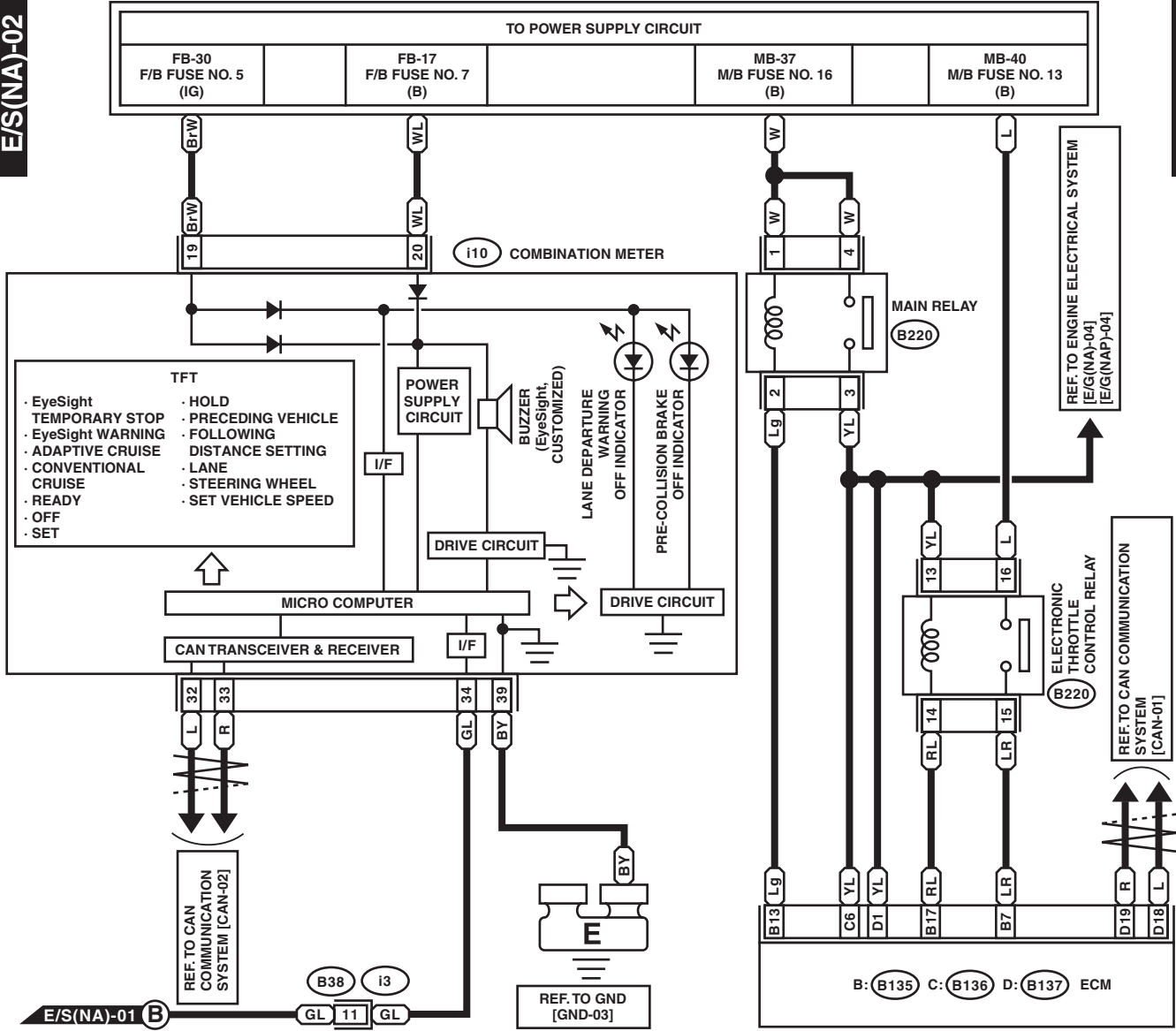

WI-41476

# EyeSight System

## WIRING SYSTEM

E/S(NA)-03

E/S(NA)-03

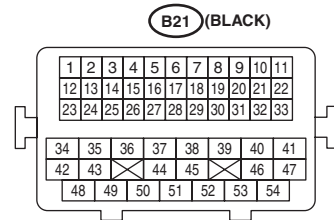
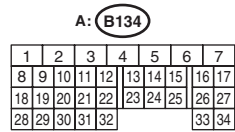
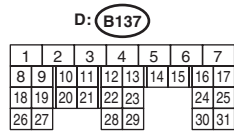
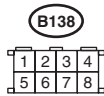
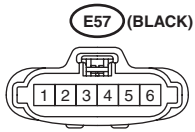
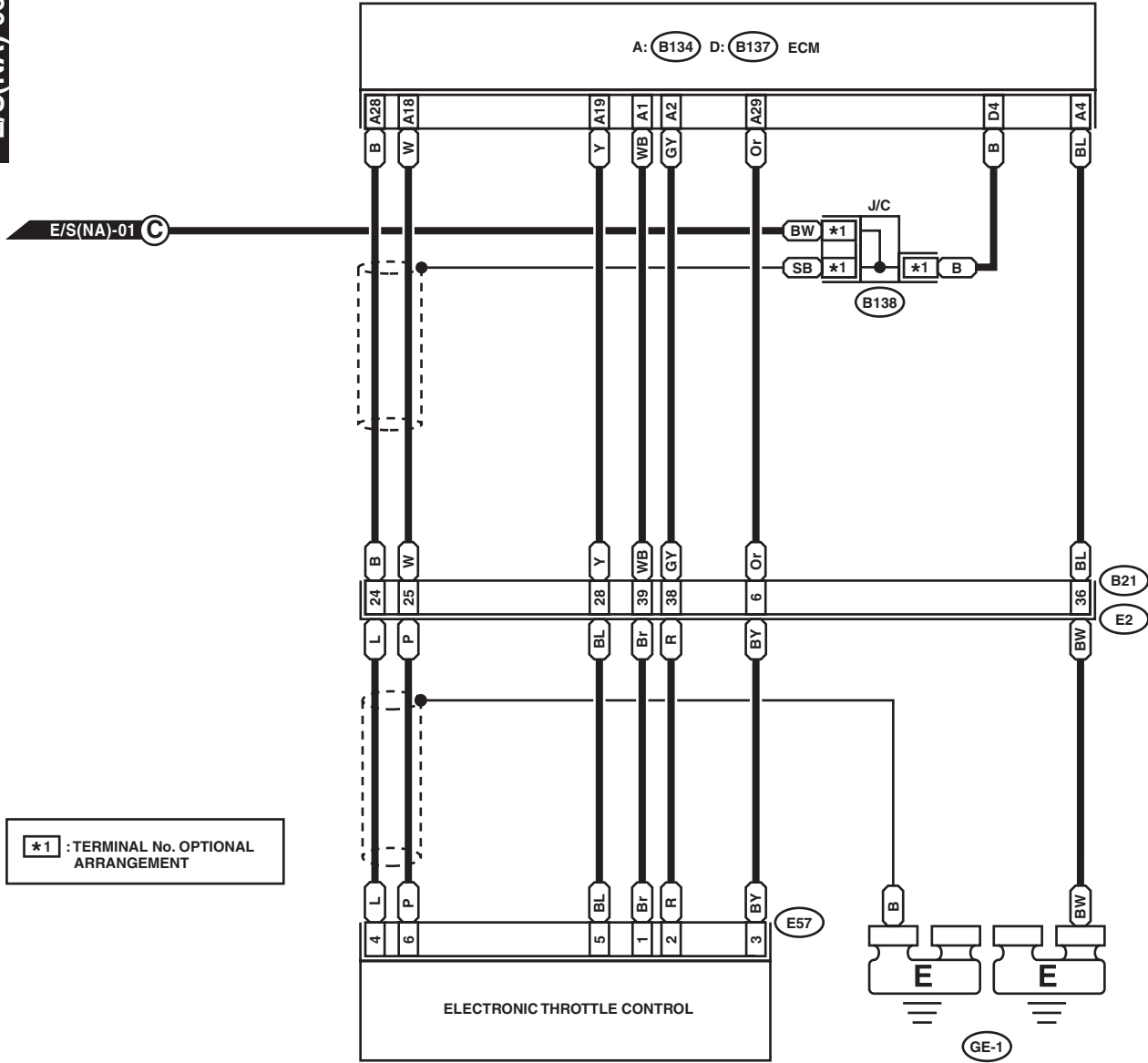

WI-41346

# EyeSight System

## WIRING SYSTEM

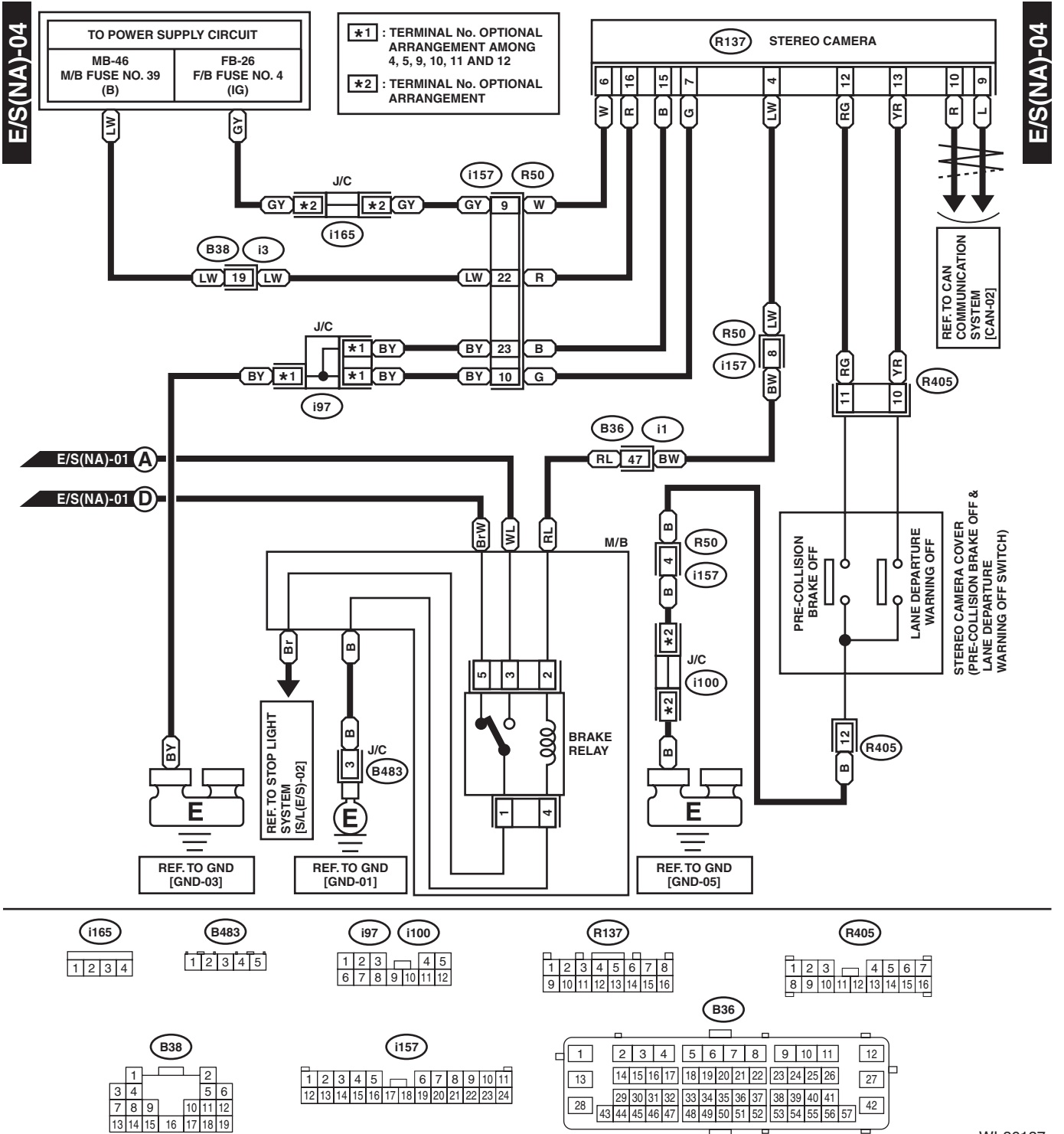

WI-36137

# EyeSight System

## WIRING SYSTEM

### 2. 3.6 L MODEL

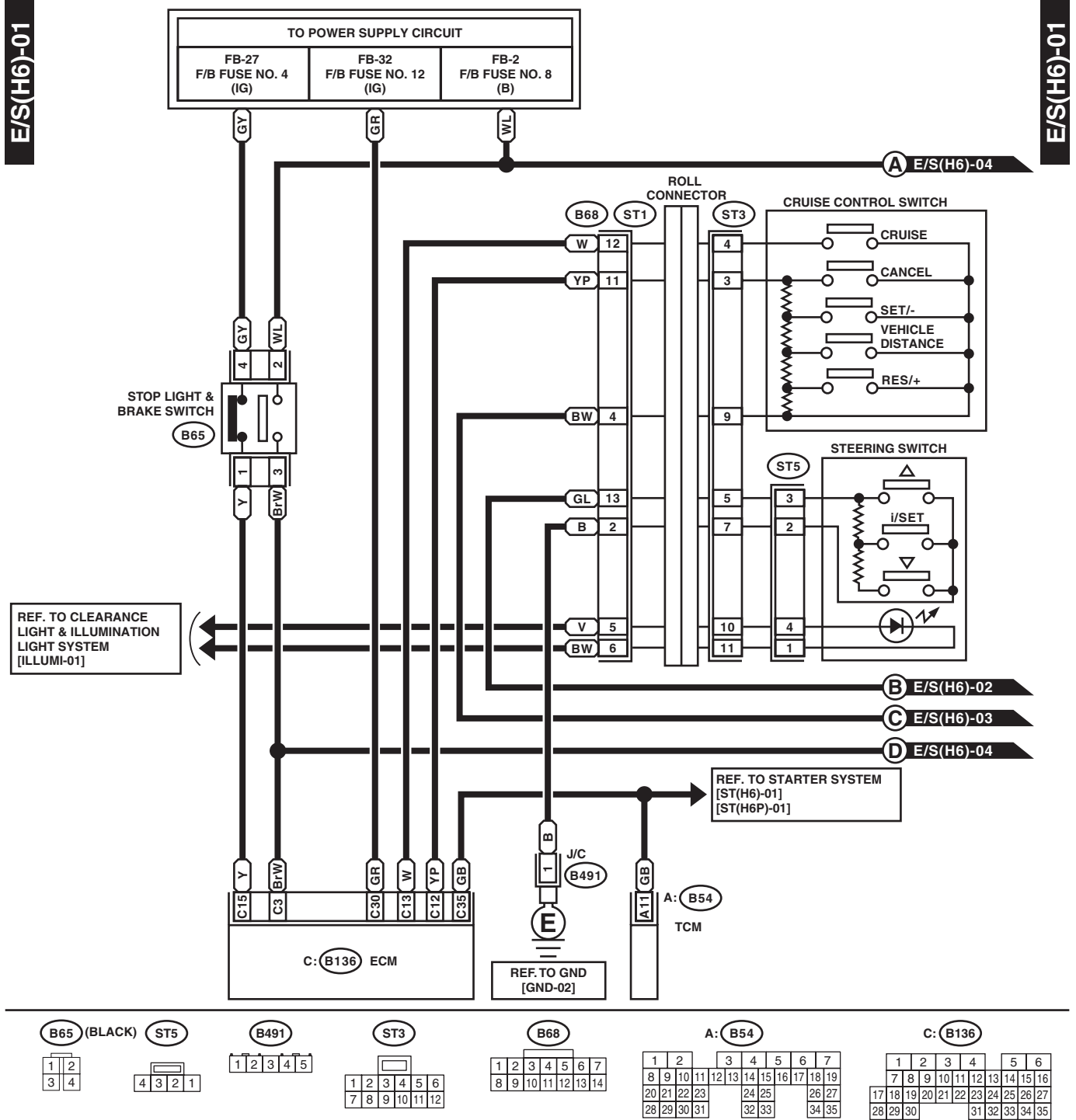

WI-36138

# EyeSight System

WIRING SYSTEM

E/S(H6)-02

E/S(H6)-02

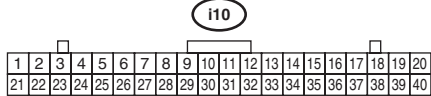
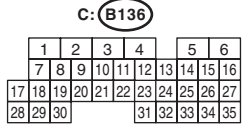
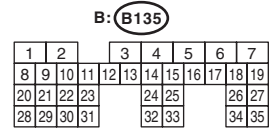
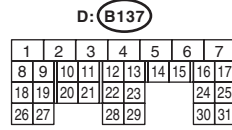
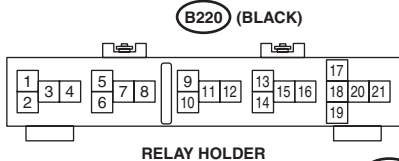
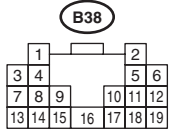
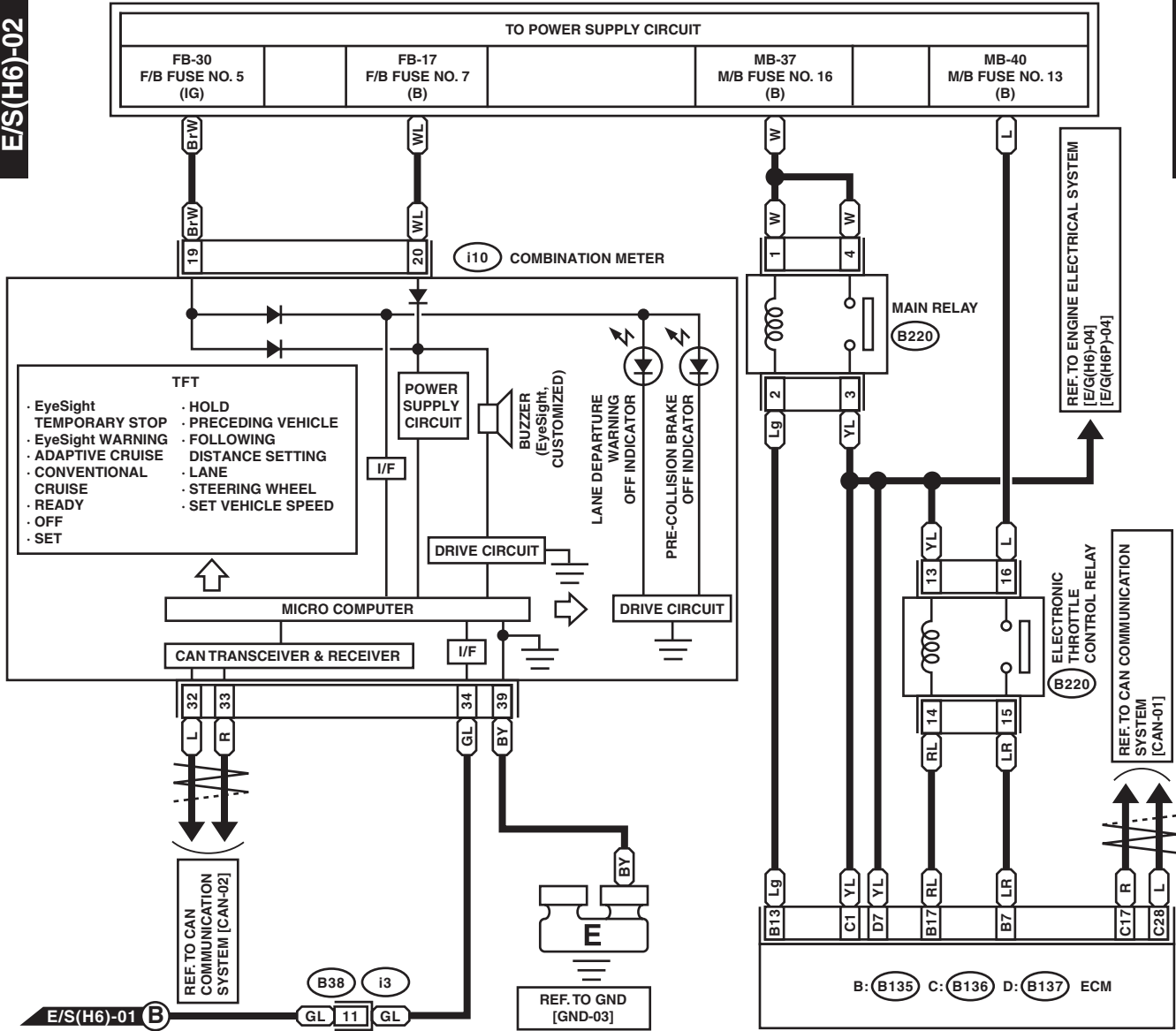

WI-41477

# EyeSight System

## WIRING SYSTEM

E/S(H6)-03

E/S(H6)-03

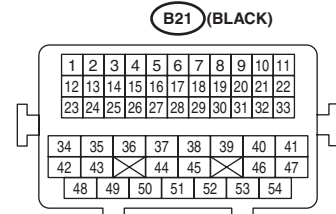
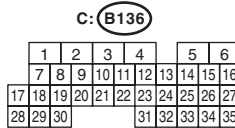
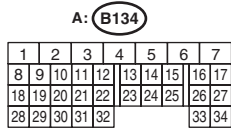
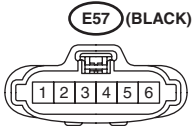
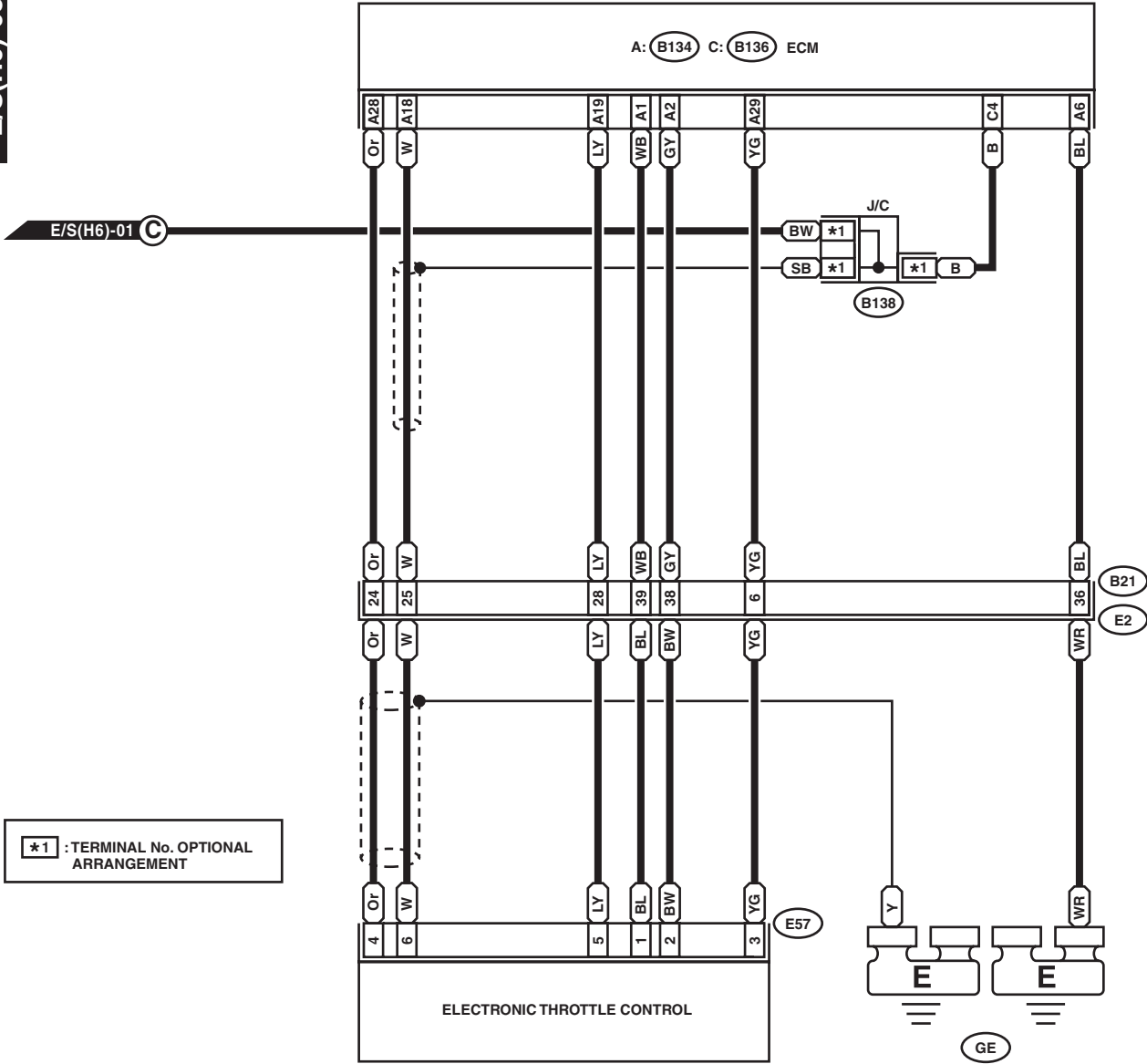

WI-41347

# EyeSight System

## WIRING SYSTEM

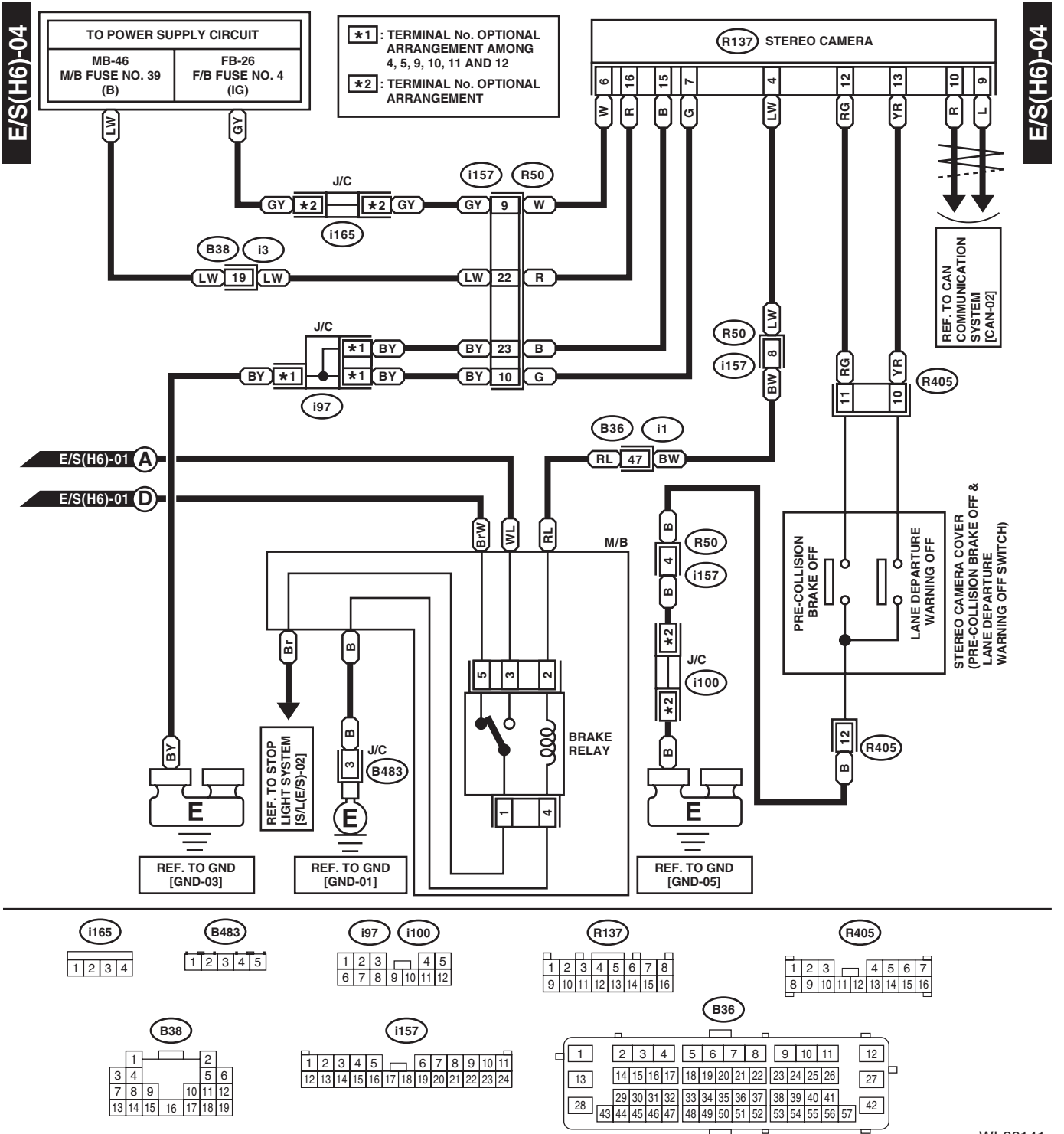

WI-36141