

Parking Brake / Brake Fluid Level Warning Light System

WIRING SYSTEM

BR/W-02

BR/W-02

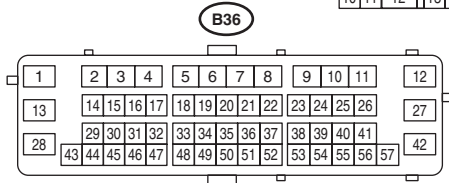
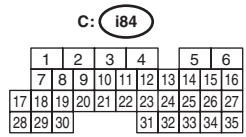
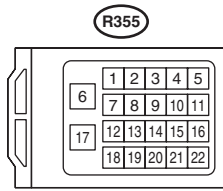
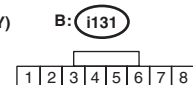
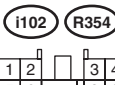
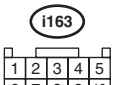
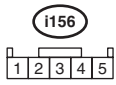
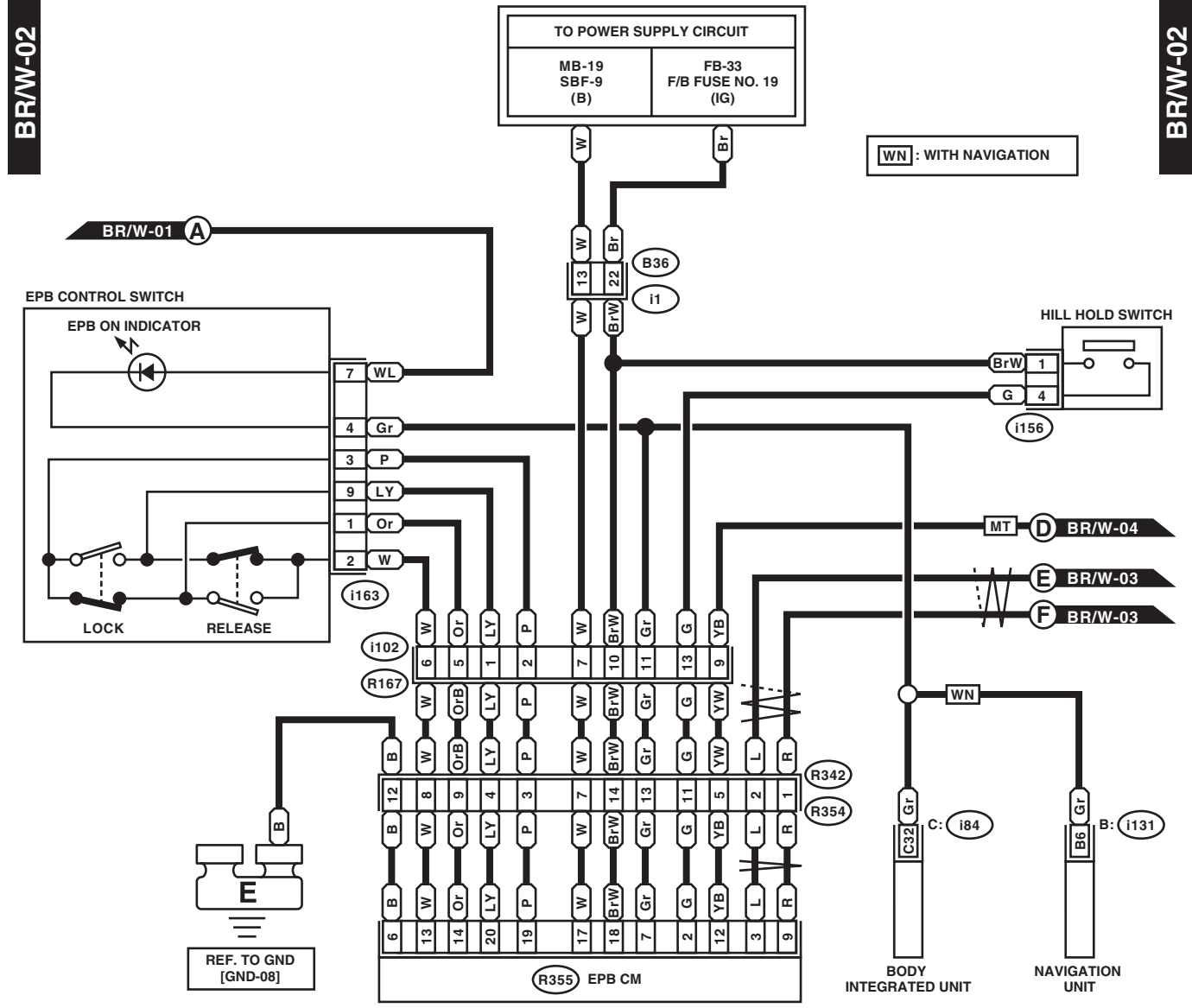

WI-36306

Parking Brake / Brake Fluid Level Warning Light System

WIRING SYSTEM

BR/W-03

BR/W-03

25 : 2.5 L MODEL
 H6 : 3.6 L MODEL
 *1 : TERMINAL No. OPTIONAL ARRANGEMENT

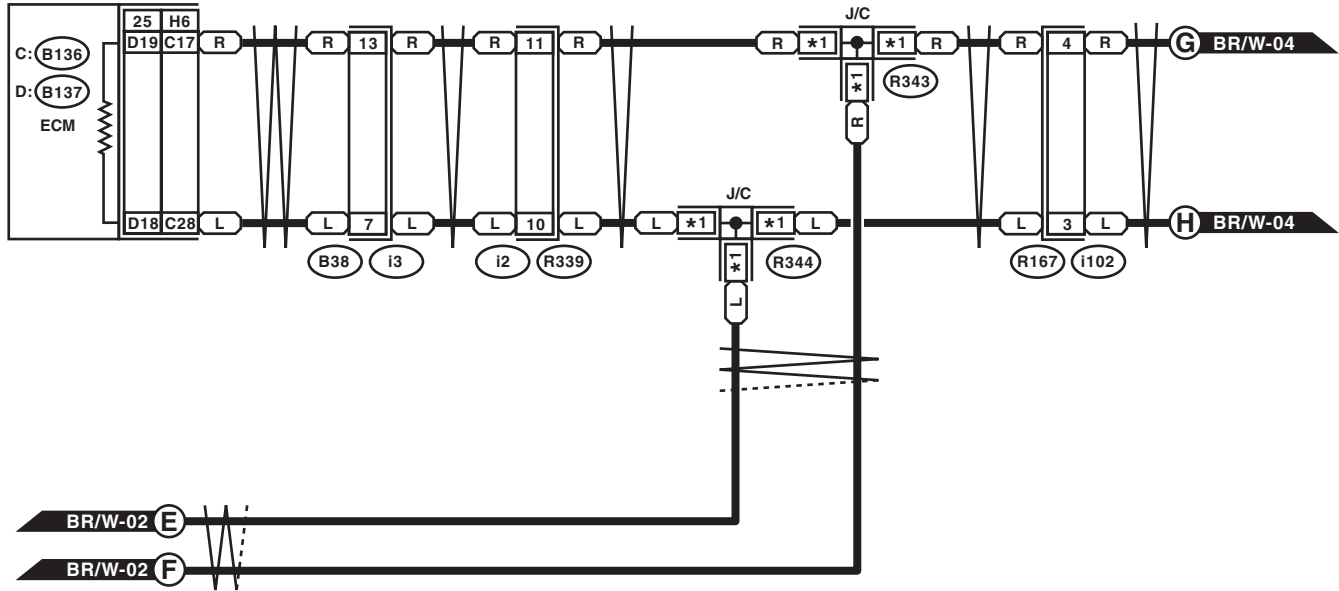

R343 R344

1	2	3	4
---	---	---	---

i102

1	2	3	4
5	6	7	8
9	10	11	12
13	14	15	16

B38

1	2
3	4
5	6
7	8
9	10
11	12
13	14
15	16
17	18
19	20

i2

1	2	3	4	5	6	7	8	9	10	11
12	13	14	15	16	17	18	19	20	21	22

D: B137

1	2	3	4	5	6	7
8	9	10	11	12	13	14
15	16	17	18	19	20	21
22	23	24	25	26	27	28
29	30	31	32	33	34	35

C: B136

1	2	3	4	5	6
7	8	9	10	11	12
13	14	15	16	17	18
19	20	21	22	23	24
25	26	27	28	29	30
31	32	33	34	35	36

WI-36307

