

## 35. Power Window System

### A: WIRING DIAGRAM

#### 1. WITHOUT DRIVER'S SEAT AUTO UP FUNCTION

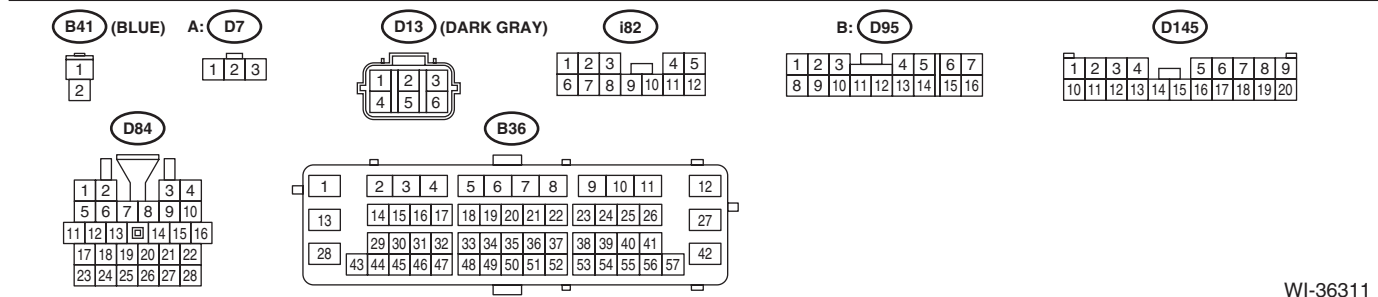
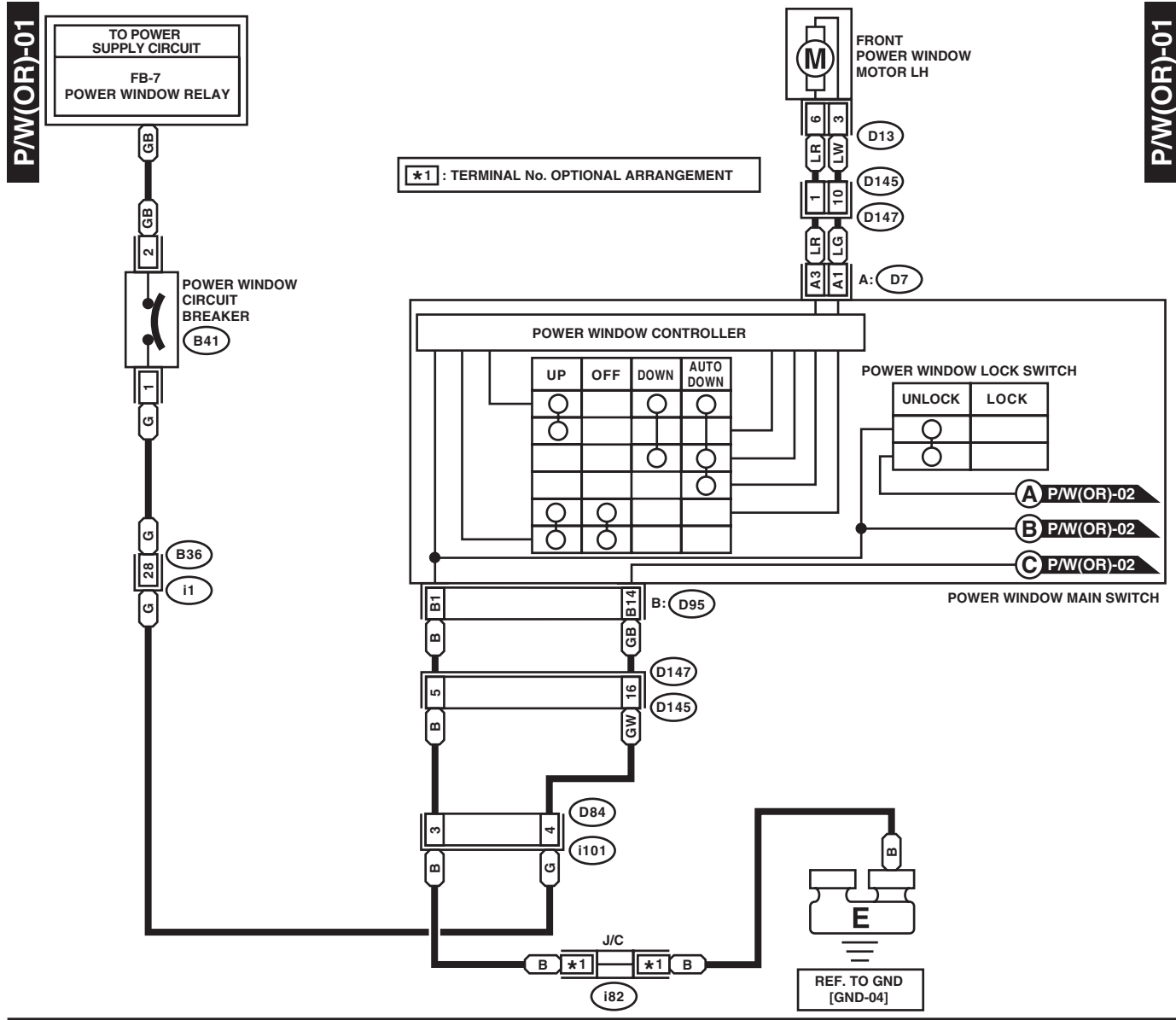

WI-36311

# Power Window System

## WIRING SYSTEM

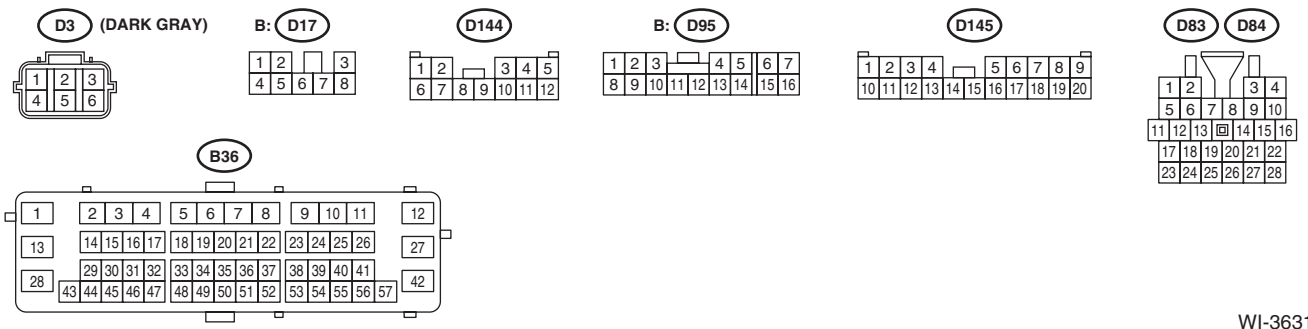
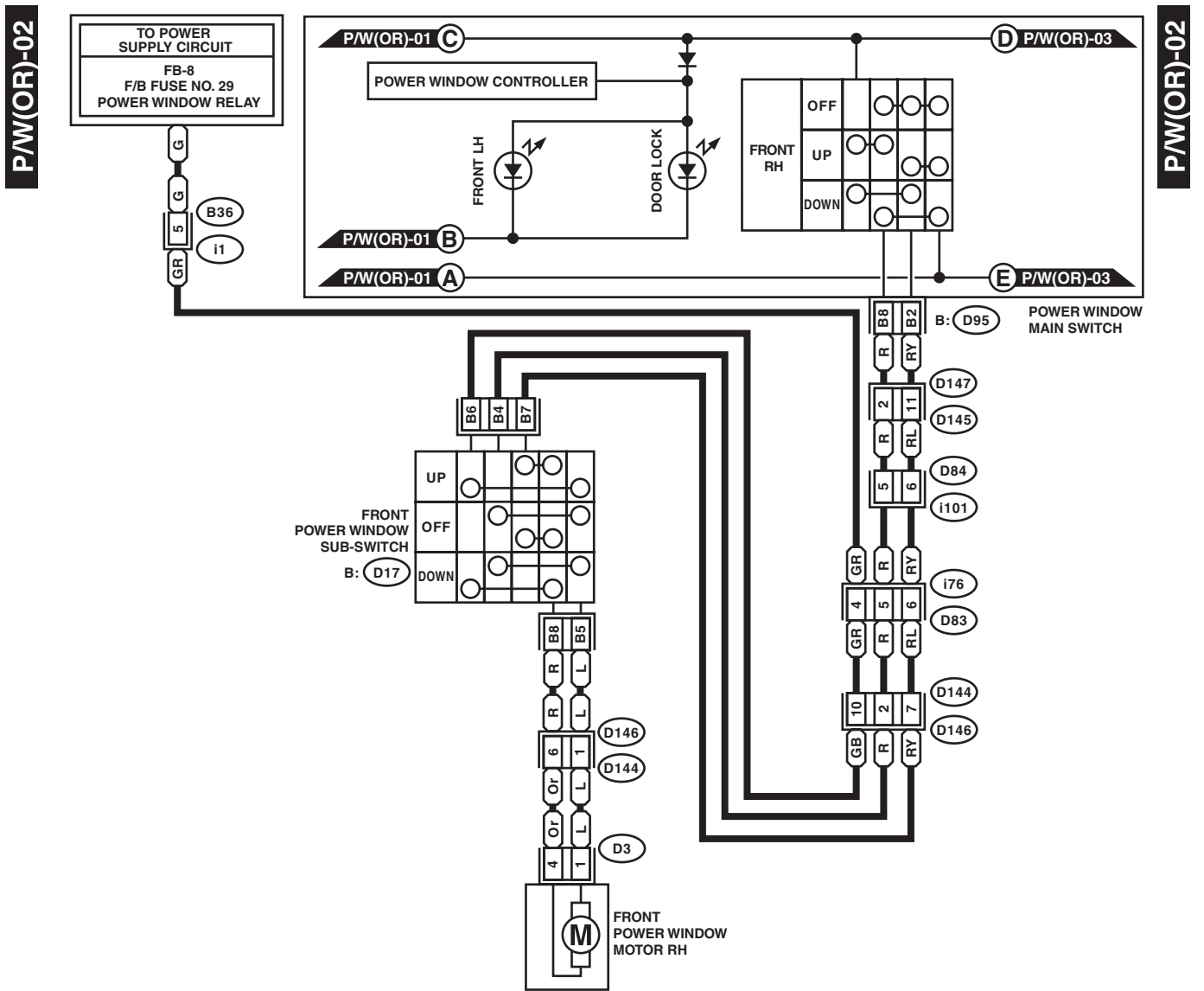

WI-36312

# Power Window System

WIRING SYSTEM

P/W(OR)-03

P/W(OR)-03

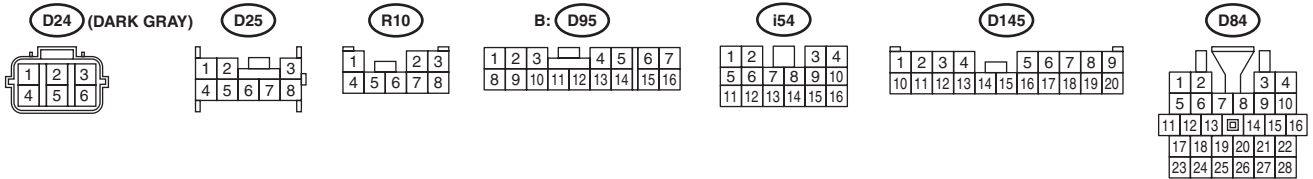
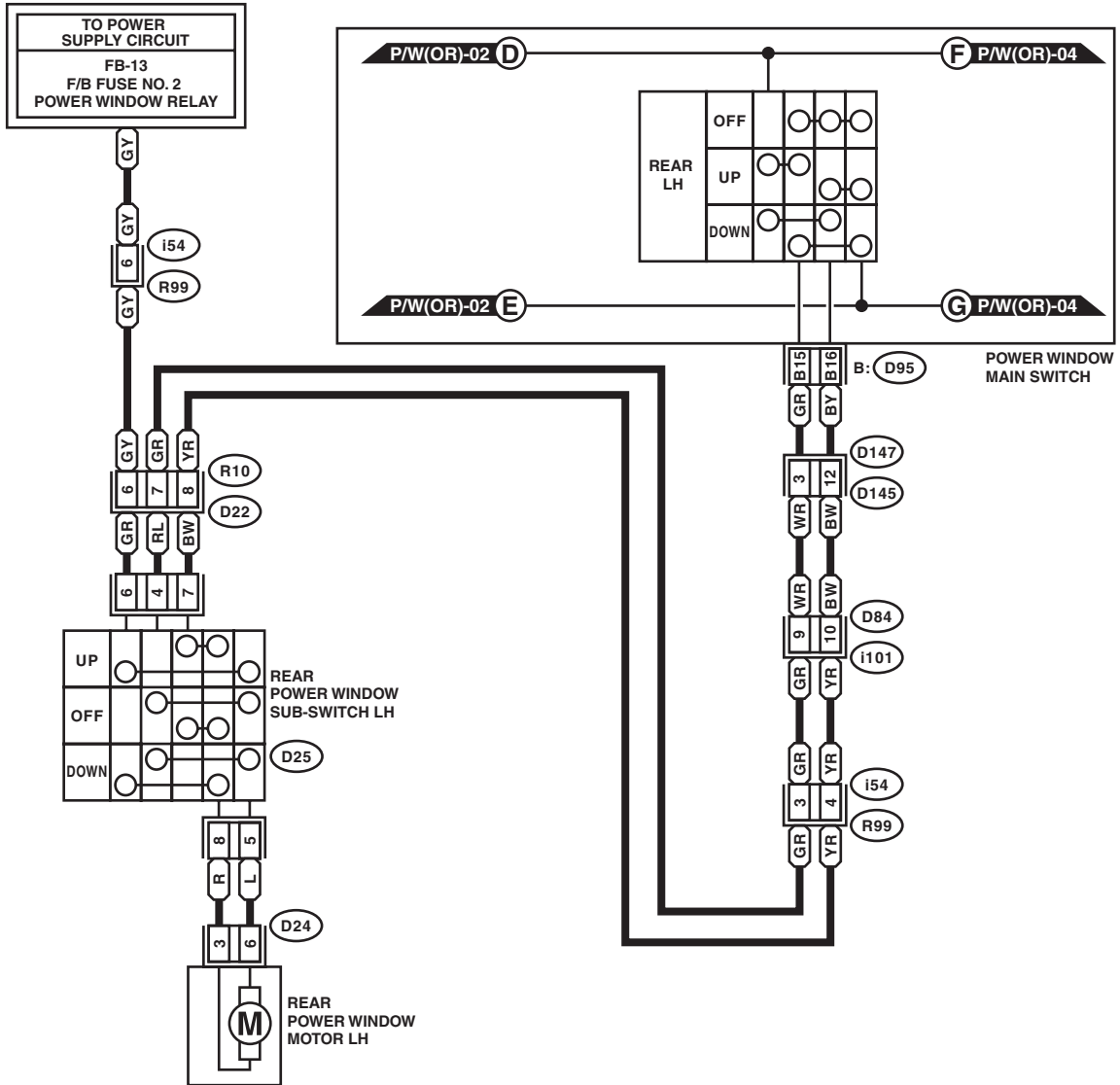

WI-36313

# Power Window System

## WIRING SYSTEM

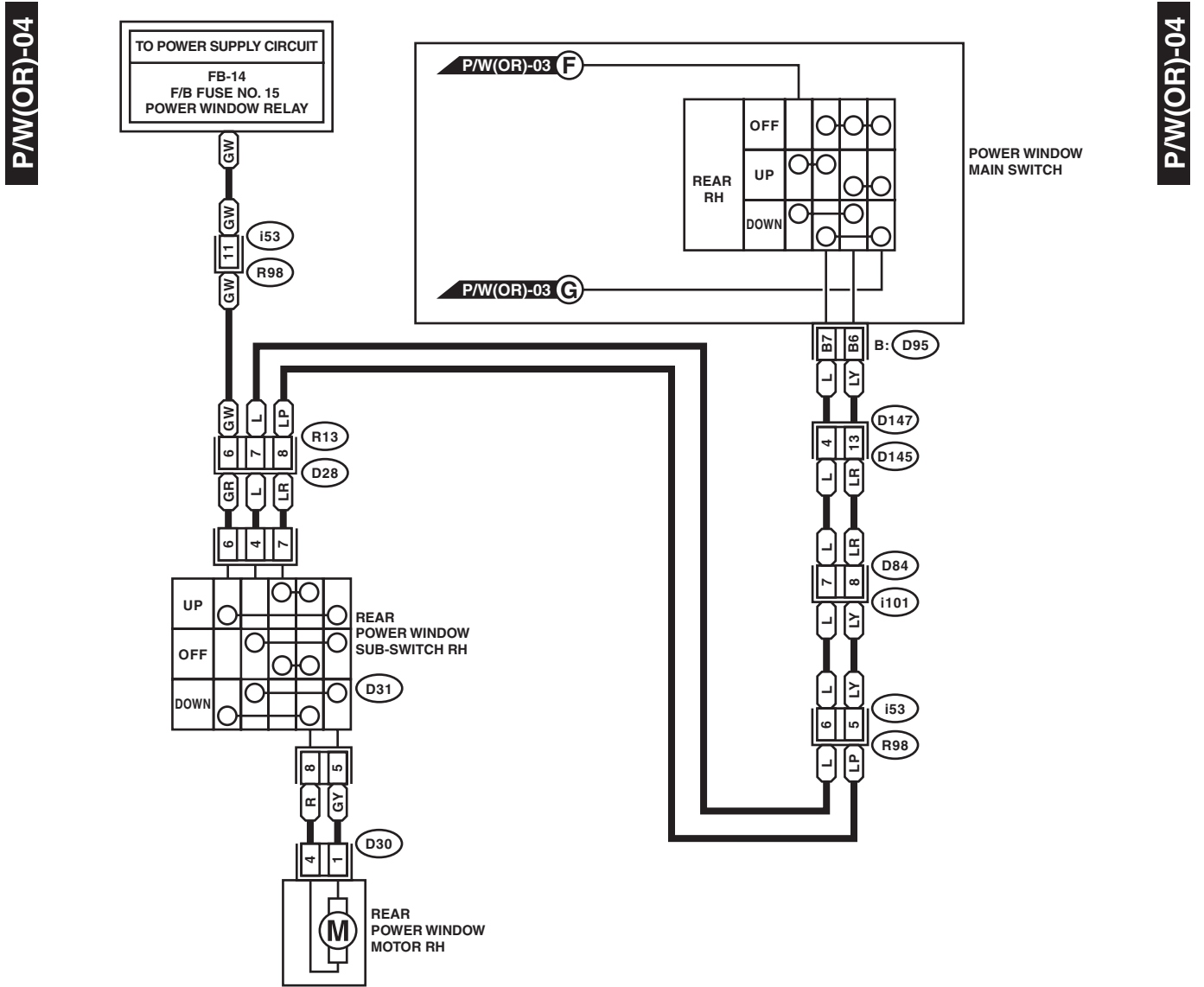

**P/W(OR)-04**

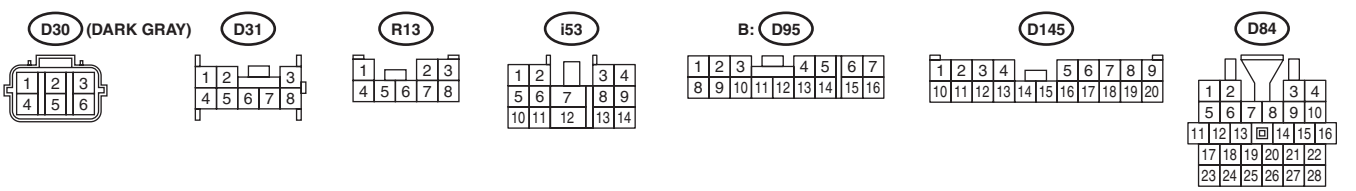

WI-36314

## 2. WITH DRIVER'S SEAT AUTO UP FUNCTION

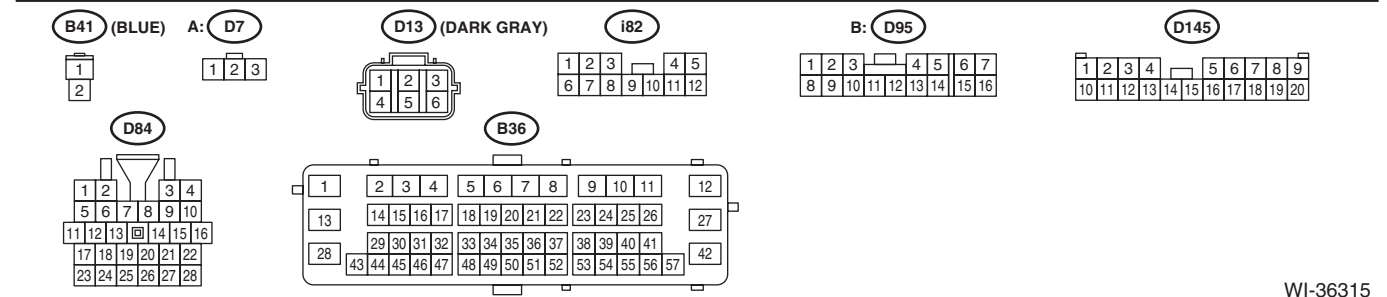
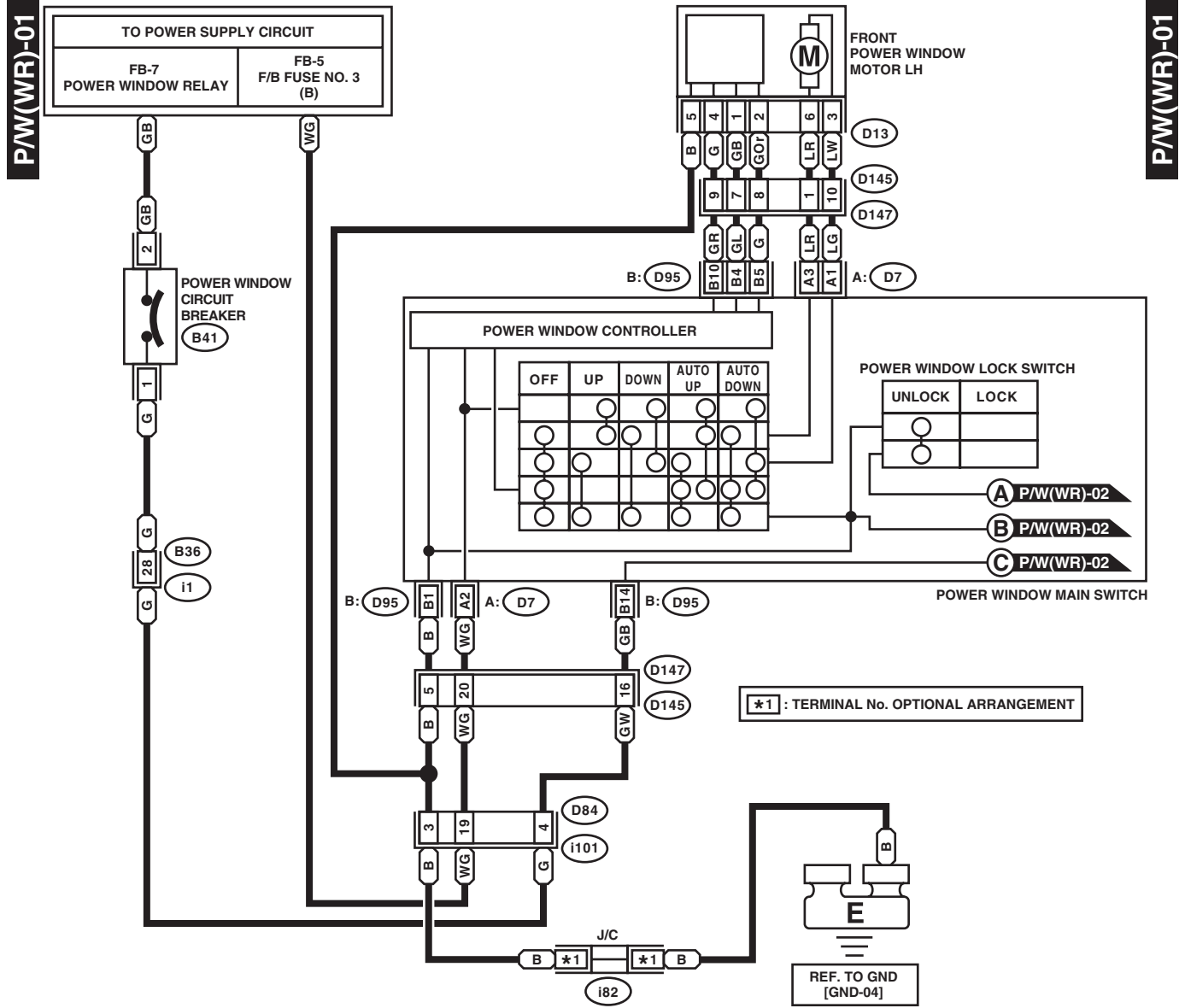

WI-36315

# Power Window System

## WIRING SYSTEM

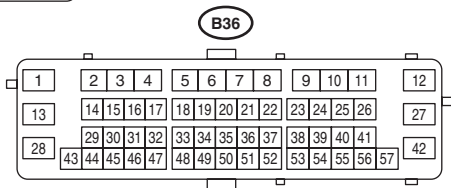
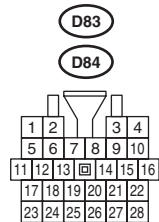
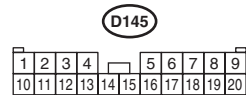
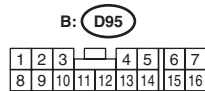
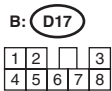
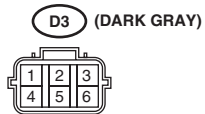
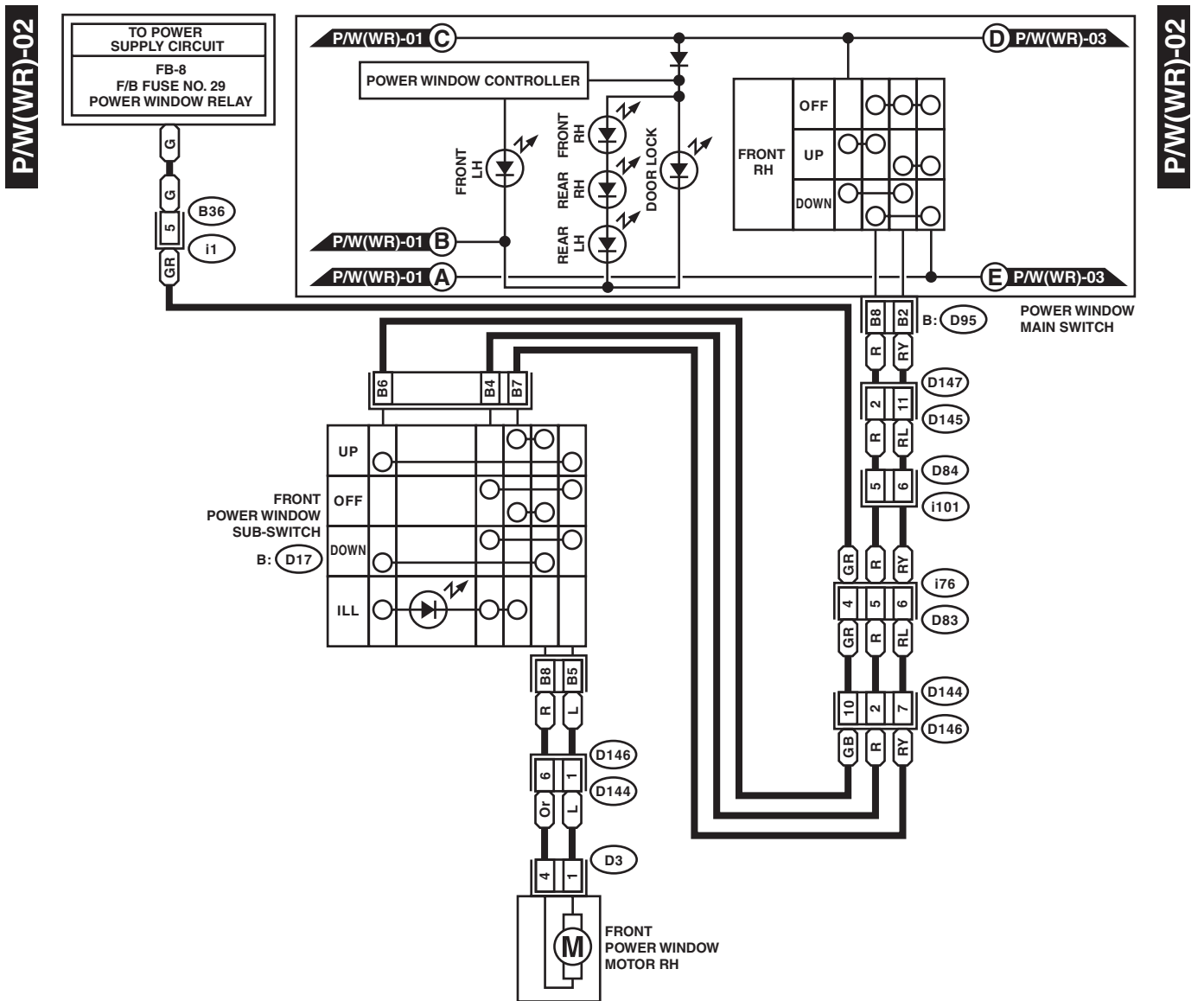

WI-36316

# Power Window System

WIRING SYSTEM

P/W(WR)-03

P/W(WR)-03

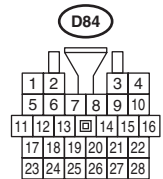
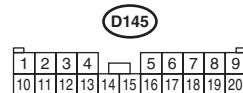
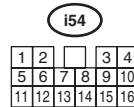
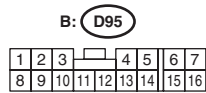
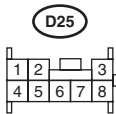
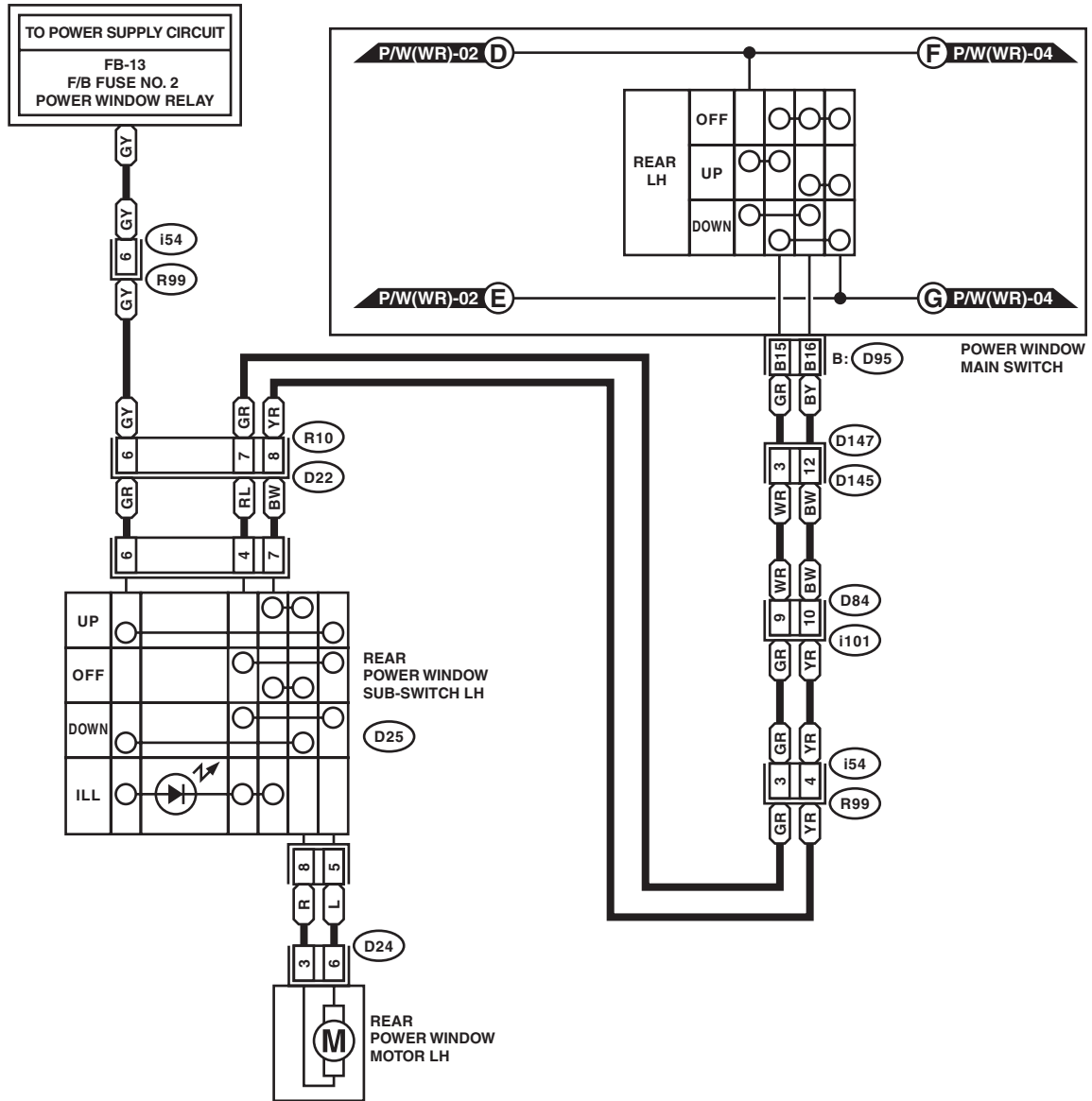

WI-36317

# Power Window System

## WIRING SYSTEM

P/W(WR)-04

P/W(WR)-04

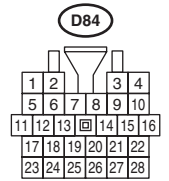
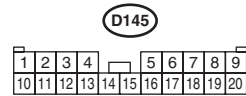
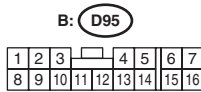
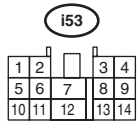
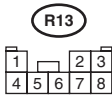
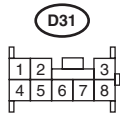
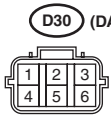
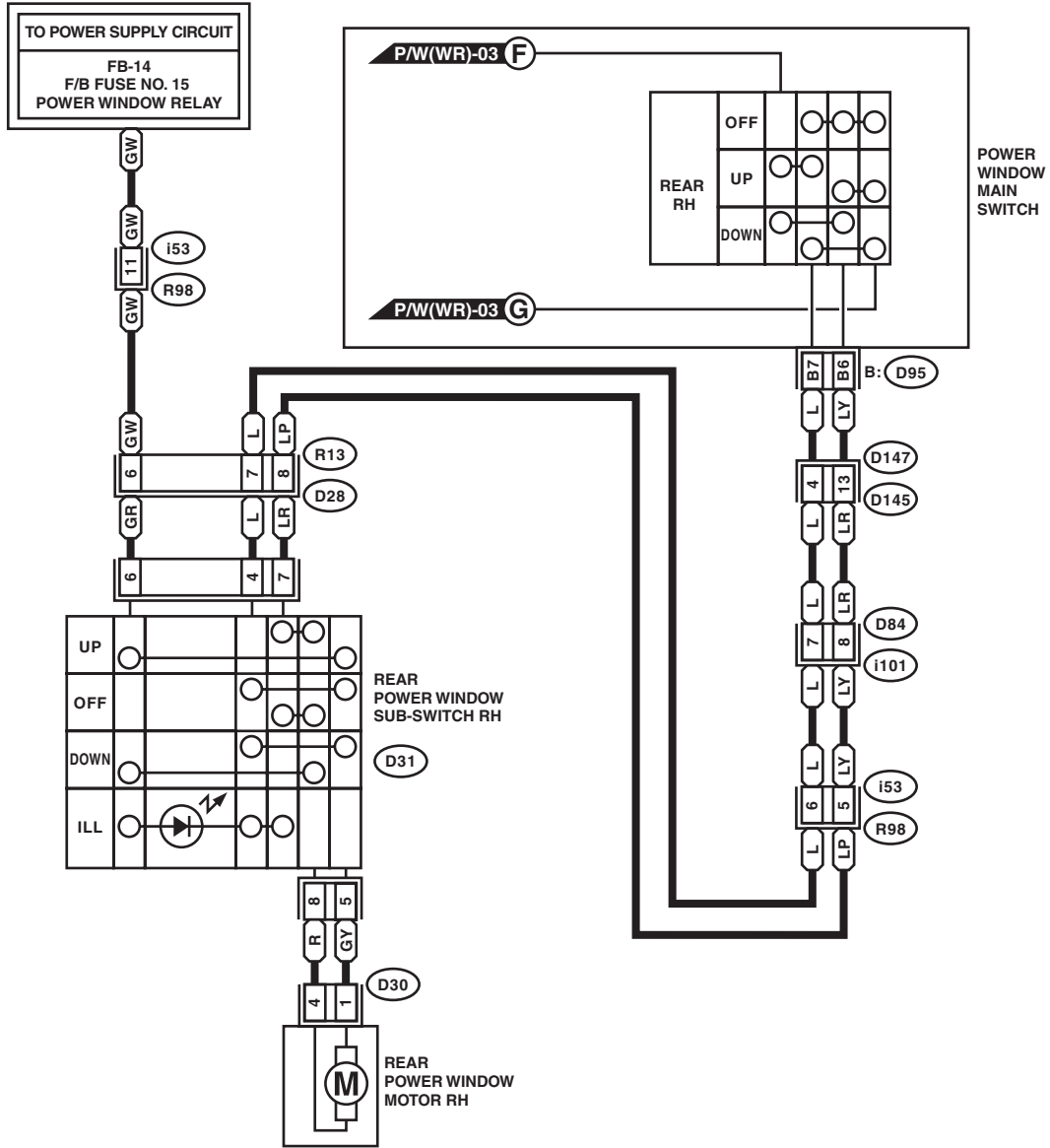

WI-36318