

37.Radiator Fan System

A: WIRING DIAGRAM

1. 2.5 L MODEL

R/F(NA)-01

R/F(NA)-01

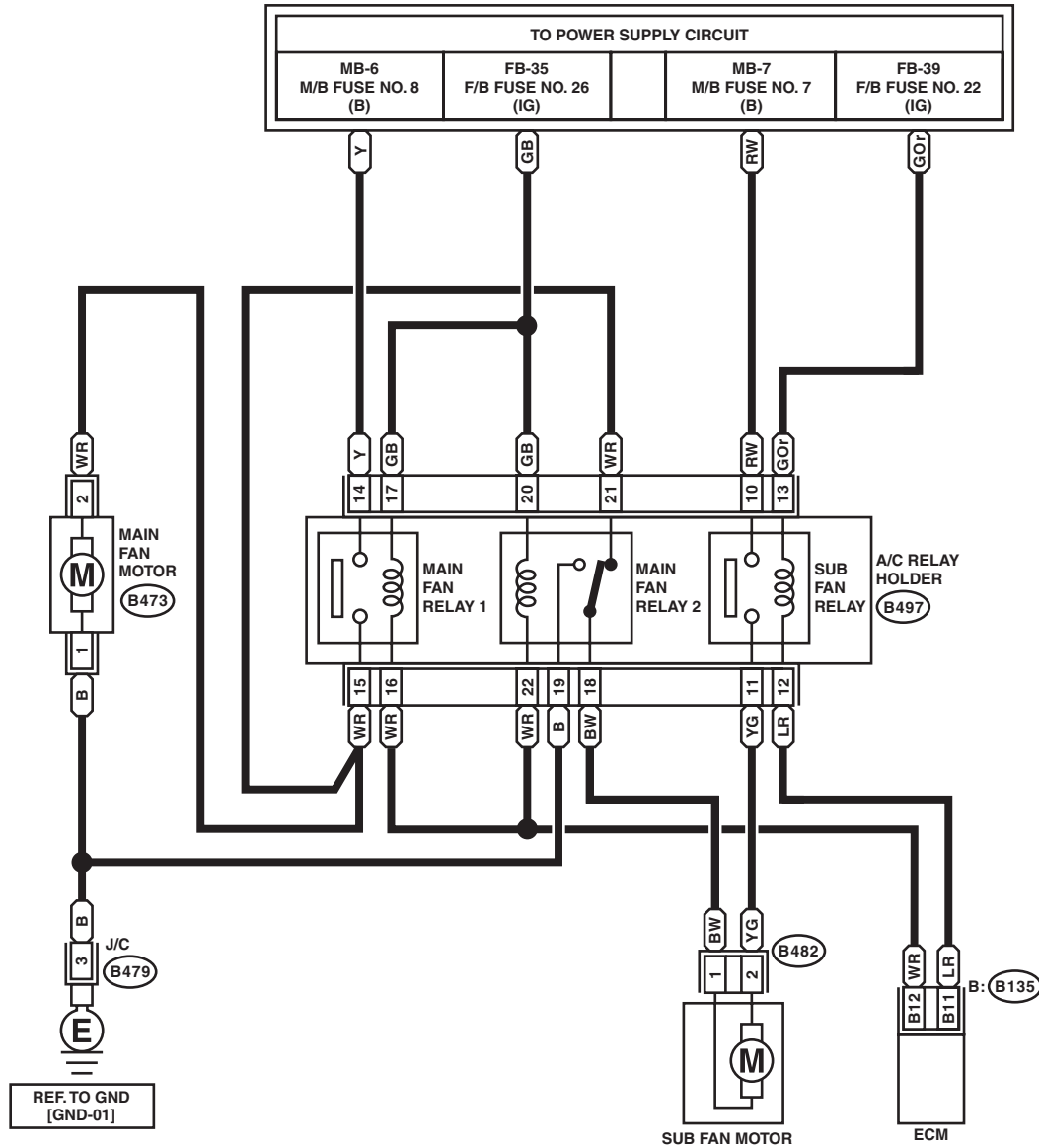

B473 (BLACK)

B479

B482 (BLACK)

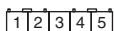

B497 (BLACK)

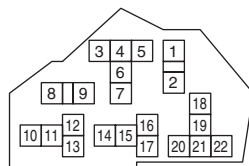

A/C RELAY HOLDER

B: B135

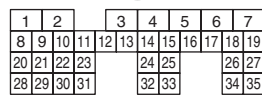

Radiator Fan System

WIRING SYSTEM

2. 3.6 L MODEL

R/F(H6)-01

R/F(H6)-01

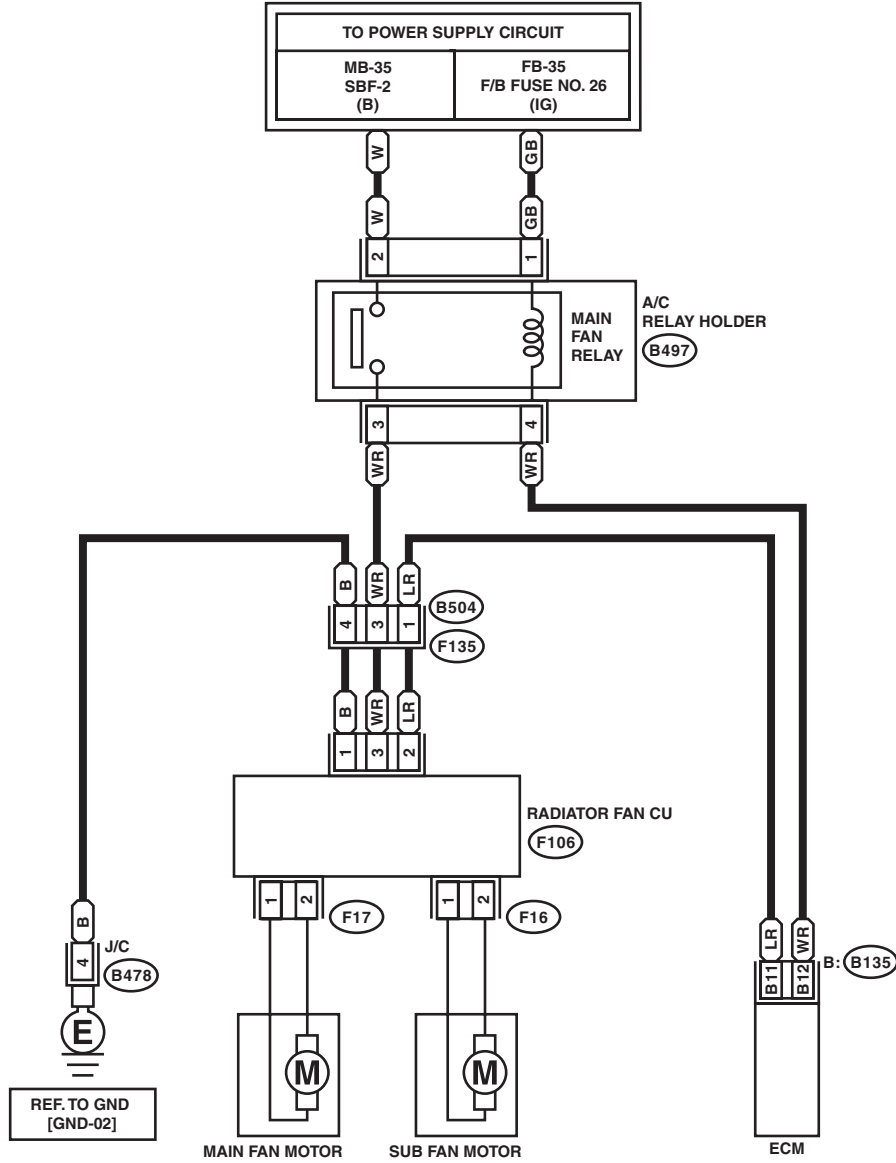

(F16) (GRAY)

(F106) (LIGHT GRAY)

(B504) (BLACK)

(B478)

(B497) (BLACK)

B: (B135)

(F17) (BLACK)

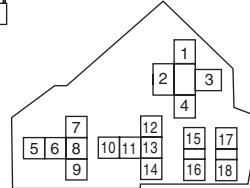
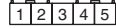

A/C RELAY HOLDER

WI-25568