

LEGACY

2017 Quick Reference Guide



SUBARU

Confidence in Motion



For detailed operating and safety information, please refer to your Owner's Manual.

BASIC OPERATION

Lock/Unlock doors

Remote keyless entry system

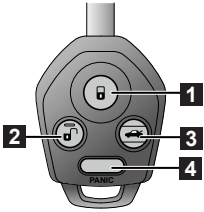

Remote transmitter key (if equipped)

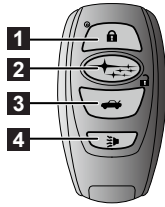

Access key (if equipped)

- 1** All doors will be locked.
- 2** The driver's door will be unlocked. (To unlock all doors, briefly press the button a second time within 5 seconds.)
- 3** Press and hold to open the trunk.
- 4** The horn will sound and the hazard warning flashes will flash.

Keyless access function (if equipped)

All doors will be locked/unlocked by the following procedures carrying the access key on your person. (The driver should always carry the access key.)

Side door (front door handles only):

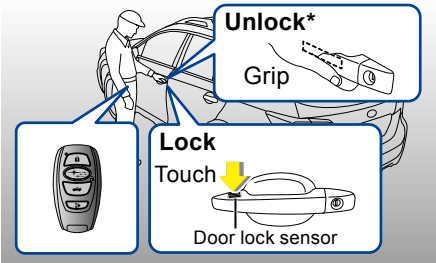

*Grip the driver's door handle to unlock the driver's door. Grip the front passenger's door handle to unlock all doors.

Opening trunk:

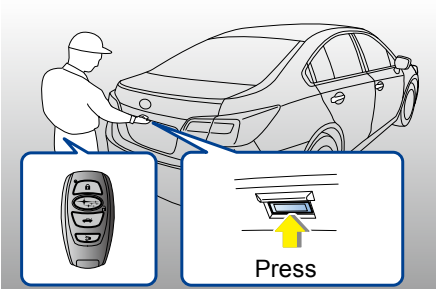

Adjust each component

Front seat

Power seat (Driver's seat-if equipped):

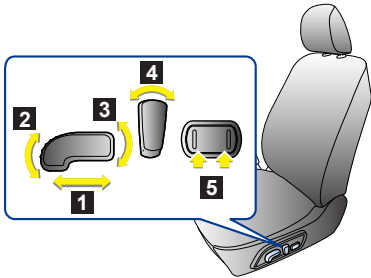

- 1 Forward and backward adjustment
- 2 Seat cushion angle adjustment
- 3 Seat height adjustment
- 4 Seatback angle (reclining) adjustment
- 5 Lumber support adjustment (if equipped)

Manual seat (if equipped):

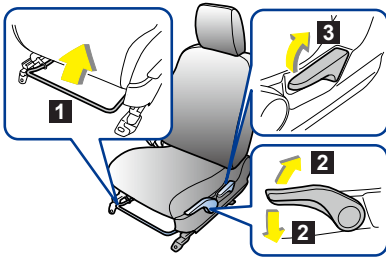

- 1 Forward and backward adjustment
- 2 Seat cushion height adjustment (Driver's seat only)
- 3 Seatback reclining adjustment

Tilt/telescopic steering wheel

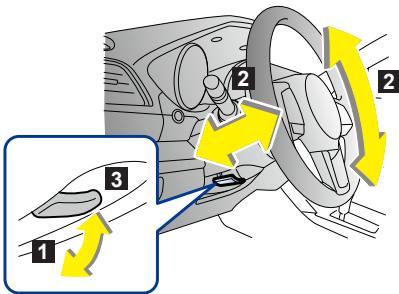

- 1 Adjust the seat position and pull the tilt/telescopic lock lever down.
- 2 Move the steering wheel to the desired level.
- 3 Pull the lever up to lock the steering wheel in place.

Make sure that the steering wheel is securely locked by moving it up and down, and forward and backward.

Remote control mirror switch

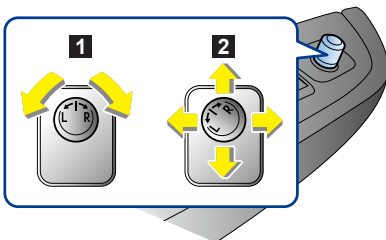

Ignition switch must be in **ACC** or **ON** position.

- 1 Select side to adjust
- 2 To adjust the mirror, move the switch in the direction of your desired position.

Start/Stop engine

Push-button ignition switch (if equipped)

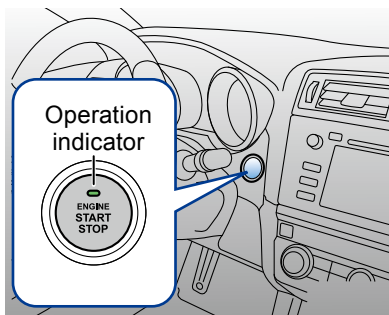

To start engine:

- STEP1:** Carry the access key, and sit in the driver's seat.
- STEP2:** Apply the parking brake.
- STEP3:** Shift the select lever in the **P** position.
- STEP4:** Depress the brake pedal until the indicator on the push-button ignition switch turns green.
- STEP5:** While depressing the brake pedal, press the push-button ignition switch.

To stop engine:

- STEP1:** Stop the vehicle completely.
- STEP2:** Move the select lever to the **P** position.
- STEP3:** Press the push-button ignition switch.

Change of the power supply (Without starting engine)

Every time the button is pressed without depressing the brake pedal, the power is switched in the sequence of **OFF→ACC→ON→OFF**.



Electronic parking brake switch

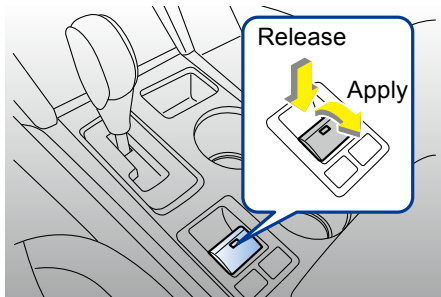

*The design may be slightly different from the illustration depending on the models.

Ignition switch (if equipped)



The key can be turned from **ACC** to **LOCK** only when the key is pushed in while turning it (all models) and the select lever is in the **P** position (CVT models).

Operate Select lever/Shift lever

Continuously variable transmission (if equipped)

Select lever button

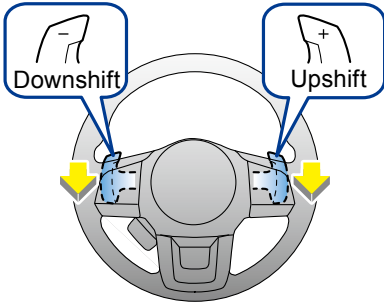
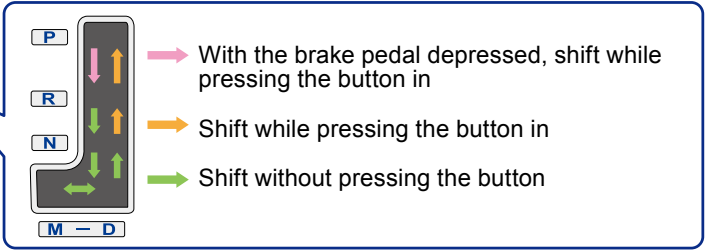
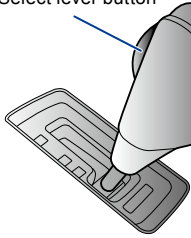

M = Manual mode:

With the vehicle either moving or stationary, move the select lever from the **D** position to the **M** position to select the manual mode.

Shift paddle:

Gearshifts can be performed using the shift paddle behind the steering wheel.

Manual transmission (if equipped)

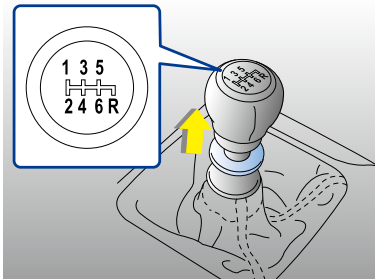

You must raise the slider and hold it in that position before you can move the shift lever to the **R** position. To change gears, fully depress the clutch pedal, move the shift lever, and gradually let up on the clutch pedal.

MAIN PARTS AND OPERATION

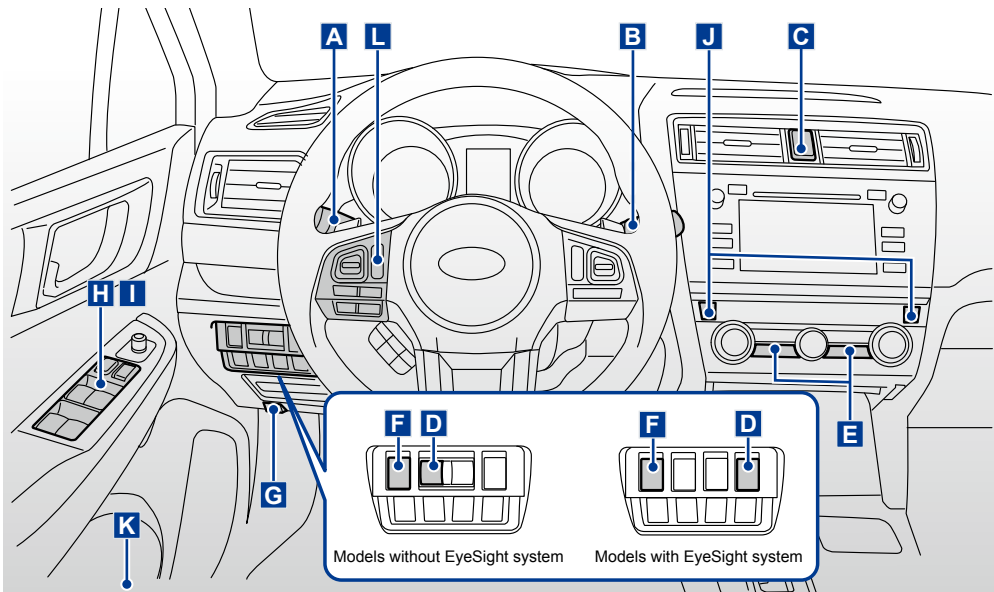

A Headlight switch/Turn signal lever/Front fog light switch (if equipped)

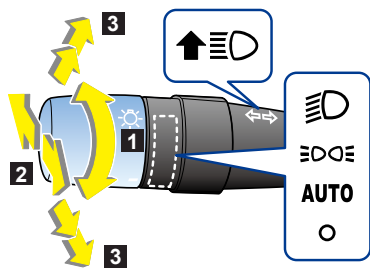

1 Headlights

2 Headlight flasher, High/Low beam change (dimmer)

High beam assist function (if equipped)

The high beam assist function automatically changes the headlight from high beam to low beam (or vice versa).

■ The high beam assist function is activated when:

1. The light control switch is in the **AUTO** position and the low beam headlights are on automatically.
2. The turn signal lever is pushed forward.

When the high beam assist function is activated, the indicator (green) on the combination meter will illuminate.



High beam assist indicator

3 Turn signal

4 Front fog lights (if equipped)

To turn on the front fog lights, rotate dial to .

Front fog lights operate only when headlight switch is in...

-  position.
- **AUTO** position and the headlights are on.

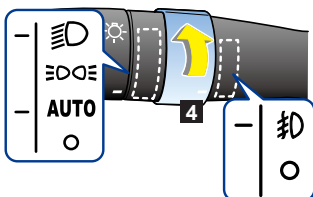

B Wiper and washer switch

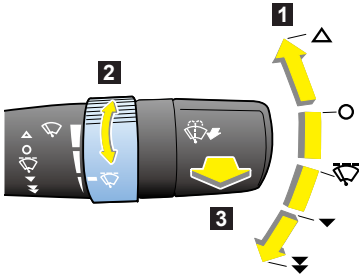

1 Windshield wiper

To operate the wiper, rotate knob to;

- △ : Mist (for a single wipe)
- : Off
- ⏸ : Intermittent
- ▼ : Low speed
- ▼▼ : High speed

2 Wiper intermittent time control

3 Windshield washer

C Hazard warning flasher switch

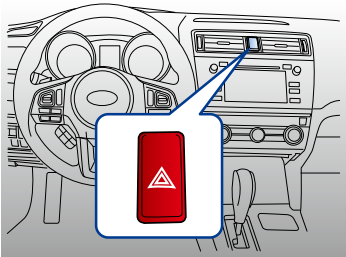

To turn on the hazard warning flasher, press the button. Use the hazard warning flasher when you have to park in emergency conditions.

D Illumination brightness control dial

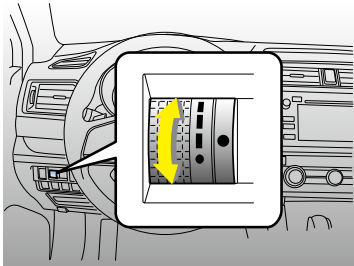

Turn the dial to adjust the illumination brightness of the instrument panel.

When the control dial is turned fully upward to

- position, the illumination brightness becomes the maximum and the automatic dimming function does not work at all.

*The design may be slightly different from the illustration depending on the models.

E Defroster button/Rear window defogger button

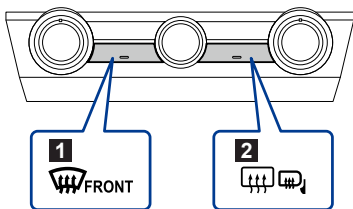

*The illustration of the print is Type A.

- 1 Defroster button:**
Press the button to defrost the windshield.
- 2 Rear window defogger button:**
Press the button to turn on rear window defogger, outside mirror defogger and windshield wiper deicer (if equipped). The function will automatically shut off after approximately 15 minutes.

F Trunk lid opener switch

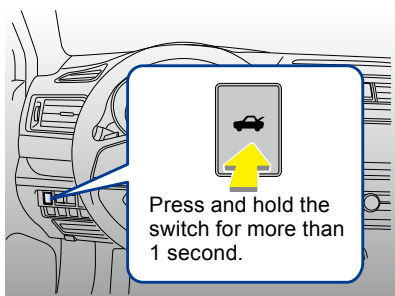

G Hood release knob

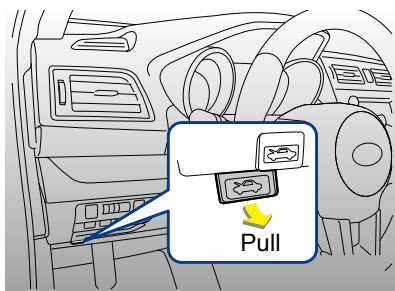

H Power window switches

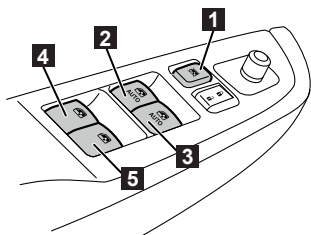

- 1 Lock switch**
- 2 For driver's window**
- 3 For front passenger's window**
- 4 For rear left passenger's window**
- 5 For rear right passenger's window**

I Power door locking switch

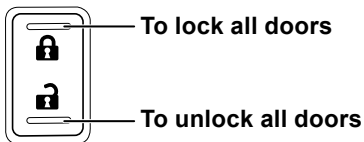

J Seat heater (if equipped)

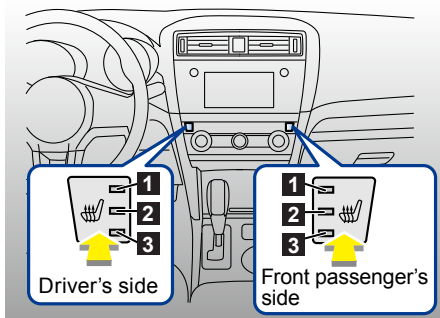

Front seat heater switch

- 1 HIGH mode indicator
- 2 MID mode indicator
- 3 LOW mode indicator

K Fuel filler lid release lever

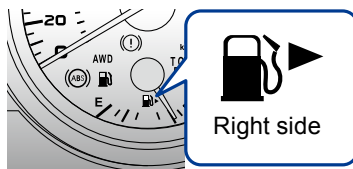
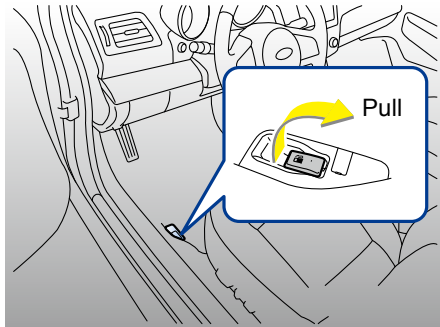

This indicates that the fuel filler door (lid) is located on the right side of the vehicle.

L Audio control buttons

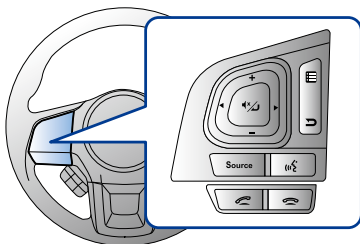

These buttons allow the driver to control audio functions without taking his/her hands off the steering wheel.

Hill Holder switch

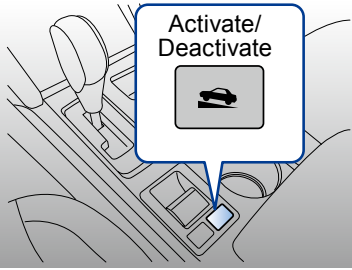

*The design may be slightly different from the illustration depending on the models.

Deactivate the Hill Holder function when:

- Towing a trailer
- Carrying a heavy load
- When you do not frequently stop your vehicle on an uphill slope using the parking brake.

Moonroof switch (if equipped)

Tilting

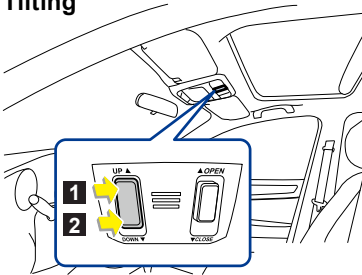

- 1 Raise
- 2 Lower

Sliding

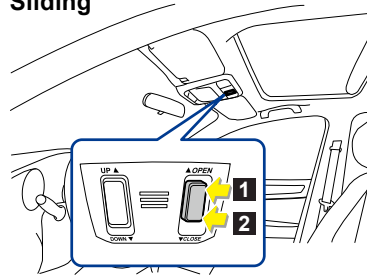

- 1 Open
- 2 Close

Child safety locks

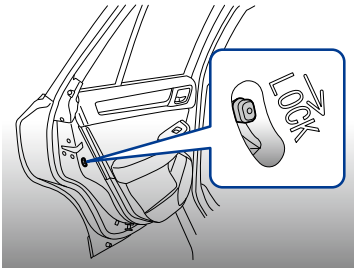

Located on the edge of each rear door.

When the lever is in the **LOCK** position, the rear door cannot be opened from the inside.

Front seat shoulder belt anchor height

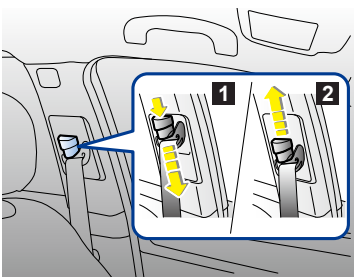

- 1 **To lower:**
Push the upper part of the anchor and slide it down.
- 2 **To raise:**
Slide the anchor up.

FUNCTION FOR MORE COMFORTABLE DRIVE

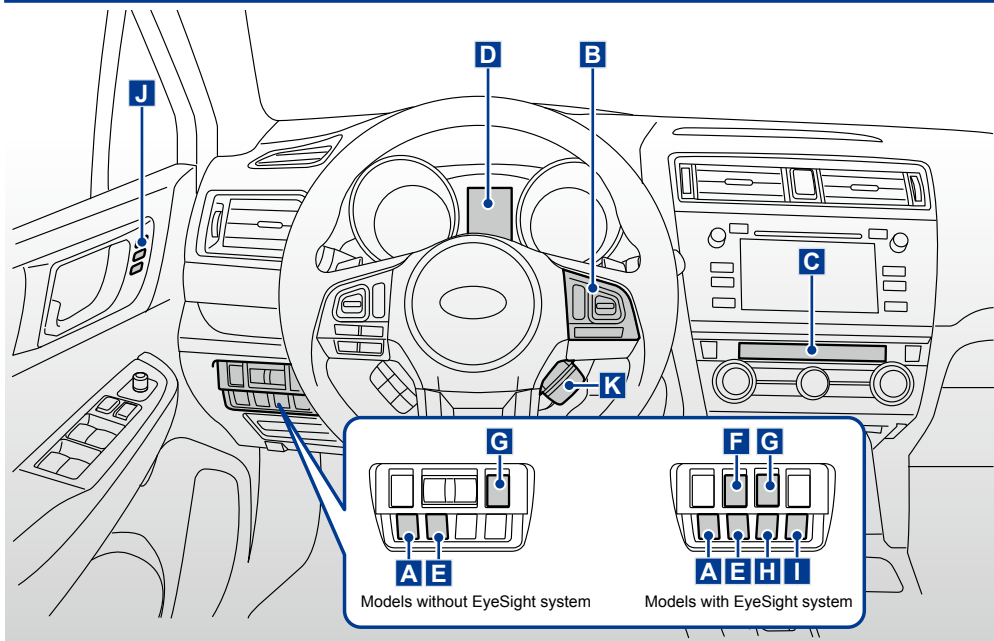

A Vehicle Dynamics Control OFF switch

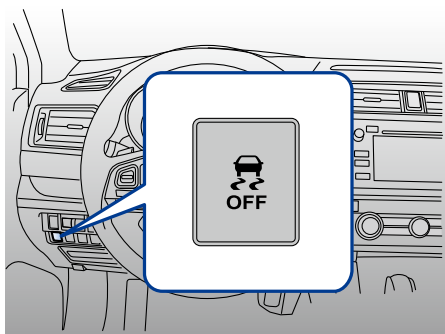

Press the switch to deactivate the Vehicle Dynamics Control system.

Indicator lights on the combination meter



Vehicle Dynamics Control mode



Vehicle Dynamics Control OFF mode

It may be helpful to temporarily deactivate the Vehicle Dynamics Control system to escape from the following situations.

- a standing start on a steeply sloping road with a snowy, gravel-covered, or otherwise slippery surface
- extrication of the vehicle when its wheels are stuck in mud or deep snow

Do not deactivate the system except when absolutely necessary.

B Cruise control buttons (if equipped)

■ Models without EyeSight system

Cruise control enables you to maintain a constant vehicle speed without holding your foot on the accelerator pedal and it is operative when the vehicle speed is 40 km/h (25 mph) or more.

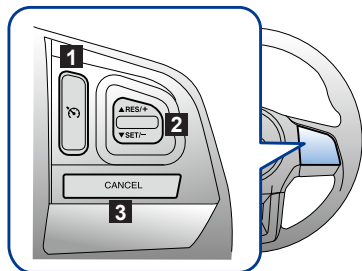

- 1 Cruise control main button:** To activate and deactivate
- 2 RES/SET switch:**
 - ▲RES/+ side : To increase the speed/To resume
 - ▼SET/- side : To set speed/To decrease the speed
- 3 CANCEL button:** To temporarily cancel

■ Models with EyeSight system

EyeSight is a driving support system that uses a range of functions to assist the driver in making decisions in order to provide for more safe and comfortable driving and to reduce driver fatigue.

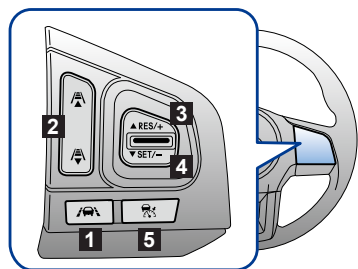

- 1** (Lane Keep Assist) switch
- 2** (Following distance setting) switch
- 3** RES/+ switch
- 4** SET/- switch
- 5** (CRUISE) switch

C Information display

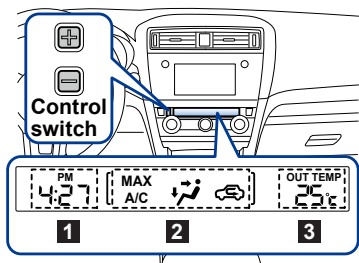

- 1** Clock
- 2** Climate control mode indicators
- 3** Outside temperature indicator

Control switch: To adjust the time shown by the clock, press the + button or the - button.

D Multi information display

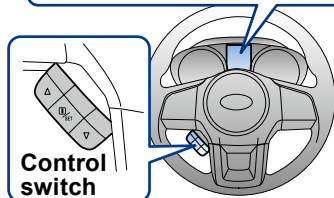
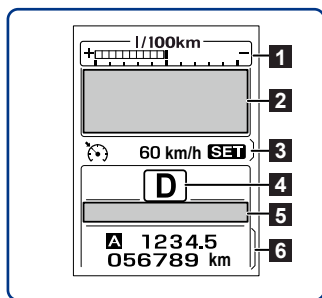

- 1 ECO gauge
- 2 Basic screen
- 3 Cruise control information
- 4 Select lever/gear position indicator
- 5 Warning screen
- 6 Odometer/double trip meter

Control switch: By operating ▲ or ▼ of the control switch, the screens and selection items can be switched. When the **i/SET** switch is pulled toward you, the item can be selected and set.

E BSD/RCTA OFF switch (if equipped)

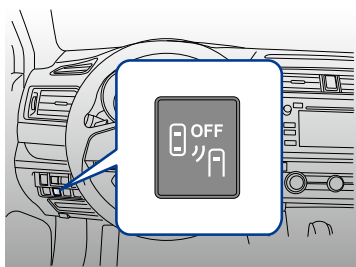

If the BSD/RCTA OFF switch is pressed, the BSD/RCTA OFF indicator is displayed on the multi information display of the combination meter, and the BSD/RCTA is deactivated.

BSD/RCTA

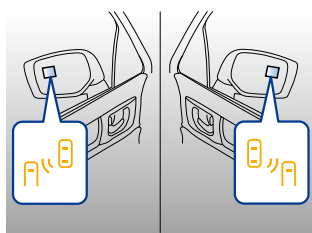

The BSD/RCTA consists of rear radar with Blind Spot Detection, Lane Change Assist and Rear Cross Traffic Alert. The system notifies the driver when vehicles in the blind area are approaching from behind in the neighboring lanes.

F Steering responsive fog lights OFF switch (if equipped)

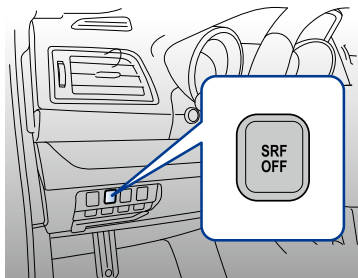

If the steering responsive fog lights OFF switch is pressed, the steering responsive fog lights OFF indicator is displayed on the Multi information display of the combination meter, and the steering responsive fog lights system is deactivated.



**Steering responsive fog lights system
OFF indicator**

Steering responsive fog lights system

The steering responsive fog lights system automatically turns the front fog light on and off based on the steering angle and vehicle speed when entering a curve or driving on curved roads.

The system is intended to help prevent accidents by enabling better visibility of curves ahead and early recognition of any disabled vehicles or other obstacles.

G Lane Departure Warning OFF switch (Models with EyeSight system)

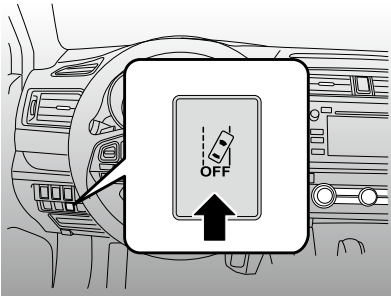

Press and hold this switch for approximately 2 seconds or longer to turn off the Lane Departure Warning and Lane Sway Warning functions.

Lane Departure Warning

When vehicle speed is approximately 50 km/h (30 MPH) or more, this function warns the driver if the system detects that the vehicle is likely to depart the traffic lane.

H Pre-Collision Braking System OFF switch (Models with EyeSight system)

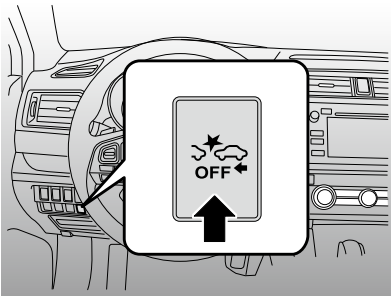

Press and hold this switch for approximately 2 seconds or longer to turn off the Pre-Collision Braking System and Pre-Collision Throttle Management.

Pre-Collision Braking System

When there is the risk of a rear-end collision with an obstacle in front, the EyeSight system helps to minimize or prevent a collision by warning the driver. If the driver still does not take evasive action to avoid a collision, the brakes can be automatically applied just before the collision in order to reduce impact damage, or if possible, prevent the collision. If the driver takes evasive action to avoid a collision, Pre-Collision Brake Assist will operate in order to help the driver to prevent the collision.

I Seat position memory function (driver's seat - if equipped)

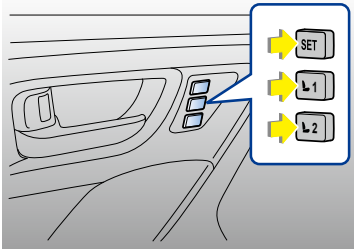

Some of your desired seat positions can be registered. Register the seat position with button **1** or **2** or each of the access keys (if equipped) and retrieve the seat position.

J Heated Steering Wheel system (if equipped)

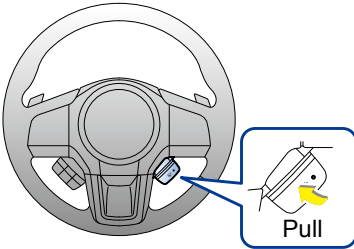

The Heated Steering Wheel system warms the surface of the steering wheel at a constant temperature.

MAIN WARNING AND INDICATOR LIGHTS

Some warning/indicator lights illuminate for a few seconds in order to check themselves when the ignition switch is turned ON.

Warning lights

Refer to your Owner's Manual for countermeasures when each warning light comes on. If necessary, consult your authorized SUBARU dealer.

Seatbelt warning



Remind the driver to fasten seatbelt.

Front passenger's seatbelt warning



Remind the front passenger to fasten seatbelt. Location: next to overhead console.

Malfunction indicator (Check Engine)



Engine/Emission control system malfunction.

Charge warning



Charging system malfunction.

Oil pressure warning



The engine oil pressure is too low.

Engine low oil level warning



The engine oil level decreases to the lower limit.

All-wheel drive warning (CVT models)



Tires of different diameter fitted/air pressure excessively low.

SRS airbag system warning



SRS airbag system and/or seatbelt pretensioners malfunction.

Power steering warning



The electric power steering system malfunction.

AT OIL TEMP warning (CVT models)



Transmission fluid temperature is too hot./Transmission control system malfunction.

Low fuel warning



Fuel tank is nearly empty. Refill fuel immediately.

High beam assist warning



The high beam assist function malfunction.

Brake system warning



Electronic parking brake system malfunction/Brake fluid level/EBD System malfunction (Anti-lock brake system warning light illuminates simultaneously).

Automatic headlight beam leveler warning



Automatic headlight beam leveler malfunction.

Access key warning



The access key is not inside the vehicle. For other situations, refer to your Owner's Manual.

ABS warning



Anti-lock Brake System malfunction/EBD System malfunction.
(Brake System warning light illuminates simultaneously).

Windshield washer fluid warning



The fluid level in the windshield washer fluid tank decreases to the lower limit.

BSD/RCTA warning



Blind Spot Detection/Rear Cross Traffic Alert (BSD/RCTA) malfunction.

Vehicle Dynamics Control warning/Vehicle Dynamics Control operation indicator



Warning : Vehicle Dynamics Control system malfunction.

Indicator : Flashes during activation of the skid suppression function and the traction control function.

Icy road surface warning screen



When the outside temperature becomes 3°C (37°F) or less, the icy road surface warning screen interrupts to inform the driver that the road surface may be frozen.

RAB warning



Reverse Automatic Braking System malfunctions.

Indicator lights

The following indicators show the current status of your car. Refer to your Owner's Manual for more information.

 Turn signal indicator	 Headlight indicator	 High beam indicator
 Front fog light indicator	 Security indicator	 Door open indicator
 BSD/RCTA OFF indicator	 Cruise control indicator	 Cruise control set indicator
 Hill Holder indicator	 Hill descent control indicator	
 Vehicle Dynamics Control OFF indicator	 High beam assist indicator	
 Electronic parking brake indicator	 Front passenger's frontal airbag ON/OFF indicator	
 RAB OFF indicator	 Steering responsive fog lights OFF indicator	
 Lane Departure Warning OFF indicator	 Sonar audible alarm OFF indicator	
 Pre-Collision Braking System OFF indicator		

subaru.ca

All illustrations, specifications, features and photographs contained in this brochure are based on product information available at the time of its printing, and may not be completely accurate following its publication. Colours shown may vary due to reproduction variations in the printing process, and some vehicle parts cannot be shown in certain photographs. Subaru Canada, Inc. reserves the right to discontinue or make changes at any time, without notice or incurring obligations, to colours, materials, equipment, accessories, features, specifications and models, or to change their prices. Please visit our Web site for the latest information and specifications. For detailed operating and safety information, please consult your Owner's Manual. For complete details on product updates, warranties or the Subaru C.A.R.E. program, please contact your Subaru dealer. Legacy and Subaru are registered trademarks. Printed in Canada. © 2016 Subaru Canada, Inc. 2017 model year.



Environmental Management System (EMS)
ISO 14001:2004 certified by SGS
www.subaru-earth.com

SUBARU CANADA, INC. / FUJI HEAVY INDUSTRIES LTD.