

22.Assist Grip

A: REMOVAL

- 1) Remove the screw cover, and remove the screw inside.
- 2) Pull the left side of assist grip, and rotate the right side of it counterclockwise to remove.

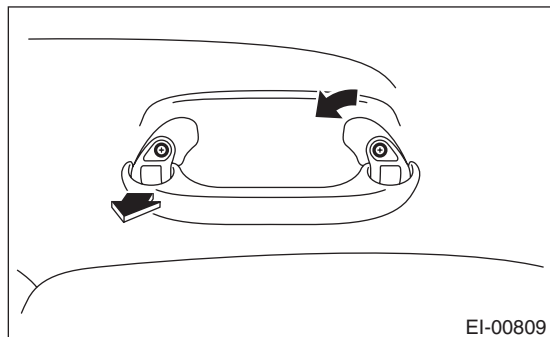

- 3) Remove the roof trim. <Ref. to EI-50, REMOVAL, Roof Trim.>
- 4) Remove the bolts, and remove the assist grip bracket.

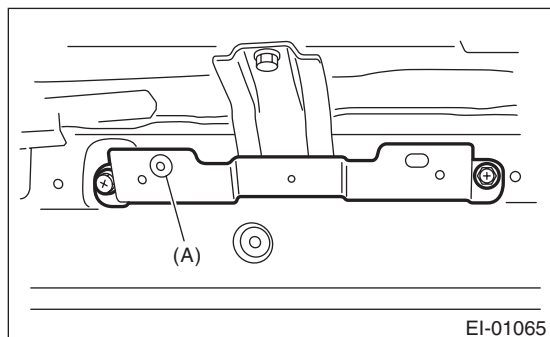

(A) Grommet

B: INSTALLATION

Install in the reverse order of removal.

CAUTION:

Be sure to install the grommet to assist grip bracket.

When the assist grip is installed with no grommet, it will cause the grip to not return properly.