



2001

# VITARA / GRAND VITARA

## OWNER'S MANUAL

Keep With Vehicle At All Times.  
Contains Important Information  
On Safety, Operation & Maintenance.

**SUZUKI**  
*Caring for Customers*

Part No. 99011-65D22-03E  
February, 2001



65D-0X01-A1E

**This owner's manual applies to  
the VITARA/GRAND VITARA series:**

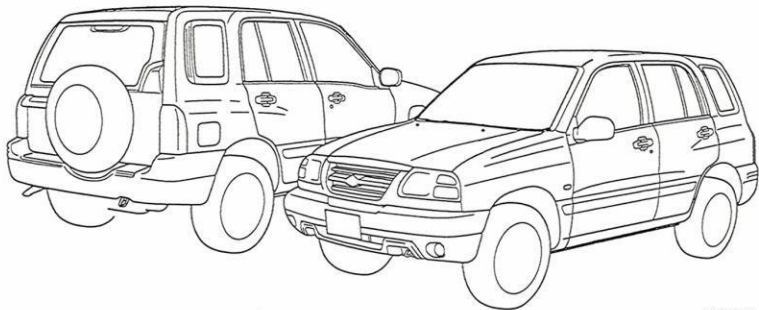

0X-65D226A

*NOTE: The illustrated model is one of the VITARA/GRAND VITARA series.*

# TABLE OF CONTENTS

This manual should be considered a permanent part of the vehicle and should remain with the vehicle when resold or otherwise transferred to a new owner or operator. Please read this manual carefully before operating your new Suzuki and review the manual from time to time. It contains important information on safety, operation, and maintenance.

## California Proposition 65 Warning

### WARNING

Engine exhaust, some of its constituents, and certain product components contain or emit chemicals known to the State of California to cause cancer and birth defects or other reproductive harm.

FUEL RECOMMENDATION	1
BEFORE DRIVING	2
STEERING COLUMN CONTROLS	3
INSTRUMENT PANEL	4
OTHER CONTROLS AND EQUIPMENT	5
OPERATING YOUR VEHICLE	6
DRIVING TIPS	7
VEHICLE LOADING AND TOWING	8
INSPECTION AND MAINTENANCE	9
EMERGENCY SERVICE	10
APPEARANCE CARE	11
GENERAL INFORMATION Including "Reporting Safety Defects"	12
FUSES AND PROTECTED CIRCUITS	13
SPECIFICATIONS	14
INDEX	15

## LOCATION OF WARNING MESSAGES

Read and follow all of the warnings (labels etc.) on your vehicle. Make sure you understand all of them. Keep them on the vehicle. Do not remove the messages for any reason. If a label comes off or the messages become difficult to be read, have it corrected by your SUZUKI dealer.

- ① Air bag warning labels  
(on both sun visors)
- ② Rollover warning label
- ③ Passenger seat belt warning label
- ④ Jacking warning label
- ⑤ Jacking warning label
- ⑥ Fuel filler cap message
- ⑦ Transfer lever warning label
- ⑧ Brake fluid cap message
- ⑨ Engine cooling fan warning label
- ⑩ Radiator cap warning label
- ⑪ Air conditioner warning label
- ⑫ Battery label
- ⑬ Canvas top warning label  
(canvas top model)

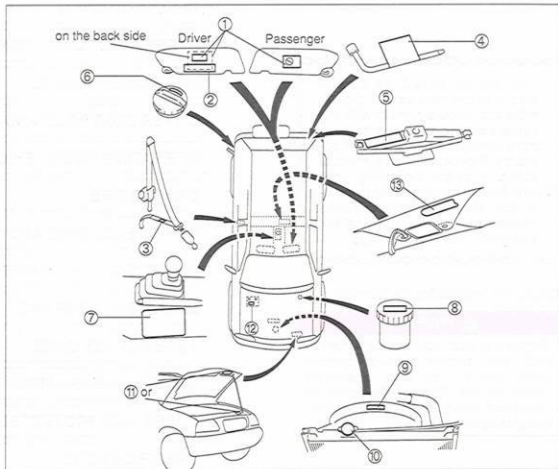

00-65D207A

## FOREWORD

*Your SUZUKI multipurpose vehicle is designed and built to be capable of performing both on pavement and off road.*

*You should therefore remember that your vehicle is distinctly different from ordinary passenger cars in handling as well as in structure. As with other vehicles of this type, failure to operate this vehicle correctly may result in loss of control or an accident. Be sure to read "Important Vehicle Design Features to Know" and the "on-pavement" and "off-road" driving guidelines which follow. It is very important to familiarize yourself with the proper operation of this vehicle before you start driving.*

All information in this manual is based on the latest product information available at the time of publication. Due to improvements or other changes, there may be discrepancies between information in this manual and your vehicle.

SUZUKI MOTOR CORPORATION reserves the right to make production changes at any time, without notice and without incurring any obligation to make the same or similar changes to vehicles previously built or sold.

SUZUKI MOTOR CORPORATION believes in conservation and protection of Earth's natural resources.

To that end, we encourage every vehicle owner to recycle, trade in, or properly dispose of, as appropriate, used motor oil, coolant, and other fluids; batteries; and tires.

**IF YOU HAVE ANY PROBLEMS WITH YOUR SUZUKI:**

*Please review the New Vehicle Warranty Information booklet supplied with your SUZUKI. Should you have a question or problem regarding the warranty or service of your vehicle, please take the following action:*

*Consult the Service Manager and the Owner of the Suzuki Automotive Dealership. Explain your problem and ask for their assistance in resolving your problem. The Owner of the dealership is in the very best position to assist you as he or she is vitally concerned with your continued satisfaction.*

*If you are still in need of additional information, or if you are dissatisfied, request that your dealer arrange a meeting with your District Service Manager.*

*If, after doing so, you still require further assistance, and you purchased your SUZUKI in the continental United States, please contact the American Suzuki Customer Relations Department at 1-800-934-0934 or write:*

American Suzuki Motor Corporation  
Automotive Customer Relations  
3251 East Imperial Highway  
Brea, CA 92821-6722

Please be certain to provide us with the following information: the model, Vehicle Identification Number, mileage, accessories involved, event dates, dealer name, dealer personnel consulted, your problem or question, and any other comments you have. When we receive your correspondence, we will be glad to contact the Owner of your dealership and assist in resolving your concern.

For owners outside the continental United States, please refer to the distributor's address listed in your Warranty Information booklet.

6SD-0004-A0E

## IMPORTANT

### ▲ WARNING/▲ CAUTION/NOTE

Please read this manual and follow its instructions carefully. To emphasize special information, the symbol ▲ and the words **WARNING**, **CAUTION**, and **NOTE** have special meanings. Pay special attention to the messages highlighted by these signal words:

#### ▲ WARNING

Indicates a potential hazard that could result in death or injury.

#### ▲ CAUTION

Indicates a potential hazard that could result in vehicle damage.

### NOTE:

Indicates special information to make maintenance easier or instructions clearer.



00-60A591A

6SD-0005-A0E

## MODIFICATION WARNING

### ▲ WARNING

Do not modify this vehicle. Modification could adversely affect safety, handling, performance, or durability and may violate governmental regulations. In addition, damage or performance problems resulting from modification may not be covered under warranty.

### ▲ CAUTION

Improper installation of mobile communication equipment such as cellular telephones or CB (Citizen's Band) radios may cause electronic interference with your vehicle's ignition system, resulting in vehicle performance problems. Consult your SUZUKI dealer or qualified service technician for advice on installing such mobile communication equipment.

**SUZUKI MOTOR CORPORATION**

65D-0100-A0E

# FUEL RECOMMENDATION

Fuel Recommendation ..... 1-1

65D-0200-A1E

# BEFORE DRIVING

Keys ..... 2-1  
 Spare Tire Nut Lock (if equipped) ..... 2-1  
 Door Locks ..... 2-2  
 Windows ..... 2-6  
 Mirrors ..... 2-8  
 Seat Adjustment ..... 2-9  
 Head Restraints (if equipped) ..... 2-11  
 Seat Belts and Child Restraint Systems ..... 2-12  
 Supplemental Restraint System (Air Bags) ..... 2-23

## FUEL RECOMMENDATION

65D-0101-A0E

## FUEL RECOMMENDATION



02-60A004A

Your vehicle requires regular unleaded gasoline with a minimum rating of 87 pump octane ( $\frac{R+M}{2}$  method). In some areas, the only fuels that are available are oxygenated fuels.

Oxygenated fuels which meet the minimum octane requirement and the requirements described below may be used in your vehicle without jeopardizing the New Vehicle Limited Warranty.

### NOTE:

Oxygenated fuels are fuels which contain oxygen-carrying additives such as MTBE or alcohol.

### Gasoline Containing MTBE

Unleaded gasoline containing MTBE (methyl tertiary butyl ether) may be used in your vehicle if the MTBE content is not greater than 15%. This oxygenated fuel does not contain alcohol.

### Gasoline/Ethanol Blends

Blends of unleaded gasoline and ethanol (grain alcohol), also known as gasohol, may be used in your vehicle if the ethanol content is not greater than 10%.

### Gasoline/Methanol Blends

Fuels containing 5% or less methanol (wood alcohol) may be suitable for use in your vehicle if they contain cosolvents and corrosion inhibitors. Do NOT USE fuels containing more than 5% methanol under any circumstances. Fuel system damage or vehicle performance problems resulting from the use of such fuels are not the responsibility of SUZUKI and may not be covered under the New Vehicle Limited Warranty.

### Fuel Pump Labeling

In some states, pumps that dispense oxygenated fuels are required to be labeled for the type and percentage of oxygenate and whether important additives are present. Such labels may provide enough information for you to determine if a particular blend of fuel meets the requirements listed above. In other areas, pumps may not be clearly labeled as to the content or type of oxygenate and additives. If you are not sure that the fuel you intend to use meets these requirements, check with the service station operator or the fuel supplier.

### NOTE:

To help clean the air, SUZUKI recommends you use the oxygenated fuels. However, if you are not satisfied with the driveability or fuel economy of your vehicle when you are using an oxygenated fuel, switch back to the regular unleaded gasoline.

### **▲ CAUTION**

Be careful not to spill fuel containing alcohol while refueling. Fuels containing alcohol can cause paint damage, which is not covered under the New Vehicle Limited Warranty.



65D-0202-ACE

## KEYS



02-60A007A

Your vehicle comes with a pair of identical keys. Keep the spare key in a safe place. One key can open all of the locks on the vehicle.

The key identification number is stamped on a metal tag provided with the keys. Keep the tag in a safe place. If you lose your keys, you will need this number to have new keys made. Write the number below for your future reference.

KEY NUMBER:

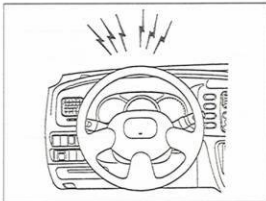

02-65D004A

**Ignition Key Reminder**

A buzzer sounds to remind you to remove the ignition key if it is in the ignition switch when the driver's door is opened.

65D-0211-ACE

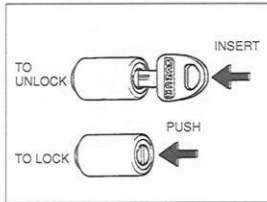
**SPARE TIRE NUT LOCK  
(if equipped)**

02-65D283A

A nut lock is used for the spare tire. Simply insert the ignition key into the lock as far as the key will go and remove the lock with the key in. To lock the spare tire nut, put the lock on the nut and push the lock in.

## BEFORE DRIVING

65D-0203-A3E

### DOOR LOCKS

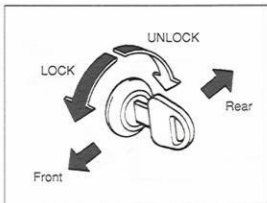

02-60A009A

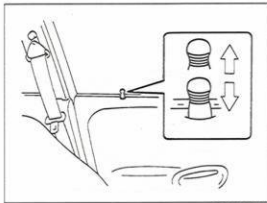

02-60G006A

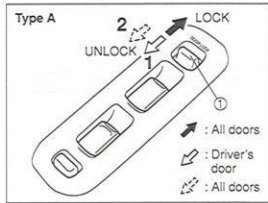

02-65D283A

#### **⚠ WARNING**

Always lock all doors when driving. Locking the doors helps to prevent occupants from being thrown from the vehicle in the event of an accident. It also helps prevent unintended opening of the doors.

#### Side Door Locks

To lock a front door from outside the vehicle:

- Insert the key and turn the top of the key toward the front of the vehicle, or
- For 2.5ℓ model:  
Push in the lock knob and hold the door handle up as you close the door.  
For 1.6ℓ/2.0ℓ models:  
Push the lock knob down and close the door.

To unlock a front door from outside the vehicle, insert the key and turn the top of the key toward the rear of the vehicle.

To lock a door from inside the vehicle, push down the lock knob. Pull up the lock knob to unlock the door.

#### ● For 4-DOOR MODEL

To lock a rear side door from outside the vehicle, push in the lock knob and close the door. You do not need to hold the door handle up as you close the door.

#### Power Door Locking System (if equipped)

The power door locking switch is located on the driver's side door panel.

You can lock and/or unlock driver's door and all other doors (except Canvas top model rear gate) by:

- Turning the key in a door lock, or
  - Pushing the central door locking switch ①.
- To lock all doors (except Canvas top rear gate) simultaneously, push the switch ① to "LOCK" as shown in the illustration or turn the key in one of the door locks to the LOCK side.

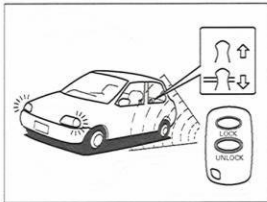
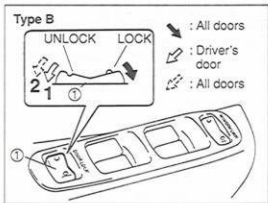

- To unlock the driver's door only, push the switch ① to "UNLOCK" as shown in the illustration or turn the key in the driver's door to the UNLOCK side.
- To unlock all other doors (except Canvas top model rear gate), repeat above UNLOCK operation (by the switch ① or by the key) once again within a short time.

**NOTE:**

For Vitara without the keyless entry system, two stage unlocking is unavailable:

- \* All doors are unlocked by operating the switch ① one time and
- \* only the driver's door can be unlocked by using the key in the driver's door lock.
- Unlocking by using the key in a door lock other than driver's door will unlock that door only.

**Keyless Entry System (if equipped)**

You can lock or unlock all doors (except Canvas top model rear gate) simultaneously by operating the transmitter near the vehicle.

- Push the "LOCK" button on the transmitter to lock the doors.
- Push the "UNLOCK" button on the transmitter to unlock the driver's door.
- Push the "UNLOCK" button one more time, within a short time, to unlock other doors.

The turn signal lights will flash once when the doors are locked.

The turn signal lights will flash twice when the door(s) is (are) unlocked.

Be sure the doors are locked after you operate the "LOCK" button. If no door is opened within about 30 seconds after the "UNLOCK" button is operated, the doors will automatically lock again.

**NOTE:**

- \* The maximum operating distance is about 5m (16ft.), but this can vary depending on the surroundings, especially near other transmitting devices such as radio towers or CB (Citizen's Band) radios.
- \* The door locks can not be operated with the transmitter:
  - if the ignition key is in the "ON" or "START" position, or
  - if any door is open or incompletely closed.
- \* If you lose your transmitter, ask your Suzuki dealer as soon as possible for a replacement and to have the lost one deactivated.

**⚠ CAUTION**

The transmitter is a sensitive electronic instrument. To avoid damaging the transmitter, do not expose it to impacts, moisture, or high temperature (such as on the dashboard under direct sunlight).

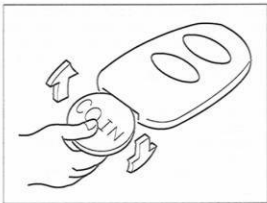

02-60G355A

**Replacement of the transmitter battery**  
If the transmitter becomes unreliable, replace the battery.

- 1) Put the edge of a coin or a flat blade screw driver in the slot of the transmitter and pry it open.
- 2) Replace the battery (specified in the illustration) so its  $\ominus$  terminal faces the "+" mark of the transmitter.
- 3) Close the transmitter firmly.
- 4) Make sure the door locks can be operated with the transmitter.
- 5) Dispose of the used battery properly according to applicable rules or regulations. Do not dispose of lithium batteries with ordinary household trash.

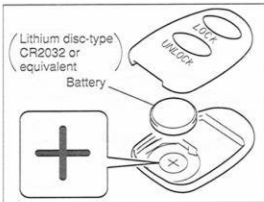

02-60G356A

#### **⚠ WARNING**

Swallowing a lithium battery may cause serious internal injury. Do not allow anyone to swallow a lithium battery. Keep lithium batteries away from children and pets. If swallowed, contact physician immediately.

#### **⚠ CAUTION**

The transmitter is a sensitive electronic instrument. To avoid damaging the transmitter, do not expose it to dust or moisture or tamper with internal parts.

**For vehicles sold in U.S.A.:**

**FCC ID: MOZ D01TB MADE IN JAPAN**

This device complies with Part 15 of the FCC Rules. Operation is subject to the following two conditions:

- 1) this device may not cause harmful interference, and
- 2) this device must accept any interference received, including interference that may cause undesired operation.

**FCC ID: MOZ D01RB MADE IN JAPAN**

This device complies with Part 15 of the FCC Rules. Operation is subject to the following two conditions:

- 1) this device may not cause harmful interference, and
- 2) this device must accept any interference received, including interference that may cause undesired operation.

**NOTE:**

*Changes or modifications not expressly approved by the party responsible for compliance could void the user's authority to operate the equipment.*

**For vehicles sold in Canada:**

This device complies with RSS-210 of Industry Canada. Operation is subject to the following two conditions:

- 1) this device may not cause interference, and
- 2) this device must accept any interference, including interference that may cause undesired operation of the device.

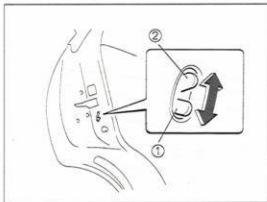

02-60G008A

**Child Lock System (4-door models)**

Each of the rear doors is equipped with a child lock which can be used to help prevent unwanted opening of the door from inside the vehicle. When the lock lever is in the "LOCK" position ①, the rear door can only be opened from outside. When the lock lever is in the "RELEASE" position ②, the rear door can be opened from inside or outside.



02-65D001A

**Rear Door Lock/Tail Gate Lock (if equipped)**

To lock the rear door or the tail gate, insert the key and turn it clockwise. To unlock the door, turn the key counterclockwise.

## BEFORE DRIVING

6SD-0204-AGE

### WINDOWS

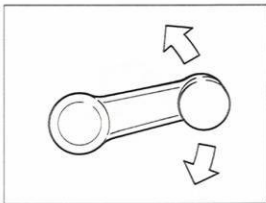

02-60G010A

#### Manual Window Control (if equipped)

Raise or lower the door windows by turning the hand crank located on the door panel.

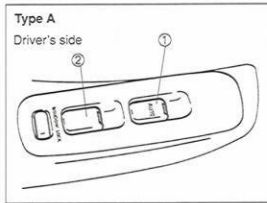

02-60G011A

#### Power Window Controls (if equipped)

The driver's door has a switch to operate the driver's window ①, and a switch to operate the front passenger's window ②. In 4-door models, there are switches ④, ⑤, to operate the rear left and right passenger windows, respectively.

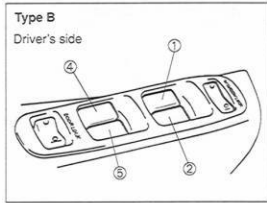

02-60G012A

The passenger's door only has a switch to operate the passenger's window ③. The power windows can only be operated when the ignition switch is in the "ON" position.

To open a window, push the top part of the switch and to close a window lift up the top part of the switch.

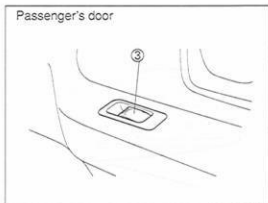

02-65D002A

The driver's window has an auto-down feature for added convenience (at toll booths or drive-through restaurants, for example). This means you can open the window without holding the window switch in the "Down" position. Press the driver's window switch completely down and release it. To stop the window before it reaches the bottom, pull the switch up briefly.

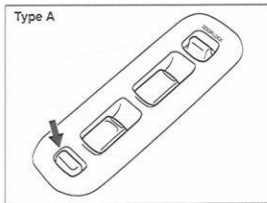

02-65D295A

The driver's door also has a lock switch for the passenger's window(s). When you push in the lock switch or the lock side of the switch, the passenger's window(s) can not be raised or lowered by operating either of the switches ② or ③, and ④ or ⑤ in 4-door models. To restore normal operation, release the lock switch by pushing it in again or by pushing the unlock side of the switch.

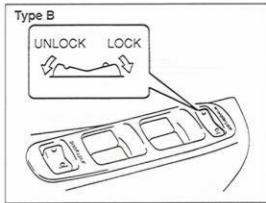

02-60G014A

**⚠ WARNING**

You should always lock the passenger's window operation when there are children in the vehicle. Children can be seriously injured if they get part of their body caught by the window during operation.

## BEFORE DRIVING

65D-0205-AGE

### MIRRORS

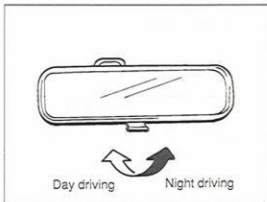

02-50G010A

#### Day-Night Rearview Mirror (if equipped)

To adjust the inside rearview mirror, set the selector tab to the day position, then move the mirror up, down, or sideways to obtain the best view.

When driving at night, you can move the selector tab to the night position to reduce glare from the headlights of vehicles behind you.

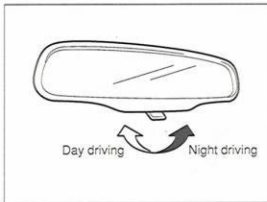

02-65D277A

#### **⚠ WARNING**

- \* Always adjust the mirror with the selector set to the day position.
- \* Only use the night position if it is necessary to reduce glare from the headlights of vehicles behind you. Be aware that in this position you may not be able to see some objects that could be seen in the day position.

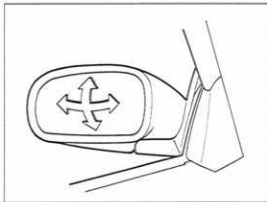

02-60G016A

#### Outside Rearview Mirrors

Adjust the outside rearview mirrors so you can just see the side of your vehicle in the mirrors.

The passenger's side mirror is a convex (curved surface) mirror. Objects seen in this mirror will look smaller and appear farther away than when seen in a flat mirror.

#### **⚠ WARNING**

Be careful when judging the size or distance of a vehicle or other object seen in the side convex mirror. Be aware that objects look smaller and appear farther away than when seen in a flat mirror.



65D-0212-AGE

## SEAT ADJUSTMENT

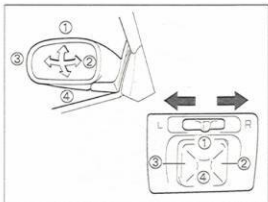

02-60G016A

02-60G334A

**Power Mirror Control (if equipped)**

The switch to control the power rearview mirrors is located on the instrument panel. You can only adjust the mirrors when the ignition switch is in the "ON" position. To adjust the mirrors:

- 1) Move the selector switch to the left or right to select the mirror you wish to adjust.
- 2) Press the outer part of the switch that corresponds to the direction you wish to move the mirror.
- 3) Return the selector switch to the center position to help prevent unintended adjustment.

**⚠ WARNING**

Never attempt to adjust the driver's seat or seatback while driving. The seat or seatback could move unexpectedly, causing loss of control. Make sure that the driver's seat and seatback are properly adjusted before you start driving.

**⚠ WARNING**

To avoid excessive seat belt slack, which reduces the effectiveness of the seat belts as a safety device, make sure that the seats are adjusted before the seat belts are fastened.



02-65D005A

**Adjusting Seat Position**

The adjustment lever for each front seat is located under the front of the seat. To adjust the seat position, pull up on the adjustment lever and slide the seat forward or rearward. After adjustment, try to move the seat forward and rearward to ensure that it is securely latched.



02-65D006A

### Adjusting Seatbacks

The front and rear seatbacks can be adjusted to different angles. To adjust the seatback angle of front seats, pull up the lever on the outboard side of the seat, move the seatback to the desired position, and release the lever to lock the seatback in place. After adjustment, try moving the seatback to make sure it is securely locked.

To adjust the seatback angle of the rear seats:

- Pull up the knob on the top of a split folding seat.

### EXAMPLE

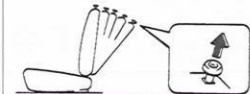

02-65D055A

- Move the seatback to one of the lock positions. The number of the lock positions depends on the vehicle specification.
- Release the knob to lock the seatback in position. After adjustment, try moving the seatback to make sure it is securely locked.

### **⚠ WARNING**

All seatbacks should always be in a fairly upright position when driving, or seat belt effectiveness may be reduced. Seat belts are designed to offer maximum protection when seatbacks are in the fully upright position.



02-65D007A

### Walk-In Type Seats (if equipped)

The walk-in type seat can be moved to provide easy entry to and exit from the rear seats. You can move a walk-in seat from outside the vehicle by pulling up the lever on the outboard side of the seat. You can move the front passenger's seat from inside the vehicle by depressing the pedal on the rear of the seat.

65D-0213-A0E

## HEAD RESTRAINTS (if equipped)



02-65D008A

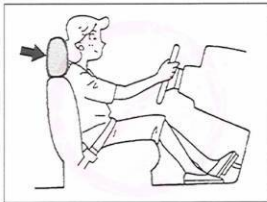

02-75F012A

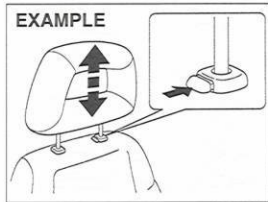

02-81A017A

**⚠ WARNING**

- \* After using the walk-in function, be sure to return the folded seat back to an upright position.
- \* Before returning a walk-in seat to its normal seating position, make sure that the feet of the passenger in the rear seat are out of the way.
- \* After returning the seat to its normal seating position, make sure it is securely latched.

Head restraints are designed to help reduce the risk of neck injuries in case of an accident.

Adjust the head restraint to the position which places the top of the head restraint closest to the top of your ears.

**⚠ WARNING**

- \* Never drive the vehicle with the head restraints removed.
- \* Do not attempt to adjust the head restraint while driving.

To raise the head restraint, pull upward on the restraint until it clicks. To lower the restraint, push down on the restraint while holding in the release knob. If a head restraint must be removed (for cleaning, replacement, etc.), push in the release knob and pull the head restraint all the way out.

**NOTE:**

*It may be necessary to recline the seatback to provide enough overhead clearance to remove the head restraint.*

## BEFORE DRIVING

6SD-0209-AZE

### SEAT BELTS AND CHILD RESTRAINT SYSTEMS



07-6SD231A



02-6SD200A

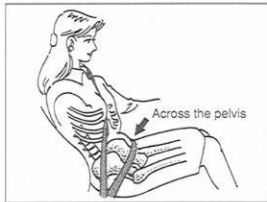

02-6SD201A

#### **⚠ WARNING**

An air bag supplements, or adds to, the frontal crash protection offered by seat belts. The driver and all passengers must be properly restrained by wearing seat belts at all times, whether or not an air bag is mounted at their seating position, to minimize the risk of severe injury or death in the event of a crash.

#### **⚠ WARNING**

- \* Never allow persons to ride in the cargo area of a vehicle. In the event of an accident, there is a much greater risk of injury for persons who are not riding in a seat with their seat belt securely fastened.
- \* Seat belts should always be adjusted so the lap portion of the belt is worn low across the pelvis, not across the waist. Shoulder straps should be worn on the outside shoulder only, and never under the arm. Seat belts should never be worn with the straps twisted and should be adjusted as tightly as is

(Continued)

(Continued)

comfortable to provide the protection for which they have been designed. A slack belt will provide less protection than one which is snug.

- \* Make sure that each seat belt buckle is inserted into the proper buckle catch. It is possible to cross the buckles in the rear seat.
- \* Do not wear your seat belt over hard or breakable objects in your pockets or on your clothing. If an accident occurs, objects such as glasses, pens, etc. under the seat belt can cause injury.

(Continued)

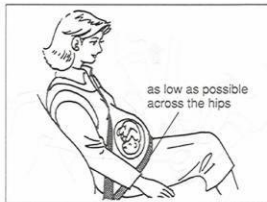

02-65D199A

**WARNING**

(Continued)

- \* Never use the same seat belt on more than one occupant and never attach a seat belt over an infant or child being held on an occupant's lap. Such seat belt use could cause serious injury in the event of an accident.
- \* Pregnant women should use seat belts, although specific recommendations about driving should be made by the woman's medical advisor. Remember that the lap portion of the belt should be worn as low as possible across the hips,

(Continued)

(Continued)

as shown in the diagram.

- \* Periodically inspect seat belt assemblies for excessive wear and damage. Seat belts should be replaced if webbing becomes frayed, contaminated, or damaged in any way. It is essential to replace the entire seat belt assembly after it has been worn in a severe impact, even if damage to the assembly is not obvious.
- \* Children age 12 and under should ride properly restrained in the rear seat, if equipped.
- \* Infants and small children should never be transported unless they are properly restrained. Restraint systems for infants and small children can be purchased commercially and should be used. Make sure that the system you purchase meets Federal Motor Vehicle Safety Standards. Read and follow all the directions provided by the manufacturer.
- \* Avoid contamination of seat belt webbing by polishes, oils, chemicals, and particularly battery acid. Cleaning may safely be carried out

(Continued)

(Continued)

- using mild soap and water.
- \* For children, if the shoulder belt irritates the neck or face, move the child closer to the center of the vehicle.
- \* All seatbacks should always be in a fairly upright position when driving, or seat belt effectiveness may be reduced. Seat belts are designed to offer maximum protection when seatbacks are in the fully upright position.

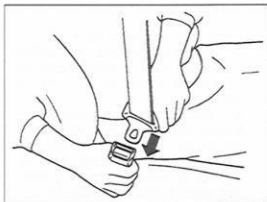

02-60A036A

Your vehicle is equipped with a lap-shoulder belt at each outboard seating position and a lap belt at the rear center seating position (if available).

### Front and Rear Lap-Shoulder Belts

Pull the buckle tongue attached to the seat belt across your body and press it into the buckle catch until you hear a "click". The buckle catch is located at the inboard side of the seat. To reduce the risk of sliding under the belt during a collision, position the lap portion of the belt across your lap as low on your hips as possible and adjust it to a snug fit by pulling the shoulder portion of the belt upward through the latch plate.



02-60A038A

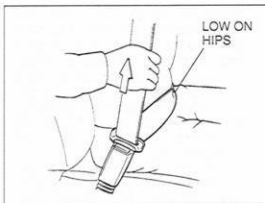

02-60A040A

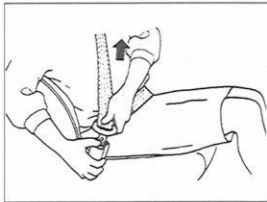

02-60A039A

The length of the diagonal shoulder strap adjusts itself to allow freedom of movement. The seat belt has an emergency locking retractor (ELR), which is designed to lock the seat belt only during a sudden stop or impact. To unfasten the belt, press the release button on the buckle catch.

### NOTE:

*The front passenger's seat belt and the rear seat belts have emergency locking retractors (ELRs) that can be temporarily converted to function as automatic locking retractors (ALRs). The ALR mode should be used if you need to secure a child restraint system in the seat. Refer to the "CHILD RESTRAINT" section for details.*

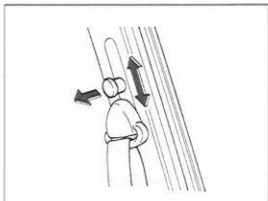

02-60G026A

### Shoulder anchor height adjuster (if equipped)

Adjust the shoulder anchor height so that the shoulder belt rides on the center of the outboard shoulder. To adjust the shoulder anchor height, slide the anchor up or down while pulling the lock knob out. After adjustment, make sure that the anchor is securely locked.



02-60B038A

### Lap belt

Sit up straight and well back in the seat. Pull the buckle tongue attached to the seat belt across your hips and press it into the buckle catch until you hear a "click". The buckle catch is located at the left side of the seating position. To reduce the risk of sliding under the belt during a collision, position the belt across your lap as low on your hips as possible and adjust it to a snug fit.

To tighten the belt, pull the free end of the belt across alongside the lap strap.

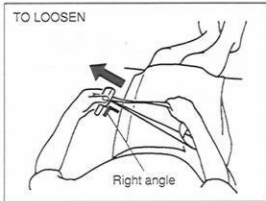

02-60A046A

To lengthen, release the tongue from the buckle catch, pull the tongue (adjuster) in the direction of the arrow, at right angles to the belt. The tongue should then be refitted into the buckle catch and the belt tightened as previously described.

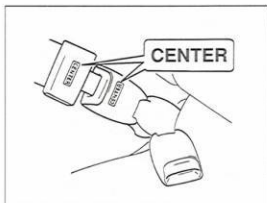

02-60G028A

**NOTE:**

At the left side of the rear center seating position, there are two buckle catches, one for the center lap belt and one for the left lap-shoulder belt.

To identify them, "CENTER" is molded on the buckle catch for the center lap belt. The buckle catches are designed so a buckle tongue can not be inserted into the wrong buckle catch.

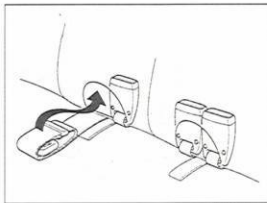

02-65D016A

Stow the rear seat belt buckle catches and the center seat belt webbing in the seat back as illustrated when the seatback is folded.

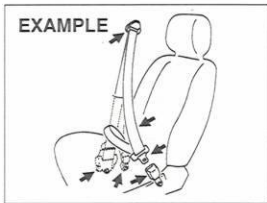

02-65D209A

**Seat Belt Inspection**

Periodically inspect the seat belts to make sure they work properly and are not damaged. Check the webbing, buckles, latch plates, retractors, anchorages, and guide loops. Replace any seat belts which do not work properly or are damaged.



**WARNING**

Be sure to inspect all seat belt assemblies after any collision. Any seat belt assembly which was in use during a collision (other than a very minor one) should be replaced, even if damage to the assembly is not obvious. Any seat belt assembly which was not in use during a collision should be replaced if it does not function properly or is damaged in any way.

**Child Restraint Systems**

02-60G332A

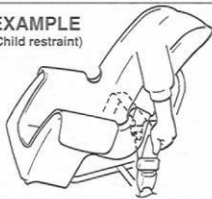
**EXAMPLE****(Child restraint)**

02-65D197A

**EXAMPLE****(Infant restraint  
– rear seat only)**

02-65D202A

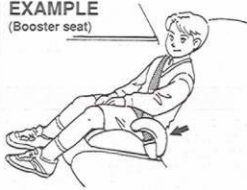
**EXAMPLE****(Booster seat)**

02-65D203A

### Child Restraint Systems

SUZUKI highly recommends that you use a child restraint system to restrain infants and small children. Many different types of child restraint systems are available; make sure that the restraint system you select meets Federal Motor Vehicle Safety Standards.

All child restraint systems are designed to be secured in vehicle seats by lap belts or the lap portion of lap-shoulder belts. Whenever possible, SUZUKI recommends that child restraint systems be installed on the rear seat. According to accident statistics, children are safer when properly restrained in rear seating positions than in front seating positions.

If you must use a front-facing child restraint in the front passenger's seat, be sure to move the front passenger's seat as far back as possible.

#### WARNING

Do not install a rear-facing child restraint in the front passenger's seat. If the passenger's air bag inflates, a child in a rear-facing child restraint could be seriously injured. The back of a rear-facing child restraint would be too close to the inflating air bag.



02-60A582A



02-60A583A

#### WARNING

Children could be endangered in a crash if their child restraints are not properly secured in the vehicle. When installing a child restraint system, be sure to follow the instructions below. Be sure to secure the child in the restraint system according to the manufacturer's instructions.



02-60A577A

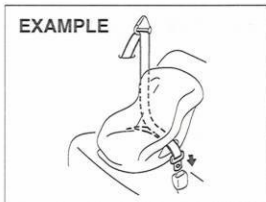

**Installation with lap-shoulder seat belts  
(Child restraint with no Top Strap)**

Install your child restraint system according to the instructions provided by the child restraint system manufacturer. If you install the child restraint system in the front seat, be sure to slide the seat to the rearmost position. After making sure that the seat belt is securely latched:

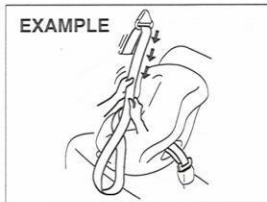

1) Pull all of the remaining webbing out of the retractor. You will hear a click, which means that the emergency locking retractor (ELR) has converted to function as an automatic locking retractor (ALR).

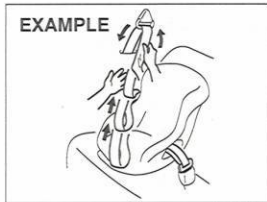

2) Allow the extra webbing to retract, and pull the webbing toward the retractor to take up any slack. Make sure that the lap portion of the belt is tight around the child restraint system and the shoulder portion of the belt is positioned so that it can not interfere with the child's head or neck.

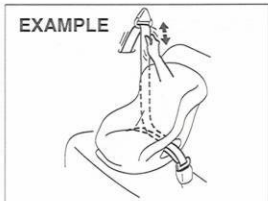

- 3) Make sure that the retractor has converted to the ALR mode by trying to pull webbing out of the retractor. If the retractor is in the ALR mode, the belt will be locked.

**⚠ WARNING**

If the retractor is not in the ALR mode, the child restraint system can move or tip over when your vehicle turns or stops abruptly.

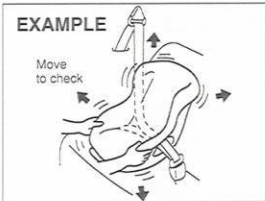

- 4) Try moving the child restraint system in all directions, to make sure it is securely installed. If you need to tighten the belt, pull more webbing toward the retractor.

When you unbuckle the seat belt and allow it to retract to a certain length, the retractor will automatically revert back to the normal ELR mode.

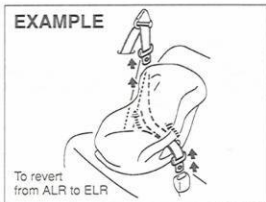
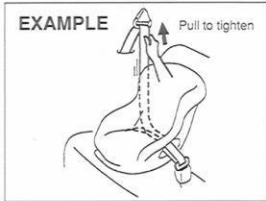

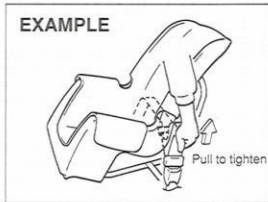

#### Installation with a lap belt (Child restraint with no Top Strap)

Install your child restraint system according to the instructions provided by the child restraint system manufacturer.

To lengthen or tighten the belt, refer to the "Lap belt" item in this "SEAT BELTS AND CHILD RESTRAINT SYSTEMS" section. After making sure that the seat belt is securely latched, try moving the child restraint system in all directions, to make sure it is securely installed. If you need to tighten the belt, pull the free end of the webbing.

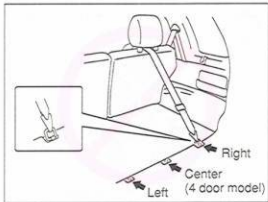

#### Installation-Child Restraint with Top Strap

Some child restraint systems require the use of a top strap. Top strap anchor brackets are located on either side (and at the center (for 4 door model)) of the rear of the luggage compartment. Install the child restraint system as follows:

- 1) Remove the luggage compartment cover (if equipped).
- 2) Secure the child restraint on the rear seat using the procedure described above for securing a restraint system that does not require a top strap.
- 3) Lift up the anchor bracket. Hook the top strap to the anchor bracket and tighten the top strap according to the instructions provided by the child restraint system

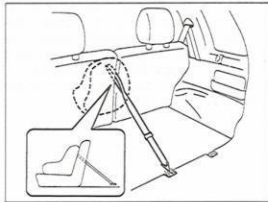

manufacturer. Be sure to attach the top strap to the corresponding anchor located directly behind the child restraint. Do not attach the top strap to the luggage restraint loops (if equipped).

#### **⚠ WARNING**

**Do not attach the child restraint top strap to the luggage restraint loops (if equipped). Incorrectly attached top strap will reduce the intended effectiveness of the child restraint system.**

- 4) When routing the top strap at an outboard seating position, be sure to pass it between the head restraint and the rear seatback as shown.

- When routing the top strap at the center seating position, be sure to pass it between the rear seatbacks as shown, if the top strap connection to the child restraint is below the top of the rear seatback.
- Make sure that cargo does not interfere with routing of the top strap.

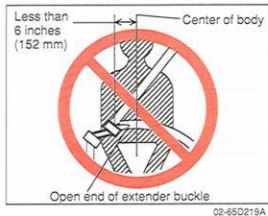

### Seat Belt Extender

If a front seat belt cannot be fastened securely because it is not long enough, see your authorized SUZUKI dealer for a seat belt extender. After inspecting the relationship between the seat belt length, the occupant's body size, and the seat adjustment (the driver's seat should always be adjusted as far back as possible while still maintaining control of the vehicle, and the passenger seat should be adjusted as far back as possible), he can select the appropriate seat belt extender for either the driver or passenger seat.

- A seat belt extender should only be used for the person, vehicle, and seating location it was provided for.
- When using the extender, ensure that both ends are latched securely. Do not use the extender if the open end of the extender's buckle is within 6 inches of the center of the occupant's body (See diagram). Use of the extender when the buckle is too close to the center of the body could increase the risk of abdominal injury in the event of an accident, and could cause the shoulder belt to be positioned incorrectly.
- Seat belt extenders are not intended for use by pregnant women, and should only be used upon approval by their medical advisors.
- Remove and stow the extender when it is not being used.

65D-0210-A0E

**SUPPLEMENTAL RESTRAINT  
SYSTEM (Air Bags)****⚠ WARNING**

Failure to follow these instructions may increase the risk of injury in a crash.

- \* Only use an extender for the person, vehicle, and seating position it was provided for.
- \* Do not use if open end of extender's buckle is within 6 inches of center of occupant's body (See diagram).

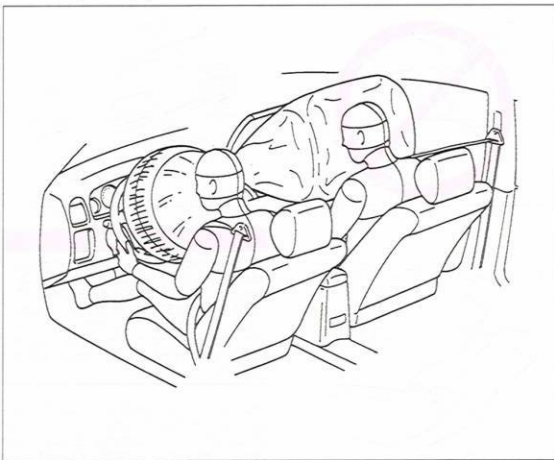

02-60A047A



02-60A585A

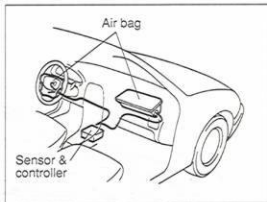

02-65D168A

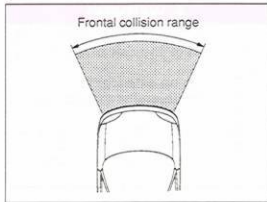

02-50G032A



02-60A038A

**⚠ WARNING**

This section of the owner's manual describes the protection provided by your SUZUKI's SUPPLEMENTAL RESTRAINT SYSTEM (Air Bags). Please read and follow ALL these instructions carefully to minimize your risk of severe injury or death in the event of a collision.

Your vehicle is equipped with a Supplemental Restraint System consisting of a driver air bag and a front passenger air bag, crash sensors, an electronic controller, and air bag inflators, in addition to a lap/shoulder belt at each front seating position.

**⚠ WARNING**

An air bag supplements, or adds to, the frontal crash protection offered by seat belts. The driver and all passengers must be properly restrained by wearing seat belts at all times, whether or not an air bag is mounted at their seating position, to minimize the risk of severe injury or death in the event of a crash.



# AIR BAG

02-50G212A

Air bags are designed to inflate only in severe frontal collisions. They are not designed to inflate in rear impacts, side impacts, rollovers, or minor frontal collisions, since they would offer no protection in those types of accidents. Also, since an air bag deploys only one time during an accident, seat belts are needed to restrain occupants from further movements during the accident.

Therefore, an airbag is NOT a substitute for seat belts. To maximize your protection, ALWAYS WEAR YOUR SEAT BELTS. Be aware that no system can prevent all possible injuries that may occur in an accident.

If the "AIR BAG" light on the instrument cluster does not blink when the ignition switch is first turned to the "ON" position, or the "AIR BAG" light stays on, or comes on while driving, the air bag system may not work properly. Have the air bag system inspected by an authorized SUZUKI dealer as soon as possible.



02-60A582A

## WARNING

**Do not install a rear-facing child restraint in the front passenger's seat. If the passenger's air bag inflates, a child in a rear-facing child restraint could be severely injured. The back of a rear-facing child restraint would be too close to the inflating air bag.**

If you must use a front-facing child restraint in the front passenger's seat, be sure to move the front passenger's seat as far back as possible. Please refer to the "SEAT BELTS AND CHILD RESTRAINT SYSTEMS" section in the "BEFORE DRIVING" section for details on securing your child.

### How the System Works.

In a frontal collision, the crash sensors will detect rapid deceleration and send a signal to the controller. If the controller judges that the deceleration represents a severe frontal crash, the controller will trigger the inflators. The inflators inflate the air bags with nitrogen or argon gas. The inflated air bags provide a cushion for your head and upper body. The air bag inflates and deflates so quickly that you may not even realize that it has activated. The air bag will neither hinder your view nor make it harder to exit the vehicle.

Airbags must inflate quickly and forcefully in order to reduce the chance of serious or fatal injuries. However, an unavoidable consequence of the quick inflation is that the air bag may irritate bare skin, such as the facial area. Also, upon inflation, a loud noise will occur and some powder and smoke will be released. These conditions are not harmful and do not indicate a fire in the car. Be aware, however, that some air bag components may be hot for a while after inflation.

A seat belt helps keep you in the proper position for maximum protection when an airbag inflates. Adjust your seat as far back as possible while still maintaining control of the vehicle. Sit fully back in your seat; sit up straight; do not lean over the steering wheel

or dashboard. Please refer to the "FRONT SEAT ADJUSTMENT" section and the "SEAT BELTS AND CHILD RESTRAINT SYSTEMS" section in the "BEFORE DRIVING" section for details on proper seat and seat belt adjustments.

### **▲ WARNING**

Do not attach any objects to, or place any objects over, the steering wheel or dashboard. Do not place any objects between the air bag and the driver or front passenger. These objects may interfere with air bag operation or may be propelled by the air bag in the event of a crash. Either of these conditions may cause severe injury.

Note that even though your vehicle may be moderately damaged in a frontal collision, the collision may not have been severe enough to trigger the air bags to inflate. If your car sustains ANY front-end damage, have the air bag system inspected by an authorized SUZUKI dealer to ensure it is in proper working order.

Your vehicle is equipped with a diagnostic module which records information about the air bag system if the air bags deploy in a crash. The module records information about overall system status, which sensors

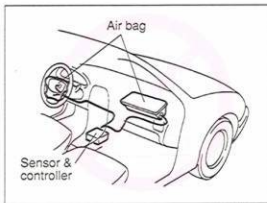

02-65D168A

activated the deployment, and whether the driver's seat belt was in use.

### **Servicing the Air Bag System.**

If the air bags inflate, have the air bags and related components replaced by an authorized SUZUKI dealer as soon as possible.

If your vehicle ever gets in deep water and the driver's floor is submerged, the air bag controller could be damaged. If it does, have the air bag system inspected by the SUZUKI dealer as soon as possible.

Special procedures are required for servicing or replacing an air bag. For that reason, only an authorized SUZUKI dealer should be allowed to service or replace your air

bags. Please remind anyone who services your SUZUKI that it has air bags.

Service on or around air bag components or wiring must be performed only by an authorized SUZUKI dealer. Improper service could result in unintended air bag deployment or could render the air bag inoperative. Either of these two conditions may result in severe injury.

To prevent damage or unintended inflation of the air bag system, be sure the battery is disconnected and the ignition switch has been in the "LOCK" position for at least 90 seconds before performing any electrical service work on your SUZUKI. Do not touch air bag system components or wires. The wires are wrapped with yellow tape or yellow tubing, and the couplers are yellow for easy identification.

Scrapping a car that has an uninflated air bag can be hazardous. Ask your dealer, body repair shop, or scrap yard for help with disposal.

# STEERING COLUMN CONTROLS

Ignition Switch .....	3-1
Lighting/Turn Signal Control Lever .....	3-3
Windshield wiper and washer lever .....	3-6
Tilt Steering Lock Lever (if equipped) .....	3-7
Cruise Control (if equipped) .....	3-8
Horn .....	3-9

65D-0301-AZE

### IGNITION SWITCH



03-70G142A

#### **⚠ WARNING**

To avoid possible injury, do not operate controls by reaching through the steering wheel.

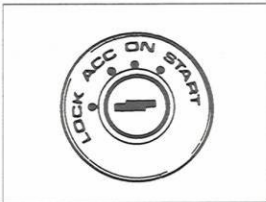

03-60A054A

The ignition switch has the following four positions:

#### **LOCK**

This is the normal parking position. It is the only position in which the key can be removed.

#### MANUAL TRANSMISSION



03-60A055A

#### **Manual Transmission Vehicles**

You must push in the key to turn it to the "LOCK" position. It locks the ignition, and prevents normal use of the steering wheel after the key is removed.

#### **Automatic Transmission Vehicles**

The shift lever must be in the "P" (Park) position to turn the key to the "LOCK" position. It locks the ignition and prevents normal use of the steering wheel and shift lever.

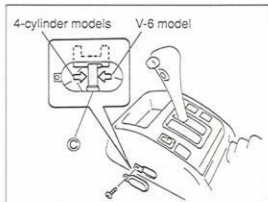

16-65D058A

If the shift lever can not be shifted out of Park in the normal way, pushing the release cam © forward (for V-6 model) or rearward (for 4-cyl. models) with the key in the "ON" or "ACC" position will permit movement of the shift lever out of "P". (see "Emergency Shifting out of "P" (Park)" of "USING THE TRANSMISSION" in "OPERATING YOUR VEHICLE" section.). The shift lever can be moved back to "P" without pushing the release cam ©.

To release the steering lock, insert the key and turn it clockwise to one of the other positions. If you have trouble turning the key to unlock the steering, try turning the steering wheel slightly to the right or left while turning

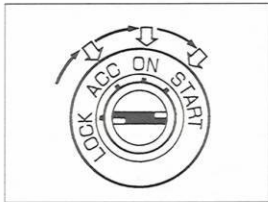

03-60A300A

the key.

#### ACC

Accessories such as the radio can operate, but the engine is off.

#### ON

This is the normal operating position. All electrical systems are on.

#### START

This is the position for starting the engine using the starter motor. The key should be released from this position as soon as the engine starts.

#### ⚠ WARNING

- \* For manual transmission vehicles, never remove the ignition key while the vehicle is moving. The steering wheel will lock and you will not be able to steer the vehicle.
- \* Do not leave children or pets alone in a parked vehicle, and always remove the keys. Unattended children could cause accidental movement of the vehicle or could tamper with power windows. Children or pets could suffer from heatstroke in warm or hot weather, which could result in severe injury or even death.

#### ⚠ CAUTION

- \* Do not turn the starter motor for more than 15 seconds at a time. If the engine does not start, wait 15 seconds before trying again. If the engine does not start after several attempts, check the fuel and ignition systems or consult your SUZUKI dealer.
- \* Do not leave the ignition switch in the "ON" position if the engine is not running or the battery will discharge.

## STEERING COLUMN CONTROLS

65D-0302-A2E

### LIGHTING/TURN SIGNAL CONTROL LEVER

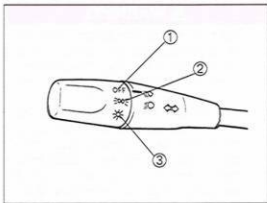

03-60G034A

Your vehicle's lighting system is controlled by three main systems: the Lighting switch, the Auto-On Headlight System, and the Daytime Running Light (D.R.L.) system.

The three systems work together to operate your lights as shown in the following chart:

H/L : Head lights    E/G : Engine  
 IG : Ignition switch    ☼ : Lights ON  
 LIGHT : When it is light around the light sensor (A).  
 DARK : When it is dark around the light sensor (A).



03-65D166A

Lighting switch position	Main lights to be operated	IG OFF		IG ON			
		E/G OFF		E/G OFF		E/G RUNNING	
		LIGHT	DARK	LIGHT	DARK	LIGHT	DARK
① OFF	D.R.L.	—	—	—	—	☼	—
	Parking lights	—	—	—	☼	—	☼
	H/L, Tail lights	—	—	—	☼	—	☼
② Middle	D.R.L.	—	—	—	—	☼	—
	Parking lights	☼	☼	☼	☼	☼	☼
	H/L, Tail lights	—	—	—	☼	—	☼
③ Third	D.R.L.	—	—	—	—	—	—
	Parking lights	☼	☼	☼	☼	☼	☼
	H/L, Tail lights	☼	☼	☼	☼	☼	☼

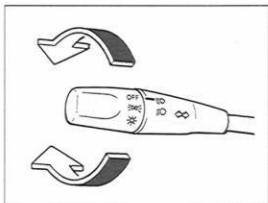

03-60G034A

### Lighting Operation

This control lever is located on the outboard side of the steering column. Operate the lever as described below.

To turn the lights on or off, twist the knob on the end of the lever. There are three positions: in the "OFF" position all lights are off; in the middle position the front parking lights, tail-lights, license plate light, and instrument lights are on, but the headlights are off; in the third position the headlights come on in addition to the other lights.

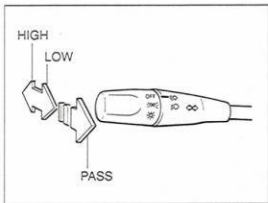

03-60G035A

With the headlights on, push the lever forward to switch to the high beams or pull the lever toward you to switch to the low beams. When the high beams are on, a light on the instrument panel will come on. To momentarily activate the high beams as a passing signal, pull the lever slightly toward you and release it when you have completed the signal.

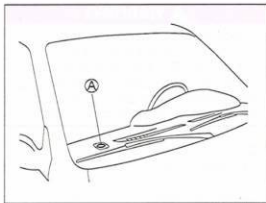

03-65D166A

### Auto-On Headlight System

When it is dark and the ignition switch is turned to the "ON" position, this system automatically turns on all the lights that are operated by the lighting control lever on the steering column even if you do not operate the lighting control lever.

This system is operated by the signal from the light sensor (A) on the right end of the instrument panel. Do not cover the sensor (A). If you do, the system will not work correctly.

### **⚠ WARNING**

It takes about 20 seconds for the light sensor to react to a change in lighting conditions. To help avoid an accident due to reduced visibility, turn on your headlights before driving into a tunnel, parking structure, or the like.

#### **NOTE:**

*This system does not react to all types of ambient light. As the sensor is infrared type, it will not work correctly with ambient lights that do not contain infrared rays.*

**Daytime Running Light (D.R.L.) System**  
The headlights light, but are dimmer than the low beam, when the following three conditions are all met.

Conditions for D.R.L. system operation:

1. The engine is running.
2. The parking brake is released.
3. The lighting switch is at either the "OFF" or the "middle" position.

#### **NOTE:**

*Be sure to turn the lighting switch to the third position at night or at any time of the day when driving or weather conditions require the headlights to operate at full brightness and the taillights to be on.*

#### **Lights "On" Reminder**

A buzzer sounds to remind you to turn off the lights if they are left on when the ignition key is removed and the driver's door is opened.

#### **Turn Signal Operation**

With the ignition switch in the "ON" position, move the lever up or down to activate the right or left turn signals.

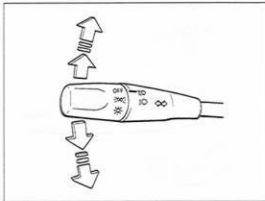

03-50G036A

#### **Normal Turn Signal**

Move the lever all the way up to signal a right turn or all the way down to signal a left turn. When the turn is completed, the signal will cancel and the lever will return to its normal position.

#### **Lane Change Signal**

In some turns, such as changing lanes, the steering wheel is not turned far enough to cancel the turn signal. For convenience, you can flash the turn signal by moving the lever part way and holding it there. The lever will return to its normal position when you release it.



65D-0304-ACE

## WINDSHIELD WIPER AND WASHER LEVER

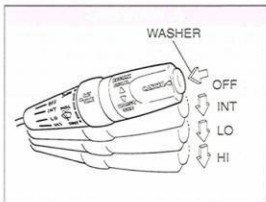

03-60G135A

### Windshield Wipers

To turn the windshield wipers on, move the lever down to one of the three operating positions. In the "INT" position (if equipped), the wipers operate intermittently. The "INT" position is very convenient for driving in mist or light rain. In the "LO" position, the wipers operate at a steady low speed. In the "HI" position, the wipers operate at a steady high speed. To turn off the wipers, move the lever back to the "OFF" position.

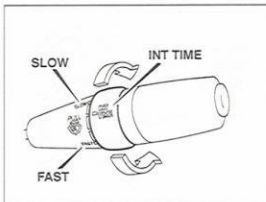

03-60G040A

If the lever is equipped with the "INT TIME" control, turn the control toward the "SLOW" or "FAST" positions to adjust the intermittent wiper operation to the desired interval.

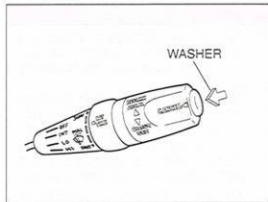

03-60G205A

### Windshield Washer

To spray windshield washer fluid, pull the lever toward you. The windshield wipers will automatically turn on at low speed if they are not already on and if the "INT" position is equipped.

### **⚠ WARNING**

- \* To prevent windshield icing in cold weather, turn on the defroster to heat the windshield before and during windshield washer use.
- \* Do not use radiator antifreeze in the windshield washer reservoir. It can severely impair visibility when sprayed on the windshield, and can also damage your vehicle's paint.

**CAUTION**

To help prevent damage to windshield wiper and washer system components, you should take the following precautions:

- \* Do not continue to hold in the lever when there is no windshield washer fluid being sprayed or the washer motor can be damaged.
- \* Do not attempt to remove dirt from a dry windshield with the wipers or you can damage the windshield and the wiper blades. Always wet the windshield with washer fluid before operating the wipers.
- \* Clear ice or packed snow from the wiper blades before using the wipers.
- \* Check the washer fluid level regularly. Check it often when the weather is bad.
- \* Only fill the washer fluid reservoir 3/4 full during cold weather to allow room for expansion if the temperature falls low enough to freeze the solution.

65D-0305-A0E

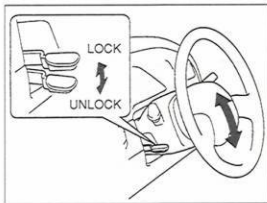
**TILT STEERING LOCK LEVER  
(if equipped)**

03-65D214A

The release lever is located on the left side of the steering column. To adjust the steering wheel height:

- 1) Push down on the release lever and hold it there to unlock the steering column.
- 2) Adjust the steering wheel to the desired height and lock the steering column by letting the release lever return slowly. The steering column will be locked automatically.
- 3) Try moving the steering wheel up and down to make sure it is securely locked in position.

**WARNING**

Never attempt to adjust the steering wheel height while the vehicle is moving or you could lose control of the vehicle.

65D-0308-A0E

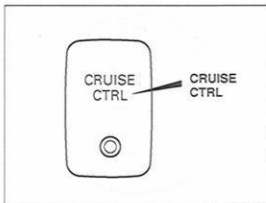
**CRUISE CONTROL (if equipped)**

03-65D296A

The cruise control system allows you to maintain a steady speed without keeping your foot on the accelerator pedal. The controls for operating the cruise control system are on the windshield wiper lever and there is an on/off switch for the system on the instrument panel. When the system is on, an indicator light on the instrument panel switch will be lit. You can use the cruise control system at speeds of about 25 mph (40 km/h) or higher.

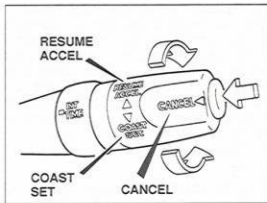

03-60G137A

**WARNING**

To help avoid loss of vehicle control, do not use the cruise control system when driving in heavy traffic, on slippery or winding roads, or on steep downgrades.

**To Set Cruising Speed**

Turn on the cruise control system by pushing the "CRUISE CTRL" button on the instrument panel. Accelerate to the desired speed, turn the control lever to the "COAST SET" position, and then slowly release the lever. Take your foot off the accelerator pedal and the set speed will be maintained.

While the vehicle speed is controlled with this system, the "CRUISE" light on the instrument cluster will be on.

With the cruise control on, you can increase speed for passing by using the accelerator pedal. When you take your foot off the pedal, your vehicle will return to the set speed.

**To Change Cruising Speed**

To reset the cruise control to a slower speed, hold the control lever in the "COAST SET" position until the vehicle has slowed to the desired speed, then slowly release the lever. The new speed will be maintained.

To reset the cruise control to a faster speed, use either of the following procedures:

- Turn the control lever to the "RESUME ACCEL" position and hold it there. Vehicle speed will steadily increase. When you release the lever, the new speed will be maintained.

### HORN

- b) Accelerate to the desired speed using the accelerator pedal and turn the control lever to the "COAST SET" position. When you slowly release the lever, the new speed will be maintained.

#### To Cancel

To cancel cruise control operation, use one of the following procedures:

- a) Slightly depress the brake pedal or clutch pedal, or push in the "CANCEL" button. Cruise control operation will be cancelled until you reset a cruising speed turning the control lever to the "RESUME ACCEL" or the "COAST SET" positions.
- b) Push the "CRUISE CTRL" button on the instrument panel. Cruise control operation will be cancelled until you turn on the system by pushing the "CRUISE CTRL" button again and reset a cruising speed turning the control lever to the "COAST SET" position.

Cruise control operation will also be cancelled any time the vehicle speed falls below 25 mph (40 km/h). The cruise control system will be turned off each time the ignition switch is turned off.

#### To "Resume" a Previously Set Speed

After canceling cruise control operation without turning off the instrument panel switch, you can "resume" a previously set speed, if you have not let your speed drop below 25 mph (40 km/h), by holding the control lever in "RESUME ACCEL" position for about one second. When you release the lever the vehicle will accelerate to and maintain the previously set speed.

#### NOTE:

*If vehicle speed drops below 25 mph (40 km/h), the set speed in the memory is cleared and you can not use the Resume feature. In this case, reset your CRUISE speed.*



G3-65D083A

Press the horn pad on the steering wheel to sound the horn. The horn will sound with the ignition switch in any position.

## INSTRUMENT PANEL

Warning And Indicator Lights .....	4-3
Speedometer/Odometer/Tripmeter (if equipped) .....	4-7
Tachometer (if equipped) .....	4-8
Fuel Gauge .....	4-8
Temperature Gauge .....	4-9
Hazard warning switch .....	4-9
Instrument Light Brightness Control .....	4-9
Rear Window Wiper/Washer Switch (if equipped) .....	4-10
Rear Window Defroster Switch (if equipped) .....	4-10
Cigarette Lighter And Ashtray .....	4-10
Clock (if equipped) .....	4-11
Glove Box .....	4-11
Heater System .....	4-12
Air Conditioning System (if equipped) .....	4-14

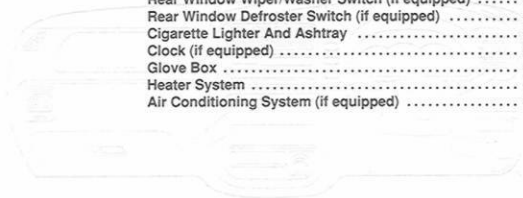

## INSTRUMENT PANEL

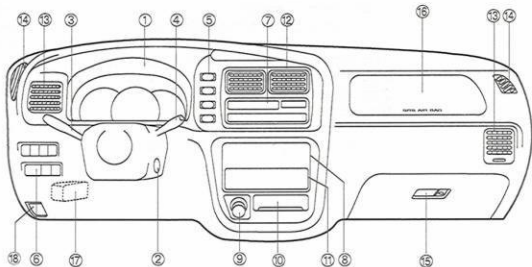

- ① Instrument cluster
- ② Ignition switch
- ③ Lighting switch/Turn signal and dimmer switch
- ④ Windshield wiper and washer switch
- ⑤ Hazard warning switch
- ⑥ Other switches (if equipped)
- ⑦ Heater control panel
- ⑧ Radio (if equipped)
- ⑨ Cigarette lighter (if equipped)
- ⑩ Ashtray
- ⑪ Clock (if equipped)
- ⑫ Center ventilator
- ⑬ Side ventilator
- ⑭ Side defroster
- ⑮ Glove box
- ⑯ Passenger's air bag
- ⑰ Fuse box
- ⑱ Hood release

04-65D159A

## EXAMPLE

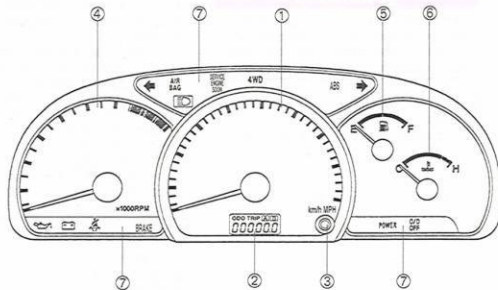

- ① Speedometer
- ② Odometer/Trip meter
- ③ Odometer/Trip meter selector knob
- ④ Tachometer (if equipped)
- ⑤ Fuel gauge
- ⑥ Temperature gauge
- ⑦ Warning and indicator lights

04-6SD160A

## INSTRUMENT PANEL

65D-0401-A2E

### WARNING AND INDICATOR LIGHTS

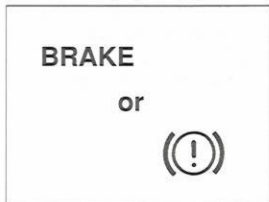

04-60A072A

#### Brake System Warning Light

This light comes on briefly when the ignition switch is turned to the "ON" position. The light also comes on under the following conditions: 1) when the ignition switch is turned to the "START" position, 2) when the parking brake is engaged, and 3) when the fluid in the brake fluid reservoir falls below the specified level. The light should go out after starting the engine and fully releasing the parking brake, if the fluid level in the brake fluid reservoir is adequate.

If the brake system warning light comes on while you are driving the vehicle, it may mean that there is something wrong with the vehicle's brake system. If this happens, you should:

- 1) Pull off the road and stop carefully.

#### WARNING

Remember that stopping distance may be longer, you may have to push harder on the pedal, and the pedal may go down farther than normal.

- 2) Test the brakes by carefully starting and stopping on the shoulder of the road.
  - 3) If you determine that it is safe, drive cautiously at low speed to the nearest dealer for repairs,
- or
- 4) Have the vehicle towed to the nearest dealer for repairs.

#### WARNING

If any of the following conditions occur, you should immediately ask your SUZUKI dealer to inspect the brake system.

- \* If the brake system warning light does not go out after the engine has been started and the parking brake has been fully released.
- \* If the brake system warning light does not come on when the ignition switch is turned to the "START" position.
- \* If the brake system warning light comes on at any time during vehicle operation.

#### NOTE:

*Because the disc brake system is self-adjusting, the fluid level will drop as the brake pads become worn.*

*Replenishing the brake fluid reservoir is considered normal periodic maintenance.*



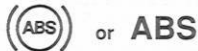

04-50G049A

### Anti-Lock Brake System (ABS) Warning Light (if equipped)

When the ignition switch is turned to the "ON" position, the light comes on briefly so you can check that the bulb is working. If the light stays on, or comes on when driving, there may be something wrong with the ABS.

For V6 engine models, if the ABS light and the brake system warning light stay on, or come on simultaneously when driving, then there may be something wrong with both the rear brake proportioning valve function and anti-lock function of the ABS system.

If one of these happens, have the system inspected by your SUZUKI dealer. If the ABS becomes inoperative, the brake system will function as an ordinary brake system that has no ABS.



04-50G051A

### Oil Pressure Light

This light comes on when the ignition switch is turned on, and goes out when the engine is started. The light will come on and remain on if there is insufficient oil pressure. If the light comes on when driving, pull off the road as soon as you can and stop the engine. Check the oil level and add oil if necessary. If there is enough oil, the lubrication system should be inspected by your SUZUKI dealer before you drive the vehicle again.

### ⚠ CAUTION

- \* If you operate the engine with this light on, severe engine damage can result.
- \* Do not rely on the Oil Pressure Light to indicate the need to add oil. Be sure to periodically check the engine oil level.



04-50G052A

### Charging Light

This light comes on when the ignition switch is turned on, and goes out when the engine is started. The light will come on and remain on if there is something wrong with the battery charging system. If the light comes on when the engine is running, the charging system should be inspected immediately by your SUZUKI dealer.



04-60A341A

**Seat Belt Warning Light**

When the ignition switch is turned to the "ON" position, this light comes on as a reminder and stays on until the driver's seat belt is buckled.

At the same time the warning light is lit, a buzzer sounds for about 6 seconds as a reminder if the driver's seat belt is not buckled.

**⚠ WARNING**

It is absolutely essential that the driver and passengers wear their seat belts at all times. Persons who are not wearing seat belts have a much greater risk of injury if an accident occurs. Make a regular habit of buckling your seat belt before putting the key in the ignition.

**AIR  
BAG**

04-60A212A

**"AIR BAG" light**

This light blinks for several seconds when the ignition switch is turned to the "ON" position so you can check if the bulb is working. The light will come on and stay on if there is a problem in the air bag system.

**⚠ WARNING**

If the "AIR BAG" light does not blink when the ignition switch is turned to the "ON" position, or stays on, or comes on when driving, the air bag system may not work properly. Have the air bag system inspected by an authorized SUZUKI dealer.

**SERVICE  
ENGINE  
SOON**

04-60A511A

**Malfunction Indicator Lamp  
("SERVICE ENGINE SOON")**

Your vehicle has a computer-controlled emission control system. A malfunction indicator lamp is provided on the instrument panel to indicate when it is necessary to have the emission control system serviced. The malfunction indicator lamp comes on when the ignition switch is turned on to let you know the bulb is working and goes out when the engine is started.

If the malfunction indicator lamp comes on or blinks when the engine is running, service to the emission control system is necessary. Bring the vehicle to your SUZUKI dealer to have the emission control system serviced right away and avoid hard acceleration until the service is performed.

**⚠ CAUTION**

Continuing to drive the vehicle when the malfunction indicator lamp is on or blinking can cause permanent damage to the vehicle's emission control system, and can affect fuel economy and driveability.

**NOTE:**

If the fuel filler cap is not installed fully, the electrical system gets wet (such as by driving through a deep puddle of water) or the fuel tank gets nearly empty, the malfunction indicator lamp may come on. If so, the lamp will go off after driving a few times after the fuel filler cap is installed fully, the electrical system dries out or the fuel tank is filled.

**CRUISE**

04-60A297A

**"CRUISE" indicator light (if equipped)**

When the vehicle's speed is controlled by the cruise control system, this light will be on.

**POWER**

04-60A297A

**"POWER" indicator light (if equipped)**

When the ignition switch is turned to "ON" with the power mode selector switch turned to "N" (normal), this indicator comes on briefly to let you know the bulb is working.

When the power mode selector switch is turned to "P" (power) with the ignition switch in the "ON" position, this indicator comes on and remains on.

**O/D OFF**

04-60A298A

**"O/D OFF" indicator light (if equipped)**

When the ignition switch is turned to "ON" with the 4-speed automatic transmission in the 4-speed mode (3-speeds plus overdrive), this light comes on briefly to let you know the bulb is working.

When the automatic transmission is converted to the 3-speed mode (overdrive is off) with the ignition switch in the "ON" position, this indicator comes on and stays on.



04-50G055A

**Turn Signal Indicators**

When you turn on the left or right turn signals, the corresponding green arrow on the instrument panel will flash along with the respective turn signal lights.

When you turn on the hazard warning switch, both arrows will flash along with all of the turn signal lights.



04-50G056A

**High Beam Indicator Light**

This indicator comes on when headlight high beams are turned on.

65D-0402-A1E

**SPEEDOMETER/ODOMETER/TRIPMETER (if equipped)**

04-60A080A

**"4WD" Indicator Light (if equipped)**

This indicator comes on when the ignition switch is in the "ON" position and the transfer lever is in one of the four-wheel drive positions; either "4H" or "4L".

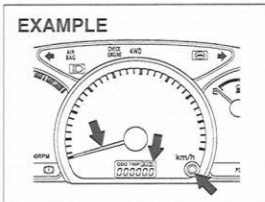

04-65D010A

The speedometer indicates vehicle speed in km/h and miles/h. The odometer records the total distance the vehicle has been driven. The trip meter can be used to measure the distance traveled on short trips or between fuel stops.

**CAUTION**

Keep track of your odometer reading and check the maintenance schedule regularly for required services. Increased wear or damage to certain parts can result from failure to perform required services at the proper mileage intervals.

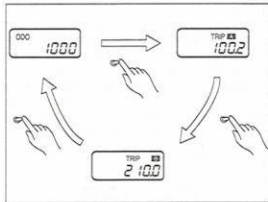

04-65D059A

When the ignition switch is turned to "ON", the display shows the odometer or trip meter.

The display shows three types of indication; odometer, trip meter A and trip meter B. Push the selector knob quickly to switch the indication among the three.

You can use the two trip meters (A and B) independently.

65D-0403-A0E

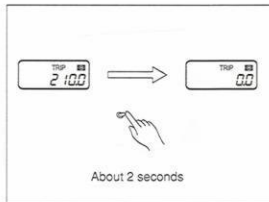
**TACHOMETER (if equipped)**

04-65D060A

Hold in the selector knob for about 2 seconds to reset the trip meter to zero.

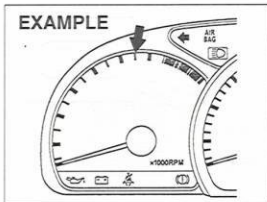

04-65D011A

The tachometer indicates engine speed in revolutions per minute.

**⚠ CAUTION**

Never drive with the engine speed indicator in the red zone or severe engine damage can result.

65D-0404-A0E

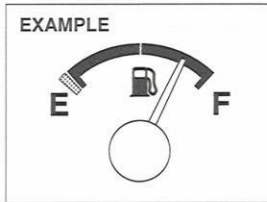
**FUEL GAUGE**

04-65D181A

This gauge gives an approximate indication of the amount of gasoline in the fuel tank. "F" stands for full and "E" stands for empty.

## INSTRUMENT PANEL

65D-0405-A1E

### TEMPERATURE GAUGE

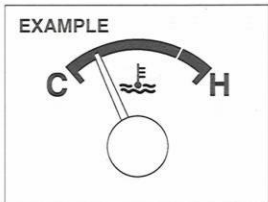

04-65D052A

When the ignition switch is on, this gauge indicates the engine coolant temperature. Under normal driving conditions, the indicator should stay within the normal, acceptable temperature range between "H" and "C". If the indicator goes outside this range and approaches "H", overheating is indicated. Follow the instructions in the "If the Engine Overheats" of "EMERGENCY REMEDIES" section.

#### CAUTION

Continuing to drive the vehicle when engine overheating is indicated can result in severe engine damage.

65D-0419-A0E

### HAZARD WARNING SWITCH

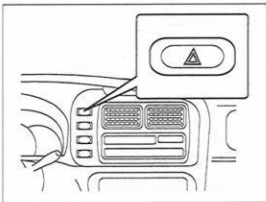

04-65D065A

Push in the hazard warning switch to activate the hazard warning lights. All four turn signal lights and both turn signal indicators will flash simultaneously. To turn off the lights, push the switch again.

Use the hazard warning lights to warn other traffic during emergency parking or when your vehicle could otherwise become a traffic hazard.

65D-0406-A0E

### INSTRUMENT LIGHT BRIGHTNESS CONTROL

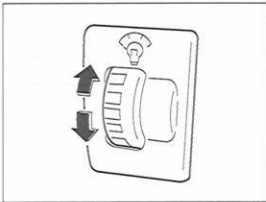

04-60G340A

Turn this control to dim or brighten the instrument lights.

6DA-0408-A0E

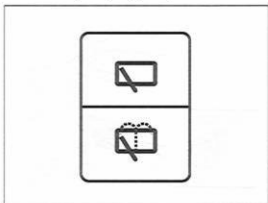
**REAR WINDOW WIPER/WASHER SWITCH (if equipped)**

04-75F024A

With the ignition switch in the "ON" position, push the top switch to turn on the rear wiper. To turn the wiper off, push the switch again.

To spray window washer fluid, hold in the bottom switch. Washer fluid will stop spraying when you release the switch.

**CAUTION**

Clear ice or snow from the rear window and rear wiper blade before using the rear wiper. Accumulated ice or snow could prevent the wiper blade from moving, causing damage to the wiper motor.

6SD-0409-A0E

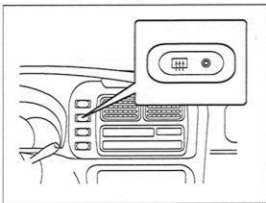
**REAR WINDOW DEFROSTER SWITCH (if equipped)**

04-65D066A

When the rear window is fogged, push this switch to clear the window. An indicator light below the switch will be lit when the defroster is on. The defroster will only work when the ignition switch is in the "ON" position. To turn off the defroster, push the switch again.

**CAUTION**

The rear window defroster uses a large amount of electricity. Be sure to turn off the defroster after the window has become clear.

6SD-0413-A1E

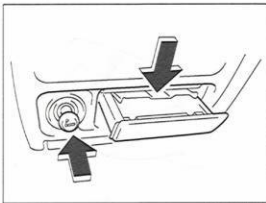
**CIGARETTE LIGHTER AND ASHTRAY**

04-60G343A

**Cigarette Lighter (if equipped)**

To use the cigarette lighter, push it all the way into the receptacle and release it. It will automatically heat up and will pop out to its normal position when it is ready for use.

**CAUTION**

Holding the cigarette lighter in can overheat and damage the lighter. Release the lighter after you push it in.

**CAUTION**

To avoid damage to the cigarette lighter socket, do not use it as an accessory power source. Some accessories' power plug can damage the inner mechanism of the cigarette lighter socket.

6SD-0414-A0E

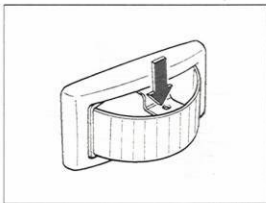
**CLOCK (if equipped)**

04-60B078A

**Ashtray**

To remove the front panel ashtray for cleaning, push down on the metal plate, and pull the ashtray completely out of its holder.

To remove the rear ashtray, push down on the tongue and pull the ashtray out of its holder.

**⚠ WARNING**

Make sure tobacco is fully extinguished before closing the ashtrays. Never throw waste in the ashtrays: it could create a fire hazard.

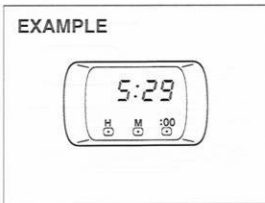

04-6SD061A

The clock operates as long as the battery remains connected and power is supplied to the system. To set the clock, follow the instructions below.

**To set the minute display:**

- Push the “:00” knob to reset the minute display to zero. The hour display may also be affected when the minute display is reset. For example, times between 1:01 ~ 1:29 will be reset to 1:00 and times between 1:30 ~ 1:59 will be reset to 2:00.
- Push the “M” knob to advance the minute display.

**To set the hour display:**

Push the “H” knob to advance the hour display.

6SD-0415-A0E

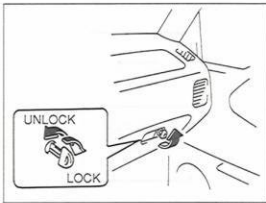
**GLOVE BOX**

04-6SD162A

To open the glove box, pull the latch lever. To close it, push the lid until it latches securely. Lock the glove box by inserting the key and turning it clockwise and unlock the glove box by turning the key counterclockwise.

**⚠ WARNING**

Never drive with the glove box lid open. It could cause injury if an accident occurs.



65D-0416-A2E

## HEATER SYSTEM

The heater system provides heating, defrosting, and ventilation.

- a. Windshield defroster
- b. Side defroster
- c. Side outlet
- d. Center outlet
- e. Floor outlet

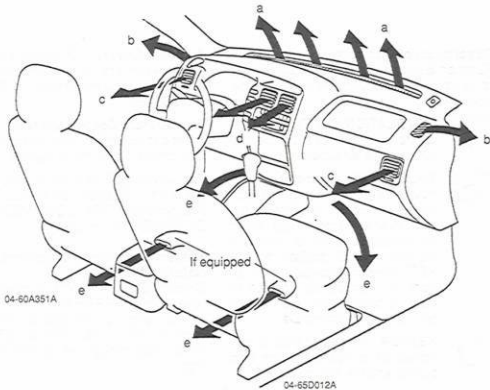
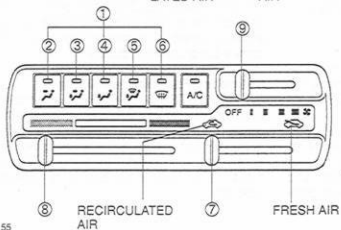
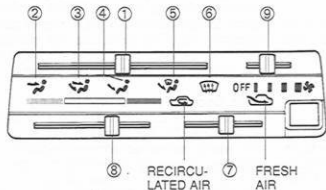

04-60A351A

04-65D012A

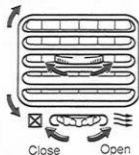

(When "Open", air comes out regardless of the function selector (1) position.)

04-65D0225A

## Description of Controls

Function Selector ①: This selector is used to select one of the functions described below.

04-60A102A



**VENTILATION ②:** Temperature-controlled air comes out of the center and side air outlets.

04-60A103A



**BI-LEVEL ③:** Temperature-controlled air comes out of the floor outlets and cooler air comes out of the center and side outlets. When the temperature control lever is in the fully COLD position or fully HOT position, however, the air from the floor outlets and the air from the center and side outlets will be the same temperature.

04-60A104A



**HEATER ④:** Temperature-controlled air comes out of the floor outlets and the side outlets.

04-60A105A



**HEATER & DEFROST ⑤:** Temperature-controlled air comes out of the floor outlets, the windshield defroster outlets, the side defroster outlets and the side outlets.

04-60A106A



**DEFROST ⑥:** Temperature-controlled air comes out of the windshield defroster outlets, the side defroster outlets and the side outlets.

**Air Intake Lever ⑦:** This lever is used to select between circulating outside air (FRESH AIR) or recirculating inside air (RECIRCULATED AIR).

**Temperature Control Lever ⑧:** This lever is used to control the temperature of the air that comes out of the air outlets.

**Fan Lever ⑨:** This lever is used to turn on the fan and to select fan speed. There are five positions: OFF, LOW, MEDIUM, MEDIUM HIGH and HIGH.

## System Operating Instructions

### Natural Ventilation

Select "VENTILATION" and move the air intake lever to "FRESH AIR", the temperature control lever to the desired temperature position, and the fan lever to "OFF". Fresh air will flow through the vehicle during driving.

### Forced Ventilation

The lever/selector settings are the same as for natural ventilation except you move the fan lever to a position other than "OFF".

### Normal Heating (Using outside air)

Select "HEAT" and move the air intake lever to "FRESH AIR", the temperature control lever to the desired temperature position and the fan lever to the desired fan speed position. Moving the fan lever to a higher fan

speed position increases heating efficiency.

### Quick Heating (Using recirculated air)

The lever/selector settings are the same as for normal heating except you move the air intake lever to "RECIRCULATED AIR". If you use this heating method for an extended period of time, the air in the vehicle can become contaminated and the windows can become misty. Therefore, use this method only for quick heating and change to the normal heating method as soon as possible.

### Head Cooled/Feet Warmed Heating

Select "BI-LEVEL" and move the air intake lever to "FRESH AIR", the temperature control lever to the desired temperature position, and the fan lever to the desired fan speed position. Unless the temperature control lever is in the fully COLD position or fully HOT position, the air that comes out of the center and side outlets will be cooler than the air that comes out of the floor outlets.

### Defrosting/Feet Warmed Heating

Select "HEATER & DEFROST" and move the air intake lever to "FRESH AIR", the temperature control lever to the desired temperature position, and the fan lever to HIGH. When the windshield has become clear, move the fan lever to the desired fan speed position.

**Defrosting**

Select "DEFROST" and move the air intake lever to "FRESH AIR", the temperature control lever to the desired temperature position (higher temperature provides more efficient defrosting), and the fan lever to HIGH. When the windshield has become clear, move the fan lever to the desired fan speed position.

**NOTE:**

The air conditioning system (if equipped) will come on automatically when the function selector ① is turned either to "HEATER & DEFROST" or "DEFROST" with the "HEATER" system on. Although the air conditioning is operating, the indicator light on the A/C button will not come on.

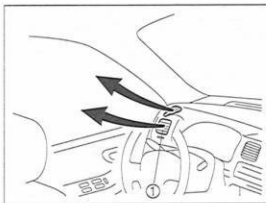

04-65D220A

① Side outlet

**NOTE:**

If you need maximum defrosting, adjust the temperature control lever to the HOT end and adjust the side outlets so the air blows on the side window, in addition to the above Defrosting steps.

65D-0417-A3E

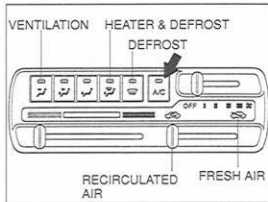
**AIR CONDITIONING SYSTEM  
(if equipped)**

04-65D013A

If your vehicle is equipped with air conditioning, it has an "A/C" button located on the heater control panel. The air conditioning system can be used to provide cooling and dehumidifying, as described below. To turn on the air conditioning system, push in the "A/C" button and move the fan lever to a position other than "OFF". With this mode of "A/C" operation, an indicator light will come on when the air conditioning system is on. To turn off the air conditioning system, push the "A/C" button again.

During operation of the air conditioner, you may notice slight changes in engine speed. These changes are normal; the system is designed so that the compressor turns on or off to maintain the desired temperature. Less operation of the compressor results in

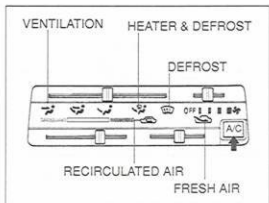

better fuel economy.

### System Operating Instructions

#### Normal Cooling (Using outside air)

Push in the "A/C" button, select "VENTILATION", and move the air intake lever to "FRESH AIR", the temperature control lever to the desired temperature position, and the fan lever to the desired fan speed position. Moving the fan lever to a higher fan speed position increases cooling efficiency.

If the ambient temperature is high enough to cause insufficient cooling, use the "Quick Cooling" below.

#### Quick Cooling (Using recirculated air)

The lever/function button settings are the same as for normal cooling except you

move the air intake lever to "RECIRCULATED AIR". If you use this cooling method for an extended period of time, the air in the vehicle can become contaminated. Therefore, you should occasionally move the air intake lever to "FRESH AIR".

#### NOTE:

*If your vehicle has been left in the sun with the windows closed, it will cool faster if you open the windows briefly while you operate the air conditioner with the air intake lever at "FRESH AIR" and the fan at high speed.*

#### Dehumidifying

Push in the "A/C" button and select a desired function selector position, and move the air intake lever to "FRESH AIR", the temperature control lever to the desired temperature position, and the fan lever to the desired fan speed position.

#### NOTE:

*Because the air conditioner dehumidifies the air, turning it on will help keep the windows clear, even when blowing heated air using the "DEFROST" or "HEATER & DEFROST" functions.*

#### NOTE:

*Your vehicle uses the air conditioning refrigerant HFC-134a, commonly called "R-134a". R-134a replaced R-12 a few*

*years ago for automotive applications. Other refrigerants are available, including recycled R-12, but only R-134a should be used in your vehicle.*

#### CAUTION

Using the wrong refrigerant may damage your air conditioning system. Use R-134a only. Do not mix or replace the R-134a with other refrigerants.

#### Maintenance

Your air conditioner is equipped with air filters. Clean or replace them as specified in the "MAINTENANCE SCHEDULE" in the "INSPECTION AND MAINTENANCE" section. Have this job done by your SUZUKI dealer as the lower glove box must be lowered for this job.

## OTHER CONTROLS AND EQUIPMENT

Parking Brake Lever .....	5-1
Pedals .....	5-1
Gearshift Lever .....	5-2
Transfer Lever (if equipped) .....	5-3
Free Axle Mechanism (For 4WD Vehicle) .....	5-3
Fuel Filler Cap .....	5-4
Folding Seats .....	5-5
Front Seat Armrest .....	5-8
Canvas Top (if equipped) .....	5-8
Sun Visor .....	5-23
Driver's Side Floor Mat .....	5-23
Interior Light Switch .....	5-24
Spot Light (if equipped) .....	5-24
Assist Grips (if equipped) .....	5-25
Accessory Socket (if equipped) .....	5-25
Engine Hood .....	5-26
Cup Holder And Storage Bin (if equipped) .....	5-27
Frame Hooks .....	5-27
Tire Changing Tools .....	5-28
Front Seat Back Pocket (if equipped) .....	5-28
Underseat Tray (if equipped) .....	5-29
Luggage Restraint Loops (if equipped) .....	5-29
Luggage Compartment Cover (if equipped) .....	5-30
Roof Rails (if equipped) .....	5-31

## OTHER CONTROLS AND EQUIPMENT

65D-0501-A0E

### PARKING BRAKE LEVER

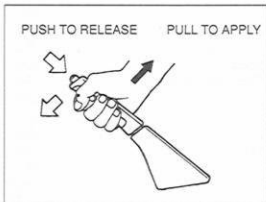

05-60A305A

The parking brake lever is located between the seats. To set the parking brake, hold the brake pedal down and pull the parking brake lever all the way up. To release the parking brake, hold the brake pedal down, pull up slightly on the parking brake lever, push the button on the end of the lever with your thumb, and lower the lever to its original position.

For automatic transmission vehicles, always set the parking brake before moving the gearshift lever to the "P" (PARK) position. If you park on an incline and shift into "P" before you set the parking brake, the weight of the vehicle may make it difficult to shift out of "P" when you are ready to drive the vehicle. When preparing to drive the vehicle, move the gearshift lever out of the "P"

position before releasing the parking brake.

#### **⚠ WARNING**

- \* Never drive your vehicle with the parking brake set: rear brake effectiveness can be reduced from overheating, brake life may be shortened, or permanent brake damage may result.
- \* If the parking brake does not hold the vehicle securely or does not fully release, have your vehicle inspected immediately by an authorized SUZUKI dealer.

#### **⚠ WARNING**

Always set the parking brake fully before leaving your vehicle or it may roll, causing injury or damage. When parking, make sure the gearshift lever for manual transmission vehicles is in 1st gear or "R" (Reverse) and the gearshift lever for automatic transmission vehicles is in "P" (Park). Never leave the transfer lever in "N" (Neutral) when you are parked. Remember, even though the transmission is in gear or in Park, you must set the parking brake fully.

65D-0502-A0E

### PEDALS

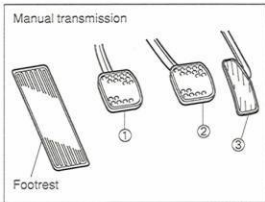

05-65D053A

#### Clutch Pedal ① (For manual transmission)

The clutch pedal is used to disengage the drive to the wheels when starting the engine, stopping, or shifting the transmission lever or transfer lever. Depressing the pedal disengages the clutch.

#### **⚠ CAUTION**

Do not drive with your foot resting on the clutch pedal. It could result in excessive clutch wear or clutch damage.

65D-0503-A0E

## GEARSHIFT LEVER

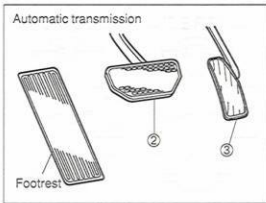

05-65D054A

**Brake Pedal ②**

Your SUZUKI vehicle is equipped with front disc brakes and rear drum brakes. Depressing the brake pedal applies both sets of brakes.

You may hear occasional brake squeal when you apply the brakes. This is a normal condition caused by environmental factors such as cold, wet, snow, etc.

**⚠ WARNING**

If brake squeal is excessive and occurs each time the brakes are applied, you should have the brakes checked by your SUZUKI dealer.

**⚠ WARNING**

Do not "ride" the brakes by applying them continuously or resting your foot on the pedal. This will result in overheating of the brakes which could cause unpredictable braking action, longer stopping distances, or permanent brake damage.

**Accelerator Pedal ③**

This pedal controls the speed of the engine. Depressing the accelerator pedal increases power output and speed.

## Manual Transmission

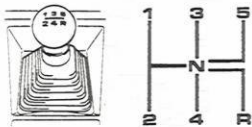

05-60A119A

Your vehicle is equipped with either a manual transmission or automatic transmission. The gearshift lever for each transmission type is shown below. For details on how to use the transmission, refer to the "USING THE TRANSMISSION" in "OPERATING YOUR VEHICLE" section.

65D-0518-A0E

## TRANSFER LEVER (if equipped)

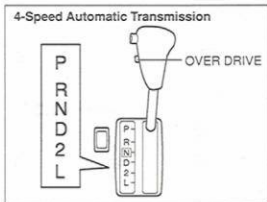

05-65D068A

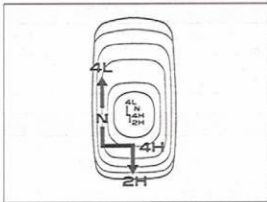

05-65D161A

The transfer lever is used to change between 2-wheel drive and 4-wheel drive. For details on how to use the transfer lever, refer to the "USING THE TRANSFER LEVER" in "OPERATING YOUR VEHICLE" section.

65D-0531-A0E

## FREE AXLE MECHANISM (For 4WD Vehicle)

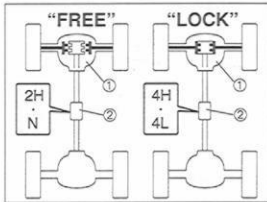

05-65D241A

- ① Front differential case
- ② Transfer case

Your vehicle is equipped with the Free Axle Mechanism. With this feature, the front axles are engaged with (or disengaged from) the front differential gear automatically when the transfer lever is shifted to 4H or 4L (or, to 2H or N) with the ignition switch in the "ON" position.

This feature keeps the front drive train components from rotating during 2-wheel drive operation, providing improved fuel economy and reducing noise and wear.

For proper operation of this system, refer to the "USING THE TRANSFER LEVER" item in the "OPERATING YOUR VEHICLE" section.



65D-0504-A0E

## FUEL FILLER CAP

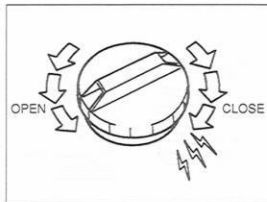
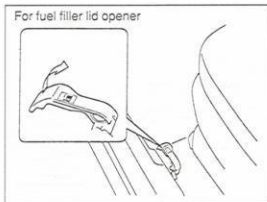
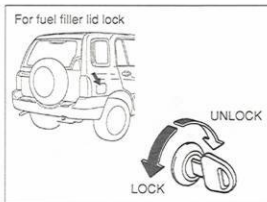

The fuel filler cap is located on the right rear side of the vehicle. There are three different types of fuel filler doors. One type can be opened by using the key, another type can be opened by pulling up the opener lever located under the front outboard end of the driver's seat, and the third type can simply be opened by hand.

To remove the fuel filler cap:

- 1) Open the fuel filler door. If the fuel filler door is not the type that can be opened by hand, you must either insert the key in the fuel filler door lock and turn it clockwise or pull up on the opener lever located under the front outboard end of the driver's seat.

- 2) Remove the cap by turning it counter-clockwise.

**⚠ WARNING**

Remove the fuel filler cap slowly. The fuel may be under pressure and may spray out, causing injury.

To reinstall the fuel filler cap:

- 1) Turn the cap clockwise until you hear several clicks.
- 2) Close the fuel filler door. If the fuel filler door has a lock, turn the key counter-clockwise to lock the door.

**⚠ WARNING**

Gasoline is extremely flammable. Do not smoke when refueling, and make sure there are no open flames or sparks in the area.

**⚠ WARNING**

If you need to replace the fuel cap, use a genuine SUZUKI cap or its equivalent. Use of an improper cap can result in a malfunction of the fuel system or emission control system. It may also result in fuel leakage in the event of an accident.

### FOLDING SEATS

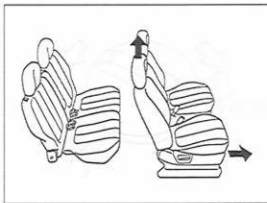

05-65D015A

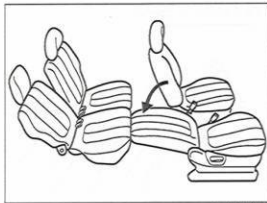

05-65D072A

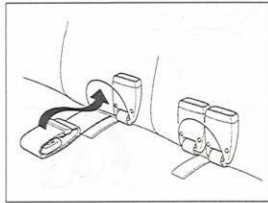

05-65D016A

#### NOTE:

Refer to the "HEAD RESTRAINTS" section for details on how to raise the head restraint. Refer to the "SEAT ADJUSTMENT" section for details on how to slide the seat forward and how to recline the seatback.

#### Flat Folding Front Seats (if equipped)

#### **⚠ WARNING**

Never drive the vehicle with the seats folded fully back. Seatbacks should always be in a fairly upright position when driving, or seat belt effectiveness may be reduced. Seat belts are designed to offer maximum protection when seatbacks are in the fully upright position.

The front seats of your vehicle can be reclined fully back to provide a flat resting place. To fold back a front seat so it is flat:

- 1) Remove the head restraint.
- 2) Slide the seat fully forward.
- 3) Recline the seatback fully.

#### Folding Rear Seats

The rear seat(s) of your vehicle can be folded forward to provide additional cargo space. To fold the rear seat(s) forward:

- 1) Stow the seat belt buckles and center belt webbing in the seatback as illustrated.
- 2) Fold the front seatback(s) forward.
- 3) Remove the rear headrest(s) (if equipped).



05-65D017A

- 4) Pull up the lock release strap ① to fold the bottom cushion forward.
- 5) Fully install the removed headrest to the top of the folded bottom cushion directing the front side of the headrest rearward.
- 6) Extract the plate ring from the holder.

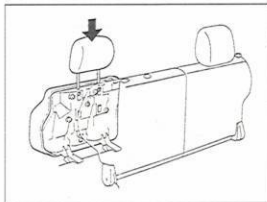

05-65D019A

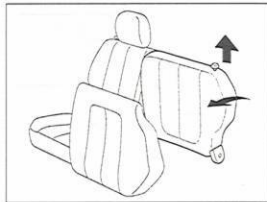

05-65D018A

- 7) Pull up the knob on the top of the seatback and fold the seatback forward.

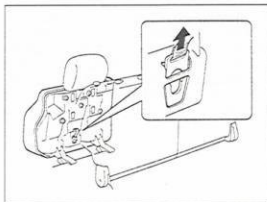

05-65D020A

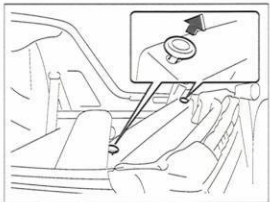

05-65D115A

For one-piece seatback, pull up both knobs simultaneously to fold the seatback forward.

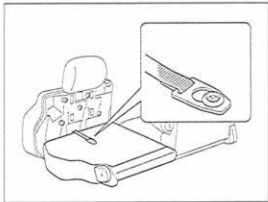

05-65D021A

- 8) Hook the plate ring to the button on the back of the seatback.

To return the seat(s) to the normal position, reverse the procedure used to fold the seat(s) forward. After returning the seat(s) to the normal position, try moving the seat and seatback to make sure they are securely latched. Also, make sure the seat belt buckle catches and center belt webbing are properly located on the bottom cushion.

### **⚠ WARNING**

When returning a rear seat to the normal position, make sure that movement of the seat is unobstructed and the seat and seatback are securely latched.

### **⚠ WARNING**

Luggage or other cargo should be stowed in the luggage compartment with the rear seat in an upright position, whenever possible. If you need to carry cargo in the passenger compartment with the rear seat back folded forward, be sure to secure the cargo or it may be thrown about, causing injury. Never pile cargo higher than the seatbacks.

65D-0541-A0E

**FRONT SEAT ARMREST  
(if equipped)**

05-65D297A

From the stowed (fully up) position, lower the armrest as far as it will go. Then raise it slowly to the desired position. When not in use, return the armrest to the stowed position.

**CAUTION**

To avoid damage to the armrest, do not lean on it or allow a child to sit on it.

65D-0520-A4E

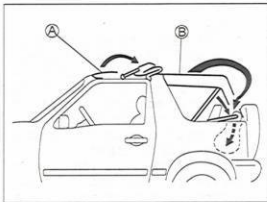
**CANVAS TOP (if equipped)**

05-65D126A

The canvas top consists of two main parts, the folding sunroof **A** and the rear canvas top **B**. The rear canvas top **B** can be opened fully and folded into the luggage compartment with the rear side windows removed and the rear window opened. For the details on how to operate the canvas top, carefully read and follow the instructions and precautions in this section.



05-60A133A

- ① Exhaust gas
- ② Rear window opened or removed
- ③ Folding sunroof opened
- ④ Side window glass slightly opened

**NOTE:**

*You can open or close the rear gate with the rear window closed.*

## SHOULD YOU NEED TO OPEN THE REAR WINDOW

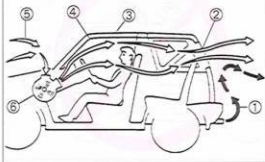

05-60A134A

- ① Exhaust gas
- ② Rear window opened or removed
- ③ Folding sunroof CLOSED
- ④ Side window CLOSED
- ⑤ FRESH AIR
- ⑥ Fan (HIGH SPEED)

**▲ WARNING**

- \* The canvas top is provided only to offer some protection against undesirable weather conditions. It is not designed to hold occupants inside the vehicle, or to protect against the intrusion of foreign objects in the event of an accident. Wear your seat belt at all times.

(Continued)

(Continued)

- \* Do not modify the center pillar of your canvas top vehicle. Modification or damage can result in reduced occupant protection in the event of an accident. If the center pillar becomes damaged in any way, have it checked immediately by your SUZUKI dealer.
- \* Avoid operating the vehicle with the rear gate open and/or the rear window open or removed. If it is necessary to open the rear gate or to open or remove the rear window, make sure the folding sunroof and all windows are closed, and the fan is at high speed with the air intake lever set to "FRESH AIR". If you do not take this precaution, exhaust gas can enter the vehicle. Refer to the "EXHAUST GAS WARNING" section for details.

**▲ CAUTION**

To help prevent damage to the canvas top, you should take the following precautions:

- \* Avoid opening or removing the canvas top when the temperature is below 41°F (5°C). Bending or folding the canvas in cold temperatures can cause damage to the canvas.
- \* Do not run your canvas top vehicle through automatic car washes. The windows can be scratched or the canvas can be damaged.
- \* Do not tap or beat the plastic windows to remove snow or dust when the temperature is below 41°F (5°C). Tapping or beating the plastic windows in cold temperatures can damage the windows.

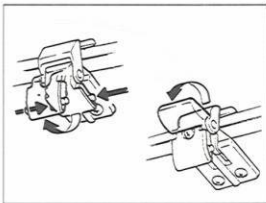

05-60A135A

### Opening and Closing the Folding Sunroof

#### **⚠ WARNING**

Never attempt to open or close the folding sunroof while driving. You may lose control of the vehicle or may damage the canvas top.

To open the folding sunroof, use the following procedure:

- 1) After lowering the sun visors, push in the release buttons on the front latches and unhook the latches.

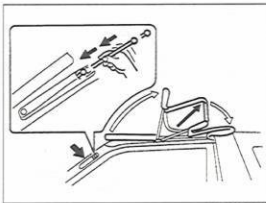

05-65D215A

- 2) Slide the radio antenna all the way in, then pull back the swing arm as shown in the illustration. Make sure that the canvas folds outward as shown.

#### **⚠ CAUTION**

The swing arm may hit and damage the extended radio antenna. Slide the antenna all the way in before moving the swing arm.

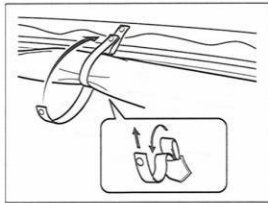

05-65D245A

- 3) Fasten the strap as shown in the illustration to hold the folded canvas in position.

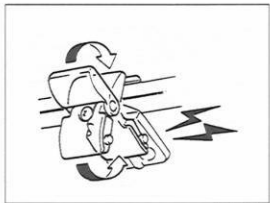

05-60A139A

- 4) Refasten the front latches. Make sure that you hear a "click" when you close each of the latches; the "click" indicates that the latch has locked into place.

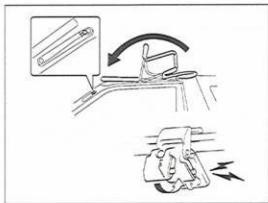

05-65D246A

To close the folding sunroof, first unhook the front latches, then reverse the procedure used to open the sunroof.

Make sure that you hear a "click" when you close each of the front latches; the "click" indicates that the latch has locked into place.

### **⚠ WARNING**

**After opening or closing the sunroof, make sure that the swing arm is secured in place. Failure to properly secure it can cause personal injury or damage.**

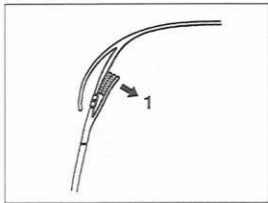

05-65D247A

**Opening and Closing the Rear Window**  
To open the rear window:

- 1) Inside the vehicle, peel apart the fasteners around the rear window.
- 2) Peel off the canvas flap at the bottom corner of the window.
- 3) Unzip the zipper.

To close the rear window, zip the zipper all the way up and refasten all the fasteners peeled apart.



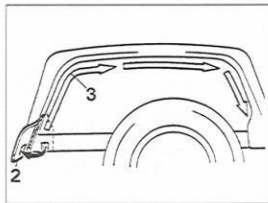

05-65D284A

**WARNING**

When closing the rear window, make sure that it is fully closed and the corner flap is fastened, or exhaust gas can enter the vehicle.

**NOTE:**  
If it is hard to unzip the zipper, try lubricating it with a bar of soap.

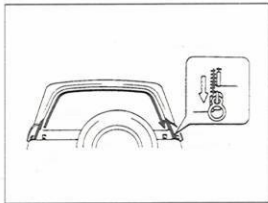

05-60A358A

**Removing and Installing the Rear Window**

The rear window of your vehicle is removable. This allows you to access the cargo area or to replace the window if it becomes deteriorated. To remove the rear window:

- 1) Inside the vehicle, peel apart the fasteners around the rear window.
- 2) Open the rear gate fully.
- 3) Unfasten the canvas flaps at the lower corners of the rear window.
- 4) Unzip the zipper fully.
- 5) Let the rear window hang down to the rear.
- 6) Pull off the rear window frame. At this moment, slide the right end of the frame rear-leftward so it does not hit the tail gate.
- 7) Slide the rear window sideward to remove it from the frame if necessary.

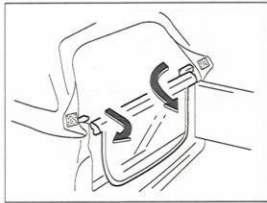

05-65D155A

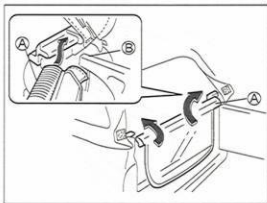

05-65D128A

To install the rear window:

- 1) If the rear window has been removed from the rear window frame, install the window to the frame by sliding so each end of the window aligns with the corresponding end of the frame.
- 2) Install the rear window frame by sliding its right end **A** from the left to the right so the right end **A** does not hit the tail gate **B**.

**NOTE:**

Make sure that the right end of the sliding core of the rear window aligns with the metal frame end before installation.

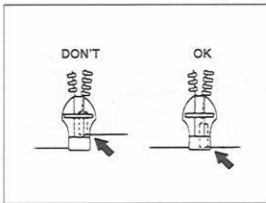

05-60A361A

- 3) Raise the rear window.
- 4) Close the tail gate.
- 5) Fasten the zipper so the end of the zipper is pushed all the way in (as shown in the illustration).

**NOTE:**

If it is difficult to fully seat the zipper end, pull the zipper end loop as shown.

- 6) Zip the zipper fully.
- 7) Refasten all the fasteners peeled apart.

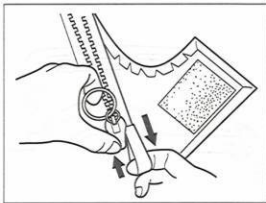

05-65D248A

**WARNING**

When installing the rear window, make sure that it is fully closed and both corner flaps are fastened, or exhaust gas can enter the vehicle.



05-65D133A

### Removing and Installing the Side Window

To remove the side window:

- 1) Turn both bottom pieces of top bow forward while sliding down the release knob **D**.

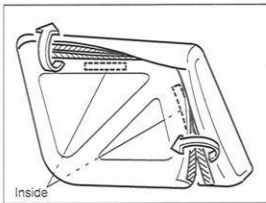

05-65D129A

- 2) Unfasten the top end and rear end of the side window (Both outside and inside).

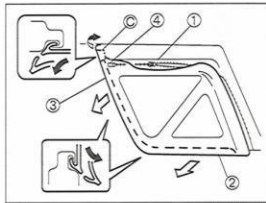

05-65D130A

- 3) Unhook the front end **C** of the rear canvas top.
- 4) Unzip the zipper as far as it goes (to the position **1**).
- 5) Unhook the bottom end **2** and front end **3** of the side window by pulling it down and forward. A rocking motion will help this job.
- 6) Unzip the zipper fully (to position **4**) and remove the side window.
- 7) Hook the front end **C** of the canvas top.
- 8) Turn back the bottom pieces of top bow to give tension to the top.

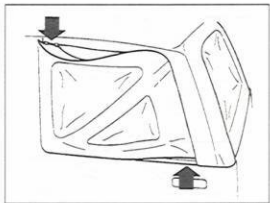

05-60A364A

To install the side window, reverse the procedure used to remove it.

Be sure to:

- 1) put the rear bottom corner of the window on the rear part of the vehicle body temporarily to engage the zipper end.
- 2) push the end of the zipper all the way in, and

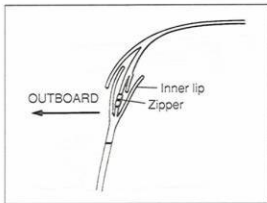

05-60A365A

- 3) push in the inner lip of the side window inside the canvas top while zipping.
- 4) Refasten the inner lip.

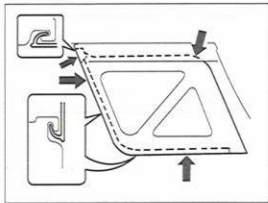

05-65D131A

After completing installation, make sure that the front and bottom ends are securely hooked and the rear top end is under the canvas top.

Also, make sure that the front end of the rear canvas top is securely hooked.

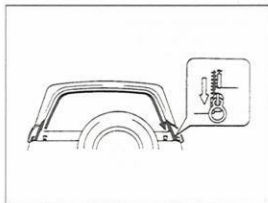

05-60A358A

### Lowering and Raising the Rear Canvas Top

#### To lower the rear canvas top:

- 1) Remove the side windows of the canvas top.
- 2) Open the rear window and hang it down inside the luggage compartment.

Make sure the right end of the zipper is detached.

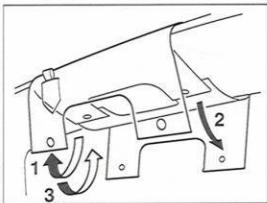

05-65D249A

- 3) Unfasten all the snaps that secure the canvas top to the roof piece.

Refasten the snaps that secure the folding sunroof canvas to the roof piece.



05-65D133A

- 4) Turn both bottom pieces of top bow forward while sliding down the release knob (D) if this hasn't been done yet.

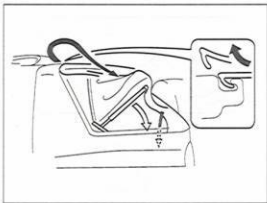

05-65D134A

- 5) Unhook the front end of the rear canvas top.
- 6) Lower the top bow slowly while neatly tucking the canvas into the luggage compartment.
- 7) Turn both bottom pieces of top bow rearward fully.
- 8) Stow the canvas in the luggage compartment completely.

Make sure that the rear seat belts around the shoulder anchor are clear from the folded canvas top.

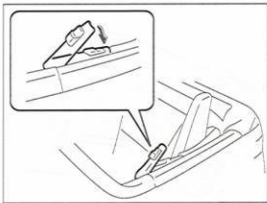

05-65D1177A

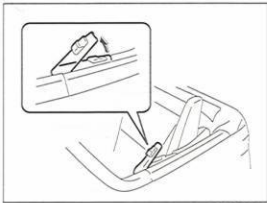

05-65D250A

### To raise the rear canvas top:

- 1) Unlock the bottom pieces of top bow.
- 2) Raise the top bow while spreading the canvas forward.
- 3) Hook the front end of the canvas to the roof piece completely.

### NOTE:

When hooking the front end of the canvas, align the center notch (A) of the canvas with the center mark (B) of the roof piece.

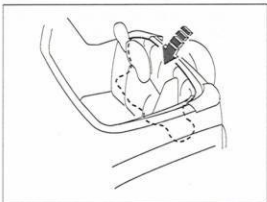

05-65D135A

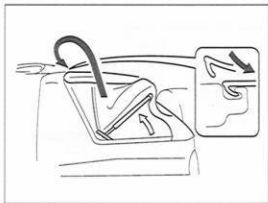

05-65D136A

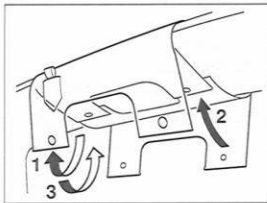

05-65D251A



05-65D138A

- 4) Unfasten the snaps that secure the folding sunroof canvas to the roof piece. Fasten the snaps to secure the rear canvas top to the roof piece. Refasten the snaps of the folding sunroof.
- 5) Raise and close the rear window.
- 6) Install the side windows.

- 7) Turn both bottom pieces of top bow rearward until it clicks.

Make sure the canvas top is properly tensioned with the front end and both rear bottom corners hooked firmly.

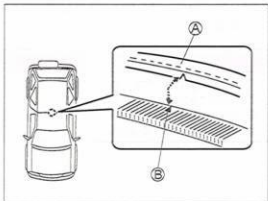

05-65D137A

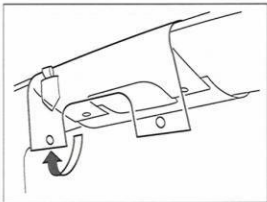

05-65D252A

### Removing and Installing the Folding Sunroof

If you need to replace the folding sunroof, proceed as follows.

#### To remove the folding sunroof:

- 1) Unfasten the snaps that secure the folding sunroof canvas to the roof piece.

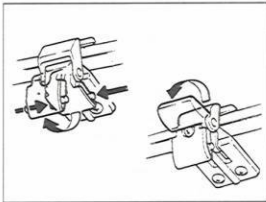

05-60A135A

- 2) After lowering the sun visors, push in the release buttons on the front latches and unhook the latches.

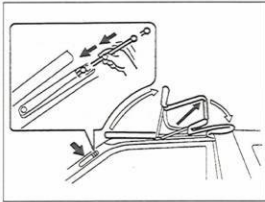

05-65D215A

- 3) Slide the radio antenna all the way in, then pull back the swing arm as shown in the illustration. Make sure that the canvas folds outward as shown.

#### **CAUTION**

The swing arm may hit and damage the extended radio antenna. Slide the antenna all the way in before moving the swing arm.



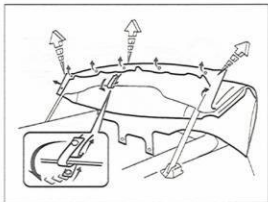

05-65D253A

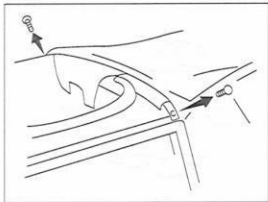

05-65D254A

- 4) Unfasten all the snaps that secure the sunroof canvas to the swing arm.
- 5) Detach the sunroof canvas from the swing arm.

- 6) Undo the two screws that secure the rear end of sunroof canvas to the center pillar.
- 7) Remove the sunroof canvas by slightly sliding rearward.

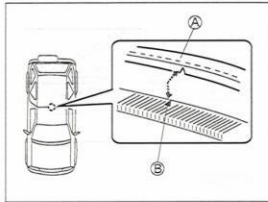

05-65D137A

#### To install the sunroof canvas:

Reverse the procedure used to remove it.

#### NOTE:

When hooking the rear end of the sunroof canvas, align the center notch (A) of the canvas with the center mark (B) of the roof piece.

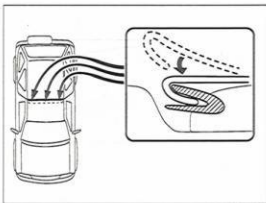

05-65D118A

**NOTE:**

*When fitting the rear end of sunroof canvas to the roof piece, make sure the rear end is completely hooked in the groove of roof piece (all the way from the right end to the left end).*

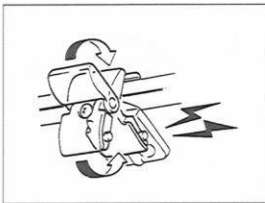

05-60A139A

**⚠ WARNING**

After closing the sunroof, make sure that the swing arm is secured in place. Failure to properly secure the swing arm can cause personal injury or damage.

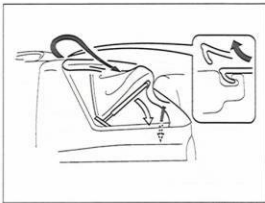

05-65D134A

**Removing and Installing the Rear Canvas Top**

If you need to replace the rear canvas top, proceed as follows.

**To remove the rear canvas top:**

- 1) Lower the rear canvas top.  
(See “Lowering and Raising the Rear Canvas Top” item.)

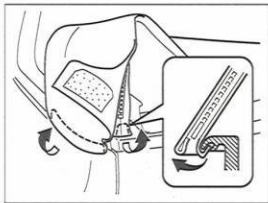

05-65D119A

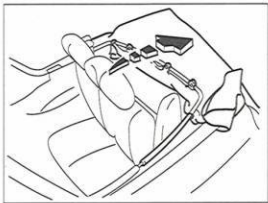

05-65D120A

- 2) Unhook both rear bottom corners of rear canvas top. Remember that there are two portions to be unhooked for each corner.
- 3) Let the front part of the rear canvas top come to the rear.
- 4) Unhook the snaps that secure the canvas to the top bow.
- 5) Remove the canvas.

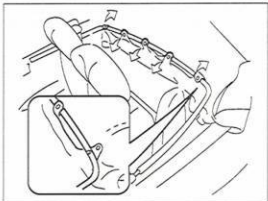

05-65D223A

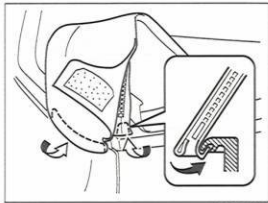

05-65D122A

#### To install the rear canvas top:

Reverse the procedure used to remove it.

Make sure that each rear bottom corner of the canvas top are hooked at two portions.

## OTHER CONTROLS AND EQUIPMENT

65D-0506-A1E

### SUN VISOR

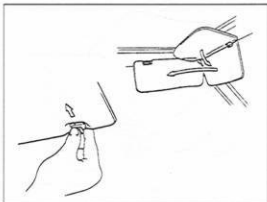

05-60A158A

The sun visors can be pulled down to block glare coming through the windshield, or they can be unhooked and turned to the side to block glare coming through the side window.

#### **CAUTION**

When unhooking and hooking a sun visor, be sure to handle it by the hard plastic parts or the sun visor can be damaged.

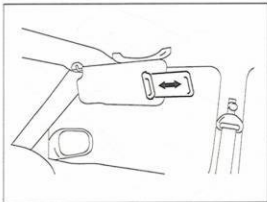

05-65D123A

#### **Sun visor extension (if equipped)**

If you need more surface area on the sun visor when it is turned to the side, pull out the extension. Be sure to push it in when you return the sun visor to the forward position.

65D-0542-A0E

### DRIVER'S SIDE FLOOR MAT (if equipped)

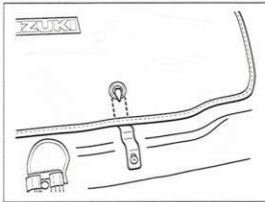

05-65D303A

Unhook grommet from the bracket to remove floor mat from vehicle.

Hook the grommet to the bracket to install floor mat into the vehicle. Make sure that floor mat is in position before driving.

#### **WARNING**

To keep floor mat away from pedals, securely position grommet over floor mat bracket.

65D-0507-A0E

## INTERIOR LIGHT SWITCH

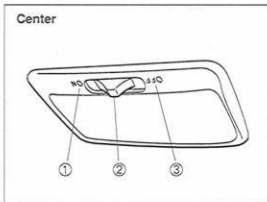

05-60G070A

The interior light switch has three positions.

- ① The light comes on and stays on regardless of whether the door is open or closed.
- ② The light comes on when the door is opened.
- ③ The light remains off even when the door is opened.

**NOTE:**

The number of doors involved in the lighting operation of the interior light depends on the vehicle specification. If there is a switch (rubber projection) at the door opening as shown, the door is involved in the lighting operation.

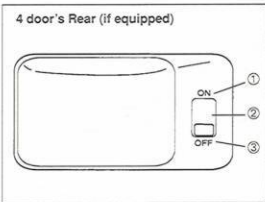

05-60G314A

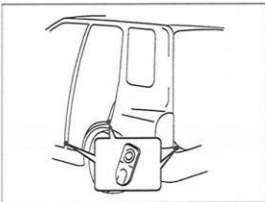

05-65D069A

65D-0521-A1E

## SPOT LIGHT (if equipped)

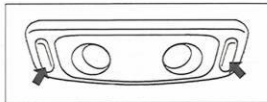

05-65D022A

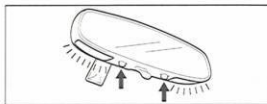

05-65D273A

Push the switch to turn on the light and push it again to turn off the light.

## OTHER CONTROLS AND EQUIPMENT

65D-0509-A0E

### ASSIST GRIPS (if equipped)

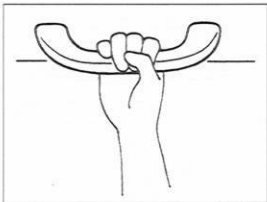

05-60A165A

Assist grips are provided for passenger convenience.

#### **⚠ WARNING**

Do not hang items on the assist grips. They could obstruct the driver's view, resulting in an accident, or could be thrown about in an accident or abrupt maneuver, causing injury.

65D-0420-A1E

### ACCESSORY SOCKET (if equipped)

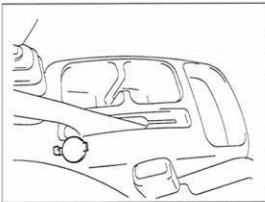

05-65D185A

The socket is located either on the center console or on the left side of the luggage compartment.

This socket can be used to provide 12 volt/120 watt power for electrical accessories which are designed to plug into a cigarette lighter receptacle. Make sure that the cap remains on the socket when the socket is not in use.

#### **⚠ CAUTION**

Use of inappropriate electrical accessories can cause damage to your vehicle's electrical system. Make sure that any electrical accessories you

(Continued)

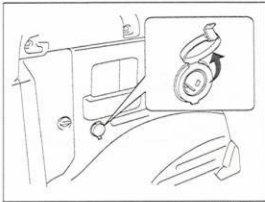

05-65D153A

(Continued)

use are designed to plug into this type of socket.

65D-0510-A0E

## ENGINE HOOD

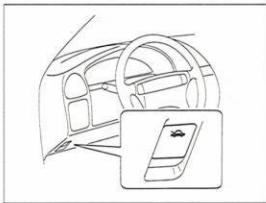

05-60G072A

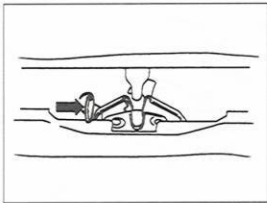

05-65D039A

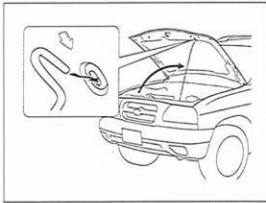

05-65D023A

To open the engine hood:

- 1) Pull the hood release handle located on the outboard side of the driver's side of the instrument panel. This will disengage the engine hood lock half-way.

- 2) Push the under-hood release lever sideways with your finger, as shown in the illustration. While pushing the lever, lift up the engine hood.

- 3) Continue to lift up the hood until it is high enough to support with the prop rod.

**⚠ WARNING**

Make sure the hood is fully closed and latched before driving. If it is not, it can fly up unexpectedly during driving, obstructing your view and resulting in an accident.

## OTHER CONTROLS AND EQUIPMENT

65D-0529-A0E

### CUP HOLDER AND STORAGE BIN (if equipped)

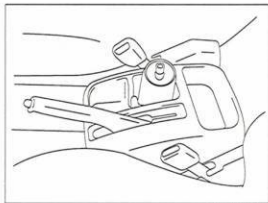

05-65D186A

Cup holders and a storage bin are provided in the center console.

#### **⚠ WARNING**

Do not use the cup holder or the storage bin to hold cups containing hot liquids, or sharp-edged, hard or breakable objects. Objects in these bins may be thrown about during a sudden stop or impact, and could cause personal injury.

65D-0523-A0E

### FRAME HOOKS

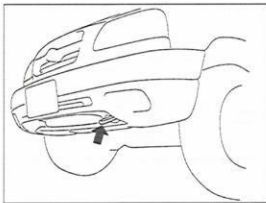

05-65D024A

Frame hooks are provided at the front and rear of the vehicle.

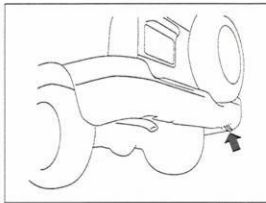

05-65D025A

#### **⚠ WARNING**

Do not use the frame hooks to tow another vehicle or to have your vehicle towed on the road or highway. The hooks are designed for use in emergency situations only, such as if your vehicle or another vehicle gets stuck in deep mud or snow.



65D-0512-A0E

## TIRE CHANGING TOOLS

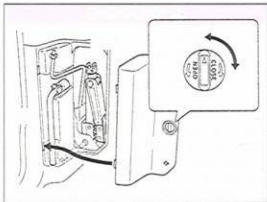

05-65D196A

The jack, wheel wrench and jack handle are stowed in the rear left corner of the luggage compartment.

Turn the knob and remove the cover to access the tools.

To remove the jack, turn its shaft counter-clockwise and pull the jack out of the storage bracket. To stow the jack, place it in the storage bracket and turn the shaft clockwise until the jack is securely held in place.

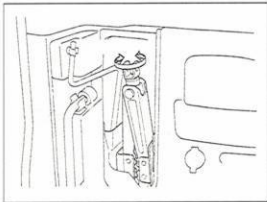

05-65D027A

**⚠ WARNING**

The jack should be used only to change wheels. It is important to read the jacking instructions in the "EMERGENCY SERVICE" section of this manual before attempting to use the jack.

**⚠ WARNING**

After using the jack, jack handle, and wheel wrench, be sure to stow them securely or they can cause injury if an accident occurs.

65D-0515-A0E

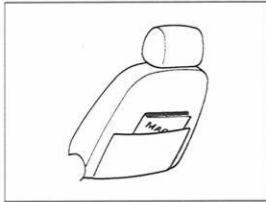
FRONT SEAT BACK POCKET  
(if equipped)

05-60B119A

This pocket is provided for holding light and soft things such as gloves, newspapers or magazines.

**⚠ WARNING**

Do not put hard or breakable objects in the pocket. If an accident occurs, objects such as bottles, cans, etc. can injure the occupants in the rear seat.

## OTHER CONTROLS AND EQUIPMENT

65D-0529-A0E

### UNDERSEAT TRAY (if equipped)

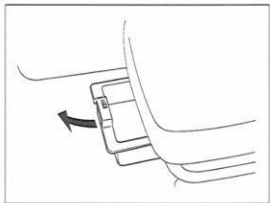

05-70G074A

The tray is located under the driver's seat. Pull the lever forward to draw out the tray. Be sure to push the tray back in before driving.

65D-0529-A1E

### LUGGAGE RESTRAINT LOOPS (if equipped)

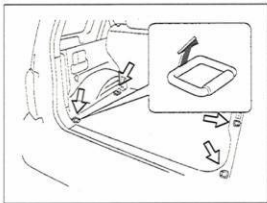

05-65D028A

Four luggage restraint loops are provided on the luggage compartment floor. An optional rubber net can be hooked to these loops to help keep cargo from moving around in the luggage compartment during normal driving.

### **▲ WARNING**

The luggage restraint loops and optional rubber net can be used to help keep lightweight cargo from moving around in the luggage compartment during normal driving. They are neither capable of nor intended for preventing cargo from being thrown around in a crash.

Place heavier objects on the floor and as far forward in the cargo area as possible. Never pile cargo higher than the top of the seat backs.

### **▲ WARNING**

Do not attach the child restraint top strap to the luggage restraint loops. Incorrectly attached top strap will reduce the intended effectiveness of the child restraint system.

65D-0513-A2E

## LUGGAGE COMPARTMENT COVER (if equipped)

Luggage or other cargo placed in the luggage compartment can be hidden from view by a luggage compartment cover (ring hook type or roll type).

However, the luggage compartment covers are not designed to support items loaded on top of them, and may get damaged if used as a shelf.

### ⚠ WARNING

Do not carry items on top of the luggage compartment cover, even if they are small and light. Objects on top of the cover could be thrown about in an accident, causing injury, or could obstruct the driver's rear view.

### ⚠ CAUTION

To avoid damaging the luggage compartment cover:

- \* Do not place items on top of it.
- \* Do not push down on it or lean on it.
- \* Handle it carefully when installing or removing.

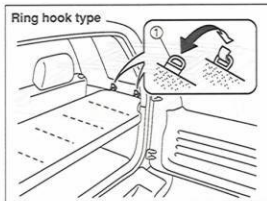

05-65D280A

#### ① Ring hook

#### Ring hook type

To use the cover, simply hook the rings ① as shown.

#### Roll type

To use the cover, pull it rearward and hook it as shown.

To remove the cover housing, simply push up both ends. To install the cover housing push the ends back in.

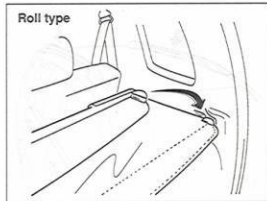

05-65D081A

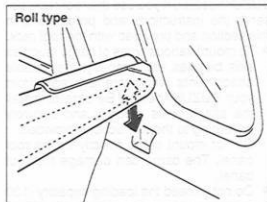

05-65D082A

## OTHER CONTROLS AND EQUIPMENT

65D-0528-A0E

### ROOF RAILS (if equipped)

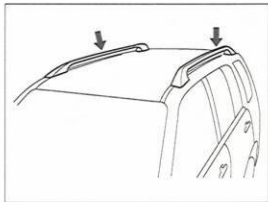

05-65D167A

You can use the roof rails to attach the optional roof rack which is available at your SUZUKI dealer. If you use the roof rack, observe the instructions and precautions in this section and provided with the roof rack.

- To mount various types of cargo (such as skis, bicycles, etc.) properly, use suitable attachments which are available from your SUZUKI dealer. Be sure to install the attachments properly and securely according to the instructions provided. Do not mount cargo directly on the roof panel. The cargo can damage the roof panel.
- Do not exceed the loading capacity (100 lbs (45kg)). Also, do not let the gross vehicle weight (fully loaded vehicle including driver, passengers, cargo, roof load

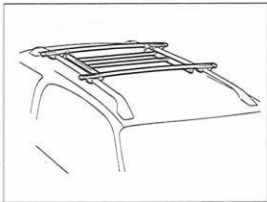

05-65D163A

and trailer tongue weight) exceed the Gross Vehicle Weight Rating (GVWR) listed on the driver's door lock pillar.

- Mount and secure the cargo onto the roof rack properly according to the instructions provided. Be sure to stow the heaviest items at the bottom and distribute the cargo as evenly as possible.
- Do not carry items so large that they hang over the bumpers or the sides of the vehicle, or block your view.
- Secure the front and rear ends of long items--such as wood panels, surfboards and so forth--to both the front and rear of the vehicle. You should protect the painted surfaces of the vehicle from scuffing caused by tie-down ropes.

- Check periodically to make sure the roof rack is securely installed and free from damage.

#### **WARNING**

- \* Abrupt maneuvers or failure to properly secure the cargo can allow the cargo to fly off the vehicle and hit others, causing personal injury or property damage. Mount the cargo securely and avoid abrupt maneuvers (such as "jackrabbit" starts, sharp turns, fast cornering and sudden braking). Check periodically to make sure the cargo is securely fastened.
- \* Large, bulky, long, or flat items can affect vehicle aerodynamics or be caught by the wind, and can reduce vehicle control resulting in an accident and personal injury. Drive cautiously at a safely reduced speed when carrying this type of cargo.

# OPERATING YOUR VEHICLE

Exhaust Gas Warning .....	6-1
Daily Inspection Checklist .....	6-1
Starting the Engine .....	6-2
Engine Block Heater .....	6-3
Using the Transmission .....	6-3
Using the Transfer Lever (if equipped) .....	6-7
Braking .....	6-9
Break-In .....	6-11
Catalytic Converter .....	6-11
Improving Fuel Economy .....	6-12

## EXHAUST GAS WARNING

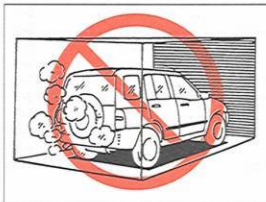

06-65D042A

**⚠ WARNING**

Avoid breathing exhaust gases. Exhaust gases contain carbon monoxide, a potentially lethal gas that is colorless and odorless. Since carbon monoxide is difficult to detect by itself, be sure to take the following precautions to help prevent carbon monoxide from entering your vehicle.

- \* Do not leave the engine running in garages or other confined areas.
- \* Do not park with the engine running for a long period of time, even in an open area. If it is necessary to sit for a short time in a parked vehicle with the engine running,

(Continued)

(Continued)

- make sure the air intake lever is set to "FRESH AIR" and the fan is at high speed.
- \* Avoid operating the vehicle with the rear door, tailgate, or rear window open. If it is necessary to operate the vehicle with the rear door, tailgate, or rear window open, make sure the folding sunroof (if equipped) and all windows are closed, and the fan is at high speed with the air intake lever set to "FRESH AIR".
- \* To allow proper operation of your vehicle's ventilation system, keep the air inlet grille in front of the windshield clear of snow, leaves, or other obstructions at all times.
- \* Keep the exhaust tailpipe area clear of snow and other material to help reduce the buildup of exhaust gases under the vehicle. This is particularly important when parked in blizzard conditions.
- \* Have the exhaust system inspected periodically for damage and leaks. Any damage or leaks should be repaired immediately.

## DAILY INSPECTION CHECKLIST

**Before driving:**

- 1) Make sure that windows, mirrors, lights, and reflectors are clean and unobstructed.
- 2) Check the tires.
- 3) Look for fluid, oil leaks.

**NOTE:**

*It is normal for water to drip from the air conditioning system after use.*

- 4) Make sure the hood is fully closed and latched.
- 5) Check the headlights, turn signal lights, brake lights and horn for proper operation.
- 6) Lock all doors.
- 7) Adjust the seat and adjustable head restraints (if equipped).
- 8) Check the brake pedal.
- 9) Adjust the mirrors.
- 10) Make sure that you and all passengers have properly fastened your seat belts.
- 11) Make sure that all warning lights come on as the key is turned to the "ON" or "START" position.
- 12) Check all gauges.
- 13) Make sure that the BRAKE light turns off when the parking brake is released.

65D-0603-A0E

**STARTING THE ENGINE**

Once a week, or each time you fill your fuel tank, perform the following under-hood checks:

- 1) Engine oil level.
- 2) Coolant level.
- 3) Brake fluid level.
- 4) Power steering (if equipped) fluid level.
- 5) Windshield washer fluid level.
- 6) Hood latch operation

Pull the hood release handle inside the vehicle. Make sure that you cannot open the hood all the way without releasing the secondary latch. Be sure to close the hood securely after checking for proper latch operation. See the item "All Latches, Hinges and Locks" of "CHASSIS AND BODY" in the "PERIODIC MAINTENANCE SCHEDULE" section in the "INSPECTION AND MAINTENANCE" section for lubrication schedule.

**⚠ WARNING**

**Make sure the hood is fully closed and latched before driving. If it is not, it can fly up unexpectedly during driving, obstructing your view and resulting in an accident.**

**Before starting the engine:**

- 1) Make sure the parking brake is set fully.
- 2) Manual Transmission — Shift into "N" (Neutral) and depress the clutch pedal all the way to the floor.  
Hold it while starting the engine.  
Automatic Transmission — If the shift lever is not in "P" (Park) position, shift into "P" (Park). (If you need to re-start the engine while the vehicle is moving, shift into "N".)

**NOTE:**

*Automatic transmission vehicles have a starter interlock device which is designed to keep the starter from operating if the transmission is in any of the drive positions.*

**⚠ WARNING**

**Make sure that the parking brake is set fully and the transmission is in Neutral (or Park for vehicles with an automatic transmission) before attempting to start the engine.**

**Starting a Cold Engine**

With your foot off the accelerator pedal, crank the engine by turning the ignition key to "START". Release the key when the engine starts.

**⚠ CAUTION**

- \* Stop turning the starter immediately after the engine has started or the starter system can be damaged.
- \* Do not crank the engine for more than 15 seconds at a time. If the engine doesn't start on the first try, wait about 15 seconds before trying again.

If the engine does not start after 15 seconds of cranking, wait about 15 seconds, then press down the accelerator pedal to 1/3 of its travel and try cranking the engine again. Release the key and accelerator pedal when the engine starts.

If the engine still does not start, try holding the accelerator pedal all the way to the floor while cranking. This should clear the engine if it is flooded.

If you are unable to start the engine using this procedure, consult your SUZUKI dealer.

**Starting a Warm Engine**

Use the same procedure as for "Starting a Cold Engine".

## OPERATING YOUR VEHICLE

65G-0611-ADE

### ENGINE BLOCK HEATER (if equipped)

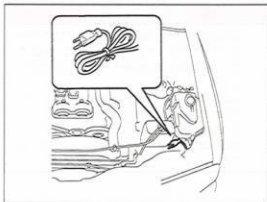

06-65D301A

The engine block heater will help you start the engine more easily in very cold weather (0°F (-18°C) or below). To use the engine block heater:

- 1) Turn off the engine.
- 2) Open the engine hood.
- 3) Untie the block heater cord and remove the block heater plug cap. When the engine block heater is not in use, ensure the heater cord is secured to prevent contact with any moving parts.
- 4) Using a heavy-duty, three-prong grounded extension cord, plug the female end into the block heater socket and the male end into a normal, grounded 110-volt AC outlet.

#### NOTE:

Activate the heater at least four hours before you start the engine. However, as the heating

time varies depending on the ambient temperature and other factors, adjust the time by observing the engine cranking condition.

#### **⚠ WARNING**

To avoid serious personal injury caused by electrical shock or fire:

- \* Do not plug the cord into a non-grounded outlet. Only use a properly grounded three-prong 110-volt AC outlet.
- \* Do not use a 2-wire (non-grounded) extension cord.
- \* Only use a heavy-duty, three-prong extension cord rated for at least 15 amps.

After using the block heater:

- 1) Unplug the extension cord and reinstall the plug cap.
- 2) Tie the block heater cord back to its original position.

#### **⚠ CAUTION**

Secure the block heater cord back to its original position or to the routed position. A loose cord could get caught in the engine accessory drive belt(s) or other moving parts.

- 3) Close the engine hood securely before starting the engine.

65D-0604-A1E

### USING THE TRANSMISSION

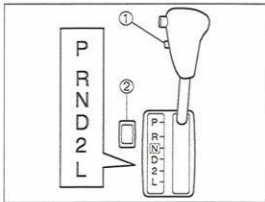

06-65D068A

- ① Overdrive off switch
- ② Power mode selector switch

#### 4-Speed Automatic Transmission

The transmission is a 4-speed (3-speed plus overdrive) automatic transmission. By operating the overdrive off switch, the transmission can be converted to a 3-speed automatic transmission that will not shift to the overdrive position. To convert the transmission to the 3-speed mode, push in the overdrive off switch and release it with the ignition switch in the "ON" position. The "O/D OFF" indicator light in the instrument cluster comes on.



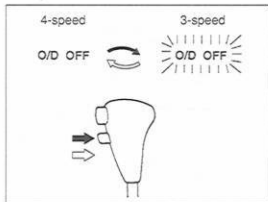

06-65D298A

To return the transmission to the 4-speed mode, push in the overdrive off switch again. The "O/D OFF" indicator light goes off.

When the ignition switch is turned to the "ACC" position, the transmission in the 3-speed mode is converted to the 4-speed mode automatically.

**NOTE:**

With the transfer lever in the "4L" position, the 4-speed automatic transmission will remain in the 3-speed mode.

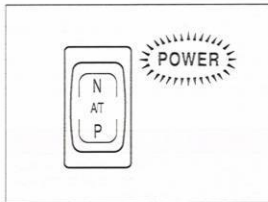

06-65D071A

A power mode selector switch is fitted as well. When you need more power for climbing hills or quicker acceleration, turn the switch to "P" (power). The "POWER" indicator light in the instrument cluster comes on, and the shifting points are delayed so the engine can rev higher in each gear. For normal driving, turn the switch to "N" (normal). The "POWER" indicator light goes off.

The gearshift lever has a lock mechanism to help prevent accidental shifting into or out of "P" (Park), into "R" (Reverse), from "D" (Drive) to "2" (Low 2), and from "2" (Low 2) to "L" (Low 1). To release the lock, push in the lock button on the left side of the gearshift lever before shifting.

The shift lever is designed so that it can not be shifted out of the "P" position unless the ignition switch is in the "ON" position and the brake pedal is depressed at the time that you push in the shift lever lock button.

**⚠ WARNING**

Always depress the brake pedal before shifting from "P" (Park) or "N" (Neutral) to a forward or reverse gear, to help prevent the vehicle from moving unexpectedly when you shift.

For all normal driving, make sure that the "O/D OFF" and "POWER" indicator lights are off, then put the gearshift lever into "D" (Drive). Use the other gearshift lever positions as described below:

**P (Park)**

Use this position to lock the transmission with the transfer lever in gear when the vehicle is parked or when starting the engine. Shift into Park only when the vehicle is completely stopped.

**R (Reverse)**

Use this position to back the vehicle from stop. Make sure that the vehicle is completely stopped before shifting into Reverse.

### N (Neutral)

Use this position for starting the engine if the engine stalls and you need to restart it while the vehicle is moving. You may also shift into Neutral and depress the brake pedal to hold the vehicle stationary during idling.

### D (Drive)

Use this position for all normal driving.

With the selector in "D" range, you can get an automatic downshift by pressing the accelerator pedal. The higher the vehicle speed is, the more you will need to press the accelerator pedal to get a downshift.

### 2 (Low 2)

Use this position to provide extra power when climbing hills, or to provide engine braking when going down hills.

#### NOTE:

*In this position, if the power mode selector switch is turned to the "P" position, the transmission will not downshift into "L" (Low).*

### L (Low 1)

Use this position to provide maximum power when climbing steep hills or driving through deep snow or mud, or to provide maximum engine braking when going down steep hills.

#### NOTE:

*If you move the shift lever to a lower gear while driving faster than the maximum allowable speed for the lower gear, the transmission will not actually downshift until your speed drops below the maximum speed for the lower gear.*

### ⚠ CAUTION

Be sure to take the following precautions to help avoid damage to the automatic transmission:

- Make sure that the vehicle is completely stopped before shifting into "P" or "R".
- Do not shift from "P" or "N" to "R", "D", "2", or "L" when the engine is running above idle speed.
- Do not rev the engine with the transmission in a drive position ("R", "D", "2", or "L") and the rear wheels not moving.
- Do not use the accelerator pedal to hold the vehicle on a hill. Use the vehicle's brakes.

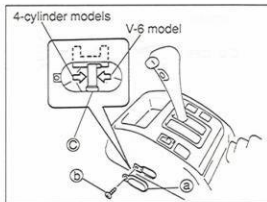

16-65D058A

### Emergency Shifting out of "P" (Park)

Vehicles with an automatic transmission have an electrically operated park-lock feature. If the vehicle's battery is discharged, or there is some other electrical failure, the automatic transmission cannot be shifted out of Park in the normal way. Jump starting may correct the condition. If not, follow the procedure described below. This procedure will permit shifting the transmission out of Park.

If you are unable to shift the transmission out of Park in the normal manner:

- 1) Be sure the parking brake is firmly applied.
- 2) Remove the access hole cover (a) by unfastening the screw (b) with a Phillips Screwdriver.
- 3) If the engine is running, stop the engine.
- 4) Make sure the key is in the "ON" or "ACC" position.
- 5) Move the release cam (c) forward for V-6 model or rearward for 4-cylinder model.
- 6) While holding the release cam (c) in the moved position, shift the transmission lever to the desired position.
- 7) Replace the access hole cover (a) and the screw (b).

This procedure is for emergency use only. If repeated use of this procedure is necessary, or the procedure does not work as described, take the vehicle to your dealer for repair.

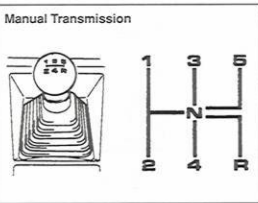

### Manual Transmission Starting Off

To start off, push in the clutch pedal and shift into 1st gear. After releasing the parking brake, gradually release the clutch. When you hear a change in the engine's sound, slowly press the accelerator while continuing to gradually release the clutch.

### Shifting

All forward gears are synchronized, which provides for quiet, easy shifting. Always push in the clutch pedal fully before shifting gears. The table shows the maximum allowable speed for each gear.

### 2-Wheel drive model and transfer gear in "2H" or "4H" position

GEAR	MAXIMUM SPEED
First	25 mph (41 km/h)
Second	48 mph (78 km/h)
Third	68 mph (110 km/h)
Fourth	94 mph (152 km/h)
Fifth	Vehicle top speed

### Transfer gear in "4L" position

GEAR	MAXIMUM SPEED
First	14 mph (23 km/h)
Second	27 mph (43 km/h)
Third	38 mph (61 km/h)
Fourth	52 mph (84 km/h)
Fifth	Vehicle top speed

65D-0610-A0E

## USING THE TRANSFER LEVER (if equipped)

### ⚠ WARNING

- \* Reduce your speed and downshift to a lower gear before going down a long or steep hill. Downshifting will allow the engine to provide braking. Avoid riding the brakes or they may overheat, resulting in brake failure.
- \* When driving on slippery roads, be sure to slow down before downshifting. Large and sudden changes in engine speed may cause loss of traction, which could cause you to lose control.
- \* Make sure that the vehicle is completely stopped before you shift into reverse.

### ⚠ CAUTION

- \* To help avoid clutch damage, do not use the clutch pedal as a foot-rest while driving or use the clutch to keep the vehicle stationary on a hill. Depress the clutch fully when shifting.
- \* When changing gears or starting off, do not race the engine. Racing the engine can shorten engine life and prevent smooth shifting.

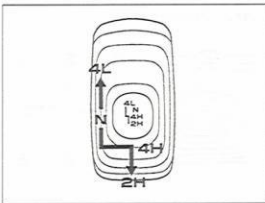

05-65D161A

Your vehicle is equipped with the Drive Select 4 x 4 system that consists of a transfer case with a synchronizer (between "2H" and "4H" gears) and the Free axle mechanism in the front differential case. With this feature, you can switch the drive mode between 2-wheel drive high range and 4-wheel drive high range by operating the transfer lever even when the vehicle is moving, provided the front wheels are in the straight ahead position and the speed is less than 100 km (60 mph).

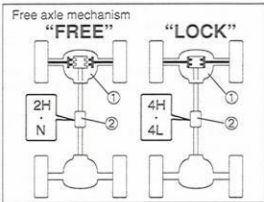

05-65D241A

- ① Front differential case
- ② Transfer case

### Description of Transfer Lever Positions 2H (2-Wheel Drive High Range)

In this position, engine power is supplied to the rear axle only. Use this position for normal driving on dry, hard surfaces.

### 4H (4-Wheel Drive High Range)

In this position, engine power is supplied to the front and rear axles at normal speed, providing greater traction than 2-wheel drive. Use this position for offroad driving, or for driving on slippery roads (wet, snow-covered, muddy, etc.)

**N (Neutral)**

In this position, engine power is not supplied to the front or rear axles. Only use this position for towing your vehicle.

**4L (4-Wheel Drive Low Range)**

In this position, engine power is supplied to the front and rear axles at reduced speed. Use this position for off-road driving on soft or slippery surfaces, or for climbing or descending steep, slippery hills.

**Transfer Lever Operation**

Shift the transfer lever according to the appropriate procedure described below:

**From 2H to 4H**

You can shift the transfer lever either when the vehicle is stopped or while the vehicle is moving.

Position the front wheels straight ahead and shift into "4H". If the vehicle is moving, the speed must be less than 100 km (60mph) during this operation.

**From 4H to 4L**

Stop the vehicle completely, place the transmission in "N" (Neutral) or depress the clutch pedal fully (if equipped), then shift into "4L".

**From 4L to 4H**

Stop the vehicle completely, place the transmission in "N" (Neutral) or depress the clutch pedal fully (if equipped), then shift into "4H".

**From 4H to 2H**

You can shift the transfer lever either when the vehicle is stopped or while the vehicle is moving.

Position the front wheels straight ahead and shift into "2H". If the vehicle is moving, the speed must be less than 100 km (60 mph) during this operation.

**NOTE:**

*If it is difficult to shift between "2H" and "4H" while the vehicle is moving, stop the vehicle and operate the transfer lever.*

**NOTE:**

*If your vehicle has an automatic transmission, it is recommended that you stop the engine when shifting the transfer lever between "4H" and "4L". If you shift the transfer lever between "4H" and "4L" with the engine running, be sure to shift using a quick, continuous motion, without pausing in Neutral.*

**⚠ CAUTION**

- \* Be sure to stop the vehicle completely when shifting the transfer lever between "4H" and "4L".
- \* Do not shift between "2H" and "4H" unless the front wheels are in the straight-ahead position and the vehicle speed is less than 100 km (60 mph).
- \* Do not operate your vehicle in "4H" or "4L" on dry, hard surfaces.
- \* Make sure that you have shifted completely into "4H" or "4L" by observing that the 4WD indicator is lit.

**⚠ WARNING**

Make sure that the transfer lever is fully engaged. Loss of power or transfer case damage can result from failure to completely engage a position. Be sure to completely familiarize yourself with the gearshift operation of your vehicle.

## BRAKING

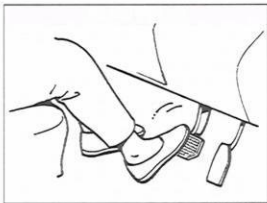

06-60G165A

The distance needed to bring any vehicle to a halt increases with the speed of the vehicle. The braking distance needed, for example, at 37 mph (60 km/h) will be approximately 4 times greater than the braking distance needed at 19 mph (30 km/h). Start to brake the vehicle when there is plenty of distance between your vehicle and the stopping point, and slow down gradually.

**⚠ WARNING**

If water gets into the brake drums, brake performance may become poor and unpredictable. After driving through water or washing the underside of the vehicle, test the brakes

(Continued)

(Continued)

while driving at a slow speed to see if they have maintained their normal effectiveness. If the brakes are less effective than normal, dry them by repeatedly applying the brakes while driving slowly until the brakes have regained their normal effectiveness.

**Power assisted brakes**

Your vehicle has power assisted brakes. If power assistance is lost due to a stalled engine or other failures, the system is still fully operational on reserve power and you can bring the vehicle to a complete stop by pressing the brake pedal once and holding it down. The reserve power is partly used up when you depress the brake pedal and reduces each time the pedal is pressed. Apply smooth and even pressure to the pedal. Do not pump the pedal.

**⚠ WARNING**

Even without reserve power in the brake system, you can still stop the vehicle by pressing the brake pedal harder than normally required. However, the stopping distance may be longer.

**Anti-Lock Brake System (ABS) (if equipped)** ABS will help you avoid skidding by electronically controlling braking pressure. It will also help you maintain steering control when braking on slippery surfaces or when braking hard.

The ABS works automatically, so you do not need any special braking technique. Just push the brake pedal down without pumping. The ABS will operate whenever it senses that the wheels are locking up.

You may feel the brake pedal pulsate while the ABS is operating.

**NOTE:**

*The ABS will not work if vehicle speed is under 3 – 4 mph (5 – 6 km/h).*

**▲ WARNING**

- \* On some types of loose surfaces (such as gravel, snow-covered roads, etc.), the stopping distance required for an ABS-equipped vehicle may be slightly greater than for a comparable vehicle with a conventional brake system. With a conventional brake system, skidding tires are able to "plow" the gravel or snow layer, shortening the stopping distance. ABS minimizes this resistance effect. Allow for extra stopping distance when driving on loose surfaces.
- \* On regular paved roads, some drivers may be able to obtain slightly shorter stopping distances with conventional brake systems than with ABS.
- \* In both of the above conditions, ABS will still offer the advantage of helping you maintain directional control. However, remember that ABS will not compensate for bad road or weather conditions or poor driver judgment. Use good judgment and do not drive faster than conditions will safely allow.

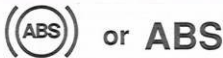

06-50G116A

**▲ WARNING**

- \* If the ABS warning light (ⓘ or ABS) on the instrument panel comes on and stays on while driving, there may be a problem with the ABS system.  
If this happens:
  - 1) Pull off the road and stop carefully.
  - 2) Turn the ignition switch to "LOCK" and then start the engine again.
 If the warning light comes on briefly then turns off, the system is normal. If the warning light still stays on, have the system inspected by your SUZUKI dealer immediately. If the ABS system becomes inoperative, the brake system will function as an ordinary brake system that has no ABS.

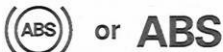

06-83E091A

**▲ WARNING**

(For V6 engine models)  
If the ABS warning light (ⓘ or ABS) and the Brake system warning light (ⓘ) on the instrument panel simultaneously stay on or come on when driving, both anti-lock function and rear brake force control function (Proportioning valve function) of the ABS system may have failed. This could cause the rear wheels to skid or the vehicle to spin during braking on a slippery road or hard braking on a dry paved road. If both warning lights come on, drive carefully, avoiding hard braking as much as possible,

(Continued)

## BREAK-IN

**⚠ WARNING**

(Continued)

and ask your SUZUKI dealer to inspect the ABS system immediately.

**How the ABS works:**

A computer continuously monitors wheel speed. The computer compares the changes in wheel speed when braking. If the wheels slow suddenly, indicating a skidding situation, the computer will change braking pressure several times each second to prevent the wheels from locking. When you start your vehicle or when you accelerate after a hard stop, you may hear a momentary motor or clicking noise as the system resets or checks itself.

**⚠ WARNING**

The ABS may not work properly if tires or wheels other than those specified in the owner's manual are used. This is because the ABS works by comparing changes in wheel speed. When replacing tires or wheels, use only the size and type specified in this owner's manual.

**⚠ CAUTION**

The future performance and reliability of the engine depends on the care and restraint exercised during its early life. It is especially important to observe the following precautions during the initial 600 miles of vehicle operation.

- \* After starting, do not race the engine. Warm it up gradually.
- \* Avoid prolonged vehicle operation at a constant speed. Moving parts will break in better if you vary your speed.
- \* Start off from a stop slowly. Avoid full throttle starts.
- \* Avoid hard stopping, especially during the first 200 miles (320 km) of driving.
- \* Do not drive slowly with the transmission in a high gear.
- \* Drive the vehicle at moderate engine speeds.
- \* Do not tow a trailer during the first 600 miles of vehicle operation.

## CATALYTIC CONVERTER

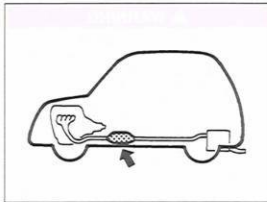

06-60A181A

The purpose of the catalytic converter is to minimize the amount of harmful pollutants in your vehicle's exhaust. Use of leaded fuel in vehicles equipped with catalytic converters is prohibited by federal law, because lead deactivates the pollutant-reducing components of the catalyst system.

The converter is designed to last the life of the vehicle under normal usage and when unleaded fuel is used. No special maintenance is required on the converter. However, it is very important to keep the engine properly tuned. Engine misfiring, which can result from an improperly tuned engine, may cause overheating of the catalyst. This may result in permanent heat damage to the catalyst and other vehicle components.



65D-0608-A0E

## IMPROVING FUEL ECONOMY

The following instructions will help you improve fuel economy.

**Avoid excessive idling:**

If you are to wait for more than a minute while you are parked, stop the engine and start it again later. When warming up a cold engine, allow the engine to idle until the temperature gauge pointer comes up to the "C" position. In this position, the engine is sufficiently warm for starting off.

**Avoid "jackrabbit" starts:**

Fast starts away from lights or stop signs will consume fuel unnecessarily and shorten engine life. Start off slowly.

**Avoid unnecessary stops:**

Avoid unnecessary deceleration and stopping. Try to maintain a slow, steady speed whenever possible. Slowing down and then accelerating again uses more fuel.

**Keep a steady cruising speed:**

Keep as constant a speed as road and traffic conditions will permit.

**CAUTION**

To minimize the possibility of catalyst or other vehicle damage:

- \* Maintain the engine in the proper operating condition.
- \* In the event of an engine malfunction, particularly one involving engine misfire or other apparent loss of performance, have the vehicle serviced promptly.
- \* Do not shut off the engine or interrupt the ignition when the transmission is in gear and the vehicle is in motion.
- \* Do not try to start the engine by pushing or towing the vehicle, or coasting down a hill.
- \* Do not idle the engine with any spark plug wires disconnected or removed, such as during diagnostic testing.
- \* Do not idle the vehicle for prolonged periods if idling seems rough or there are other malfunctions.
- \* Do not allow the fuel tank to get near the empty level.



06-60A588A

**WARNING**

Be careful where you park and drive; the catalytic converter and other exhaust components can get very hot. As with any vehicle, do not park or operate this vehicle in areas where combustible materials such as dry grass or leaves can come in contact with a hot exhaust system.

### EXAMPLE

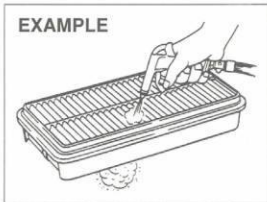

06-60A183A

#### **Keep the air cleaner clean:**

A dirty air cleaner will cause the fuel injection system to supply too much fuel to the engine for the amount of air being supplied. The result is waste of fuel due to incomplete fuel burning.

#### **Keep weight to a minimum:**

The heavier the load, the more fuel the vehicle consumes. Take out any luggage or cargo when it is not necessary.

#### **Keep tire pressure correct:**

Underinflation of the tires can waste fuel due to increased running resistance of the tires. Keep your tires inflated to the correct pressure shown on the label located below the driver's side door latch striker.

65D-0707-A0E

## IMPORTANT VEHICLE DESIGN FEATURES TO KNOW



07-65D231A

### WARNING

- \* **Wear Your Seat Belts at All Times.** Even though air bags are equipped at the front seating positions, the driver and all passengers should be properly restrained at all times, using the seatbelts provided. Refer to the "SEATBELTS AND CHILD RESTRAINT SYSTEMS" section for instructions on proper use of the seat belts.
- \* **Never drive while under the influence of alcohol or other drugs.** Alcohol and drugs can seriously impair your ability to drive safely, greatly increasing the risk of injury to yourself and others. You should also avoid driving when you are tired, sick, irritated, or under stress.

### WARNING

Your multipurpose vehicle has handling characteristics that differ from those of a conventional passenger car. For the safety of you and your passengers, please read the following section very carefully.

Multipurpose vehicles such as your new SUZUKI have higher ground clearance and a narrower track than conventional passenger cars, to make them capable of performing in a wide variety of off-road applications. Specific design characteristics give them a higher center of gravity than ordinary cars. An advantage of the higher ground clearance is a better view of the road allowing you to anticipate problems. They are not designed for cornering at the same speed as conventional passenger cars any more than low-slung sports cars are designed to perform satisfactorily under off-road conditions. If at all possible, avoid sharp turns or abrupt maneuvers. As with other vehicles of this type, failure to operate this vehicle correctly may result in loss of control or vehicle rollover.

Multipurpose vehicles have a significantly higher rollover rate than other types of vehicles.

## EXAMPLE



07-65D218A

In a rollover crash, an unbelted person is significantly more likely to die than a person wearing a seat belt.

### Important Differences Between Your Multipurpose Vehicle and Ordinary Pas- senger Cars

- \* **Higher Ground Clearance**  
The higher ground clearance of your vehicle enables it to clear off-road obstacles, such as rocks and tree stumps, that ordinary passenger cars can not drive over. An unavoidable result of this higher ground clearance is that the vehicle also has a higher center of gravity. Consequently, your vehicle will handle differently than a vehicle with a lower

65D-0705-A1E

## ON-PAVEMENT DRIVING

center of gravity.

\* **Shorter Wheelbase**

Along with its higher ground clearance, your vehicle has a shorter wheelbase and shorter front and rear overhangs than many passenger cars. These features combine to allow you to drive your vehicle over hillcrests without hanging up on them or damaging the frame and chassis components. The shorter wheelbase also makes the steering of your vehicle more responsive than that of vehicles with longer wheelbases.

\* **Narrower Body Width and Track**

Your vehicle is narrower than the average passenger car so that it can pass through tight spaces.

Without the essential characteristics described above: higher ground clearance, shorter wheelbase, and narrower body width and track — your vehicle could not provide you with excellent off road driving performance. However, it is also true that on-pavement driving, handling, and steering will be different from what drivers experience with a conventional passenger car.

Government data show that most rollover accidents for multi-purpose vehicles are caused when a driver loses control of the vehicle and leaves the paved portion of the roadway striking a ditch, curb, or other off-road object that causes the vehicle to overturn. The following driving practices may reduce the risk of rollover.

\* **Vehicle Slides Off-Road**

You can reduce the risk of this kind of rollover accident by always keeping the vehicle under control. Typically, drivers lose control of vehicles, often resulting in rollover accidents, when the driver is impaired because of alcohol or other drugs, falls asleep at the wheel or is otherwise inattentive, or is driving too fast for the road conditions.

\* **Rollovers On the Roadway**

If, for any reason, your vehicle slides sideways or spins out of control at highway speeds, while on the paved portion of the roadway, the risk of rollover is greatly increased. This condition can be created when two or more wheels drop off onto the shoulder and you steer sharply in an attempt to reenter the roadway. To reduce the risk of rollover in these circumstances, if conditions permit, you should hold the steering wheel firmly and slow down before pulling back into the

travel lanes with controlled steering movements.

\* **All Types of Rollover Accidents**

As with many kinds of automobile accidents, rollovers can be greatly reduced by doing what all prudent drivers should do, i.e., don't drink and drive, don't drive when tired, and don't do anything behind the wheel that could cause a loss of attention to the driving task.

Additional guidelines are set out below for your on-road driving.

\* **Know Your Vehicle**

Take time to familiarize yourself with the unique handling characteristics of your vehicle by first driving around in an area away from traffic. Practice turning the vehicle at a variety of speeds and in different directions. Get a feel for the greater steering response that your vehicle has over a conventional car.

\* **Wear Your Seat Belts at All Times**

The driver and all passengers should be properly restrained at all times, using the seat belts provided. Refer to the "SEAT BELTS AND CHILD RESTRAINT SYSTEMS" section for instructions on proper use of the seat belts.

### OFF-ROAD DRIVING

#### \* Don't Make Sharp Turns

As mentioned before, small multipurpose vehicles have specific design characteristics that allow them to perform in a wide variety of applications. These characteristics also change the cornering behavior relative to conventional passenger cars. Remember, small multipurpose vehicles have more responsive steering and a higher center of gravity than conventional passenger cars. If at all possible, avoid making sharp turns in your vehicle.

#### \* Slow Down on Curves

Learn to approach curves cautiously and at a conservative speed. Do not attempt to take curves at the same speeds that you would in a vehicle with a lower center of gravity. Just as you would not drive a sports car on a trail, you should not attempt to drive your vehicle around curves like a sports car.

#### \* Slow Down and Use Caution on Slippery Roads

Under wet road conditions you should drive at a lower speed than on dry roads due to possible slippage of tires during braking. When driving on icy, snowcovered, or muddy roads, reduce your speed and avoid sudden acceleration, abrupt braking, or sharp steering movements.

Use 4-wheel drive high range (4H) (if equipped) for better traction.

Your vehicle has specific design characteristics for off-road driving. When you leave the pavement, you will encounter driving surfaces of all kinds which may change continually as you drive. In most cases, off-road driving requires the use of 4-wheel drive. If your vehicle is a 2-wheel drive vehicle, you should limit your off-road driving only to hard, flat, nonslippery surfaces. 2-wheel drive vehicles have far less traction on off-road surfaces than 4-wheel drive vehicles. It is important when driving off-road to follow the guidelines below.

#### \* Use Caution on Steep Inclines

Always inspect hills before you attempt to drive up them. Know what is on the other side and how you will get back down. If you have any doubt that it is safe, do not attempt to drive over a hill. Never drive your vehicle up an extremely steep incline.

Coming down a steep hill can be trickier than getting up one. Keep the vehicle heading straight down the hill and use low gear. Do not lock the brakes. If the vehicle begins to slide, accelerate slightly to regain steering control.

\* **Do Not Turn on or Drive Across the Side of Hills**

Turning on or driving across the side of a hill can be extremely hazardous. Most of the vehicle's weight will be transferred to the downhill tires, which could result in the vehicle rolling sideways. Whenever possible, avoid this potential hazard. Also, if you have to exit your vehicle on a side-hill, always get out on the uphill side.

\* **Wear Your Seatbelt at all Times**

You and your passengers should use the seatbelts at all times when driving off-road. For proper seat belt use, refer to the "Seat Belts and Child Restraint Systems" section in this manual.

\* **Avoid Sudden Reactions in Mud, Ice, or Snow**

Be careful when off-road conditions are slick. Reduce your speed and avoid sudden movements of the vehicle. If your vehicle is a 2-wheel drive vehicle, do not drive in deep snow or mud. If your vehicle is a 4-wheel drive vehicle, be aware that driving in deep snow or mud can cause a loss of traction and an increase in the resistance to the vehicle's forward motion. Use 4WD low gear (4L) and maintain a steady but moderate speed with a light touch on the steering wheel and brakes.

\* **If Your Vehicle Gets Stuck**

If your vehicle gets stuck in snow, mud, or sand, follow the directions below:

- 1) Shift the transfer lever (if equipped) to "4L".
- 2) Shift the transmission back and forth between a forward range (or first gear for manual transmission) and reverse. This will create a rocking motion which may give you enough momentum to free the vehicle. Press gently on the accelerator to keep wheel spin to a minimum. Remove your foot from the accelerator while shifting.  
  
Do not race the engine. Excessive wheel spin will cause the tires to dig deeper, making it more difficult to free the vehicle.
- 3) If your vehicle remains stuck after a few minutes of rocking, get another vehicle to pull you out.

**⚠ WARNING**

Do not allow anyone to stand near the vehicle when you are rocking it, and do not spin the wheels faster than an indicated 25 mph (40 km/h) on the speedometer. Personal injury and/or vehicle damage may result from spinning the wheels too fast.

**⚠ CAUTION**

Do not continue rocking the vehicle for more than a few minutes. Prolonged rocking can cause engine overheating, transmission or transfer case damage, or tire damage.

**Tire Chains**

Tire chains should only be used if they are needed to increase traction or are required by law. Make sure that the chains you use are small-link chains or cable-type chains and are the correct size for your vehicle's tires. Also make sure that there is enough clearance between the fenders and the chains as installed on the tires.

Install the chains on the rear tires tightly, according to the chain manufacturer's instructions. Retighten the chains after driving about 1/2 mile (1.0 km) if necessary. With the chains installed, drive slowly.

**⚠ CAUTION**

If you hear the chains hitting against the vehicle body while driving, stop and tighten them.

**\* Do not drive through deep or rushing water**

Driving in deep or rushing water can be hazardous. You could lose control of the vehicle and the occupants could drown. Also, your vehicle could be seriously damaged. To avoid these risks, observe the following instructions and precautions.

- Do not drive through deep or rushing water. Deep or rushing water, such as fast-moving streams or floodwaters, could carry your vehicle away from your intended path. The water is too deep if it covers your wheel hubs, axles, or exhaust tailpipe. Know the depth of the water before you attempt to drive through it.
- If water blocks the tailpipe, the engine may not start or run. If the water is deep enough to get drawn into the engine intake system, the engine will be badly damaged.
- Submerged brakes will have poor braking performance. Drive slowly and carefully. Driving slowly will also help avoid water splashing onto the ignition system, which could cause the engine to stall.
- Even when driving through shallow or still waters, drive carefully since the water may be hiding ground hazards such as holes, ditches, or bumps.

**⚠ WARNING**

In addition to following the driving tips in this section, it is important to observe the following precautions for on-road and off-road driving.

- \* Driver and passengers should wear seat belts at all times.
- \* Do not let anyone else drive your vehicle unless they are also aware of the vehicle characteristics and handling differences described in this section.
- \* Avoid loaning your vehicle to anyone unless you accompany them.
- \* Make sure your tires are in good condition and always maintain the specified tire pressure. Refer to "TIRES" in the "INSPECTION AND MAINTENANCE" section for details.
- \* Do not use tires other than those specified by SUZUKI. Never use different sizes or types of tires on the front and rear wheels. For information regarding the specified tires, refer to the Tire Inflation Pressure Label located on the driver's side door pillar or the "SPECIFICATIONS" section.

(Continued)

(Continued)

- \* Never use oversized tires or special shocks and springs to raise (jack up) your vehicle. This will raise the center of gravity of the vehicle and change its handling characteristics. Oversized tires may also rub against the fender over bumps, causing vehicle damage or tire failure.
- \* After driving through water, mud, or sandy ground, test the brakes while driving at a slow speed to see if they have maintained their normal effectiveness. If the brakes are less effective than normal, dry them by repeatedly applying the brakes while driving slowly until the brakes have regained their normal effectiveness.
- \* Do not use 4-wheel drive for normal driving on dry, hard surfaced roads.
- \* After extended operation in mud, sand, or water, have the brakes inspected by your authorized SUZUKI dealer as soon as possible.

65D-0804-A0E

## VEHICLE LOADING

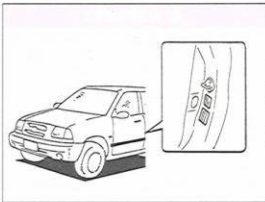

08-65D033A

Your vehicle was designed for specific weight capacities. The weight capacities of your vehicle are indicated by the Gross Vehicle Weight Rating (GVWR) and the Gross Axle Weight Rating (GAWR, front and rear). The GVWR and GAWR (front and rear) are listed on the Safety Certification Label which is located below the driver's side door latch striker.

- GVWR – Maximum permissible overall weight of the vehicle including the driver, passengers, and all cargo.
- GAWR – (Front and Rear) Maximum permissible weight on an individual axle.

Actual weight of the loaded vehicle and actual loads at the front and rear axles can only be determined by weighing the vehicle. Compare these weights to the GVWR and GAWR (front and rear) listed on the Safety Certification Label. If the gross vehicle weight or the load on either axle exceeds these ratings, you must remove enough weight to bring the load down to the rated capacity.

**⚠ WARNING**

Never overload your vehicle. The gross vehicle weight (sum of the weights of the loaded vehicle, driver, and passengers) must never exceed the Gross Vehicle Weight Rating (GVWR) listed on the Safety Certification Label. In addition, never distribute a load so that the weight on either the front or rear axle exceeds the Gross Axle Weight Rating (GAWR) listed on the Safety Certification Label.

**⚠ WARNING**

Always distribute cargo evenly. To avoid personal injury or damage to your vehicle, always secure cargo to prevent it from shifting if the vehicle moves suddenly. Place heavier objects on the floor and as far forward in the cargo area as possible. Never pile cargo higher than the top of the seat backs.



### TRAILER TOWING

You can use your SUZUKI to tow a light trailer (class 1), but you should always observe the requirements and recommendations in this section. If you intend to tow a trailer, it is essential to select a trailer and trailer towing equipment which are compatible. A reputable trailer dealer can help you.

#### CAUTION

Trailer towing puts additional stress on the engine, drive train and brakes of your vehicle. Never tow a trailer during the first 600 miles of vehicle operation.

#### CAUTION

Because towing a trailer puts additional stress on your vehicle, more frequent maintenance will be required than under normal driving conditions. Follow the schedule for Maintenance Recommended Under Severe Driving Conditions.

#### Hitches

Use only a trailer hitch bracket that is designed to bolt to the frame of your vehicle, and a class 1 hitch that is designed to bolt to this bracket. We recommend that you use a genuine SUZUKI trailer hitch bracket and trailer hitch (available as options), or equivalent.

#### WARNING

Never use a bumper hitch or a hitch which attaches to the axle of your vehicle.

#### Safety Chains

Always attach safety chains between your vehicle and trailer. Cross safety chains under the tongue of the trailer so that the tongue will not drop to the road if the trailer becomes separated from the hitch. Follow the manufacturer's recommendation for attaching safety chains. Always leave just enough slack to permit full turning. Never allow safety chains to drag on the road.

#### WARNING

Never attach safety chains to the bumper of your vehicle. Secure connections so that they can't come loose.

#### Trailer Lights

Make sure your trailer is equipped with lights which meet federal, state, and local requirements. Always check for the proper operation of all trailer lights before you start to tow.

#### WARNING

Never splice trailer lights directly into your vehicle's electrical system, or electrical system damage may occur.

#### Brakes

#### WARNING

If trailer brakes are used, you should follow all instructions provided by the manufacturer. Never tap into the brake system of your vehicle.

## Tires

**WARNING**

When towing a trailer, it is very important for your vehicle and trailer to have properly inflated tires. Your vehicle's tires should be inflated to the laden pressures listed on your vehicle's Tire Inflation Pressure label. Inflate trailer tires according to the specifications provided by the trailer manufacturer.

**Mirrors**

Check to see if your vehicle's mirrors meet federal, state, and local requirements for mirrors used on towing vehicles. If they do not, you must install required mirrors before you tow.

**Vehicle/Trailer Weight Limits**

Before towing, you must make sure that gross trailer weight, gross combined weight, trailer tongue weight, gross vehicle weight, and gross axle weight (front and rear) are within specified limits as described below. You can measure vehicle and trailer weights using a vehicle scale and can measure tongue weight using a bathroom scale.



08-60A378A

Gross Trailer Weight is the weight of the trailer plus all cargo in it (measured with the trailer disconnected from the towing vehicle). Gross trailer weight must never exceed:

- 2-Door Model – 1,000 pounds (450 kg)
- 4-Door Model – 1,500 pounds (680 kg)

If you have a 4-door model and intend to tow a trailer having a gross trailer weight greater than 1,000 pounds (450 kg), the trailer must be equipped with trailer brakes.

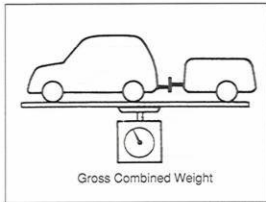

08-60A381A

Gross Combined Weight is the weight of the fully loaded vehicle (including driver, passengers, and cargo) plus the weight of the fully loaded trailer. Gross combined weight must never exceed:

- 2-Door Model
  - 1.6ℓ 2WD 4,350 pounds (1,980 kg)
  - 1.6ℓ 4WD 4,500 pounds (2,030 kg)
  - 2.0ℓ 2WD 4,500 pounds (2,030 kg)
  - 2.0ℓ 4WD 4,600 pounds (2,080 kg)
- 4-Door Model
  - 2.0ℓ 2WD 5,300 pounds (2,410 kg)
  - 2.0ℓ 4WD 5,400 pounds (2,460 kg)
  - 2.5ℓ 2WD 5,500 pounds (2,490 kg)
  - 2.5ℓ 4WD 5,600 pounds (2,550 kg)

Tongue Weight is the downward force exerted on the hitch by the trailer coupler, with the trailer fully loaded and the coupler at its

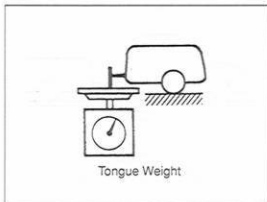

08-60A380A

normal towing height. Cargo should be distributed so that tongue weight is approximately 10% of gross trailer weight.

**NOTE:**

*You can usually get tongue weight to be about 10% of gross trailer weight by placing about 60% of the total cargo weight in the front half of the trailer. You should measure gross trailer weight and tongue weight before towing, however, to make sure that your load is properly distributed.*

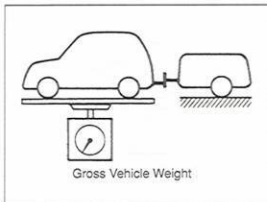

08-60A379A

Gross Vehicle Weight is the weight of the fully loaded vehicle (including driver, passengers and cargo) plus the trailer tongue weight. The gross vehicle weight must never exceed the Gross Vehicle Weight Rating (GVWR) listed on the Safety Certification Label.

Gross Axle Weight (Front and Rear) is the weight supported by an individual axle with the vehicle fully loaded and the trailer connected. Gross axle weight for the front and rear axles must never exceed the Gross Axle Weight Rating (GAWR) listed on the Safety Certification Label.

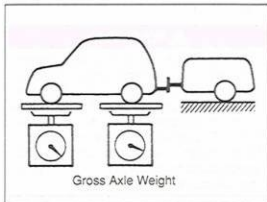

08-60A382A

**WARNING**

Improper distribution of cargo in your trailer may result in poor vehicle handling and swaying of the trailer. Always make sure that trailer tongue weight is about 10% of gross trailer weight. Failure to observe this requirement may result in an accident.

**⚠ WARNING**

Never overload your trailer or your vehicle. Gross trailer weight must never exceed 1,000 pounds (450 kg) for 2-door models or 1,500 pounds (680 kg) for 4-door models. Gross combined weight must never exceed:

**2-Door Model**

- 1.6ℓ 2WD 4,350 pounds (1,980 kg)
- 1.6ℓ 4WD 4,500 pounds (2,030 kg)
- 2.0ℓ 2WD 4,500 pounds (2,030 kg)
- 2.0ℓ 4WD 4,600 pounds (2,080 kg)

**4-Door Model**

- 2.0ℓ 2WD 5,300 pounds (2,410 kg)
- 2.0ℓ 4WD 5,400 pounds (2,460 kg)
- 2.5ℓ 2WD 5,500 pounds (2,490 kg)
- 2.5ℓ 4WD 5,600 pounds (2,550 kg)

Gross vehicle weight must never exceed the Gross Vehicle Weight Rating (GVWR) listed on the Safety Certification Label. Gross axle weight for the front and rear axles must not exceed the Gross Axle Weight Rating (GAWR) listed on the Safety Certification Label.

**⚠ WARNING**

Do not tow a trailer having a gross trailer weight greater than 1,000 pounds (450 kg) unless the trailer is equipped with trailer brakes.

**Additional Trailer Towing Warnings****⚠ WARNING**

Connect trailer lights and hook up safety chains every time you tow.

**⚠ WARNING**

Your vehicle will handle differently when towing a trailer. For your safety and the safety of others, you should observe the following precautions:

- \* Practice turning, stopping, and backing up before you begin towing in traffic. Do not tow in traffic until you are confident that you can handle the vehicle and trailer safely.
- \* Never exceed posted towing speed limits or 45 mph (72 km/h), whichever is lower.
- \* Always have someone guide you when backing.

(Continued)

(Continued)

- \* Allow adequate stopping distance. Stopping distance is increased when you tow a trailer. For each 10 mph (16 km/h) of speed, allow at least one vehicle and trailer length between you and the vehicle ahead. Follow at a greater distance if roads are wet or slippery.
- \* Slow down when making turns. Remember that a larger than normal turning radius is needed because the trailer wheels will be closer than the vehicle wheels to the inside of the turn.
- \* Avoid sudden acceleration and stopping of the vehicle. Do not make quick maneuvers unless they are necessary.
- \* Slow down in cross winds and be prepared for wind blasts from large passing vehicles.
- \* Be careful when passing other vehicles. Be sure to allow enough room for your trailer before you change lanes, and signal well in advance.

(Continued)

## **⚠ WARNING**

(Continued)

- \* Slow down and shift into a lower gear before you reach long or steep downhill grades. It is hazardous to attempt downshifting while you are descending a hill.
- \* Avoid "riding" the brakes. "Riding" the brakes could cause the brakes to overheat, resulting in reduced braking efficiency. Use engine braking as much as possible.
- \* Because of the added trailer weight, your engine may overheat on hot days when going up long or steep hills. Pay attention to your engine temperature gauge. If it indicates overheating, pull off the road and stop in a safe place. Refer to the "ENGINE OVERHEATING" section for details on how to proceed.

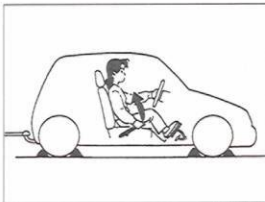

08-60A186A

## **⚠ WARNING**

When parking your vehicle and connected trailer, always use the following procedure:

- 1) Apply the vehicle's brakes firmly.
- 2) Have another person place wheel chocks under the wheels of the vehicle and the trailer while you are holding the brakes.
- 3) Slowly release the brakes until the wheel chocks absorb the load.
- 4) Fully engage the parking brake.
- 5) Manual Transmission – Shift into Reverse or first gear and turn off the engine.

(Continued)

(Continued)

**Automatic Transmission –** Shift into Park and turn off the engine.

When starting out after parking:

- 1) Push in the clutch (if equipped) and start the engine.
- 2) Depress the brake pedal, shift into gear, release the parking brake, and slowly pull away from the chocks.
- 3) Stop, apply the brakes firmly, and hold the brakes while you have another person remove the chocks.

65D-0805-A0E

## TOWING YOUR VEHICLE (RECREATIONAL TOWING)

Your vehicle may be towed behind another vehicle (such as a motorhome), provided you use the proper towing method specified for your vehicle. The towing method you must use depends on the specifications of your vehicle: whether it is a 2-wheel drive (2WD) or 4-wheel drive (4WD) vehicle.

Use the towing instruction table to select the proper towing method for your vehicle, and carefully follow the corresponding instructions. Be sure to use proper towing equipment designed for recreational towing and make sure that towing speed does not exceed 55 mph (90 km/h).

### TOWING INSTRUCTION TABLE

DRIVE TRAIN	TRANSMISSION	TOWING METHOD
4WD	A/T (AUTO)	A C
	M/T (MANUAL)	B C
2WD	A/T	D
	M/T	D

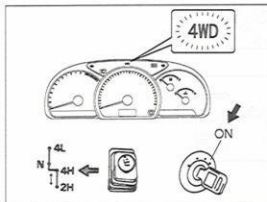

10-65D100A

### Before towing (For 4WD vehicles)

Make sure the "4WD" light on the instrument cluster comes on when the transfer lever is shifted to "4H" position and goes off when the transfer lever is shifted to "2H" position with the ignition key in the "ON" position. If the "4WD" light does not respond properly, then there may be a problem locking or unlocking the front axles, and the vehicle must be towed with the front wheels lifted and the rear wheels on a dolly.

## TOWING METHOD A

### FOUR WHEELS ON THE GROUND

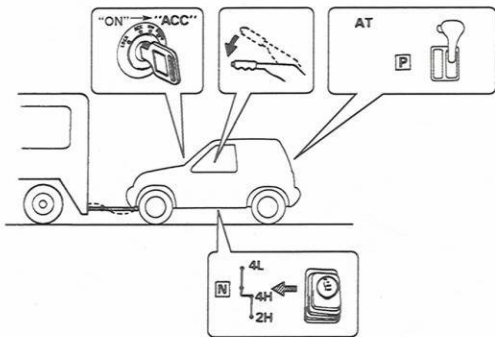

10-65D157A

### A : 4WD VEHICLES WITH AUTOMATIC TRANSMISSION

- 1) Shift the automatic transmission into "P" (Park).
- 2) Turn the ignition key to the "ON" position.
- 3) Shift the transfer lever into neutral.
- 4) Make sure the "4WD" light on the instrument cluster is off.
- 5) Turn the ignition key to the "ACC" position to unlock the steering wheel.
- 6) Release the parking brake.

Stop towing the vehicle every 200 miles (300 km). With the transfer lever still in neutral, start the engine, shift into "D" (drive) and rev the engine for about one minute to circulate oil in the transfer case. Make sure to shift into "P" (Park) before next towing.

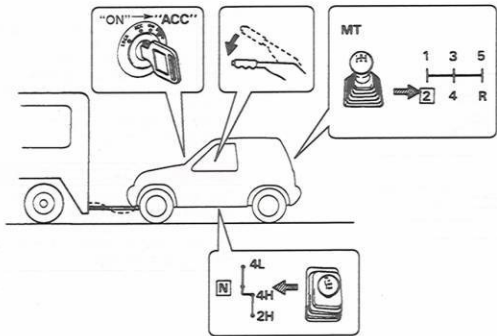
**TOWING METHOD B****FOUR WHEELS ON THE GROUND****B : 4WD VEHICLES WITH MANUAL TRANSMISSION**

- 1) Shift the manual transmission lever into 2nd gear.
- 2) Turn the ignition key to the "ON" position.
- 3) Shift the transfer lever into neutral.
- 4) Make sure the "4WD" light on the instrument cluster is off.
- 5) Turn the ignition key to the "ACC" position to unlock the steering wheel.
- 6) Release the parking brake.

Stop towing the vehicle every 200 miles (300 km). Leave the manual transmission in 2nd gear. With the transfer lever still in neutral, start the engine and rev it for about one minute with the clutch engaged to circulate oil in the transfer case.

10-65D156A



**TOWING METHOD C**

**FRONT WHEELS ON THE GROUND  
AND REAR WHEELS ON A DOLLY.**



**C : 4WD VEHICLES**

- 1) Turn the ignition key to the "ON" position.
- 2) Shift the transfer lever into neutral. Make sure the "4WD" light on the instrument cluster is off.
- 3) Secure the rear wheels on a towing dolly according to the instructions provided by the dolly manufacturer.
- 4) Turn the ignition key to the "ACC" position to unlock the steering wheel.
- 5) Make sure the front wheels are facing straight forward and secure the steering wheel with a steering wheel clamping device designed for towing.

**CAUTION**

The steering column is not strong enough to withstand shocks transmitted from the front wheels during towing. Always unlock the steering wheel before towing.

10-65D096A

**TOWING METHOD D**

**FRONT WHEELS ON THE GROUND  
AND REAR WHEELS ON A DOLLY.**

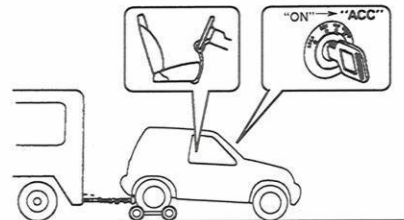

10-65D158A

**D : 2WD VEHICLES**

- 1) Secure the rear wheels on a towing dolly according to the instructions provided by the dolly manufacturer.
- 2) Turn the ignition key to the "ACC" position to unlock the steering wheel.
- 3) Make sure the front wheels are facing straight forward and secure the steering wheel with a steering wheel clamping device designed for towing.

**CAUTION**

The steering column is not strong enough to withstand shocks transmitted from the front wheels during towing. Always unlock the steering wheel before towing.



## INSPECTION AND MAINTENANCE

Maintenance Schedule .....	9-2
Periodic Maintenance Schedule .....	9-3
Maintenance Recommended Under	
Severe Driving Conditions .....	9-5
Drive Belt .....	9-7
Engine Oil and Filter .....	9-8
Gear Oil .....	9-11
Automatic Transmission Fluid .....	9-13
Engine Coolant .....	9-15
Windshield Washer Fluid .....	9-16
Air Cleaner .....	9-17
Spark Plugs .....	9-17
Brakes .....	9-19
Steering Wheel .....	9-21
Clutch Pedal .....	9-22
Tires .....	9-22
Battery .....	9-26
Fuses .....	9-26
Headlight Housing Replacement .....	9-29
Headlight Aiming .....	9-31
Bulb Replacement .....	9-32
Wiper Blades .....	9-37



09-60B128A

### ⚠ WARNING

You should take extreme care when working on your vehicle to prevent accidental injury. Here are a few precautions that you should be especially careful to observe:

- \* To prevent damage or unintended inflation of the air bag system, be sure the battery is disconnected and the ignition switch has been in the "LOCK" position for at least 90 seconds before performing any electrical service work on your SUZUKI. Do not touch air bag system components or wires.

(Continued)

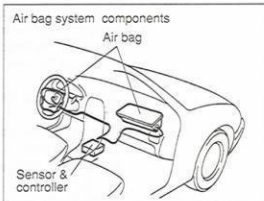

09-65D168A

(Continued)

The wires are wrapped with yellow tape or yellow tubing, and the couplers are yellow for easy identification.

- \* Do not leave the engine running in garages or other confined areas.
- \* When the engine is running, keep hands, clothing, tools, and other objects away from the moving fan and fan belt.
- \* When it is necessary to do service work with the engine running, make sure that the parking brake is

(Continued)

(Continued)

set fully and the transmission is in Neutral (for manual transmission vehicles) or Park (for automatic transmission vehicles).

- \* Do not touch ignition wires or other ignition system parts when starting the engine or when the engine is running, or you could receive an electric shock.
- \* Be careful not to touch a hot engine, exhaust manifold and pipes, muffler, radiator, and water hoses.
- \* Do not allow smoking, sparks, or flames around gasoline or the battery. Flammable fumes are present.
- \* Do not get under your vehicle if it is supported only with the portable jack provided in your vehicle.
- \* Be careful not to cause accidental short circuits between the positive and negative battery terminals.
- \* Keep used oil, engine coolant, and other fluids away from children and pets. Dispose of used fluids properly; never pour them on the ground, into sewers, etc.

65D-0902-ADE

**MAINTENANCE SCHEDULE****NOTICE (For U.S.A.)**

Maintenance, replacement or repair of the emission control devices and systems may be performed by any automobile repair establishment or individual using any part which has been certified under the provisions in the Clean Air Act sec. 207. (a) (2).

The following table shows the times when you should perform regular maintenance on your vehicle. This table shows in miles, kilometers and months when you should perform inspections, adjustments, lubrication and other services. These intervals should be shortened if driving is usually done under severe conditions (refer to Maintenance Recommended Under Severe Conditions).

**⚠ WARNING**

SUZUKI recommends that maintenance on items marked with an asterisk (\*) be performed by your authorized SUZUKI dealer or a qualified service mechanic. If you are qualified, you may perform maintenance on the unmarked items by referring to the instructions in this section. If you are not sure whether you can successfully complete any of the unmarked maintenance jobs, ask your authorized SUZUKI dealer to do the maintenance for you.

**⚠ CAUTION**

Whenever it becomes necessary to replace parts on your vehicle, it is recommended that you use genuine SUZUKI replacement parts or their equivalent.

**⚠ WARNING**

The rear shock absorbers are filled with high pressure gas. Never attempt to disassemble it or throw it into a fire. Avoid storing it near a heater or heating device. When scrapping the absorber, the gas must be released from the absorber safely. Ask your dealer for assistance.

# INSPECTION AND MAINTENANCE

6SD-0903-A4E

## PERIODIC MAINTENANCE SCHEDULE

**R: Replace or change**

**I: Inspect and correct, replace or lubricate if necessary**

Interval: This interval should be judged by odometer reading or months, whichever comes first.	miles (× 1,000)	7.5	15	22.5	30	37.5	45	52.5	60	67.5	75	82.5	90	97.5	105	112.5	120	
	Km (× 1,000)	12.5	25	37.5	50	62.5	75	87.5	100	112.5	125	137.5	150	162.5	175	187.5	200	
	months	7.5	15	22.5	30	37.5	45	52.5	60	67.5	75	82.5	90	97.5	105	112.5	120	
<b>ENGINE &amp; EMISSION CONTROL</b>																		
1. Drive belt					I					R				I				R
Tension check, *adjustment, *replacement										R				I				R
* 2. Camshaft timing belt (1.6ℓ engine models)										R				I				R
* 3. Valve lash (clearance) (1.6ℓ engine models)				I			I			I				I				I
4. Engine oil and oil filter	R	R	R	R	R	R	R	R	R	R	R	R	R	R	R	R	R	R
* 5. Cooling system hoses and connections					I					I				I				I
6. Engine coolant					R					R				R				R
* 7. Exhaust pipes and mountings					I				I&(R)					I				I&(R)
* 8. EVAP canister																		R
* 9. Emission-related hoses & tubes									I									I
10. Spark plugs									R									R
*11. Ignition wiring (1.6ℓ engine models)									R									R
*12. Ignition coil (Plug cap)					I				I					I				I
*13. Fuel tank cap					I				I					I				R
14. Air cleaner filter element					R				R					R				R
*15. Fuel filter					R				R					R				R
*16. Fuel lines and connections					I				I					I				I
*17. Canister air suction filter																		R

**NOTE:**

The maintenance services indicated by  are recommended maintenance items.  
Item 7 (R) is applicable to the exhaust mounting rubber only.

The U.S. Environmental Protection Agency or the California Air Resources Board has determined that the failure to perform recommended maintenance items, indicated by , will not nullify the emission warranty or limit recall liability prior to the completion of the vehicle's useful life. SUZUKI, however, urges that all recommended maintenance services be performed at the indicated intervals and the maintenance recorded.

**R: Replace or change****I: Inspect and correct, replace or lubricate if necessary**

Interval: This interval should be judged by odometer reading or months, whichever comes first.		miles (x 1,000)	7.5	15	22.5	30	37.5	45	52.5	60	67.5	75	82.5	90	97.5	105	112.5	120	
		Km (x 1,000)	12.5	25	37.5	50	62.5	75	87.5	100	112.5	125	137.5	150	162.5	175	187.5	200	
		months	7.5	15	22.5	30	37.5	45	52.5	60	67.5	75	82.5	90	97.5	105	112.5	120	
<b>CHASSIS AND BODY</b>																			
1.	Clutch (For manual transmission)																		
	Fluid level check		I	I	I	I	I	I	I	I	I	I	I	I	I	I	I	I	I
*2.	Brake discs and pads (front)																		
	Brake drums and shoes (rear)																		
*3.	Brake hoses and pipes																		
4.	Brake fluid Level check, *replacement									R									R
5.	Brake pedal Stroke check, *adjustment																		
6.	Parking brake lever and *cable																		
	Lever movement check, *adjustment																		
7.	Tires (including tire rotation)		I	I	I	I	I	I	I	I	I	I	I	I	I	I	I	I	I
*8.	Wheel discs		I	I	I	I	I	I	I	I	I	I	I	I	I	I	I	I	I
*9.	Wheel bearings		I	I	I	I	I	I	I	I	I	I	I	I	I	I	I	I	I
*10.	Suspension system		I	I	I	I	I	I	I	I	I	I	I	I	I	I	I	I	I
*11.	Propeller shafts/Drive shafts		I	I	I	I	I	I	I	I	I	I	I	I	I	I	I	I	I
*12.	Manual transmission oil		I			R				R				R					R
13.	Automatic transmission (A/T)																		
	Fluid level		I	I	I	I	I	I	I	I	I	I	I	I	I	I	I	I	I
	*Fluid change		Replace every 100,000 miles (166,000 km)-----4-speed A/T																
	*Fluid hose							R							R				
*14.	Transfer oil		I							R									R
*15.	Differential oil		*R																
16.	Steering system																		
	Steering wheel movement, *linkage		I	I	I	I	I	I	I	I	I	I	I	I	I	I	I	I	I
*17.	Power steering (if equipped)		I	I	I	I	I	I	I	I	I	I	I	I	I	I	I	I	I
18.	All Latches, Hinges and Locks		I	I	I	I	I	I	I	I	I	I	I	I	I	I	I	I	I
19.	Air conditioner filter (if equipped)					R				R				R					R

Item 9 \*I — inspect for wear and proper lubrication.

Item 12 \*I, Item 14 \*I and Item 15 \*R — perform at 135,000 miles (225,000 km) or 135 months after 120,000 mile/200,000 km/120 month maintenance service.



## INSPECTION AND MAINTENANCE

6SD-0904-A1E

### MAINTENANCE RECOMMENDED UNDER SEVERE DRIVING CONDITIONS

If the vehicle is usually used under the conditions corresponding to any severe condition code given below, it is recommended that applicable maintenance operation be performed at the particular interval shown in the chart below.

#### Severe condition code

**A** — Repeated short trips

**B** — Driving on rough and/or muddy roads

**C** — Driving on dusty roads

**D** — Driving in extremely cold weather and/or on salted roads

**E** — Repeated short trips in extremely cold weather

**H** — Towing a trailer

Severe Condition Code	Maintenance	Maintenance Operation	Maintenance Interval
A — C D E H	Engine oil and oil filter	R	Every 3,000 miles (5,000 km) or 3 months
A B — D — H	Exhaust pipes and mountings	I	Every 6,000 miles (10,000 km) or 6 months
— — C — — —	Air cleaner filter element *1	I	Every 3,000 miles (5,000 km) or 3 months
		R	Every 15,000 miles (25,000 km) or 15 months
— — — D — —	Ignition wiring *2 (SOHC engine models)	I	Every 15,000 miles (25,000 km) or 15 months
— — C — — —	Canister air suction filter	R	Every 60,000 miles (100,000 km) or 60 months
A B C — — H	Brake discs and pads (Front) Brake drums and shoes (Rear)	I	Every 6,000 miles (10,000 km) or 6 months
— B — D E H	Propeller shafts/Drive shafts	I	Every 6,000 miles (10,000 km) or 6 months

#### NOTE:

*I* — Inspect and correct or replace if necessary

*T* — Tighten to the specified torque

*R* — Replace or change

*L* — Lubricate

\*1 Inspect more frequently if the vehicle is used under dusty conditions.

\*2 In areas where road salt is used, inspect and clean the distributor cap and ignition wiring more frequently.

Severe Condition Code	Maintenance	Maintenance Operation	Maintenance Interval
— B — — E H	Manual transmission oil	R	Every 15,000 miles (25,000 km) or 15 months
— B — — E H	Automatic transmission (A/T) fluid	R	Every 15,000 miles (25,000 km) or 15 months
— B — — E H	Transfer and differential oil	R	Every 15,000 miles (25,000 km) or 15 months
— B — — — —	Bolts and nuts on suspension	T	Every 6,000 miles (10,000 km) or 6 months
— B C — — —	Drive belt	I	Every 15,000 miles (25,000 km) or 15 months
— — C D — —	Air conditioner filter element*2	I	Every 6,000 miles (10,000 km) or 6 months
		R	Every 30,000 miles (50,000 km) or 30 months

**NOTE:**

*I — Inspect and correct or replace if necessary*

*T — Tighten to the specified torque*

*R — Replace or change*

*L — Lubricate*

*\*2 Clean more frequently if the air flow from the air conditioner decreases.*

## DRIVE BELT

**⚠ WARNING**

When the engine is running, keep hands, hair, clothing, tools, etc. away from the moving fan and drive belts.

Make sure the drive belt tension is correct. If the belt is too loose, insufficient battery charging, engine overheating, poor power steering, poor air conditioning, or excessive belt wear can result. When you press the belt with your thumb midway between the pulleys, there should be a deflection according to the following chart.

The belts should also be examined to ensure that they are not damaged.

(For L4 2.0ℓ Engine)

Check the accessory drive belt only for damage. You do not need check it for tension as it has an automatic tensioner.

If you need to replace or adjust the belt have it done by your SUZUKI dealer.

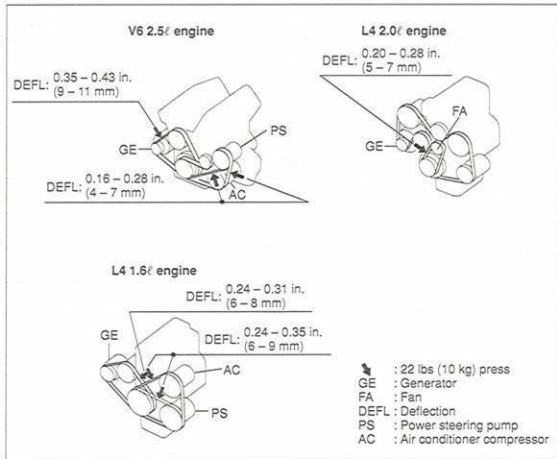

65D-0906-A1E

## ENGINE OIL AND FILTER

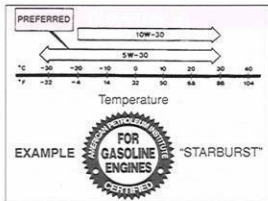
**Specified oil**

Use engine oil with the American Petroleum Institute Certified For Gasoline Engines "Starburst" symbol.

Select the appropriate oil viscosity according to the above chart.

We highly recommend you use SAE5W-30 oil.

**CAUTION**

Failure to use the recommended oil can result in engine damage.

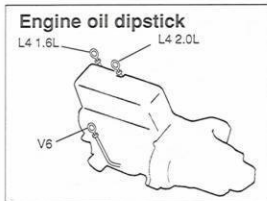
**Oil Level Check**

It is important to keep the engine oil at the correct level for proper lubrication of your vehicle's engine. Check the oil level with the vehicle on a level surface. The oil level indication may be inaccurate if the vehicle is on a slope. The oil level should be checked either before starting the engine or at least 5 minutes after stopping the engine.

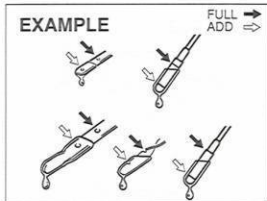

Pull out the oil dipstick, wipe oil off with a clean cloth, insert the dipstick all the way into the engine, then remove it again. The oil on the stick should be between the upper and lower limits shown on the stick.

If the oil level indication is near the lower limit, add enough oil to raise the level to the upper limit.

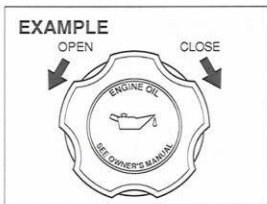

### Refilling

Remove the oil filler cap and pour oil slowly through the filler hole to bring the oil level to the upper limit on the dipstick. Be careful not to overfill. Too much oil is almost as bad as too little oil. After refilling, start the engine and allow it to idle for about a minute. Stop the engine, wait about 5 minutes and check the oil level again.

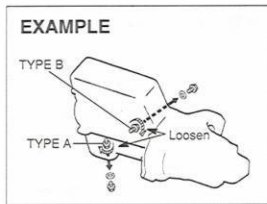

### Changing Engine Oil and Filter

Drain the engine oil while the engine is still warm.

- 1) Remove the oil filler cap.
- 2) Place a drain pan under the drain plug.
- 3) Using a wrench, remove the drain plug and drain out the engine oil.

### ⚠ WARNING

The engine oil temperature may be high enough to burn your fingers when the drain plug is loosened. Wait until the drain plug is cool enough to touch with your bare hands.

### ⚠ WARNING

New and used oil and solvent can be hazardous. Children and pets may be harmed by swallowing new or used oil or solvent. Continuous contact with used engine oil has been found to cause skin cancer in laboratory animals. Brief contact with used oil or solvent may irritate skin.

- Keep new and used oil and solvent away from children and pets.
- Wear a long-sleeve shirt and waterproof gloves.
- Wash with soap if oil or solvent contacts your skin.

- 4) Reinstall the drain plug and gasket. Tighten the plug with a wrench to the specified torque.

Tightening torque specification

25.5 lb-ft (3.5 kg-m)

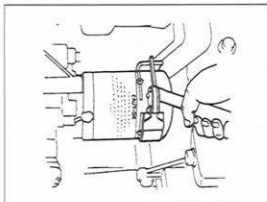

09-60A198A

#### Replace the oil filter.

- Using an oil filter wrench, turn the oil filter counterclockwise and remove it.
- Using a clean rag, wipe off the mounting surface on the engine where the new filter will be seated.
- Smear a little engine oil around the rubber gasket of the new oil filter.
- Screw on the new filter by hand until the filter gasket contacts the mounting surface.

#### **CAUTION**

To tighten the oil filter properly, it is important to accurately identify the position at which the filter gasket first contacts the mounting surface.

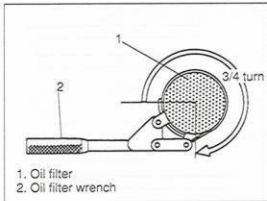

- Oil filter
- Oil filter wrench

09-60A199A

- Tighten the filter 3/4 turn from the point of contact with the mounting surface (or to the specified torque) using an oil filter wrench.

Tightening torque specification

10.0 lb-ft (1.4 kg-m)

#### **CAUTION**

To prevent oil leakage, make sure that the oil filter is tight, but do not over-tighten it.

#### Refill with oil and check for leaks.

- Pour oil through the filler hole and install the filler cap.

For the approximate capacity of the oil, refer to the "CAPACITIES" item in the "SPECIFICATIONS" section.

- Start the engine and look carefully for leaks at the oil filter and drain plug. Run the engine at various speeds for at least 5 minutes.
- Stop the engine and wait about 5 minutes. Check the oil level again and add oil if necessary. Check for leaks again.

#### **CAUTION**

When replacing the oil filter, it is recommended that you use a genuine SUZUKI replacement filter. If you use an after-market filter, make sure it is of equivalent quality and carefully follow the manufacturer's instructions and precautions.

65D-0907-A2E

## GEAR OIL

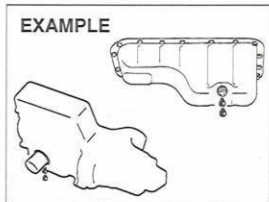

09-83E010A

**CAUTION**

Oil leaks from around the oil filter or drain plug indicate incorrect installation or gasket damage. If you find any leaks or are not sure that the filter has been properly tightened, have the vehicle inspected by your SUZUKI dealer.

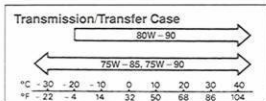

09-60G166A

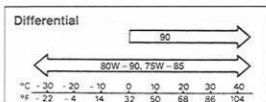

09-60G167A

**Specified Gear Oil**

When replacing gear oil, use the appropriate viscosity, grade and quantity as shown in the charts below. We highly recommend you use SAE 75W-90 gear oil (SAE 80W-90 for differential gear).

	API GRADE	CAPACITY (Approx.)
Transmission	GL-4	L4 engine 3.2 Imp pt. (1.5L)
		V6 engine 5.5 Imp pt. (2.6L)
Transfer Case (if equipped)	GL-4	3.6 Imp pt. (1.7L)
Differential (Front) (if equipped)	GL-5 (Hypoid gear oil)	2.1 Imp pt. (1.0L)
Differential (Rear)	GL-5 (Hypoid gear oil)	4.6 Imp pt. (2.2L)

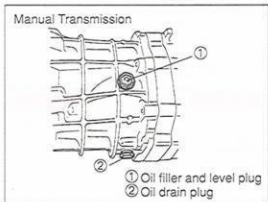

09-65D224

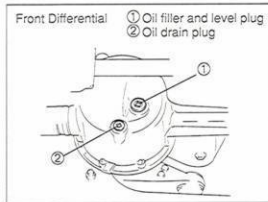

09-60A527A

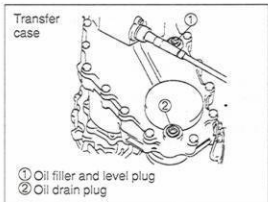

09-60A202A

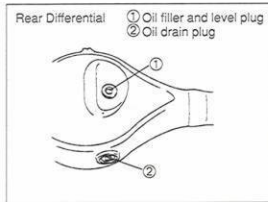

09-60A204A

### Gear Oil Level Check

The manual transmission, transfer gears and differentials (front and rear) are lubricated with gear oil. To check the gear oil level in any of the above locations, use the following procedure:

- 1) Park the vehicle on a level surface. Set parking brake and stop the engine.
- 2) Remove the oil filler plug ①.
- 3) Feel the inside of the hole with your finger. If the oil level comes up to the bottom of the plug hole, the oil level is correct. If so, reinstall the plug.
- 4) If the oil level is low, add gear oil through the filler plug hole ① until the oil level reaches the bottom of the filler hole.



**Gear Oil Replacement**

To change the gear oil in the manual transmission, transfer case or differential(s), use the following procedure:

- 1) Remove the oil filler plug ①.
- 2) Remove the drain plug ②, drain the oil, and reinstall the drain plug.
- 3) Pour new gear oil of the specified type through the filler hole until the oil level reaches the bottom of the filler hole.
- 4) Reinstall the filler plug.



**⚠ WARNING**

After driving the vehicle, gear oil temperature may be high enough to burn you. Wait until the oil filler plug is cool enough to touch with your bare hands before inspecting or replacing gear oil.

**⚠ CAUTION**

When tightening these plugs, apply sealing compound "Suzuki Bond No. 1215" or equivalent to the plug threads to prevent oil leakage, and tighten them to the specified torque shown below.

**Tightening torque**

	Oil Filler Plug		Oil Drain Plug
Manual transmission	2.5 L model	27.5 lb-ft (3.8 kg-m)	27.5 lb-ft (3.8 kg-m)
	2.0 L / 1.6 L models	17.0 lb-ft (2.3 kg-m)	17.0 lb-ft (2.3 kg-m)
Transfer	17.0 lb-ft (2.3 kg-m)		17.0 lb-ft (2.3 kg-m)
Front differential		16.5 lb-ft (2.3 kg-m)	18.0 lb-ft (2.5 kg-m)
		29.0 lb-ft (4.0 kg-m)	
Rear differential	36.5 lb-ft (5.0 kg-m)		20.5 lb-ft (2.8 kg-m)

6SD-0909-A0E

**AUTOMATIC TRANSMISSION FLUID****Specified Fluid**

Use an automatic transmission fluid equivalent to DEXRON®-III

**Fluid Level Check****⚠ CAUTION**

Driving with too much or too little fluid can damage the transmission.

You must check the fluid level with the automatic transmission fluid at normal operating temperature.

To warm up the transmission fluid, drive the vehicle or idle the engine until the temperature gauge indicates normal operating temperature, then drive for ten more minutes.

**NOTE:**

Do not check the fluid level if you have just driven the vehicle for a long time at high speed, if you have driven in city traffic in hot weather, or if the vehicle has been pulling a trailer. Wait until the fluid cools down (about 30 minutes), or the fluid level indication will not be correct.

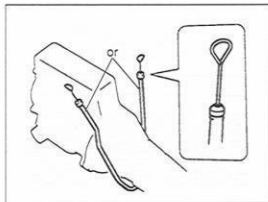

09-60A205A

To check the fluid level:

- 1) Park your vehicle on level ground.
- 2) Apply the parking brake and then start the engine in "P" (Park). Let it idle for two minutes and keep it running during the fluid level check.
- 3) With your foot on the brake pedal, move the selector lever through each gear, pausing for about three seconds in each range. Then move it back to the "P" (Park) position.

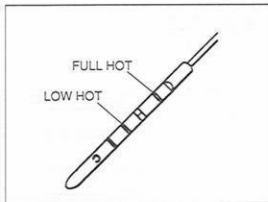

09-65D109A

### ⚠ WARNING

**Be sure to depress the brake pedal when moving the selector lever, or the vehicle can move suddenly.**

- 4) Remove the dipstick, clean it and push it back in until the cap seats. Pull out the dipstick and read the fluid level.

The fluid level should be between the two marks in the "HOT" range on the dipstick.

- 5) Add just enough specified fluid through the dipstick hole to fill the transmission to the proper level. It takes only 0.3 liters (0.53 Imp pt) for 4-speed automatic transmission to raise the level from "LOW HOT" to "FULL HOT".

### ⚠ CAUTION

**After checking or adding oil, be sure to insert the dipstick securely.**

### Changing Oil

Since special procedures, materials, and tools are required to change the automatic transmission oil, it is recommended that you trust this job to your authorized SUZUKI dealer.

## ENGINE COOLANT

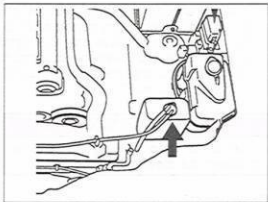

09-65D032A

**Engine Coolant Level Check**

Check the engine coolant level at the reserve tank, not at the radiator. With the engine cool, the engine coolant level should be between the "FULL" and "LOW" marks.

**Adding Engine Coolant**

If the engine coolant level is below the "LOW" mark, more engine coolant should be added. Remove the reserve tank cap and add engine coolant until the reserve tank level reaches the "FULL" mark. Never fill the reserve tank above the "FULL" mark.

**WARNING**

\* When adding or replacing engine coolant, use a high quality ethylene

(Continued)

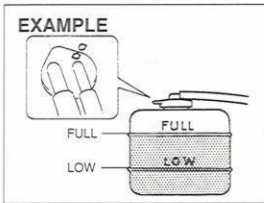

09-60A208A

(Continued)

glycol anti-freeze diluted with distilled water. The mixture you use should contain at least a 50% concentration of anti-freeze. If a 50% concentration does not provide adequate protection against freezing, follow the instructions on the anti-freeze container to obtain the desired freezing point.

- \* When putting the cap on the reserve tank, line up the arrow on the cap and the arrow on the tank, or coolant can leak out.

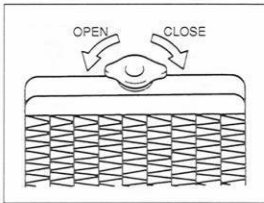

09-60G099A

**Engine Coolant Replacement**

- 1) When the engine is cool, remove the radiator cap by turning it slowly to the left until a "stop" is felt. Do not press down while turning the cap. Wait until any pressure is released, then press down on the cap and continue turning it to the left.

## WINDSHIELD WASHER FLUID

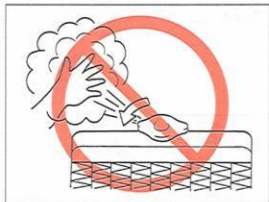

09-70G146A

**WARNING**

It is hazardous to remove the radiator cap when the engine coolant temperature is high, because scalding fluid and steam may be blown out under pressure. Wait until the engine coolant temperature has lowered before removing the cap.

- Remove the reservoir by lifting it up, and drain the reservoir completely.
- Loosen the drain plug attached to the lower part of the radiator and drain the engine coolant into a suitable container.

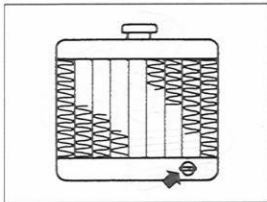

09-60A212A

- Reinstall the reservoir and fill it with engine coolant to the "FULL" line.
- Tighten the drain plug of the radiator, fill the radiator with engine coolant and install the radiator cap.
- After filling, let the engine idle for about 2 – 3 minutes to get rid of air in the cooling system. Then, stop the engine.
- Check the engine coolant level in the radiator again. If the level has gone down, add more engine coolant.

**CAUTION**

The engine coolant must be replaced with the vehicle on level ground.

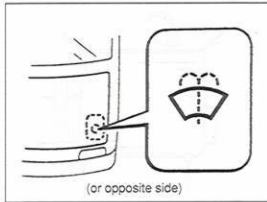

(or opposite side)

09-65D108A

Check that there is washer fluid in the tank. Refill it if necessary. Use a good quality windshield washer fluid, diluted with water as necessary.

**WARNING**

Do not use "anti-freeze" solution in the windshield washer reservoir. This can severely impair visibility when sprayed on the windshield, and also damage your vehicle's paint.

**CAUTION**

Damage may result if the washer motor is operated with no fluid in the washer tank.

## INSPECTION AND MAINTENANCE

65D-0912-A0E

### AIR CLEANER

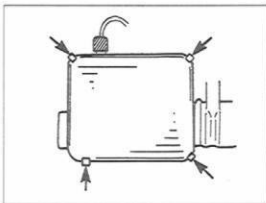

09-65D110A

If the air cleaner is clogged with dust, there will be greater intake resistance, resulting in decreased power output and increased fuel consumption.

Take off the air cleaner cover.

Remove the element from the air cleaner. If it appears to be dirty, replace it with a new one.



09-65D144A

#### **CAUTION**

The air cleaner element should be replaced every 30,000 miles (50,000 km). More frequent replacement is necessary when you drive under dusty conditions.

65D-0913-A0E

### SPARK PLUGS

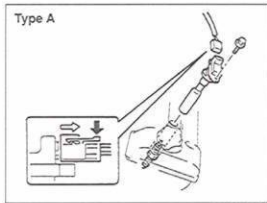

09-65D180A

You should inspect spark plugs periodically for carbon deposits. When carbon accumulates on a spark plug, a strong spark may not be produced. Remove carbon deposits with a wire or pin and adjust the spark plug gap.

For Type A, to access the spark plugs,

1. remove the ignition coil cover,
2. disconnect the coupler while pushing the release lever,
3. remove the bolt, and
4. pull the ignition coil out.

Type B

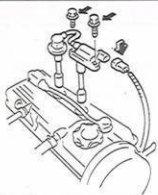

09-65D088A

- For Type B, to access the spark plugs,
1. disconnect the coupler while pushing the release lever,
  2. remove the bolts, and
  3. pull the spark plug boots.

### ⚠ CAUTION

- \* (For Type B) When disconnecting the spark plug cables, pull on the boot, not on the cable itself. Pulling on the cable can damage it.
- \* When servicing the iridium/platinum spark plugs (slender center electrode type plugs), do not touch the center electrode, as it is easy to damage.

(Continued)

(Continued)

- \* When installing the spark plugs, screw them in with your fingers to avoid stripping the threads. Tighten with a torque wrench to 25 N-m (2.5 kg-m, 18.0 ft-lb). Do not allow contaminants to enter the engine through the spark plug holes when the plugs are removed.
- \* Never use spark plugs with the wrong thread size.

### ⚠ CAUTION

When replacing spark plugs, you should use the brand and type specified for your vehicle. For the specified plugs, refer to the "SPECIFICATIONS" section at the end of this book. If you wish to use a brand of spark plug other than the specified plugs, consult your SUZUKI dealer.

L4 SOHC

CORRECT

WRONG

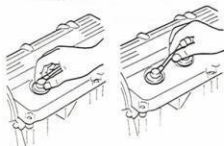

09-60G102A

0.039 – 0.043 in.  
(1.0 – 1.1 mm)



09-80G093A

## BRAKES

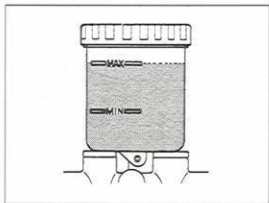

09-60A224A

**Brake Fluid**

Check the brake fluid level by looking at the reservoir in the engine compartment. Check that the fluid level is between the "MAX" and "MIN" lines. If the brake fluid level is near the "MIN" line, fill it up to the "MAX" line with DOT-3 brake fluid.

**⚠ WARNING**

Failure to follow the guidelines below can result in personal injury or serious damage to the brake system.

- \* If the brake fluid in the reservoir drops below a certain level, the brake warning light on the instrument panel will come on (the en-

(Continued)

**BRAKE** or



04-60A072A

(Continued)

gine must be running with the parking brake fully disengaged.) Should the light come on, immediately ask your SUZUKI dealer to inspect the brake system.

- \* A rapid fluid loss indicates a leak in the brake system which should be inspected by your SUZUKI dealer immediately.
- \* Brake fluid can harm your eyes and damage painted surfaces. Use caution when refilling the reservoir.
- \* Do not use any fluid other than DOT-3 brake fluid. Do not use reclaimed fluid or fluid that has been stored in old or open containers. It is essential that foreign particles and other liquids are kept out of the brake fluid reservoir.

**⚠ CAUTION**

The brake fluid should be replaced according to the maintenance schedule. Have the brake fluid replaced by your SUZUKI dealer.

**NOTE:**

*With disc brakes, the fluid level can be expected to gradually fall as the brake pads wear.*

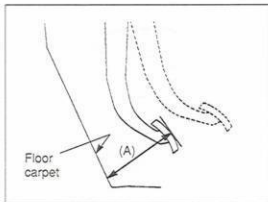

09-60A225A

Pedal to wall minimum distance (A)

3.9 in. (100 mm)

**Brake Pedal**

Measure the distance between the brake pedal and floor wall when the pedal is depressed with approximately 66 lbs (30 kg) of force. The minimum distance required is as specified. Since your vehicle's brake system is self-adjusting, there is no need for pedal adjustment. If the pedal to floor wall distance as measured above is less than the minimum distance required, have your vehicle inspected by your SUZUKI dealer.

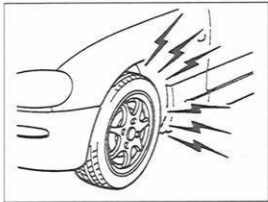

09-60A313A

**NOTE:**

When measuring the distance between the brake pedal and floor wall, push in the floor carpet as far as it goes and measure the distance between the carpet surface and the brake pedal.

**⚠ WARNING**

If you experience any of the following problems with your vehicle's brake system, have the vehicle inspected immediately by your SUZUKI dealer.

- \* Poor braking performance
- \* Uneven braking (Brakes not working uniformly on all wheels.)
- \* Excessive pedal travel
- \* Brake dragging
- \* Excessive noise
- \* (Except ABS equipped vehicle)  
Pedal pulsation (Pedal pulsates when pressed for braking.)



65D-0916-A2E

## STEERING WHEEL

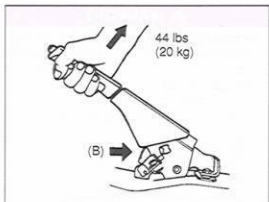

09-60A226A

Ratchet tooth specification (B)

5th - 7th

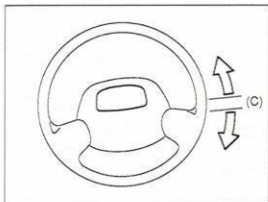

09-65D187A

Steering wheel play (C)

0.0 - 1.2 in. (0 - 30 mm)

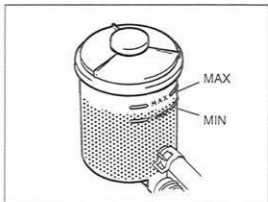

09-65D111A

**Power Steering (if equipped)**

Check the steering box case, vane pump and hose connections for leaks or damage.

**Power steering fluid**

Check the fluid level by looking at the reservoir in the engine compartment when the fluid is cold (about room temperature).

Check that the fluid level is between the "MAX" and "MIN" lines. If the fluid level is near the "MIN" line, fill it up to the "MAX" line with an automatic transmission fluid equivalent to DEXRON®-III. Do not overfill.

**Parking Brake Lever**

Check the parking brake for proper adjustment by counting the number of clicks made by the ratchet teeth as you slowly pull up on the parking brake lever to the point of full engagement. The parking brake lever should stop between the specified ratchet teeth and the rear wheels should be securely locked. If the parking brake is not properly adjusted or the brakes drag after the lever has been fully released, have the parking brake inspected and/or adjusted by your SUZUKI dealer.

Check the play of the steering wheel by gently turning it from left to right and measuring the distance that it moves before you feel slight resistance. The play should be between the specified values. Check that the steering wheel turns easily and smoothly without rattling by turning it all the way to the right and to the left while driving very slowly in an open area. If the amount of free play is outside the specification or you find anything else to be wrong, an inspection must be performed by your SUZUKI dealer.

65D-0918-A0E

**CLUTCH PEDAL**

09-60B318A

Check the clutch pedal for smooth operation and clutch fluid level from time to time. If clutch dragging is felt with the pedal fully depressed, have the clutch inspected by your SUZUKI dealer. If the clutch fluid level is near the "MIN" line, fill it up to the "MAX" line with DOT-3 brake fluid.

65D-0919-A3E

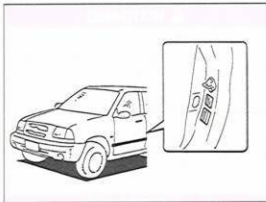
**TIRES**

09-65D033A

The front and rear tire pressure specifications for your vehicle are listed on the Tire Inflation Pressure Label which is located on the driver's door lock pillar.

**Tire Inspection**

Inspect your vehicle's tires periodically by performing the following checks:

- 1) Measure the air pressure with a tire gauge. Adjust the pressure if necessary.

**⚠ WARNING**

- \* Air pressures should be checked when the tires are cold or you may get inaccurate readings.
- \* Check the inflation pressure from time to time while inflating the tire gradually, until the specified pressure is obtained.
- \* Never underinflate or overinflate the tires.

Underinflation can cause unusual handling characteristics or can cause the rim to slip on the tire bead, resulting in an accident or damage to the tire or rim. Overinflation can cause the tire to burst, resulting in personal injury. Overinflation can also cause unusual handling characteristics which may result in an accident.

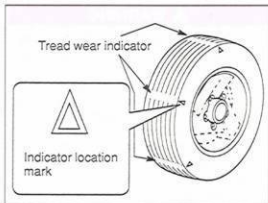

09-81A056A

- 2) Check that the depth of the tread groove is more than 0.06 in. (1.6 mm). To help you check this, the tires have molded-in tread wear indicators in the grooves. When the indicators appear on the tread surface, the remaining depth of the tread is 0.06 in. (1.6 mm) or less and the tire should be replaced.
- 3) Check for abnormal wear, cracks and damage. Any tires with cracks or other damage should be replaced. If any tires show abnormal wear, have them inspected by your SUZUKI dealer.

#### ⚠ WARNING

Hitting curbs and running over rocks can damage tires and affect wheel alignment. Be sure to have tires and wheel alignment checked periodically by your SUZUKI dealer.

- 4) Check for loose wheel nuts.
- 5) Check that there are no nails, stones or other objects sticking into the tires.

#### ⚠ WARNING

Your SUZUKI is equipped with tires which are all the same type and size. This is important to ensure proper steering and handling of the vehicle. Never mix tires of different size or type on the four wheels of your vehicle. The size and type of tires used should be only those approved by Suzuki Motor Corporation as standard or optional equipment for your vehicle.

#### ⚠ WARNING

Replacing the wheels and tires equipped on your vehicle with certain combinations of aftermarket wheels and tires can significantly change the steering and handling characteristics of your vehicle. Oversized tires may also rub against the fender over bumps, causing vehicle damage or tire failure. Therefore, use only those wheel and tire combinations approved by Suzuki Motor Corporation as standard or optional equipment for your vehicle. For information regarding the specified tires, refer to the Tire Inflation Pressure Label located on the driver's side door pillar or the "SPECIFICATIONS" section.

#### ⚠ CAUTION

Replacing the original tires with tires of a different size may result in false speedometer or odometer readings. Check with your SUZUKI dealer before purchasing replacement tires that differ in size from the original tires.

**Uniform Tire Quality Grading**

The U.S. National Highway Traffic Safety Administration has developed a grading system for evaluating the performance of passenger car tires. The following information will help you understand the grading system, which applies to vehicles sold in the U.S. Consult your SUZUKI dealer or tire retailer for help in choosing the correct replacement tires for your vehicle.

Quality grades can be found where applicable on the tire sidewall between tread shoulder and maximum section width. For example:

Treadwear 200 Traction AA Temperature A

**DOT quality grades****TREADWEAR****TRACTION AA A B C****TEMPERATURE A B C**

All Passenger Car Tires Must Conform To Federal Safety Requirements in Addition To These Grades

**TREADWEAR**

The treadwear grade is a comparative rating based on the wear rate of the tire when tested under controlled conditions on a specified government test course. For example, a tire graded 150 would wear one and one-half (1½) times as well on the government

course as a tire graded 100. The relative performance of tires depends upon the actual conditions of their use, however, and may depart significantly from the norm due to variations in driving habits, service practices and differences in road characteristics and climate.

**TRACTION-AA, A, B, C**

The traction grades, from highest to lowest, are AA, A, B and C. Those grades represent the tire's ability to stop on wet pavement as measured under controlled conditions on specified government test surfaces of asphalt and concrete. A tire marked C may have poor traction performance.

**▲ WARNING**

The traction grade assigned to this tire is based on straight-ahead braking traction tests, and does not include acceleration, cornering, hydroplaning or peak traction characteristics.

**TEMPERATURE-A, B, C**

The temperature grades are A (the highest), B and C, representing the tire's resistance to the generation of heat and its ability to dissipate heat when tested under controlled conditions on a specified indoor laboratory

test wheel. Sustained high temperature can cause the material of the tire to degenerate and reduce tire life, and excessive temperature can lead to sudden tire failure. The grade C corresponds to a level of performance which all passenger car tires must meet under the Federal Motor Vehicle Safety Standard No. 109. Grades B and A represent higher levels of performance on the laboratory test wheel than the minimum required by law.

**▲ WARNING**

The temperature grade for this tire is established for a tire that is properly inflated and not overloaded. Excessive speed, underinflation, or excessive loading, either separately or in combination, can cause heat buildup and possible tire failure.

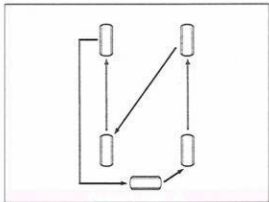

09-65D164A

### Tire Rotation

To avoid uneven wear of your tires and to prolong their life, rotate the tires as illustrated. Tires should be rotated as recommended in the periodic maintenance schedule. After rotation, adjust front and rear tire pressures to the specification listed on your vehicle's Tire Inflation Pressure Label.

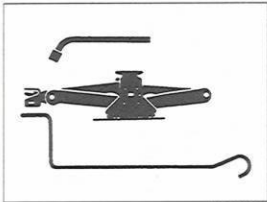

09-60A401A

### Changing Wheels

To change a wheel, use the following procedure:

- 1) Remove the jack, tools and spare wheel from the vehicle.
- 2) Loosen, but do not remove the wheel nuts.
- 3) Jack up the vehicle (follow the jacking instructions in the "EMERGENCY SERVICE" section in this manual)
- 4) Remove the wheel nuts and wheel.
- 5) Clean the contact surface of the new wheel and the wheel hub.
- 6) Install the new wheel and replace the wheel nuts with their cone shaped end facing the wheel. Tighten each nut snugly by hand until the wheel is securely seated on the hub.

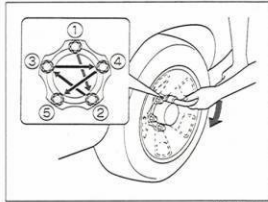

09-65D184A

### Wheel tightening torque

72.3 lb-ft (10.0 kg-m)

- 6) Lower the jack and fully tighten the nuts (to the specified torque) in a crisscross fashion with a wrench as shown in the illustration.

### Snow Tires

Your vehicle is equipped with all-season tires which are designed for use in summer and most winter conditions. For improved traction in severe winter conditions, SUZUKI recommends mounting radial snow tires on all four wheels. Snow tires must be the same size as the standard tires.

## BATTERY

## EXAMPLE

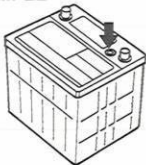

09-60A269A

**⚠ WARNING**

Batteries produce flammable hydrogen gas. Keep flames and sparks away from the battery or an explosion may occur. Never smoke when working near the battery.

**⚠ WARNING**

When checking or servicing the battery, disconnect the negative cable. Be careful not to cause a short circuit by allowing metal objects to contact the battery posts and the vehicle at the same time.

**⚠ WARNING**

To avoid harm to yourself or damage to your vehicle or battery, follow the jump starting instructions in the "EMERGENCY SERVICE" section of this manual if it is necessary to jump start your vehicle.

**⚠ WARNING**

Battery posts, terminals, and related accessories contain lead and lead compounds. Wash hands after handling.

Your vehicle is equipped with a battery that requires infrequent maintenance. You will never have to add water. You should, however, periodically check the battery, battery terminals, and battery hold-down bracket for corrosion. Remove corrosion using a stiff brush and ammonia mixed with water, or baking soda mixed with water. After removing corrosion, rinse with clean water.

The test indicator on the top of the battery provides information on the condition of the battery.

If your vehicle is not going to be driven for a month or longer, disconnect the cable from the negative terminal of the battery to help prevent discharge.

## FUSES

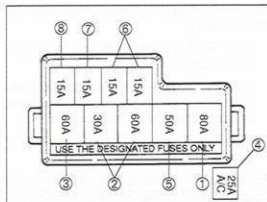

09-65D056A

- ① Main fuse
- ② Primary fuse
- ③ Heater fuse
- ④ A/C fuse (if equipped)
- ⑤ ABS actuator fuse (if equipped)
- ⑥ Head light fuse
- ⑦ Fuel injection system fuse
- ⑧ Empty

Your vehicle has three types of fuses, as described below:

**Main Fuse** – The main fuse takes current directly from the battery.

**Primary Fuses** – These fuses are between the main fuse and individual fuses, and are for electrical load groups.

**Individual Fuses** – These fuses are for individual electrical circuits.

For details on protected circuits, refer to the "FUSES AND PROTECTED CIRCUITS" section in this manual.

### Main Fuse Box

The main fuse, primary fuses and some of the individual fuses are located in the engine compartment. If the main fuse blows, no electrical component will function. If a primary fuse blows, no electrical component in the corresponding load group will function. When replacing the main fuse or a primary fuse, use a genuine SUZUKI replacement.

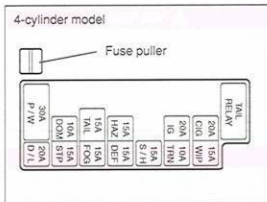

09-65D182A

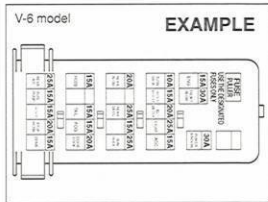

09-65D285A

### WARNING

If a fuse in the main fuse box blows, be sure to have your vehicle inspected by an authorized SUZUKI dealer. Always use a genuine SUZUKI replacement. Never use a substitute such as a wire even for a temporary fix, or extensive electrical damage and a fire can result.

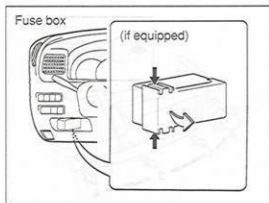

09-65D299A

### Fuse Box

The fuse box is located under the driver's side of the dashboard. Remove the fuse box cover (if equipped) by pushing in at both ends and pulling off the cover. To remove a fuse, use the fuse puller provided in the fuse box.

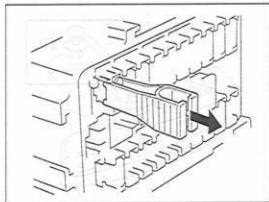

09-65D045A

### WARNING

Always be sure to replace a blown fuse with a fuse of the correct amperage. Never use a substitute such as aluminum foil or wire to replace a blown fuse. If you replace a fuse and the new one blows in a short period of time, you may have a major electrical problem. Have your vehicle inspected immediately by your SUZUKI dealer.

### NOTE:

Make sure that the fuse box cover always carries spare fuses.

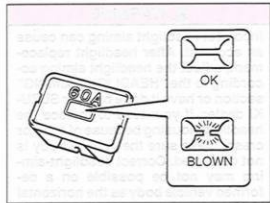

09-60A243A

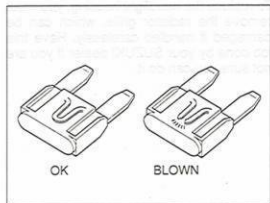

09-65D046A



65D-0930-A0E

HEADLIGHT HOUSING  
REPLACEMENT**⚠ WARNING**

Incorrect headlight aiming can cause an accident. After headlight replacement, adjust the headlight aiming according to the "HEADLIGHT AIMING" section or have it done by your SUZUKI dealer. If you need to replace the headlight housing because of a minor crash, make sure the vehicle body is not deformed. Correct headlight-aiming may not be possible on a deformed vehicle body as the horizontal aiming of the headlight housing is not adjustable.

To replace the headlight housing, you must remove the radiator grille, which can be damaged if handled carelessly. Have this job done by your SUZUKI dealer if you are not sure you can do it.

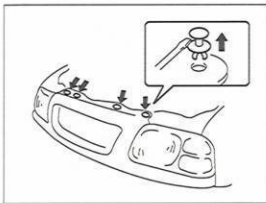

09-65D173A

- 1) Remove the clips that secure the top of the radiator grille. Pry up the center piece and pull up the clip to remove it.

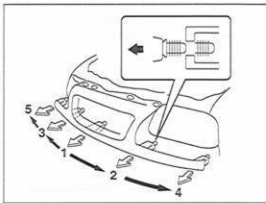

09-65D174A

- 2) Pull the radiator grille forward at each gripped portion from the center to the ends.

**⚠ CAUTION**

To avoid damaging the grille, do not apply force when removing it. Pull it gradually.

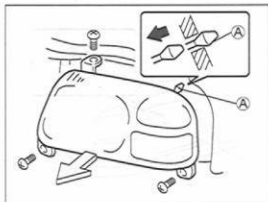

09-65D175A

- 3) Undo the screws that secure the headlight housing. Pull the housing forward. Note that there is a guide pin (A).
- 4) Detach the connector (B) from the bracket by squeezing the lock tip with a pliers.
- 5) Remove all the bulbs.  
To remove the headlight bulb, see the "BULB REPLACEMENT" section.

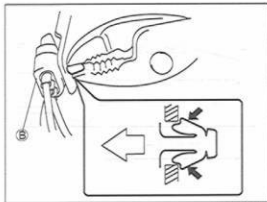

09-65D172A

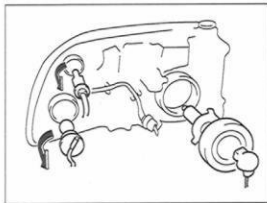

09-65D171A

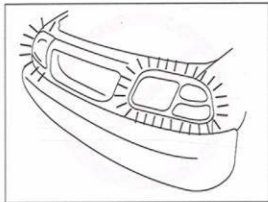

09-65D169A

- 6) Replace the headlight housing.  
For installation, reverse the procedure used for removal. Make sure all the lights work properly.

## HEADLIGHT AIMING

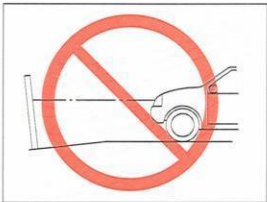

09-65D176A

**⚠ WARNING**

Incorrect headlight aiming can cause an accident. If you can not adjust the aiming correctly, have it done by your SUZUKI dealer.

Before adjustment:

- Make sure the tires are at the correct pressure.
- Place the vehicle on a flat, level surface facing a blank wall with the headlights 32 ft. (10 m) from the wall. If the surface is not flat or level, correct aiming will not be obtained.

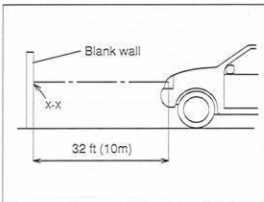

09-65D177A

- c) Have the driver or similar weight person sit in the driver's seat.

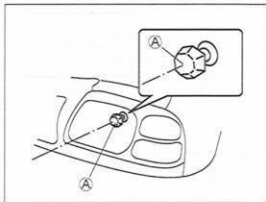

09-65D170A

- d) Measure the distance from the ground to the center of the headlight bulb reflector cap (A).

## BULB REPLACEMENT

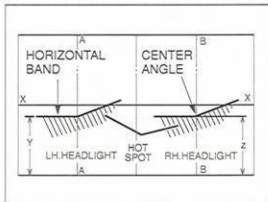

09-65D178A

- X-X: Horizontal center of headlights  
 A-A: Vertical center of left headlight  
 B-B: Vertical center of right headlight  
 Y: Height of left hot-spot band  
 Z: Height of right hot-spot band

To adjust the aiming:

- Turn on the headlights.
- At the wall, measure the distance from the ground to the center of the horizontal band of the hot spots (high intensity zones). This distance should be 2 to 4 inches (50 to 100 mm) less than the height of the headlight bulbs. If the aiming is incorrect, adjust it by turning the adjusting gear.

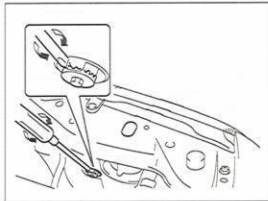

09-65D145A

- At the wall, measure the distance between the center angles of the hot spots (A-A to B-B). This distance should be between 38 and 41 inches (96 and 104 cm). If the distance is outside this range, or the hot spots are not directly in front of the vehicle, check the headlight housings for improper installation or have the vehicle body checked for deformation.

**⚠ WARNING**

- Light bulbs can be hot enough to burn your finger right after being turned off. This is true especially for halogen headlight bulbs. Replace the bulbs after they become cool enough.
- The headlight bulbs are filled with pressurized halogen gas. They can burst and injure you if they are hit or dropped. Handle them carefully.

**⚠ CAUTION**

The oils from your skin may cause a halogen bulb to overheat and burst when the lights are on. Grasp a new bulb with a clean cloth.

**⚠ CAUTION**

Frequent replacement of a bulb indicates the need for an inspection of the electrical system. This should be carried out by your SUZUKI dealer.

**NOTE:**

If it is difficult to replace headlight bulbs or clearance light bulbs due to under-hood components trust this job to your dealer.

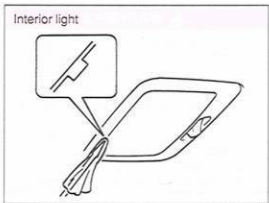

**Center Interior Light (if equipped)**

Pull down the lens by using a plain screw driver covered with a soft cloth as shown. To install it, simply push it back in.

The bulb can be removed by simply pulling it out. When replacing the bulb, make sure that the contact springs are holding the bulb securely.

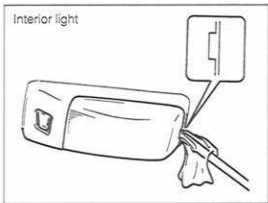

**Rear Interior Light (if equipped)**

Pull down the lens by using a plain screw driver covered with a soft cloth as shown. To install it, simply push it back in.

The bulb can be removed by simply pulling it out.

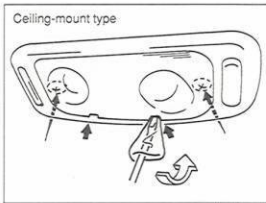

**Spot Light (if equipped)**

Pull down the lens by using a plain screw driver covered with a soft cloth as shown.

**Ceiling-mount type:**

Undo the two screws and detach the light housing. Remove the bulb holder by turning it counterclockwise. Pull out the bulb.

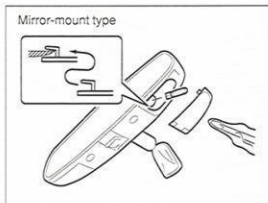

Mirror-mount type:  
Pull out the bulb.

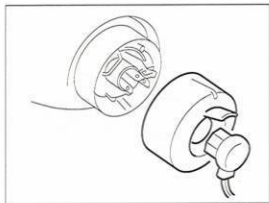

### Headlights

Open the engine hood. Remove the socket and rubber cover. Then unhook the bulb holding spring and replace the bulb.

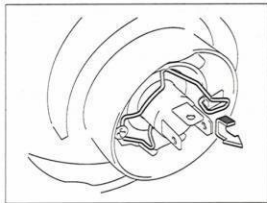
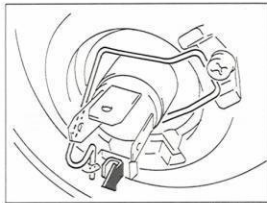

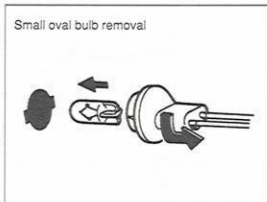

09-60A251A

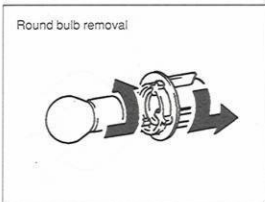

09-60A252A

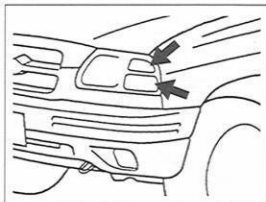

09-65D102A

**Front Clearance/Turn Signal Light,  
Tail/Stop/Back-up Combination Light,  
Side Marker Light, License Plate Light**

Two types (small oval and round) of bulbs are used for these lights. To remove and install a small oval bulb, simply pull out or push in the bulb.

To remove a round bulb from a bulb holder, push in the bulb and turn it counterclockwise. To install a new bulb, push it in and turn it clockwise.

To remove a bulb holder from a light housing, turn the holder counterclockwise and pull it out. To install the holder, push the holder in and turn it clockwise. You can access the individual bulb holders as described below:

**Front clearance/turn signal light**

Trust this replacement job to your dealer as the front grille and the headlight housing must be removed for this job.

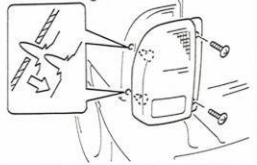
Tail/stop/back-up  
combination light

09-65D091A

License plate light

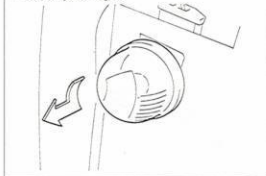

09-75F087A

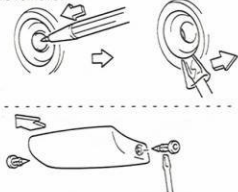
High-mount stop light (if equipped)  
To remove:

Front side marker light

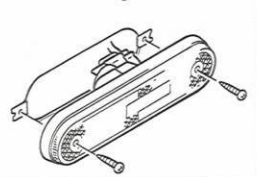

09-60G148A

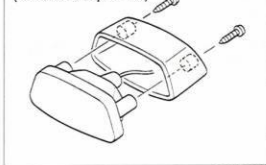
High-mount stop light  
(for Canvas top model)

09-60A408A

To install:

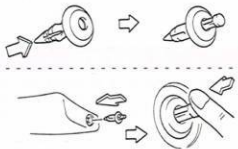

09-65D094A



## WIPER BLADES



09-65D270A

If the wiper blades become brittle or damaged, or make streaks when wiping, replace the wiper blades.

To install new wiper blades, follow the procedures below.

**⚠ CAUTION**

To avoid scratching or breaking the window, do not let the wiper arm strike the window while replacing the wiper blade.



09-70G119A

**NOTE:**

*Some wiper blades may be different from the ones described here depending on vehicle specifications. If so, consult your SUZUKI dealer for proper replacement method.*

**For windshield wipers and some rear wipers:**

1. Hold the wiper arm away from the window.

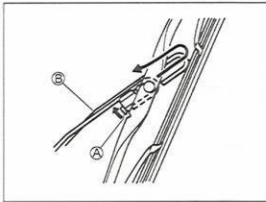

09-60A256A

2. Squeeze lock lever **A** towards wiper arm **B** and remove the wiper frame from the arm as shown.
3. Pull the locked end of the wiper blade firmly to unlock the blade and slide the blade out as shown.
4. If the new blade is provided without the two metal retainers, move them from the old blade to the new one.

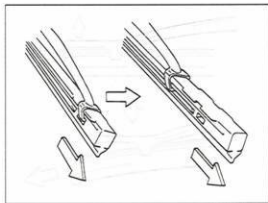

09-60A260A

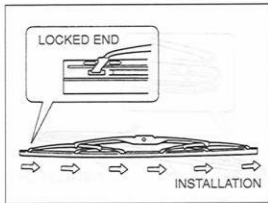

09-60A262A

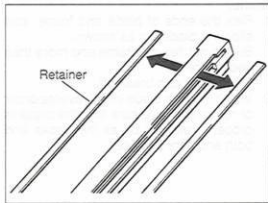

09-60A261A

5. Install the new blade in the reverse order of removal, with the locked end positioned toward the wiper arm. Make sure the blade is properly retained by all the hooks. Grasp the blade near the locked end and pull in the direction of the arrows to lock the end into place.
6. Reinstall wiper frame to arm, making sure that the lock lever is snapped securely into the arm.

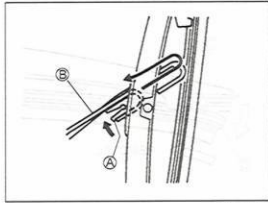

09-60A263A

**To remove some types of rear wiper frame from the wiper arm:**

1. Hold the arm away from the window.
2. Squeeze the lock piece **A** toward the wiper arm **B** and remove the wiper frame as shown.
3. When reinstalling wiper frame to arm, make sure that the lock piece is snapped securely into the arm.

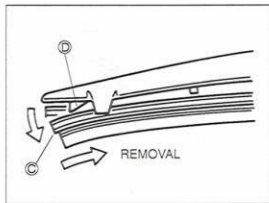

09-60A264A

**To remove and install some types of rear wiper blade from and to the wiper frame.**

1. Flex the locked end of blade © away from retainer © to unlock it and slide the blade out as shown.

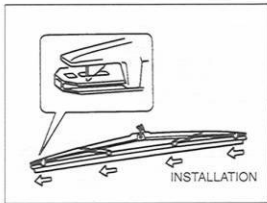

09-60A265A

2. Install the new blade in the reverse order of removal. Make sure that the blade is properly retained by all the hooks and the end is locked in place.

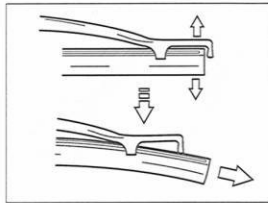

09-65D151A

**To remove and install some types of rear wiper blade from and to the wiper frame.**

1. Flex the ends of blade and frame, and slide the blade out as shown. But do not flex the frame end more than necessary. If you do, it can break off.
2. Install the new blade in the reverse order of removal. Make sure that the blade is properly retained by all the hooks and both ends are in place.

6SD-1000-ACE

## EMERGENCY SERVICE

Jacking Instructions .....	10-1
Jump Starting Instructions .....	10-2
Towing a Disabled Vehicle .....	10-4
Emergency Remedies .....	10-4

6SD-1100-ACE

## APPEARANCE CARE

Corrosion Prevention .....	11-1
Vehicle Cleaning .....	11-3

## EMERGENCY SERVICE

65D-1001-AGE

### JACKING INSTRUCTIONS

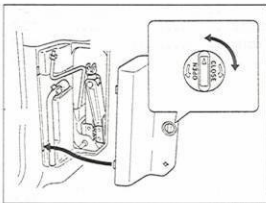

10-65D196A

- 1) Place the vehicle on level, hard ground.
- 2) Set the parking brake firmly and shift into "P" (Park) if your vehicle has an automatic transmission, or shift into "R" (Reverse) if your vehicle has a manual transmission. Block the front and rear of the wheel diagonally opposite of the wheel being lifted.
- 3) Turn on the hazard warning flasher if your vehicle is near traffic.
- 4) Position the jack vertically and raise the jack by turning the jack handle clockwise until the jack head recess fits the frame boss.

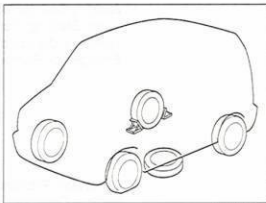

10-75F062A

- 5) Continue to raise the jack slowly and smoothly until the tire clears the ground. Do not raise the vehicle more than necessary.

#### **▲ WARNING**

- \* Use the jack only to change wheels.
- \* Never jack up the vehicle on an inclined surface.
- \* Never raise the vehicle with the jack in a location other than under the frame boss near the wheel to be changed.
- \* Make sure that the jack is raised at least 2 inches (51 mm) before it

(Continued)

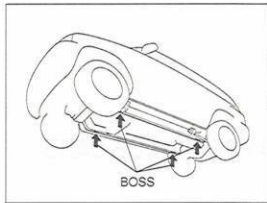

10-65D034A

(Continued)

contacts the frame boss. Use of the jack when it is within 2 inches of being fully collapsed may result in failure of the jack.

- \* Never get under the vehicle when it is supported by the jack.
- \* Never run the engine when the vehicle is supported by the jack and never allow passengers to remain in the vehicle.

65D-1002-A0E

## JUMP STARTING INSTRUCTIONS

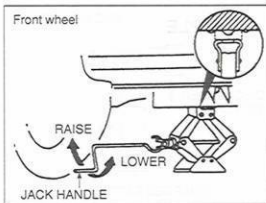

10-60A267A

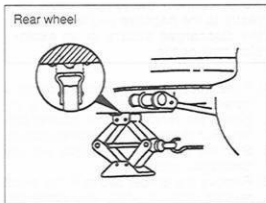

10-60A268A

**⚠ WARNING**

- \* Never attempt to jump start your vehicle if the battery appears to be frozen. Batteries in this condition may explode or rupture if jump starting is attempted.
- \* When making jumper cable connections, be certain that your hands and the jumper cables remain clear from pulleys, belts, or fans.
- \* Batteries produce flammable hydrogen gas. Keep flames and sparks away from the battery or an explosion may occur. Never smoke when working near the battery.
- \* If the booster battery you use for jump starting is installed in another vehicle, make sure the two vehicles are not touching each other.
- \* If your battery discharges repeatedly, for no apparent reason, have your vehicle inspected by an authorized SUZUKI dealer.
- \* To avoid harm to yourself or damage to your vehicle or battery, follow the jump starting instructions below precisely and in order. If you are in doubt, call for qualified road service.

**⚠ CAUTION**

Your vehicle should not be started by pushing or towing. This starting method could result in permanent damage to the catalytic converter. Use jumper cables to start a vehicle with a weak or run-down battery.

## 12V BATTERY

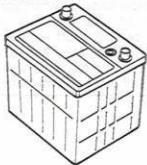

10-60A269A

When jump starting your vehicle, use the following procedure:

- 1) Use only a 12 volt battery to jump start your vehicle. Position the good 12V battery close to your vehicle so that the jumper cables will reach both batteries. When using a battery installed on another vehicle, **DO NOT LET THE VEHICLES TOUCH**. Set the parking brakes fully on both vehicles.
- 2) Turn off all vehicle accessories, except those necessary for safety reasons (for example, headlights or hazard lights).

## EXAMPLE

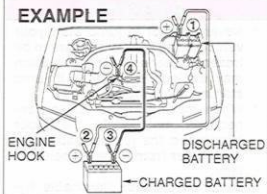

10-65D263A

- 3) Make jumper cable connections as follows:

- a) Connect one end of the first jumper cable to the positive (+) terminal of the discharged battery.
- b) Connect the other end to the positive (+) terminal of the booster battery.
- c) Connect one end of the second jumper cable to the negative (-) terminal of the booster battery.
- d) Make the final connection to an unpainted, heavy metal part of the engine of the vehicle with the discharged battery.

## EXAMPLE

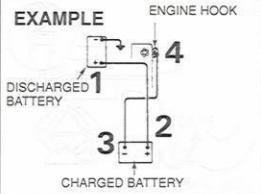

10-60A270A

### **⚠ WARNING**

Never connect the jumper cable directly to the negative (-) terminal of the discharged battery, or an explosion may occur.

- 4) If the booster battery you are using is installed on another vehicle, start the engine of the vehicle with the booster battery. Run the engine at moderate speed.
- 5) Start the engine of the vehicle with the discharged battery.
- 6) Remove the jumper cables in the exact reverse order in which you connected them.

65D-1006-A0E

## TOWING A DISABLED VEHICLE

**(EMERGENCY TOWING)**

If your vehicle is disabled, it may be towed by a tow truck using one of the following methods:

- a) Tow the vehicle with two wheels lifted by the tow truck and the other two wheels on a towing dolly.
- b) Use the appropriate towing method specified for your vehicle in the "RECREATIONAL TOWING" section, but with the wheels lifted by the tow truck instead of on a towing dolly. Be sure to carefully follow the specific instructions provided in the "RECREATIONAL TOWING" section.

**⚠ CAUTION**

If vehicle damage (such as steering or drivetrain damage, inability to operate free axle mechanism, etc.) prevent normal use of the towing procedures for your vehicle described in the "RECREATIONAL TOWING" section, have your vehicle towed with two wheels lifted by the tow truck and the other two wheels on a towing dolly.

65D-1004-A0E

## EMERGENCY REMEDIES

**If the Starter Does Not Operate:**

- 1) Try turning the ignition switch to the "START" position with the headlights turned on to determine the battery condition. If the headlights go excessively dim or go off, it usually means that either the battery has run down or battery terminal contact is poor. Recharge the battery or correct battery terminal contact if necessary.
- 2) If the headlights remain bright, check the fuses. If the reason for failure of the starter is not obvious, there may be a major electrical problem. Have the vehicle inspected by your authorized SUZUKI dealer.

**If the Engine is Flooded**

If the engine is flooded with gasoline, it may be hard to start. If this happens, press the accelerator pedal all the way to the floor and hold it there while cranking the engine. (Do not operate the starter motor for more than 15 seconds).

**If the Engine Overheats**

The engine could overheat temporarily under severe driving conditions. If the engine coolant temperature gauge indicates overheating during driving:

- 1) Turn off the air conditioner, if equipped.
- 2) Take the vehicle to a safe place and park.
- 3) Let the engine run at normal idle speed for a few minutes until the indicator is within the normal, acceptable temperature range shown by the white band between "H" and "C".

**⚠ WARNING**

If you see or hear escaping steam, stop the vehicle in a safe place and immediately turn off the engine to let it cool. Do not open the hood when steam is present. When the steam can no longer be seen or heard, open the hood to see if the coolant is still boiling. If it is, you must wait until it stops boiling before you proceed. Also, be careful not to touch hot engine parts (radiator, water hoses, engine etc).



If the temperature indication does not come down to within the normal, acceptable range:

- 1) Turn off the engine and check that the water pump belt and pulleys are not damaged or slipping. If any abnormality is found, correct it.
- 2) Check the coolant level in the reservoir. If it is found to be lower than the "LOW" line, look for leaks at the radiator, water pump, and radiator and heater hoses. If you locate any leaks that may have caused the overheating, do not run the engine until these problems have been corrected.
- 3) If you do not find a leak, carefully add coolant to the reservoir and then the radiator, if necessary. (Refer to "ENGINE COOLANT" in the "INSPECTION AND MAINTENANCE" section.)

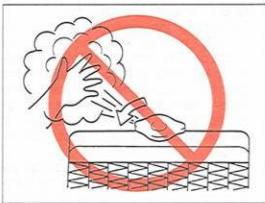

09-70G146A

### **⚠ WARNING**

It is hazardous to remove the radiator cap when the water temperature is high, because scalding fluid and steam may be blown out under pressure. The cap should only be taken off when the coolant temperature has lowered.

65D-1101-A0E

## CORROSION PREVENTION

It is important to take good care of your vehicle to protect it from corrosion.

Listed below are instructions for how to maintain your vehicle to prevent corrosion. Please read and follow these instructions carefully.

### Important Information About Corrosion Common causes of corrosion

- 1) Accumulation of road salt, dirt, moisture, or chemicals in hard to reach areas of the vehicle underbody or frame.
- 2) Chipping, scratches and any damage to treated or painted metal surfaces resulting from minor accidents or impact from stones and gravel.

### Environmental conditions which accelerate corrosion

- 1) Road salt, dust control chemicals, sea air or industrial pollution will all accelerate the corrosion of metal.
- 2) High humidity will increase the rate of corrosion particularly when the temperature range is just above the freezing point.
- 3) Moisture in certain areas of a vehicle for an extended period of time may promote corrosion even though other body sections may be completely dry.



12-65D210A

- 4) High temperatures will cause an accelerated rate of corrosion to parts of the vehicle which are not well ventilated to permit quick drying.

This information illustrates the necessity of keeping your vehicle (particularly the underbody) as clean and dry as possible. It is equally important to repair any damage to the paint or protective coatings as soon as possible.

### How to Help Prevent Corrosion Wash your vehicle frequently

The best way to preserve the finish on your vehicle and to help avoid corrosion is to keep it clean with frequent washing.

Wash your vehicle at least once during the winter and once immediately after the winter. Keep your vehicle, particularly the underside, as clean and dry as possible.

If you frequently drive on salted roads, your vehicle should be washed at least once a month during the winter. If you live near the ocean, your vehicle should be washed at least once a month throughout the year.

Wash your vehicle immediately after using it off-road. For washing instructions, refer to the "VEHICLE CLEANING" section.

### Remove foreign material deposits

Foreign material such as salts, chemicals, road oil or tar, tree sap, bird droppings and industrial fall-out may damage the finish of your vehicle if it is left on painted surfaces. Remove these types of deposits as quickly as possible. If these deposits are difficult to wash off, an additional cleaner may be required. Be sure that any cleaner you use is not harmful to painted surfaces and is specifically intended for your purposes. Follow the manufacturer's directions when using these special cleaners.

### **⚠ WARNING**

Foreign material can lodge between the fuel tank of your vehicle and the skid plate which covers it. You should periodically clean out any foreign material which has accumulated in this area, since it could create a fire hazard.

### **Repair finish damage**

Carefully examine your vehicle for damage to the painted surfaces, especially if it is used off-road. Should you find any chips or scratches in the paint, touch them up immediately to prevent corrosion from starting. If the chips or scratches have gone through to the bare metal, have a qualified body shop make the repair.

### **Keep passenger and cargo compartments clean**

Moisture, dirt or mud can accumulate under the floor mats and may cause corrosion. Occasionally, check under these mats to ensure that this area is clean and dry. More frequent checks are necessary if the vehicle is used off road or in wet weather.

Certain cargo such as chemicals, fertilizers, cleaners, salts, etc. are extremely corrosive by nature. These products should be transported in sealed containers. If a spill or leak

does occur, clean and dry the area immediately.

### **Use mud and gravel shields**

The use of mud and gravel shields will help protect your vehicle, especially if you frequently drive on gravel or salted roads. Full-size shields, which extend as close to the road as is practical, are the best. The fittings for such shields should also be corrosion resistant. Please check with your authorized SUZUKI dealer for information on these shields.

### **Store your vehicle in a dry, well-ventilated area**

Do not park your vehicle in a damp, poorly ventilated area. If you often wash your vehicle in the garage or if you frequently drive it in when wet, your garage may be damp. The high humidity in the garage may cause or accelerate corrosion. A wet vehicle may corrode even in a heated garage if the ventilation is poor.

### **⚠ WARNING**

Do not apply additional undercoating or rust preventive coating on or around exhaust system components such as the catalytic converter, exhaust pipes, etc. A fire could be started if the undercoating substance becomes overheated.

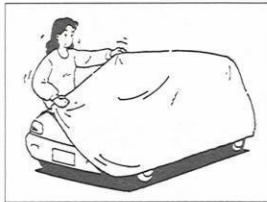

11-50G203A

### **Cover your vehicle**

If you can not regularly park your vehicle in a garage, we recommend you use a vehicle cover. Years of exposure to midday sun can cause the colors in paint, plastic parts, and fabrics to fade. Covering your vehicle with a high-quality, "breathable" vehicle cover can help protect the finish from the harmful UV rays in sunlight, and can reduce the amount of dust and air pollution reaching the surface. Your SUZUKI dealer can help you select the right cover for your vehicle.

## VEHICLE CLEANING



12-65D035A

**⚠ WARNING**

When cleaning the interior or exterior of the vehicle, **NEVER USE** flammable solvents such as lacquer thinners, gasoline, benzene or cleaning materials such as bleaches and strong household detergents. The materials could cause personal injury or damage to the vehicle.

**Cleaning Interior**  
**Vinyl upholstery**

Prepare a solution of soap or mild detergent mixed with warm water. Apply the solution to the vinyl with a sponge or soft cloth and let it soak for a few minutes to loosen dirt. Rub the surface with a clean, damp cloth to re-

move dirt and the soap solution. If some dirt still remains on the surface, repeat this procedure.

**Fabric upholstery**

Remove loose dirt with a vacuum cleaner. Using a mild soap solution, rub stained areas with a clean damp cloth. To remove soap, rub the areas again with a cloth dampened with water. Repeat this until the stain is removed, or use a commercial fabric cleaner for tougher stains. If you use a fabric cleaner, carefully follow the manufacturer's instructions and precautions.

**Leather upholstery**

Remove loose dirt with a vacuum cleaner. Using a mild soap or saddle soap solution, wipe dirt off with a clean damp soft cloth. To remove soap, wipe the areas again with a soft cloth dampened with water. Wipe the areas dry with a soft dry cloth. Repeat this until the dirt or stain is removed, or use a commercial leather cleaner for tougher dirt or stains. If you use a leather cleaner, carefully follow the manufacturer's instructions and precautions. Do not use solvent type cleaners or abrasive cleaners.

**Seat belts**

Clean seat belts with a mild soap and water. Do not use bleach or dye on the belts. They may weaken the fabric in the belts.

**Vinyl floor mats**

Ordinary dirt can be removed from vinyl with water or mild soap. Use a brush to help loosen dirt. After dirt is loosened, rinse the mat thoroughly with water and dry it in the shade.

**Carpets**

Remove dirt and soil as much as possible with a vacuum cleaner. Using a mild soap solution, rub stained areas with a clean damp cloth. To remove soap, rub the areas again with a cloth dampened with water. Repeat this until the stain is removed, or use a commercial carpet cleaner for tougher stains. If you use a carpet cleaner, carefully follow the manufacturer's instructions and precautions.

**Cleaning the Exterior**
**⚠ CAUTION**

It is important that your vehicle be kept clean and free from dirt. Failure to keep your vehicle clean may result in fading of the paint or corrosion to various parts of the vehicle body.



12-76G044A

## Washing

### ⚠ WARNING

- \* Never attempt to wash and wax your vehicle with the engine running.
- \* When cleaning the underside of the body and fender, where there may be sharp-edged parts, you should wear gloves and a long-sleeved shirt to protect your hands and arms from being cut.
- \* After washing your vehicle, carefully test the brakes before driving to make sure they have maintained their normal effectiveness.

When washing the vehicle, follow the instructions below:

- 1) Flush the underside of body and wheel housings with pressurized water to remove mud and debris. Use plenty of water.

### ⚠ CAUTION

When washing the vehicle, avoid directing steam or hot water of more than 80°C (176°F) on plastic parts.

- 2) Remove dirt and mud from the body exterior with running water. You may use a soft sponge or brush. Do not use hard materials which can scratch the paint.
- 3) Wash the entire exterior with a mild detergent or car wash soap using a sponge or soft cloth. The sponge or cloth should be frequently soaked in the soap solution.

### ⚠ CAUTION

When using a commercial car wash product, observe the cautions specified by the manufacturer. Never use strong household detergents or soaps.

- 4) Once the dirt has been completely removed, rinse off the detergent with running water.
- 5) After rinsing, wipe off the vehicle body with a wet chamois or cloth and allow it to dry in the shade.
- 6) If your vehicle has a canvas top, special care should be taken to clean and preserve it.
  - a) After washing the canvas top, make sure it is completely dry before opening or removing.
  - b) If you use vinyl cleaner on the canvas top, do not allow any vinyl cleaner to run down and dry on the paint, leaving a streak.
  - c) Do not wash your canvas top at an automatic car wash.
  - d) Do not shower the canvas top with a strong spray of water, especially on the zippers and where the canvas meets the vehicle body.
  - e) When washing the plastic windows, follow the special directions outlined below.
- 7) Check carefully for damage to painted surfaces. If there is any damage, "touch-up" the damage following the procedure below:
  - a) Clean all damaged spots and allow them to dry.
  - b) Stir the paint and "touchup" the damaged spots lightly using a small brush.
  - c) Allow the paint to dry completely.

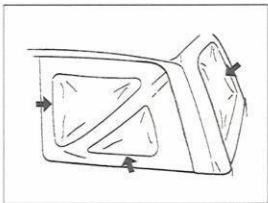

12-65D211A

### Cleaning plastic windows on canvas top

The plastic windows on the canvas top are so pliable that they can be scratched if special care is not taken. Care for your windows as outlined below:

- \* To wipe off dust, use a soft cotton cloth dampened with clean water. Move the cloth in one direction. Never use a dry cloth.
- \* To remove frost, snow or ice, use lukewarm water. Do not use a scraper or de-icing chemicals.
- \* To wash the windows, be sure to use lukewarm or cold water. Do not use hot water or strong soap or detergents. Never use solvents such as alcohol or harsh cleaning agents. After thoroughly rinsing,

wipe with a soft and slightly moist, clean cloth.

- \* Never paste stickers, gummed labels or any tape to the windows. It is very hard to remove adhesives left on the windows after removing such stickers or labels.



12-65D036A

### Waxing

After washing the vehicle, waxing and polishing are recommended to further protect and beautify the paint.

- \* Only use waxes and polishes of good quality.
- \* When using waxes and polishes, observe the precautions specified by the manufacturers.

# GENERAL INFORMATION

Identification Numbers .....	12-1
Safety Certification Label .....	12-2
Emission Compliance Label (for U.S.A.) .....	12-2
Warranties .....	12-3
Reporting Safety Defects .....	12-3

## GENERAL INFORMATION

65D-1302-A0E

### IDENTIFICATION NUMBERS

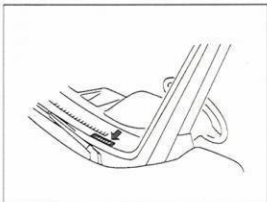

13-60A410A

#### Vehicle Identification Number

The Vehicle Identification Number (VIN) may be found in the two locations shown in the above illustrations. This number is used to register the vehicle. It is also used to assist your dealer when ordering parts or referring to special service information.

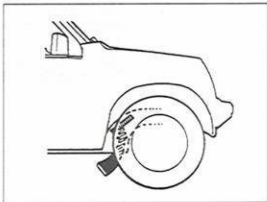

13-65D105A

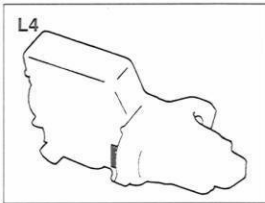

13-60G128A

#### Engine Serial Number

The engine serial number is stamped on the cylinder block as shown in the above illustration.



6SD-1303-A0E

## SAFETY CERTIFICATION LABEL

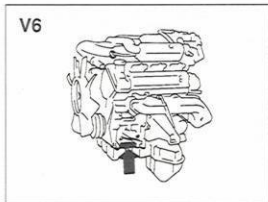

13-60A280A

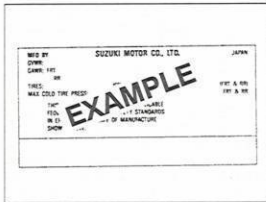

13-60A411A

This label contains important safety-related information about your vehicle. The label is located below the driver's side door latch striker.

6SD-1304-A0E

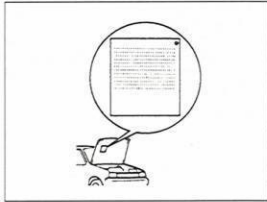
EMISSION COMPLIANCE LABEL  
(For U.S.A.)

13-60A412A

The EPA emission compliance label is located under the hood. It provides much of the information needed to perform an engine tune-up on your vehicle.

### WARRANTIES

The warranties covering your vehicle are explained in a separate New Vehicle Warranty Information booklet given to you at the time of sale. Please read this booklet carefully so you can understand your rights and responsibilities.

#### (For U.S.A.)

The following warranties are provided with your vehicle:

- New Vehicle Limited Warranty
- Limited Warranty For Suzuki Parts or Accessories
- Emission Components Defect Warranty
- Emission Performance Warranty

### REPORTING SAFETY DEFECTS

If you believe that your vehicle has a defect which could cause a crash or could cause injury or death, you should immediately inform the National Highway Traffic Safety Administration (NHTSA) in addition to notifying American Suzuki Motor Corp.

If NHTSA receives similar complaints, it may open an investigation, and if it finds that a safety defect exists in a group of vehicles, it may order a recall and remedy campaign. However, NHTSA cannot become involved in individual problems between you, your dealer, or American Suzuki Motor Corp.

To contact NHTSA, you may either call the Auto Safety Hotline toll-free at 1-800-424-9393 (or 366-0123 in Washington, D.C. area) or write to: NHTSA, U.S. Department of Transportation, Washington, D.C. 20590. You can also obtain other information about motor vehicle safety from the Hotline.

To contact American Suzuki, owners in the continental United States can call toll-free 1-800-934-0934, or write to:

American Suzuki Motor Corporation  
Automotive Customer Relations  
3251 East Imperial Highway  
Brea, CA 92821-6722

For owners outside the continental United States, please refer to the distributor's address listed in your Warranty Information booklet.

65D-1400-A0E

## FUSES AND PROTECTED CIRCUITS

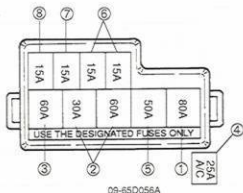

FUSES				
	COLOR-SIZE (AMPS)	PROTECTED CIRCUIT		
MAIN FUSE BOX	①	BLACK (80)	All Electric Loads.	In engine compartment
	⑤	RED (50)	Anti-lock Brake System	
	②	YELLOW (60)	Cigar lighter, Radio, I.G. Coil, Meter, Wiper, Washer, Rear defroster, Turn signal light, Back-up light.	
	②	PINK (30)	Hazard lights, Rear combination lights, Dome light, Horn.	
	③	YELLOW (60)	Heater	
	⑥	BLUE (15)	Right headlight.	
	⑥	BLUE (15)	Left headlight, High beam indicator	
	⑦	BLUE (15)	Electronic fuel injection system	
	⑧	BLUE (15)	Empty (2.5ℓ model), ACC socket (1.6ℓ/2.0ℓ models)	
A/C	④	CLEAR (25)	Air conditioning.	

## V-6 model

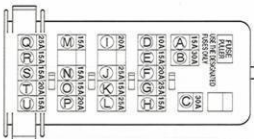

09-65D285A

**FUSES IN FUSE BOX**

Ⓐ	BLUE (15)	Empty
Ⓑ	PINK (30)	Heater blower
Ⓒ	PINK (30)	Power window
Ⓓ	RED (10)	Turn signal light, Back-up light
Ⓔ	BLUE (15)	Wiper & washer (Front & Rear)
Ⓕ	YELLOW (20)	Ignition coil, Fuel injection controller, Meter gages & indicators
Ⓖ	CLEAR (25)	Cigar lighter
Ⓗ	BLUE (15)	Accessory
Ⓘ	—	—
Ⓙ	CLEAR (25)	Rear defroster
Ⓚ	—	—
Ⓛ	—	—

**FUSES IN FUSE BOX**

Ⓜ	BLUE (15)	O <sub>2</sub> sensor heater
Ⓝ	BLUE (15)	License plate light, Clearance/marker light (Front & Rear), Instrument panel illumination light
Ⓞ	BLUE (15)	Fog light
Ⓟ	YELLOW (20)	Door lock control
Ⓠ	—	—
Ⓡ	YELLOW (20)	Empty
Ⓢ	BLUE (15)	Hazard light
Ⓣ	BLUE (15)	Brake light, Horn
Ⓤ	BLUE (15)	Dome light
Ⓥ	—	Fuse puller

## 4-cylinder model

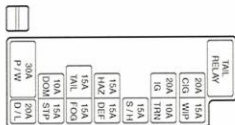

09-65D182A

## FUSES IN FUSE BOX

20A CIG (YELLOW)	Cigar lighter, Radio, Clock, Power mirror
20A IG (YELLOW)	O2 sensor heater, Cruise control, Ignition coil, Meter, G sensor
15A HAZ (BLUE)	Hazard light
15A TAIL (BLUE)	License plate light, clearance/marker light (Front & Rear), Instrument panel illumination light
10A DOM (RED)	Dome light, Spot light
30A P/W (PINK)	Power window
15A WIP (BLUE)	Wiper & washer (Front & Rear)
10A TRN (RED)	Turn signal light, Back-up light
15A S/H (BLUE)	Empty
15A DEF (BLUE)	Rear defroster, D.R.L. control
15A FOG (BLUE)	Fog light
15A STP (BLUE)	Brake light, Horn, High mount stop light
20A D/L (YELLOW)	Door lock control

---

MEMO

650-1500-ASE

## SPECIFICATIONS

## NOTE:

Specifications are subject to change without notice.

ITEM	CANVAS TOP	4-DOOR HARDTOP	
		4-cylinder model	V-6 model
<b>DIMENSIONS in. (mm)</b>			
Overall length	2.0L: 152.0 (3 861) 1.6L/4WD: 151.8 (3 856) 1.6L/2WD: 151.6 (3 851)	163.0 (4 141)	164.5 (4 178)
Overall width	67.3 (1 710)	67.3 (1 710)	70.1 (1 780)
Overall height	4WD/2.0L: 65.8 (1 671) 4WD/1.6L: 65.9 (1 675) 2WD/2.0L: 65.0 (1 651) 2WD/1.6L: 64.8 (1 647)	4WD: 65.8 (1 671) 2WD: 65.0 (1 651)	4WD: 67.8 (1 722) 2WD: 67.3 (1 710)
Wheelbase	86.6 (2 200)	97.6 (2 480)	97.6 (2 480)
Tread, front/rear	57.5 (1 460)	57.5 (1 460)	59.1 (1 500)
Ground clearance	7.0 ( 179) – 7.2 ( 183)	↔	6.9 ( 175)
<b>WEIGHT</b>			
Curb weight lbs (kg)	2 624 – 2 844 (1 190) (1 290)	2 866 – 3 020 (1 300) (1 370)	3 064 – 3 197 (1 390) (1 450)
Gross axle weight rating	See the safety certification label.		
Gross vehicle weight rating	See "SAFETY CERTIFICATION LABEL" in "GENERAL INFORMATION" section.		

4WD : 4-wheel drive

2WD : 2-wheel drive

A/T : Automatic transmission

A/C : Air conditioning

P/S : Power steering

# SPECIFICATIONS

ITEM	ALL MODELS		
<b>ENGINE</b>			
Type	G16B (16 valve SOHC)	J20A (16 valve DOHC)	H25A (24V DOHC)
Number of cylinders	4	4	6
Bore	2.95 in. (75.0mm)	3.31 in. (84.0mm)	3.31 in. (84.0mm)
Stroke	3.54 in. (90.0mm)	3.54 in. (90.0mm)	2.95 in. (75.0mm)
Piston displacement	97.0 cu.in (1590cc, 1590cm <sup>3</sup> )	121.7 cu.in (1995cc, 1995cm <sup>3</sup> )	152.1 cu.in (2493cc, 2493cm <sup>3</sup> )
Compression ratio	9.5 : 1	9.3 : 1	9.5 : 1
<b>ELECTRICAL</b>			
Ignition timing	5° B.T.D.C.		
Standard spark plug 1.6ℓ engine model 2.0ℓ/2.5ℓ engine models	DENSO SK20PR-A11 or NGK IFR6E11 (Highly recommended) DENSO SK16PR11 or NGK IFR5J11 (Highly recommended)		
Battery	12V GP26-50S ..... 1.6ℓ, 12V GP85 ..... 2.0ℓ, 12V GP24 ..... 2.5ℓ		
Fuses	See "INSPECTION AND MAINTENANCE" and "FUSES AND PROTECTED CIRCUITS" sections		
Headlight	12V 60/55W		
Turn signal light	12V 21W		
Side marker light	12V 3.8W		
Clearance light	12V 5W		
Turn signal light/Clearance light	12V 27/8W		
Tail/brake light	12V 5/21W		
Licence plate light	12V 5W		
Back-up light	12V 21W		
Interior light (Except mirror mount type)	12V 5W (Spot light/Rear light) 8W (Center light)		
Meter pilot, warning, indicator lights	12V 1.4W		
High-mount stop light (Single bulb type) (Multi bulb type)	12V 18W 12V 5W × 5 (For clear window glass), 12V 18W × 2 (For dark window glass)		



ITEM	ALL MODELS
<b>WHEEL</b> Tire size, front and rear  Tire pressure	P205/75R15 ..... 1.6ℓ 4WD, P195/75R15 ..... 1.6ℓ 2WD, P215/65R16 ..... 2.0ℓ P235/60R16 ..... 2.5ℓ  For the specified tire pressure, see the Tire Inflation Pressure Label located on the driver's door lock pillar.
<b>STEERING</b> Toe-in Camber angle Caster angle	0 ± 0.08 in. (0 ± 2mm) 0° 00' 2.4°
<b>CAPACITIES</b> Coolant  Fuel tank  Engine oil (Replaced with filter) Transmission oil  Differential gear oil Front: Rear:  Transfer gear box oil	5.5 L (11.6 US pt) .... G16B 6.5 L (13.8 US pt) .... J20A 8.0 L (14.8 US pt) .... H25A  56 L (14.8 US gal) .... 2 DOOR 66 L (17.4 US gal) .... 4 DOOR  4.2 L (4.4 quarts) .... G16B, 5.2 L (5.5 quarts) .... J20A, 5.5 L (5.8 quarts) .... H25A Manual Transmission: 1.5 L (3.2 US pt) .. 4WD 1.9 L (4.0 US pt) .. 2WD 4-speed Automatic Transmission: 2.5 L (5.3 US pt) (when drained)  1.0 L (2.1 US pt) .... 4WD 2.2 L (4.6 US pt)  1.7 L (3.6 US pt) ..... 2WD/4WD



## INDEX

"4WD" Indicator Light ..... 4-7

## A

"AIR BAG" Light ..... 4-5  
 Accelerator Pedal ..... 5-2  
 Accessory Socket ..... 5-25  
 Adjusting Seat Position ..... 2-9  
 Adjusting Seatbacks ..... 2-10  
 Air Cleaner ..... 9-17  
 Air Conditioning System ..... 4-14  
 Anti-Lock Brake System (ABS) ..... 6-9  
 Anti-Lock Brake System (ABS) Warning Light ..... 4-4  
 Ashtray ..... 4-11  
 Assist Grips ..... 5-25  
 Automatic Transmission Fluid ..... 9-13

## B

Battery ..... 9-26  
 Brake Pedal ..... 5-2  
 Brake System Warning Light ..... 4-3  
 Brakes ..... 9-19  
 Braking ..... 6-9  
 Break-in ..... 6-11  
 Bulb Replacement ..... 9-32

## C

"CRUISE" Indicator Light ..... 4-6  
 Canvas Top ..... 5-8  
 Catalytic Converter ..... 6-11  
 Changing Engine Oil and Filter ..... 9-9

Charging Light ..... 4-4  
 Child Lock System ..... 2-5  
 Child Restraint Systems ..... 2-18  
 Cigarette Lighter ..... 4-10  
 Clock ..... 4-11  
 Clutch Pedal ..... 5-1, 9-22  
 Corrosion Prevention ..... 11-1  
 Cruise Control ..... 3-8  
 Cup Holder ..... 5-27

## D

Daily Inspection Checklist ..... 6-1  
 Day-Night Rearview Mirror ..... 2-8  
 Defrosting ..... 4-14  
 Door Locks ..... 2-2  
 Drive Belt ..... 9-7  
 Driver's Side Floor Mat ..... 5-23

## E

Emergency Remedies ..... 10-4  
 Emission Compliance Label ..... 12-2  
 Engine Block Heater ..... 6-3  
 Engine Coolant ..... 9-15  
 Engine Hood ..... 5-26  
 Engine Oil and Filter ..... 9-8  
 Engine Serial Number ..... 12-1  
 Ethanol ..... 1-1  
 Exhaust Gas Warning ..... 6-1

## F

Flat Folding Front Seats ..... 5-5

- Folding Rear Seats ..... 5-5  
Folding Seats ..... 5-5  
Frame Hooks ..... 5-27  
Free Axle Mechanism ..... 5-3  
Front and Rear Lap-Shoulder Belts ..... 2-14  
Front Seat Armrest ..... 5-8  
Front Seat Back Pocket ..... 5-28  
Fuel Filler Cap ..... 5-4  
Fuel Gauge ..... 4-8  
Fuel Recommendation ..... 1-1  
Fuses ..... 9-26  
Fuses and Protected Circuits ..... 13-1
- G**
- Gear Oil ..... 9-11  
Gearshift Lever ..... 5-2  
Glove Box ..... 4-11
- H**
- Hazard Warning Switch ..... 4-9  
Head Restraints ..... 2-11  
Headlight Aiming ..... 9-31  
Headlight Housing Replacement ..... 9-29  
Heater System ..... 4-12  
High Beam Indicator Light ..... 4-6  
Horn ..... 3-9
- I**
- Identification Numbers ..... 12-1  
Ignition Key Reminder ..... 2-1
- Ignition Switch ..... 3-1  
Important Vehicle Design Features to Know ..... 7-1  
Improving Fuel Economy ..... 6-12  
Installation with a Lap Belt ..... 2-21  
Instrument Light Brightness Control ..... 4-9  
Instrument Panel ..... 4-1  
Interior Light Switch ..... 5-24
- J**
- Jacking Instructions ..... 10-1  
Jump Starting Instructions ..... 10-2
- K**
- Keyless Entry System ..... 2-3  
Keys ..... 2-1
- L**
- Lane Change Signal ..... 3-5  
Lap Belt ..... 2-15  
Lighting Control Lever ..... 3-3  
Lights "On" Reminder ..... 3-5  
Luggage Compartment Cover ..... 5-30  
Luggage Restraint Loops ..... 5-29
- M**
- Maintenance Schedule ..... 9-2  
Malfunction Indicator Lamp ..... 4-5  
Manual Window Control ..... 2-6  
Methanol ..... 1-1  
Mirrors ..... 2-8

MTBE .....	1-1
<b>O</b>	
"O/D OFF" Indicator Light .....	4-6
Odometer .....	4-7
Off-Road Driving .....	7-3
Oil Level Check .....	9-8
Oil Pressure Light .....	4-4
On-Pavement Driving .....	7-2
Opening and Closing the Rear Window .....	5-11
Outside Rearview Mirrors .....	2-8
<b>P</b>	
"POWER" Indicator Light .....	4-6
Parking Brake Lever .....	5-1
Pedals .....	5-1
Periodic Maintenance Schedule .....	9-3
Power Assisted Brakes .....	6-9
Power Door Locking System .....	2-2
Power Mirror Control .....	2-9
Power Steering Fluid .....	9-21
Power Window Controls .....	2-6
<b>R</b>	
Rear Door Lock .....	2-5
Rear Window Defroster Switch .....	4-10
Rear Window Wiper/Washer Switch .....	4-10
Refilling .....	9-9
Replacement of the Transmitter Battery .....	2-4
Reporting Safety Defects .....	12-3

Roof Rails .....	5-31
<b>S</b>	
Safety Certification Label .....	12-2
Seat Adjustment .....	2-9
Seat Belt Extender .....	2-22
Seat Belt Warning Light .....	4-5
Seat Belts and Child Restraint Systems .....	2-12
Shoulder Anchor Height Adjuster .....	2-15
Side Door Locks .....	2-2
Snow Tires .....	9-25
Spare Tire Nut Lock .....	2-1
Spark Plugs .....	9-17
Specifications .....	14-1
Speedometer .....	4-7
Spot Light .....	5-24
Starting the Engine .....	6-2
Steering Wheel .....	9-21
Sun Visor .....	5-23
Supplemental Restraint System .....	2-23
<b>T</b>	
Tachometer .....	4-8
Temperature Gauge .....	4-9
Tilt Steering Lock Lever .....	3-7
Tire Changing Tools .....	5-28
Tire Rotation .....	9-25
Tires .....	9-22
Towing a Disabled Vehicle .....	10-4
Towing Your Vehicle .....	8-7

Trailer Towing .....	8-2
Transfer Lever .....	5-3
Tripmeter .....	4-7
Turn Signal Control Lever .....	3-3
Turn Signal Indicators .....	4-6

**U**

Underseat Tray .....	5-29
Uniform Tire Quality Grading .....	9-24
Using the Transfer Lever .....	6-7
Using the Transmission .....	6-3

**V**

Vehicle Cleaning .....	11-3
Vehicle Identification Number .....	12-1
Vehicle Loading .....	8-1

**W**

Walk-In Type Seats .....	2-10
Warning and Indicator Lights .....	4-3
Warranties .....	12-3
Washing .....	11-4
Waxing .....	11-5
Windows .....	2-6
Windshield Washer .....	3-6
Windshield Washer Fluid .....	9-16
Windshield Wiper and Washer Lever .....	3-6
Windshield Wipers .....	3-6
Wiper Blades .....	9-37

Prepared by

**SUZUKI MOTOR CORPORATION**

Overseas Service Department

June, 2000

Part No. 99011-65D22-03E

Printed in Japan

TP190

65D-1800-A0E

## SERVICE STATION INFORMATION

**Fuel recommendation:**

See page 1-1

**Engine oil recommendation:**

Engine oil with "STARBURST" symbol

For further details, see "ENGINE OIL AND FILTER" in the "INSPECTION AND MAINTENANCE" section.

**Brake and clutch fluid:**

DOT3

**Automatic transmission fluid:**

An equivalent of DEXRON<sup>®</sup>-III.

**Tire cold pressure:**

See the "Tire Inflation Pressure Label" located on the driver's door lock pillar.



Made from 100% recycled paper,  
except for cover.



99011-65D22-03E

**SUZUKI MOTOR CORPORATION**

Printed in Japan