

General Information

GENERAL INFORMATION	GI - 2
RECOMMENDED LUBRICANTS AND CAPACITIES	GI -12
MAINTENANCE INFORMATION	GI -13

GENERAL INFORMATION

HOW TO USE THIS MANUAL EAMB1000

This manual is divided into 21 sections. The first page of each section is marked with a black tab at the edge of the page. You can quickly find the first page of each section without looking through the whole table of contents.

Each section includes the essential removal, installation, adjustment and maintenance procedures for servicing all body styles. This information is correct at the time of publication.

An **INDEX** is provided on the first page of each section to guide you to the appropriate item.

TROUBLESHOOTING tables are included for each system to help you diagnose the problem and find the cause. The repair for each possible cause is referred to in the remedy column to lead you to the solution quickly.

DEFINITION OF TERMS

STANDARD VALUE (SERVICE STANDARD)

Indicates the value used when a part or assembled item should be inspected or the value to which a part or assembled item should be adjusted after reinstallation. It is given as a tolerance.

SERVICE LIMIT

Indicates the maximum or minimum value that a part or assembled item must meet when inspected. It is a value established beyond the standard value.

NOTE, WARNING, CAUTION, ABBREVIATION

NOTE

Information needed in reference to a repair service.

CAUTION

Information about an activity that could cause damage to the vehicle.

WARNING

Information about an activity that could cause injury or damage to the driver, occupants or repairman.

ABBREVIATIONS

DOHC : Double Over Head Camshaft

V6 : V-type 6 Cylinder

I4 : Inline 4 Cylinder

VEHICLE IDENTIFICATION NUMBER LOCATION

The vehicle identification number (VIN) is located on the right side of rear frame and on the driver's side of the dash cover.

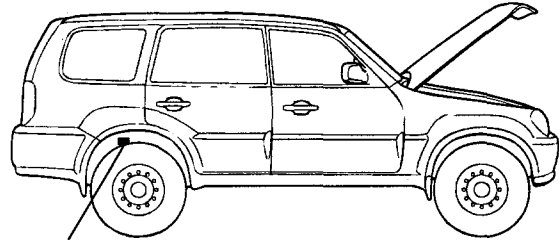

VIN. NO.

KAMB100A

VEHICLE IDENTIFICATION NUMBER

The Vehicle identification number consists of 17 digits.

K	M	H	N	M	8	3	C	P	Y	U	0	0	0	0	0	1
1	2	3	4	5	6	7	8	9							10	

EAMB100A

1. W.I.C. (World manufacturer's Identification Code)
KMH - Hyundai Motor Company, Korea
2. Vehicle Line
N : TERRACAN
3. Model & Series
L : Standard(L)
M : Deluxe (GL)
N : Super deluxe (GLS)
4. Body Type
8 : Wagon
5. Restraint system or brake system
1 - A / Belt (Driver side + Passenger side)
2 - P / Belt (Driver side + Passenger side)
3 - Driver side : A / Belt + A / Bag, Passenger side : A / Belt or P / Belt
4 - A / Belt + A / Bag (Driver side + Passenger side)

NOTE

A / Belt : Active belt

P / Belt : Passive belt

A / Bag : Air bag

6. Engine type
C : G 3.5 V6
W : D 2.5 I4
X : D 2.9 I4
7. Driver side
P : LHD (Left hand driver)

R : RHD (Reft hand driver)

8. Production year
Y - 2000 Model Year, 2 - 2002 Model year
1 - 2001 Model Year, 3 - 2003 Model year
9. Production plant
U - Ulsan (Korea)
10. Vehicle production sequence number
000001 - 999999

000001 - 999999

TRANSAXLE IDENTIFICATION NUMBER LOCATION

DESCRIPTION (MANUAL TRANSAXLE)

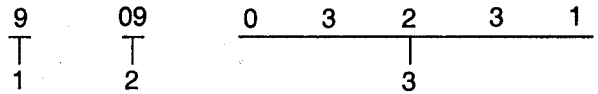

ENGINE IDENTIFICATION NUMBER LOCATION

The engine identification number is stamped on the right front side of the top edge of the cylinder block.

EAJB001X

V6

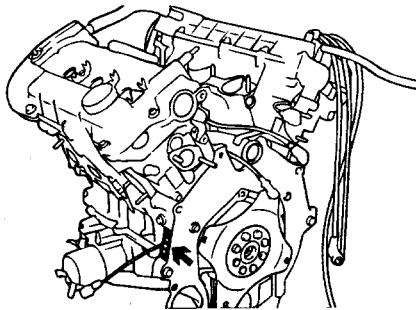

EAA9004A

DESCRIPTION OF ENGINE IDENTIFICATION NUMBER

The engine identification number consists of 11 digits.

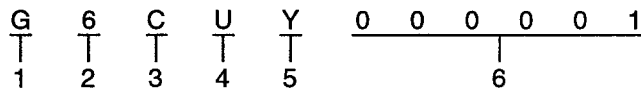

EAMB100B

1. Engine fuel
G - Gasoline
D - Diesel
2. Engine range
4 - In line 4 cycle 4 cylinder
6 - V type 4 cycle 6 cylinder
3. Engine development order
C - V6 sigma Engine
B - 4D56 Engine
4. Engine capacity
V - 3496cc
H - 2467cc
5. Production year
Y - 2000
1 - 2001
2 - 2002
3 - 2003
6. Engine production sequence number

1. Production year
9 : 1999
0 : 2000
1 : 2001
2. Production month
09-9 (September)
12-12 (December)
3. Transmission production sequence number
000001 ~ 999999

DESCRIPTION (AUTOMATIC TRANSAXLE)

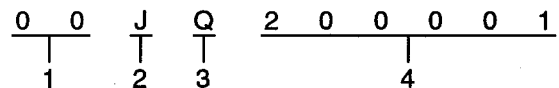

EAMB100C

1. Production year
00 - 2000
01 - 2001
2. Production month
J - 9
3. Model
Q - 03 - 7ILE
4. Production sequence number

PROTECTION OF THE VEHICLE

Always be sure to cover fenders, seats, and floor areas before starting work.

CAUTION

The support rod must be inserted into the hole near the edge of the hood whenever you inspect the engine compartment to prevent the hood from falling and causing possibly injury. Make sure that the support rod has been released prior to closing the hood. Always check to be sure the hood is firmly latched before driving the vehicle.

A WORD ABOUT SAFETY

The following precautions must be followed when jacking up the vehicle.

1. Block the wheels.
2. Place a jack under the specified jacking point.
3. Support the vehicle with safety stands (jack stands) Refer to page GI-10.
4. Start the engine when engine compartment is clean.

PREPARATION OF TOOLS AND MEASURING EQUIPMENT

Be sure that all necessary tools and measuring equipments are available before starting work.

SPECIAL TOOLS

Use special tools when required.

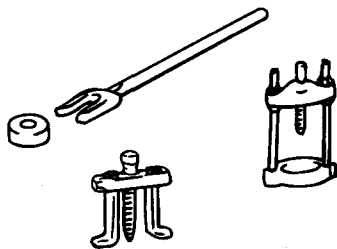

EAA9006A

REMOVAL OF PARTS

First find the cause of the trouble and then make sure whether removal or disassembly is required before starting the job.

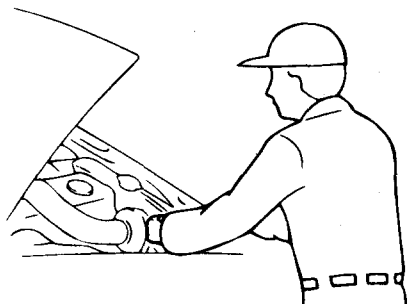

EADA010I

DISASSEMBLY

If the disassembly procedure is complex and requires many parts to be disassembled, all parts should be disassembled in a way that will not affect their performance or external appearance.

1. Inspection of parts

Each part, when removed, should be carefully inspected for malfunction, deformation, damage, and other problems.

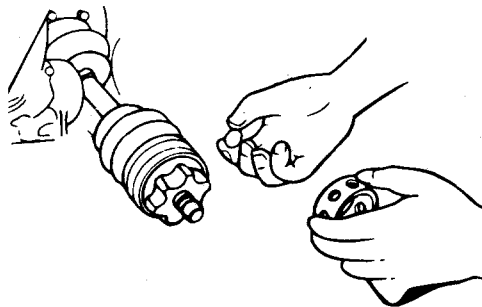

EADA010J

2. Arrangement of parts

All disassembled parts should be carefully arranged for effective reassembly.

Be sure to separate and correctly identify the parts to be replaced from those that will be used again.

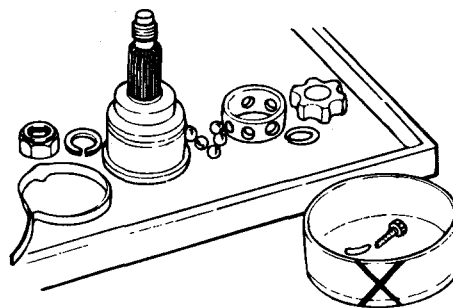

EAA9008B

3. Cleaning parts for reuse

All parts to be used again should be carefully and thoroughly cleaned by the appropriate method.

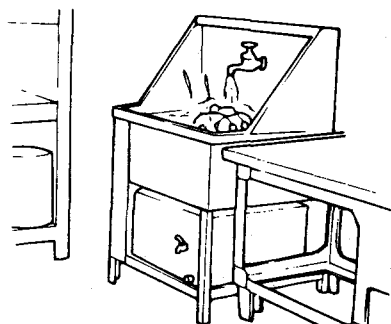

EADA010K

PARTS

When replacing parts, use HYUNDAI genuine parts.

HYUNDAI
Genuine
Parts



Made in Korea

EADA010M

REPLACEMENT

Standard values, such as torques and certain adjustments, must be strictly observed in the reassembly of all parts.

If removed, the following parts should be always replaced with new ones.

1. Oil seals
2. Gaskets
3. O-rings
4. Lock washers
5. Cotter pins (split pins)
6. Plastic nuts

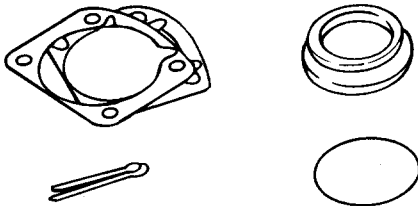

EADA010N

Depending on their location.

1. Sealant should be applied to gaskets.
2. Oil should be applied to the moving components of parts.
3. Specified oil or grease should be applied to the prescribed locations (oil seals, etc.) before assembly.

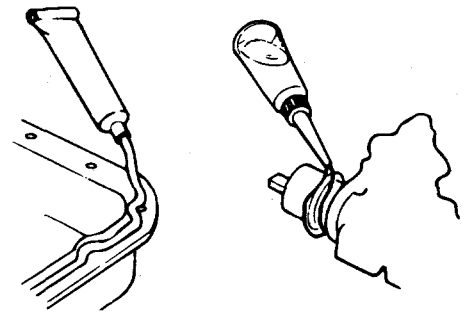

EADA010O

ADJUSTMENT

Use gauges and testers to adjust correctly the parts to standard values correctly.

ELECTRICAL SYSTEM

1. Be sure to disconnect the battery cable from the negative (-) terminal of the battery.
2. Never pull on the wires when disconnecting connectors.
3. Locking connectors will click when the connector is secure.
4. Handle sensors and relays carefully. Be careful not to drop them or hit them against other parts.

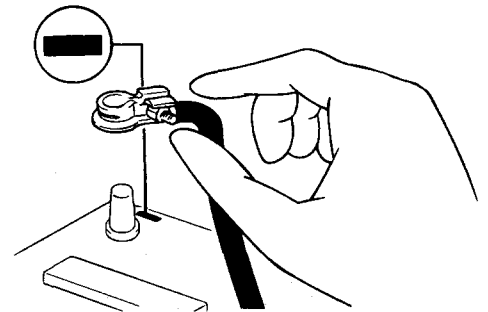

EAA9011A

RUBBER PARTS AND TUBES

Always prevent gasoline or oil from touching rubber parts or tubing.



EADA010Q

MEASURING BODY DIMENSIONS

1. Basically, all measurements in this manual are taken with a tracking gauge.
2. When a measuring tape is used, check to be sure there is no elongation, twisting or bending.
3. For measuring dimensions, both projected dimensions and actual-measurement dimensions are used in this manual.

DIMENSIONS PROJECTED

1. These are the dimensions measured when the measurement points are projected from the vehicle's surface, and are the reference dimensions used for body alterations.
2. If the length of the tracking gauge probes is adjustable, measure it by lengthening one of the two probes as long as the height of the two surfaces are different.

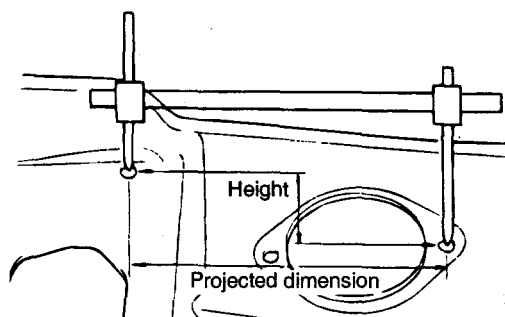

EADA011M

MEASURING ACTUAL DIMENSIONS

1. These dimensions indicate the actual linear distance between measurement points, and are used as the reference dimensions when a tracking gauge is used for measurement.
2. First adjust both probes to the same length ($A=A'$) before measurement.

NOTE

Check the probes and gauge itself to make sure there is no free play.

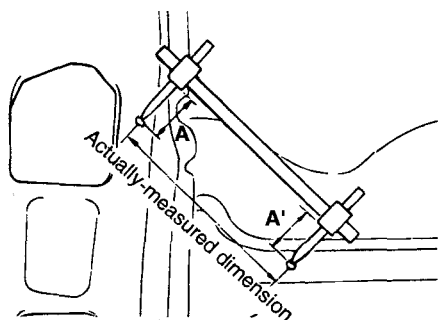

EADA011N

MEASUREMENT POINT

Measurement should be taken at the center of the hole.

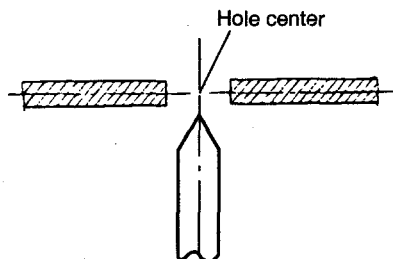

EADA011O

CHECKING CABLES AND WIRES

1. Check the terminal for tightness.
2. Check terminals and wires for corrosion from battery electrolyte, etc.
3. Check terminals and wires for open circuits.
4. Check wire insulation and coating for damage, cracks and degrading.
5. Check the conductive parts of terminals for contact with other metallic parts (vehicle body and other parts).
6. Check grounded parts to verify that there is complete continuity between their attaching bolt(s) and the vehicle's body.
7. Check for incorrect wiring.
8. Check that the wiring is clamped firmly to prevent contact with sharp corners of the vehicle body, etc. or hot parts (exhaust manifold, etc.)
9. Check that the wiring is clamped firmly to provide enough clearance from the fan pulley, fan belt and other rotating or moving parts.
10. Check that the wiring has a little space so that it can vibrate between the fixed and moving parts such as the vehicle body and the engine.

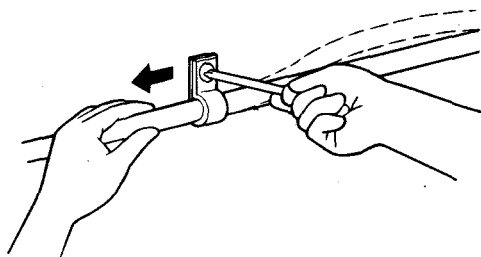

EADA011B

CHECKING FUSES

A blade type fuse has test taps provided to allow checking the fuse itself without removing it from the fuse block. The fuse is good if the test lamp lights up when its one lead is connected to the test taps (one at a time) and the other lead is grounded. (Turn the ignition switch so that the fuse circuit becomes operative.)

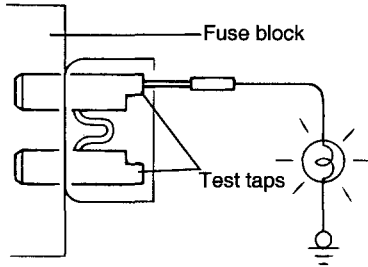

EAA9014B

2. Attach the wiring harnesses with clamps so that there is no slack. However, for any harness which passes the engine or other vibrating parts of the vehicle, allow some slack within a range that does not allow the engine vibrations to cause the harness to come into contact with any of the surrounding parts, and then secure the harness by using a clamp.

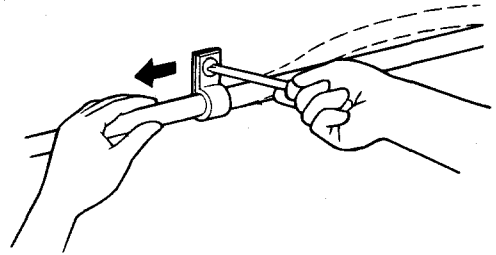

EADA011B

SERVICING THE ELECTRICAL SYSTEM

1. Prior to servicing the electrical system, be sure to turn off the ignition switch and disconnect the battery ground cable.

NOTE

In the course of MFI or ELC system diagnosis, when the battery cable is removed, any diagnostic trouble code retained by the computer will be cleared. Therefore, if necessary, read the diagnostic codes before removing the battery cable.

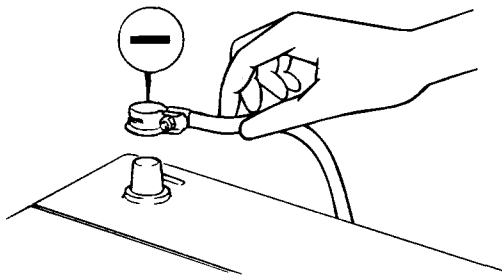

EADA011A

3. If any section of a wiring harness interferes with the edge of a part, or a corner, wrap the section of the harness with tape or something similar in order to protect it from damage.

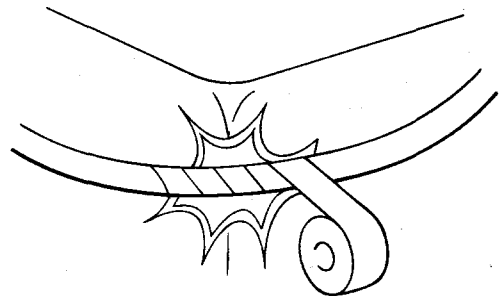

EADA011C

4. When installing any parts, be careful not to pinch or damage any of the wiring harnesses.

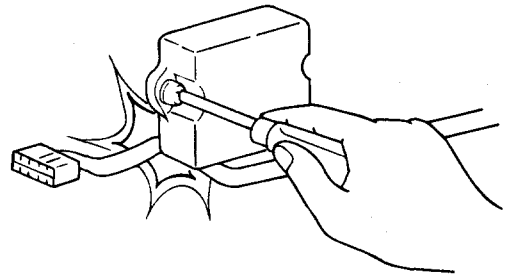

EADA011D

5. Never throw relays, sensors or electrical parts, or expose them to strong shock.

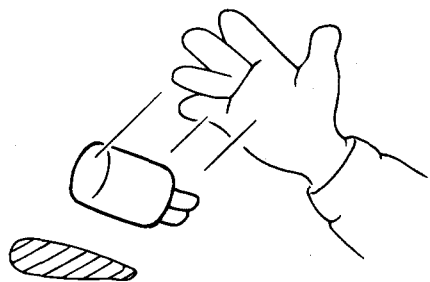

EADA011E

6. The electronic parts used in the computer, relays, etc. are readily damaged by heat. If there is a need for service operations that may cause the temperature to exceed 80°C (176°F), remove the electronic parts beforehand.

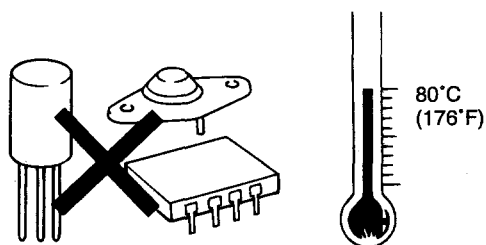

EADA011F

7. Loose connectors cause problems. Make sure that the connectors are always securely fastened.

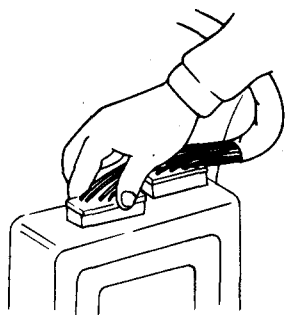

EADA011G

8. When disconnecting a connector, be sure to grip only the connector, not the wires.

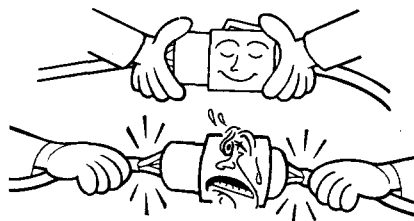

EADA011H

9. Disconnect connectors which have catches by pressing in the direction of the arrows shown the illustration.

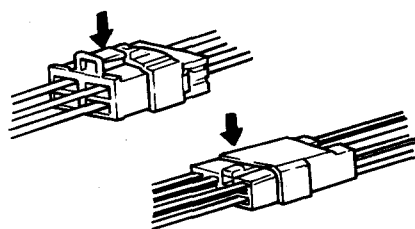

EADA011I

10. Connect connectors which have catches by inserting the connectors until they make a clicking sound.

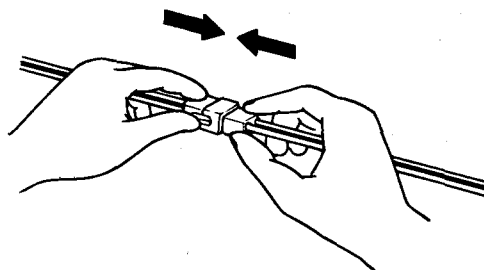

EADA011J

11. When, using a circuit tester, to check continuity or voltage on connector terminals, insert the test probe into the harness side. If the connector is a sealed connector, insert the test probe through the hole in the rubber cap until it contacts the terminal, being careful not to damage the insulation of the wires.

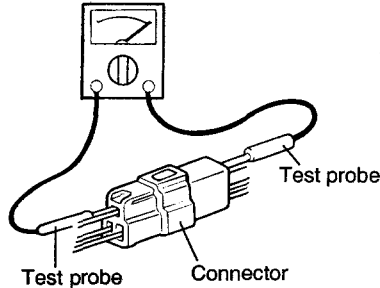

EADA011K

12. To avoid overloading the wiring, take the electrical current load of the optional equipment into consideration, and determine the appropriate wire size.

Nominal size	SAE gauge No.	Permissible current	
		In engine compartment	Other areas
0.3 mm ²	AWG 22	-	5A
0.5 mm ²	AWG20	7A	13A
0.85 mm ²	AWG18	9A	17A
1.25 mm ²	AWG16	12A	22A
2.0 mm ²	AWG14	16A	30A
3.0 mm ²	AWG12	21A	40A
5.0 mm ²	AWG10	31A	54A

PRECAUTIONS FOR CATALYTIC CONVERTER

CAUTION

If a large amount of unburned gasoline flows into the converter, it may overheat and create a fire hazard. To prevent this, observe the following precautions and explain them to your customer.

1. Use only unleaded gasoline.
2. Do not run the engine while the car is at rest for a long time. Avoid running the engine at fast idle speed for more than 10 minutes and at idle speed for more than 20 minutes.
3. Avoid spark- jump tests. Do spark- jumps only when absolutely necessary. Perform this test as rapidly as possible and, while testing, never race the engine.

4. Do not measure engine compression for an extended time. Engine compression tests must be made as rapidly as possible.
5. Do not run the engine when the fuel tank is nearly empty. This may cause the engine to misfire and create an extra load on the converter.
6. Avoid coasting with the ignition turned off and during prolonged braking.
7. Do not dispose of a used catalytic converter together with parts contaminated with gasoline or oil.

SRS SYSTEM COMPONENTS INFORMATION

CUSTOMER CAUTIONS

Failure to carry out service operations in the correct sequence could cause the airbag system to be deployed unexpectedly during servicing, and a serious accident to occur. Further, if there is a mistake in servicing the airbag system, it is possible the airbag may fail to operate when required. Before performing service (including removal or installation of parts, inspection or replacement), be sure to read the following items carefully, then follow the correct procedures described in the repair manual.

1. Work must be started approx. 30 seconds or longer after the ignition switch is turned to the LOCK position and the negative (-) battery cable is disconnected. (The airbag system is equipped with a back-up power source. If work is started within 30 seconds after disconnecting the negative (-) terminal cable of the battery, the airbag may be operative.) When the negative (-) terminal cable is disconnected from the battery, the clock and audio systems memories will be erased. Before starting work, record the setting of the audio memory system. When work is finished, reset the audio system as before and adjust the clock.
2. Malfunction symptoms of the airbag system are difficult to confirm, so diagnostic codes become the most important source of information when troubleshooting. When troubleshooting the airbag system, always read the diagnostic codes before disconnecting the battery.
3. Never use airbag parts from another vehicle. When replacing parts, replace them with new parts.
4. Never attempt to disassemble and repair the airbag modules, SRSCM, clock spring and airbag wiring harness in order to reuse it.
5. If the SRSCM or airbag module has been dropped, or if there are cracks, dents or other defects in the case, bracket or connector, replace them with new ones.
6. After work on the airbag system is completed, re-set the SRS SRI.

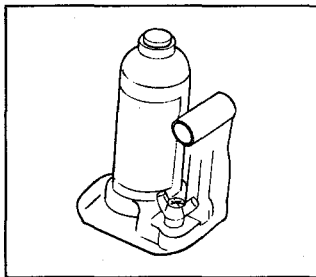
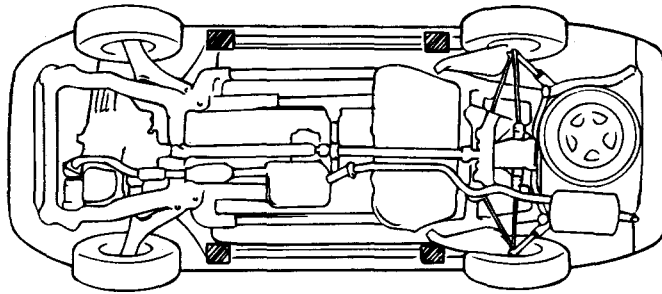

The jack provided with the vehicle (for reference)

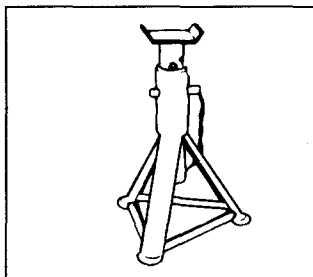

Rigid rack (Safety stand)

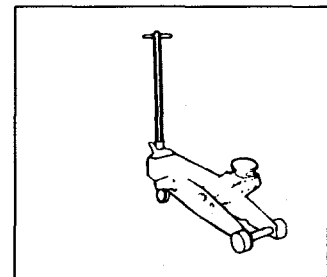

Garage jack (floor Jack)

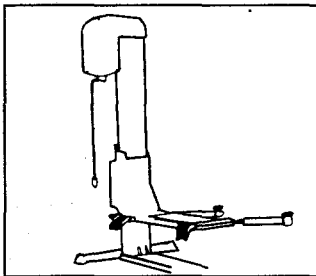

Single post lift

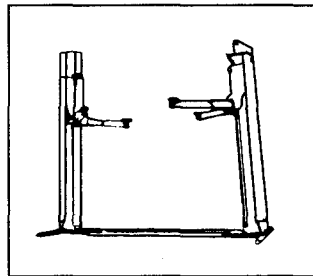

Double post lift

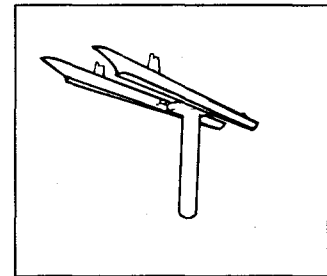



Free wheel type of auto lift (H bar lift)

EAMB100D

⚠ CAUTION

1. Never use a jack beneath the lateral rod or rear suspension assembly.
2. In order to prevent scratching the sub frame, place a piece of cloth on the jack's contact surface (to prevent corrosion caused by damage to the coating).
3. Never support vehicle with only a jack. Always use safety stands.
4. Do not attempt to raise one entire side of the vehicle by placing a jack midway between the front and rear wheels. To do so could result in permanent damage to the body.

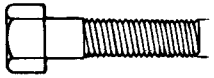
TIGHTENING TORQUE TABLE OF STANDARD PARTS

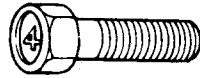
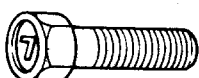
Bolt nominal diameter (mm)	Pitch (mm)	Torque Nm (kg.cm, lb.ft)	
		Head Mark 4	Head Mark 7
 EADA010R	 EADA010S	 EADA010T	 EADA010U
M5	0.8	3-4 (30-40, 2.2-2.9)	5-6 (50-60, 3.6-4.3)
M6	1.0	5-6 (50-60, 3.6-4.3)	9-11 (90-110, 6.5-8.0)
M8	1.25	12-15 (120-150, 9-11)	20-25 (200-250, 14.5-18.0)
M10	1.25	25-30 (250-300, 18-22)	30-50 (300-500, 22-36)
M12	1.25	35-45 (350-450, 25-33)	60-80 (600-800, 43-58)
M14	1.5	75-85(750-850,54-61)	120-140(1,200-1,400,85-100)
M16	1.5	110-130(1,100-1,300,80-94)	180-210(1,800-2,100, 130-150)
M18	1.5	160-180(1,600-1,800, 116-130)	260-300(2,600-3,000, 190-215)
M20	1.5	220-250 (2,200-2,500, 160-180)	360-420 (3,600-4,200,260-300)
M22	1.5	290-330 (2,900-3,300, 210-240)	480-550 (4,800-5,500,350-400)
M24	1.5	360-420 (3,600-4,200, 260-300)	610-700 (6,100-7,000, 440-505)

 NOTE

- The torques shown in the table are standard values under the following conditions:
 - Nuts and bolts are made of steel bar, and galvanized.
 - Galvanized plain steel washers are inserted.
 - All nuts, bolts, and plain washers are dry.
- The torques shown in the table are not applicable:
 - When Spring washers, toothed washers and the like are inserted.
 - If plastic parts are fastened.
 - If self-tapping screws or self-locking nuts are used.
 - If threads and surface are coated with oil.
- If you reduce the torques in the table to the percentage indicated below, under the following conditions, it will be the standard value.
 - If spring washers are used. : 85%
 - If threads and bearing surfaces are stained with oil. : 85%

RECOMMENDED LUBRICANTS AND CAPACITIES

RECOMMENDED LUBRICANTS EAMB2000

Parts	Specifications	Remarks
Engine oil	API Classification SG Above	For further details, refer to SAE viscosity number
Manual transaxle	API classification GL-4	SAE grade number: SAE 75W/90
Automatic transaxle	GENUINE HYUNDAI transaxle oil, GENUINE DIAMOND ATF SP-II M	
Brake	DOT 3 or DOT 4	
Cooling system	High quality ethylene glycol	Concentration level 50% (normal) Concentration level 40% (tropical)
Power steering	PSF-3	
Transaxle linkage, parking brake cable mechanism, hood lock and hook, door latch, seat adjuster, trunk latch, door hinges, trunk hinges	Multipurpose grease NLGI grade #2	

M/EAST : Middle East, GEN.: General Areas
 AUST.: Australia, EC : European Community

LUBRICANTS CAPACITIES

Description		Capacities	
		2.5 I4	3.5 V6
Engine oil	Oil pan	5.8 (6.6, 5.5)	4.1 (4.66, 3.88)
	Oil filter	0.7 (0.8, 0.66)	0.3 (0.32, 0.26)
	Total	6.5 (7.4, 6.15)	4.4 (5, 4.2)
Cooling system		8 (9, 7.6)	11 (12.5, 10.4)
Manual transaxle		2.5 (2.64, 2.2)	2.5 (2.64, 2.2)
Automatic transaxle		8.2 (8.66, 7.21)	10.46 (11.0, 9.2)
Power steering		1.0 (1.05, 0.88)	1.0 (1.05, 0.88)

liter (U.S. qts., Imp. qts.)

MAINTENANCE INFORMATION

CHANGING ENGINE OIL EAMB3000

1. If the engine is cold, run the engine until it reaches normal operating temperature.
2. Turn off the engine.
3. Remove the oil filler cap and drain plug. Drain the engine oil.
4. Tighten the drain plug to the specified torque.

Tightening torque

Oil pan drain plug :

35-45 N.m (350-450 kg.cm, 25-33 lb.ft)

NOTE

Whenever tightening the oil drain plug, use a new drain plug gasket.

5. Fill new engine oil through the oil filler cap opening.

NOTE

Do not overfill, this will cause oil aeration and loss of oil pressure.

6. Install the oil filler cap.
7. Start and run the engine.
8. Turn off the engine and then check the oil level. Add oil if necessary.

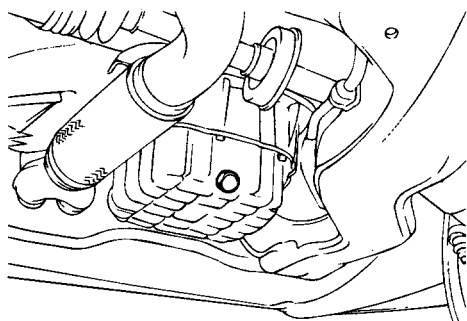

ECA9081A

REPLACING THE ENGINE OIL FILTER

1. Use a filter wrench to remove the oil filter.
2. Before installing a new oil filter on the engine, apply clean engine oil to the surface of the rubber gasket.
3. Tighten the oil filter to the specified torque.

Tightening torque

Oil filter : 12 -16 N.m (120-160 kg.cm, 9-12 lb.ft)

4. Start and run the engine and check for engine oil leaks.
5. After turning off the engine, check the oil level and add oil as necessary.

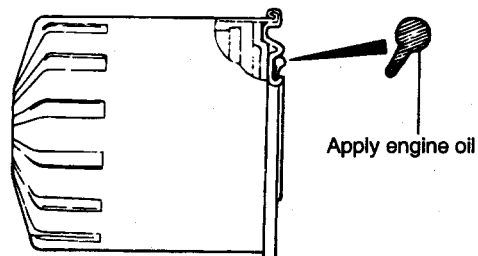

ECA9970B

REPLACING THE AIR CLEANER FILTER

The air cleaner filter will become dirty during use and the filtering efficiency will be substantially reduced. Replace with a new one as needed.

1. Disconnect the clip holding air cleaner filter cover.
2. Remove the air filter cover.

CAUTION

The air filter cover should be removed carefully because intake hose includes the air-flow sensor.

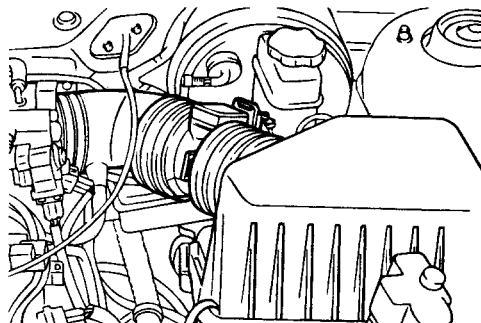

EDJAB60A

3. Remove the air cleaner filter.
4. Install a new air cleaner filter and replace the air cleaner filter cover.

CHECKING AND ADJUSTING BELT TENSION

Refer to the EM and EMA-Sections.

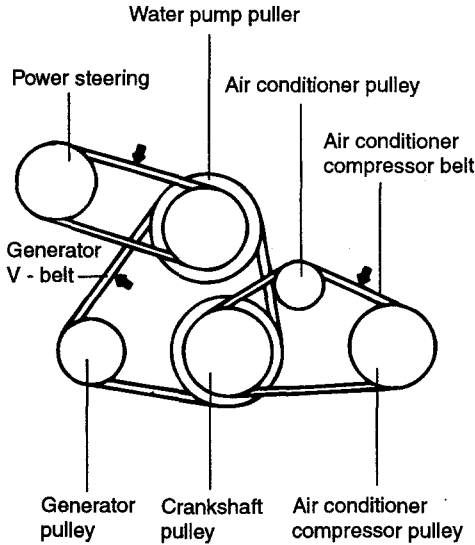

ECLA003A

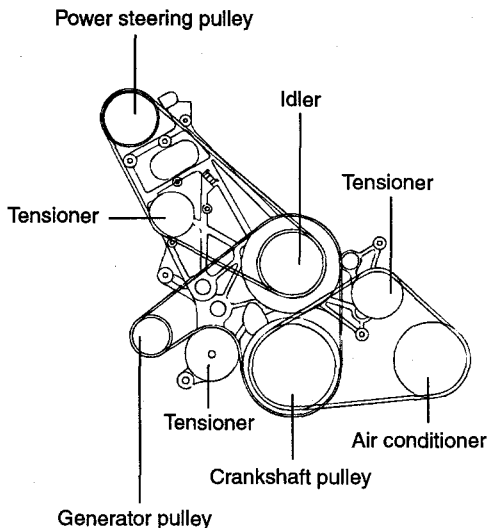

EDMB007B

COOLING SYSTEM

Check the cooling system for damaged hoses, loose or leaking connections, or other possible causes of coolant leaks.

ANTIFREEZE

The engine cooling system is provided with a mixture of 50% ethylene glycol anti-freeze and 50% water (For the vehicles of tropical area, the engine cooling system is provided with a mixture of 40% ethylene glycol anti-freeze and 60% water at the time of manufacture.)

Since the cylinder head and water pump body are made of aluminum alloy casting, be sure to use a 30 to 60% ethylene glycol antifreeze coolant to assure corrosion protection and freezing prevention.

CAUTION

If the concentration of the antifreeze is below 30%, the anticorrosion property will be adversely affected. In addition, if the concentration is above 60%, both the antifreeze and engine cooling properties will decrease, adversely affecting the engine. For these reasons, be sure to maintain the concentration level within the specified range.

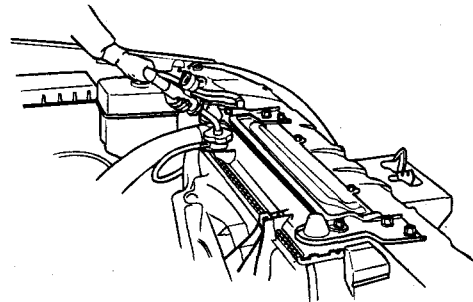

KDMB002A

MEASURING OF ANTIFREEZE CONCENTRATION

Run the engine until the coolant is fully mixed. Drain some coolant (antifreeze), and then measure the temperature and specific gravity of the coolant. Determine its concentration and safe working temperature. If the coolant is short of antifreeze, add antifreeze to a concentration of 50%. (Tropical Areas : 40%)

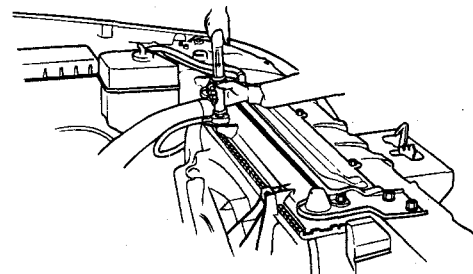

KDMB002B

REPLACING OF THE COOLANT

1. Set the temperature control lever to the hot position.

- Remove the radiator cap.

⚠ CAUTION

Remove the cap slowly. The system is pressurized and the coolant may be hot. Do not open the cap when the engine is hot.

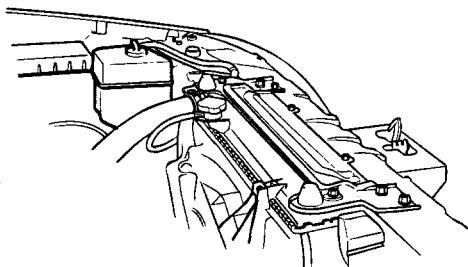

KDMB002E

- Loosen the drain plug to drain the coolant.
- Drain the coolant from the reserve tank.
- After draining the coolant, tighten the drain plug securely.
- Fill the radiator with the coolant up to its filler neck.
- Fill the reserve tank with the coolant.
- Warm up the engine until the thermostat opens, remove the radiator cap and check the coolant level.
- When the radiator is filled up to its filler neck, install the radiator cap securely.
- Fill the reserve tank with coolant up to the "FULL" line.

REPLACING IGNITION CABLES

The ignition cables should be replaced periodically with new ones. After replacing, make sure that the ignition cables and terminals are properly connected and positioned correctly.

📖 NOTE

When disconnecting an ignition cable, be sure to hold the cable cap. If the cable is disconnected by pulling on the cable alone, an open circuit might result.

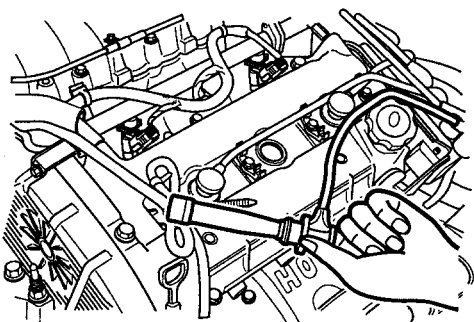

KFW2005A

REPLACING OXYGEN SENSOR

The oxygen sensor is a device which helps control the fuel mixture. If the oxygen sensor is damaged, the exhaust-gas cleaning efficiency as well as driveability deteriorates. Therefore, it should be replaced periodically with a new one.

FUEL SYSTEM

Tank, Lines And Connections

- Check for damage or leakage in the fuel lines and connections.
- Inspect the surface of fuel hoses for heat and mechanical damage. Hard and brittle rubber, cracking, tears, cuts, abrasions and excessive swelling indicate deterioration of the rubber.
- If the fabric casing of the rubber hose is damaged by cracks and abrasions in the fuel system, the hoses should be changed.

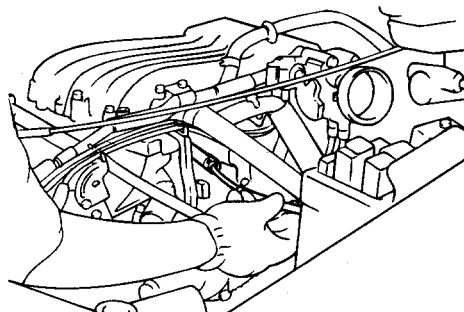

ECHA060A

MANUAL TRANSAXLE (INSPECT OIL LEVEL)

Inspect for leakage in each component and check the oil level by removing the filler plug. If the oil is contaminated, replace it with new oil.

- With the vehicle parked at a level place, remove the filler plug and make sure that the oil level is the same level as the plug hole.
- Check that the transaxle oil is not dirty.

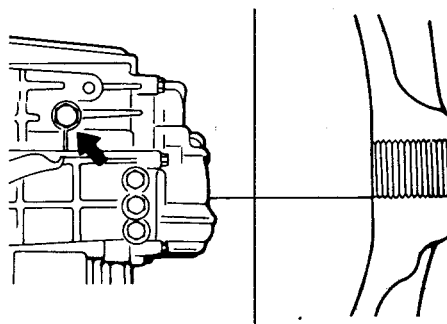

EAA9029A

TRANSAXLE OIL (REPLACE)

1. With the vehicle parked at a level place, remove the magnetic plug and drain transaxle oil.
2. Replace the washer with a new one and reinstall the plug.
3. Fill with transaxle oil (through the filler plug part) until the oil level is the same level as the plug hole.

INSPECTING STEERING LINKAGE

1. Check the steering wheel freeplay.

Maximum steering wheel freeplay : 30 mm (1.181 in.)

2. Check the steering linkage for looseness and damage.
 - a) Tie rod ends must not have excessive play.
 - b) Dust seals and boots must not be damaged.
 - c) Boot clamps must not be loose.

POWER STEERING FLUID LEVEL (INSPECT FLUID LEVEL)

1. Park the vehicle on a level surface, start the engine, and then turn the steering wheel several times to raise the temperature of the fluid to approximately 50°C (122°F).

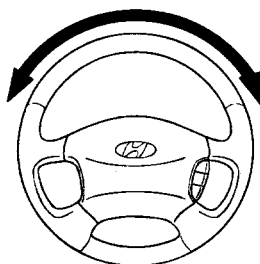

ECHA062A

2. With the engine idling, turn the wheel all the way to the left and right several times. Check the fluid in the oil reservoir for foaming, and its level. Replenish the fluid in the oil reservoir through the oil filter if necessary.

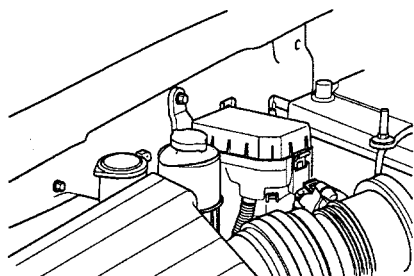

KDMB002D

POWER STEERING HOSES (CHECK FOR DETERIORATION OR LEAKS)

1. Check the hose connections for fluid leaks.
2. The power steering hoses should be replaced if there is severe surface cracking, pulling, scuffing or worn steps. Deterioration of the hoses could cause premature failure.

BALL JOINT AND STEERING LINKAGE SEALS, STEERING AND DRIVE SHAFT BOOTS

1. These components, which are permanently lubricated at the factory, do not require lubrication. Damaged seals and boots should be replaced to prevent leakage or contamination of the grease.
2. Inspect the dust covers and boots for proper sealing, leakage and damage. Replace them if defective.

INSPECTING BRAKE LINES

1. Check all brake lines and hoses for damage, wear, cracks, corrosion, leaks, bends and twists.
2. Check all clamps for tightness.
3. Check that the lines are clear of sharp edges, moving parts and the exhaust system.



EAA9033A

FRONT DISC BRAKE PADS

Check for fluid contamination and wear. Always replace brake pads in complete sets.

NOTE

If a squealing or scraping noise occurs from the brake during driving, check if the pad wear indicator is contacting the disc. If it is, the brake pads should be replaced.

CAUTION

The pads for the right and left wheels should be replaced at the same time. Never split or intermix brake pad sets. All pads must be replaced as a complete set.

Thickness of pad lining [Limit] : 2.0 mm (0.079 in.)

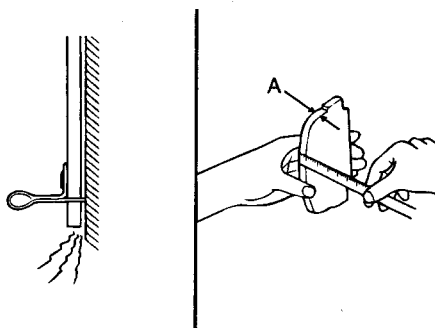

EAA9034A

REAR DRUM BRAKE LININGS AND REAR WHEEL CYLINDERS

1. Remove the brake drum and check the thickness of the brake shoe lining for wear. Check the automatic brake adjusting system by hand to see that it operates smoothly, and gears are in proper mesh with each other. To assure smooth function, apply a very thin coat of grease to the friction surface of the adjuster and link shaft.
2. Inspect the wheel cylinder boots for fluid leaks. Visually check the boots for cuts, tears or heat cracks. (A small amount of fluid on the boot may not be a leak but preservative fluid used at assembly.)

Checking the brake shoes for wear.

Thickness of lining [Limit] : 0.8 mm (0.031 in.)

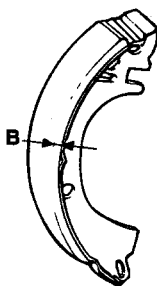

EAA9035A

CHECKING THE BRAKE FLUID LEVEL

1. Check the level of the brake fluid in the reserve tank of the master cylinder.
2. The level should be between the "MAX" and "MIN" mark.
3. If the level is lower than the "MIN" mark, add new brake fluid up to the "MAX" mark.

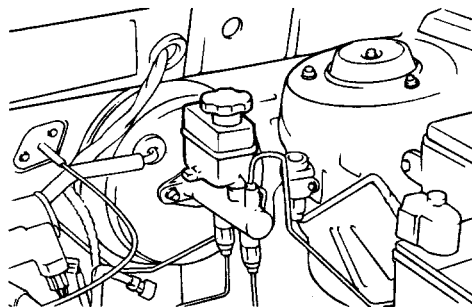

ECJA230A

CHANGING BRAKE FLUID

1. Refer to BR-Section for air-bleeding procedures.
2. With a vehicle equipped with ABS(Anti-lock Brake System), refer to BR-section.
3. Connect a vinyl tube to the bleeder screw of each wheel cylinder. Put the other end of the vinyl tube in a vessel to receive the brake fluid.

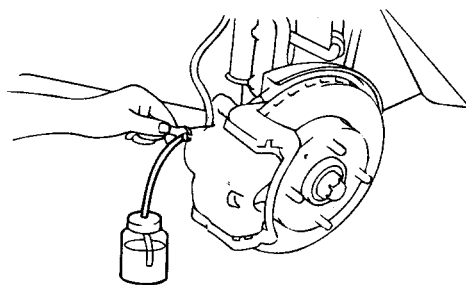

EAA9037A

4. Depress the brake pedal a few times. Then loosen the bleeder screw(with the brake pedal still depressed), and tighten it after the brake fluid stops flowing.

5. Repeat the above operation until there are no air bubbles in the brake fluid.
6. Repeat these steps for the other cylinders.
7. Add new brake fluid up to the "MAX" level in the reserve tank.

Brake fluid : DOT 3 or DOT4

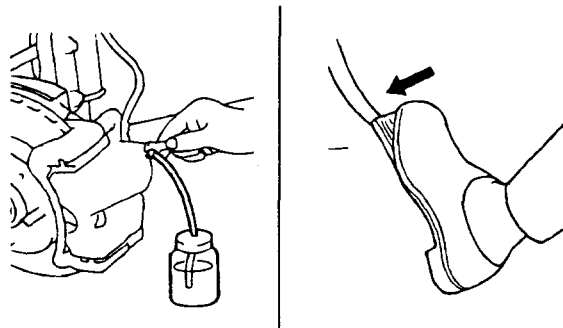

EAHA014B

CHECKING TIRE INFLATION PRESSURE

Check the tire inflation pressures as follows.

TIRE INFLATION PRESSURE (CHECK WITH TIRES COOL)

	Tire size	Front	Rear
4WD	225/70 R15	30 psi	30 psi

ROAD TEST

Drive the vehicle and check for abnormal conditions.

1. Check oil, fluid, fuel, water and exhaust gas leaks.
2. Check free play of clutch pedal and brake pedal.
3. Check operation of brake booster.
4. Check the operation of service brake and parking brake systems.
5. Check the stroke of parking brake lever.
6. Check the driveability of engine.
7. Check the condition of instruments, gauges, indicators, exterior lamps, heater and ventilators.
8. Check the abnormal noises from each part.

STEERING AND DRIVE SHAFT BOOTS

1. Aluminum wheels require special attention. If salt or chemicals adhere to the wheels, they need to be rinsed off as soon as possible. After cleaning the wheels, apply a coating of wax to them to prevent corrosion.
2. When cleaning the vehicle with steam, do not direct steam onto the aluminum wheels.
 - Clean the hub surface.
 - After tightening the wheel nuts by hand, tighten them according to specifications.
 - Do not use an impact wrench or stand on the wrench with your foot to tighten the wheel nuts.
 - Do not apply oil to the threaded portions.

TIRE CHAINS AND SNOW TIRES

- Use tire chains only on the rear wheels.
- When using snow tires, use them on all four wheels for added maneuverability and safety.