

WKD 997 021 **06**

5/05

© Dr. Ing. h.c. F. Porsche AG

Porsche, the Porsche crest, Carrera, PCCB, Tiptronic and Tequipment are registered trademarks and the distinctive shapes of Porsche automobiles are trademarks of Dr. Ing. h.c. F. Porsche AG.

All rights reserved.

Printed in Germany

Dear Owner,

We would like to thank you for your purchase of a Porsche Sports car.

Judging by the car you have chosen, you are a motorist of a special breed, and you are probably no novice when it comes to automobiles.

Remember however, as with any vehicle, you should take time to familiarize yourself with your Porsche and its performance characteristics. Always drive within your own unique capabilities as a driver and your level of experience with your Porsche. Ensure that anyone else driving your Porsche does the same. To prevent or minimize injury, always use your safety belts. Never consume alcohol or drugs before or during the operation of your vehicle.

This Owner's Manual contains a host of useful information. Please take the time to read this manual before you drive your new Porsche. Become familiar with the operation of your Porsche car for maximum safety and operating pleasure. The better you know your Porsche, the more pleasure you will experience driving your new car. Always keep your Owner's Manual in the car, and give it to the new owner if you ever sell your Porsche.

A separate Maintenance Booklet explains how you can keep your Porsche in top driving condition by having it serviced regularly.

A separate Warranty and Customer Information Booklet contains detailed information about the warranties covering your Porsche.

For U.S. only:

If you believe that your vehicle has a fault which could cause a crash, injury or death, you should immediately inform the National Highway Traffic Safety Administration (NHTSA) in addition to notifying Porsche Cars North America, Inc. (Porsche Cars N.A.).

If NHTSA receives similar complaints, it may open an investigation, and if it finds that a safety problem exists in a group of vehicles, it may order a recall and remedy campaign. However, NHTSA cannot become involved in individual problems between you and your dealer, or Porsche Cars N.A..

To contact NHTSA, you may either call the Auto Safety Hotline toll-free at 1-(800)-424-9393 (or 366-0123 in Washington, D.C. area) or write to: NHTSA, U.S. Department of Transportation, Washington, D.C. 20590. You can also obtain other information about motor vehicle safety from the Hotline.

Your car has thousands of parts and components which have been designed and manufactured in accordance with Porsche's high standards of engineering quality and safety.

Any alteration of the vehicle may negate or interfere with those safety features built into the vehicle.

Your Porsche is intended to be used in a safe manner obeying the local laws and in the light of driving conditions faced by you, and in accordance with the instructions provided in this Owner's Manual.

Do not misuse your Porsche by ignoring those laws and driving conditions, or by ignoring the instructions in this manual. Any alteration or misuse of the vehicle can lead to accidents and severe or fatal personal injuries.

The fitting of racing tires (e.g. slicks) for sporting events is not approved by Porsche. Very high cornering speeds can be achieved with racing tires. However, the resulting transverse acceleration values would jeopardize the adequate supply of oil to the engine.

Porsche therefore will not accept any warranty or accept any liability for damage occurring as a result of non-compliance with this provision.

Regularly check your vehicle for signs of damage.

Damaged or missing aerodynamic components such as spoilers or underside panels affect the driving behavior and therefore must be replaced immediately.

Your car may have all or some of the components described in this manual.

Should you have difficulty understanding any of the explanations of features or equipment installed in your vehicle, contact your authorized Porsche dealer. He/She will be glad to assist you. Also check with your dealer on other available options or equipment.

Throughout this booklet, left is designated as the driver's side of the vehicle, and right as the passenger's side of the vehicle.

Text, illustrations and specifications in this manual are based on the information available at the time of printing.

It has always been Porsche's policy to continuously improve its products. Porsche, therefore, reserves the right to make changes in design and specification, and to make additions or improvements in its product without incurring any obligation to install them on products previously manufactured.

We wish you many miles of safe and pleasurable driving in your Porsche.

Important

For your own protection and longer service life of your car, please follow all operating instructions and special warnings. These special warnings use the safety alert symbol, followed by the words **Danger, Warning and Caution**. These special warnings contain important messages regarding your safety and/or the potential for damage to your Porsche. Ignoring them could result in serious mechanical failure or even physical injury.

- f Do not alter your Porsche. Any alteration could create dangerous conditions or defeat safety engineering features built into your car.
- f Do not misuse your Porsche. Use it safely, and consistently with the law, according to the driving conditions, and the instructions in this manual.

Alteration or misuse of your Porsche could cause accidents and severe or fatal personal injuries.

Note to owners

In Canada, this manual is also available in French. To obtain a copy contact your dealer or write to:

Note aux propriétaires

Au Canada on peut se procurer un exemplaire de ce Manuel en français auprès du concessionnaire ou du:

Porsche Cars Canada, Ltd.
Automobiles Porsche Canada, LTEE

5045 Orbitor Drive
Building #8, Suite 200
Mississauga, Ontario
Canada L4W 4Y4

Telephone number for customer assistance:
1-800-PORSCHE / Option 3

Fuel Quality

Your engine is designed to provide optimum performance and fuel economy using **unleaded premium fuel with an octane rating of 98 RON (93 CLC or AKI)**. Porsche therefore recommends the use of these fuels in your vehicle.

Porsche also recognizes that these fuels may not always be available. Be assured that your vehicle will operate properly on unleaded premium fuels with octane numbers of at least **95 RON (90 CLC or AKI)**, since the engine's "Electronic Oktane™ knock control" will adapt the ignition timing, if necessary.

Fuels containing alcohol and ether

Some areas of the U.S. require oxygenated fuels during certain portions of the year. Oxygenated fuels are fuels which contain alcohols (such as methanol or ethanol) or ether (such as MTBE).

Under normal conditions, the amount of these compounds in the fuel will not affect driveability.

You may use oxygenated fuels in your Porsche, provided the octane requirements for your vehicle are met. We recommend, however, to change to a different fuel or station if any of the following problems occur with your vehicle:

- Deterioration of driveability and performance.
- Substantially reduced fuel economy.
- Vapor lock and non-start problems, especially at high altitude or at high temperature.
- Engine malfunction or stalling.

Fuels containing MMT

Some North American fuels contain an octane enhancing additive called methylcyclopentadienyl manganese tricarbonyl (MMT). If such fuels are used, your emission control system performance may be negatively affected.

The check engine warning lights on your instrument panel may turn on. If this occurs, Porsche recommends you stop using fuels containing MMT.

Tire Pressures for Cold Tires

Summer tires and snow tires 911 Carrera, 911 Carrera S

18 inch wheels	front	36 psi (2.5 bar)
	rear	44 psi (3.0 bar)
19 inch wheels, partially loaded (up to 2 persons without luggage)	front	33 psi (2.3 bar)
	rear	39 psi (2.7 bar)
19 inch wheels, fully loaded (as of 2 persons with luggage)	front	36 psi (2.5 bar)
	rear	44 psi (3.0 bar)

Summer tires and snow tires 911 Carrera 4, 911 Carrera 4S

18 inch and 19 inch wheels, partially loaded (up to 2 persons without luggage)	front	33 psi (2.3 bar)
	rear	39 psi (2.7 bar)
18 inch and 19 inch wheels, fully loaded (as of 2 persons with luggage)	front	36 psi (2.5 bar)
	rear	44 psi (3.0 bar)

These tire pressures are valid only for Porsche approved tires.

For replacement tires it is imperative that you consult the Technical Data and Tires, Wheels sections of this manual and follow the recommendations found there.

Porsche and the Environment

Environmental guidelines

We develop and produce exclusive sports cars with advanced environmental and safety technology and a great ability to fascinate.

Our environmental policy is based on the following principles:

- The maximum possible use of environmental and safety technology that is economically justifiable.
- Economical usage of energy and resources.
- Involvement of our business partners and contractors in our efforts to protect the environment.
- Open dialogue with all social groups.

California Proposition 65 Warning

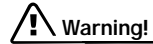

Engine exhaust, some of its constituents, and certain vehicle components contain or emit chemicals known to the State of California to cause cancer and birth defects or other reproductive harm. In addition, certain fluids contained in vehicles and certain products of component wear contain or emit chemicals known to the State of California to cause cancer and birth defects or other reproductive harm.

Production

Whether in production or repair, Porsche always relies on environmentally friendly technology. An example of this is the water-based paint used in our painting installations. Water-base paints and new painting methods reduce solvent emissions by 70 per cent. The water used in the painting installation is re-circulated. Waste water leaves the Porsche factory only after being appropriately treated.

A waste-management system has been introduced to reduce the amount of waste while simultaneously increasing the recycling rate.

Environmentally friendly vehicles

Modern environmental technology ensures compliance with all emission laws applicable worldwide.

These have the following advantages:

- Rapid operational readiness of the catalytic converters ensures low emissions, even in short-trip operation.
 - Reliable operation and good emission control over a long useful life.
- f Please refer to the chapter "FUEL ECONOMY" on page 207.

Recycling – for a Porsche, this is virtually an academic question

More than two-thirds of all Porsches ever built are still running.

Just in case recycling is ever necessary, we take the following precautionary measures:

- Identification of all materials.
- Use of recyclable materials.
- Reusable components designed for simple removal.
- These reasons result in a further increase in the recycling rate which is currently 80 per cent.

Emission control is built in

Innovative engine technology combines high engine performance and environmental compatibility.

The engine diagnosis system electronically monitors the components and systems that affect exhaust gases.

This continuous monitoring and fault storage enables swift, reliable diagnosis and fault detection.

Any fault messages are indicated to the driver by the "Check Engine" warning light and the on-board computer.

- f Please refer to the chapter "WARNINGS ON THE INSTRUMENT PANEL AND THE ON-BOARD COMPUTER" on page 122.

Porsche Ceramic Composite Brake (PCCB)

The high-performance brake system is designed for optimal braking effect at all speeds and temperatures.

Certain speeds, braking forces and ambient conditions (such as temperature and humidity) therefore might cause brake noises.

Wear on the different components and braking system, such as brake pads and brake discs, depends to a great extent on the individual driving style and the conditions of use and therefore cannot be expressed in actual miles on the road.

The values communicated by Porsche are based on normal operation adapted to traffic. Wear increases considerably when the vehicle is driven on race tracks or through an aggressive driving style.

- f Please consult an authorized Porsche dealer about the current guidelines in effect before such use of your vehicle.

Setting and operating vehicle components when driving

Warning!

There is a danger of accident if you set or operate the on-board computer, radio, navigation system, telephone or other equipment when driving.

This could distract you from the traffic and cause you to lose control of the vehicle resulting in serious personal injury or death.

- f Operate the components while driving only if the traffic situation allows you to do so safely.
- f Carry out any complicated operating or setting procedures only with the vehicle stationary.

Portable Fuel Containers

Danger!

Portable fuel containers, full or partially empty, may leak, causing an explosion, or result in fire in case of an accident.

- f Never carry additional fuel in portable containers in your vehicle.

Engine Exhaust

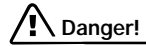

Engine exhaust is dangerous if inhaled. Engine exhaust fumes have many components which you can smell. They also contain carbon monoxide (CO), which is a colorless and odorless gas. Carbon monoxide can cause unconsciousness and even death if inhaled.

- f Never start or let the engine run in an enclosed, unventilated area. It is not recommended to sit in your car for prolonged periods with the engine on and the car not moving.
-

Ground Clearance

Please bear in mind the limited ground clearance of your car on uneven surfaces, when parking (curbs), on ramps, lifting platforms, towing etc.

Controls, Instruments	13 - 161
 Shifting Gear	163 - 170
 Mobile Roofs	171 - 195
Maintenance, Car Care	197 - 226
Practical Tips, Emergency Service	227 - 282
Vehicle Identification, Technical Data	284 - 302
 Index	304 - 308

Controls, Instruments

Before driving off	14	Parking Brake	65	Check Engine	97
Break in hints for the first		Brakes	66	Warning Light	98
2,000 miles/3,000 kilometers	16	ABS Brake System		On-Board Computer (BC)	130
Keys	19	(Antilock Brake System)	69	Emergency Flasher Switch	131
Security Wheel Bolts	19	Sport Mode	71	Light Switch	131
Doors	21	Porsche Stability Management (PSM)	72	Welcome Home Lighting	131
Central Locking	22	Porsche Active Suspension		Automatic Headlight Beam Adjustment	132
Alarm System,		Management (PASM)	75	Turn Signal / Headlight Dimmer /	
Passenger Compartment Monitoring	26	Interior Lights	76	Parking light / Flasher Lever	132
Power Windows	28	Operation, Instruments	78	Windshield Wiper / Washer Lever	133
Inside mirror	30	Ignition/Starter Switch with anti-theft		Automatic Speed Control	136
Door Mirrors	30	Steering Lock	80	Automatic Air Conditioning System	138
Rear Window Defogger,		Starting Procedures	82	Central and Side Vents	141
Door Mirror Heating	33	Stopping Engine	83	Fresh-air Intake	141
Seat Adjustment	34	Instrument Panel USA Models	84	Ashtray	142
Seat Memory	36	Instrument Panel Canada Models	86	Cigarette Lighter	143
Heated Seats	38	Engine oil temperature	88	Cupholder	144
Rear Seat Backrests	39	Automatic Speed Control Indicator light	88	Storage in the Passenger Compartment	146
Steering Wheel Adjustment	39	Instrument Illumination	88	Luggage Compartment Lid and Engine	
Multi-Functional Steering Wheel	40	Trip Odometer	89	Compartment Lid	148
Sun Visors	41	Speedometer	90	Luggage Compartment	
Safety Belts	42	Changing over between		(911 Carrera, 911 Carrera S)	150
Airbag Systems	45	Miles / Kilometers	90	Luggage Compartment	
Child Restraint Systems	51	Tachometer	91	(911 Carrera 4, 911 Carrera 4S)	151
LATCH System		Turn Signal Indicator Light	91	Trunk Entrapment	152
Child seat bracket on the passenger's seat	55	High Beam	91	Fire Extinguisher	154
Child Restraint Anchorages	56	Cooling System	92	HomeLink	155
Rollover Protection System	57	Tiptronic	93	Porsche Communication	
Parking Aids	58	Fuel	94	Management (PCM)	158
Four-Wheel Drive	61	Clock	95	Car Telephone and	
Retractable Rear Spoiler	63	Outside temperature	95	Aftermarket Alarms	161
Clutch Pedal	65	Engine Oil Pressure	96		

Dear Porsche Owner

A lot has gone into the manufacture of your Porsche, including advanced engineering, rigid quality control and demanding inspections. These engineering and safety features will be enhanced by you...

the safe driver...

- who knows his car and all controls,
- who maintains the vehicle properly,
- who uses driving skills wisely and always drives within her/his own capabilities and the level of familiarity with the vehicle.

You will find helpful hints in this manual on how to perform most of the checks listed on the following pages.

If in doubt, have these checks performed by your authorized Porsche dealer.

Before driving off...

Check the following items first

- f Turn the engine off before you attempt any checks or repairs on the vehicle.
- f Be sure the tires are inflated correctly. Check tires for damage and tire wear.
- f See that wheel bolts are properly tightened and not loose or missing.
- f Check engine oil level, add if necessary. Make it a habit to have engine oil checked with every fuel filling.
- f Check all fluid levels such as windshield washer and brake fluid levels.
- f Be sure the vehicle battery is well charged and cranks the engine properly.
- f Check all doors and lids for proper operation and latch them properly.
- f Check, and if necessary replace worn or cracked wiper blades.
- f See that all windows are clear and unobstructed.
- f Check air intake slots and area between luggage compartment lid and windshield are free of snow and ice, so the heater and the windshield wipers work properly.

- f If a child will be riding in the vehicle, check child seat/child seat restraint system to ensure that restraints are properly adjusted.
- f Check all exterior and interior lights for operation and that the lenses are clean.
- f Check the headlights for proper aim, and if necessary, have them adjusted.
- f Check under the vehicle for leaks.
- f Be sure all luggage is stowed securely.

Emergency equipment

It is good practice to carry emergency equipment in your vehicle.

Some of the items you should have are: window scraper, snow brush, container or bag of sand or salt, emergency light, small shovel, first-aid kit, etc.

In the driver's seat...

- f Check operation of the horn.
- f Position seat for easy reach of foot pedals and controls.
To reduce the possibility of injury from the airbag deployment, you should always sit back as far from the steering wheel as is practical, while still maintaining full vehicle control.
- f Adjust the inside and outside rear view mirrors.
- f Buckle your safety belts.
- f Check operation of the foot and parking brake.
- f Check all warning and indicator lights with ignition on and engine not running.
- f Start engine and check all warning displays for warning symbols.
- f Never leave an idling car unattended.
- f Lock doors from inside, especially with children in the car to prevent inadvertent opening of doors from inside or outside.
Drive with doors locked.

On the road...

- f Never drive after you have consumed alcohol or drugs.
- f Always have your safety belt fastened.
- f Always drive defensively.
Expect the unexpected.
- f Use signals to indicate turns and lane changes.
- f Turn on headlights at dusk or when the driving conditions warrant it.
- f Always keep a safe distance from the vehicle in front of you, depending on traffic, road and weather conditions.
- f Reduce speed at night and during inclement weather.
Driving in wet weather requires caution and reduced speeds, particularly on roads with standing water, as the handling characteristics of the vehicle may be impaired due to hydroplaning of the tires.
- f Always observe speed limits and obey road signs and traffic laws.
- f When tired, get well off the road, stop and take a rest. Turn the engine off. Do not sit in the vehicle with engine idling.
Please observe the chapter "ENGINE EXHAUST" on Page 9.

- f When parked, always set the parking brake. Move the Tiptronic selector lever to "P" or the gearshift lever to reverse or first gear. On hills also turn the front wheels toward the curb.
- f When emergency repairs become necessary, move the vehicle well off the road. Turn on the emergency flasher and use other warning devices to alert other motorists. Do not park or operate the vehicle in areas where the hot exhaust system may come in contact with dry grass, brush, fuel spill or other flammable material.
- f Make it a habit to have the engine oil checked after every fuel filling.

Break in hints for the first 2,000 miles/3,000 kilometers

The following tips will be helpful in obtaining optimum performance from your new Porsche.

Despite the most modern, high-precision manufacturing methods, it cannot be completely avoided that the moving parts have to wear in with each other. This wearing-in occurs mainly in the first 2,000 miles/3,000 km.

Therefore:

- f Preferably take longer trips.
- f Avoid frequent cold starts with short-distance driving whenever possible.
- f Avoid full throttle starts and abrupt stops.
- f Do not exceed maximum engine speed of 4,200 rpm (revolutions per minute).
- f Do not run a cold engine at high rpm either in Neutral or in gear.
- f Do not let the engine labor, especially when driving uphill. Shift to the next lower gear in time (use the most favorable rpm range).
- f Never lug the engine in high gear at low speeds. This rule applies at all times, not just during the break-in period.

- f Do not participate in motor racing events, sports driving schools, etc. during the first 2,000 miles/3,000 kilometers.

There may be a slight stiffness in the steering, gear-shifting or other controls during the break-in period which will gradually disappear.

Break in brake pads and brake discs

New brake pads and discs have to be "broken in", and therefore only attain optimal friction when the car has covered several hundred miles or km. The slightly reduced braking ability must be compensated for by pressing the brake pedal harder. This also applies whenever the brake pads and brake discs are replaced.

New tires

New tires do not have maximum traction. They tend to be slippery.

- f Break in new tires by driving at moderate speeds during the first 60 to 120 miles/100 to 200 km. Longer braking distances must be anticipated.

Engine oil and fuel consumption

During the break-in period oil and fuel consumption may be higher than normal.

As always, the rate of oil consumption depends on the quality and viscosity of oil, the speed at which the engine is operated, the climate and road conditions, as well as the amount of dilution and oxidation of the lubricant.

- f Make a habit of checking engine oil with every fuel filling, add if necessary.

H51-159

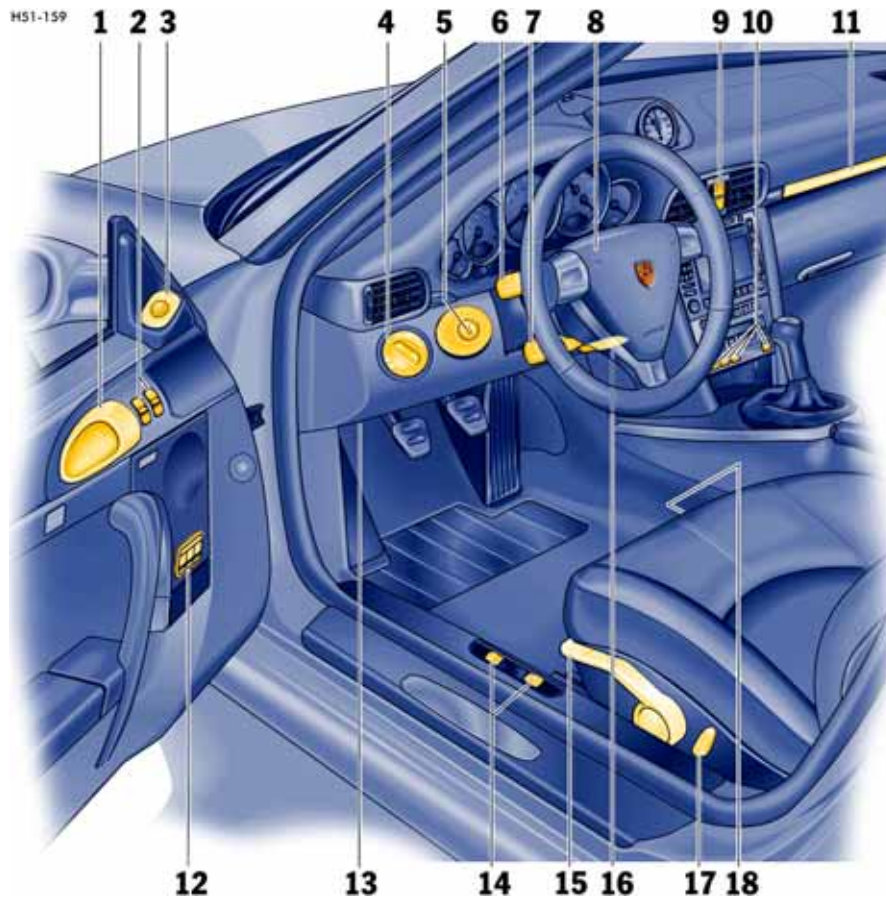

- 1 Inner door handle
- 2 Power windows
- 3 Door mirror control
- 4 Light switch
- 5 Ignition/starter switch with steering lock
- 6 Turn signal/headlight dimmer, flasher lever
- 7 Operating lever for on-board computer
- 8 Horn
- 9 Emergency flasher switch, central locking switch
- 10 Switches for rear spoiler, Porsche Active Suspension Management (PASM), Sport mode, Porsche Stability Management (PSM)
- 11 Cupholder
- 12 Switch for seat memory
- 13 Diagnostic socket (OBD)
- 14 Lid release
- 15 Seat height adjustment
- 16 Steering-wheel adjustment
- 17 Backrest angle adjustment
- 18 Seat fore and aft adjustment

Never invite car theft!

An unlocked car with the key in the ignition lock invites car theft.

A steering wheel lock and a **gong alarm** are standard equipment in your Porsche.

The gong alarm will sound if you open the driver's door while the key is still in the ignition lock. It is your reminder to pull the key out of the ignition lock and to lock the doors.



Any uncontrolled movement of the vehicle may result in serious personal injury and property damage.

Never leave your vehicle unattended with the key in the ignition lock, especially if children and/or pets are left unattended in the vehicle. They can operate power windows and other controls. If the engine is left running, they may accidentally engage the shift lever.

f Always remove the ignition key.

f Always set the parking brake.

f Lock the doors with the remote control.

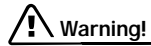

Risk of a serious accident.

The steering column will lock when you remove the key while you are driving or as the car is rolling to a stop. You will not be able to steer the car.

f Never remove the key from the steering lock while you are driving.

To protect your vehicle and your possessions from theft, you should always proceed as follows when leaving your vehicle:

f Close windows.

f Close lifting/sliding roof

f Close convertible top (with the convertible top open, the passenger compartment monitoring system is always switched off)

f Remove ignition key.

f Engage steering lock.

f Lock glove compartment.

f Remove valuables (e.g. car documents, telephone, house keys) from the car.

f Lock doors.

Keys

f Please observe the chapter "ALARM SYSTEM, PASSENGER COMPARTMENT MONITORING" on Page 26.

f Please observe the chapter "CENTRAL LOCKING" on Page 22.

Two main keys and one spare key are supplied with your Porsche.

These keys operate all the locks on your vehicle.

f Be careful with your car keys: do not part with them except under exceptional circumstances.

f To avoid battery run-down, always remove the ignition key from the ignition lock.

Replacement keys

Replacement car keys can be obtained only from your authorized Porsche dealer, and this can sometimes be very time-consuming.

You should therefore always keep the spare key on your person.

Keep it in a safe place (e.g. wallet), but under no circumstances in or on the vehicle.

The key codes of new keys have to be "reported" to the car control unit by your authorized Porsche dealer.

Disabling key codes

If a key is lost, the key codes can be disabled by an authorized Porsche dealer.

All the remaining car keys are required for this purpose.

Disabling the code ensures that the car can be **started** only using authorized keys.

Note

f Please note that the other locks can still be opened with the disabled key.

Immobilizer

There is a transponder (an electronic component) in the key grip, containing a stored code.

When the ignition is switched on, the ignition lock checks the code.

The immobilizer can be deactivated and the engine started only using an authorized ignition key.

Switching off the immobilizer

f Insert the ignition key into the ignition lock.

If the ignition is left on for more than 2 minutes without the engine being started, the immobilizer is reactivated.

f If this happens, turn the ignition key back to the **3** position before starting the engine.

Please observe the chapter "IGNITION/ STARTER SWITCH WITH ANTI-THEFT STEERING LOCK" on Page 80.

Switching on the immobilizer

f Remove ignition key.

Security Wheel Bolts

f If wheels have to be removed during a workshop visit, do not forget to hand over the socket for the security wheel bolts along with the car key.



- A - Main key
- 1 - Central locking button
- 2 - Luggage compartment lid button
- 3 - Light-emitting diode
- B - Spare key

Key with Radio Remote Control

Unlocking the vehicle

- f Press button 1.

Locking the vehicle

- f Press button 1.

H51-061

Switching off the alarm system if it is triggered accidentally

- f Unlock the vehicle.

Unlocking luggage compartment lid

- f Press button 2 for approx. two seconds.

If the vehicle was locked, it is unlocked simultaneously with the luggage compartment.

In vehicles with seat memory the stored seat and door mirror positions are automatically set.

The vehicle will be locked again approx.

15 seconds after the luggage compartment is closed if none of the doors was opened.

Note

Your authorized Porsche dealer can program further types of unlocking.

Type 1

The relocking time of the doors can be adjusted to suit your individual requirements:
10 - 100 seconds.

Type 2

The doors stay locked when the luggage compartment is unlocked.

The remote-control standby function switches off after 7 days

If the vehicle is not started or unlocked with the remote control within 7 days, the remote control standby function is switched off (to prevent discharging of the vehicle battery).

1. In this case, unlock the driver's door with the key at the door lock.
Leave the door closed in order to prevent the alarm system from being triggered.

2. Press button 1 on the remote control.

The remote control is now activated again.

Note

- f Do not insert the ignition key into the ignition lock if the vehicle battery is discharged.
The ignition key can no longer be removed.

The key cannot be removed until the vehicle electrical system is supplied with power again.

- f Please observe the chapter "EMERGENCY UNLOCKING OF THE LUGGAGE COMPARTMENT LID" on Page 257.
- f Please observe the chapter "EMERGENCY STARTING WITH JUMPER CABLES" on Page 264.



Doors

If the door windows are closed, they will be automatically opened by a few millimeters when the doors are opened and, when the doors are closed, they will be closed again. This makes it easier to open and close the doors and protects the seals.

- f Therefore, you should pull the door handle slowly so that the door window can be lowered before the door is opened.

Opening doors from outside

- f Unlock vehicle with the remote control.
- f Slowly pull door handle **A**.

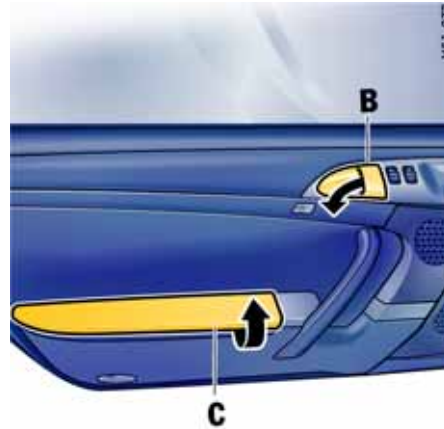

Opening unlocked doors from inside

- f Slowly pull door handle **B**.

Opening locked doors from inside

- f Slowly pull door handle **B** twice.
- f Please observe the chapter "LOCKING CONDITIONS" on Page 23.

Door storage tray

Opening storage tray

- f Open the cover.

Always keep the door storage tray **C** closed, so that the side airbag is not obstructed in the event of an accident.

Central Locking

This device complies with:
Part 15 of the FCC Rules
RSS-210 of Industry Canada.

Operation is subject to the following two conditions:

1. This device may not cause harmful interference, and
2. this device must accept any interference received, including interference that may cause undesired operation.

Note

The manufacturer is not responsible for any radio or TV interference caused by unauthorized modifications to this equipment.

Such modification could void the user's authority to operate the equipment.

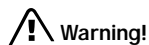

Any changes or modifications not expressly approved by Porsche could void the user's authority to operate this equipment.

-
- f Please observe the chapter "LOAD SWITCH-OFF AFTER 2 HOURS OR 7 DAYS" on Page 255.
 - f Please observe the chapter "SEAT MEMORY" on Page 36.

Both car doors and the filler flap can be centrally unlocked or locked with the remote control.

The vehicle cannot be locked if the driver's door is not completely closed.

A short **signal from the alarm horn** will draw your attention to the fact that the following components are not completely closed when you try to lock the vehicle:

- Passenger's door
- Luggage compartment lid
- Engine compartment lid
- Glove compartment

Unlocking the vehicle by using the key in the door lock and opening the door may activate the alarm system within 10 seconds.

Note

On vehicles with the Sport Chrono package, the PCM can be used to activate automatic door locking.

Please observe the chapter "Individual Memory" in the separate PCM operating instructions.

Automatic relocking

If the car is unlocked by remote control and none of the car doors is opened within approx. 60 seconds, automatic relocking takes place.

This relocking time can be adapted to your individual requirements (10 - 100 seconds) by an authorized Porsche dealer.

Locking conditions

- f Lock car **once**.
The doors cannot be opened from the outside. Alarm system and passenger compartment monitoring are switched on.

If a person or animal remains in the vehicle:

- f Quickly lock car **twice**.
The doors cannot be opened from the outside. The passenger compartment monitoring is switched off.

Unlocking the door with the inner door handle

Any person remaining in the locked car can open the door with the inner door handle:

1. Pull inner door handle once to unlock door lock.
2. Pull inner door handle again to open door.

Note

- f Inform any person remaining in the car that the alarm system will be triggered if the door is opened.

Malfunction of the remote control

The remote control may not function correctly due to local radio wave interference. The vehicle will then not lock properly.

This can be identified by the missing locking sound and the missing check-back signal of the emergency flasher.

If this should occur:

- f Lock the vehicle with the key in the door.

Emergency operation – opening

- f Unlock the driver's door with the key at the door lock.
Open door within 20 seconds and insert the ignition key into the ignition lock within 10 seconds to prevent the alarm system from being triggered.

Note on operation

If the door is not opened within approx. 20 seconds, automatic relocking takes place. The alarm system will be triggered by the next unlocking of the door:

- f Insert the ignition key into the ignition lock to switch off the alarm system.

Emergency operation – closing

- f Lock the driver's door with the key at the door lock.
If there is a defect in the central locking system, all functioning elements of the central locking system will be locked.
The alarm system is switched on.
The passenger compartment monitoring system is switched off.

The fault should be remedied immediately at an authorized Porsche dealer.

Indication by emergency flasher and alarm horn

If the **remote control** is used for unlocking or locking, a response is provided by the emergency flasher:

- Unlocking – single flash.
- Locking – double flash.
- Locking twice – continuous illumination for approx. 2 seconds.

Fault indication

A double **horn signal** during locking indicates a defect in the central locking or alarm system. Have the defect remedied at an authorized Porsche dealer.

Overload protection

If the central locking system is operated more than ten times within a minute, further operation is blocked for 30 seconds.



Central locking button

The central locking button on the dashboard lets you lock and unlock both doors electrically.

Note

If the doors are locked with the key or remote control, they can not be opened by pressing the central locking button.

Locking

- f Press the central locking button. Indicator light in the button lights up if ignition is on.

Unlocking

- f Press the central locking button. Indicator light goes out.

If the doors were locked with the central locking button, they can be opened by pulling the inner door handle:

1. Pull inner door handle once to unlock door lock.
2. Pull inner door handle again to open door.

Automatic door locking

Your authorized Porsche dealer can program diverse types of automatic door locking in the control unit of the central locking system:

Type 1

Doors lock automatically when the ignition is switched on.

Type 2

Doors lock automatically when a speed of 3 - 6 mph (5 - 10 km/h) is exceeded.

Type 3

Doors lock automatically when the ignition is switched on. If doors are opened with the engine running, they lock again automatically when a speed of 3 - 6 mph (5 - 10 km/h) is exceeded.

Type 4

The doors do not lock automatically.

Note

Automatically locked doors can be unlocked with the central locking button or opened by pulling on the inside door handle twice.

On vehicles with the Sport Chrono package, the PCM can be used to activate automatic door locking.

Please observe the chapter "Individual Memory" in the separate PCM operating instructions.

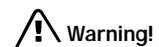

In an emergency situation where you need to exit the car through an automatically locked door, remember the following procedure to open the door.

- f Unlock the doors by pressing the central locking button **or**
 - f pull the inside door handle **twice** to open the door.
-



A - Light-emitting diode for alarm system

Alarm System, Passenger Compartment Monitoring

This device complies with:
Part 15 of the FCC Rules
RSS-210 of Industry Canada.

Operation is subject to the following two conditions:

1. This device may not cause harmful interference, and

2. this device must accept any interference received, including interference that may cause undesired operation.

Note

The manufacturer is not responsible for any radio or TV interference caused by unauthorized modifications to this equipment. Such modification could void the user's authority to operate the equipment.

Warning!

Any changes or modifications not expressly approved by Porsche could void the user's authority to operate this equipment.

The alarm system and passenger compartment monitoring system are switched on when the doors are locked with the key or remote control.

- f Please observe the chapter "CENTRAL LOCKING" on Page 22.

Unlocking the vehicle by using the key in the door lock and opening the door may activate the alarm system within 10 seconds.

Cabriolet

The passenger compartment monitoring system is always switched off when the convertible top is open.

Function indication

If the alarm system is activated, light-emitting diode **A** in the central locking switch flashes.

If, after locking, the light-emitting diode does not flash or, after ten seconds, it emits double flashes, then **not** all alarm contacts are closed. Additionally, a brief horn signal sounds.

When the doors are unlocked, the alarm system and passenger compartment monitoring system are switched off and the light-emitting diode goes off.

When the alarm is armed, the following areas are monitored

- Doors
- Luggage compartment lid
- Engine compartment lid
- Convertible-top lock (Cabriolet)
- Glove compartment
- Passenger compartment

If one of these alarm contacts is interrupted, the alarm horn sounds for approximately 3 minutes. Additionally, the emergency flasher flashes and the passenger compartment light lightes for approximately five minutes.

When the alarm is triggered, the light-emitting diode changes over to double flashes.

In order not to limit the action range of the passenger compartment monitoring system:

- f Do not fold the front seat backrests forward.

Deactivating the passenger compartment monitoring system for one locking process

If a person or animal remains in the car while it is locked, the passenger compartment monitoring system must be switched off.

- f Quickly lock car **twice**.
The doors are locked but can be opened from the inside:

1. Pull inner door handle once to unlock door lock.
2. Pull inner door handle again to open door.

Note

- f Inform any person remaining in the car that the alarm system will be triggered if the door is opened.

Fault indication

A double **horn signal** during locking indicates a defect in the central locking or alarm system.

- f Have the defect remedied at an authorized Porsche dealer.

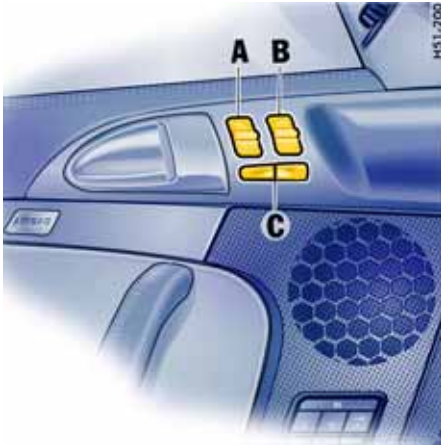

A - Power window in driver's door
 B - Power window in passenger's door
 C - Cabriolet: Switching button for front/rear power windows

Power Windows

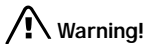

Warning!

Risk of injury when the door windows close. This applies especially if the windows are closed with the one-touch operation, because with this function the window goes up automatically.

- f Make sure nobody can be injured when the windows close.

- f Remove the ignition key to shut off power to the window switches when the vehicle is not attended by a responsible person. Uninformed persons could injure themselves by operating the power windows.

- f Do not leave children in the car unattended.

Risk of an accident.

- f Do not put anything on or near the windows that may interfere with the driver's vision.

Readiness for operation of power windows

- When the ignition is switched on (engine switched on or off) **or**
- with doors closed and ignition key withdrawn, but only until door is first opened. One-touch operation for closing the door windows is available only when the ignition is switched on.

Cabriolet

When the convertible top is open, the rear side windows can only be closed if the door windows are closed.

Opening/closing windows

- f For the **Cabriolet**, select front or rear power windows with rocker switch **C**. The selection is displayed by the respective light-emitting diode.

The two rocker switches in the driver's door and the switch in the passenger's door have a two-stage function:

Opening window with the rocker switch

- f Press the rocker switch down to the first stage until the window has reached the desired position.

Closing window with the rocker switch

- f Press the rocker switch upwards to the first stage until the window has reached the desired position.

One-touch operation

- f Press the rocker switch upwards or downwards to the second stage. Window moves to its final position. Press again to stop the window in the desired position.

Coupé

One-touch operation for closing the passenger's window is available once the window is approximately half-way closed.

Comfort function when unlocking the vehicle

- f Unlock car with the remote control. Hold car key in door lock in the unlocking direction until the windows have reached the desired position.

Anti-crushing protection

If a side window is blocked during closing, it will stop and open again by about an inch.

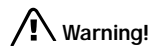

Risk of severe personal injuries.

If the rocker switch is pressed again within 10 seconds of the window being blocked, the window will close with its full closing force.

Anti-crushing protection is disabled.

- f Once the anti-crushing protection acts to stop the window and opens it slightly, do not press the rocker switch again within 10 seconds without checking to make sure that nothing is blocking the path of the window. The window will close with full closing force.

One-touch operation is disabled for 10 seconds after blockage of a side window.

Automatic window lowering

- f Please observe the chapter "DOORS" on Page 21.

Storing end position of the windows

If the battery is disconnected and reconnected, the windows will not be raised automatically when the door is closed.

1. Close the windows with the rocker switch **once**.
2. Press the rocker switch upwards again to store the end position of the windows in the control unit.



Inside mirror

When the mirror is being adjusted, the anti-glare lever must point forward.

Basic position: lever forward
 Anti-glare position: lever back



Door Mirrors

Before driving the vehicle, adjust the outside and inside mirrors.

It is important for safe driving that you have good vision to the rear.

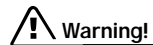

Warning!

Risk of an accident.

- f Do not put anything on or near the windows or the mirrors that may interfere with the driver's vision.

Adjusting

1. Switch on ignition.
2. By turning the control switch **A**, select the driver's side or the passenger's side.
3. Move the door mirror glasses in the appropriate direction by tilting the control switch.

If the electrical adjustment facility fails

- f Adjust mirror by pressing on the mirror face.

Automatically swivelling down mirror on the passenger's side

- f Please observe the chapter "PARKING AIDS" on Page 58.
- f Please observe the chapter "SEAT MEMORY" on Page 36.

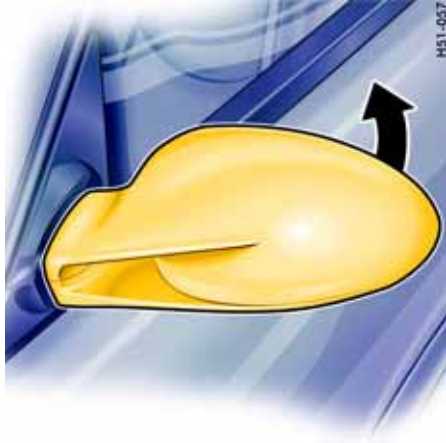

Folding in door mirrors

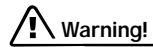

Warning!

Danger of injury to fingers if the mirror accidentally flips back when being folded in.

f Exercise extreme caution when folding in mirror by hand. Do not let go of the mirror before the locking lever is locked or the mirror is fully unfolded.



1. Push mirror towards the door window and continue to hold it (high spring force).
2. Swivel the locking lever up to the stop and slowly let go of the mirror.

Unfolding door mirrors

1. Push mirror towards the door window and continue to hold it (high spring force). The locking lever disengages automatically.
2. Move mirror back to unfolded position by hand. Do not let go of the mirror beforehand.

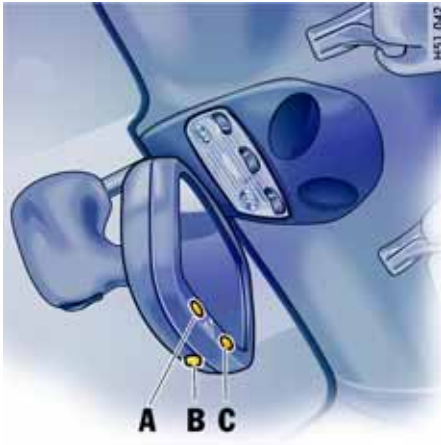

A - Sensor
 B - Switch for automatic anti-glare operation
 C - Light-emitting diode

Automatic Anti-Glare Interior Mirror and Door Mirror

Sensors on the front and rear sides of the interior mirror measure the incident light.

The mirrors automatically change to anti-glare position or revert to their normal state, depending on the light intensity.

When reverse gear is selected, automatic anti-glare operation is switched off.

Note

The incident light in the area of the sensors must not be restricted, e.g. by stickers on the windshield.

Switching off the automatic anti-glare operation

- f Press switch B.
Light-emitting diode C goes out.

Switching on the automatic anti-glare operation

- f Press switch B.
Light-emitting diode C lights up.

Warning!

Risk of injury. Electrolyte fluid can emerge from a broken mirror glass. This fluid irritates the skin and eyes.

- f If the electrolyte fluid should come into contact with the eyes or skin, immediately rinse it off with clean water.
See a doctor if necessary.

Risk of damage to the paintwork, leather and plastic parts. Electrolyte fluid can be removed only while it is still wet.

- f Clean the affected parts with water.



 **Rear Window Defogger,
Door Mirror Heating**

The mirror heater is ready for operation when the ignition is on.

Switching on

- f Press button.
The light-emitting diode in the button lights up.
- After approx. 15 minutes, the heater switches off automatically.
The heater can be switched back on by pressing the button again.

Switching off

- f Press button.
The light-emitting diode in the button goes out.

Seat Adjustment



Warning!

The seat may move unexpectedly if you attempt to adjust while driving. This could cause sudden loss of control or personal injury.

- Do not adjust seats while the vehicle is in motion.
The backrest locks must be engaged at all times while the vehicle is in motion.

Safety belts only offer protection when the backrest is upright and the belts are properly positioned on the body.

Improperly positioned safety belts or safety belts worn by passengers in an excessively reclined position can cause serious personal injury in an accident.

- Do not operate the car with the driver or passenger backrests excessively reclined (see "Seat position").

In the cabriolet, the windstop may be damaged during seat adjustment and when folding back the front-seat backrest.

- Adjust seat so that the seat backrest does not touch the windstop.

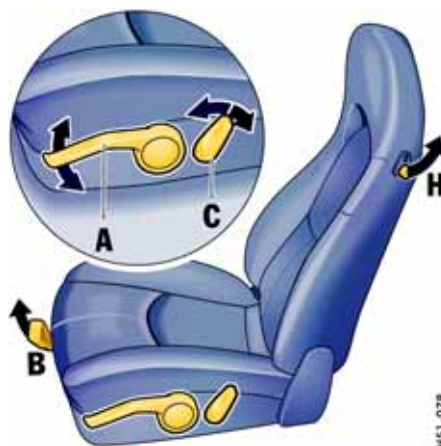

H51-078

Seat position

An ergonomically correct sitting position is important for safe and fatigue-free driving. We recommend the following procedure for adjusting the driver's seat to suit individual requirements:

- Vehicles with manual transmission:
Adjust the seat until, with the clutch pedal fully depressed, your leg remains at a slight angle.

Vehicles with Tiptronic S:
Adjust the seat until, with your left foot on the footrest, your left leg remains at a slight angle.

- Rest your outstretched arm on the steering wheel.
Set the backrest angle and the steering-wheel position so that your wrist rests on the outer rim of the steering wheel. At the same time, the shoulders must still be in noticeable contact with the backrest.
- Adjust the seat height to give yourself enough headroom and a good overview of the vehicle.
- Electrically adjustable seat:
Adjust the seat angle until your thighs rest lightly on the seat cushion.

Manually adjustable comfort seat/sports seat

A Seat height

- Use lever **A** in a pumping movement:
Upwards – seat moves upwards
Downwards – seat moves downwards

B Fore and aft

- Raise locking lever **B**.
Move seat to desired position and release lever.
Ensure that the seat engages correctly.

C Backrest angle

- Operate switch **C** until the desired backrest angle is reached.



**Electrically adjustable
comfort seat/sports seat**

f Press the switch in the direction indicated by the arrow until the desired setting is reached.

- A Seat height adjustment**
- B Fore-and-aft position adjustment**
- C Seat angle adjustment**
- D Backrest angle adjustment**

**E Lumbar support
(pelvis and spinal column support)**

To permit a relaxed sitting posture, the backrest curvature is continuously adjustable in vertical and horizontal directions for individual pelvis and spinal column support.

f Press the switch in the direction indicated by the arrow until the desired backrest curvature is reached.

**F Adjusting the backrest side bolsters
(electrically adjustable sports seat only)**

f Push forward or pull backward switch F until the side bolsters are adjusted to the shape of the body.

**G Adjusting the seat cushion side bolsters
(electrically adjustable sports seat only)**

f Push forward or pull backward switch G until the side bolsters are adjusted to the shape of the body.

Seat backrest

Folding forward

f Pull up lever H in the side part of the backrest and fold the backrest forward.

Folding back

f Tilt back and engage the backrest so that it cannot tip forward when the car is braked.



M - Memory button
1 - Key button
2, 3 - Person buttons

Seat Memory

Individual seat and door mirror settings can be stored and recalled for the driver's position.

Further individual setting options are available in vehicles with the Sport Chrono package. Please observe the chapter "Individual Memory" in the separate PCM operating instructions.

Warning!

Risk of crushing due to uncontrolled recall of a seat setting.

- f Cancel automatic adjustment by pressing any of the seat adjustment buttons.
- f Do not leave children in the vehicle unattended.

Operation with person buttons 2, 3

Storing seat position

1. Switch on ignition.
Reverse gear must not be engaged.
2. Set the desired seat and door-mirror positions.
3. Keep memory button **M** depressed and additionally press person button **2** or **3**.
The individual setting is now stored under the desired person button.

Recalling seat position

1. Switch on the ignition or open the driver's door.
2. Press person button until the seat has reached its final position.
The setting of door mirrors and lumbar support will be completed even if the person button is not kept depressed.

Note

Automatic seat adjustment can be interrupted immediately by releasing the button.

Operating with the remote control of the vehicle key

Each remote control (up to six) can be assigned an individual seat and door mirror position. The stored seat and door mirror position is set automatically when the vehicle is unlocked using the corresponding remote control.

Storing seat position

1. Switch the ignition on with the desired vehicle key.
Reverse gear must not be engaged.
2. Set the desired seat and door-mirror positions.
3. Keep memory button **M** depressed and additionally press key button **1**.
The individual setting is now assigned to this remote control and to the key button.

Storing individual lowered position of the passenger's door mirror as a parking aid

Once the driver's seat setting has been stored, an individual lowered position of the passenger's door mirror may be stored for driving in reverse:

1. Apply the handbrake.
2. Switch the ignition on with the desired vehicle key.
3. Engage reverse gear.
4. Select passenger side with mirror switch.
The passenger's mirror swivels downwards.
5. Set passenger's door mirror to desired final position.
6. Keep memory button **M** depressed and additionally press key button **1**.
The individual setting is now assigned to this remote control and to the key button.

Recalling seat position

- f Unlock the locked vehicle or the luggage compartment with the remote control.
The stored seat position is automatically set.

The seat position assigned to a remote control can also be recalled with the key button **1** if the corresponding key was used to switch on the ignition.

If no seat position has been assigned to a remote control, the key button will not work.

Note on operation

Automatic seat adjustment can be interrupted immediately:

- by switching on the ignition,
- by pressing the central locking button,
- by pressing any memory or seat adjustment button.

Clearing the stored seat position

1. Switch the ignition on with the desired vehicle key.
2. Press memory button twice and key button **1** once consecutively.



A - Seat heating, left
B - Seat heating, right

Switching on

High heating power

- f Press button.
Both light-emitting diodes in the button light up.

Low heating power

- f Press the rocker-switch symbol again.
One light-emitting diode in the button lights up.

Switching off

- f Press button.
Light-emitting diodes go out.

Heated Seats

Two-stage seat heating is ready for operation when the ignition is on.

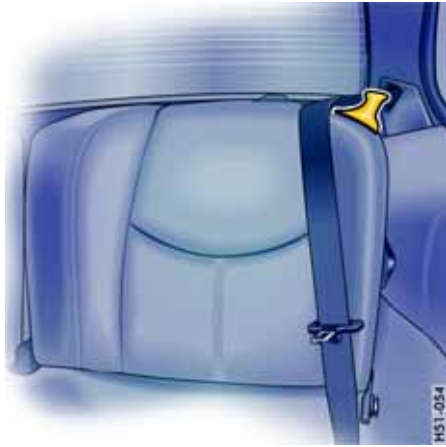

Rear Seat Backrests

Extra storage space is gained by folding the rear seat backrests forward.

Folding forward

- f Pull lever forward and fold the backrest forward.

Folding back

- f Tilt the backrest back until you feel it click into place. When doing so, make sure that the seat belt is properly routed (see figure).

Cabriolet

- f Do not fold up the rear seat backrests with the windstop installed.

Steering Wheel Adjustment

Warning!

Risk of accident.

The steering wheel may move further than desired if you attempt to adjust it when driving.

You can lose control of the vehicle.

- f Do not adjust the steering wheel when driving.



Adjusting steering wheel height and longitudinal direction

1. Push the locking lever downwards.
2. Adjust steering wheel to fit the chosen backrest angle and your seat position by moving the steering wheel up or down and longitudinally.
3. Swivel locking lever back until you feel it engage.
If necessary, move steering wheel slightly longitudinally.

Multi-Functional Steering Wheel

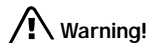

Warning!

There is a danger of accident if you set or operate the on-board computer, radio, navigation system, telephone or other equipment when driving.

Operating these devices while driving could distract you from traffic and cause you to lose control of the vehicle.

- f Operate these components while driving only if the traffic situation allows you to do so safely.
- f Carry out any complicated operating or setting procedures only while the vehicle is stationary.

Depending on the equipment in your vehicle, you can use the function keys of the multi-functional steering wheel to operate the following Porsche communication systems:

- PCM
- Telephone
- CD changer



Readiness for operation of multi-functional steering wheel

The multi-functional steering wheel is ready for operation when the ignition **and** PCM are switched on.

Operating the function keys

- f Please read the separate PCM operating instructions before operating the function keys.

The rotary knobs at the top left and right of the steering wheel can also be pressed.



Turn volume control

Upwards – increase volume.

Downwards – decrease volume.

Press volume control

To switch volume/mute on and off.



Turn rotary knob

To select/mark function in the PCM within a menu. To do this, turn the rotary knob upward or downward.

Press rotary knob

To activate selected function.



Press screen button

To call the stored PCM function.

The button can be assigned the desired function in the PCM.



Press Back button

To move back in the PCM menu.



Press Handset Pickup button

To accept a telephone call.



Press Gandset Hangup button

To end or refuse a telephone call.



Vanity mirror

The vanity mirror on the rear of the sun visor is covered by a lid.

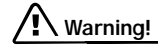

Warning!

Risk of injury.

- f Keep the lid closed while driving and when closing the convertible top.

Risk of damage.

- f Do not force the lid beyond its end position.

The vanity mirror illumination is switched on automatically when the cover is opened (**arrow**).

Sun Visors

- f Swing the sun visors down to prevent glare from the front.
- f To prevent glare from the side, unclip the sun visor from the inner bracket and swivel round so that it is in front of the door window.

Safety Belts

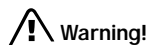

Warning!

Always make sure your and your passengers' safety belts are properly fastened while the vehicle is in motion.

Failure to follow safety belt warnings may result in serious personal injury or death.

- f For your and your passengers' protection, use safety belts at all times while the vehicle is in motion.
- f Use appropriate child restraint systems for all small children.

Proper wearing of safety belts

- f Safety belts must be positioned on the body as to restrain the upper body and lap from sliding forward. Improperly positioned safety belts can cause serious personal injury or death in case of an accident.
- f The shoulder belt should always rest on your upper body. The shoulder belt should never be worn behind your back or under your arm.
- f For maximum effectiveness, the lap belt should be worn low across the hips.
- f Pregnant women should position the belt as low as possible across the pelvis. Make sure it is not pressing against the abdomen.

- f Belts should not be worn twisted.
- f Do not wear belts over rigid or breakable objects in or on your clothing, such as eye glasses, pens, keys, etc. as these may cause injury.
- f Several layers of heavy clothing may interfere with proper positioning of belts.
- f Belts must not rub against sharp objects or damage may occur to the belt.
- f Two occupants should never share the same belt at the same time.

Care and maintenance

- f Keep belt buckles free of any obstruction that may prevent a secure locking.
- f Belts that have been subjected to excessive stretch forces in an accident must be inspected or replaced to ensure their continued effectiveness in restraining you. The same applies to belt tensioner systems which have been triggered. In addition, the anchor points of the belts should be checked.
- f If safety belts do not work properly, see your authorized Porsche dealer immediately.
- f If the belts show damage to webbing, bindings, buckles or retractors, they should be replaced to ensure safe operation.
- f Do not modify or disassemble the safety belts in your vehicle.

- f The belts must be kept clean or the retractors may not work properly. Please observe the chapter "CAR CARE INSTRUCTIONS" on Page 218.
- f Never bleach or dye safety belts.
- f Do not allow safety belts to retract until they are completely dry after cleaning or this may cause damage to the belt.

Belt tensioner

Depending on the force of an impact, fastened safety belts are tightened in an accident.

The belt tensioners are triggered in:

- Front, side and rear impacts of sufficient severity.
- For the Cabriolet, in cases of vehicle rollover.

Note

The belt-tensioner system can be triggered only once; the system must be replaced afterward.

If there is a fault in the belt-tensioner system, the airbag warning light lights up.

Work may be performed on the belt-tensioner system only by an authorized Porsche dealer. Smoke is released when the belt tensioners are triggered. This does not indicate a fire in the vehicle.



Safety Belt Warning System

An **audio-visual warning** system is interconnected with the driver's safety belt.

Every time the ignition is turned on, the gong will sound for about 6 seconds to remind driver and passenger to buckle up. In addition, the gong will sound for approx. 90 seconds if vehicle speed exceeds 15 mph/24 km/h. The safety belt warning lights in the instrument panel and on-board computer will go off as soon as the driver has buckled up.



Inertia reel retractor

The combination lap/shoulder belt with inertia reel locking mechanism adjusts automatically to your size and movements as long as the pull on the belt is slow.

Rapid deceleration during hard braking or a collision locks the belt. The belt will also lock when you drive up or down a steep hill or in a sharp curve, otherwise, the shoulder belt will not inhibit your upper body movement.

Fastening the safety belt

- f Assume a comfortable sitting position. The shoulder belt should always rest on your upper body. The shoulder belt should never be worn behind your back or under your arm.
- f Grasp belt and pull the belt in a continuous slow motion across your chest and lap.
- f Insert belt tongue into buckle on inboard side of seat. Push down until it securely locks with an audible click. Pull the belt to check.
- f Pull shoulder section to make sure belt fits snugly across the pelvis.
- f Belts should fit snugly across the pelvis and chest. Make sure there is no slack in the belt.

Releasing the safety belt

- f Push in release button (**arrow**) on buckle. Belt tongue will spring out of buckle.
- f To release a latched belt, lean back to take the body pressure off the belt.
- f To store lap/shoulder belt, allow the belt to retract as you guide the latch to its stowed position.
- f Please observe the chapter "AUTOMATIC LOCKING RETRACTOR" on Page 54.

f f f



Cleaning the safety belts

- f Please observe the chapter "SAFETY BELTS" on Page 226.

Safety belt height adjustment

(Coupé only)

The height of the belt deflectors for the driver's seat and passenger's seat can be adjusted. Adjust the height of the safety belt so that it runs across the middle of the shoulder, not against the neck.

Adjusting belt height

- f Upward – push belt deflector up.
- f Downward – press button (**arrow**) and move belt deflector.

Airbag Systems

The airbags in combination with the safety belts make up a safety system which offers the driver and the passenger the greatest known protection from injuries in case of accident.

Your vehicle is equipped with a weight sensing system for the front passenger's seat in accordance with U.S. Federal/Canadian Motor Vehicle Safety Standard 208.

Even if your vehicle is equipped with airbags, **the safety belts must be worn at all times**, because the front airbag system is only deployed by frontal collisions with an impact of sufficient severity.

Below the deployment threshold of the airbag system, and during types of collisions which do not cause the actuation of the system, the safety belts provide the primary protection to the occupants when correctly worn.

Therefore, all persons within the vehicle must wear safety belts at all times (in many states, state law requires the use of safety belts).

f Please observe the chapter "SAFETY BELTS" on Page 42.

The **front airbags** are located under the padded steering wheel panel on the driver's side and, on the passenger's side, in the dashboard.

The **side airbags** for the front seats are installed on the side in the seat backrests.

The **head airbags** are installed in the door linings.



To provide optimal occupant protection, airbags must inflate at very high speed. If you are not wearing your safety belt or are too close to the airbag when it is deployed, inflating airbags can result in serious personal injury or death.

Improper handling of the weight sensing system can unintentionally impair switching the passenger's airbag off and on.

- f Make sure there are no people, animals or objects between the driver or passenger and the area into which the airbag inflates.
- f Sit back as far from the dashboard or steering wheel as is practical, while still maintaining full vehicle control.
- f Always hold the steering wheel by the outer rim. Never rest your hands on the airbag panel.
- f **Always fasten seat belts** because triggering of the airbag system depends on the force and angle of impact.
- f Do not transport heavy objects on or in front of the passenger's seat. These could impair the function of the airbag, the seat belts, and weight sensing.
- f Do not hang objects (e.g. jackets, coats, coat hangers) over the backrest.

- f Always keep the lid of the door storage compartment closed. Objects must not protrude out of the door storage compartment.
- f No changes may be made to the wiring or components of the airbag system.
- f Do not add any additional coverings or stickers to the steering wheel or in the area of the passenger's airbag, side airbags and head airbags. Doing so may adversely affect the functioning of the airbag system or cause harm to the occupants if the airbag system should deploy.
- f Do not modify the seat coverings. Do not attach additional cushions, protective coverings, or pillows to the passenger's seat. Do not affix things to the passenger's seat or cover it with other materials. Do not cover the back of the backrest. Do not make changes to the passenger's seat and to the seat base frame.
- f Do not undertake any wiring for electrical accessory equipment in the vicinity of the airbag wiring harnesses. Doing so may disable the airbag system or cause inadvertent inflation.
- f If the warning light comes on, the airbag system should be repaired immediately by your authorized Porsche dealer.
- f Always keep feet in the footwell while driving. Do not put feet on the dashboard or the seat area. Do not lean against the inside of the door or outside the window while the vehicle is moving.

- f Using accessories not approved by Porsche can cause the weight sensing system to be impaired.
- f Do not squeeze objects, such as the fire extinguisher, or first aid kit under the seat.
- f Only have seats removed and installed by an authorized Porsche dealer so that weight sensing components will not be damaged.
- f Give your passenger all of the information in this chapter.

Note

Airbag components (e.g. steering wheel, door lining, seats) may be disassembled only by an authorized Porsche dealer.

When disposing of a used airbag unit, our safety instructions must be followed. These instructions can be obtained at any authorized Porsche dealer.

Function of the airbag system

The front airbags are triggered during a frontal collision of sufficient force and direction.

In the event of a side impact of corresponding force, the side airbag on the impact side is triggered.

The inflation process generates the amount of gas required to fill the airbags at the necessary pressure in fractions of a second.

Airbags protect the head and upper body, while simultaneously damping the motion of the driver and passenger in the impact direction in the event of a frontal impact or side impact.

Your vehicle is equipped with a crash sensing and diagnostic module. This module will record the use of the seat belt restraint system by the driver and front passenger when the airbags and/or belt tensioner work.

Advanced Airbag

Your vehicle is equipped with a weight sensing system for the passenger's seat in accordance with U.S. Federal/Canadian Motor Vehicle Safety Standard 208.

Depending on the weight acting on the front passenger's seat, the front passenger's airbag will automatically be switched on and off.

Depending on the angle and force of impact, the front passenger's airbag which is activated will be triggered during a collision.

Precondition for switching the front passenger's airbag on and off, depending on weight:

- Vehicles equipped with key-operated airbag deactivation device:
Switch position AUTO.
- Ignition key is inserted.

Seat adjustment for the front passenger's seat

If the seat is in an extreme position (e.g., the backrest is in contact with the rear seat), the backrest can warp. Warping of the backrest can lead to malfunctions.

- f Correct the seat adjustment.
Ensure that the seat is not jammed and is self-supporting.
Ensure that the backrest is in the upright position.

- f Do not transport a load and objects in the rear footwell and under the passenger's seat.
If the load or objects are under the seat, it can cause malfunctions.

If the weight on the passenger's seat is reduced significantly, e.g., by supporting weight on the armrest, the passenger's airbag can be switched off.

- f Select an upright seat position, and do not support weight on the armrests or lean out of the window.
Always keep feet in the footwell while driving.
Do not put feet on the dashboard or the seat area. Do not lean against the inside of the door or outside the window while the vehicle is moving.

If the passenger's seat is warped significantly, a message is displayed on the on-board computer:

- f Correct the seat adjustment.
- f Please observe the chapter "WARNINGS ON THE INSTRUMENT PANEL AND THE ON-BOARD COMPUTER" on Page 122.

Automatic deactivation of the front passenger's airbags



Danger!

The use of a child restraint system in the front passenger's seat can result in serious personal injury or death to the child from an airbag deployment.

- f Please observe the chapter "PASSENGER AIRBAG OFF INDICATOR LAMP DOES NOT LIGHT UP" on Page 49.
- f Before transporting a child on the passenger's seat:
Please observe the chapter "CHILD RESTRAINT SYSTEMS" on Page 51.

- When an **up to one-year old child** is seated in the child restraint system, the front airbag is automatically deactivated on the passenger's side.
- When an adult is seated in the front seat, the front airbag remains active on the passenger's side.

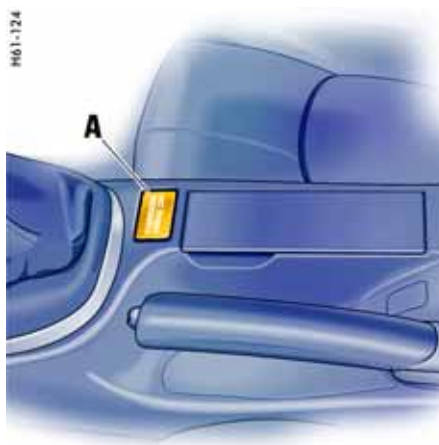

A - PASSENGER AIRBAG OFF indicator lamp

Note on operation

Although not desired, it can occur in the case of heavier children that the passenger's airbags remain active or, in the case of very light adults or young persons, that the passenger's airbag is deactivated.

The condition of the passenger's airbag system is shown by the indicator lamp **A**.

If in doubt:

- f Please observe the chapter "PASSENGER AIRBAG OFF INDICATOR LAMP DOES NOT LIGHT UP" on Page 49.
- f Please observe the chapter "KEY-OPERATED AIRBAG DEACTIVATION DEVICE" on Page 50.
- f Please observe the chapter "CHILD RESTRAINT SYSTEMS" on Page 51.
- f Please observe the chapter "LATCH SYSTEM CHILD SEAT BRACKET ON THE PASSENGER'S SEAT" on Page 55.

Note

- f After inserting the ignition key, the PASSENGER AIRBAG OFF warning light lights up for a few seconds as a bulb check.

PASSENGER AIRBAG OFF indicator lamp lights up

- The passenger's airbag is switched off.

PASSENGER AIRBAG OFF indicator lamp does not light up

- The passenger's airbag is active and ready for operation.
- If the passenger's seat is not occupied, the PASSENGER AIRBAG OFF indicator lamp will also not light up, even though the passenger's airbag is switched off.



Danger!

Risk of serious personal injury or death due to the passenger airbag triggering unintentionally.

When the ignition is on and the up to one-year old child is seated in the child restraint system on the passenger's seat, the indicator lamp "PASSENGER AIRBAG OFF" must be on.

If the "PASSENGER AIRBAG OFF" indicator lamp does not light up, it could indicate a fault in the system.

In this case:

- f Child restraint systems **facing forwards**:
Install on the rear seats.
- f Child restraint systems **facing rearwards**:
On vehicles **with** key-operated airbag deactivation device: Switch to position OFF.
- f Child restraint systems **facing rearwards**:
On vehicles **without** key-operated airbag deactivation device: Do not use a child restraint system in the front passenger's seat.

- f Have the fault remedied at your nearest authorized Porsche dealer.

Note

The key switch for switching off the passenger's airbag in combination with the LATCH attachment bracket are not installed at the factory. They can be retrofitted.

- f Please see your authorized Porsche dealer.



Warning light and warning message

Faults are indicated by a warning light in the instrument panel and a message on the on-board computer.

- f Please observe the chapter "WARNINGS ON THE INSTRUMENT PANEL AND THE ON-BOARD COMPUTER" on Page 122.

In the following cases you should immediately consult an authorized Porsche dealer in order to assure the airbag system is functioning properly:

- If the warning light does not light up when the ignition key is inserted **or**
- If the warning light does not go out once the engine is running **or**
- If the warning light appears while driving.

Airbag maintenance

In order to ensure long-term functioning, the airbag system must be inspected by an authorized Porsche dealer at the intervals recommended in your Maintenance Booklet.

Important information

If you sell your Porsche, notify the purchaser that the vehicle is equipped with airbags, and refer them to the chapter, "Airbag Systems", in the Owner's Manual (safety and disposal rules).

Further information on the airbag system can be found on stickers attached to the sun visors.

For special recommendations on the use of child restraints:

- f Please observe the chapter "CHILD RESTRAINT SYSTEMS" on Page 51.



Key-operated airbag deactivation device

If in doubt about the status of the airbag, you can switch off the passenger's airbag on the key switch.

- f Switch off the passenger's airbag on the key switch using the vehicle key.

Switch position AUTO – passenger's airbag system is active

Switch position OFF – passenger's airbag system is switched off

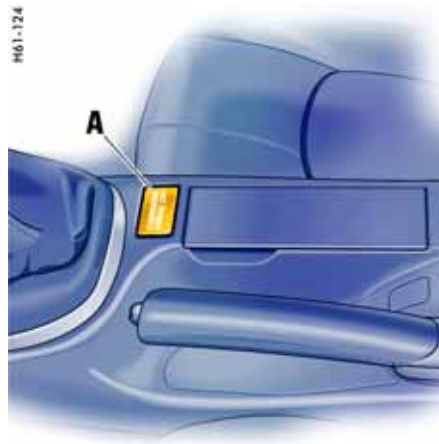

A - PASSENGER AIRBAG OFF indicator lamp

! Danger!

Risk of serious personal injury or death for passenger if passenger's airbag remains switched off after the child restraint system is removed.

- f Make sure that the key switch is switched to AUTO once the child seat has been removed, in order to provide protection to the adult occupants.

Warning light "PASSENGER AIRBAG OFF"

If the airbag on the passenger's side is switched off:

- Warning light "PASSENGER AIRBAG OFF" is continuously lit when the ignition key is inserted.

! Danger!

Risk of serious personal injury or death from the passenger's airbag.

If the "PASSENGER AIRBAG OFF" warning light "A" is not lit when the ignition key is inserted and the Airbag OFF switch is switched to the OFF-Position, this could indicate a fault in the system.

- f Do not install a child restraint system on the passenger's seat.
- f Have the fault remedied immediately. Please see your authorized Porsche dealer.

Note

The key switch for switching off the passenger's airbag in combination with the LATCH attachment bracket are not installed at the factory. They can be retrofitted.

- f Please see your authorized Porsche dealer.

Child Restraint Systems

Porsche recommends that all infants and children be restrained in child restraint systems at all times while the vehicle is in motion in accordance with applicable laws.

Use only child restraint systems with the LATCH-system recommended by Porsche. These systems have been tested and adjusted to the interior of your Porsche and the appropriate child age groups. Other systems have not been tested and could entail an increased risk of injury or death.

You can obtain child seats that are LATCH compatible at your authorized Porsche dealer.

- f Always observe the separate installation instructions for your child seat.

The use of infant or child restraints is required by law in all 50 states of the U.S. and all Canadian provinces. The child restraint system should be one that complies with U.S. Federal/Canadian Motor Vehicle Safety Standards and should be secured by a lap belt or lap belt portion of a lap-shoulder belt or for child seats equipped with the LATCH system (Lower Anchorage and Tether for Children, also known as ISOFIX) to the LATCH anchorages.

A statement by the seat manufacturer of compliance with this standard can be found on the instruction label on the restraint and in the instruction manual provided with the restraint.

Danger!

The use of a child restraint system in the front passenger's seat can result in serious personal injury or death to the child from an airbag deployment.

To reduce risk of injury from an inflating airbag in an accident, Porsche strongly recommends:

- f Please observe the chapter "PASSENGER AIRBAG OFF INDICATOR LAMP DOES NOT LIGHT UP" on Page 49.
- f Please observe the chapter "CHILD RESTRAINT SYSTEMS" on Page 51.

Note

The key switch for switching off the passenger's airbag and the LATCH attachment bracket are not installed at the factory. They can be retrofitted.

- f Please see your authorized Porsche dealer.

Danger!

Risk of serious personal injury or death to the child.

- f Follow all child restraint instructions and warnings in this manual.
- When using an infant or child restraint system, be sure to follow all manufacturer's instructions on installation and use.

- Infants and small children should never be held on the lap, nor should they share a safety belt with another occupant while the vehicle is in motion.
- Children too big for child restraint systems should use regular safety belts. A shoulder belt can be used providing it does not cross the face or the neck of the child.
- Choose a child restraint system according to the age and size of the child.
- Child restraint systems that are damaged or have been heavily stressed in an accident must be replaced immediately.
- Do not affix things to child restraint systems or cover it with other materials.
- Your authorized Porsche dealer will be glad to advise you about the installation possibility for a Porsche child restraint system which allows a key-operated airbag deactivation of the passenger's airbag.
- The key-operated airbag deactivation device installation requires special programming available only from your authorized Porsche dealer.
- f Please observe the chapter "KEY-OPERATED AIRBAG DEACTIVATION DEVICE" on Page 50.

Direction of installation for child restraint systems

Children up to 9 months old

Children of this age must be transported in a restraint system which is installed on the passenger's seat **facing rearward**.

- f The passenger's airbag must be deactivated.

Children aged between 9 months and 6 years

Children of this age are held in child restraint systems **facing forward**.

Whenever possible, these child restraint systems should be installed on the rear seats.

- f The passenger's airbag must be deactivated when these systems are used on the front passenger's seat.

Children aged between 6 and 12 years

Children of this age are held in child restraint systems **facing forward**.

Whenever possible, these child restraint systems should be installed on the rear seats.

- f The passenger's airbag must be deactivated when these systems are used on the passenger's seat.
The passenger's airbag must be activated for children weighing over 59 lbs. (27 kg).

Note

If a child seat with top tether is adapted for use on the front seat, the rear right (passenger's side) anchor point must be used for anchoring the top tether.

It is then not permitted for a passenger to use the rear right (passenger's side) seat.

It is then not permitted to install a child restraint system on the rear right (passenger's side) seat.

- f Please observe the chapter "CHILD RESTRAINT ANCHORAGES" on Page 56.

Using child restraint systems in the front passenger seat



Danger!

The use of a child restraint system in the front passenger seat can result in serious personal injury or death to the child from an airbag deployment.

To reduce risk of injury from an inflating airbag in an accident, Porsche strongly recommends:

- f Please observe the chapter "PASSENGER AIRBAG OFF INDICATOR LAMP DOES NOT LIGHT UP" on Page 49.
- f Please observe the chapter "CHILD RESTRAINT SYSTEMS" on Page 51.

Child restraint system for up to one-year old children

- Make sure that the PASSENGER AIRBAG OFF indicator lamp lights up.
- Adjust the passenger's seat as far away from the airbag as possible.



Danger!

Risk of serious personal injury or death due to the passenger's airbag triggering unintentionally.

When the ignition is on and the up to one-year old child is seated in the child restraint system on the passenger's seat the indicator lamp „PASSENGER AIRBAG OFF" must be on.

If the "PASSENGER AIRBAG OFF" indicator lamp does not light up, it could indicate a fault in the system.

In this case:

- f On vehicles **with** key-operated airbag deactivation device: Switch to position OFF.
- f On vehicles **without** key-operated airbag deactivation device: Do not use a child restraint system in the front passenger's seat.
- f Have the fault remedied at your nearest authorized Porsche dealer.

Child restraint system for children older than one year

Your vehicle is equipped with a weight sensing system for the passenger's seat in accordance with U.S. Federal Motor Vehicle Safety Standard 208. Depending on the weight acting on the passenger's seat, the passenger's airbag will automatically be switched on or off.

Small adult passengers

Make sure that the PASSENGER AIRBAG OFF indicator lamp does not light up.



Danger!

Risk of serious personal injury or death due to the passenger's airbag not triggering.

When the ignition is on and the small adult passenger is seated on the passenger's seat, the indicator lamp "PASSENGER AIRBAG OFF" must be off.

If the "PASSENGER AIRBAG OFF" indicator lamp lights up, it could indicate a fault in the system.

In this case:

- f Carry the passenger on the rear seat.
- f Have the fault remedied at the nearest authorized Porsche dealer.

Automatic locking retractor

The safety belts for the front passenger and rear seats are equipped with an automatic locking retractor for securing the child restraint system. When activated, this retractor allows you to securely fasten the child restraint system in place so that inadvertent movements will not occur.



The use of a child restraint system on the front passenger seat can result in serious personal injury or death to the child from an airbag deployment.

To reduce risk of injury from an inflating airbag in an accident, Porsche strongly recommends:

- f Under all normal circumstances, forward facing child seats must be placed in the rear.

Before transporting a child on the passenger's seat:

- f Please observe the chapter "CHILD RESTRAINT SYSTEMS" on Page 51.

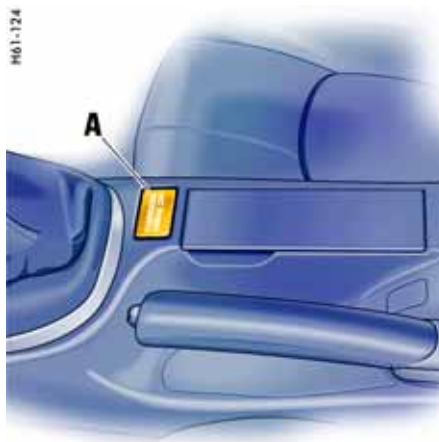

A - PASSENGER AIRBAG OFF indicator lamp



Risk of serious personal injury or death to the child, when excessive force is acting on the passenger's seat due to the seat belt. In such cases, the passenger's airbag can be switched on unintentionally.

- f After fastening the child restraint system, do not adjust the seat.
- f Check the condition of the passenger's airbag system shown by the indicator lamp A in the central console.

Activating the automatic locking retractor

1. If a child restraint system must be fastened to the passenger's seat, adjust the passenger's seat as far away from the airbag as possible.
2. Fasten child seat.
3. Pull the safety belt retractor completely out. At this point the locking mechanism is activated.
4. Insert the safety belt tongue into the buckle and make certain that it is properly latched. Make no more adjustments to the seat.
5. Allow the safety belt to retract until it is tight on the child restraint system. You may further tighten the belt by pulling on it to allow more of it to retract. Make sure that excessive seat belt forces do not occur by moving the seat with the child seat installed.

Releasing the safety belt

1. Unbuckle the safety belt latch.
2. Then make certain that the belt has fully retracted. At this point the automatic locking feature will be disengaged. Seek appropriate advice from your authorized Porsche dealer about the possible installation of a Porsche child restraint system.

LATCH System

Child seat bracket on the passenger's seat

The key switch for switching off the passenger's airbag and the LATCH attachment bracket are not installed at the factory. They can be retrofitted.

f Please see your authorized Porsche dealer.

Porsche recommends the use of a Porsche Child Seat with Lower Anchorage and Tether for Children system (LATCH).

These systems have been tested and adjusted to the interior of your Porsche and the appropriate child age groups. Other systems have not been tested and could entail an increased risk of injury.

You can obtain child seats that are LATCH compatible at your authorized Porsche dealer.

f Always observe the separate installation instructions for your child seat.

f Please observe the chapter "CHILD RESTRAINT SYSTEMS" on Page 51.

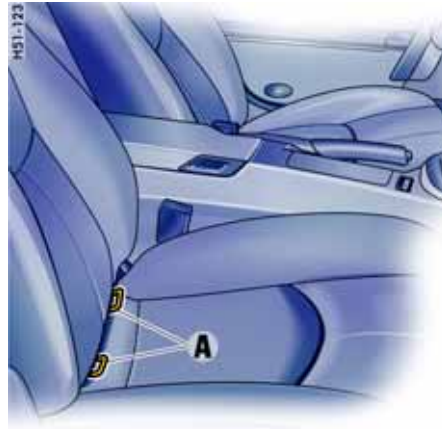

Installing a LATCH child seat system

1. Secure the child seat to retaining lugs **A** as outlined in the instruction manual for the child seat.
2. Pull the child seat to check that both fastening points are engaged correctly.

Note

Make sure that the key switch is switched to AUTO once the child seat has been removed, in order to provide protection to the adult occupants.

Child Restraint Anchorages

(Coupé only)

f Please observe the chapter "AUTOMATIC LOCKING RETRACTOR" on Page 54.

If your child restraint seat or seats require the use of a tether strap, you will want to use the anchor points provided behind the rear seat backrests under the carpet.

To ensure proper installation, see your authorized Porsche dealer.

Note

If a child seat with top tether is adapted for use on the front seat, the rear right (passenger's side) anchor point must be used for anchoring the top tether. It is then not permitted for a passenger to use the rear right (passenger's side) seat.



Warning!

Child restraint anchorages are designed to withstand only those loads imposed by correctly fitted child restraints. Under no circumstances are they to be used for adults safety belts or harnesses. Such use could result in serious personal injury or death.

- f Do not misuse the child restraint anchorages. They are not designed to withstand loads imposed by adults.
- f Only attach **one** child seat tether per anchorage.

Rollover Protection System

The Rollover Protection System on the **Cabriolet** consists of two supplemental safety bars that together with the front windshield frame help to create occupant survival space in case of rollover. Because of the extreme and unpredictable forces which can be encountered in a rollover, it is not possible to guarantee that occupants will be protected from all contact with exterior objects or the ground. However, the Rollover Protection System is designed to maintain the occupant survival space.

The Rollover Protection System is activated automatically in the event of an accident or extreme driving situation.

The protective devices are located behind each rear seat and rapidly deploy within a fraction of a second.

They can deploy under:

- Extreme tilting of the vehicle.
- Loss of ground contact (e.g. Going over the crest of a hill at high speed).



Danger!

Risk of death or serious injury.

- f Do not block area of supplemental safety bars with objects.
In the event of a deployment event, such objects could potentially prevent such deployment from occurring, or such objects could impact the car occupants at high speed.
- f Do not tamper with or work on wiring and or components of Rollover Protection System.
- f All work regarding this system must be carried out by your authorized Porsche dealer.
- f Check functions and periodic service intervals according to maintenance schedule (see your authorized Porsche dealer).

To avoid damage to the convertible top:

- f If the supplemental safety bars are extended for any reason, do not open or close convertible top.



Warning light

Faults in the Rollover Protection System are indicated by the airbag warning light in the instrument panel.

Extension of the supplemental safety bars is no longer ensured.

- f See your authorized Porsche dealer immediately and have the fault remedied.

Lowering the supplemental safety bars after deployment

- f Have this work performed by an authorized Porsche dealer.

Parking Aids

Parking assistant

When the driver backs up, the parking assistant system indicates the distance between the car and a large obstacle behind it, by means of signal tones.

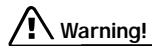

Warning!

Risk of serious personal injury or death. Parking assistant cannot detect small objects such as children and pets. Despite use of the parking assistant system, the driver is still responsible for taking due care and assessing obstacles when backing up.

- f Make sure that no persons, especially small children, animals or obstacles are within the maneuvering area.

The parking assistant system is activated automatically when reverse gear is selected and the ignition is on.

Note

Be aware that the parking assistant system is **not** switched on if the car rolls backward without reverse gear being engaged.



Ultrasonic sensors

H53-063

Sensors

Four ultrasound sensors in the rear bumper measure the distance to the closest obstacle.

- Range middle sensors around 60 in./150 cm
- Range outer sensors around 24 in./60 cm

Obstacles cannot be detected in the "blind" sensor area (e.g. near the ground).

Note

The sensors must always be kept free of dust, ice and snow in order to ensure that they are fully functional.



Caution!

To avoid damaging the sensors:

- f Maintain sufficient distance when cleaning with steam-jet units.

Signal tones/function

When reverse gear is selected, the parking assistant confirms that it is switched on by issuing a **short signal tone**.

A detected obstacle is signalled by an **intermittent tone**. The intervals decrease as the obstacle is approached.

A **continuous tone** sounds when the distance becomes less than one foot. This continuous tone can stop if the obstacle is approached closer than one foot.

The radio volume should not be so loud as to drown out the signal tones.

Limits of ultrasonic measurement

The parking assistant system cannot detect:

- sound-absorbing obstacles (e.g. powder snow),
- sound-reflecting obstacles (e.g. glass surfaces, flat painted surfaces)
- and very thin obstacles.
- Other ultrasound sources (e.g. pneumatic brakes of other vehicles, jackhammers) can interfere with detection of obstacles.

Fault indication

The parking assistant system indicates a fault in two ways:

- After reverse gear has been selected, the short signal tone is followed by a continuous tone of the **same** pitch:
This indicates that sensors are soiled or covered with ice.
- After reverse gear has been selected, the short signal tone is followed by a continuous tone with a much **lower** pitch:
This indicates a general system fault. Please have the fault remedied at an authorized Porsche dealer.



A - Control switch for door mirror adjustment

Swivelling down mirror glass as a parking aid

- f Please observe the chapter "SEAT MEMORY" on Page 36.
- When reverse gear is engaged, the mirror glass on the passenger's side swivels down slightly to show the curb area.

Preconditions

- Vehicle must be equipped with seat memory.
- Set the control switch **A** to "passenger's side".
- Reverse gear must be engaged.

Returning mirror glass to its original position

- f Drive forwards with a speed of over 4 mph (6 km/h) **or**
- f Set the control switch **A** to "driver's side".

Four-Wheel Drive

With the four-wheel drive of the 911 Carrera 4 and 911 Carrera 4S, the engine power is variably distributed to the front and rear wheels.

Power distribution and wheel speed compensation between the front and rear axles is realised with a viscous multiple-disc clutch.

Distribution of the engine power is dependent upon the wheel speed difference between the two axles.

The viscous multiple-disc clutch always delivers sufficient drive power to the front wheels (approx. 5% to 40%) to ensure optimum traction even on a poor road surface.

In combination with the Porsche Stability Management (PSM), four-wheel drive improves handling and increases driving stability.

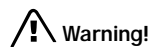

The increased control that is provided should not induce you to take greater risks with your safety. The limits dictated by the laws of physics cannot be overcome, even with four-wheel drive.

The risk of accidents due to inappropriate speed cannot be reduced, even by four-wheel drive.

The driver bears the responsibility for all driving maneuvers.

- f Adapt your driving style to the prevailing road and weather conditions.
- f Obey all traffic laws.

Dynamometer testing procedure

Some U.S. states and Canadian provinces conduct emissions inspection/maintenance testing involving the use of two-wheel dynamometer.

A two-wheeled dynamometer is a treadmill type device upon which a single axle of the car, the driving axle of the vehicle, rotates to simulate vehicle operation on the road while the vehicle remains stationary.

Your 911 Carrera 4 or 911 Carrera 4S has a full-time four-wheel drive system which cannot be disabled. Severe damage to the powertrain can result if tested on a two-wheel dynamometer.



To avoid severe powertrain damage and a possible unexpected movement of the vehicle.

- f Your 911 Carrera 4 or 911 Carrera 4S vehicle must never be tested on a two-wheel dynamometer.
- f Advise the emission station of this warning before testing the vehicle.

Power measurement

Power measurements on dynamometers are not approved by Porsche.

Brake tests

Brake tests must be performed only on plate-type test stands or roller test stands.

The following limit values must not be exceeded on roller test stands:

- Testing speed 5 mph (8 km/h)
- Test duration 20 seconds

Handbrake tests

Handbrake tests on the roller test stand must be performed only with the ignition switched off.

Balancing wheels on the vehicle

During finish balancing of the wheels, the vehicle must be hoisted and all the wheels able to rotate freely.

Towing

- f Please observe the chapter "TOWING" on Page 281.

Retractable Rear Spoiler

The rear spoiler improves driving stability, especially at higher speeds.

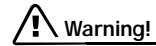

Risk of accident. If the rear spoiler cannot be extended, driving stability will be adversely affected by increased rear axle lift, which could lead to loss of control.

- f Adapt your driving style and speed to the changed driving behaviour.
- f Have the fault remedied at an authorized Porsche dealer.

Risk of injury during manual retraction or extension of the rear spoiler with the vehicle stationary.

- f Make sure that no persons or objects are within the range of movement of the rear spoiler.

Risk of damage from pushing the vehicle by the spoiler.

- f Do not push the vehicle at the spoiler.

Automatic mode

The limits for automatic extension and retraction of the spoiler depend on various circumstances (e.g. driving speed, engine compartment temperature).

Engine compartment temperature under 122°F/55°C

Spoiler extends at 75 mph/120 km/h and retracts at 37 mph/60 km/h.

Engine compartment temperature over 140°F/60°C

Spoiler extends at 50 mph/80 km/h and retracts at 19 mph/30 km/h.

If automatic control fails, a warning message is displayed by the on-board computer.



Manual control

When the ignition is on, the rear spoiler can be extended and retracted manually using the button in the center console.

Extending

- f Press button briefly.
The spoiler extends to its final position.
The light-emitting diode in the button lights up.

Retracting a manually extended rear spoiler

- f **at speeds between 0 and 20 mph (0 and 30 km/h)**
Press and hold button until the rear spoiler has reached its final position.
The light-emitting diode in the button goes out.
The rear spoiler changes to automatic mode.
- f **at speeds between 20 and 60 mph (30 and 100 km/h)**
Press button briefly.
The rear spoiler retracts, the light-emitting diode in the button goes out.
The rear spoiler changes to automatic mode.
- f **at speeds over 60 mph (100 km/h)**
Press button briefly.
The rear spoiler remains extended, the light-emitting diode in the button goes out.
The rear spoiler changes to automatic mode.

Clutch Pedal

The clutch pedal must be depressed fully before the starter will engage.

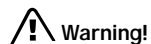

Warning!

Risk of an accident.

- f Always check the movement of the clutch pedal before driving and make sure that it is not obstructed by a floor mat or any other object.
- f Secure the floor mat to prevent it from sliding into positions that could interfere with the safe operation of your vehicle.
Your Porsche dealer will be glad to offer you nonskid floor mats of the correct size.

To avoid damage to the clutch and transmission:

- f Always depress the clutch pedal fully when changing gears.
- f Do not hold the car on a steep grade with the clutch pedal partially depressed.

Should the free travel of the clutch pedal suddenly become larger, it could mean a malfunction of the clutch.

- f See your Porsche dealer for correction.

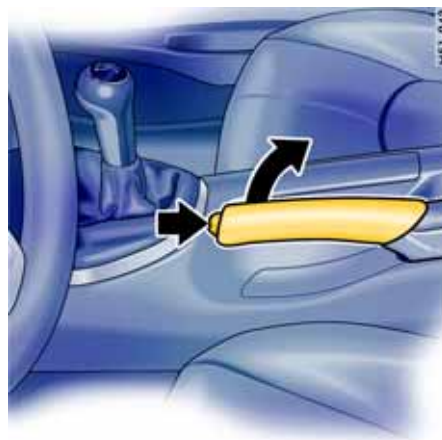

Parking Brake

Parking brake force is mechanically transferred to the rear wheels by means of cables.

- f Use the parking brake only after the vehicle has come to a full stop.

Setting the parking brake

- f Pull the lever **all the way up (arrow)**.
With the ignition on, the parking brake warning lights in the instrument panel and on-board computer will come on if the lever is even slightly raised. A firm pull upward is required to properly engage the parking brake.
If the brake is not fully set, the vehicle may roll without control.
- f Move the selector lever to "P" (Tiptronic) or move the gearshift lever to reverse or first gear (Manual transmission).
- f Before exiting the vehicle, make sure that the parking brake is fully set and the vehicle is not moving at all.



Danger!

Risk of serious personal injury or death. A partially engaged parking brake may allow the vehicle to roll, causing serious personal injury or death to any person in its path.

- f Engage the parking brake fully.

Releasing the parking brake

- f Pull the lever slightly up as you depress the release button, and then push the lever all the way down.

BRAKE Parking brake warning light USA

Parking brake warning light Canada

The warning lights in the instrument panel and on-board computer will go out after the parking brake is fully released.

The warning lights are not an indicator that the parking brake is fully set; it is only intended to be a warning to release the parking brake before driving the car.

Caution!

A partially engaged brake will overheat the rear brakes, reduce their effectiveness and cause excessive wear.

- f Release the parking brake fully.
- f When parking your car, always set the parking brake by pulling all the way up on the lever.
- f Move the selector lever to "P" (Tiptronic) or move the gearshift lever to reverse or first gear (Manual transmission).
- f On hills also turn the front wheels towards the curb.

Brakes

- f Make it a habit to check the operation of your brakes before driving.

Keep in mind that the braking distance increases very rapidly as the speed increases. At 60 mph or 100 km/h, for example, it is not twice but four times longer than 30 mph or 50 km/h. Tire traction is also less effective when the roads are wet or slippery.

- f Therefore, always maintain a safe distance from the car in front of you.

Vehicles without Porsche Ceramic Composite Brake (PCCB)

Even though the brake discs consist of alloyed grey cast iron, they will unavoidably start to corrode if your car is parked for an extended period. The brakes will tend to "rub" as a result.

The nature, extent and effects of corrosion depend on the amount of time the vehicle was parked, whether granular or liquid road salt was spread and whether grease-dissolving agents were used in car washes.

If the braking comfort is noticeably impaired, we recommend having the brake system checked by experts at an authorized Porsche dealer.

Brake system function

Your Porsche is equipped with a power assisted hydraulic dual circuit brake system with disc brakes at the front and rear.

Both circuits function independently. One brake circuit operates the front and the other operates the rear.

If one brake circuit has failed, the other will still operate. However, you will notice an increased pedal travel when you apply the brakes.

Failure of one brake circuit will cause the stopping distance to increase.

Warning!

**Risk of an accident.
In the unlikely event of hydraulic failure of one brake circuit:**

- f Push the brake pedal down firmly and hold it in that position.
A mechanical linkage activates the second circuit, and you will be able to bring the vehicle to a stop.
- f After bringing your vehicle to a complete stop, avoid driving the vehicle and instead have it towed to the nearest authorized Porsche dealer for repair.

BRAKE Brake warning light USA

(!) Brake warning light Canada

If the warning lights in the instrument panel and on-board computer go on while driving, the brake fluid level may be too low, or (if the brake pedal travel has increased) one of the two brake circuits may have failed.

A greater braking pressure will be required, stopping distances will be longer and the braking behavior will change, particularly in curves.

With correctly adjusted brakes, and a correctly working brake system, the pedal travel to the point of brake actuation should be 1-3/16 in. to 1-9/16 in. or 30 to 40 mm.

Whenever the brake pedal travel exceeds this distance, have the brake system checked.

Brake pedal

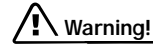

Risk of an accident.

Any obstruction of the brake pedal could increase the stopping distance.

- f Always check the movement of the brake pedal before driving and make sure that it is not obstructed by a floor mat or any other object.
 - f Secure the floor mat to prevent it from sliding into positions that could interfere with the safe operation of your vehicle.
Your Porsche dealer will be glad to offer you nonskid floor mats of the correct size.
-

Note

In case one of the two brake circuits fails, increased pedal travel is required to bring your vehicle to a full stop.

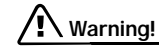

To avoid overheating and premature wear of the brakes:

- f Before descending a steep grade, reduce speed and shift the transmission into a lower gear or driving position to control speed.
 - f Do not "ride the brakes" by resting your foot on the pedal when not intending to apply brake pressure.
 - f Do not hold the pedal down too long or too often.
This could cause the brakes to get hot and not function properly.
-

Brake booster

The brake booster assists braking only when the engine is running.

When the car is moving while the engine is not running, or if the brake booster is defective, more pressure on the brake pedal is required to bring the car to a stop. If this happens, ABS and PSM will also not operate.

Moisture or road salt on brakes affects braking. When the vehicle is driven on salted roads for extended periods, the brakes should be washed down thoroughly about every 2 weeks. An automatic carwash facility cannot do this job properly. Brakes will dry after a few cautious brake applications.

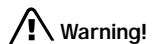

Warning!

Driving through water may reduce the traction.

Moisture on brakes from road water, car wash, or coating of road salt may affect braking efficiency.

- f Cautiously apply brakes to test brakes after being exposed.

Brake wear

Your car has excellent brakes, but they are still subject to wear. The rate at which they wear depends on how the brakes are used.

- f Have the brake system inspected at the intervals recommended in your Maintenance Booklet.

BRAKE Warning light USA

Warning light Canada

If the warning lights in the instrument panel and on-board computer stay on when the engine is running or come on while driving, the brake pads are worn, excessively.

- f Do not continue to operate the vehicle. Have your authorized Porsche dealer inspect or replace the brake pads.

Brake pads

Wear on the brake pads and brake discs depends to a great extent on the driving style and the conditions of use and therefore cannot be expressed in actual miles on the road.

The high-performance brake system is designed for optimal braking effect at all speeds and temperatures.

Certain speeds, braking forces and ambient conditions (such as temperature and humidity) therefore might cause "brake noises".

New brake pads or linings

New brake pads and brake discs have to be "broken in", and therefore only attain optimal friction when the car has covered several hundred miles or km.

The slightly reduced braking ability must be compensated for by pressing the brake pedal harder. This also applies whenever the brake pads and brake discs are replaced.

ABS Brake System (Antilock Brake System)

The ABS system represents a major contribution to the enhancement of active safety in your vehicle. This system prevents the wheels from locking in a panic stop on almost all road surfaces.

With the ABS system in your vehicle, the following areas are enhanced:

Steering, vehicle remains steerable under all braking forces when ABS is engaged.

Good directional control, no swerving caused by locking of wheels under braking conditions.

Shorter stopping distance, stopping distances are usually reduced because controlled braking is maximized.

Prevention of wheel lock up, no brake- induced sliding and thus no localized tire wear from emergency braking.

The crucial advantage of the ABS system over a conventional brake system is in the area of maintaining directional control and maneuverability of the car in emergency situations during normal driving, including panic braking in turns.

Warning!

The increased control that is provided should not induce you to take greater risks with your safety. The limits dictated by the laws of physics cannot be overcome, even with ABS. The risk of accidents due to inappropriate speed cannot be reduced, even by the ABS. The driver bears the responsibility for all driving maneuvers.

- f Adapt your driving style to the prevailing road and weather conditions.
- f Obey all traffic laws.

Other vehicles not equipped with the ABS system may not be able to maintain control, especially on wet or poor road surfaces and thus may be more likely to impact you from behind.

- f To minimize that risk, use your ABS system to increase your ability to maneuver to avoid dangerous situations and not merely to try to stop in the shortest distance possible.
-

Operation of the ABS system

A wheel speed sensor is mounted to each of the four wheels. If wheel lock-up of either of the front wheels or the rear wheels is sensed during braking, the brake pressure is adjusted automatically until the wheel no longer slips. The brake pressure is regulated for each front wheel individually and for both of the rear wheels together.

On a road surface which is slippery on only one side, the rear wheel which is braking on the slippery surface determines the brake pressure which will be applied equally to both rear wheels. This ensures that directional stability is maintained. However, if braking forces approach the wheel lock-up point for all wheels (panic braking) the ABS system will intervene to provide a rapid rhythmic braking. The proper operation of ABS is perceived by the driver as a pulsating brake pedal in conjunction with audible noise and perhaps some vibration.

- f If you experience these sensations while driving or a road surface with questionable traction, reduce vehicle speed appropriate for the prevailing road conditions.

The functional readiness of all the main electrical components of the ABS is checked by an electronic monitoring system both before and while you drive.

Warning light USA

Warning light Canada

When the ignition is switched on the ABS warning light will light up while the system is electronically interrogated and goes out when the engine is started if the check is not yet complete.

If the ABS warning lamp fails to go out, this indicates that ABS has been deactivated due to a fault. If the warning lights in the instrument panel and on-board computer light up while you are driving, this indicates that a fault has occurred. In both cases, normal braking, as in vehicles without ABS, is still retained.

The ABS system should, however, be examined at an authorized Porsche dealer immediately to prevent the occurrence of further faults.

- f If the ABS system becomes inoperative, take your vehicle to your authorized Porsche dealer immediately.

Warning!

The control unit of the ABS brake system is set for standard tire size. If non-standard tires are installed, the control unit may misinterpret the speed of the vehicle, because of the variant data it receives from the sensors on the axles.

- f Use only tire makes and types tested by Porsche.

Sport Mode

A sportier car set-up is obtained when Sport mode is switched on. Interventions by the Porsche control systems are intentionally shifted towards greater agility and driving performance.

- PASM (Porsche Active Suspension Management) is automatically changed to Sport mode, resulting in a stiffer suspension setup.
 - The Tiptronic S switches to a sporty gear-changing map and shortens the gear shifting periods. Gear changes take place faster.
 - PSM (Porsche Stability Management) control is sporty. PSM interventions take place later than in Normal mode. The driver can maneuver the vehicle with greater agility at its performance limits, without having to dispense with the assistance of PSM in emergency situations.
 - The electronic accelerator pedal reacts sooner, and the engine is more responsive to throttle inputs. When Sport mode is switched on, this function is activated only after the driver has floored the accelerator pedal or released it briefly.
 - The rpm limiter characteristic is "harder", i.e. the engine is immediately throttled when the performance limits are reached (only in manual selection mode for vehicles with Tiptronic S).
- f Please observe the appropriate chapters of this Manual.



Switching Sport mode on and off

- f Press SPORT button in the center console. When Sport mode is switched on, the light-emitting diode in the SPORT button is lit.



When Sport mode is switched on, the logo SPORT appears next to the digital speedometer.

Switching Sport mode on and off simultaneously activates and deactivates the Sport mode of the PASM.

If the Sport mode of the PASM was activated with the PASM button, it will remain on.

After the ignition is switched off, Sport mode is automatically reset to Normal mode.

Porsche Stability Management (PSM)

PSM is an active control system for stabilization of the vehicle during extreme driving manoeuvres. The most recent version of PSM (only on vehicles with four-wheel drive) improves the brake system functionality.



The increased control that is provided should not induce you to take greater risks with your safety. The limits dictated by the laws of physics cannot be overcome, even with PSM. The risk of accidents due to inappropriate speed cannot be reduced, even by PSM. The driver bears the responsibility for all driving maneuvers.

- f Adapt your driving style to the prevailing road and weather conditions.
- f Obey all traffic laws.

Advantages of PSM

- Superior traction and lane-holding ability in all driving situations – even on road surfaces with varying friction.
- PSM actively stabilizes the vehicle during dynamic driving maneuvers (e.g. rapid steering movements, during lane changes or on alternating curves).

- Improved braking stability in curves and on different or varying road surfaces.
- It improves the braking functions and shortens the stopping distance if emergency braking is needed (only vehicles with four-wheel drive).

Readiness for operation

PSM is switched on automatically every time you start the engine.

Function

Sensors at the wheels, brakes, steering system and engine continuously measure:

- Speed
- Steering angle
- Lateral acceleration
- Rate of turn about the vertical axis
- Brake pressure

PSM uses these values to determine the direction of travel desired by the driver.

PSM intervenes and corrects the course if the actual direction of motion deviates from the desired course (steering-wheel position): It brakes individual wheels as needed. In addition, the engine power may be manipulated in order to stabilize the vehicle.

The events below inform the driver of PSM control operations and warn him to adapt his driving style to the road conditions:

- The multi-functional information light on the instrument panel lights up.
- Hydraulic noises can be heard.
- The vehicle decelerates and steering-wheel forces are altered as the PSM controls the brakes.
- Reduced engine power.
- The brake pedal pulsates and its position is changed during braking. In order to achieve full vehicle deceleration, foot pressure must be increased after beginning of the brake pedal pulsing.

Examples of PSM control operations

- If the front wheels of the vehicle drift on a bend, the rear wheel on the inside of the bend is braked and the engine power is reduced if necessary.
- If the rear of the vehicle swings out on a bend, the front wheel on the outside of the bend is braked.

Additional functions for vehicles with four-wheel drive

- Pre-filling the brake system:
If you suddenly and quickly take your foot off the accelerator pedal, the brake system gets prepared for possible emergency braking. The brake system is pre-filled which lightly presses the brake pads on the brake discs.

Brake boost:

If emergency braking does not have sufficient pedal pressure, the brake boost produces the brake pressure necessary for maximum deceleration on all 4 wheels.

The PSM should always be switched on during "normal" driving.

However, it may be advantageous to switch off PSM temporarily in exceptional situations, for example:

- On a loose surface or in deep snow,
- When "rocking the vehicle free" and
- When using snow chains.



Switching off PSM

- f Press PSM OFF button.
PSM is switched off after a short delay.
The light-emitting diode in the button is illuminated.
When the PSM is switched off, the multifunctional PSM light on the instrument panel is lit **and** a message is shown by the on-board computer. An acoustic signal also sounds.

Vehicles with four-wheel drive

When PSM is switched off, the additional braking functions are deactivated. The automatic reactivation in emergency situations is coupled to the PSM control in emergency situations.

The following functions stabilize the vehicle in emergency situations, even with PSM switched off:

- When PSM is off, the vehicle is stabilized as soon as one of the two front wheels enters the ABS control range.
- When PSM is off and Sport mode is on, the vehicle is stabilized as soon as both front wheels enter the ABS control range.

One-sided spinning of the wheels is prevented, even with PSM switched off.

Switching PSM back on

- f Press PSM OFF button.
PSM is switched on after a short delay.
The light-emitting diode in the button and the multifunctional PSM light go out.
The on-board computer shows a message.

Sport mode

A sportier car set-up is obtained when Sport mode is switched on. PSM interventions are later than in Normal mode; the vehicle can be manoeuvred with greater agility at its performance limits, without the need to dispense with the assistance of PSM in emergency situations. This helps to achieve optimal lap times, particularly on race circuits and a dry road surface.



Multifunctional PSM light

- The multifunctional light on the instrument panel lights up for a lamp check when the ignition is switched on.
 - The light indicates a control operation by flashing, including when PSM is switched off (brake control in the event of one-sided wheel spin).
 - In conjunction with a message on the on-board computer, the light indicates that PSM is switched off.
An acoustic signal also sounds.
 - Faults are displayed by the light in conjunction with a message on the on-board computer.
PSM is out of order.
- f Please consult an authorized Porsche dealer.
 - f Please observe the chapter “PUTTING VEHICLE INTO OPERATION” on Page 261.
 - f Please observe the chapter “WARNINGS ON THE INSTRUMENT PANEL AND THE ON-BOARD COMPUTER” on Page 122.

Towing

- f Please observe the chapter “VEHICLE TOWING” on Page 281.

Checks on test stands

Brake tests

Brake tests must be performed only on plate-type test stands or roller test stands.

The following limit values must not be exceeded on roller test stands:

- Testing speed 5 mph (8 km/h)
- Test duration 20 seconds

Handbrake tests

Handbrake tests on the roller test stand must be performed only with the ignition switched off.



Porsche Active Suspension Management (PASM)

PASM makes two running-gear setups available to the driver: "Normal" and "Sport". The selection is made via a button on the center console.

In Normal mode the running gear is in a sporty and comfortable setup.

Sport mode offers a markedly sporty shock absorber tuning (e.g. for driving on the race circuit).

The variable suspension system selects the appropriate damping level for each wheel according to the situation and conditions of driving.

Example:

If the vehicle is driven in a markedly sporty manner in Normal mode, PASM automatically adapts the shock-absorber behavior to the driving situation in this case as well.



Switching on PASM Sport mode

- Press PASM button in the center console. When PASM Sport mode is switched on, the light-emitting diode in the button is illuminated **and** a message is shown by the on-board computer.

Switching off PASM Sport mode

- Press PASM button in the center console. The light-emitting diode in the button goes out **and** the on-board computer displays a message.

After the ignition is switched off, PASM is automatically reset to Normal mode.

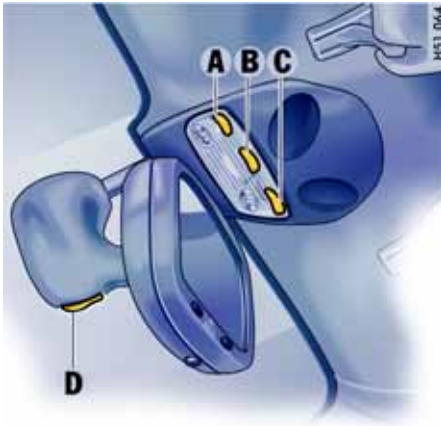

A, C - Switch for reading light on driver/passenger side
 B - Switch for interior light and footwell lights
 D - Orientation light

Interior lights, reading lights

Switching off

- f Press left half of switch.

Switching to continuous illumination

- f Press right half of switch.

Switching on and off automatically

- f Move switch to center position.

The interior and footwell lights are **switched on** when a door is unlocked or opened or when the ignition key is withdrawn from the ignition lock.

The lights are **switched off** with a delay of approx. 2 minutes after the doors are closed. The light goes out immediately as soon as the ignition is switched on or the vehicle is locked.

Orientation light

A light-emitting diode at the bottom of the interior mirror improves orientation in the passenger compartment when it is dark.

Note on operation

On vehicles with the Sport Chrono package, the brightness of the orientation light can be changed in PCM.

- f Please observe the chapter "Individual Memory" in the separate PCM operating instructions.

Interior Lights

- f Please observe the chapter "LOAD SWITCH-OFF AFTER 2 HOURS OR 7 DAYS" on Page 255.

For vehicles with automatic anti-dazzle mirrors

- f Switch off the automatic anti-dazzle operation of the mirrors before you switch on the interior light. Otherwise the mirrors may accidentally swivel into the anti-dazzle position.

Operation, Instruments

1. Ignition lock/steering lock
2. Turn signals/high beam/headlight flasher stalk
3. Hands-free microphone for telephone
4. Horn
5. Wiper/washer stalk, rear window wiper
6. Button for seat heating, left
7. Interior temperature sensor/GPS antenna
8. Stopwatch
9. Emergency flasher switch
10. Central locking button, readiness display for alarm system
11. Porsche Communication Management (PCM)
12. Button for seat heating, right
13. Cupholder
14. Light switch
15. Operating lever for on-board computer
16. Locking lever for steering-wheel adjustment
17. Operating lever for automatic speed control
18. Operating panel for air conditioning
19. Buttons for rear spoiler, Porsche Active Suspension Management (PASM), Sport mode, Porsche Stability Management (PSM)

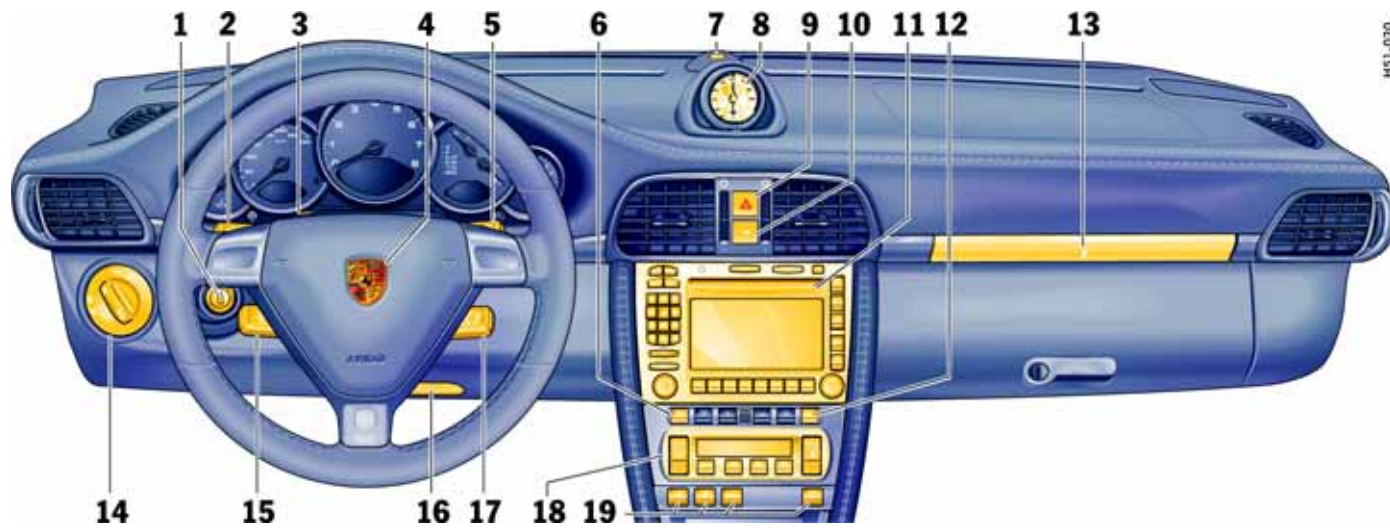



Ignition/Starter Switch with anti-theft Steering Lock

The ignition lock has a total of four ignition lock positions.

The ignition key rebounds to the initial position from every ignition lock position.

f For your safety, fasten safety belts.

- f Please observe the chapter "IMMOBILIZER" on Page 19.
- f Please observe the chapter "KEY WITH RADIO REMOTE CONTROL" on Page 20.

Before starting the engine

- f Apply the footbrake.
- f **Manual transmission:**
Move the gearshift lever into neutral.
The clutch pedal must be depressed fully before the starter will engage.
- f **Tiptronic:**
Move the selector lever to **P** or **N**.

Switch position 0

Initial position

The ignition key cannot be withdrawn when the ignition is switched on or when the engine has been started.

To withdraw the ignition key:

- f Stop the vehicle.
- f **On vehicles with Tiptronic S:**
Move selector lever to position **P**.
- f Switch ignition off.
- f Remove ignition key.

Switch position 1

Ignition on

- f Turn ignition key to position 1.
Ignition is switched on.

Note on operation

All electrical equipment can be switched on.

- f Please observe the chapter "WARNINGS ON THE INSTRUMENT PANEL AND THE ON-BOARD COMPUTER" on Page 122.

Switch position 2

Start engine

- f Turn ignition key to ignition lock position 2.
- f Please observe the chapter "STARTING PROCEDURES" on Page 82.

Switch position 3

Ignition off

- f Turn ignition key to ignition lock position 3.

Locking the steering column

Automatic locking

The steering column is automatically locked when the ignition key is withdrawn from the ignition lock.

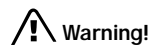

**Risk of an accident.
The steering wheel will lock and will cause loss of steering.**

- f Never remove key from the ignition lock or turn the key off while the vehicle is moving.
- f **Always withdraw the ignition key** when leaving the vehicle.

Automatic unlocking

The steering column is automatically unlocked when the ignition key is inserted into the ignition lock.

Note

- f To avoid battery run-down, always remove the ignition key from the ignition lock. Please observe the chapter "BATTERY" on Page 258.

Gong

If you leave the key in the ignition/steering lock, a gong will sound when the driver's door is opened. This is a reminder to remove the key.

Starting Procedures

- f Please observe the chapter "IMMOBILIZER" on Page 19.
- f Please observe the chapter "EMISSION CONTROL SYSTEM" on Page 211.



Warning!

Serious injury may result if you are involved in a collision without having fastened the safety belts.

- f Fasten safety belts before driving away.

Before starting the engine

- f Apply the footbrake.
- f **Manual transmission:**
Move the gearshift lever into neutral.
The clutch pedal must be depressed fully before the starter will engage.
- f **Tiptronic:**
Move the selector lever to **P** or **N**.

Temperature sensors on the engine automatically provide the correct fuel/air mixture required for starting.

Therefore, it is **not necessary to depress the accelerator pedal** while starting a cold or a warm engine.

Starting the engine

- f Turn ignition key to ignition lock position **2**.
- f As soon as the engine starts, release the ignition key.

The first operation of the starter is ended automatically when the engine starts.

If the engine does not start, subsequent starter operations will not be ended automatically.

If the engine fails to start after 10 or 15 seconds of cranking:

- f Wait about 10 seconds before engaging the starter again.
- f When starting the engine, be ready to drive immediately.
Drive vehicle at moderate speeds and avoid engine speeds above 4,200 rpm during the first 5 minutes.
- f Do not let the engine idle to warm up.



Danger!

Engine exhaust fumes have many components which you can smell. They also contain carbon monoxide (CO), which is a colorless and odorless gas.

Carbon monoxide can cause unconsciousness and even death if inhaled.

- f Never start or let the engine run in an enclosed, unventilated area.
It is not recommended to sit in your car for prolonged periods with the engine on and the car not moving.

An unattended vehicle with a running engine is potentially hazardous.

If warning lights should come on to indicate improper operation, they would go unnoticed.

- f Never leave the engine idling unattended.

Danger of fire.

- f Do not park or operate the vehicle in areas where the hot exhaust system may come in contact with dry grass, brush, fuel spill or other flammable material.
- f If your car catches on fire for any reason, call the fire department.
Do not endanger your life by attempting to put out the fire.

Stopping Engine

- f Turn key back to position 3.
- f Do not stop engine immediately after hard or extended driving.
Keep engine running at increased idle for about two minutes to prevent excessive heat build-up before turning off engine.
- f To avoid battery run-down, always remove the ignition key from the ignition lock.
- f Make sure that when you leave the car, even briefly, you have withdrawn the ignition key.
- f Engage the steering lock by moving the steering wheel to the left or right.
Turn the steering wheel to the locking position before you switch off the engine so that you don't have to exert yourself when locking or unlocking the steering.



Danger of injury. Hot engine compartment components can burn skin on contact.

- f Before working on any part in the engine compartment, turn the engine off and let it cool down sufficiently.

Engine-compartment blower, radiator fan

The radiator and radiator fans are in the front of the car.

The engine-compartment blower is mounted on the engine compartment lid.



Risk of injury.

After the engine is switched off, the engine-compartment temperature is monitored for approx. 30 minutes.

During this period, and depending on temperature, the engine-compartment blower may continue to run or start to run.

- f Carry out work in these areas only with the engine off, the ignition off, and exercise extreme caution.

Risk of injury. The radiator fans in the front end of the car may be operating or unexpectedly start operating when the engine is switched on.

- f Carry out work in these areas only with the engine switched off.

Automatic garage door

The ignition system in your Porsche may interfere with your electronically operated garage door.

- f To check this, drive your Porsche close to the garage door. Make sure not to interfere with the operating range of the door.
- f Run the engine at different speeds.

If the garage door opens or closes without you operating the garage door unit in your car, contact the dealer who installed the automatic garage door to have the frequency and/or coding of the garage door signal changed or modified.

Instrument Panel USA Models

Also refer to the corresponding chapters in the Owner's Manual.

1. Engine oil temperature gauge
2. Speedometer with analogue display
3. Tire pressure warning light
4. Turn signal indicator light, left
5. Tachometer
6. High beam indicator light
7. Turn signal indicator light, right
8. ABS warning light
9. Cooling system
Temperature gauge, warning light
10. Fuel
Level gauge, warning light
11. Engine oil pressure gauge
12. Adjustment button for instrument illumination and trip counter
13. Odometer and daily trip mileage display
14. Automatic speed control indicator light
15. Light sensor for instrument illumination
16. Airbag warning light
17. Emission control warning light (Check Engine)
18. Central warning light
19. On-board computer display
20. Porsche Stability Management Multifunctional PSM light
21. Brake warning light
22. Safety belt warning light
23. Tiptronic indicator
24. Clock and outside temperature display
25. Adjustment button for clock

When the ignition is switched on, the warning lights light up for a lamp check.

Note

Warnings that have been given are stored in the appropriate control unit memory and can be read out at an authorized Porsche dealer.

This information can help to warn you about situations which may be hazardous to you or your car.



100-134

Instrument Panel Canada Models

Also refer to the corresponding chapters in the Owner's Manual.

1. Engine oil temperature gauge
2. Speedometer with analogue display
3. Tire pressure warning light
4. Turn signal indicator light, left
5. Tachometer
6. High beam indicator light
7. Turn signal indicator light, right
8. ABS warning light
9. Cooling system
Temperature gauge, warning light
10. Fuel
Level gauge, warning light
11. Engine oil pressure gauge
12. Adjustment button for instrument illumination and trip counter
13. Odometer and daily trip mileage display
14. Automatic speed control indicator light
15. Light sensor for instrument illumination
16. Airbag warning light
17. Emission control warning light (Check Engine)
18. Central warning light
19. On-board computer display
20. Porsche Stability Management Multifunctional PSM light
21. Brake warning light
22. Safety belt warning light
23. Tiptronic indicator
24. Clock and outside temperature display
25. Adjustment button for clock

When the ignition is switched on, the warning lights light up for a lamp check.

Note

Warnings that have been given are stored in the appropriate control unit memory and can be read out at an authorized Porsche dealer.

This information can help to warn you about situations which may be hazardous to you or your car.



1451-001

H53-011



Engine oil temperature

The engine oil temperature is indicated in the left instrument.

H53-009



A - Adjustment button for instrument illumination and trip counter



Automatic Speed Control Indicator light

Indicates automatic speed control readiness.

Instrument Illumination

The illumination is automatically adjusted to the ambient brightness by the light sensor in the tachometer.

In addition, when the car lights are switched on, the instrument and switch symbol brightness can be manually adjusted.

Warning!

Risk of an accident, personal injury and loss of control.

- f Do not reach through the steering-wheel spokes while driving.

Note

When the car lights are switched on, the instrument lighting for light dials switches on and off automatically depending on the ambient brightness.



Dimming instrument illumination

- f Turn adjustment button **A** in the appropriate direction and hold it until the desired brightness has been reached.
The chosen level of brightness is indicated by a bar display in the display field of the on-board computer.

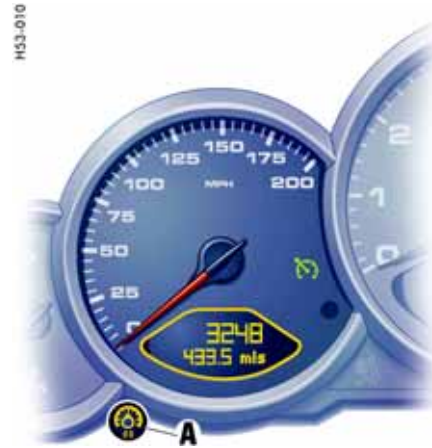

Trip Odometer

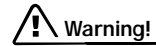

Warning!

Risk of an accident, personal injury and loss of control.

- f Do not reach through the steering-wheel spokes while driving.

Resetting to zero

- f Press adjustment button **A** for approximately one second **or**
- f Reset the distance in the "SET" menu of the on-board computer.
Please observe the chapter "SET BASIC SETTING ON ON-BOARD COMPUTER" on Page 120.

After exceeding 6,213 miles or 9,999 kilometers, the counter returns to "0".



Speedometer

The digital speedometer is integrated in the on-board computer.
The indication changes from mph to km/h when the units are changed from miles to kilometers.

Changing over between Miles / Kilometers

The units of the distance and speed displays can be changed in the "SET" menu of the on-board computer.

- f Please observe the chapter "SET BASIC SETTING ON ON-BOARD COMPUTER" on Page 120.



Tachometer

The tachometer shows the engine speed in revolutions per minute (rpm).

The beginning of the red marks at the right end of the scale indicates the maximum permissible engine rpm.

A speed limiter prevents the engine from being overrevved during acceleration. Before reaching this area, the next **higher** gear should be selected.

Shift to the next **lower** gear when the engine rpm drops below 1,500 rpm.

Caution!

To avoid severe engine damage.

- f Always observe the engine rpm before downshifting to a lower gear, so you do not exceed the maximum engine rpm.

Turn Signal Indicator Light

Flashes in synchronism with the turn signals.

Left arrow – left turn signals
Right arrow – right turn signals

- f If the frequency of the display becomes noticeably faster, check the operation of the turn signals.

High Beam

Indicator light

Lights when high beam or headlight flasher is switched on.

The indicator light goes out when the high beams are switched off.



Cooling System

Temperature gauge (ignition on)

USA: Display in °F
Canada: Display in °C

Pointer to the left – engine cold

- f Avoid high engine speeds and heavy engine loading.

Pointer in the middle – normal operating temperature

The pointer may move up to the red area when engine is heavily loaded and outside temperature is high, but should return to “normal” when engine load is reduced.

Warning light “A”

If the **coolant temperature** is too high, the warning light **comes on**. Additionally, a warning is displayed in the on-board computer.

- f Pull off the road, turn off the engine and allow to cool.
- f Check radiator and air passages in front end of car for obstructions.
- f Check coolant level.
If necessary, add coolant and have fault remedied at an authorized Porsche dealer.
Please observe the chapter “COOLANT LEVEL” on Page 199.

Note

To prevent excessive temperatures, the cooling-air passages must not be restricted by coverings (e.g. films, “stone guards”).

If the **coolant level** is too low, the warning light **flashes**.

Additionally, a warning is displayed in the on-board computer.

- f Switch engine off and allow to cool.
- f Add coolant.
- f Have the cause of the fault remedied at an authorized Porsche dealer.
Please observe the chapter “COOLANT LEVEL” on Page 199.

Caution!

Risk of engine damage.

- f If the warning lights come on even though coolant level is correct, do not continue driving.
- f Have the fault remedied at the nearest authorized Porsche dealer.

Engine compartment blower fan

In addition, this warning light **flashes** to indicate a fault in the **engine compartment blower fan**.

- f Have the cause of the fault remedied at an authorized Porsche dealer.

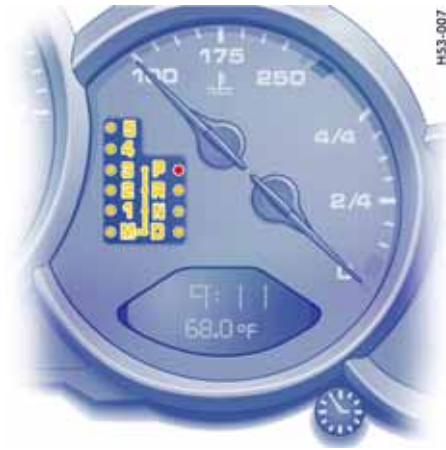

Tiptronic

Indicator for selector lever position and engaged gear

When the engine is running, the selector lever position and engaged gear are indicated.

If the selector lever is between two positions:

- The corresponding selector lever position in the instrument cluster flashes **and**
 - The warning "Selector lever not engaged" appears on the display of the on-board computer.
- f Engage the selector lever correctly.

If there is a fault in the transmission:

- The **4th gear** display flashes.
 - The warning "Tiptronic emergency run" appears on the on-board computer.
- f Please observe the chapter "REDUCED DRIVING PROGRAM" on Page 170.
- f Have the fault repaired immediately at an authorized Porsche dealer.
- f Please observe the chapter "TIPTRONIC S" on Page 165.



Fuel

Level gauge

When the ignition is on the fuel level is displayed.

- f Please observe the chapter "CAPACITIES" on Page 291.

If the vehicle's inclination changes (e.g. going up or downhill), minor deviations in the indication may occur.

Note

If the tank is near empty and you top up with only a small quantity of fuel, this cannot be registered by the level gauge and calculation of the range remaining is impossible.

Warning light "A"

When the engine is running, the warning light of the level gauge lights up if less than approx. 2.6 U.S. gallons (10 liters) of fuel remains in the tank or the range on remaining fuel falls below approx. 30 miles (50 km). Additionally, a warning is displayed in the on-board computer.

- f Fill up at the next opportunity.

Caution!

To prevent damage to the emission control system and engine.

- f Never drive the tank completely out of fuel.
 - f Avoid high cornering speeds after the warning lights have come on.
-
- f Please observe the chapter "EMISSION CONTROL SYSTEM" on Page 211.

If the level gauge warning light flashes, there has been a system fault.

Additionally, a warning is displayed in the on-board computer.

There will then be no reserve warning.

- f To remedy the fault, go to an authorized Porsche dealer.



A - Adjustment button for clock
 B - Clock
 C - Outside temperature display

Clock

The **clock** is blanked out approximately four minutes after the ignition is switched off or when the car is locked.

Setting the time

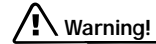

Warning!

Risk of an accident and loss of control.

- f Do not reach through the steering-wheel spokes while driving.

Setting hours

- f Press adjustment button **A** for about one second. Hour display flashes.
- f Turn button in the appropriate direction:
 - to right – increase hours figure
 - to left – decrease hours figure.

Adjustment in hours – turn button briefly
 Fast adjustment (display cycles) – turn and hold button.

Setting minutes

- f Press adjustment button again. Minutes display flashes.
- f Set by rotating as in hours mode.

Leaving adjustment mode

Automatically after one minute **or**:

- f Press adjustment button again.

When adjustment mode is deliberately left by pressing the button, the time begins precisely to the second.

Note

The time mode can be changed between 12h and 24h in the on-board computer.

Outside temperature

The outside temperature display **C** does not indicate, if ice is on the road.

Even if a temperature above 32°F (0°C) is displayed, ice may still form on the road, for instance on bridges or when the road passes through a heavily shaded area.



Engine Oil Pressure

With the engine warmed up and running at a speed of 5000 rpm, the engine oil pressure should be approx. 3.5 bar.

H53-008

If oil pressure drops abruptly and a message is displayed on the on-board computer when the engine is running on or when driving:

- f Stop immediately in a suitable place.
- f Switch off the engine.
- f Check oil level.
Please observe the chapter "OIL DISPLAY AND MEASUREMENT OF THE ENGINE OIL LEVEL" on Page 118.
Please observe the chapter "ENGINE OIL LEVEL" on Page 201.
- f Add engine oil if necessary.

Caution!

Risk of engine damage.

- f Do not continue driving if there is an obvious oil leak.
 - f Do not continue driving if the warning lights come on even though oil level is correct.
 - f Have the fault remedied at the nearest authorized Porsche dealer.
-

Battery

If the battery voltage drops abruptly, a warning message will be displayed by the on-board computer.

If the warning is displayed by the on-board computer while the engine is running or while driving:

- f Stop the car in a safe place and stop the engine.

Possible causes

- Defect in the battery charging system.
- Broken drive belt.

Warning!

Risk of an accident and risk of engine damage.

A broken drive belt means there is no power assistance to the steering (more effort is required to steer) and coolant pump function will stop.

- f Do not continue driving.
 - f Have the fault remedied at the nearest authorized Porsche dealer.
-



Check Engine Warning Light

The warning light in the instrument panel comes on when the ignition is first turned on and remains on briefly as a bulb check. If the light does not come on, have the bulb replaced promptly.

If the warning lights in the instrument panel and on-board computer come on and remain on while driving, it suggests:

- a potential engine control problem and the need for system service **or**
- an improperly fastened tank cap **or**
- refuelling with engine running.

Although the vehicle is usually driveable and will not require towing, see your dealer for service as soon as possible.

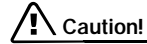

Caution!

If the Check engine light in the instrument panel is flashing, severe catalytic converter damage and power loss will soon occur. Prolonged driving with the Check engine light on could cause damage to the emission control system. It also could affect fuel economy and driveability.

- f Have the fault remedied at the nearest authorized Porsche dealer immediately.



Central warning light

The central warning light on the instrument panel lights up if there are warning messages in the INFO menu.

The messages can be called in the on-board computer INFO menu:

- f Please observe the chapter "INFO WARNING MESSAGES" on Page 102.



Brake warning light USA



Brake warning light Canada

The warning light on the instrument panel lights up:

- if the handbrake is on,
- if the brake fluid level is low,
- if the brake pads have reached the wear limit,
- if the brake circuit division is defective.

Additionally, a warning is displayed by the on-board computer.

- f Please observe the chapter "WARNINGS ON THE INSTRUMENT PANEL AND THE ON-BOARD COMPUTER" on Page 122.



H52-003



H51-023

On-Board Computer (BC)

Display field

The display field is beneath the tachometer.

Readiness for operation

- With ignition switched on,
- with engine running.

Operation, controls

It is not possible to describe all details of the on-board computer functions in this Owner's Manual. However, the examples will quickly familiarize you with the operational principle and help you to navigate through the menu structure.

You can restore the factory default settings at any time by using the "SET" menu.

Operating lever

The on-board computer is operated with the lower left lever on the steering column.

Selecting functions of the on-board computer

- f Push lever up **3** or down **4**.

Confirming selection (Enter)

- f Push the lever forward **1**.

Moving back one or several selection levels

- f Pull the lever back **2** once or several times **or**
- f  Select the arrow on the on-board computer display with the operating lever and push the operating lever forward **1**.

Note

You can always return to the basic menu by pulling the operating lever several times.

Functions and display possibilities

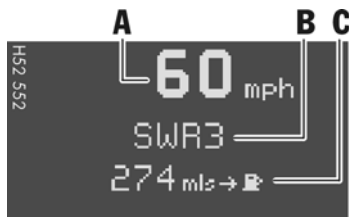

- A - Digital speedometer
- B - Central display
- C - Bottom display

Note

The available items and displays in the on-board computer depend on the equipment of your vehicle. For this reason it is possible that some of the items and displays shown here are not available in your on-board computer.

Basic setting

- Central display: Radio station

The central line **B** of the on-board computer can be selected in the SET menu.

Calling on-board computer functions in display "C"

- f Push operating lever up or down (selection field **D** must be switched off).

The following displays can be called step by step:

- Average speed (Ø mph),
- Average consumption (Ø mpg),
- Range on remaining fuel (mi → 🚗),
- Tire pressure
- Navigation information (if activated in the SET menu).

Note

The values "Average speed", "Average consumption" and "Daily trip mileage" can be reset to zero in the SET menu.

Switching selection field "D" on or off

- f Push operating lever forward or back.

Arrow symbol "E" for continuation

Arrow symbol: ↕

- f Push operating lever down in order to page through the menu.

Arrow symbol: ⬆️

- f Push operating lever up in order to page through the menu.

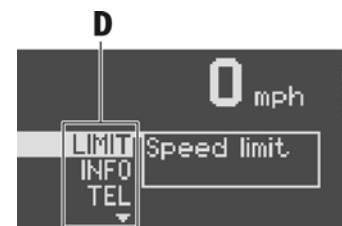

- D - Selection field
- E - Continuation arrow symbols

LIMIT Acoustic warning signal for speed limit

The acoustic warning signal can be activated for speeds above 6 mph (10 km/h).

The signal sounds when the preset speed is exceeded.

For the signal to sound again, the driving speed must fall below the preset speed by at least 3 mph (5 km/h).

Switching on selection field "D"

f Push operating lever forward.

Setting the speed

f Select LIMIT with the operating lever.



f Push operating lever forward.

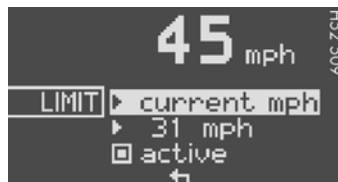

Option 1: Accepting current speed

f Push operating lever forward.

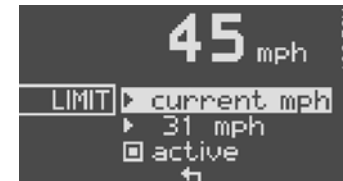

The acoustic warning signal is activated for the current speed.

Display:

**Option 2:
Presetting speed**

f Select "LIMIT active" with the operating lever:

- not active
- active

f If "not active", push the operating lever forward.

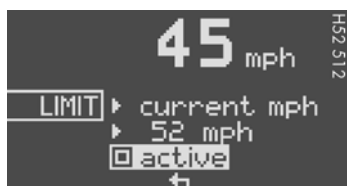

f Select "xx mph" with the operating lever.

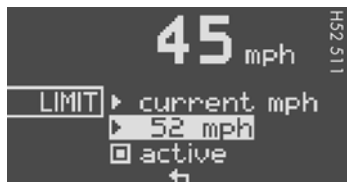

f Push operating lever forward.

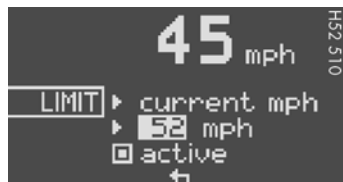

f Push operating lever slightly up or down until the desired speed is reached.

upwards: speed is increased
downwards: speed is decreased

Note:

Holding the lever pressed up or down for a longer period will adjust the speed in steps of 6 mph (10 km/h).

f Push operating lever forward.

Switching the acoustic warning signal off

f Select "LIMIT active" with the operating lever.

f Push operating lever forward.

Display:

INFO Warning messages

Switching on selection field "D"

f Push operating lever forward.

Calling warning messages

f Select INFO with the operating lever.



f Push operating lever forward.

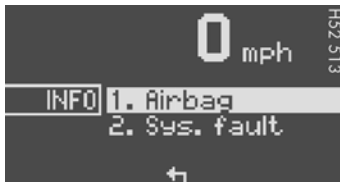

Any existing warning messages can be called using the operating lever.

You also can call warning messages which were cancelled during the journey (but only until the next time the ignition is switched on).

f Push operating lever forward.



f Push operating lever forwards or pull backwards.

The display returns to the Info menu.

TEL
Telephone information

Switching on selection field "D"

f Push operating lever forward.

Recalling telephone information

f Select TEL with the operating lever.



f Push operating lever forward.

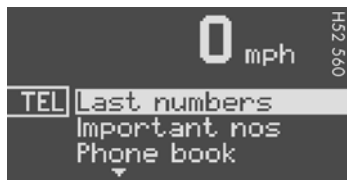

Note

You can recall phone calls, e.g. calls that arrived during your absence, via the menu item "Missed calls".

Example:

Selecting from the telephone book and calling

f Select "Phone book" with the operating lever.

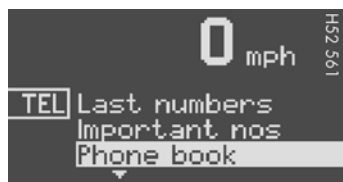

f Push operating lever forward.

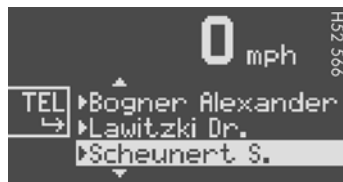

f Select a person to call and push the operating lever forward.
 The connection is established.

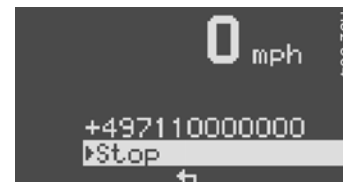

f Push the operating lever forward to end the call.

Incoming call

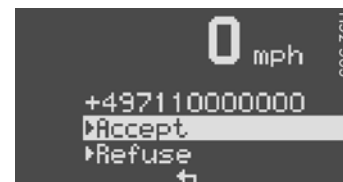

f Select "Accept" or "Refuse" and push the operating lever forward.

Note

Rejected phone calls can be recalled with the menu item "Missed calls".



CHRONO Stopwatch

You can use the stopwatch to measure time intervals, e.g. on the race circuit or on work-related journeys. Measured lap times can be stored and evaluated if the vehicle is equipped with Porsche Communication Management (PCM).

f Please observe the chapter "Sport display" in the separate PCM operating instructions.

Stopwatch on the instrument panel

The stopwatch has an analogue and a digital display.

The large pointer of the analogue display measures the seconds. The two small pointers measure hours and minutes. The display re-starts at zero after 12 hours.

Seconds and increments of 1/100th of a second can be read on the digital display.

The digital display and the display in the on-board computer can indicate up to 99 hours and 59 minutes.

The stopwatch can be swivelled both to the left and to the right.

Stopwatch displays:

- on the stopwatch on the instrument panel,
- in the on-board computer menu CHRONO,
- on the performance display in the PCM.

Starting/stopping stopwatch

All stopwatch displays are started and stopped via the on-board computer menu CHRONO.

Note on operation

When you leave the CHRONO menu while the stopwatch is running, measurement will continue.

The stopwatch stops after the ignition is switched off. If the ignition is switched on again within approx. 4 minutes, the stopwatch will continue to run.

The only way to reset the stopwatch to zero is by selecting "Reset" in the CHRONO menu.

Starting the timing

- f Push operating lever forward.
The selection field is switched on.



- f Select CHRONO with the operating lever.
- f Push operating lever forward.

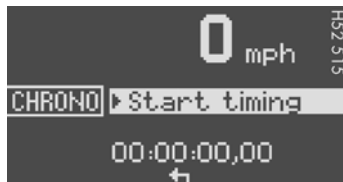

- f Push operating lever forward.
The time runs on all stopwatch displays.
The on-board computer display changes to the "Stop timing/Intermediate time" selection.

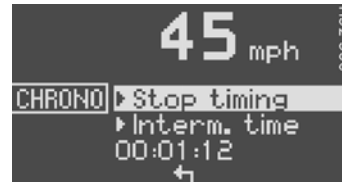

PCM information

The performance display in the "Trip/Sport display/Begin trip" menu must be selected in order to analyse the data in the PCM.

Stopping the timing

After time measurement is started, the on-board computer display changes to the "Stop timing/Intermediate time".

- f Select "Stop timing" with the operating lever.

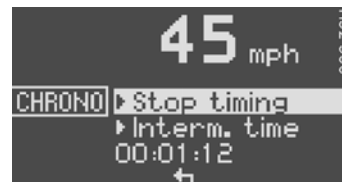

- f Push lever forward.
The time is stopped in all stopwatch displays,
and the on-board computer display changes to the "Continue/Reset" selection.



The timing can be continued or reset to zero.

PCM information

After timing has been stopped, a prompt asking whether the time is to be stored appears on the PCM.

Continue timing

After timing has been stopped, the on-board computer display changes to the "Continue/Reset" selection.

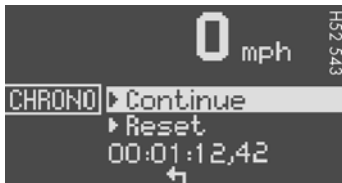

- f Push operating lever forward.
The stopwatch displays continue the timing.

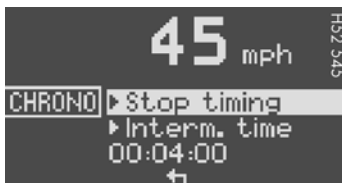

The on-board computer display returns to the "Stop timing/Intermediate time" selection. You can stop the stopwatch or measure an intermediate time.

Resetting the time

After timing has been stopped, the on-board computer display changes to the "Continue/Reset" selection.

- f Select "Reset" with the operating lever.



- f Push operating lever forward.
The display returns to the "Start timing" selection.
The stopwatch displays in the instrument panel and the on-board computer are reset to zero.

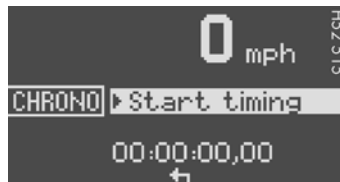

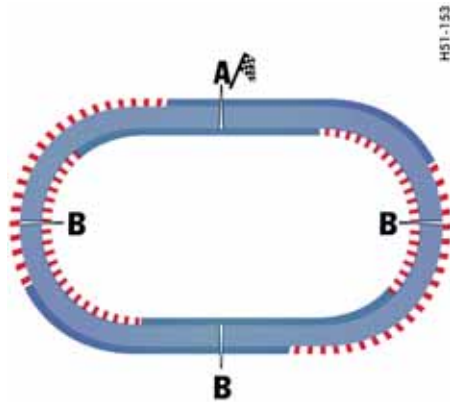

A - Lap
B - Intermediate time

Displaying intermediate times

Several intermediate times can be displayed for a route or for a lap on the race circuit. The intermediate times **B** are for your information. Measured lap times **A** can be stored and evaluated if the vehicle is equipped with Porsche Communication Management (PCM).

H51-153

To display an intermediate time:

After timing has been started, the on-board computer display changes to the "Stop timing/Intermediate time" selection.

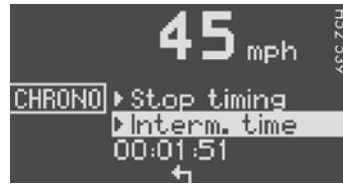

H52-539

- f Select "Intermediate time" with the operating lever and push the operating lever forwards.

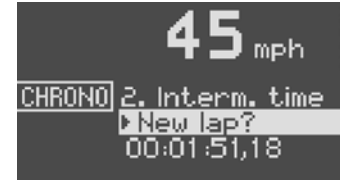

H52-516

The intermediate time will be displayed for approx. 5 seconds. The on-board computer display then returns to the "Stop timing/Intermediate time" selection.

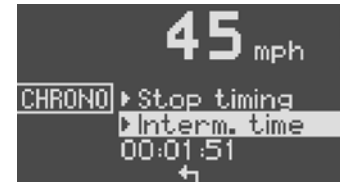

H52-539

- f You can stop the stopwatch or measure another intermediate time.

In order to start timing a new lap:

The "New lap?" selection appears for 5 seconds after selection of "Intermediate time".



- f Select "New lap?" with the operating lever and push the operating lever forwards.



The new lap is displayed on the on-board computer and the PCM. Timing on the on-board computer and on the PCM begins from zero. The stopwatch in the instrument panel continues to show the total time.

- f The on-board computer display returns to the "Stop timing/Intermediate time" selection after a short period.

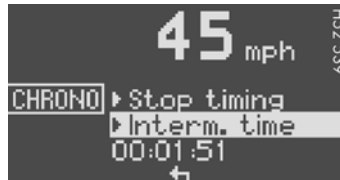

- f You can stop the stopwatch or measure another intermediate time or a new lap.

PCM information

If you wish to store the lap time in the PCM, the performance display in the "Trip/Sport display/Begin trip" menu of the PCM must be selected.

TPC Tire pressure monitoring

Please observe the chapter "TIRE PRESSURES" on Page 232.

The tire pressure monitoring continuously monitors tire pressure and tire temperature on all four wheels and warns the driver when the tire pressure is too low.

The display as well as the settings for the tire pressure monitoring take place on the on-board computer.

However, you must still adjust the tire pressure on the wheel.

- f The driver is responsible for filling the tires correctly and making the correct settings on the on-board computer.

The tire pressure monitoring offers the following functions:

- Display of the actual tire pressure while the vehicle is in motion
- Display of the deviation from the required pressure (refilling pressure)
- Display of currently set tire size and type
- Tire pressure warnings in two stages

Safety notes!

Despite the advantages offered by the tire pressure monitoring, it is still the driver's responsibility to update the corresponding settings in the on-board computer and maintain the pressure in the tires. Low tire pressure reduces the road safety of the vehicle and destroys the tire and wheel.

- f When a flat tire has been displayed, immediately stop in a suitable place and check the tires for damage. If necessary, remedy the damage with a tire sealant.
- f Do not by any means continue to drive with damaged tires.
- f Sealing the tire with tire sealant is only an emergency repair, so you can drive to the next authorized Porsche dealer. The maximum permitted speed is **50 mph (80 km/h)**.
- f Do not drive with tires whose tire pressure drops again in a short period of time. In cases of doubt, have tires checked by an authorized Porsche dealer.
- f Damaged tires must be immediately replaced by an authorized Porsche dealer.
Tire repairs are not permissible under any circumstances.

- f If the tire pressure monitoring is defective (e.g. defective wheel transmitter), contact an authorized Porsche dealer immediately and have the damage repaired.
The tire pressure will not be monitored by a defective tire pressure monitoring.
- f Tires lose air over time without a tire defect being present. A tire pressure warning will then appear in the on-board computer display. Correct the tire pressure at the next opportunity.
- f The tire pressure monitoring gives a warning about tire damage due to natural pressure loss as well as about a gradual loss of pressure due to foreign objects.
The tire pressure monitoring cannot warn you about tire damage that occurs suddenly (e.g. flat tire due to abrupt external effects).

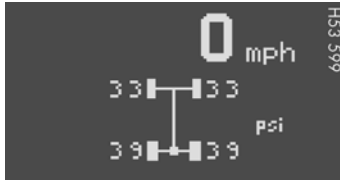

Tire pressure function of the on-board computer

The tire pressure function of the on-board computer displays the tire pressures (actual pressure) dependent on temperature in the four wheels.

You can watch the tire pressure rise as the temperature increases while driving.

This display is only for information.

- f Under no circumstances should the tire pressures be changed based on this display.

Displaying the tire pressure function of the on-board computer

- f Push operating lever up or down until the tire pressure function of the on-board computer appears.
(The selection field must be **switched off**.)



Pressure info in Tire pressure menu

In accordance with physical principles, the air pressure changes as the temperature changes. The tire pressure increases or decreases by around 1.5 psi (0.1 bar) for every 18°F (10°C) change in temperature.

The tire pressure monitoring takes this relationship between tire pressure and temperature into account.

You can read the tire pressures to be corrected in this display.

The tire pressure to be corrected (refill pressure) is indicated on the displayed wheel.

Example: If “-1.5 psi (-0.1 bar)” is displayed, 1.5 psi (0.1 bar) must be added to this tire.

Note

The Tire pressure menu can only be called up when the vehicle is stationary.

Calling up the “Info pressure” display

- f Push operating lever forward in order to switch on the selection field.
- f Select “TPC” with the operating lever.
- f Push operating lever forward.
The display changes to the Tire pressure menu.
- f Select “Info pressure” with the operating lever.
- f Push operating lever forward.

Note

After the ignition is switched on, it can take up to approx. 1 minute before all tire pressures are displayed. Dashes (“-.-”) appear instead of the tire pressures.



Tire type info in Tire pressure menu

Information about the currently set tires:

- Tire type:
Summer tires, winter tires
- Tire size:
18, 19 inch

"Info tires" shows the current tire settings.

Calling up the "Info tires" display

- f Push operating lever forward in order to switch on the selection field.
- f Select "TPC" with the operating lever.
- f Push operating lever forward.
The display changes to the Tire pressure menu.
- f Select "Info tires" with the operating lever.
- f Push operating lever forward.

Tire selection in the "Set" menu

- f Push operating lever forward in order to switch on the selection field.
- f Select "TPC" with the operating lever.



- f Push operating lever forward.
The display changes to the Tire pressure menu.



- f Select "Set" with the operating lever.

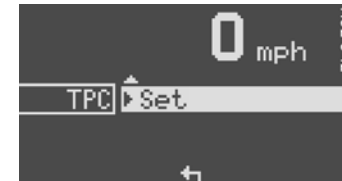

- f Push the operating lever forward.

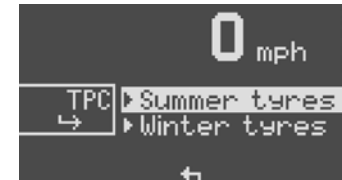

- f Select desired tire type:
summer or winter.
- f Push operating lever forward.
A display for confirming the selected type of tire appears.

f f f



- f Select "Continue" and push the operating lever forward.



- f Select the appropriate tire size (18 or 19 inch) and push operating lever forwards. A display for confirming the selected tire size appears.

Note

This menu is only displayed when different tire sizes are approved.



- f Select "Continue" and push the operating lever forward.

Setting of the tire characteristics has only been successfully completed when the message "Process complete" is displayed by the on-board computer.

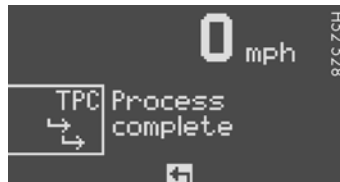

- f Select arrow (Back) and push the operating lever forward. The display returns to the Tire pressure menu. The on-board computer additionally displays the message "System learning".

Note

The message "Process aborted" appears if the setting process is interrupted. All entries made up to this point are lost, and the original settings remain in effect.

Only if the message "Process complete" appears after the settings have been made will the tire pressure monitoring re-learn the wheels.

- f Please observe the chapter "SYSTEM LEARNING" on Page 115.

Before fitting tires with sizes which are not stored in the on-board computer, the missing information should be supplemented in the on-board computer.

- f Consult a qualified specialist garage. We recommend that you use a Porsche partner for this work since these are staffed with trained personnel and have the necessary parts and tools.
- f Use only tires approved by Porsche.

The available items in the Tire pressure menu depend on the equipment of your vehicle. For this reason it is possible that some of the items shown here are not available on your on-board computer's display.



- f Please observe the chapter "TIRE PRESSURES FOR COLD TIRES" on Page 290.
- f Make sure that the tire pressures correspond to the on-board computer settings. Correct the tire pressures if necessary.

**Load
(depending on equipment level)**

- f Push operating lever forward in order to switch on the selection field.
- f Select "TPC" with the operating lever.
- f Push operating lever forward.
The display changes to the Tire pressure menu.
- f Select "Load" with the operating lever.



- f Select partial load or full load and push the operating lever forward.

Tire pressure warnings

The tire pressure monitoring warns about loss in pressure in two stages, depending on the amount of pressure loss:

Stage 1 – Add air
(3 to 6 psi (0.2 to 0.4 bar) loss in pressure)

Stage 2 – Flat tire
(from 6 psi (0.4 bar) loss in pressure)



Stage 1 – Add air

The pressure in the tire is too low by 3 to 6 psi (0.2 to 0.4 bar). Driving with insufficient tire pressure reduces the road safety of the vehicle and destroys the tire and wheel.

- f The tire pressure warning contains the affected tire with the tire pressure to be added. Correct the tire pressure at the next opportunity.

This tire pressure warning appears with vehicle stopped and can be deactivated. The tire pressure warning light in the instrument panel goes out when the tire pressure has been corrected.



Stage 2 – Flat tire

The pressure in the tire has dropped by more than 6 psi (0.4 bar). This significant pressure loss is a danger to road safety.

- f When the tire pressure warning has appeared on the on-board computer, stop immediately at a suitable location. Check the tire for signs of damage. If necessary, fill in tire sealant and set the correct tire pressure.

This tire pressure warning appears when driving and can be deactivated.

The tire pressure warning light in the instrument panel goes out when the tire pressure has been corrected.



System learning

The tire pressure monitoring begins to “learn” the wheels after a wheel change, wheel transmitter replacement or update of the tire settings. During this process, the tire pressure monitoring recognises the tires and their locations. The on-board computer displays the message “TPC inactive – system learning”.

The tire pressure monitoring requires a certain amount of time to learn the wheels. During this time, the current tire pressures are not available on the on-board-computer:

- The display of the Tire pressure function of the on-board computer shows lines.
- The required pressures for cold tires at 68°F (20°C) are indicated in the Info pressure display in the Tire pressure menu.
- Tire pressure warnings are issued without tire pressure and position information (**figure**) as soon as the vehicle’s own wheels have been detected and the tire pressure warning light has gone out.

Position and pressure information is displayed as soon as the tire pressure monitoring has assigned the wheels identified as belonging to the vehicle to the correct wheel positions.

The wheel learning process takes place exclusively when the vehicle is being driven.

- f Manually check the tire pressure at all wheels and correct the tire pressure to the required value.

Changing a wheel and replacing tires

- f New wheels must be fitted with radio transmitters for the tire pressure monitoring. Before tires are changed, the battery charge state of the wheel transmitters should be checked at an authorized Porsche dealer.
- f Switch the ignition off when changing a wheel.

The tire settings on the on-board computer must be updated after changing a wheel.

A message appears if the characteristics of the new tires do not agree with the on-board computer settings.

- f Update the on-board computer settings when the vehicle is stationary the next time.

Warning light

The warning light in the speedometer lights up:

- When a loss in pressure has been detected
- If the tire pressure monitoring is faulty
- When learning newly mounted wheels/wheel sensors, as long as the vehicle's own wheels have not yet been recognized.

The tire pressure warning light in the instrument panel goes out only when the cause of the fault has been rectified.

No monitoring

In the event of faults the tire pressure monitoring cannot monitor the tire pressure.

The warning light on the instrument panel lights up and a corresponding message appears on the on-board computer.

Monitoring is not active when:

- the tire pressure monitoring is faulty,
- wheel transmitters for the tire pressure monitoring are missing,
- temporarily after changing a wheel (learning phase),
- more than four wheel transmitters are detected,
- there is external interference by other radio sources, e.g. wireless headphones,
- tire temperatures are too high.

f Please observe the chapter "WARNINGS ON THE INSTRUMENT PANEL AND THE ON-BOARD COMPUTER" on Page 122.

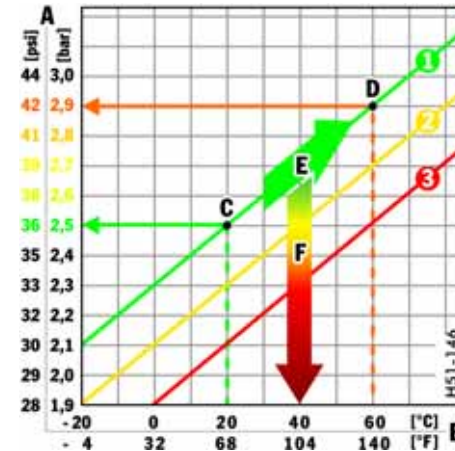

Pressure increase as the result of temperature increase

- A Tire pressure
 - B Tire temperature
 - C Tire pressures for cold tires
 - D Tire pressure for hot tires
 - E Pressure increase as the result of temperature increase
 - F Pressure drop in faulty/leaking tires
1. Required-pressure line
 2. Warning stage 1 (from -3 to -6 psi (-0.2 bar to -0.4 bar))
 3. Warning stage 2 (from -6 psi (-0.4 bar))

In accordance with physical principles, the air pressure changes as the temperature changes. The tire pressure increases or decreases by around 1.5 psi (0.1 bar) for every 18°F (10°C) change in temperature.

The tire pressure monitoring takes this relationship between tire pressure and temperature into account.

Tire pressure specifications

Information on tire pressure for public roads can be found in this Owner's Manual or on the tire-pressure plate in the left door aperture.

These values apply to cold tires at 68°F (20°C) ambient temperature.

OIL Display and measurement of the engine oil level



Caution!

Risk of engine damage.

- f Regularly check the oil level after refuelling.
- f Do not allow the oil level to fall below the minimum mark.

Conditions for measuring the oil level

1. It is important to ensure that the vehicle is **horizontal** for correct oil level measurement to occur.
2. Engine is off.
3. Ignition on.

Oil return time

Before the oil level is measured, the engine oil has to have flowed back into the oil pan. The time taken for the engine oil to flow back depends on the engine temperature and how long the engine has been stopped.

This waiting time is counted down in the on-board computer display when the ignition is switched on. The oil level display segments start to "cycle".

- f It is best to measure the engine oil level before embarking on a journey (if the vehicle has not been driven for an extended period) or with the engine at operating temperature. Shorter waiting times are achieved in this way.

Initiating oil level measurement

- f Switch ignition on (do not start the engine). The engine-oil level measurement display appears in the on-board computer.



- f Allow waiting time to elapse.
- f Once the measurement has been completed, you can read off the engine oil level on the segment display.



- If the segments are filled in up to the top line, the oil level has reached the maximum mark.
- f Under no circumstances add engine oil.



- If the bottom segment is filled in, the oil level has reached the minimum mark.
- f Add engine oil immediately.
- If the segment flashes, the oil level has dropped to below the minimum mark.
- f Add engine oil immediately.

The difference between the minimum and maximum marks on the segment display is approx. 1.2 liters.

Each segment of the display corresponds to approx. 0.4 liter.

- f Add engine oil if necessary.
Please observe the chapter "ENGINE OIL LEVEL" on Page 201.
Before adding oil, switch ignition off.

f Never add more engine oil than required to reach the maximum mark.

Oil level measurement during refuelling

The oil level is automatically measured during refuelling.

Preconditions

1. Ignition is switched off.
2. If the engine is at operating temperature, at least 5 minutes must elapse between parking the vehicle and starting the engine.
3. Refuelling completed within 15 minutes.

When the ignition is switched on, the engine oil level is shown on the segment display.

Measurement will be stopped if the above requirements are not met.

- f Start oil level measurement in the "OIL" menu
or
- f Start oil level measurement by switching on the ignition.

Failure

A failure of the oil level display is indicated by a warning message in the on-board computer.

The oil level measurement can also be initiated in the "OIL" menu:

Switching on selection field "D"

- f Push operating lever forward.

Initiating measurement

- f Select "OIL" with the operating lever.



- f Push operating lever forward.
Measurement is started.

SET Basic setting on on-board computer

Switching on selection field "D"

f Push operating lever forward.

Changing the basic setting of the on-board computer

f Select "SET" with the operating lever.



f Push operating lever forward.

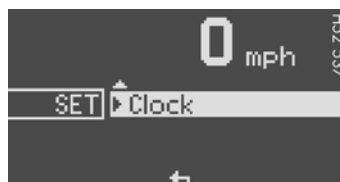

f Select the desired function with the operating lever:

Reset

- Reset all,
Reset average consumption,
Reset average speed,
Reset trip counter

Units

- Speedometer
km - km/h, miles - mph
- Consumption
l/100 km, mis/gal (USA), mpg (UK), km/l
- Temperature
°Celsius, °Fahrenheit
- Tire pressure
bar, psi

Display (Select central line of the on-board computer)

- **Change display**
Audio information (set radio station)
Range on remaining fuel
Empty
- **Telephone Info**
When Telephone information is active, incoming telephone calls are displayed on the on-board computer.

Navigation

- Integrated in the BC
(Navigation instructions can be recalled on the on-board computer display)
- When turning off
(Navigation instructions are only shown before changing direction)

Basic setting

- Restore the basic setting of the on-board computer

Language

- Select language version

12/24h mode

- Select time mode:
12h (small squares on the right side of the time display for AM/PM),
24h

General information regarding the on-board computer functions

Range on remaining fuel

The range on remaining fuel is continuously recalculated during the journey based on the fuel level, current consumption and average consumption. The more the fuel level falls, the more spontaneously the display reacts. For this reason, the range on remaining fuel is not displayed if less than 9 miles (15 kilometers).

If the vehicle's inclination changes while driving or refuelling, incorrect range information may temporarily be given.

Note

If the tank is nearly empty and you top up with only a small quantity of fuel, an accurate range on remaining fuel is impossible.

Average consumption and average speed

The values displayed are based on the distance travelled since the last reset to "zero".

You can set the starting time for a measurement before or during the trip.

Switching the ignition off does not reset the measurements. It is therefore possible to collect values over long periods.

Disconnecting the car battery will cause these memories to be erased.

memories to be erased.









Tire pressure







The **Tire pressure** function of the on-board computer displays the tire pressures dependent on temperature in the four wheels. You can watch the tire pressure rise and fall while driving.













The display is only for information. To correct the tire pressures, always use the displayed values from the "Info pressure" display in the Tire pressure menu.

















Warnings on the instrument panel and the on-board computer







If a warning message appears, always refer to the corresponding chapters in the Owner's Manual. Warning messages are issued only if all measurement preconditions are met. Therefore, check all fluid levels regularly – in particular, always check the engine oil level after refuelling.











Instrument panel	On-board computer	Text display on on-board computer	Meaning/measure
		Seat belt	Driver and passengers must fasten their seat belts.
		Handbrake	Handbrake is still on.
		Ignition key not removed	
		Replace battery in ignition key	Replace the remote-control battery.
		Ignition lock faulty, please go to workshop	Have the fault remedied at an authorized Porsche dealer.
		Ignition lock faulty, visit workshop now	Have the fault remedied at an authorized Porsche dealer.
		Relieve steering	Relieve the steering lock by moving the steering wheel to the left or right.
		Steering locked	The steering wheel lock remains engaged. Have the fault remedied at an authorized Porsche dealer.
		Lights on	
		Parking light on	













Instrument panel	On-board computer	Text display on on-board computer	Meaning/measure
		Check left/right dipped beam (low beam) also applies to: front side lights, direction indicator, high beam, fog lights, side indicator light, brake light, tail light, rear fog light, reversing light, raised brake light, side marker	The reported light is faulty. Check bulb. Have the fault remedied at an authorized Porsche dealer.
		Daytime driving lights off	Daytime driving lights switch off when the engine is shut off. Switch on lights if necessary.
		Headlight beam adjustment faulty	Have the fault remedied at an authorized Porsche dealer.
		Front lid not closed	Close luggage compartment lid properly.
		Rear lid not closed	Close engine compartment lid properly.
		Lid opener front faulty	Luggage compartment lid release is faulty. Have the fault remedied at an authorized Porsche dealer.
		Rain sensor faulty	Have the fault remedied at an authorized Porsche dealer.
		Refill washer fluid	
		LIMIT Cannot be accepted with vehicle stopped	The current speed can only be accepted for the acoustic warning signal when the vehicle is in motion.
		LIMIT 30	Selected speed limit (e.g. 30 mph) for the acoustic warning signal has been exceeded. Adjust your speed if necessary.

Instrument panel	On-board computer	Text display on on-board computer	Meaning/measure
Fuel gauge warning light		Consider remaining range	Refuel at next opportunity.
		Check engine oil level	Start engine oil level measurement in the on-board computer. The vehicle must be horizontal and the ignition must be switched on.
		Engine oil pressure too low	Stop immediately at a suitable place, measure oil level with the on-board computer and, if necessary, add engine oil.
Warning light Temperature gauge		Engine temperature too high	Switch engine off and let it cool. Check coolant level and, if necessary, add coolant.
Temperature gauge warning light flashes		Check coolant level	Switch engine off and let it cool. Check coolant level and, if necessary, add coolant.
		Engine diagnostics – workshop	Consult your authorized Porsche dealer.
		Reduced engine power	Consult your authorized Porsche dealer.
Temperature gauge warning light flashes		Failure of engine compartment blower	Consult your authorized Porsche dealer.
		Warning Battery/generator	Stop at a safe place and switch the engine off. Do not continue driving. Have the fault remedied at an authorized Porsche dealer.
		Oil pressure gauge faulty	Have the fault remedied at an authorized Porsche dealer.
		Oil level display faulty	Have the fault remedied at an authorized Porsche dealer.

Instrument panel	On-board computer	Text display on on-board computer	Meaning/measure
		Oil temperature gauge faulty	Have the fault remedied at an authorized Porsche dealer.
		Indicator faulty	Coolant indicator failed. Have the fault remedied at an authorized Porsche dealer.
		Brake pad wear	Have the brake pads changed immediately at an authorized Porsche dealer.
		Warning – Brake fluid level	Stop immediately in a suitable place. Do not continue driving. Have the fault remedied at an authorized Porsche dealer.
		Warning – Brake circuit division	Stop immediately in a suitable place. Do not continue driving. Have the fault remedied at an authorized Porsche dealer.
		ABS failure	Have the fault remedied at an authorized Porsche dealer.
		PSM off	Porsche Stability Management has been switched off.
		PSM on	Porsche Stability Management has been switched on.
		PSM failure	Have the fault remedied at an authorized Porsche dealer.
		PASM Normal/Sport	Indicator for selected PASM mode
		PASM failure	Have the fault remedied at an authorized Porsche dealer.
		PASM indicator faulty	Have the fault remedied at an authorized Porsche dealer.

Instrument panel	On-board computer	Text display on on-board computer	Meaning/measure
		Sport mode failure	Have the fault remedied at an authorized Porsche dealer.
		Airbag system fault	Airbag is faulty. Have the fault remedied at an authorized Porsche dealer.
		Check passenger's seat setting	Weight sensing is impaired on the front passenger's seat (Advanced Airbag). Correct the seating position, set the backrest upright, do not support weight on the armrests, or lift on the handles.
		Failure spoiler control	Driving stability is impaired. Adjust your driving style. Reduce speed. Have the fault remedied at an authorized Porsche dealer.
Display of selector lever position flashes		Selector lever is not engaged	Tiptronic S: Selector lever can be between two positions. Engage the selector lever correctly.
		Move selector lever to P	Tiptronic S: Move selector lever to position P before withdrawing key from ignition lock.
		Apply brake	Tiptronic S: Apply the brake when starting.
		Depress clutch pedal	Manual transmission: Depress clutch pedal when starting.
		Move selector lever to position P or N	Tiptronic S: The vehicle can be started only in the selector lever position P or N.
Display of selector lever position flashes		Tiptronic emergency run	Have the fault remedied at an authorized Porsche dealer.

Instrument panel	On-board computer	Text display on on-board computer	Meaning/measure
		System fault Go to workshop	Several systems may have failed. Adjust your driving style. Reduce speed. Have the fault remedied at an authorized Porsche dealer.
		Failure of fuel level indicator Workshop	Have the fault remedied at an authorized Porsche dealer.
		Service in km/days	Service indicator Bring the vehicle in for service no later than after the distance/time shown has elapsed. However, it is the intervals in the "Guarantee and Maintenance" booklet that are decisive.
		Service now	Service indicator Have your vehicle serviced at an authorized Porsche dealer.
		Failure Convertible-top control	Activate convertible top in opposite direction. If there is a failure: Consult an authorized Porsche dealer.
		Convertible top not in limit position	Fully open or close convertible top
		Opening convertible top	Message goes out in final position
		Closing convertible top	Message goes out in final position
		Close rear lid	The convertible top cannot be operated with the rear lid open.
		Flat tyre!	Tyre pressure monitoring system has detected a serious pressure loss. Stop in a suitable place and check tyres for damage. Fill in tyre sealant if necessary.

Instrument panel	On-board computer	Text display on on-board computer	Meaning/measure
		Add air	The tyre pressure monitoring system has detected a gradual pressure loss. Correct tyre pressure at the next opportunity.
		TPC inactive System learning	The tyre pressure monitoring system is learning the wheels on the vehicle. The tyre pressure monitoring system is searching for the tyres and their position. During this period the current pressure specifications are not available on the on-board computer.
		TPC inactive	The tyre pressure monitoring system is faulty. Consult a qualified specialist workshop.*
		TPC inactive Brief disturbance TPC inactive Too many wheel transmitters	The tyre pressure monitoring system is temporarily deactivated by excessive tyre temperatures (approx. 120 °C (248°F)) or external interference (e.g. from other wheel transmitters inside the car). Once the source of the interference is removed, the system is automatically reactivated.
		Wheel change? Input new TPC settings!	Update the settings in the TPC menu of the on-board computer at the next opportunity. Wrong entries will affect the correct pressure information in the menu. The safety of your vehicle is at risk.
		TPC Indicator faulty	The display of the tyre pressure monitoring system is faulty. Consult a qualified specialist workshop.*

Acknowledging warning messages

Warning messages can be deleted from the on-board computer display.

f Push the on-board computer operating lever forward.

You can recall erased warning messages in the "INFO" menu.



Emergency Flasher Switch

Operational readiness of the emergency flasher does not depend on the ignition lock and turn signal lever position.

- f If your car is disabled or parked under emergency conditions switch on the emergency flasher in the dashboard.
All turn signals and the indicator light in the switch flash with the same frequency.

Warning!

Risk of an accident.

- f Whenever stalled or stopped for emergency repairs, move the car well off the road. Switch on the emergency flasher and mark the car with road flares or other warning devices.
- f Do not remain in the car. Someone approaching from the rear may not realize your vehicle is stopped and cause a collision.

Danger of fire.

- f Do not park or operate the vehicle in areas where the hot exhaust system may come in contact with dry grass, brush, fuel spill or other flammable material.

Hot engine compartment components can burn skin on contact.

- f Before working on any part in the engine compartment, turn the engine off and let it cool down sufficiently.
-





Light Switch

- Lights switched off

HOME Welcome Home Function

 **Parking lights**, side marker lights, license plate light, instrument illumination

 **Low beam, high beam**
Only with ignition on

 **Fog lights** in addition to parking lights or low beam:
Pull switch to first click.
Indicator light on.
The fog lights will go out automatically when the high beams are switched on.

 **Rear fog light** in addition to the fog lights:
Pull switch to second click.
Indicator light on.

If the ignition key is withdrawn and the door is opened while the lights (not the parking light or Welcome Home lighting) are on, a **chime** warns of possible battery discharge.

In some countries, differences are possible due to provisions of law.

Note on operation

Further individual light functions (e.g. daytime driving lights) are available in vehicles with the Sport Chrono package.

Please observe the chapter "Individual Memory" in the separate PCM operating instructions.

Welcome Home Lighting

Switching on

f Move light switch to the HOME position.

For improved visibility and security when you get in and out of the car, the fog lights and the tail lights remain on for a certain period of time:

- **When you get out of the car**, the lights are turned on for approx. 30 seconds after the door is opened. The off-delay time resumes when the vehicle is locked.
On vehicles with the Sport Chrono package, the PCM can be used to set the off-delay time. This setting also changes the lighting period for unlocking the vehicle.
Please observe the chapter "Individual Memory" in the separate PCM operating instructions.
- The lights are turned on for approx. 30 seconds **when the vehicle is unlocked**. The lights go out if the ignition is switched on or when leaving the Welcome Home lighting.

Automatic Headlight Beam Adjustment

Vehicles with **Bi-Xenon headlights** feature **automatic** headlight beam adjustment.

When the ignition is switched on, the level of the headlight beam automatically changes in accordance with the vehicle load.

The level of the headlight beam is automatically kept constant during acceleration and braking.

Checking operation

1. Switch the low beam on.
2. Insert ignition key and switch ignition on.
The light beam first dips all the way down and is then adapted to the vehicle load.

If this test item is not met, the headlight beam adjustment system must be checked by an authorized Porsche dealer.



Turn Signal / Headlight Dimmer / Parking light / Flasher Lever

Turn signals, low beam and high beam are ready for operation when the ignition is on.

1 - Turn signal left

2 - Turn signal right

Push the lever to the upper or lower pressure point - turn signals flash three times

3 - High beam

4 - Headlight flasher

Lever in center position - Low beam

When high beam and headlight flasher are selected, the blue indicator light in the tachometer is lit.

The turn signal lever turns off automatically when the steering wheel is straightened out after completing a turn.

Lane changer

- f To indicate your intention when changing lanes on the freeway, slightly lift or depress the lever to the resistance point.
The lever will return to the OFF position when released.
- f If the frequency of the display becomes noticeable faster, check the operation of the turn signal bulbs.

Headlight flasher

(With ignition on or off)

- f To flash the headlights to oncoming motorists, slightly pull the lever toward the steering wheel and then release it.
The blue indicator light in the tachometer will go on/off as you pull/release the lever.

Parking light

The parking light can only be switched on when the ignition is switched off.

- f Move the lever up or down to switch on the right or left parking light.



Windshield Wiper / Washer Lever

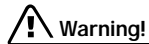

Warning!

Danger of injury when the windshield wipers operate unintentionally.

Risk of damage to the windshield and wiper system.

- f Avoid running the wiper blades over a dry windshield to prevent scratching the glass. Spray washer fluid on the windshield first. A scratched windshield will reduce visibility.
- f Always loosen wiper blades from frozen glass before operating wipers to prevent damage to the wiper motor or blades.

- f Always switch off windshield wipers in car wash to prevent them wiping unintentionally (intermittent or sensor operation).
- f Always switch off windshield wipers before cleaning the windshield to avoid unintentional operation (intermittent or sensor operation).
- f Do not operate the headlight washer in car washes.
- f Do not operate headlight washer when it is frozen.

Front wiper and headlight washer system

0 – Windshield wipers off

1 – Rain sensor operation for front windshield wipers

- f Move wiper lever upwards to the first click. Please observe the chapter "RAIN SENSOR" on Page 135.

2 – Windshield wipers slow

- f Move wiper lever upwards to the second click.

3 – Windshield wipers fast

- f Move wiper lever upwards to the third click.

4 – Front windshield wiper – one-touch operation:

- f Move wiper lever downwards. The front windshield wipers wipe once.

5 – Windshield wipers and washer system:

- f Pull wiper lever towards the steering wheel. The washer system sprays and wipes while the lever is pulled towards the steering wheel. When the wiper lever is released, a few drying wipes are executed.

A - Headlight washer (Vehicles with Bi-Xenon headlights):

The washer sprays only while low beam or high beam is switched on.

- f Briefly push button A to operate headlight washer system.
- f If heavily soiled, repeat wash.

The headlight washer system automatically sprays once for every ten times the front windshield washer system is operated.

Note

The **windshield washer nozzles** are heated when the ignition is on, as a precaution against freezing.



The rear wiper is automatically switched off when a speed of 130 mph (210 km/h) is exceeded. It is switched on again when the speed falls below 118 mph (190 km/h).

On vehicles with the Sport Chrono package, further rear wiper functions can be selected via the PCM.

Please observe the chapter "Individual Memory" in the separate PCM operating instructions.

Rear Wiper

6 – Rear window wiper – intermittent operation

- f Move wiper lever forwards to the first click. The rear window wiper wipes at preset intervals.



Rain sensor

In vehicles with a rain sensor the amount of rain or snow which has settled on the windshield is measured. Wiper speed is automatically adjusted accordingly.

Switching on

- f Move wiper lever upwards to the first click.

Switching off

- f Move wiper lever to position **0**.

The rain sensor remains switched off if the wiper lever is already in position **1** when the ignition is switched on.

To switch the rain sensor on again:

- f Move wiper lever to position **0** and then to position **1** or
- f Operate windshield washer system **5** or
- f Change the sensitivity of the rain sensor with four-stage switch **A**.

Switch-on is confirmed by one wipe of the windshield.

On vehicles with the Sport Chrono package, further rain sensor functions can be selected via the PCM.

Please observe the chapter "Individual Memory" in the separate PCM operating instructions.

Changing the sensitivity of the rain sensor

Sensitivity can be set with switch **A** in 4 stages:

- f Adjust switch **A** upwards – high sensitivity. The setting is confirmed by one wipe of the windshield.
- f Adjust switch **A** downwards – low sensitivity.

Maintenance note

If the wiper blades rub or squeak, this may be as a result of the following:

- If the vehicle is washed in an automatic car wash, wax residues may be adhering to the windshield. These wax residues can only be removed by using a special cleaning solution. Please contact your authorized Porsche dealer for further information.
- The wiper blades may be damaged or worn out.
- f Replace wiper blades as soon as possible.
- f Persistent dirt (e.g. insect remains) should be regularly removed.
- f Please observe the chapter "CAR CARE INSTRUCTIONS" on Page 218.



- A - Automatic speed control readiness off/on
 1 - +SPEED/SET (accelerate/store)
 2 - -SPEED (decelerate)
 3 - OFF (interrupt)
 4 - RESUME

Automatic Speed Control

The automatic speed control maintains any selected speed between 15 mph and 145 mph (30 km/h and 240 km/h) without you having to use the accelerator pedal.

The automatic speed control is operated with the lever on the steering wheel.

Vehicles with Tiptronic

Additional downshifts are carried out to help maintain the pre-selected speed (especially when driving downhill).



Risk of accident and consequent personal injury. A constant speed may not be safe in heavy traffic, or on winding or slippery roads.

With the speed control system engaged, the engine speed will not return to idle when removing the foot from the accelerator pedal.

- f Do not use the speed control when it may be unsafe to keep the car at a constant speed.
- f Observe all local and national speed limits.

Switch automatic speed control readiness on

- f Press button **A** on the automatic speed control lever.



This green indicator light in the speedometer now indicates readiness

Hold and store speed

- f Bring the car to the desired speed with the accelerator.
- f Then briefly push the operating lever forward (position 1).

Accelerating (e.g. to overtake)

Option 1

- f Increase the speed as usual with the accelerator.
When you ease off the accelerator, the previously saved value is set again.

Option 2

- f Push operating lever forward (position 1) until the desired speed is reached.
The speed reached is maintained and stored when the lever is released.

Option 3

- f Push lever slightly forwards (position 1) (a maximum of 10 times).
The speed is increased by 1 mph (1.6 km/h) each time.

Note on operation

Speed control operation is automatically interrupted if the speed is increased by more than approx. 16 mph (25 km/h) for longer than 20 seconds.

Decelerating

Option 1

- f Pull operating lever towards the steering wheel (position **2**) until the desired speed is reached. The speed reached is maintained and stored when the lever is released.

Option 2

- f Briefly move lever towards the steering wheel (position **2**) (a maximum of 10 times). The speed is reduced by 1 mph (1.6 km/h) each time.

Vehicles with Tiptronic

Additional downshifts are carried out to improve deceleration (especially when driving downhill).

Interrupting automatic speed control operation

- f Pull operating lever downwards briefly (position **3**) **or**
- f Operate brake or clutch pedal **or**
- f Switch Tiptronic transmission to selector lever position **N**.
- f Please observe the chapter "TIPTRONIC S" on Page 165.

The speed driven before the interruption remains stored in the memory.

Automatic speed control operation is interrupted automatically:

- If the set vehicle speed is exceeded by more than approx. 16 mph (25 km/h) for longer than 20 seconds.
- If the actual vehicle speed falls to approx. 6 mph (10 km/h) below the set vehicle speed for longer than 5 seconds (upward slopes).
- For PSM control operations.

Resuming the stored speed

- f Briefly push operating lever upwards (position **4**). The speed control accelerates/decelerates the vehicle to the stored speed.

The stored speed should only be recalled when traffic conditions and the road surface so permit.

Switching automatic speed control readiness off

- f Press button **A** on the automatic speed control lever. The green readiness light in the speedometer goes off.

When the vehicle is parked and the ignition switched off, the memory is cleared.

Important note

On upward or downward slopes, the set speed cannot always be maintained by the automatic speed control.

To obtain sufficient engine braking or a better engine-speed range, therefore, you have to select a lower gear.

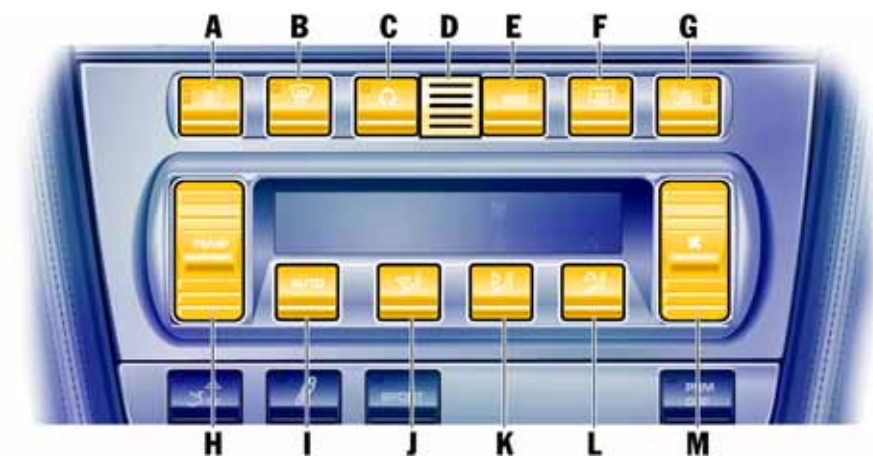

- A - Seat heating, left*
- B - Defrosting the windshield*
- C - Recirculating-air button*
- D - Temperature sensor*
- E - ECO button (air-conditioning compressor off/on)*
- F - Heated rear window*
- G - Seat heater, right*
- H - Temperature button*
- I - AUTO button (automatic mode)*
- J - Air distribution to footwell*
- K - Air distribution to central and side vents*
- L - Air distribution to windshield*
- M - Blower speed button*

Automatic Air Conditioning System Automatic mode

The automatic air-conditioning system controls the preselected interior temperature completely automatically. If necessary, the automatic system can be manually influenced.

- f Press AUTO button I.
AUTO will appear on the display panel. Air quantity and distribution are automatically controlled and variations are compensated.

All automatic setting functions can be individually changed.

This setting is retained until the appropriate function button is pressed again or the AUTO button is pressed.

Setting temperature

- f Press button **H** upwards or downwards respectively.

To suit personal comfort, the interior temperature can be adjusted between 61°F and 85°F/16 and 29.5°C.

Recommendation: 72°F/22°C.

If "LO" or "HI" appears on the display, the system is operating at maximum cooling or heating power.

Automatic control is no longer active.

Note

If the preselected temperature is changed, the blower speed can increase automatically in automatic mode.

The desired temperature is reached more quickly this way.

Sensors

To avoid affecting the performance of the air-conditioning system:

- f Do not cover the sun sensor on the instrument panel or the temperature sensor **D**.



Defrosting the windshield

- f Press button **B** (switch on or off).
The windshield is defogged or defrosted as quickly as possible.
Air flows to the windshield only.
The light-emitting diode in the button lights up.

ECO – switching compressor for air-conditioning system on and off

The air-conditioning compressor switches off automatically at temperatures below approx. 37°F/3°C and cannot be switched on, even manually.

Whenever outside temperatures exceed approx. 37°F/3°C, the air-conditioning compressor is always switched on in automatic mode.
The compressor can be switched off to save fuel, but control comfort is then limited:

- f Press ECO button **E**.
The compressor is switched off.
The light-emitting diode in the button lights up.
- f If the interior temperature is too high, switch compressor back on or press AUTO button.

To dry incoming air in damp weather, do not switch off the air-conditioning compressor.
This prevents fogging of windows.



Adjusting blower speed

- f Press button **M** upwards or downwards respectively.
The preset blower speed is increased or decreased.

The speed stages are indicated by a bar display.

If the button is pressed downwards at the lowest blower stage, the blower and automatic control are switched off. "OFF" will appear on the display field.

Pressing the button upwards or pressing the AUTO button switches the blower and automatic control back on again.



Recirculating-air setting



Warning!

**Risk of accident due to impaired vision.
In recirculating-air setting, the windows may fog up.**

- f Only select recirculating-air setting for short periods.
- f If the windows fog up, switch recirculating-air setting off immediately by pressing the circulating-air button again and select the "Defrost windshield" function.

f f f

Switching recirculating-air setting on or off

- f Press button C.
The outside-air supply is interrupted and only the inside air is circulated.
The light-emitting diode in the button lights up.

Over approx. 37°F/3°C

If the air-conditioning compressor was off, it switches on automatically. The duration of recirculating-air setting is not limited.

Below approx. 37°F/3°C

The air-conditioning compressor is switched off. Recirculating-air setting is automatically ended after approx. 3 minutes.

Air distribution

The individual air distributions can be combined as desired.

Recommended setting in Summer:
Air distribution to central and side vents.

Recommended setting in Winter:
Air distribution to footwell and windshield.



Air distribution to footwell

- f Press button J.
The air flows to the footwell.
The selection appears on the display panel.



Air distribution to central and side vents

- f Press button K.
The air flows from the central and side vents.
Vents must be open.
The selection appears on the display panel.



Air distribution to windshield

- f Press button L.
The air flows to the windshield.
The selection appears on the display panel.

Note on operation

- f On vehicles with the Sport Chrono package, individual air conditioning settings can be stored on your vehicle key.
Please observe the chapter "Individual Memory" in the separate PCM operating instructions.

General instructions for air-conditioning compressor

- Can switch off briefly if engine is under an extreme load to ensure sufficient engine cooling.
- Switches off automatically at temperatures below approx. 37°F/3°C and cannot be switched on, even manually.
- Operates most effectively with windows closed.
If the car has been in the sun for a long time, it is a good idea to ventilate the interior briefly with the windows open.
- Depending on the outside temperature and humidity, condensation can drip from the evaporator and form a pool under the vehicle.
This is normal and not a sign of leakage.
- If uncooled air flows out when the lowest temperature has been set, switch off the air-conditioning compressor and have the fault repaired at an authorized Porsche dealer.



A - Continuous opening and closing
 B - Setting vent direction

Central and Side Vents

○ Opening vents

f Rotate knurled wheel upward.

● Closing vents

f Rotate knurled wheel downward.

Changing air flow direction

f Move the vanes to make the air flow in the desired direction.

Outside air or conditioned air can be delivered from all vents, depending on the air-distribution setting on the operating panel.

Fresh-air Intake

To ensure proper air intake:

f Keep the fresh-air inlet between the luggage compartment lid and the windshield free from snow, ice and leaves.



 **Heated Rear Window/Door Mirror Heating**

The heated rear window/door mirror heating is ready for operation when the ignition is on.

Switching on

- f Press button.
The light-emitting diode in the button lights up.
- After approx. 15 minutes, the heating switches off automatically.
The heater can be switched back on by pressing the button again.

Switching off

- f Press button.
The light-emitting diode in the button goes out.

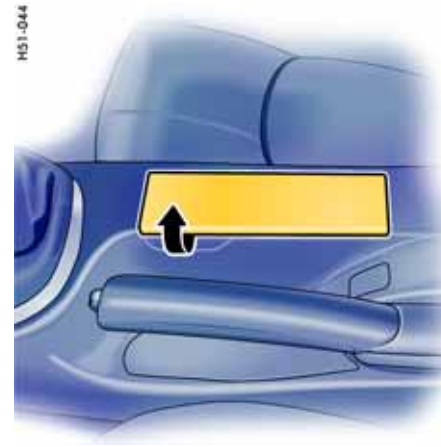

Ashtray

Opening

- f Open ashtray lid.

Emptying

- f Open ashtray and carefully pull out ash insert.
- f Leave ashtray lid open.
Push in ash insert.

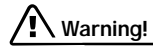

Danger of fire.

- f Never use ashtray for waste paper disposal, as it could pose a fire hazard.
-

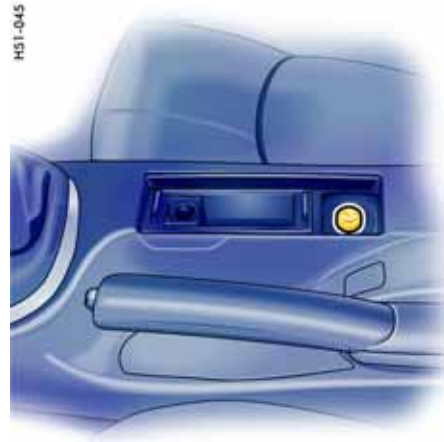

Cigarette Lighter



Danger of fire and burning.
The cigarette lighter is ready for use, regardless of the ignition lock position.

- f Never leave unsupervised children in the car.
 - f Never touch the heating element or sides of the lighter.
 - f Hold the lighter by the knob only.
-

Heating lighter

- f Open ashtray lid.
- f Push in knob of the cigarette lighter.
When ready for use, the lighter will snap back.

Note on operation

The lighter receptacle is not to be used for electrical accessories (except for the tire filling compressor).

Maximum power consumption: 150 W

- f Please observe the chapter "SOCKETS" on Page 254.

Cupholder (holder for drinks cans and cups)

- f Keep the cupholder closed while driving.

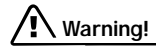

Risk of scalding or damage due to spilling drinks.

- f Only use beverage containers which fit.
- f Never put overfull containers in the cupholder.
- f Never use hot drinks.



Extending cupholder

- f Press the panel.
The panel opens.



- f Press the symbol for the respective cupholder.
 - f Close panel in the middle.
- The cupholders can be pulled out to hold larger containers.



Closing cupholder

- f Push cupholder drawer in.
- f Open panel in the middle.
- f Close and engage the cupholder.
- f Close panel in the middle.

Pulling cupholder out

- f Pull out holder (**arrow**).
- f Insert container.
- f Carefully slide holder inwards to adjust it to the container size.

Storage in the Passenger Compartment



Warning!

Unsecured luggage and heavy objects may come loose during braking, rapid directional changes or in an accident and cause serious personal injury or death.

- f Do not transport any heavy objects in the storage trays.
- f Do not carry unsecured luggage or objects in the passenger compartment.

Additional storage possibilities

- in the doors,
- in the door sill next to the passenger's seat,
- in the center console,
- behind the rear seat backrests (only with the convertible top closed on the Cabriolet, when opening the convertible top there should not be any objects in the area behind the rear seats – **risk of damage**),
- storage tray with coin holder between seats,
- glove compartment with CD and pen holder,
- clothes hook on the roof frame,
- clothes hook on back of front backrests (depending on vehicle equipment),
- enlarged storage space by folding the rear seat backrests forward.

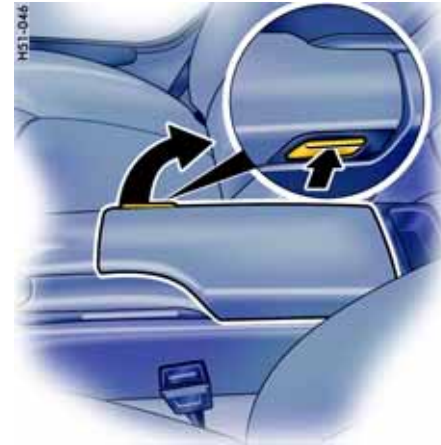

Storage tray between the seats

Opening

- f Press release button and lift the lid. There is a coin holder and socket in the forward part of the storage tray.
- f Please observe the chapter "SOCKETS" on Page 254.

Glove compartment

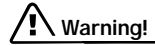

Warning!

Risk of injury by the glove compartment lid in case of an accident.

- f Keep the glove compartment closed while driving.

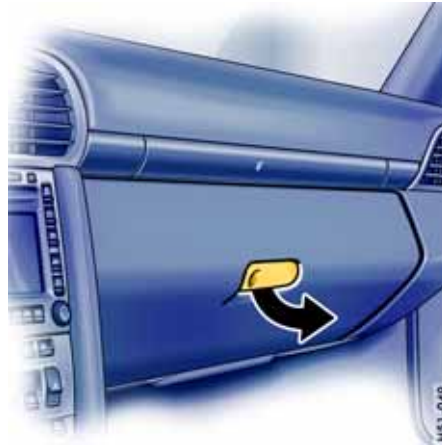

Opening

- f Pull the catch and open the lid.

Locking

- f Lock the catch to secure the contents against unauthorized access.



CD holder

Occupied drawers are indicated by a red window.

Opening drawers

- f Push the button of the drawer you wish to open.

Closing drawers

- f Fold up CD drawer and close until it engages.

Pen holder

A pen can be clipped in on the right side of the CD holder.

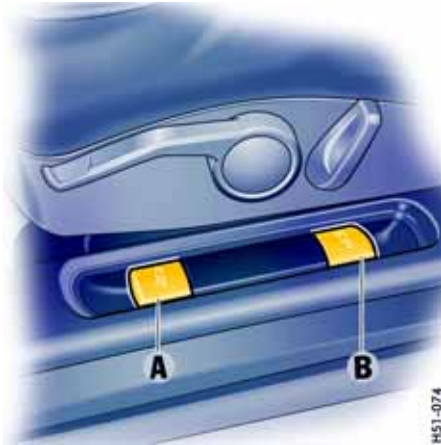

A - Opening luggage compartment lid
B - Opening engine compartment lid

Luggage Compartment Lid and Engine Compartment Lid

Unlocking

- f Operate the appropriate pull-button next to the driver's seat.
The luggage compartment or engine compartment is illuminated when the respective lid is open.
- f Please observe the chapter "LOAD SWITCH-OFF AFTER 2 HOURS OR 7 DAYS" on Page 255.

The luggage compartment lid can also be unlocked with the radio remote control.

- f Please observe the chapter "KEYS" on Page 19.

Important Note

If the vehicle battery is discharged, the luggage compartment lid can be opened only by connecting an external electrical power source.

- f Please observe chapter "ELECTRICAL SYSTEM" on Page 254.
or the description inside the fuse box lid.



Warning message

A warning message in the on-board computer comes on if the lids are not completely closed.

- f Fully close the lid.



Opening luggage compartment lid



Caution!

Risk of damage to luggage compartment lid or windshield wipers.

- f Make sure that the windshield wipers are not folded out forwards when opening the luggage compartment lid.

- f Raise lid slightly and unlatch the safety catch with the lever (**arrow**).

Closing luggage compartment lid and engine compartment lid

- f Lower the lid and close it.
- f Push the lid closed with the palm of your hand in the area of the lock.
Check that the lid has correctly engaged in the lock.



Warning!

Risk of loss of control or an accident, resulting in serious personal injury or death.

- f Should you notice at any time while driving that one of the lids is not secured properly, please stop immediately in a suitable place and close it.
The front lid may fly up impairing vision.



Luggage Compartment (911 Carrera, 911 Carrera S)

Access covers

(on vehicles with DVD navigation or CD changer)

Opening

- f Grasp access cover **A** or **B** at the handle and open.

The drive for DVD navigation and the CD changer can be found behind the access cover **B**.

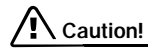

Caution!

Risk of damage.

- f Do not store any heavy, damp or heat-sensitive objects behind the access covers.

Tool box

Opening

- f Unlock turn-locks **C**.
- f Open tool box and place it on the floor of the luggage compartment.



- E - Adapter for security wheel bolts
- F - Tire filling compressor
- G - Towing hook
- H - Tool kit
- I - Tire sealant

Closing

- f Insert tool box into the guide pegs in the luggage compartment floor.
- f Close tool box and lock the turn-locks **C**.



Luggage Compartment (911 Carrera 4, 911 Carrera 4S)

The position of the components in the luggage compartment are dependent on the country equipment and can vary from what is shown in this manual.

DVD navigation

The drive for DVD navigation and the audio amplifier are on the rear wall of the luggage compartment.



Caution!

Risk of damage.

- f Do not store any objects behind the access cover **A**.

Tire sealant

The tire sealant is located behind the access cover **B**.

- f Open access cover **B** using the opening.

Tools

The tools are located under the floor plate of the luggage compartment.

- f Lift the floor plate on the opening and take out.

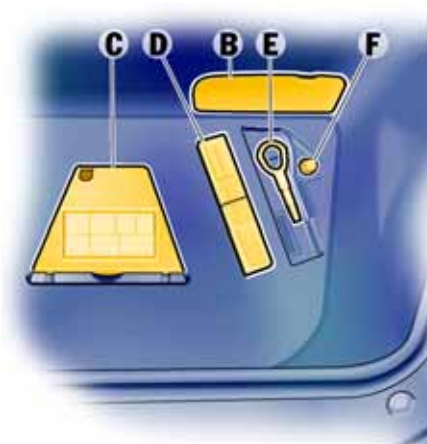

- B** - Access cover for tire sealant
- C** - Tire filling compressor
- D** - Tool kit
- E** - Towing lug
- F** - Adapter for security wheel bolts

H53-167



Trunk Entrapment

Your vehicle is equipped with an internal trunk release mechanism.

A person trapped in the luggage compartment can release the lid from the inside using unlocking handle **A**.

The handle **A** is fluorescent and glows in the dark.



Warning light

A warning message in the on-board computer lights up when unlocking handle **A** is operated.

- f Stop the vehicle immediately when the warning lights light up.
- f Check the luggage compartment.
- f Close the lid.

Function with vehicle stationary

If the luggage compartment lid is unlocked with unlocking handle **A**, the lid can be opened from the inside immediately.

Function with vehicle in motion

If the luggage compartment lid is unlocked with unlocking handle **A** when a speed of 2 mph (3 km/h) is exceeded, the warning message in the on-board computer lights up.

At the same time, the lid is unlocked and the latch striker pops into the catch-hook position.

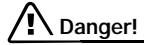

Danger!

Risk of accident.

If the warning message in the on-board computer lights up when the vehicle is in motion, the lid may impact in front of the windshield and can tear off.

You can lose control of the vehicle.

- f Stop the vehicle immediately when the warning message lights up.
 - f Check the luggage compartment.
 - f Close the lid.
-

Note

The lid cannot be opened from the inside if the battery is disconnected or empty.

Safety reasons require that you unscrew the latch striker of the lid lock if you plan to put the vehicle out of operation for an extended period.

Please consult your authorized Porsche dealer. They will advise you about the necessary measures.

Note

- f When loading the luggage compartment, make sure that items of luggage or other objects cannot become caught on handle **A**. This could cause the luggage compartment to open unintentionally.

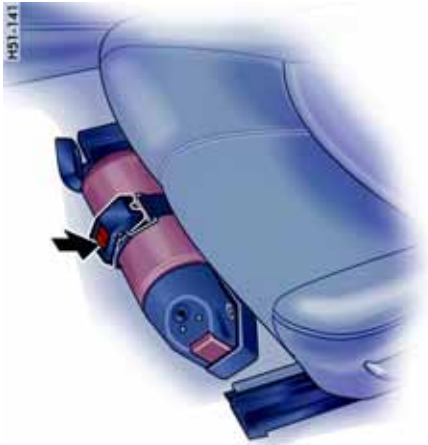

Fire Extinguisher

In cars equipped with a fire extinguisher, the extinguisher is fitted to the front of the driver's seat.

Taking out fire extinguisher

1. Hold fire extinguisher with one hand and press the PRESS button on the fastening strap with the other hand (**arrow**).
2. Remove fire extinguisher from mounting.

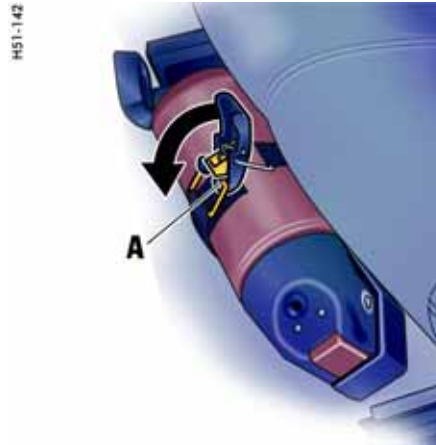

Inserting fire extinguisher

1. Place fire extinguisher in the mounting.
2. Engage fastening strap lug **A** in the tension jack and close tension jack (**arrow**).

Note

- f Pay attention to the final control date on the fire extinguisher.
If the fire extinguisher is used after its expiration date has elapsed, it may not operate properly.
- f Follow the operating instructions on the fire extinguisher.
- f The functional ability of the fire extinguisher should be checked by a specialist workshop every 1-2 years.
- f After use, have the fire extinguisher refilled.

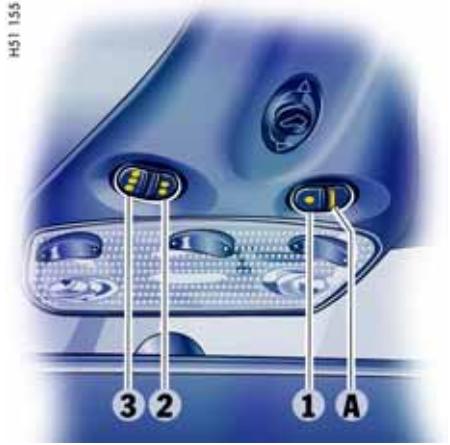

1, 2, 3 - Programmable buttons
 A - Light-emitting diode for status identification

HomeLink

The programmable HomeLink replaces up to three original hand-held transmitters used to operate various devices (e.g. garage door, gate to the property, alarm system).

You can program buttons **1 to 3** with a frequency of an original handheld transmitter.

Warning!

Risk of accident when using the HomeLink if persons, animals or objects are within the range of movement of the equipment that is being operated.

- f When using the HomeLink, ensure that no persons, animals or objects are within the range of movement of the equipment that is being operated.
- f Observe the safety notes for the original hand-held transmitter.

Preconditions for operating and programming the HomeLink:

- Ignition is switched on.
- Fog lights are switched off.

To operate the respective device:

- f Press the appropriate button (**1, 2 or 3**). Light-emitting diode **A** lights up during signal transfer.

Note on operation

- f Always use the HomeLink opener in the direction of travel. Otherwise, range restrictions cannot be ruled out.
- f Before selling the vehicle, delete the programmed signals of the HomeLink.
- f Please read the instructions for the original hand-held transmitter to find out whether the original transmitter is equipped with fixed or changeable code.



Allocating signals to the buttons

- f Please follow the operating instructions for the original hand-held transmitter.

Prior to programming the HomeLink for the first time

The following process deletes the standard codes set at the factory. Do not repeat the process if you program further buttons.

- f Keep the two outer buttons **1 and 3** depressed for approx. 20 seconds until light-emitting diode **A** begins to flash quickly. All programmed signals of buttons **1 to 3** are deleted.

HomeLink with fixed code system

1. Press the desired button until the light-emitting diode begins to flash slowly. You then have approx. 5 minutes to perform steps 2 and 3.
2. Hold the original hand-held transmitter approx. 0 to 12 in. (0 to 30 cm) in front of the marked position (figure) on the vehicle.
3. Press the transmit button on the original hand-held transmitter until the fog lights flash three times (up to approx. 45 seconds).
4. Repeat steps 1 to 3 to allocate other buttons.

Note

Several attempts with different distances between the vehicle and the original hand-held transmitter might be necessary.

The fog lights will flash once the 5 minutes have been exceeded. Programming must be repeated from the beginning in this case.

HomeLink with changeable code system

1. Allocate the required keys as for the systems with fixed code (steps 1 to 3).
2. To synchronise the system: Press the programming button on the receiver for the garage door actuator. Afterwards, you usually have approx. 30 seconds to initiate step 3.
3. Press the allocated HomeLink button twice. (With some devices, the button to be allocated must be pressed a third time in order to complete the setting process.)
4. Repeat the programming steps to allocate other buttons.

Note

- f Please consult your authorized Porsche dealer if you have not been able to successfully allocate signals for the garage door opener to the buttons even though you have carefully followed the instructions in this chapter and the operating instructions for the original hand-held transmitter.

To reprogram a single button:

1. Press the desired button until the light-emitting diode begins to flash slowly (approx. 20 seconds).
You then have approx. 5 minutes to perform steps 2 and 3.
2. Hold the original hand-held transmitter approx. 0 to 30 cm in front of the marked position (figure) on the vehicle.
3. Press the transmit button on the original hand-held transmitter until the fog lights flash three times (up to approx. 45 seconds).
4. Repeat steps 1 to 3 to allocate other buttons.

Note

Several attempts with different distances between the vehicle and the hand-held transmitter might be necessary.

The fog lights will flash once the 5 minutes have been exceeded. Programming must be repeated from the beginning in this case.

Deleting programmed signals of the HomeLink

(e.g., when selling the vehicle)

- f Keep the two outer buttons **1 and 3** depressed for approx. 20 seconds until light-emitting diode **A** begins to flash quickly.
All programmed signals of buttons **1 to 3** are deleted.

Porsche Communication Management (PCM)

- f Refer to the separate operating instructions before putting the PCM into operation.
- f Please observe the chapter "LOAD SWITCH-OFF AFTER 2 HOURS OR 7 DAYS" on Page 255.

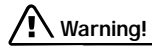

There is a danger of accident if you set or operate the on-board computer, radio, navigation system, telephone or other equipment when driving.

This could distract you from the traffic and cause you to lose control of the vehicle resulting in serious personal injury or death.

- f Operate the components while driving only if the traffic situation allows you to do so safely.
- f Carry out any complicated operating or setting procedures only with the vehicle stationary.

The reception conditions for the radio module integrated in the PCM change continuously as you drive. Interference from buildings, terrain and the weather is unavoidable.

FM stereo reception is particularly susceptible to varying reception conditions.

Electronic accessories should only be retrofitted by a qualified specialist workshop.

Accessories which have not been tested and approved by Porsche may impair radio reception.

Navigation

When put into operation for the first time, a distance of approx. 30 miles (50 km) must be driven in order for the navigation system to complete the process of fine calibration. The same applies when the tires are changed (e.g. summer/winter tires) or new tires fitted. Full location accuracy is not yet achieved during the fine-calibration process.

If the vehicle has been transported (e.g. ferry, car train), the system may take a few minutes to determine the current location after it has been switched on.

Serious tire slip (e.g. spinning wheels on snow) may result in temporarily inaccurate navigation.

When the battery has been disconnected, it may take up to 15 minutes before the navigation system is operational again.

Car Audio Operation/Tips

FM reception

A vehicle is not an ideal place to listen to a radio. Because the vehicle moves, reception conditions are constantly changing.

Buildings, terrain, signal distance and noise from other vehicles are all working against good reception.

Some conditions affecting FM may appear to be problems when they are not.

The following characteristics are completely normal for a given reception area, and they do not indicate any problem with the radio itself.

Note

Electronic accessories should only be installed by your authorized Porsche dealer. Equipment which has not been tested and approved by Porsche may impair radio reception.

Fading and drifting

FM range is limited to about 25 miles (40 km), except for some high power stations.

If a vehicle is moving away from the desired station's transmitter, the signal will tend to fade and/or drift. This condition is more prevalent with FM than AM, and is often accompanied by distortion. Fading and drifting can be minimized to a certain degree by careful attention to fine tuning or selection of a stronger signal.

Static and fluttering

When the line-of-sight link between a transmitter and vehicle is blocked by large buildings or mountains, the radio sound may be accompanied with static or fluttering because of the characteristic of FM.

In a similar effect, a fluttering noise is sometimes heard when driving along a tree-lined road.

This static and fluttering can be reduced by adjusting the tone control for greater bass response until the disturbance has passed.

Multipath

Because of the reflecting characteristics of FM, direct and reflected signals may reach the antenna at the same time (multipath) and cancel each other out.

As a vehicle moves through these electronic dead spots, the listener may hear a momentary flutter or loss of reception.

Station swapping

When two FM stations are close to each other, and an electronic dead spot, such as static or multipath area, interrupts the original signal, sometimes the stronger second signal will be selected automatically until the original one returns.

This swapping can also occur as you drive away from the selected station and approach another station of a stronger signal.

Compact disc player

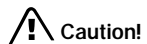

To avoid damage to compact disc player and discs.

- f Use only compact discs labeled as shown, having no dirt, damage or warpage.
- f Never attempt to disassemble or oil any part of the player unit.
Do not insert any object other than a disc into the slot.
Remember there are no user-serviceable parts inside the compact disc player.
- f Do not allow the disc to sustain any fingerprints, scrapes or stickers on the surfaces.
This may cause poor sound quality.
Hold the disc only on the edge or center hole.
- f When not in use, take the disc out of the player, put the disc back into its case and store it away from dust, heat, damp and direct sunlight.
Leaving the disc on the dashboard in the sun can damage the disc.
- f If the disc gets dirty, clean the disc by wiping the surfaces from the center to the outside in a radial direction with a soft cloth.
Do not use a conventional record cleaner or anti-static record preservative.
Disc cleaners are available in audio stores.

Car Telephone and Aftermarket Alarms

Important legal and safety information regarding the use of cellular telephones

Some states may prohibit the use of cellular telephones while driving a vehicle. Check the laws and regulations on the use of cellular telephones in the areas where you drive.



Risk of an accident.

Severe personal injury or death can result in the event of an accident.

Looking away from the road or turning your attention away from your driving can cause an accident and serious or fatal injury.

When using your cellular telephone, you should always:

- f Give full attention to your driving - pull off the road and park before making or answering a call if traffic conditions so require; **and**
- f Keep both hands on the steering wheel - use hands-free operation (if available) - pull off the road and park before using a hand-held telephone.

It is essential to observe the instructions of the telephone manufacturer before putting the telephone into operation.

Any portable telephone or radio transmitter which is used in a Porsche must be properly installed in accordance with the technical requirements of Porsche.

The transmission power must not exceed 10 W.

The devices must possess a type approval for your vehicle and have an "e" symbol.

If you should require equipment with transmission power values greater than 10 W, please consult your authorized Porsche dealer for this purpose. He is familiar with the technical requirements for installing devices of this kind.

The antennas for all radios and telephones with a transmitting antenna must be externally mounted.

The improper installation of radios or telephones or use of a radio or telephone with a transmitting antenna inside the car may cause **the warning lights to come on.**

Improper installation of such equipment can create a discharged battery or excessive current draw from added equipment.

If aftermarket systems are installed by non-dealer-ship technicians or outside the selling dealer, problems may result. Installation of aftermarket equipment is not covered under the New Car Warranty.

- f Consult your authorized Porsche dealer about the installation of non Porsche approved equipment.

Reception quality

The reception quality of your car telephone will change constantly when you are driving. Interference caused by buildings, landscape and weather is unavoidable. It may become particularly difficult to hear when using the hands-free function due to external noise such as engine and wind noise.

Automatic car-wash

- f Unscrew external antennas before using an automatic car-wash.

Shifting Gears

Manual Transmission, Clutch	164
Tiptronic S	165



Manual Transmission, Clutch

The positions of the gears are shown on the shift diagram on the gearshift lever.

Warning!

Risk of accident.

- f Do not obstruct the pedal travel with floor mats or other objects. Nonskid floor mats of the correct size are available at your authorized Porsche dealer.

To avoid damage to the clutch and transmission:

- f Always depress the clutch pedal fully when changing gears. Make sure that the gearshift lever is completely engaged.
- f Only shift into reverse when the car has come to a complete stop.

-
- f When shifting gears, always ensure that the clutch pedal is fully depressed and the gear has fully engaged.
 - f Select reverse only when vehicle is stationary.
 - f Select an appropriately low gear on upward and downward slopes. This will ensure optimum use of engine power and engine braking.

When reverse gear is selected and the ignition is on, the backup lights are illuminated.

Permitted engine speed

- f You should change into a higher gear before the needle reaches the red mark on the tachometer, or ease off the accelerator.

If the red zone is reached during acceleration, fuel feed is interrupted.

Caution!

Risk of engine damage (overrevving) when shifting down to a lower gear.

- f Take care not to exceed the maximum permitted engine speed when shifting down.

Tiptronic S

The Porsche Tiptronic is a five-speed transmission with an “automatic” and a “manual” selection mode.

In **automatic selection mode** (selector lever position **D**), gear changing is automatic. You can change temporarily from automatic to manual mode using the rocker switches on the steering wheel.

In **manual selection mode** (selector lever position **M**), you change gear using the rocker switches on the steering wheel.

You can change between selector lever position **D** and **M** as you wish while driving.

Note

Take care not to operate the rocker switches on the steering wheel inadvertently in either automatic or manual mode, thereby triggering undesired gear changes.

Keylock position

The **ignition key** can be withdrawn only in selector lever position **P**.



Changing the selector lever position

The selector lever is locked with the ignition key withdrawn.

The selector lever can be moved from position **P** or **N** only with:

- The ignition switched on
- The brake pedal pressed and
- The release button pressed

Release button

The release button (**arrow**) in the selector lever prevents unintentional gear changes.

The release button must be pressed when shifting to position **R** or **P**.

Starting

The engine can be started only if the brake pedal is depressed and the selector lever is in position **P** or **N**.

Moving off

- f Only select the desired position for moving off (**D**, **M** or **R**) when the engine is idling and the brake pedal is depressed.
- f Since the vehicle creeps when in gear, do not release the brake until you want to move off.
- f After selecting a gear, do not accelerate until you can feel that the gear is engaged.



Indicator for selector lever position and engaged gear

When the engine is running, the selector lever position and engaged gear are indicated.

If the selector lever is between two positions:

- The corresponding selector lever position in the instrument cluster flashes for two seconds **and**
- The warning "Selector lever not engaged" appears in the on-board computer.
- f Engage the selector lever correctly.
- The selector lever position is displayed immediately after the correct position has been detected.
- The current gear is shown after a brief detection period.

If there is a fault in the transmission:

- The **4th gear** display flashes.
- The warning "Tiptronic emergency run" appears on the on-board computer. Please observe the chapter "REDUCED DRIVING PROGRAM" on Page 170.
- f Have the fault remedied at an authorized Porsche dealer.

Selector Lever Positions

P – Parking lock

- f Engage parking lock only when vehicle is stationary.
- f Engage parking lock **after** applying the hand-brake and release it **before** releasing the hand-brake.

The **ignition key** can be withdrawn only in selector lever position **P**.

R – Reverse gear

- f Select only if car is stationary and the brake is applied.

N – Neutral

Selector lever position **N** must be selected for towing or in car washes, for example.

- f Only select the desired position for moving off (**D**, **M** or **R**) when the engine is idling and the brake pedal is depressed.

D - Automatic selection mode

Select position **D** for “normal” driving. The gears are shifted automatically according to the accelerator position and speed.

Depending on the way the vehicle is driven and on the resistance (e.g. uphill), the gear-changing points are shifted towards higher or lower engine-speed ranges.

The accelerator position, driving speed, engine speed, longitudinal and lateral acceleration and the road profile all have an influence on the gear-changing characteristic.

Unwanted upward shifts, e.g. before bends, are prevented by swiftly releasing the accelerator pedal.

Depending on lateral acceleration, upward changes on bends are not made until the engine-speed limit is reached.

Under braking, and depending on the amount of deceleration, the Tiptronic changes down earlier. For subsequent cornering, the right gear is engaged when pressure is applied to the brakes before the bend. The bend is taken in the right gear, and when you accelerate out of the bend you do not have to shift down.

Sport mode switched on

- f Please observe the chapter “SPORT MODE” on Page 71.

If the Sport mode program is switched on, Tiptronic switches to a sporty gear-changing map and shortens the shifting periods. Deceleration downshifts are commenced earlier. Downshifts are already carried out in the case of slight decelerations, even at higher engine speeds.

Driving off

In **2nd gear**, the vehicle moves off with the throttle only slightly open.

Move off in **1st gear** with the throttle open wider or when the engine is cold.

Shifting gears on the steering wheel

With the rocker switches on the steering wheel, you can change temporarily from automatic selection mode **D** to manual mode **M**.

Example:

- Shifting down before bends and on entering built-up areas.
- Shifting down on downward slopes (engine braking).
- Shifting down for brief spurts of acceleration.
- Selecting 1st gear for starting off.

Manual selection mode remains engaged:

- for cornering (depending on the lateral acceleration) and overrunning,
- when the vehicle is stationary (e.g. at a junction).

The system leaves manual selection mode:

- automatically after approx. 8 seconds (unless cornering or overrunning),
- if you depress the accelerator for kickdown,
- after moving off.

Temporary change-down

Conditions:

Speed is higher than approx. 33 mph (54 km/h).

f Rapid acceleration.

The Tiptronic temporarily changes to the sportiest gear-changing map, i.e. to the highest possible gear-changing points. Correspondingly, the transmission shifts down immediately by one or two gears.

Ending the function:

f Release the accelerator markedly (by approx. 25%).

Kickdown

The kickdown function is active in selector lever position **D**, even if you temporarily change to manual mode **M** using the rocker switches on the steering wheel.

f For optimum acceleration, e.g. when overtaking, depress the accelerator pedal beyond the full-throttle point (kickdown).

The transmission shifts down depending on the speed of travel and engine speed. Upward shifts occur at the highest possible engine speeds.

These gear-changing speeds remain active until the accelerator is released to approx. 80% of the full-throttle position.



M - Manual selection mode

The currently selected gear is retained when you change from **D** to **M**.

If you change from **M** to **D**, the gear-changing map suitable for your current driving style is selected and the appropriate gear is chosen.



The kickdown function is not active in manual selection mode "M".

f Therefore shift down manually when accelerating (e.g. to overtake).

Two rocker switches in the upper steering-wheel spokes let you comfortably and reliably select the five forward speeds.

Shifting up

- f Press upper part (+) of a rocker switch.

Shifting down

- f Press lower part (-) of a rocker switch.

Depending on driving speed and engine speed, you can shift up or down at any time.

Gear changes which would exceed the upper or lower engine-speed limit will not be executed by the controller.

You can change down two gears by quickly pressing the rocker switches twice.

If the engine-speed limit is reached, an automatic upward shift is performed or, just before idling speed is reached, a downward shift is performed.

Select an appropriately low gear on upward and downward slopes.
This will ensure optimum use of engine power and engine braking.

PSM switched off and/or Sport mode switched on

- f Please observe the chapter "PORSCHE STABILITY MANAGEMENT (PSM)" on Page 72.
- f Please observe the chapter "SPORT MODE" on Page 71.

If the PSM is switched off and/or Sport mode is switched on, an automatic upshift does not occur when the engine speed limit is reached.

Cancelling upshift suppression

This restriction can be cancelled for one gear change by depressing the accelerator to kick-down. If, for example, the engine speed limit is reached during overtaking and the automatic upshift does not occur, the transmission in this case shifts up by accelerating to kickdown.

- f Depress the accelerator pedal beyond the full-throttle point (kickdown).

Manual mode failure

If manual mode fails, the control electronics switch to automatic mode. In this event, the instrument cluster will display selector lever position **D**.

- f Have the fault remedied at an authorized Porsche dealer.

Stopping

- f For a brief stop (e.g. at a traffic light), leave the selector lever in drive position and hold the vehicle with the brake pedal.
- f For a longer stop with the engine running, select position **N** (neutral) and hold vehicle in position with the foot brake. Select lever position **D** only when the foot brake pedal is depressed.
- f Do not hold the car on a slope using the accelerator. Use the brake pedal or the handbrake instead.
- f Before leaving the vehicle, always apply the handbrake and move the selector lever to position **P**.

Parking

- f Go easy on the accelerator!
- f When parking or maneuvering in a small space, control the speed by careful use of the footbrake.

Driving in winter

In wintry road conditions it is advisable to take steep inclines in manual mode. This prevents the occurrence of gear changes that could cause wheelspin.

Tow-starting, towing

- f Please observe the chapter "TOWING" on Page 281.

Reduced driving program

A transmission fault is indicated by the following symptoms:

- The **4th gear** display on the instrument cluster flashes.
- The warning "Tiptronic emergency run" appears on the on-board computer.
- The transmission no longer shifts.

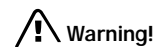

Reverse gear lock monitoring is disabled in the emergency running program. Damage to the vehicle may result as well as loss of control, if the vehicle is moving forward fast enough to cause rear wheel lockup.

- f Do not shift into **R** while the vehicle is moving forward.
-

Proceed as follows in the event of a transmission fault:

1. Stop in a safe place.
2. Move selector lever to position **P**, switch the ignition off and wait for 10 seconds.
3. Start the engine. 2nd gear in selector position **D** and reverse gear **R** are now available.
4. Have the fault seen to immediately at an authorized Porsche dealer.

Mobile Roofs

Lifting/Sliding Roof.....	172
Convertible Top.....	176
Emergency operation of the convertible top	178
Windstop	185
Hardtop.....	189
Roof Transport System.....	195

Lifting/Sliding Roof

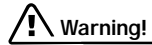

Warning!

Risk of injury when operating or automatically closing the lifting/sliding roof.

- f Take care to ensure that nobody can be injured when the lifting/sliding roof is operated.
- f Always withdraw the ignition key when leaving the vehicle. Uninformed persons (e.g. children) could injure themselves by operating the lifting/sliding roof.
- f In case of danger, release the button immediately and operate the lifting/sliding roof in the opposite direction.



A - Opening the lifting/sliding roof

- f Press rear of rocker switch **A** until lifting/sliding roof reaches the desired position.

One-touch operation

- f Touch rear of rocker switch **A**.
Lifting/sliding roof opens to its end position.
Stop it in any position by touching any button.

Note

The lifting/sliding roof opens until it reaches the best position from the point of view of noise. It can be opened fully, however, if you press the rocker switch again.

Readiness for operation

- When the ignition is switched on (engine switched on or off) **or**
- With doors closed and ignition key withdrawn, but only until a door is first opened.

B - Closing the lifting/sliding roof

- f Press front of rocker switch **B** until lifting/sliding roof reaches the desired position.

One-touch operation

- f Touch front of rocker switch **B**.
Lifting/sliding roof closes to its end position.
Stop it in any position by touching any button.

C - Lifting the lifting/sliding roof

- f Press center of rocker switch **C** until lifting/sliding roof reaches the desired position.

One-touch operation

- f Touch the rocker switch **C** in the center.
Lifting/sliding roof opens to its end position.
Touch button again to stop in any position.

B - Lowering the lifting/sliding roof

- f Press front of rocker switch **B** until lifting/sliding roof reaches the desired position.

Emergency operation

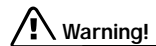

Warning!

Risk of serious personal injury and damage to the lifting/sliding roof during emergency operation.

- f Do not operate the lifting/sliding roof with the rocker switch during and after emergency operation.

Before using emergency operation, please check whether defective fuses are the cause of the malfunction.

- f Please observe the chapter "ELECTRICAL SYSTEM" on Page 254.



Closing the sliding roof

1. Carefully unclip both covers **A** with a screwdriver.
If the car is equipped with HomeLink, the HomeLink buttons must be carefully unclipped instead of the covers.
2. Unscrew the two screws **B**.



3. Fold down the cover of the lifting/sliding roof drive at the rear.
Remove the Allen key (**arrow**) from its holder.
4. Insert the Allen key into the drive axle.

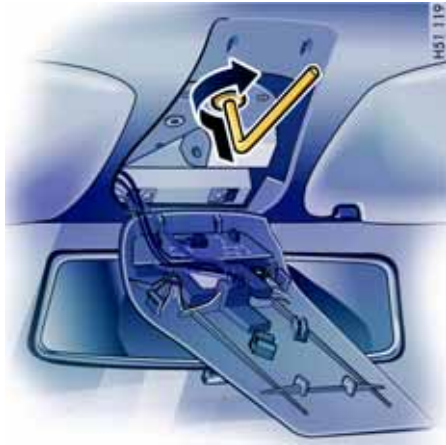

⚠ Caution!

Risk of damage to the lifting/sliding roof.

- f After emergency operation, do not operate the lifting/sliding roof using the rocker switch.
- f Drive slowly to an authorized Porsche dealer in order to have the fault remedied.

5. Press the Allen key into the drive axle, keep it pressed and turn it clockwise until the lifting/sliding roof is closed.
6. Remove the Allen key.
Close the cover and screw in the screws.
7. Have the fault remedied at an authorized Porsche dealer.

Convertible Top

Brief operating instructions can be found on the back side of the driver's sun visor.

- f Please observe the chapter "CAR CARE INSTRUCTIONS" on Page 218.



Warning!

When opening or closing the convertible top, serious personal injury may occur if a person's body parts are near or in the way of the convertible top mechanism's moving parts.

- f Make absolutely sure that nobody can be injured by the convertible-top mechanism or the convertible-top compartment lid.

Do not operate convertible top:

- At temperatures below 32°F (0°C).
- When one side of the car is on a curb, a hoist or a jack.
- When items of luggage or other objects hinder the convertible top movement.
- With the rollbars extended.

- f Avoid frequent operation of the convertible top with the engine off; the vehicle battery would be unintentionally discharged rapidly.
- f Drive only with the convertible top fully open or closed (end positions).
- f When opening or closing the convertible top, ensure there is sufficient clearance above the convertible top (e.g. in the garage).
- f To prevent damp stains and abrasions, only open the convertible top in a dry, clean state.
- f Park your car in the shade whenever possible, as the fabric, rubber material and color can be harmed by long exposure to sunlight.
- f The convertible top may only be actuated during driving on even surfaces.
- f The convertible top must not be used with strong counter wind (over approx. 50 mph/80 km/h).

Door windows and side windows

The side windows are lowered automatically when the convertible top is **opened**. The door windows close automatically if convertible top operation is not interrupted when the convertible top reaches its final position.

When the door windows are closed, the rear side windows can also be closed.

When opening the door windows, the rear windows open automatically.

The side windows are lowered automatically when the convertible top is **closed**. All windows close automatically if convertible top operation is not interrupted when the convertible top reaches its final position.

Preconditions for operation of the convertible top

- The ignition must be switched on (engine running or off),
- the engine compartment lid must be closed,
- the speed must be below approx. 30 mph (50 km/h).
If this maximum speed is exceeded, the opening/closing procedure of the convertible top will be interrupted.

Warning!

Risk of injury and damage when operating the convertible top.

- f Make absolutely sure that nobody can be injured by the convertible-top mechanism or the convertible-top compartment lid.
- f Before opening the convertible top, make sure that there are no objects behind the rear seats.
- f Keep the lids of the make-up mirrors in the sun visors closed when closing the convertible top.
- f In order to abort convertible top operation in the event of danger, immediately release the rocker switch.



Opening convertible top

- f Pull the rocker switch back and hold without interruption until the convertible top is in the final position or until the door windows are in the desired position.
The message on the on-board computer goes out.
In case of danger, release the rocker switch.
Convertible top operation stops.

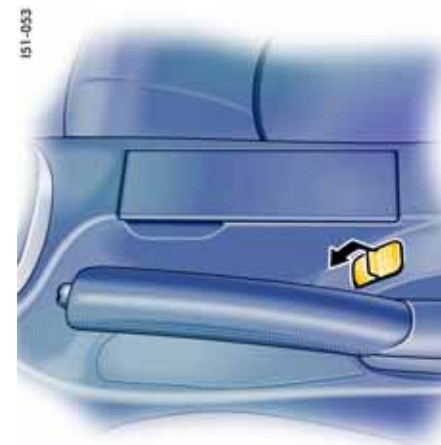

Closing convertible top

- f Push the rocker switch forward and hold without interruption until the convertible top is in the final position or until the door windows are in the desired position.
The message on the on-board computer goes out.
In case of danger, release the rocker switch.
Convertible top operation stops.

f f f



If the convertible top does not lock in the windshield frame

- f Open convertible top again, start the engine and close the convertible top again using the rocker switch.
Assist with the closing process by grasping the convertible top at the handhold and pulling it toward the windshield frame (arrow).

Messages in on-board computer

 **Rear lid**

If the engine compartment lid is open when activating the convertible top, a message appears in the on-board computer. The convertible top cannot be opened.

- f Close engine compartment lid.

 **Convertible top status**

- f Please observe the chapter "WARNINGS ON THE INSTRUMENT PANEL AND THE ON-BOARD COMPUTER" on Page 122.

Emergency operation of the convertible top

- f Before performing emergency operation, please check:
Was the ignition switched on and was the engine compartment lid closed during operation of the convertible top with the rocker switch?
Are electrical fuses defective?
Please observe the chapter "ELECTRICAL SYSTEM" on Page 254.

 **Warning!**

There is danger of injury during emergency operation.

There is danger of crushing or trapping body parts at all movable convertible top parts which could cause serious personal injury.

- f Take great care when performing emergency operation.
- f Do not operate the convertible top during and after emergency operation.

Before emergency operation

- f Remove the ignition key so that the convertible top is not operated unintentionally.
- f Take screwdriver out of the tool kit.
- f Fold the rear seat backrests forward.



Removing rear wall lining

1. Unscrew screws **A** from the rear wall lining. Pull out and reposition the screwdriver insert if necessary.
2. Grasp the rear wall lining at the cut-outs for the safety belts and press downward. Pull rear wall lining forward and lift up and out.

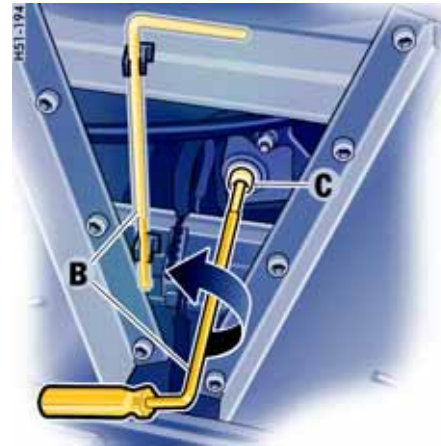

Opening convertible top compartment lid "D"

1. Take red Allen key **B** out of its holder.
2. Put handle of screwdriver onto Allen key **B**. Insert Allen key into the drive axle **C** and turn it counterclockwise (in direction of the arrow) until the convertible top compartment lid **D** is fully open. Remove the Allen key.

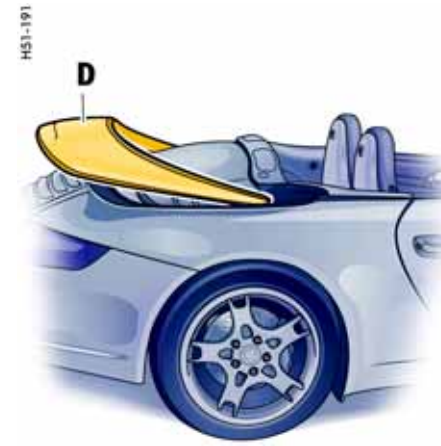

Warning!

The Allen key can rotate or fly out and thereby cause serious personal injury if the convertible top is actuated.

- f Always remove the Allen key **B** from the drive axle **C** before operating the convertible top.

When you have opened the convertible top compartment lid, try to close the convertible top using the rocker switch.

If the convertible top cannot be closed, continue with emergency operation.

f f f



Opening side flaps "F"

1. Remove ignition key.
2. Use the screwdriver to remove plastic lid **E** from the lining from behind.

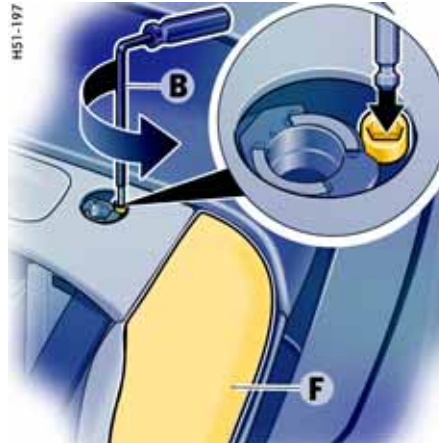

3. Insert Allen key **B** into the drive axle for the left side flap **F**.
Turn Allen key counterclockwise (in direction of arrow) until the side flap **F** is fully open (perceptible stop).
4. Repeat procedure with the right side flap.
Remove the Allen key.

Warning!

The Allen key can rotate or fly out and thereby cause serious personal injury if the convertible top is actuated.

- f Always remove the Allen key **B** from the drive axle of the side flap before operating the convertible top.
-
- f When you have opened the side flaps, try to close the convertible top using the rocker switch.
If the convertible top cannot be closed, continue with emergency operation.

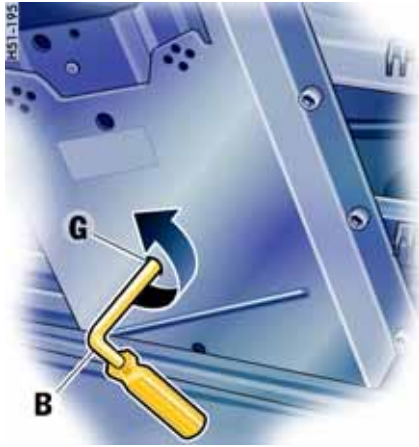

Closing convertible top

1. Insert Allen key **B** through hole **G** and into the hydraulic valve.
Turn Allen key **B** counterclockwise by approx. 1 revolution.
Always remove Allen key **B**.

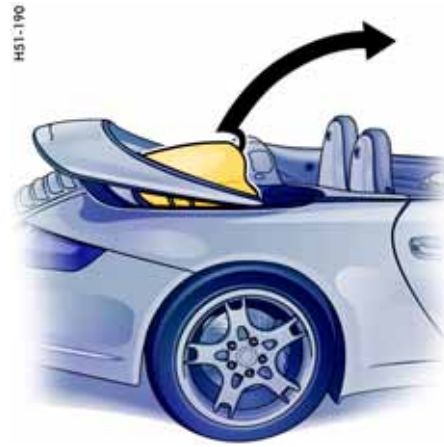

2. Get behind the front seats and grasp the convertible top in the middle.



3. Close the convertible top until it reaches its highest position.

f f f

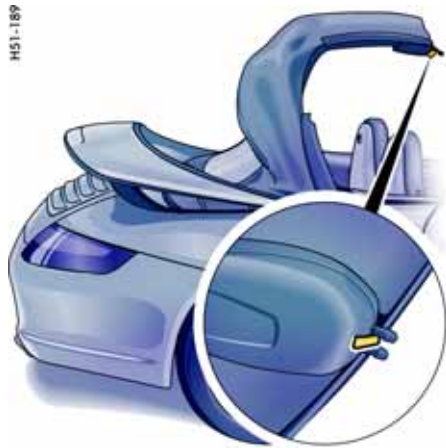

The convertible top lock with the locking hook is fitted on the convertible top.
Perform the work on the convertible top lock when standing on the right-hand side of the vehicle.

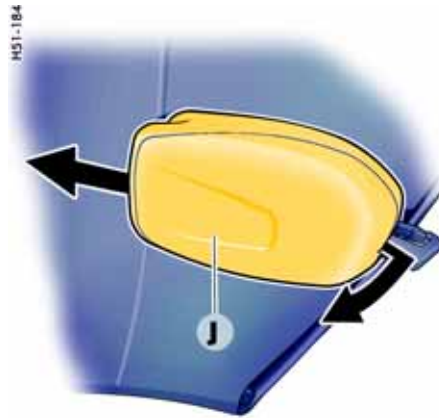

Extending the locking hook "H"

1. Pull the plastic lid **J** down on the front corners.
Push the lid carefully to the rear and take it off.



2. Take the Allen key **K** out of the oddments tray between the front seats.
3. Insert the Allen key **K** into the opening **L** and turn in the direction of arrow "**open**" until marked resistance can be felt.
The locking hook **H** is now extended.
4. Pull out the Allen key **K**.



5. Pull the convertible top all the way forward to the windshield.

Locking the locking hook "H" in the windshield frame

f When locking the convertible top, make sure that the locking hook engages in the windshield frame. Pull the convertible top to the windshield frame if necessary. The centering journals **M** must be retracted into the mounting in the windshield frame.

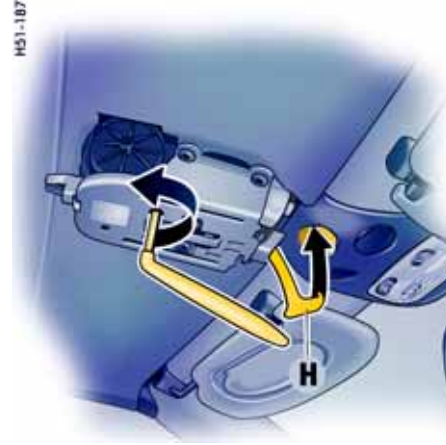

1. Insert the Allen key again. Turn in the direction of arrow "close" until you can feel marked resistance and the convertible top is completely locked.
2. Remove the Allen key.



Mounting the plastic lid

f Push the plastic lid over the convertible top locking mechanism from behind. The lid must engage centred in the guide **N**. Push the lid upwards at its front edge and engage.



Warning!

Risk of injury in an accident.

f Do not drive without the plastic lid mounted.

f f f

H51-192

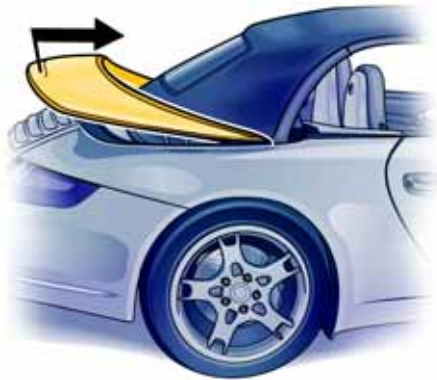

⚠ Caution!

Risk of damage to the convertible top.

- f After emergency operation, do not operate the convertible top using the rocker switch.
 - f Drive slowly to an authorized Porsche dealer in order to have the fault remedied.
-

Closing the convertible-top compartment lid

⚠ Warning!

Risk of pinching when closing the convertible-top compartment lid.

- f Place your hands on the convertible-top compartment lid when pushing.
-
1. Stand behind the vehicle.
 2. Grasp the convertible-top compartment lid above the brake light and push forward against resistance which can be felt until it is completely closed.



Example: Mount for 911 Carrera, 911 Carrera S

Windstop

The windstop is stowed in a protective bag in the luggage compartment.

The protective bag is fastened with a Velcro strip in the luggage compartment.

Caution!

Risk of damage to the windstop

- f Make sure that the windstop is not damaged by items of luggage or objects in the luggage compartment.
- f Do not place any objects on the windstop.
- f Do not store any sharp-edged objects under the installed windstop.
- f Do not damage the windstop during seat adjustment and when folding back the front-seat backrests.
Adjust seat so that the seat backrest does not touch the windstop.
- f Do not fold up the rear seat backrests with the windstop installed.
- f Remove windstop before fitting a hardtop.

Installing the windstop

1. Open zipper of the protective bag.
Take the windstop out of the luggage compartment.

f f f

H51-202



2. Fold the rear seat backrests forward. Please observe the chapter "REAR SEAT BACKRESTS" on Page 39.
3. Unfold the windstop until it can be felt to engage in the hinges at the top and bottom.



4. Check whether the lock of the windstop lower section is engaged. Press lock together if necessary (**arrows**).

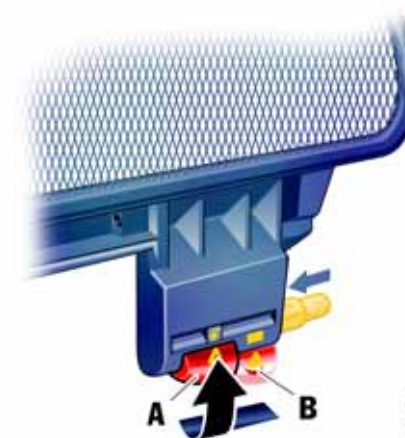

- A** - Lock open
- B** - Lock closed

5. Check whether the two red locking handles are in position **A** (open). Open the lock if necessary. To do this, push the locking handles inward as far as they will go and swivel to the side (**arrow**).

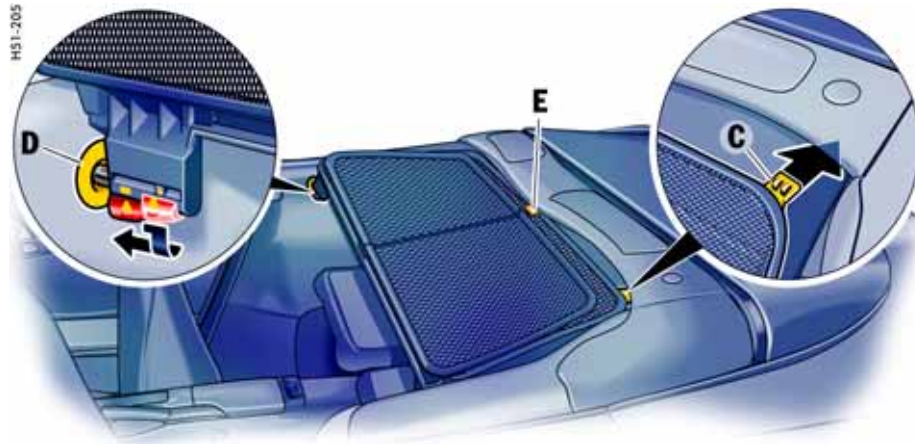

6. Insert fastening tabs **C** of the windstop into the guides of the safety belts. Make sure that the plastic peg **E** engages in the center guide of the windstop.
7. Push red locking handles inward and swivel downward. Spring force pushes the square pins of the locks into the receivers **D** in the side trim panels. Check whether the square pins are correctly engaged.



8. Lift upper section of windstop if required.

f f f

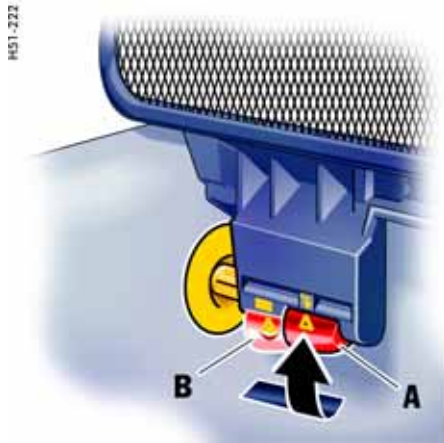

A - Lock open
B - Lock closed

Removing the windstop

1. Fold back upper section of windstop.
2. Move both red locking handles to position **A** (open).
3. Pull windstop out of the guides of the safety belts.

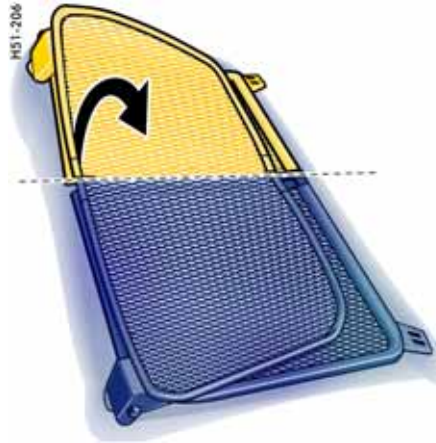

4. Fold the windstop together so that the split windstop lower section is on the outside.
5. Place windstop in the protective bag in the luggage compartment and seal the zipper of the protective bag.
 Please observe the chapter "INSTALLING THE WINDSTOP" on Page 185.

Hardtop

Your authorized Porsche dealer will be glad to give advice about correct hardtop storage.

Since the convertible top stays open for a long time, it must be absolutely dry and clean before being opened to install the hardtop. This prevents damp stains and abrasion damage.

- f Make sure that the hardtop is placed on a clean, soft surface.



Removing the hardtop

1. Open all four side windows.
2. Pull off plastic cover of the front hardtop lock (arrow).

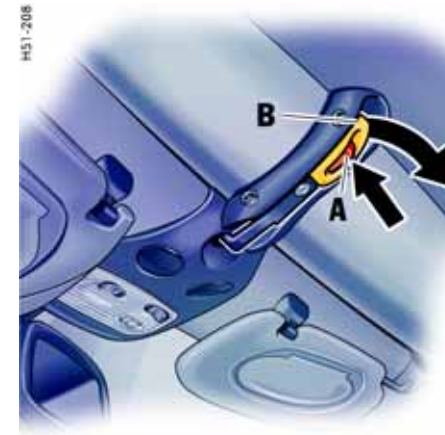

3. Press red locking button **A** of the front locking lever.
Fully open locking lever **B**.

f f f

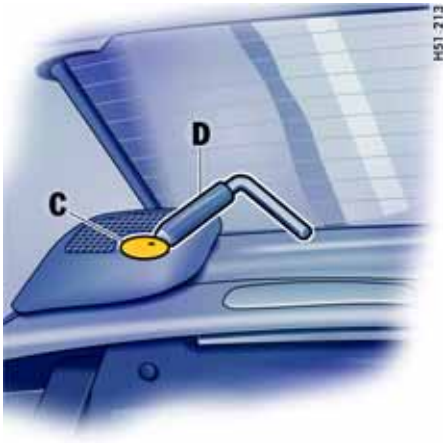

4. Take unlocking handle **D** from the storage tray between the front seats.
5. Position unlocking handle **D** on the dot marking. Carefully remove the plastic covers **C** on both sides of the hardtop.

6. Insert unlocking handle **D** into one of the rear hardtop locks. Unscrew the fastening screw approx. 2 turns, pull off the handle, and completely unscrew the screw by hand (approx. 8 turns).
7. Pull out the fastening screw up to the stop and turn it anticlockwise 2 turns (to prevent damage).
8. Repeat procedure on the other side of the hardtop.

9. Together with a second person on the other side, grasp the hardtop at points **E** and **F**.

Warning!

Danger of pinching fingers or hands at the points "F".

- f Evenly lift the hardtop at both sides.

10. First pull the hardtop rearward and up out of the locking elements. Carefully lift the hardtop up and over the vehicle to the rear.



11. Carefully remove both protection covers **J** to the rear.
12. Fit both plastic covers **C** into the trim panel. The marking point must point to the rear. These covers are also used with the hardtop.
13. Close front locking lever. Push on plastic cover of the front hardtop lock.



Putting on the hardtop

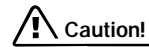

Caution!

Risk of damage to the windstop and hardtop.

- f Always remove the windstop before fitting the hardtop. Please observe the chapter "WINDSTOP" on Page 185.



1. Open all four side windows and convertible top.
2. Take unlocking handle **D** from the storage tray between the front seats. Position unlocking **D** on the point marking.

Carefully remove both plastic covers **C** on both sides of the hardtop.

3. Carefully fit both protective covers **J** into the trim panel from behind.

f f f



4. Pull off plastic cover of the front hardtop lock.



5. Press red lock button of the front locking lever.
Fully open locking lever.

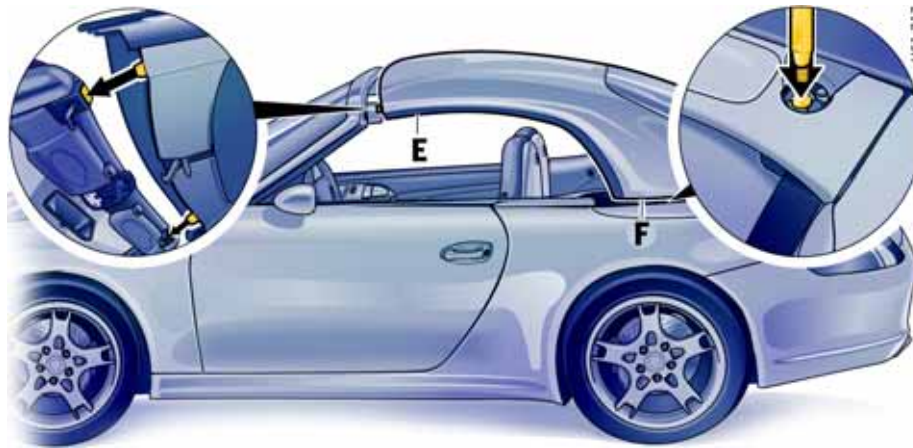

6. Check whether the rear screw connections on the hardtop are loosened (turn it 2 turns clockwise).
7. Together with a second person on the other side, grasp the hardtop at points **E** and **F**.
8. Carefully lift the hardtop up and over the vehicle from behind.

Warning!

Danger of pinching fingers or hands at the points "F".

- f Evenly lower the hardtop at both sides.

9. First push the hardtop completely into the guides on the windshield frame. Then carefully lower the hardtop into the locking elements at the rear.

Caution!

Danger of damage due to inadvertent operation of the convertible top with the hardtop fitted.

- f Make sure that the front locking lever **G** is always correctly locked. This disables the convertible top drive.

f f f



10. Swivel front locking lever **G** to the rear.
The latching hook **H** must engage in the windshield frame (**arrow**).
The white marking line **J** on the red locking button must become visible when the hardtop is locked properly.
11. Push on plastic cover of the front hardtop lock.



12. Tighten the fastening screw by hand.
Then tighten the fastening screw with the unlocking handle **D** (tightening torque 34 ftlb. (46 Nm)).
13. Repeat procedure on the other side of the hardtop.

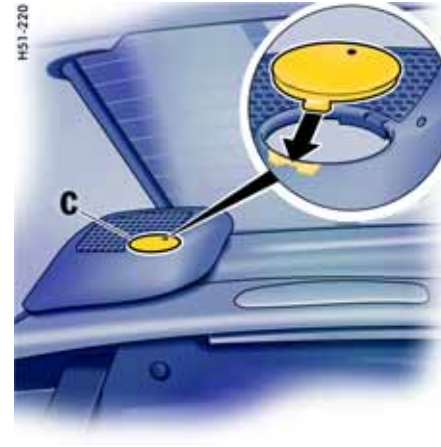

14. Fit both plastic covers **C** into the trim panels of the rear hardtop locking elements so that the marking points are opposite each other.
15. Store unlocking handle in storage tray between the front seats.

Roof Transport System

(Coupé only)

- f Please follow the separate instructions for fitting the Roof Transport System.
- f Only use Roof Transport Systems from the Porsche Tequipment product range or Roof Transport Systems which have been tested and approved for your car by Porsche. Fitting normal commercially available luggage racks is not possible.

The **Porsche Roof Transport System** allows you to carry various sports and hobby equipment. Your authorized Porsche dealer will be pleased to tell you about the various different uses of the Roof Transport System.

Safety notes!

- f Completely remove the Roof Transport System before using an automatic car wash – risk of damage to the vehicle!
- f Do not exceed the maximum permitted payload, the maximum permitted gross weight and the maximum permitted axle loads. Please observe the chapter “WEIGHTS COUPÉ” on Page 292.
- f Distribute load evenly, with heavy items as low as possible. Items of luggage must not project beyond the side of the load area.
- f Fix and secure every item to the basic carrier with a rope or lashing strap (do not use elastic rubber tensioners).
- f Before every journey, and at regular intervals during long trips, check that Roof Transport System and load are secure. Re-tighten if necessary and secure additionally by locking.

When the Roof Transport System is loaded, the maximum speed depends on the nature, size and weight of the load being carried.

Driving, braking and steering behavior change due to the higher center of gravity and the greater wind-resistant area. You should adapt your driving style appropriately.

Since fuel consumption and noise are increased with the Roof Transport System fitted, it should not remain on the vehicle if not in use.

Maintenance, Car Care

Exercise Extreme Caution when Working on your Vehicle	198
Coolant Level	199
Engine Oil	201
Engine Oil Level	201
Engine Oil Recommendation	203
Brake Fluid Level	205
Fuel Economy	207
Operating Your Porsche in other Countries..	207
Fuel Recommendations	209
Portable Fuel Containers	210
Emission Control System	211
How Emission Control Works	212
Fuel Evaporation Control	213
Washer Fluid	213
Power Steering	214
Air Filter	215
Combination Filter	215
Manual Transmission Oil	215
Automatic Transmission Fluid	215
Wiper Blades	216
Car Care Instructions	218

Exercise Extreme Caution when Working on your Vehicle



Danger!

Ignoring the following instructions may cause serious personal injury or death.

- f The engine compartment of any motor vehicle is a potentially hazardous area. If you are not fully familiar with proper repair procedures, do not attempt the adjustments described on the following pages.
This caution also applies to the entire vehicle.
- f Only work on your vehicle outdoors or in a well ventilated area.
- f Ensure that there are no open flames in the area of your vehicle at any time when fuel fumes might be present. Be especially cautious of such devices such as hot water heaters which ignite a flame intermittently.
- f Before working on any part in the engine compartment, turn the engine off and let it cool down sufficiently. Hot engine compartment components can burn skin on contact.
- f Be alert and cautious around engine at all times while the engine is running.
If work has to be performed with the engine running, always set the parking brake, and make sure the shift lever is in neutral position or the selector lever in position **P**.
- f In particular, be very careful to ensure that items of clothing (ties, shirt, sleeves etc.), jewelry, long hair, hand or fingers cannot get caught in the engine-compartment blower, fan, belts or other moving parts.
The radiator and radiator fans are in the front of the car.
The engine-compartment blower is mounted on the engine-compartment lid.
The engine-compartment blower can start or continue running as a function of temperature, even with the engine switched off.
Carry out work in these areas only with the engine off, the ignition switched off, and exercise extreme caution.
- f Your Porsche is equipped with an electronic ignition system. When the ignition is on, high voltage is present in all wires connected with the ignition system; therefore, exercise extreme caution when working on any part of the engine while the ignition is on or the engine is running.
- f Always support your car with safety stands if it is necessary to work under the car.
- f When working under the car without safety stands but with the wheels on the ground, make sure the car is on level ground, the wheels are blocked, and that the engine cannot be started.
Remove the ignition key.
- f Do not smoke or allow an open flame around the battery or fuel.
Keep a fire extinguisher in close reach.
- f Incomplete or improper servicing may cause problems in the operation of the car. If in doubt about any servicing, have it done by your authorized Porsche dealer.
Improper maintenance during the warranty period may affect your Porsche warranty coverage.
- f Supplies of fluids, e.g. engine oil, brake fluid or coolant, are hazardous to your health.
Keep these fluids out of children's reach and dispose of them in accordance with the appropriate regulations.
- f Some countries require additional tools and special spare parts to be carried.
Please make enquiries before driving abroad.

Power measurements

Power measurements on dynamometers are not approved by Porsche.



Coolant Level

- f Please observe the chapter "EXERCISE EXTREME CAUTION WHEN WORKING ON YOUR VEHICLE" on Page 198.

The cooling system is filled at the factory with a permanent coolant. It provides year-round protection from corrosion and freezing down to $-31^{\circ}\text{F}/-35^{\circ}\text{C}$.

- f Only use antifreeze authorized by Porsche.

Checking coolant level

The expansion tank with its filler orifice is in the engine compartment.

- f Check the coolant level regularly through the transparent expansion tank.

When the engine is cold and the car is level the fluid level must lie between the "MIN" and "MAX" markings.

Topping off coolant



Warning!

Danger of serious personal injury from scalding. Coolant is hazardous to your health, and may be fatal if swallowed.

- f Do not open the cap of the expansion tank while the engine is hot.
- f Allow the engine to cool down before opening the cap and protect your hands, arms and face from any possible escape of hot coolant.
- f Keep coolant out of children's reach.
- f Also, keep coolant away from your pets. They can be attracted to it should there be a spill, or to used coolant left in an open container. Coolant can be deadly to pets if consumed.

1. Switch engine off and let it cool. Please observe the chapter "COOLING SYSTEM" on Page 92.
2. Cover the expansion tank cap with a thick rag. Open cap slowly and carefully and allow overpressure to escape. Then unscrew cap completely.
3. Only add a mixture of antifreeze and water in equal parts, and do not exceed the "MAX" mark.

Antifreeze in coolant:

50% gives protection down to $-31^{\circ}\text{F}/-35^{\circ}\text{C}$

60% gives protection down to $-58^{\circ}\text{F}/-50^{\circ}\text{C}$

4. Screw cap firmly on.

If in an emergency pure water has been added, the mix ratio must be corrected at an authorized Porsche dealer.

Marked loss of coolant indicates leakage in the cooling system. The cause should immediately be remedied at an authorized Porsche dealer.

f f f

Engine-compartment blower, radiator fan

The radiator and radiator fans are in the front of the car.

The engine-compartment blower is mounted on the engine compartment lid.

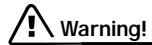

Risk of injury.

After the engine is switched off, the engine-compartment temperature is monitored for approx. 30 minutes.

During this period, and depending on temperature, the engine-compartment blower may continue to run or start to run.

- f Carry out work in these areas only with the engine off, the ignition off, and exercise extreme caution.

Risk of injury. The radiator fans in the front end of the car may be operating or unexpectedly start operating when the engine is switched on.

- f Carry out work in these areas only with the engine switched off.
-

Engine Oil

Engine oil consumption

It is normal for your engine to consume oil. The rate of oil consumption depends on the quality and viscosity of oil, the speed at which the engine is operated, the climate, road conditions as well as the amount of dilution and oxidation of the lubricant.

If the vehicle is used for repeated short trips, and consumes a normal amount of oil, the engine oil measurement may not show any drop in the oil level at all, even after 600 miles (1,000 km) or more. This is because the oil is gradually becoming diluted with fuel or moisture, making it appear that the oil level has not changed.

The diluting ingredients evaporate out when the vehicle is driven at high speeds, as on an expressway, making it then appear that oil is excessively consumed after driving at high speeds.

If the conditions you drive your vehicle in are dusty, humid, or hot, the frequency of the oil change intervals should be greater.

If the vehicle is driven at a high rate of speed, climatic conditions are warm, and the load is high, the oil should be checked more frequently, as driving conditions will determine the rate of oil consumption.

- The engine in your vehicle depends on oil to lubricate and cool all of its moving parts. Therefore, the engine oil should be checked regularly and kept at the required level.
- Make it a habit to have the engine oil level checked at every fuel filling.
- The oil pressure warning light is not an oil level indicator. The oil pressure warning light indicates serious engine damage may be occurring when lit, if engine rpm is above idle speed.

Engine Oil Level

- f Please observe the chapter “EXERCISE EXTREME CAUTION WHEN WORKING ON YOUR VEHICLE” on Page 198.
- f Regularly check the oil level using the on-board computer after the vehicle is refuelled. Please observe the chapter “OIL DISPLAY AND MEASUREMENT OF THE ENGINE OIL LEVEL” on Page 118.

The difference between the minimum and maximum marks on the segment display is approx. 1.2 liters.

Each segment of the display corresponds to approx. 0.4 liter.

f f f

Topping off engine oil

Warning!

Risk of burning from hot parts in engine compartment. Risk of injury by rotating parts. The engine compartment blower on the engine compartment lid can start up even with engine off.

- f Exercise extrem caution when working in the engine compartment.
- f Top off engine oil only with the engine off.

Engine oil is hazardous to your health and may be fatal if swallowed.

- f Keep engine oil out of children's reach.

Used engine oil contains chemicals that have caused cancer in laboratory animals.

- f Always protect your skin by washing thoroughly with soap and water.



1. The on-board computer indicates how much oil must be added.
2. Pull oil filler tube upwards out of its holder.

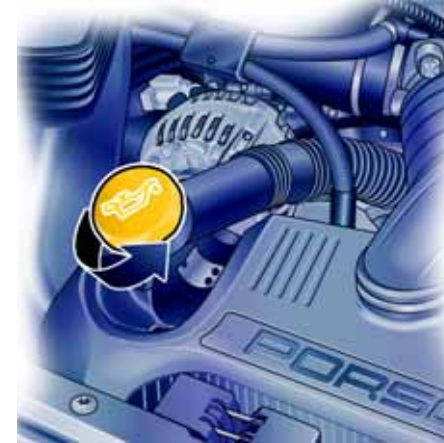

3. Unscrew cap of the oil filler opening.
4. Add at most 0,5 quarts (0,5 liter) of engine oil at a time.
5. Measure oil level again with the on-board computer.
6. Add more engine oil if necessary. **Never add more engine oil than required to reach the max. mark.**
7. Carefully close cap of the oil filler opening.
8. Push oil filler tube into its holder until it snaps into place.

Engine Oil Recommendation

Recommended oil viscosity ranges dependent on ambient temperatures

Ambient temperature seasonal	SAE Viscosity Range engine oils
generally above $-13^{\circ}\text{F}/-25^{\circ}\text{C}$	SAE 0W-40, 5W-40, 5W-50 approved by Porsche
generally below $-13^{\circ}\text{F}/-25^{\circ}\text{C}$	SAE 0W-40 approved by Porsche

🔧 Use only engine oils approved by Porsche.

If in doubt ask your authorized Porsche dealer for Porsche tested and approved all-season oils.

Oil change

The engine oil has to be changed at the intervals listed in your **Maintenance Schedule**.

f Please observe the chapter "CAPACITIES" on Page 291.

We recommend that you have the engine oil changed at your Porsche dealer, who has the required oils and the necessary filling equipment.

If you suspect an oil leak in the engine have your dealer check it out immediately.

All current engine oils are compatible with each other, i. e. when making an oil change it is not necessary to flush the engine if you wish to use a different brand or grade of oil.

Since, however, each brand of oil has a special composition, you should, if possible, use the same oil brand if it becomes necessary to top up between oil changes.

Porsche engines have long intervals between oil changes. You can make best use of these long oil change intervals by using multigrade oils since these are largely independent of seasonal fluctuations in temperature.

If your vehicle is used frequently in stop-and-go traffic in cold weather, the engine will not always be properly warmed up.

Condensation from products of combustion may accumulate in the oil. In this case, it is advisable to change the oil more frequently so that your engine once again has 100% efficient engine oil.

Engine oil performance class

Engine oil is not only a lubricant, but also serves to keep the engine clean, to neutralize the dirt which penetrates into the engine through combustion and to protect the engine against corrosion. To perform these functions, the oil is provided with additives which have been specially developed for these functions.

The efficiency of an oil is expressed, for example, by the API, ILSAC or ACEA classifications.

Viscosity

Like all liquids, engine oil is viscous when cold, and thin-bodied when warm. The viscosity of an oil is expressed by its SAE class. For cold viscosity (measured at temperatures below 32°F/0°C) the SAE class is given as a number and the letter "W" (as in winter), for hot viscosity (measured at 212°F/100°C) the SAE class is given only as a number.

The viscosity of an oil is, therefore, always the same if it has the same number of an SAE class.

Oils with two viscosities are called multigrade oils; oils with only one viscosity are termed single-grade oils.

Single-grade oils can not be used in your engine.

The viscosity of the engine oil for your Porsche has to be chosen according to the ambient temperature given in the engine oil recommendation table.

Brake Fluid Level

f Please observe the chapter "EXERCISE EXTREME CAUTION WHEN WORKING ON YOUR VEHICLE" on Page 198.

f Use only new (unused) Original Porsche brake fluid.

 **Warning!**

Brake fluid is hazardous to your health, and may be fatal if swallowed.

Brake fluid also attacks paintwork.

f Keep brake fluid out of children's reach.

f Take care while topping off brake fluid not to soil the luggage compartment or items of luggage.



Example: 911 Carrera, 911 Carrera S

Checking the brake fluid level

The reservoir for the hydraulic braking and clutch systems is located in the luggage compartment.

1. Open and remove cover flap **A**.
2. Regularly check the brake-fluid level on the transparent expansion tank through the window **B**.
The fluid level should always lie between the minimum and maximum marks.

A slight decrease in the fluid level due to wear and automatic readjustment of the disc brakes is normal.

If, however, the fluid level falls markedly or below the minimum mark, the braking system may have developed a leak.

f Have the brake system checked without delay at an authorized Porsche dealer.

Changing the brake fluid

Brake fluid absorbs moisture from the air over time. This accumulation of water lowers the boiling point and, under certain operating conditions, can affect the braking action.

Therefore have the brake fluid changed in accordance with the change intervals stated in the brochure "Maintenance".

BRAKE Warning light USA

Warning light Canada

- The warning lights on the instrument panel and on the on-board computer indicate an insufficient brake fluid level.
- If the warning light lights up on the instrument panel and the warning message appears on the on-board computer in combination with a larger pedal travel, a brake circuit may have failed.

If the warning lights should light up whilst driving:

- f Stop immediately in a suitable place.
- f Do not continue driving.
Consult an authorized Porsche dealer.

Fuel Economy

Fuel economy will vary depending on where, when and how you drive, optional equipment installed, and the general condition of your car.

A car tuned to specifications and correctly maintained, will help you to achieve optimal fuel economy.

- f Have your vehicle tuned to specifications.
 - Air cleaner should be dirt free to allow proper engine “breathing”.
 - Battery should be fully charged.
 - Wheels should be properly aligned.
 - Tires should be inflated at correct pressure.
- f Always monitor your fuel consumption.
- f Drive smoothly, avoid abrupt changes in speed as much as possible.
- f Avoid jack rabbit starts and sudden stops.
- f Do not drive longer than necessary in the lower gears. Shifting into a higher gear early without lugging the engine will help save fuel.
- f Prolonged “warm up” idling wastes gas. Start the vehicle just before you are ready to drive. Accelerate slowly and smoothly.
- f Switch off the engine if stationary for longer periods.

- f Any additional weight carried in the vehicle reduces fuel economy. Always keep cargo to a minimum and remove all unnecessary items.
- f Organize your trips to take in several errands in one trip.
- f All electrical accessories contribute to increased fuel consumption.
- f Only switch on the air conditioning when necessary.
- f Do not drive with the Roof Transport System mounted unless you need it.

The EPA estimated m.p.g. is to be used for comparison purposes, actual mileage may be different from the estimated m.p.g., depending on your driving speed, weather conditions and trip length. Your actual highway mileage will probably be less than the estimated m.p.g.

- f Please observe all local and national speed limits.

Operating Your Porsche in other Countries

Government regulations in the United States and Canada require that automobiles meet specific emission regulations and safety standards. Therefore, cars built for the U.S. and Canada differ from vehicles sold in other countries.

If you plan to take your Porsche outside the continental limits of the United States or Canada, there is the possibility that

- unleaded fuel may not be available;
- unleaded fuel may have a considerably lower octane rating. Excessive engine knock and serious damage to both engine and catalytic converters could result;
- service may be inadequate due to lack of proper service facilities, tools or diagnostic equipment;
- replacement parts may not be available or very difficult to get.

Porsche cannot be responsible for the mechanical damage that could result because of inadequate fuel, service or parts availability.

If you purchased your Porsche abroad and want to bring it back home, be sure to find out about shipping and forwarding requirements, as well as current import and customs regulations.

Fuel

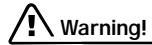

Warning!

Fuel is highly flammable and harmful to health.

- f Fire, open flame and smoking are prohibited when handling fuel.
- f Avoid contact with skin or clothing.
- f Do not inhale fuel vapors.

To prevent damage to the emission control system and engine:

- f Never drive the tank completely out of fuel.
- f Avoid high cornering speeds after the warning lights have come on.

-
- f Please observe the chapter "EMISSION CONTROL SYSTEM" on Page 211.
Please observe the chapter "FUEL ECONOMY" on Page 207.
Please observe the chapter "LEVEL GAUGE" on Page 94.

Check engine warning light

If the warning lights in the instrument panel and on-board computer come on and remain on while driving, it suggests:

- an improperly fastened tank cap **or**
- refuelling with engine running.



Opening the filler flap

The filler opening is under the filler flap in the front right fender.

- f With the vehicle unlocked, press on the front part of the filler flap (**arrow**) to open the flap.

The filler flap is centrally locked along with the other locks.



If there is a defect in the automatic unlocking system:

- f Open the passenger door.
- f Pull the ring in the right-hand door aperture (**arrow**).



Refuelling

Fuel tank capacity is listed under "Capacities". Porsche does not recommend the use of fuel additives.

Fuel is highly flammable and harmful to health.

f Please observe the chapter "CAPACITIES" on Page 291.

1. **Important:** Stop the engine and switch off the ignition.
2. Slowly unscrew the tank cap. Hang the tank cap on the plastic strap of the filler flap.
3. Insert fuel-hose nozzle fully into the filler neck with the handle of the fuel-hose nozzle facing down.
4. Do not add further fuel once the correctly operated automatic fuel-hose nozzle has switched off. Fuel could spray or could run over in warm temperatures.
5. Replace the tank cap immediately after refuelling and turn it until you hear it and feel it engage.

If you lose the tank cap, you must replace it only with an original part to reduce the possibility of a fire in the event of a collision.

Note

The oil level is automatically measured during refuelling.

f Please observe the chapter "OIL DISPLAY AND MEASUREMENT OF THE ENGINE OIL LEVEL" on Page 118.

Fuel Recommendations

Your Porsche is equipped with catalytic converters and must use **UNLEADED FUEL ONLY**.

Your engine is designed to provide optimum performance and fuel economy using unleaded premium fuel with an octane rating of **98 RON (93 CLC or AKI)**. Porsche therefore recommends the use of these fuels in your vehicle.

Porsche also recognizes that these fuels may not always be available. Be assured that your vehicle will operate properly on unleaded premium fuels with octane numbers of at least **95 RON (90 CLC or AKI)**, since the engine's "Electronic Oktan™ knock control" will adapt the ignition timing, if necessary.

The use of UNLEADED FUEL ONLY is critically important to the life of the catalytic converters. Deposits from leaded fuels will ruin the converters and make it ineffective as an emission control device.

Cars with catalytic converters have a smaller fuel tank opening, and gas station pumps have smaller nozzles. This will prevent accidental pumping of leaded fuel into cars with catalytic converters.

Unleaded fuels may not be available outside the continental U.S. and Canada. Therefore, we recommend you do not take your car to areas or countries where unleaded fuel may not be available.

Octane ratings

Octane rating indicates a fuel's ability to resist detonation. Therefore, buying the correct octane gas is important to prevent engine "damage".

The RON octane rating is based on the research method. The CLC (U.S. Cost of Living Council octane rating) or AKI (antiknock index) octane rating usually displayed on U.S. fuel pumps is calculated as research octane number plus motor octane number, divided by 2, that is written as:

$$\frac{\text{RON} + \text{MON}}{2} \quad \text{or} \quad \frac{\text{R} + \text{M}}{2}$$

The CLC or AKI octane rating is usually lower than the RON rating:

For example: 95 RON equals 90 CLC or AKI

Fuels containing alcohol and ether

Some areas of the U.S. require oxygenated fuels during certain portions of the year. Oxygenated fuels are fuels which contain alcohols (such as methanol or ethanol) or ether (such as MTBE).

Under normal conditions, the amount of these compounds in the fuel will not affect driveability.

You may use oxygenated fuels in your Porsche, provided the octane requirements for your vehicle are met. We recommend, however, to change to a different fuel or station if any of the following problems occur with your vehicle:

- Deterioration of driveability and performance.
- Substantially reduced fuel economy.
- Vapor lock and non-start problems, especially at high altitude or at high temperature.
- Engine malfunction or stalling.

Fuels containing MMT

Some North American fuels contain an octane enhancing additive called methylcyclopentadienyl manganese tricarbonyl (MMT).

If such fuels are used, your emission control system performance may be negatively affected.

The check engine warning light on your instrument panel may turn on.

If this occurs, Porsche recommends you stop using fuels containing MMT.

Portable Fuel Containers



Portable fuel containers, full or partially empty, may leak causing an explosion, or result in fire in case of an accident.

- f Never carry additional fuel in portable containers in your vehicle.

Emission Control System

In the interest of clean air

Pollution of our environment has become a problem that is of increasing concern to all of us. We urge you to join us in our efforts for cleaner air in controlling the pollutants emitted from the automobile.

Porsche has developed an emission control system that controls or reduces those parts of the emission that can be harmful to our environment. Your Porsche is equipped with such a system.

Porsche warrants the Emission Control System in your new car under the terms and conditions set forth in the Warranty Booklet.

You, as the owner of the vehicle, have the responsibility to provide regular maintenance service for the vehicle and to keep a record of all maintenance work performed. To facilitate record keeping, have the service performed by authorized Porsche dealers. They have Porsche trained technicians and special tools to provide fast and efficient service.

To assure efficient operation of the Emission Control System:

- f Have your vehicle maintained properly and in accordance with the recommendations described in your Maintenance Booklet. Lack of proper maintenance, as well as improper use of the vehicle, will impair the function of the emission control system and could lead to damage.
- f Do not alter or remove any component of the emission control system.
- f Do not alter or remove any device, such as heat shields, switches, ignition wires, valves, etc., which are designed to protect your vehicle's emission control system. In addition to serious engine damage, this can result in a fire if excess raw fuel reaches the exhaust system.
- f Do not continue to operate your vehicle if you detect engine misfire or other unusual operating conditions.

Parking



Danger of fire.

- f Do not park or operate the vehicle in areas where the hot exhaust system may come in contact with dry grass, brush, fuel spill or other flammable material.
 - f If your car catches on fire for any reason, call the fire department. Do not endanger your life by attempting to put out the fire.
-

Undercoating



Danger of fire and serious personal injuries or death.

- f Do not apply additional undercoating or rust-proofing on or near the exhaust manifold, exhaust pipes, catalytic converters or heat shields. During driving the substance used for undercoating could overheat and ignite.
-

How Emission Control Works

When an automobile engine is running, it uses energy generated through the combustion of a mixture of air and fuel. Depending on whether a car is driven fast or slowly or whether the engine is cold or hot, some of the fuel (hydrocarbons) may not be burned completely, but may be discharged into the engine crankcase or exhaust system. Additional hydrocarbons may enter the atmosphere through evaporation of fuel from the fuel tank. These hydrocarbons (HC), when released into the air, contribute to undesirable pollution.

In addition, carbon monoxide (CO) and oxides of nitrogen (NOx) contribute to engine emissions. They, too, are formed during the combustion process and discharged into the exhaust system.

To reduce these pollutants, your Porsche is equipped with a precisely calibrated fuel injection system to assure a finely balanced air/fuel mixture under all operating conditions.

Oxygen sensor

The oxygen sensor, installed in the exhaust pipe continuously senses the oxygen content of the exhaust and signals the information to an electronic control unit. The control unit corrects the air/fuel ratio, so the engine always receives an accurately metered air/fuel mixture.

Crankcase ventilation

Through crankcase ventilation, undesirable emissions from the engine crankcase are not permitted to reach the outside atmosphere. These emissions are recirculated from the crankcase to the air intake system. From here the emissions mix with the intake air and are later burned in the engine.

Catalytic converters

The catalytic converters are efficient "clean-up" devices built into the exhaust system of the vehicle. The catalytic converters burn the undesirable pollutants in the exhaust gas before it is released into the atmosphere.

The exclusive use of unleaded fuel is critically important for the life of the catalytic converters. Therefore, only unleaded fuel must be used.

The catalytic converters will be damaged by:

- push or tow starting the vehicle
 - misfiring of the engine
 - turning off the ignition while the vehicle is moving or
 - driving until the fuel tank is completely empty
 - by other unusual operating conditions.
- f Do not continue to operate your vehicle under these conditions, since raw fuel might reach the catalytic converters. This could result in overheating of the converters. Federal law prohibits use of leaded fuel in this car.

Fuel Evaporation Control

Fuel tank venting

The evaporation chamber and the carbon canister prevent fuel from escaping to the atmosphere at extreme high outside temperatures, when driving abruptly around curves and when the car is parked at an incline or in any other nonlevel position.

Vapor control system and storage

When the fuel tank is filled, vapors are collected in the evaporation chamber by a vent line leading the vapors to the carbon canister where they are stored as long as the engine does not run.

Purge system

When the engine is running, the fuel vapors from the canister will be mixed with fresh air from the ambient air of the canister. This mixture will be directed to the intake air housing by the tank vent line, mixed with the intake air and burned during normal combustion.

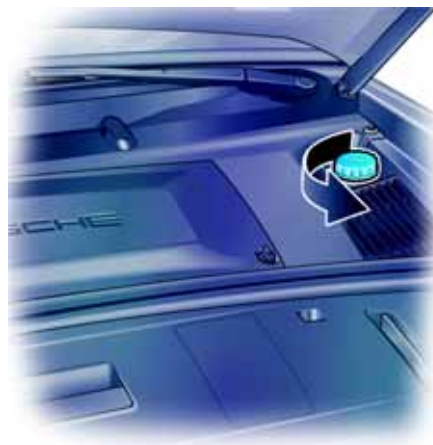

Washer Fluid

The reservoir, with a blue screw cap, is in the luggage compartment, to the rear left.

Capacity

- Without headlight cleaning system: approximately 2.6 quarts (2.5 liters).
- With headlight cleaning system: approximately 6.3 quarts (6.0 liters).

Topping off washer fluid

Clean water is generally not enough to clean the windshield and headlights. Depending on the season, mix the water with winter cleaner giving antifreeze protection or a summer cleaner. Follow the instructions for the mixing ratio.

- f Only use cleaner fluids authorized by Porsche.
- 1. Please note all the information on the refill container of the cleaning agent.
- 2. Open cap of the washer-fluid reservoir.
- 3. Top up washer fluid and close cap properly.
- f Do not use engine coolant anti-freeze or any other solution that can damage the car's paint, in the washer reservoir.



Warning light

If less than 0.52 quarts (0.5 liter) remains, a warning message appears on the on-board computer.

- f Add washer fluid.



Power Steering

Power steering is assisted by hydraulic auxiliary forces.

The hydraulic fluid reservoir is located in the engine compartment.

Note

The flow noise heard at full steering lock is design-related and does not indicate a defect in the steering system.

Warning!

Risk of accident.

When the engine is stopped (e.g. when being towed) or the hydraulic system fails, there is no assistance for steering.

Therefore, substantially more force will have to be exerted in order to steer.

- f Exercise great care when being towed.
- f Have the fault remedied at your nearest authorized Porsche dealer.

Checking hydraulic fluid

- f Please observe the chapter "EXERCISE EXTREME CAUTION WHEN WORKING ON YOUR VEHICLE" on Page 198.
- f Only use hydraulic fluid authorized by Porsche. Specification:
Please observe the chapter "CAPACITIES" on Page 291.

Check the fluid level with the engine stopped and **cold** (approximately 68°F/20°C).

1. Open the engine compartment lid.
2. Open the reservoir cap.
3. Wipe measuring rod.
Close cap and reopen. The fluid level should lie in the area below the "Cold" marking.
Add hydraulic fluid if necessary.
4. Close cap carefully.
Close engine compartment lid.

Noticeable loss of fluid indicates leakage in the system.

The cause should be remedied immediately at an authorized Porsche dealer.

Air Filter

A dirty air filter not only reduces engine performance, but can lead to premature engine wear.

Regular filter replacement is part of the routine maintenance service.

- f In dusty conditions, check the filter element more frequently and replace if necessary.

Combination Filter

The fresh air passing through the combination filter into the passenger compartment is virtually free of dust, pollen, and unpleasant odors.

- f If the outside air is polluted by exhaust fumes, press the circulating-air button.

A dirty filter can be the cause of reduced air flow:

- f Have filter replaced by your authorized Porsche dealer.

Regular filter replacement is part of the routine maintenance service.

Manual Transmission Oil

The transmission oil has to be checked and changed at the intervals listed in your Maintenance Schedule.

- f Please observe the chapter "CAPACITIES" on Page 291.

We recommend that you have the transmission oil changed at your Porsche dealer, who has the required lubricants and the necessary filling equipment.

If you suspect an oil leak in the transmission, have your authorized Porsche dealer check it out immediately.

Automatic Transmission Fluid

The torque converter and the transmission are lubricated with Automatic Transmission Fluid (ATF). The final drive requires transmission oil. See "Capacities".

Do not tow the car or run the engine without ATF in the transmission. The automatic transmission may be damaged by even a tiny speck of dirt, only a clean funnel or spout must be used when adding ATF.

The ATF and transmission oil has to be checked and changed at the intervals listed in your Maintenance Schedule.

We recommend that you have the ATF and transmission oil changed at your Porsche dealer, who has the required lubricants and the necessary filling equipment.

If you suspect an oil leak in the transmission, have your authorized Porsche dealer check it out immediately.

Wiper Blades

- f When wiper performance deteriorates, replace the wipers.
- f Please observe the chapter "CAR CARE INSTRUCTIONS" on Page 218.

Caution!

Risk of damage if the wiper arm accidentally falls back on to the window.

- f Always hold the wiper arm securely when replacing the wiper blade.

Risk of damage if wiper blades that are frozen in place are loosened improperly.

- f Thaw the wiper blades before loosening them.

Maintenance note

If the wiper blades rub or squeak, this can be as a result of the following:

- If the vehicle is washed in an automatic car wash, residues may adhere to the windshield. These residues can only be removed using a special cleaning solution. Please contact your authorized Porsche dealer for further information.
 - The wiper blades may be damaged.
- f Replace damaged wiper blades as soon as possible.

Changing windshield wiper blades

Caution!

Risk of damage.

If a wiper blade is not changed properly, it can come loose when the car is moving.

- f Check whether the wiper blade is seated securely. The wiper blade must engage the wiper arm properly.

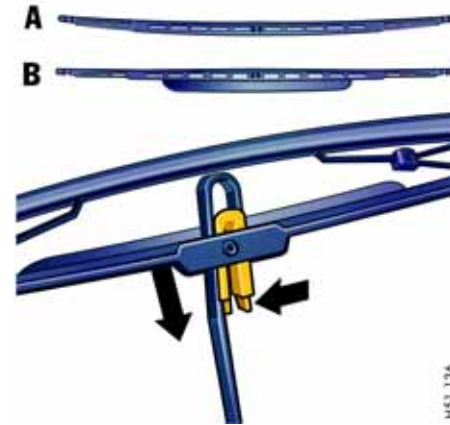

A - Passenger's side, curved wiper blade
B - Driver's side, wiper blade with spoiler

1. Apply the handbrake.
2. Switch the wipers off (position **0**) and remove the ignition key.
3. Fold windshield wiper arm away from the windshield.
4. Press together the plastic spring of the wiper blade (**right arrow**). Pull wiper blade out of wiper arm.

5. Insert new wiper blade until you feel it engage.
Ensure that the new wiper blade is inserted into the wiper arm in the same position:
 - direction of the spoiler on the driver side,
 - curvature on the passenger side.
6. Carefully fold wiper arm back onto the wind-
shield.

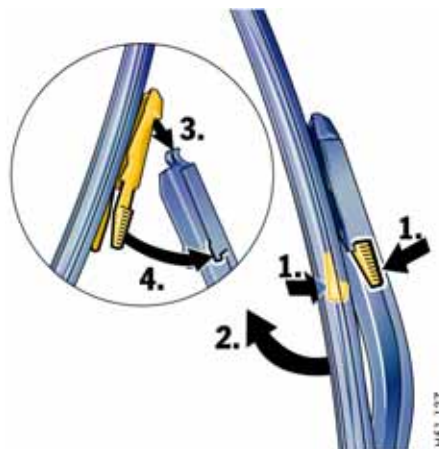

- f Apply the handbrake.
- f Switch the rear wiper off (position **0**) and
remove the ignition key.
- f Fold wiper arm away from the glass.
1. Press together the plastic spring of the wiper
blade.
2. Pull wiper blade upwards and out of wiper arm.
3. Insert new wiper blade into the wiper arm from
above.
4. Press together the plastic spring of the wiper
blade and engage it in the wiper arm until it
snaps into place.
5. Carefully fold wiper arm back onto the window.

Changing rear window wiper blade

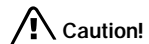

Caution!

Risk of damage.

**If a wiper blade is not changed properly, it
can come loose when the car is moving.**

- f Check whether the wiper blade is seated
securely.
The wiper blade must engage the wiper arm
properly.

Car Care Instructions

- f Please observe the chapter “EXERCISE EXTREME CAUTION WHEN WORKING ON YOUR VEHICLE” on Page 198.

Regular and correct care helps to maintain the value of your car and is also a precondition for the New Vehicle Warranty and the Anti Corrosion Warranty.

Your authorized Porsche dealer has specially developed car-care products from the Porsche program available either singly or as complete car-care sets. They will be pleased to help you select suitable products.

Whether you use Porsche products or other commercially available cleaning agents first make sure of their correct application.

A Porsche that is well-cared for can look like new for years. It all depends on the amount of care the owner is willing to give the car.

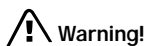

Risk of serious personal injury or damage to the vehicle or property.

Cleaning agents may be hazardous to your health.

Most chemical cleaners are concentrates which require dilution. High concentrations might cause problems ranging from irritation to serious injury as well as damage to your vehicle.

- f Keep cleaning agents out of reach from children.
- f Observe all caution labels.
- f Always read directions on the container before using any product. These directions may contain information necessary to avoid personal injury.
- f Do not use fuel, kerosene, naphtha, nail polish remover or other volatile cleaning fluids. They may be toxic, flammable or hazardous in other ways. Only use spot removing fluids in a well vented area.
- f Do not clean the underside of chassis, fenders, wheel covers, etc., without protecting your hands and arms as you may cut yourself on sharp-edged metal parts.

Moisture and road salt on brakes may affect braking efficiency.

- f Test the brakes after each vehicle washing.

Washing

The best method of protecting your car from the damaging effects of the environment is frequent washing and the application of a preservative. The underside of your vehicle should also be thoroughly washed for cinders, salt or sanding at winter's end.

The longer salt, road dust and industrial dust, dead insects, bird droppings or substances from trees (resin, pollen) are allowed to remain on the bodywork, the more serious is their harmful effect.

New cars should be washed carefully with plenty of clear water to protect the new paint work. Dark paint finishes show up the smallest of surface damage (e.g., scratches) more readily than lighter colors.

Dark colors are also more susceptible to scratching because of the composition of their pigments and require particularly careful paint care.

- f Do not wash your car in bright sunlight or while the bodywork is still hot.
- f When washing by hand, use abundant water, a soft sponge or wash brush, and Porsche car shampoo.
- f Begin by spraying the body thoroughly with water to rinse away loose dirt.

- f After washing, rinse the car with plenty of water and then dry with a chamois leather. Do not use the same chamois leather for drying as you use for cleaning the windshield and windows.

Warning!

Moisture which gets on to the brakes during a car wash can reduce braking efficiency or make the brakes pull unevenly which could increase the danger of an accident, causing serious personal injuries or death.

- f Always apply the brakes a few times after washing the car to test braking efficiency and dry the brake discs. When doing this, take care not to hamper other road users behind you (traffic conditions permitting).
-

Convertible top

- f Never remove snow and ice using a sharp edged object.

Incorrect care and treatment can damage the convertible top and cause leaks. Any repair work can be done by your authorized Porsche dealer.

Important note

No folding top is 100% leak proof.

Due to the constant changing of loads and strains to which a car is subject to when driving on roads, minor wind noise and seepage at joints between the top, body and doors on convertible tops cannot be completely sealed in certain areas. Therefore small leaks are considered normal for these models. In addition, your convertible top should not be washed in a car wash. The top may experience damage by the brushes or may experience leaks due to the high pressure water streams directed in areas which would not encounter water in normal driving conditions.

Cleaning



Risk of damage due to the cleaning jet of the high-pressure cleaning equipment or hot wax treatment.

- f Do not clean the convertible top with high-pressure cleaning equipment.
- f Do not use the hot wax treatment.

Do not wash the convertible top each time the car is washed.

It is usually sufficient to spray or wash it with clean water.

- f Brush dust off the convertible top in the direction of the weave using a soft brush.
- f Only if there is heavy dirt, wet the convertible top with lukewarm water and the Porsche Wash-Shampoo & convertible-top cleaner, using a sponge or soft brush, and rub gently. Rinse Wash-Shampoo & convertible-top cleaner thoroughly off the convertible top with clean water.
- f After washing it, treat the convertible-top cover at least once a year with the special Porsche convertible-top care product.
Do not allow the convertible-top care product to come into contact with paint or windows. If it does, remove immediately.

- f If there is leakage in the convertible-top cover or at its seams or folds, the special Porsche convertible-top care product can be used.
- f Please note the information on the container.
- f Remove bird droppings immediately since the acid in them will make the rubber swell and the convertible top will become leaky.
- f Open convertible top only when it is completely dry, otherwise damp stains and scrub marks may occur which cannot be removed.
- f Try to remove spots from the convertible-top cover by rubbing carefully with a soft rubber sponge.

Automatic car washes

Optional add-on parts or parts which project beyond the contours of the vehicle may be damaged by design features (e.g. brushes) of automatic car washes.

The following parts are particularly susceptible to damage:

- Convertible top (hot wax treatment cannot be used, as the wax attacks the convertible top material)
 - Windshield wipers (always switch them off to prevent them wiping unintentionally in intermittent or sensor operation)
 - External antennas (always unscrew)
 - Roof Transport System (always remove completely)
 - Rear spoiler
 - Wheels (the wider the rim and the lower the tire height, the greater the risk of damage)
 - High-gloss wheels (to prevent these from getting scratched, do not clean with the wheel-cleaning brushes of the car wash).
- f Please consult the operator before using automatic car washes.
- f Wash and dry by hand all points not reached by a car wash, such as door and lid seams or door sills.

Note

Automatic car washes spray water at odd angles and high pressures, which are not seen in normal driving. Therefore, water can sometimes find its way into the passengers compartment during or shortly after the car wash.

Door lock

- f To prevent the door lock from freezing during the cold season, the lock cylinder should be covered during a wash.
- f Should the lock freeze, use an ordinary de-icer. In many cases, a well warmed key can help. Never use excessive force.

Paint

- f Never rub a dusty car with a dry cloth since dust particles are abrasive and could dull and damage the surface finish.

The paintwork of your car is exposed to all types of mechanical and chemical conditions, particularly climatic ones such as bright sunlight, rain, frost and snow. Ultraviolet light, rapid changes in temperature, rain, snow, industrial dust and chemical deposits constantly attack the paint which is only able to withstand such exposure in the long term if it is given regular care and attention.

- f Do not apply silicone polishes to the windshield or windows.
- f Do not treat matt-painted components with preservatives or polishes as this will spoil the matte effect.

Preservation

The paint surface becomes dull over time due to weathering. It is therefore necessary to preserve the paint regularly.

This keeps the paint shiny and elastic. Dirt is prevented from adhering to the paint surface and industrial dust is prevented from penetrating the paint.

Provided it is washed and treated with preservative regularly, the brand new finish of your car will be retained for years to come.

- f Apply paint preservative after the car wash and polish it dry to obtain a bright finish.

Polishing

Do not resort to using Porsche polish until it becomes evident that the normal preservatives no longer produce the desired finish.

Spots and stains

- f Remove tar stains, grease, oil spots and dead insects as soon as possible with Insect Remover. They can cause discoloration if allowed to remain on the paintwork.
- f Wash the affected area immediately after treating it.

Minor paint damage

- f Have minor paint damage, such as scratches, scores or chips caused by flying stones, repaired immediately by your authorized Porsche dealer before corrosion sets in.

However, if there are already traces of corrosion, they must first be removed carefully and thoroughly. Coat the area with a rust-proofing primer and finish off with a top coat. The paint code and color number are found on the data bank in the Maintenance booklet.

Engine compartment

The engine compartment and the surface of the engine are treated with a corrosion-inhibitor at the factory.

If degreasing solvents are used to clean the engine compartment or the engine is washed down, the process almost invariably removes the corrosion-inhibiting coating. It is then absolutely necessary to have a durable preservative applied to all surfaces, body seams, joints and assemblies in the engine compartment. This also applies when corrosion-inhibitor parts are replaced.



Risk of damage to the alternator.

- f Do not point the cleaning jet directly at the alternator, or cover the alternator.
-

Effective corrosion-proofing is particularly important during the cold weather season. If your car is driven frequently in areas where salt has been spread on the roads, the whole engine compartment should be cleaned thoroughly after the winter to prevent salt from causing any lasting damage. A full under-body wash should also be performed at the same time.

Windows

The road dust which settles on the windshield and windows contains particles of tire rubber and oil residue. The interior trim and upholstery release particles, particularly in strong sunlight, which collect on the insides of the windows. These deposits are augmented by impurities in the air which enters the car through the fresh air vents.

- f Clean all windows regularly, inside and outside, with Porsche window cleaner.
- f If you use a chamois leather for the windows, do not use it for paintwork as it will otherwise pick up a certain amount of preservative or polish and could smear the windows and thus impair vision.
- f Remove dead insects with Porsche insect remover.

Note

Door windows feature a water-repellent (hydrophobic) coating which prevents soiling of the windows. This coating is subject to natural wear and can be renewed.

- f Consult an authorized Porsche dealer.

Wiper blades

Wiper blades that are in perfect condition are vital for a clear view.

- f Replace the wiper blades twice per year (before and after the cold season) or whenever wiper performance deteriorates.
- f Periodically clean the wiper blades with Porsche window cleaner, especially after the vehicle has been washed in a car wash. If they are very dirty (e.g. with insect remains), they can be cleaned with a sponge or cloth.

Undercoating

As it is not possible to exclude the risk of damage to this protective coating in day to day driving, it is advisable to have the underside of the car inspected at certain intervals – preferably before the start of winter and again in spring – and the undercoating restored as necessary.

Your authorized Porsche dealer is familiar with the bodyseal treatment procedures and has the necessary equipment for applying factory approved materials. We recommend that you entrust them with such work and inspections.

Unlike conventional spray oils, undercoating and rust-proofing compounds based on bitumen or wax do not attack the sound-proofing materials applied at the factory.

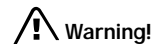

Warning!

Danger of fire and serious personal injuries.

- f Do not apply additional undercoating or rust-proofing on or near the exhaust manifold, exhaust pipes, catalytic converters or heat shields. During driving the substance used for undercoating could overheat and ignite.
- f Before applying fresh underseal, carefully remove any deposits or dirt and grease. Once it has dried, the new undercoating compound forms a tough protective coating which provides efficient rust-proofing of the floor panels and components.
- f Always apply a fresh coating of suitable preservative to unprotected areas after cleaning the underside of the body, the transmission, the engine or carrying out repairs to underbody, engine or transmission components.

Effective rust-proofing is particularly important during the cold weather season. If your car is driven frequently in areas where salt has been spread on the roads, the whole engine compartment should be cleaned thoroughly after the winter to prevent salt from causing any lasting damage. A full under-body wash should also be performed at the same time.

Light alloy wheels

- f Please observe the chapter "WASHING" on Page 219.



Danger of accident if cleaning agents (e.g. wheel cleaning agents) come into contact with the brake discs. The resulting film on the brake discs can impair braking performance.

- f Make sure that no cleaning agent comes into contact with the brake discs.
- f If cleaning agent has come into contact with the brake discs, thoroughly clean the brake discs with a strong jet of water.
- f Paying attention to any road users behind you, dry the brake discs by applying the brakes at short intervals.

Pitting may occur if metallic particles which cause contact corrosion (e.g. brass or copper in brake dust) are allowed to remain on the aluminum for too long.

- f If possible, wash the wheels with a sponge or wash brush about every two weeks. In areas where salt is spread on winter roads or there is a lot of airborne industrial dust, it is best to clean the wheels weekly.

The Porsche Light Alloy Wheel Cleaner (ph-value 9.5) can be used for this purpose.

If the ph-value of the detergent is incorrect, the protective coating on the wheels will be destroyed.

Polishes which dissolve oxides, such as those frequently used for other metals, or abrasive tools or agents are unsuitable because they break down the oxide film of the protective coating and will cause discoloration of the wheel.

- f Every three months, after cleaning, coat the wheels with a car wax or non-corrosive grease (vaseline). Using a clean cloth thoroughly rub the grease into the surface.

Door, roof, lid and window seals

- f Wash dirt (e.g. abrasion, dust, road salts) from all seals regularly using warm soapy water. Do not use any chemical cleaning agents or solvents.

When there is a frost hazard, the outer door seals and the front and rear lid seals can be protected against freezing into place by a suitable care product.

In order to prevent damage to the anti-friction coating, the inner door seals, the convertible top seals and hardtop seals must not be treated with care products.

Headlights, lights, interior and exterior plastic parts

- f Use **only** clean water and a little dishwashing detergent to clean light lenses, plastic headlight lenses, plastic parts and surfaces. Do not clean when dry. Use a soft sponge or a soft, lint-free cloth. Gently wipe the surface without applying too much pressure. The Porsche inside window cleaner is also suitable for cleaning plastic surfaces. Follow the cleaning instructions on the container. Never use other chemical cleaners or solvents.
- f Rinse cleaned surfaces with clear water.

Leather

Characteristics and special features

The natural surface markings of leather, e.g. creases, healed scars, insect sting marks, structural differences and slight variations in shade and grain add to the attractiveness of the natural leather product.

A special mention must be made here of natural leather.

For natural leather, carefully selected hides of the highest quality are used. It is not covered completely with dye on production.

"Nature's signature" is therefore easily recognizable.

This fine material is distinguished by an outstanding seating comfort, special suppleness and a typical patina.

Leather care and treatment

- f Clean all types of leather regularly to remove fine dust using a soft, damp, white woollen cloth or a commercially available microfibre cloth.
- f Remove heavy contamination with Porsche leather cleaner.
Please always follow the instructions for use given on the containers.

Caustic cleaners and hard cleaning objects must not be used.

Perforated leather must under no circumstances get wet on its reverse side.

Once cleaned, leather (particularly the heavily stressed leather seats) must be treated only with Porsche leather care liquid.

Fabric, upholstery, carpets and floor-mats

- f Use only a vacuum cleaner or a medium stiff brush.
- f Remove stains and spots with Porsche stain remover.

The Porsche range of accessories includes non-skid floor-mats to protect the carpets in summer and winter.

Warning!

Risk of an accident.

- f Always check the movement of the pedals before driving and make sure that they are not obstructed by a floor-mat or any other object.
 - f Secure the floor-mat to prevent it from sliding into positions that could interfere with the safe operation of your vehicle - do not install them loosely in the vehicle.
Your Porsche dealer will be glad to offer you nonskid floor-mats of the correct size.
-

Alcantara

- f Do not use a leather care product to clean Alcantara.

For regular care it is sufficient to clean the cover with a soft brush.

Heavy abrasion or rubbing when cleaning causes a lasting change in the surface.

Cleaning when lightly soiled

- f Wet a soft cloth with water or a neutral soap solution and wipe off the dirt.

Cleaning when heavily soiled

- f Wet a soft cloth with lukewarm water or thinned white spirit and dab the dirt from the outside in.

Safety belts

If it becomes necessary to clean the belts, you can use any mild washing agent. Allow the belts to dry prior to retracting, but avoid direct sunlight.

- f Only use suitable cleaners. If unsuitable cleaners are used or any attempt is made to dye or bleach the belts, the webbing may be weakened and thus constitute a safety risk.

Storing your Porsche

If you intend to store your Porsche for a prolonged period, please consult your authorized Porsche dealer. The staff will be glad to advise you on the most suitable and necessary methods.

- f Clean your vehicle thoroughly inside and outside. Clean the engine compartment. The under carriage and chassis components should be free of dirt and salt deposits.
- f Fill up the fuel tank.
- f Change the oil and oil filter, and run the engine for several minutes.
- f Increase the tire pressure to 58 psi (4 bar). It is not recommended to lift the vehicle, due to the possibility of corrosion on shock absorber piston shafts. The vehicle should be moved slightly, approximately every four weeks, to prevent flat spot on the tires.

Climate control

The air conditioning system should be in good working condition and fully charged.

Windshield/Headlight washer

- f Check and correct antifreeze/cleaning solution level as necessary.

Electrical system

- f Remove the battery from the vehicle and store it in a cool dry place, not on a cement floor. **When the battery is disconnected, the alarm system is deactivated.**
- f Recharge the battery every 3 months. If the battery remains in the vehicle with the cables connected, it is necessary to check, remove and recharge the battery every 2-3 weeks. **Do not fast charge the battery.**
- f Please observe the chapter "BATTERY" on Page 258.

Vehicle interior

The interior must be dry, especially in the area of the floor carpets. The use of drying agents (Silica-Gel) is recommended in vehicles with leather interior and in areas with high humidity. The recommended amount is 3 fabric bags of 1.1 lbs. (500 grams) each placed on the floor carpets.

Windows, doors and lids must be closed. The air vents should be opened.

Practical Tips, Emergency Service

Exercise Extreme Caution when Working on your Vehicle	228
Tires/Wheels	229
Loading Information.....	242
Lifting the Vehicle with a Lifting Platform or Garage Lift	244
Flat Tire	245
Wheel Bolts	248
Spacers	249
Changing a wheel.....	250
Electrical System	254
Battery	258
Emergency Starting with Jumper Cables	264
Lights, Replacing Bulbs.....	266
Headlights	268
Tail Light	276
License Plate Light	277
Luggage Compartment/ Engine Compartment/Footwell Light	277
Door Guard/Curb Light	277
Interior Light, Reading Lights.....	278
Adjusting Headlights	279
Towing	281

Exercise Extreme Caution when Working on your Vehicle



Danger!

Ignoring the following instructions may cause serious personal injury or death.

- f The engine compartment of any motor vehicle is a potentially hazardous area. If you are not fully familiar with proper repair procedures, do not attempt the adjustments described on the following pages.
This caution also applies to the entire vehicle.
- f Only work on your vehicle outdoors or in a well ventilated area.
- f Ensure that there are no open flames in the area of your vehicle at any time when fuel fumes might be present. Be especially cautious of such devices such as hot water heaters which ignite a flame intermittently.
- f Before working on any part in the engine compartment, turn the engine off and let it cool down sufficiently. Hot engine compartment components can burn skin on contact.
- f Be alert and cautious around engine at all times while the engine is running.
If work has to be performed with the engine running, always set the parking brake, and make sure the shift lever is in neutral position or the selector lever in position **P**.
- f In particular, be very careful to ensure that items of clothing (ties, shirt, sleeves etc.), jewelry, long hair, hand or fingers cannot get caught in the engine-compartment blower, fan, belts or other moving parts.
The radiator and radiator fans are in the front of the car.
The engine-compartment blower is mounted on the engine-compartment lid.
The engine-compartment blower can start or continue running as a function of temperature, even with the engine switched off.
Carry out work in these areas only with the engine off, the ignition switched off, and exercise extreme caution.
- f Your Porsche is equipped with an electronic ignition system. When the ignition is on, high voltage is present in all wires connected with the ignition system; therefore, exercise extreme caution when working on any part of the engine while the ignition is on or the engine is running.
- f Always support your car with safety stands if it is necessary to work under the car.
- f When working under the car without safety stands but with the wheels on the ground, make sure the car is on level ground, the wheels are blocked, and that the engine cannot be started.
Remove the ignition key.
- f Do not smoke or allow an open flame around the battery or fuel.
Keep a fire extinguisher in close reach.
- f Incomplete or improper servicing may cause problems in the operation of the car. If in doubt about any servicing, have it done by your authorized Porsche dealer.
Improper maintenance during the warranty period may affect your Porsche warranty coverage.
- f Supplies of fluids, e.g. engine oil, brake fluid or coolant, are hazardous to your health.
Keep these fluids out of children's reach and dispose of them in accordance with the appropriate regulations.
- f Some countries require additional tools and special spare parts to be carried.
Please make enquiries before driving abroad.

Tires/Wheels

The original equipment tires and wheel rims on your Porsche comply with all applicable Federal Motor Vehicle Safety Standards.

For your safety remember the following:

- Wheel rims and wheel bolts are matched to fit your Porsche.
- If you intend to use other than original equipment wheels, be sure that they conform to Porsche specifications for your model. Only tires with the same make and with the same specification code (e.g. "NO", "N1"...) can be mounted.
- The use of wheel rims and wheel bolts that do not meet specifications of the original factory installed equipment will affect the safe operation of your vehicle.
- Before you plan on exchanging wheels, or snow tires already mounted on the wheel rims, consult your authorized Porsche dealer. Your dealer has the technical information necessary to advise you which wheel rims and wheel bolts are compatible with the original factory installations.



Risk of loss of control and serious personal injury or death.

- f If while driving, your vehicle experiences a sudden vibration or ride disturbance, and/or you suspect that possible damage to your tires or vehicle has occurred, you should immediately reduce your speed without excessive use of the brakes.
 - f Stop the vehicle as soon as possible, and inspect the tires. If you cannot determine the cause for the disturbance, have your vehicle towed to the nearest Porsche or tire dealer to have your vehicle or tire(s) inspected.
 - f Continuing to operate the vehicle without correction could result in a loss of control and serious personal injury.
-

Uniform Tire Quality Grading

Quality grades can be found where applicable on the tire sidewall between tread shoulder and maximum section width.

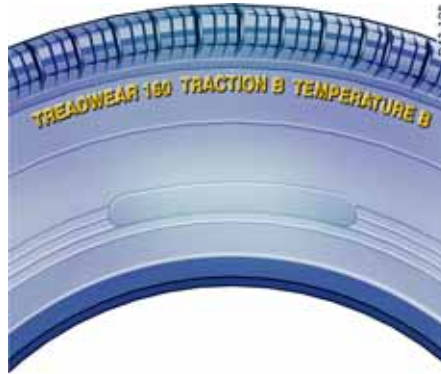

Example

All passenger car tires must conform to Federal Safety Requirements in addition to these grades.

Treadwear

The treadwear grade is a comparative rating based on the wear rate of the tire when tested under controlled conditions on a specific government test course.

For example, a tire graded 150 would wear one and a half (1-1/2) times as well on the government course as a tire graded 100.

The relative performance of tires depends upon the actual conditions of their use, however, and may depart significantly from the norm due to variations in driving habits, service practices and differences in road characteristics and climate.

Traction AA, A, B, C

The traction grades, from highest to lowest, are AA, A, B, and C and they represent the tire's ability to stop on wet pavement as measured under controlled conditions on specified government test surfaces of asphalt and concrete.

A tire marked C may have poor traction performance.

 **Warning!**

The traction grade assigned to this is based on braking (straight-ahead) traction tests and does not include cornering (turned) traction, acceleration, hydroplaning or peak traction characteristics.

Temperature A, B, C

The temperature grades are A (the highest), B and C, representing the tire's resistance to the generation of heat and its ability to dissipate heat when tested under controlled conditions on a specified indoor laboratory test wheel.

Sustained high temperatures can cause the material of the tire to degenerate and reduce tire life, and excessive temperature can lead to sudden tire failure.

The grade C corresponds to a level of performance which all passenger car tires must meet under the Federal Motor Vehicle Safety Standard No. 109.

Grades B and A represent higher levels of performance on the laboratory test wheel than the minimum required by law.

 **Warning!**

The temperature grade for this tire is established for a tire that is properly inflated and not overloaded.

Excessive speed, underinflation, or excessive loading, either separately or in combination, can cause heat buildup and possible tire failure.

Tire pressures

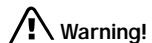

Warning!

Incorrect tire pressure causes increased tire wear and adversely affects road handling.

- f Always use an accurate tire pressure gauge when checking inflation pressures.
 - f Do not exceed the maximum tire pressure listed on the tire sidewall.
Please observe the chapter "TIRE PRESSURE PLATE" on Page 285.
 - f Cold tire inflation pressure means: all tires must be cold, ambient temperature maximum (68°F/20°C), when adjusting the inflation pressure.
Avoid sunlight striking the tires before measuring cold pressures, since the pressures would rise from temperature influence.
 - f Valve caps protect the valve from dust and dirt, and thus from leakage.
Always screw caps tightly down.
Replace missing caps immediately.
 - f Use only plastic valve caps.
 - f Do not use commercially available sealant or tire inflating bottles. Only use Porsche approved tire sealant.
-

Each tire, including the spare (if provided), should be checked every 2 weeks when cold (68°F/20°C) and inflated to the inflation pressure recommended in this Owner's Manual or on the tire-pressure plate.

If your vehicle has tires of a different size than the size indicated in this Owner's Manual or on the tire-pressure plate, you should determine the proper tire inflation pressure for those tires.

As an added safety feature, your vehicle has been equipped with a tire pressure monitoring (TPC) that illuminates a low tire pressure message when one or more of your tires is significantly under-inflated. Accordingly, when the low tire pressure message illuminates, you should stop and check your tires as soon as possible, and inflate them to the proper pressure. Driving on a significantly under-inflated tire causes the tire to overheat and can lead to tire failure. Under-inflation also reduces fuel efficiency and tire tread life, and may affect the vehicle's handling and stopping ability.

Please note that the TPC is not a substitute for proper tire maintenance, and it is the driver's responsibility to maintain correct tire pressure, even if under-inflation has not reached the level to trigger illumination of the TPC low tire pressure message.

- f On vehicles with tire pressure monitoring: Please observe the chapter "TPC TIRE PRESSURE MONITORING" on Page 109.

When tires are warm, the tire pressure is increased.

- f Never let air out of hot tires.
This could cause the tire pressure to fall below the prescribed value.

Insufficient tire filling pressure can cause tires to overheat and thus be damaged – even invisibly. Hidden tire damage is not eliminated by subsequently correcting the tire pressure.

Overloading



Danger!

Risk of personal injury, loss of control and damage to vehicle parts.

- f Do not overload your vehicle. Be careful about the roof load.
 - f If loading the vehicle also correct the tire pressure. Tire pressure for loaded vehicle can be found on the tire pressure plate and in the chapter technical data.
 - f Never exceed the specified axle load.
Overloading can shorten the service life of the tires and car, as well as lead to dangerous vehicle reactions and long braking distances.
Damage due to overloading is not covered by the vehicle warranty.
-
- f Please observe the chapter "LOADING INFORMATION" on Page 242.
 - f Please observe the chapter "TIRE PRESSURES FOR COLD TIRES" on Page 290.

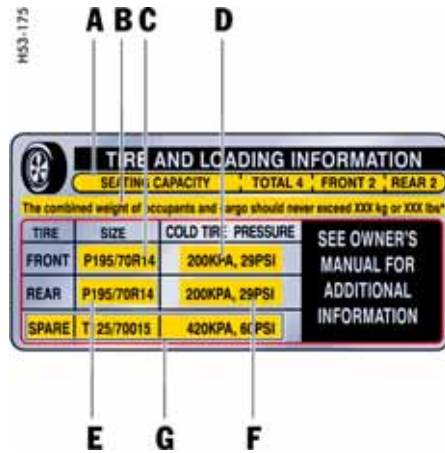

Example of a tire pressure plate A

Tire pressure plate

Depending on when your vehicle was manufactured, the tire pressure plate on the driver's door aperture will contain different data.

Information on the tire pressure plate A

- A Seating capacity
Maximum number of vehicle occupants, including the driver.

- B Vehicle load limit
Is the maximum total weight limit specified of the load (passengers and cargo) for the vehicle. This is the maximum weight of passengers and cargo that can be loaded into the vehicle. If a trailer is being towed, the trailer tongue weight must be included as part of the cargo load.
Please observe the chapter "LOADING INFORMATION" on Page 242.

- C Tire size for the front axle
Check with your authorized Porsche dealer about the current release status.
- D Recommended tire pressure for the front axle
These values are for cold tires (68°F/20°C).
- E Tire size for the rear axle
Check with your authorized Porsche dealer about the current release status.
- F Recommended tire pressure for the rear axle
These values are for cold tires (68°F/20°C).
- G In vehicles with collapsible spare wheel:
Size and tire pressure of the spare wheel



Example of a tire pressure plate B

Information on the tire pressure plate B

- A Information for tire sealant, seating capacity, vehicle load limit
- B Approved tire size for the front axle
- C Permissible tire pressure for the front axle
- D Tire pressure for fully loaded or partially loaded vehicle
- E Permissible tire pressure for the rear axle
- F Approved tire size for the rear axle

Tire traction

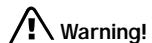

Warning!

When driving on wet or slushy roads, a wedge of water may build up between the tires and the road. This phenomenon is known as “hydroplane” and may cause partial or complete loss of traction, vehicle control or stopping ability.

- f Reduce speed on wet surface to prevent this.
-

Tire life

Tire life depends on various factors, i. e., road surfaces, traffic and weather conditions, driving habits, type of tires and tire care.

- f Inspect your tires for wear and damage before driving off. If you notice uneven or substantial wear, wheels might need alignment or tires should be balanced or replaced.

Tire wear

The original equipment tires on your Porsche have built-in tire wear indicators. They are molded into the bottom of the tread grooves and will appear as approximately 1/2 in. (12 mm) bands when the tire tread depth is down to 1/16 of an in. (1.6 mm).

When the indicators appear in two or more adjacent grooves, it is time to replace the tires. We recommend, however, that you do not let the tires wear down to this extent.

Worn tires cannot grip the road surface properly and are even less effective on wet roads.

In the United States, state laws may govern the minimum tread depth permissible. Follow all such laws.



Danger!

Driving on worn tires can result in loss of control of the vehicle and could cause serious personal injuries or death.

- f Do not drive with worn tires or tires showing cuts or bruises as they may lead to sudden deflation and loss of control which could cause severe personal injury.
 - f Specialized high performance tires on high performance sports cars exhibit more wear than those on a family sedan, or even a high performance sedan. Therefore, it is important to check your tire pressure and condition at least every two weeks.
-

If you notice that tires are wearing unevenly, consult your Porsche dealer.

Uneven wear may not always be due to improper wheel alignment. It can be the result of individual driving habits such as cornering at high speeds. If the tire pressure is not checked and adjusted regularly, abnormal tire wear can also occur.

Tire care

- f Avoid damaging tires and wheel rims.
- f If you must drive over a curb or other obstacle, drive slowly and at an obtuse angle.
- f Check tires for uneven wear and damage before driving off.
- f Remove imbedded material.
- f Replace worn or damaged tires immediately.
- f Keep oil, fuel, brake fluid, etc. away from tires.
- f Replace missing valve stem caps.
- f Keep tires inflated correctly.
- f Wash tires when washing the vehicle. Also clean inner side of wheels.
- f Do not use abrasive cleaners when washing the wheels.
- f Check wheel rims for corrosion.
- f Remove road salt, if driving in winter.

Tire damage, puncture

- f Check tires for imbedded material, cuts, punctures, cracks and bulges (side wall) before driving off.

In case of tire damage, where it is uncertain whether there is a break in the ply with all its consequences or tire damage caused by thermal or mechanical overloading due to loss of pressure or any other prior damage, we recommend that the tire be replaced for safety reasons.

If one faulty tire is replaced it should be noted that the difference in tread depth on one axle must not exceed 30%.

Handling inconsistencies may result.

- f Perform a visual inspection if necessary.



Risk of serious personal injury or death. Driving the vehicle with low tire pressure increases risk of a tire failure and resulting loss of control. Furthermore, low tire pressure increases rate of wear of the affected tires.

- f Check tires – including sidewalls – regularly for foreign bodies, nicks, cuts, cracks and bulges.
 - f After driving off road, examine tires for signs of damage such as cuts, tears, bulges or foreign objects stuck in the tread. Replace a damaged tire if necessary.
 - f Cross curb edges slowly and at right angles if possible. Avoid driving over steep or sharp curbs.
 - f In cases of doubt, have the wheel (particularly the inner side) checked by an authorized Porsche dealer.
-

Tire replacements

If in doubt, contact your Porsche dealer.
Use only tire makes and types approved by Porsche.

If you do not use a Porsche recommended replacement tire, make sure that you purchase your new tires from a reputable tire dealer and that the dealer complies with all manufacturers warnings for those tires.

Only tires with the same make and with the same specification code (e.g. "N0", "N1"...) can be mounted.

Before mounting new tires, check with your Porsche dealer about the current release status.

Use tires with "ZR" quality standards. There are currently no standards concerning tire strength at speeds above 150 mph (240 km/h).

Tires should be replaced no less than on one axle at the time.

Only tires of the same make and type must be used. Mixed tires are not permissible.

Initially, new tires do not have their full traction. You should therefore drive at moderate speeds during the first 60 - 120 miles (100 - 200 km).

If new tires are installed only on one axle, a noticeable change in handling occurs due to the different tread depth of the other tires.

This happens especially if only rear tires are replaced. However, this condition disappears as the new tires are broken in.

f Please adjust your driving style accordingly.

Installation of new tires should only be done by a qualified tire technician.

Valves

Rubber valve stems must be replaced every time a tire is replaced.

For metal valves, the installation and replacement instructions must be observed.

f Use only genuine Porsche metal valves.

f Protect the valve inserts against soiling with valve caps.
Soiled valve inserts can cause a gradual loss of air.

f Use only plastic valve caps.

Parking at the curb



Hard impacts against curbs (or traffic islands) are dangerous and may cause hidden tire damage which is not noticeable until later. Such damage can result in accidents at high speeds causing severe personal injury. Depending on the force of impact, the edge of the rim can also be damaged.

f If you are in doubt, have the wheel checked by an expert, particularly if you suspect damage on the inside.

f If you must drive over a curb or other obstacle, drive slowly and at an obtuse angle. Exercise care when parking along curbs.

Wheel alignment, wheel balancing

As a precaution, have wheels with summer tires balanced in the spring, and those with mud and snow tires before winter.

Unbalanced wheels may affect car handling and tire life.

Only the specified weights may be used for wheel balancing.

Self-adhesive weights must not come into contact with cleaning agents, since they could drop off. Uneven tread wear indicates wheel imbalance. In this event, the vehicle should be checked at an authorized Porsche dealer.



If, during a journey, uneven running or vibrations occur that could be caused by damage to tires or the car, the speed must be reduced immediately, but without braking sharply.

If you continue your trip without having the cause of the fault remedied, you might lose control of your vehicle which could cause severe personal injury.

f Stop the vehicle and check the tires.

f If no cause for the fault can be found, drive carefully to the nearest authorized Porsche dealer.

Removing and storing tires

f After changing, adjust tire pressure and torque wheel bolts diagonally to 94 ftlb (130 Nm).

Tires must always remain on the same side of the vehicle.

When wheels are removed, the direction of rotation and position of each wheel should be marked.

Example

FR (front right), FL, RR and RL.

Wheels must always be fitted in accordance with their marking.

The preception that tire durability and performance are immune to the effects of storage and age is unfounded.

Chemical additives, which make the rubber elastic, lose their effectiveness in the course of time and the rubber becomes brittle and cracks.

Therefore, the tires should be inspected from time to time.

Note

Under no circumstances should tires older than 6 years be used on your Porsche.

The age of the tire can be obtained from the "DOT" code number. If, for example, the last four numbers read 1204, then the tire was produced in the 12th week of 2004.

f Store tires in a cool and dry place.

Snow tires

For a better grip on snow and ice, use radial M+S tires with studs. Check with your local Motor Vehicle Bureau for possible restrictions.



Risk of loss of control and damage to the vehicle as well as serious personal injury or death.

The standard tires profile and rubber mixture are optimized for wet and dry driving conditions, and may not prove favorable for snow conditions.

- f Therefore install M+S tires before driving in such conditions.

Before mounting snow tires, consult with your Porsche dealer. He has the technical information necessary to advise you on wheel and tire compatibility.

Snow tires should have the same load capacity as original equipment tires and should be mounted on all four wheels.

Snow tires with studs should be run at moderate speeds when new in order to give the studs time to settle.



Tires with badly worn treads and studs are very dangerous and could cause accidents resulting in serious personal injuries or death.

- f Make sure they are replaced immediately.
- f Do not drive a vehicle equipped with snow tires at prolonged high speed. Snow tires do not have the same degree of traction on dry, wet or snowfree roads as a normal tire. Furthermore, snow tires wear rapidly under these conditions.

Comply with all state and local laws governing snow tire and tread depth requirements.



Risk of accident and serious personal injury or death due to excessive speed.

- f Always check the maximum speed rating on the tire sidewall on any tire on the vehicle.
- f Never exceed the maximum speed rating of the tires.
- f Fit winter tires to both axles well before the cold season begins. Your authorized Porsche dealer will be pleased to advise you.

Maintenance note

We recommend fitting winter tires on the vehicle at temperatures below 45°F (7°C).

Winter tires lose their traction capability when their tread depth falls below 5/32 in. (4 mm).

Snow chains



Risk of damage to body, axle or brake components.

- f Fit snow chains only to the rear wheels, and only with the tire/rim combination listed in the Technical Data.
To ensure adequate clearance between chain and body, Porsche recommends only the use of fine-link chains such as those approved by Porsche.
- f Follow instructions issued by the supplier of the chains.

Different states and countries have varying statutory requirements regarding maximum speed. Check with local authorities for possible restrictions.

- f Remove chains as soon as the roads are free of ice and snow.

911 Carrera, 911 Carrera S

Fitting snow chains

The use of snow chains is not permitted when 5 mm spacers are mounted.



Risk of damage to the wheel housings if the 5 mm spacers are not removed before fitting snow chains.

- f To permit the fitting of snow chains, have the 5 mm spacers removed on all 4 wheels.
-
- f To fit/remove the spacers:
Please consult an authorized Porsche dealer.
 - f Please observe the chapter "5 MM SPACERS" on Page 253.

Tire designations

Due to new speed and load ratings for radial tires, new designations have come into force for snow tires for your Porsche.

The designation to be used for ZR tires is e.g., 265/40 ZR 18 (Z = code letter for radial tires for speeds above 150 mph / 240 km/h).



Example of Inscription

Inscription on radial tire

A Tire size

Example: P 295/30 ZR 19 100 Y

- **P** - The tire is designed for Passenger vehicle. This information is not included on all tires.
- **295** - Indication of tire width in mm
- **30** - Indication of tire height to tire width ratio in percent

- **ZR** - code letter for radial tires for speeds above 150 mph / 240 km/h
There are currently no standards concerning tire strength at speeds above 150 mph (240 km/h).
- **R** - Belt type code letter for radial
- **19** - Indication of rim diameter in inches
- **100** - Load capacity coefficient
- **Y** - Speed code letter
- **XL (Extra Load)** - Tire with increased load rating

B TIN (Tire Identification Number)

Example: DOT xx xx xxxx xxxx

- **DOT**
The DOT symbol indicates that the tires comply with the requirements of the US Department of Transportation and provides information about:
 - first two-digit code means manufacturer's identification mark.
 - second two-digit code means tire size.
 - third four-digit code means tire type code.
 - fourth four-digit code means date of manufacture.
If, for example, the last four numbers read 0204, the tire was produced in the 2nd week of 2004.

C Tire ply composition and material

The number of layers in the tread and sidewalls and their material composition.

D Maximum permissible inflation pressure

The maximum permissible cold inflation pressure to which a tire can be inflated.

- f Do not exceed the permissible inflation pressure.

E Maximum Load rating

The maximum load in kilograms and pounds can be carried by the tire. If you replace tires always use a tire that has the same maximum load rating as the factory installed tire.

F Radial

The identification indicates if the tire has radial structure.

G Term of tubeless or tube tire

Identification for tubeless tires.

Speed code letter

The speed code letter indicates the maximum permissible speed for the tire. This code letter is shown on the tire sidewall.

T = up to 118 mph (190 km/h)
H = up to 131 mph (210 km/h)
V = up to 150 mph (240 km/h)
W = up to 167 mph (270 km/h)
Y = up to 186 mph (300 km/h)

Tip on driving

Tires with a maximum speed rating that is lower than the specified maximum vehicle speed may be mounted only if they bear an M+S identification on the tire sidewall.

- f Please note that in addition to the winter tires, all-season and all-terrain tires are also subject to speed limits and bear this identification.

Inscription on light alloy wheels

Maintenance note

- f Protect the valve inserts against soiling with valve caps. Use only plastic valve caps. Soiled valve inserts can cause a gradual loss of air.

Note on operation

- f The rim width in inches **A** and the rim offset **F** are visible from the outside. This information can be found near the tire valve.



- A - Rim width in inches
- B - Rim-flange contour code letter
- C - Symbol for drop-center rim
- D - Rim diameter in inches
- E - Double hump
- F - Rim offset in mm

Loading Information

Definitions

The Curb weight - actual weight of your vehicle - vehicle weight including standard and optional equipment, fluids and emergency tools. This weight does not include passengers and cargo.

The Gross Vehicle Weight is sum of the curb weight and the weight of passengers and cargo combined.

The Gross Vehicle Weight Rating is the maximum total weight of vehicle, passengers, luggage and optional equipment.

The Gross Axle Weight Rating is the maximum load limit for the front or the rear axle. This information is located on the safety compliance sticker located in the driver's side door jamb.

For determining the compatibility of the tire and vehicle load capabilities:

- f Please observe the chapter "TIRES, RIMS, TRACKS 911 CARRERA, 911 CARRERA S" on Page 288.

The load capacity coefficient (e.g. "100") is a minimum requirement.

The Gross Combined Weight Rating is the maximum total weight rating of vehicle, passengers and cargo.

The Vehicle Capacity Weight - Load Limit - is the maximum total weight limit specified of the load (passengers and cargo) for the vehicle. This is the maximum weight of passengers and cargo that can be loaded into the vehicle. This information can be found on the tire pressure plate.

The maximum loaded vehicle weight is the sum of curb weight, accessory weight, vehicle capacity weight and production options weight.

The load rating is the maximum load that a tire is rated to carry for a given inflation pressure.

The maximum load rating is the load rating for a tire at the maximum permissible inflation pressure.

The cargo capacity is the permissible weight of cargo, the subtracted weight of passengers from the load limit.

- f Never exceed the permissible limits.



Risk of personal injury, loss of control and damage to vehicle.

- f Never exceed the specified axle loads. Overloading can shorten the service life of the tires and car, as well as lead to dangerous vehicle reactions and long braking distances. Damage due to overloading is not covered by the vehicle warranty.
-

H53-174

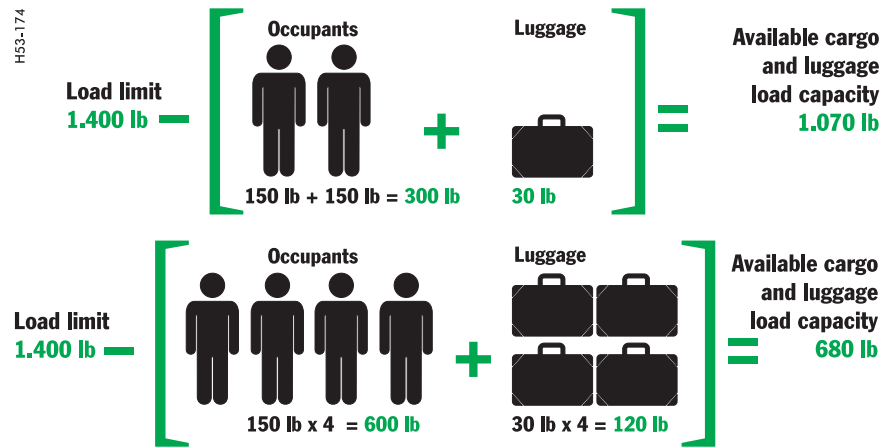

Example for determining the combined weight of occupants and cargo

Vehicle Load Capacity

- f The combined weight of occupants and cargo should never exceed the weight shown on the tire plate in the vehicle. Please observe the chapter "TIRE PRESSURE PLATE" on Page 285.
- f Never exceed the number of passengers shown on the tire pressure plate in the vehicle.

Determining the combined weight of occupants and cargo:

- f Add the weight of all occupants and then add the total luggage weight (figure).

Steps for determining correct load limit

1. Locate the statement "The combined weight of occupants and cargo should never exceed XXX pounds" on your vehicle's placard (depending on the date of manufacture)
2. Determine the combined weight of the driver and passengers that will be riding in your vehicle.

3. Subtract the combined weight of the driver and passengers from XXX kilograms or XXX pounds.
4. The resulting figure equals the available amount of cargo and luggage load capacity. For example, if the "XXX" amount equals 1400 lbs. and there will be five - 150 lb passengers in your vehicle, the amount of available cargo and luggage load capacity is 650 lbs. (1400 - 750 (5 x 150) = 650 lbs.)
5. Determine the combined weight of luggage and cargo being loaded on the vehicle. That weight may not safely exceed the available cargo and luggage load capacity calculated in Step 4.



A - Front jacking point

Lifting the Vehicle with a Lifting Platform or Garage Lift

The car must be raised **only** at the illustrated jacking points.



B - Rear jacking point

Caution!

Serious injury and/or serious damage to the engine or the vehicle may occur, if you lift the vehicle improperly.

- f Never lift the vehicle at any other place than the jacking points.
- f Never lift the vehicle by the engine, transmission or axles.
- f Do not damage any sensitive components in the vicinity of the jacking points.

Platform lift

Before the car is driven on to a lifting platform, it must be ensured that there is enough space between the lifting platform and the vehicle.

Garage lift

A garage lift must be used **only** at the illustrated jacking points.

Flat Tire

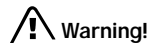

Failure to follow these instructions may result in serious personal injuries to you or to bystanders.

- f If you have a flat tire, move a safe distance off the road. Turn the emergency flasher on and use other warning devices to alert other motorists. Set the parking brake.
- f Do not park your vehicle where it may contact dry grass, brush or other flammable materials. The hot parts of the exhaust system could set such materials on fire, thereby causing both property damage and severe or fatal physical injury.

A tire sealant and compressor with pressure tester are located in the luggage compartment.

- f Please observe the safety and operating instructions on the special sealant bottle with a special Porsche part number and on the compressor – these are essential.

Important note

Sealing the tire with the tire repair kit is only an emergency repair. Even with the tire airtight, it may be used only for short journeys in an emergency.

The maximum permitted speed is 50 mph (80 km/h).

- f Do not use commercially available sealant or tire inflating bottles.
Use only the tire sealant located in the luggage compartment.



Risk of accident.

- f Have tires replaced by a specialist workshop as soon as possible.
- f Avoid hard acceleration and high cornering speeds.

f f f



A - Filler bottle
B - Filler hose

Tire sealant

The tire sealant can be used to seal small cuts, especially in the tire tread.

Sealing the tire with the tire sealant is only an emergency repair, so you can drive to the next workshop. Even with the tire air-tight, it may be used only for short journeys in an emergency.

E31-114

The tire sealant and a compressor with pressure tester can be found in the luggage compartment.

The tire sealant comprises:

- A filler bottle
- A filler hose
- A valve turner and
- A spare valve insert.

! Danger!

Risk of accident.

- f Use the tire sealant only in the case of cuts or punctures no larger than 0.15 in. (4 mm).
- f Never use the tire sealant if the rim is damaged.

! Warning!

The sealant is highly flammable and harmful to health.

- f Fire, naked flame and smoking are prohibited when handling tire sealant.
- f Avoid contact with skin, eyes or clothing.
- f Keep tire sealant away from children.
- f Do not inhale vapors.

In case of contact with the sealant:

- f If sealant gets on the skin or in the eyes, thoroughly rinse the affected part of the body off without delay.
- f Change soiled clothing immediately.
- f Visit a doctor immediately in the event of an allergic reaction.
- f If sealant was swallowed, thoroughly rinse out the mouth without delay and drink plenty of water.
Do not induce vomiting.
See a doctor immediately.

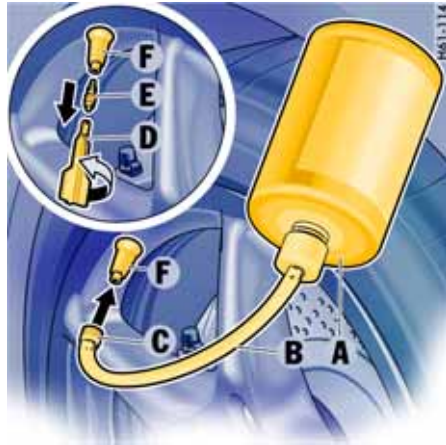

- A - Filler bottle
- B - Filler hose
- C - Plug of the filler hose
- D - Valve turner
- E - Valve insert
- F - Tire valve

Inserting sealant

1. Leave the object that caused the puncture in the tire.
2. Remove sealant and the enclosed sticker from the luggage compartment.
3. Adhere the sticker in the driver's field of vision.
4. Shake filler bottle **A**.

5. Screw filler hose **B** onto the filler bottle. The filler bottle is now open.
6. Unscrew valve cap from tire valve **F**.
7. Remove valve insert **E** from the tire valve with valve turner **D**. Keep the valve insert in a clean and dry place.
8. Remove plug **C** of the filler hose **B**.
9. Push filler hose onto the tire valve.
10. Hold filler bottle higher than the level of the tire valve and press it together forcefully until the bottle is completely emptied into the tire.
11. Pull filler hose off the tire valve.
12. Twist the valve insert firmly into the tire valve using the valve turner.
13. Connect the compressor to the cigarette lighter and inflate the tire to the prescribed tire pressure. Please observe the chapter "TIRE PRESSURES FOR COLD TIRES" on Page 290.
14. Screw valve cap onto the tire valve.
15. Check the tire pressure after driving for around 10 minutes. If the tire pressure is less than 22 psi (1.5 bar), do not continue driving. If a value of more than 22 psi (1.5 bar) is indicated, correct the pressure to the prescribed value.

16. Please consult your authorized Porsche dealer.

Care Instructions

After drying, any sealant that emerges can be peeled off like a film.

Warning!

Risk of accident.

- f Have the tire replaced by an authorized Porsche dealer immediately.
- f Avoid hard acceleration and high cornering speeds.
- f Do not exceed maximum speed of 50 mph (80 km/h).
- f Please always observe the safety and operating instructions, which can be found in the separate operating instructions for the sealant and on the compressor.

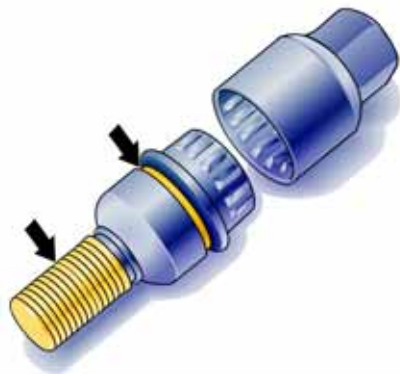

DAI 136

- f Always clean the wheel bolts before fitting.
- f Apply a thin coat of **Optimoly TA** (aluminium paste) on the thread and between the bolt head and movable spherical cap ring (**arrows**).
The bearing surface of the spherical cap facing the wheel must not be greased.
- f Replace damaged wheel bolts.
Only use the Original Porsche wheel bolts specially designed for this vehicle type.

Tightening torque

Tightening torque of wheel bolts:
130 Nm/96 ftlb.

Wheel Bolts



Warning!

Risk of wheel bolt breakage and wheel separation, resulting in severe personal injury or death.

- f Follow all instructions concerning wheel bolts.

Wheel Securing Bolts

The wrench socket for the wheel securing bolts is in the tool pocket.

To loosen or tighten the wheel bolt with anti-theft protection, a wrench socket with the appropriate coding must be used between the wheel bolt and the wheel-bolt spanner.

- f When positioning the wrench socket, ensure that it engages fully in the teeth of the wheel bolt.

If the wheels have to be removed at the workshop, please do not forget to hand over the wrench socket for the wheel securing bolts along with the car key.

Note on operation

On vehicles with 17 mm spacers on the rear axle, the wheels are secured with wheel nuts.

On request, separate anti-theft protection for the wheel nuts can be mounted.

Please consult an authorized Porsche dealer.

Spacers

- f Use the spacers only together with wheels and fastening parts approved by Porsche.
Before having spacers fitted, find out about the current approval status.

911 Carrera 4, 911 Carrera 4S



Risk of accident.

17 mm spacers must only be mounted on the rear axle together with 11.5 J x 19 (67 mm rim offset) wheels.

- f Always remove 17 mm spacers before mounting other wheel sizes or an emergency spare wheel because the wheel cannot be mounted correctly.

911 Carrera, 911 Carrera S

Mounting an emergency spare wheel

If 5 mm spacers are mounted, these must **not** be removed to mount an emergency spare wheel.

Fitting snow chains

The use of snow chains is not permitted when 5 mm spacers are mounted.



Risk of damage to the wheel housings if the 5 mm spacers are not removed before fitting snow chains.

- f To permit the fitting of snow chains, have the 5 mm spacers removed on all 4 wheels.

Note on operation

- f To fit/remove the spacers:
Please consult an authorized Porsche dealer.
- f Please observe the chapter "17 MM SPACERS" on Page 252.
Please observe the chapter "5 MM SPACERS" on Page 253.

Changing a wheel

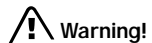

Warning!

Risk of injury. The car may slip off the jack.

- f Make sure that no one is in the vehicle when jacking up and changing a wheel.
- f Always place the car on stable supports if work has to be carried out under the car.

Risk of damage to the brake discs of the Porsche Ceramic Composite Brake (PCCB).

- f Always screw in both assembly aids when changing a wheel.

Note

The tools required for changing a wheel (e.g. jack, wheel bolt wrench, assembly aids) are not supplied with the car.

Your authorized Porsche dealer will be pleased to advise you.

1. Fully apply the handbrake, engage 1st gear or select position **P** and withdraw the ignition key.
 2. Secure the car against rolling away, e.g. by means of wedges under the wheels on the opposite side.
This is particularly important on slopes.
 3. Slightly slacken the wheel bolts of the wheel to be changed.
 4. Raise the car until the wheel lifts off the ground.
- f Please observe the chapter "LIFTING THE VEHICLE WITH A LIFTING PLATFORM OR GARAGE LIFT" on Page 244.



*Screw in assembly aid for vehicles **without** Porsche Ceramic Composite Brake*

5. Remove 1 or 2 wheel bolts (see respective illustration). Screw in assembly aids instead of the wheel bolts.
Remove the remaining wheel bolts.

Note on operation

- f To remove or mount the spacers:
Please observe the chapter "17 MM SPACERS" on Page 252.
Please observe the chapter "5 MM SPACERS" on Page 253.



*Screw in two assembly aids for vehicles **with** Porsche Ceramic Composite Brake*

6. Take the wheel off and put a new wheel on.
7. Please observe the chapter "WHEEL BOLTS" on Page 248.
Screw in wheel bolts; remove assembly aids and screw in the remaining wheel bolts. Initially tighten bolts in diagonally opposite sequence so that the wheel is centered.

8. Lower the car completely.
9. Tighten wheel bolts in diagonally opposite sequence.

Immediately after changing a wheel, use a torque wrench to check the prescribed tightening torque (130 Nm/96 ftlb.).

Checking tire pressure with a pressure gauge

1. Remove the valve stem cap from the tire.
2. Press the pressure gauge onto the valve stem.

Note on operation

- f Do not press too hard or force the valve stem sideways, or air will escape.
If the sound of air escaping from the tire is heard, reposition the pressure gauge.
3. Read the tire pressure on the gauge stem and compare it to the permissible tire pressure.
This information can be found on the tire pressure plate or in the chapter Technical Data.
Please observe the chapter "TIRE PRESSURES FOR COLD TIRES" on Page 290.
4. Remove the pressure gauge.
- f Please observe the chapter "TPC TIRE PRESSURE MONITORING" on Page 109.

17 mm spacers

911 Carrera 4, 911 Carrera 4S



Danger!

Risk of accident.

17 mm spacers must only be mounted on the rear axle together with 11.5 J x 19 (67 mm rim offset) wheels.

- f Always remove 17 mm spacers before mounting other wheel sizes or an emergency spare wheel because the wheel cannot be mounted correctly.
- f For information on the spacers: Please observe the chapter "SPACERS" on Page 249.

Removing the spacers

1. Unscrew the wheel bolts **A** with which the spacer is fastened.
2. Remove the spacer.
3. Screw in 1 or 2 assembly aids instead of the wheel bolts.
4. Fit wheel.



5. Please observe the chapter "WHEEL BOLTS" on Page 248. Insert wheel bolts **A** and tighten by hand. Remove assembly aids, screw in remaining wheel bolts. Initially tighten bolts slightly in diagonally opposite sequence so that the wheel is centred.
6. Lower the car completely.
7. Tighten wheel bolts in diagonally opposite sequence.

Immediately after changing a wheel, use a torque wrench to check the prescribed tightening torque of the wheel bolts (130 Nm/96 ftlb.).

- f Store spacer and wheel nuts together.

Mounting the spacers

1. Remove wheel.
 2. Fit the spacer with the wheel bolts **A** used to fasten the wheel. Initially tighten the wheel bolts slightly in diagonally opposite sequence.
 3. Tighten wheel bolts in diagonally opposite sequence. Tightening torque: **130 Nm (96 ftlb.)**.
 4. Fit wheel.
To do this use the original wheel nuts for fastening the wheels. Tightening torque: **130 Nm (96 ftlb.)**.
 - f Please observe the chapter "CHANGING A WHEEL" on Page 250.
- On request, separate anti-theft protection for the wheel nuts can be mounted.
- f Please consult an authorized Porsche dealer.

5 mm spacers

911 Carrera, 911 Carrera S

Mounting an emergency spare wheel

If 5 mm spacers are mounted, these must **not** be removed to mount an emergency spare wheel.

Fitting snow chains

The use of snow chains is not permitted when 5 mm spacers are mounted.



Caution!

Risk of damage to the wheel housings if the 5 mm spacers are not removed before fitting snow chains.

- ▷ To permit the fitting of snow chains, have the 5 mm spacers removed on all 4 wheels.

- ▷ To fit/remove the spacers:
Please consult an authorized Porsche dealer.

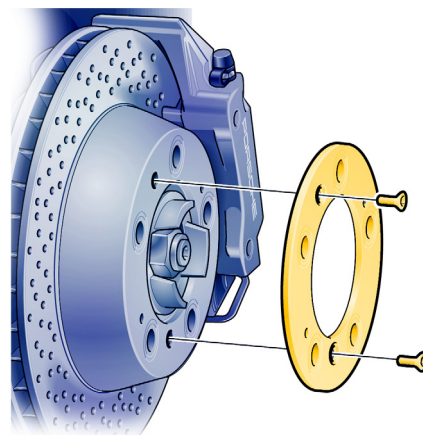

H61-224

- ▷ Please observe the chapter “CHANGING A WHEEL” on Page 250.

Required scope of parts if the spacers are removed

Short countersunk screws (M6x12)
Part No: 900.269.047.09

1 set short wheel bolts
Part No: 996.361.203.02

Short anti-theft protection
Part No: 996.361.057.01

- ▷ For information on the spacers: Please observe the chapter “SPACERS” on Page 249.

▷ ▷ ▷

Removing the spacers

1. Unscrew both countersunk screws (M6x16) on the wheel hub.
2. Remove the spacer.
3. Fasten the brake disc with the **short** M6x12 countersunk screws, part No.: 900.269.047.09.
Tightening torque **10 Nm (7.5 ftlb.)**.
4. For wheel mounting without a spacer, 5 mm **shorter** wheel bolts (part No.: 996.361.203.02) must be used.
Tightening torque: **130 Nm (96 ftlb.)**.

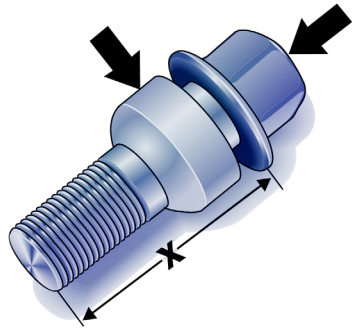

Long wheel bolt
X - bolt length approx. 50 mm
Arrows - marks

Wheel bolt identifying features

The **long** wheel bolts are identified on the face surface of the bolt head with GT or in red, or the moveable spherical cap ring is galvanised in red. The long wheel bolts must only be used together **with** 5 mm spacers fitted.

The **short** wheel bolts are not marked in colour. The short wheel bolts must only be used **without** 5 mm spacers fitted.

Tightening torque for both wheel bolts:
130 Nm (96 ftlb.).

H61-225

Electrical System

In order to avoid damage and faults in electrical or electronic systems, electrical accessories should be installed at your authorized Porsche dealer.

- ▷ Only use accessories authorized by Porsche.



Warning!

Risk of short circuit and fire.
Replacing fuses or relays with the engine running or the ignition on could cause electrical shock.

- ▷ Disconnect the battery during all work on the electrical system.
Please observe the chapter "BATTERY" on Page 258.

Relays

Defective **relays** should be changed only by an authorized workshop.

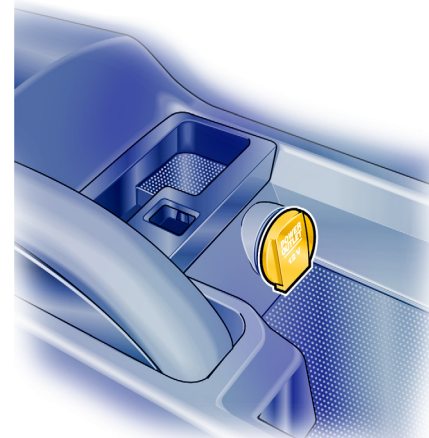

H51-047

In storage tray between the front seats

Sockets

Electrical accessories should preferably be connected to the 12 V sockets.

- ▷ Please observe the maximum power consumption.

Note on operation

The tire filling compressor must be connected to the cigarette lighter.

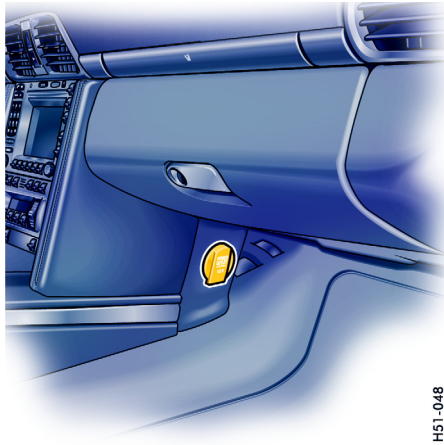

H51-048

In the passenger's footwell

Note on operation

The sockets and thus the connected electrical accessories function even if the ignition is switched off or the ignition key is withdrawn.

If the engine is not running and the accessories are switched on, the vehicle battery will be discharged.

Do not operate additional accessories for more than 5 minutes when engine is off.

Maximum power consumption for both sockets together: 70 W.

- ▷ Please observe the power specifications from the accessory manufacturer.

Alarm system, central locking

The status of the central locking and alarm system is not changed by disconnecting the battery. When the battery is disconnected, the alarm system ceases to function.

Overload protection

If the central locking system is operated more than ten times within a minute, further operation is blocked for 30 seconds.

Load switch-off after 2 hours or 7 days

If the ignition key is removed, loads which are switched on or are in standby mode (such as the luggage compartment light, interior light and radio) are automatically switched off after approx. **2 hours**.

If the vehicle is not started or unlocked with the remote control within **7 days**, the remote control standby function is switched off (to save the vehicle battery).

1. In this case, unlock the driver's door with the key at the door lock.
Leave the door closed in order to prevent the alarm system from being triggered.

2. Press **button 1** on the remote control.

The remote control is now activated again.



A - Diagnostic socket



A - Plastic gripper
B - Spare fuses

Replacing fuses

In order to prevent damage to the electrical system due to short circuits and overloads, the individual circuits are protected by fuses. The fuse box is located in the driver's footwell.

1. Switch off the load with the defective fuse.
2. Pull off plastic cover at the finger hole (**arrow**). The **fuse plan** and **instructions for emergency unlocking of the luggage compartment lid** can be found on the inner side of the cover.
3. Remove the corresponding fuse from its slot using the plastic gripper **A** in order to check it. A blown fuse can be identified by the melted metal strip.
4. Replace only with fuses of the same rating.

Note

- f If a fuse blows repeatedly consult an authorized Porsche dealer.
- f Never try to "repair" fuses: you may cause serious damage to other parts of the electrical system.

Emergency unlocking of the luggage compartment lid

If the battery is discharged, the lid can be opened only with the aid of a donor battery.

Unlocking lid

1. Use the key to unlock the vehicle at the door lock.
2. Remove plastic cover over the fuse box.
3. Pull out positive terminal **A** in the fuse box.
4. Use a jumper cable to connect the positive terminal of the donor battery with positive terminal **A** in the fuse box.



Note

If the vehicle was locked, the alarm horn will sound when the negative cable is connected.

5. Use the second jumper cable to connect the negative terminal of the donor battery with latch striker **B**.
6. Unlock the luggage compartment lid with the remote control.
The alarm system is switched off.

7. Disconnect the negative cable first, then the positive cable.
8. Push the positive terminal **A** into the fuse box and push on the plastic fuse box cover.

Note

The engine cannot be started with this method.

- f Please observe the chapter "EMERGENCY STARTING WITH JUMPER CABLES" on Page 264.

Battery



Risk of short circuit and fire.

- f Observe all warning notes on the battery.
- f Disconnect the battery during all work on the electrical system.
- f Do not lay tools or other metal objects on the battery as they could cause a short circuit across the battery terminal.

Hydrogen gas generated by the battery could cause an explosion, resulting in severe personal injuries.

- f Do not expose the battery to an open flame, electrical spark or a lit cigarette.
- f Do not wipe battery with a dry cloth.

Risk of severe personal injury and damage to the fabric, metal or paint.

- f Wear eye protection.
- f Do not allow battery acid to come in contact with your skin, eyes, fabric or painted surfaces.

- f If you get electrolyte, which is an acid, in your eyes or on your skin, immediately rinse with cold water for several minutes and call a doctor.

- f Spilled electrolyte must be rinsed off at once with a solution of baking soda and water to neutralize the acid.

Battery posts, terminals and related accessories contain lead and lead compounds, chemicals known to the State of California to cause cancer and reproductive harm.

- f Always protect your skin by washing thoroughly with soap and water.

Risk of explosion as a result of static charge.

- f Do not wipe the battery with a dry cloth.
 - f Eliminate potential electrostatic charge by touching the vehicle before touching the battery.
-

Charge state

A well charged battery will not only prevent starting problems but will also last longer.

In order to avoid discharging the battery unintentionally:

- f Switch off unnecessary electrical loads in city traffic, on short trips or in a line or traffic.
- f Always remove the ignition key from the ignition switch when leaving the car.
- f Avoid frequent operation of the convertible top and operation of the Porsche Communication Management system when the engine is not running.

Battery care

- f Ensure that battery is securely mounted.
- f Keep terminals and connections clean and properly tightened.
Corrosion can be prevented by coating the terminals and connections with petroleum jelly or silicone spray.
- f Ensure that vent caps are securely tightened to prevent spillage.

Checking the electrolyte fluid level

Generally, the electrolyte level must be checked more often in summer than in the winter, and more often when driving long distances.

- f When adding water, use only clean containers. In no case may alcohol (e.g. window cleaner residues) be permitted to enter the battery.
- f Unscrew and open the filler vent caps of each cell.

With the car on a level surface, the fluid level should meet the indicator mark in each cell.

- f If necessary, top up with **distilled water**.
Do not use acid.
Only fill up to the mark, otherwise the electrolyte will overflow when the battery is being charged and cause damage.

Battery charging

Automotive batteries lose their efficiency when not in use.

The charge available in your battery can be measured with a battery hydrometer. We recommend that the battery voltage be tested by your Porsche dealer who has the appropriate equipment.

If the car is not driven for prolonged periods, the battery must be charged at least every 6 weeks. A discharged battery allows rapid formation of sulfates, leading to premature deterioration of the plates.

f f f

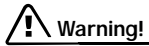

Warning!

Hydrogen gas generated by the battery could cause an explosion, resulting in severe personal injuries.

- f Charge battery in a well ventilated area.
- f Never charge a frozen battery. It may explode because of gas trapped in the ice. Allow a frozen battery to thaw out first.
- f If you get electrolyte, which is an acid, in your eyes or on your skin, immediately rinse with cold water for several minutes and call a doctor.

Slow battery charging

1. Pay attention to all warnings and follow instructions that come with your battery charger.
2. When charging, ensure adequate ventilation.
3. Remove battery.
Please observe the chapter "REMOVING THE BATTERY" on Page 262.
4. All vent caps should be open.
The fluid level should meet the indicator mark in each cell.
5. Ensure that charger is switched off – danger of short circuit!
6. Connect charger cables.
Charger cables must be connected POSITIVE (+) to POSITIVE (+) and NEGATIVE (-) to NEGATIVE (-).
7. Switch on charger.
Normally, a battery should be charged at no more than 10 percent of its rated capacity. Rated capacity of the battery in your vehicle is listed on the battery housing.
8. After charging, turn off charger and disconnect charger cables.
9. Tighten the vent caps and reinstall battery.
Please observe the chapter "INSTALLING THE BATTERY" on Page 263.

Winter operation

The capacity and ability of the battery to store power decreases at low outside temperatures. Additionally, more power is consumed while starting, and the headlights, heater, rear window defogger, etc., are used more frequently.

- f Let your Porsche dealer test the battery's capacity before winter sets in.

The battery will discharge more quickly if your vehicle is not driven on a daily basis over a distance of several miles. The more often you drive your vehicle, and the longer the distance driven on each trip, the more opportunity the vehicle's charging system will have to recharge the batteries.

Replacing battery

The service life of the battery is subject to normal wear; it depends greatly on care, climatic conditions, and driving conditions (distances, loads).

- f Only use an original Porsche battery, with the correct part number, as a replacement.
- f Please observe the disposal instructions for batteries.

Putting vehicle into operation

After the battery is connected or after an **exhaustively discharged** battery is charged, the multifunctional PSM light lights up on the instrument panel and a message appears on the on-board computer to indicate a fault.

This fault can be remedied with a few simple steps:

1. Start the engine.
 2. With the vehicle stationary, perform a few steering movements to the left and right and then drive a short distance in a straight line until the multifunctional PSM light goes out and the message on the on-board computer disappears.
 3. If the warnings do **not** disappear, then:
Drive carefully to the nearest authorized Porsche dealer.
Have the fault remedied.
 4. After the warnings disappear:
Stop the vehicle in a suitable place.
- f Perform adaptation of the power windows:
Please observe the chapter "STORING END POSITION OF THE WINDOWS" on Page 29.

Ignition key/ignition lock

- f Do not insert the ignition key into the ignition lock if the vehicle battery is discharged.
The ignition key can no longer be removed.

The key cannot be removed until the vehicle electrical system is supplied with power again.

- f Please observe the chapter "EMERGENCY UNLOCKING OF THE LUGGAGE COMPARTMENT LID" on Page 257.
- f Please observe the chapter "EMERGENCY STARTING WITH JUMPER CABLES" on Page 264.

f f f

Removing the battery

The required tool is in the tool kit.

The battery is located in the luggage compartment under a black plastic lid.

Warning!

Risk of damage to alternator and electronic control units.

- f Do not disconnect the battery while the engine is running. This also applies to cars equipped with a battery main switch.
- f Never drive the car with a disconnected battery.

Risk of caustic burns from escaping acid.

- f Keep vent caps on to avoid spillage.
- f Do not tilt the battery when removing and installing it.

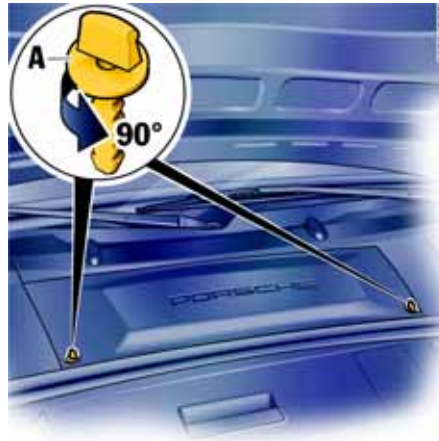

1. Switch off engine and all electrical loads.
2. Open turn-locks **A**. Remove plastic lid.
3. Pull off central vent hose **C**.

Danger!

Risk of short circuit and explosion.

- f Important: disconnect the negative (-) ground wire first, and then the positive (+) cable.



4. Unscrew fastening screw **B**.
5. Remove battery.

Installing the battery

1. Put battery in and push it all the way to the stop.
2. Screw in fastening screw **B**.

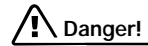

Risk of short circuit and explosion.

f Important: connect the positive (+) cable first, and then the negative (-) ground wire.

3. Push on central vent hose **C**.
4. Fit plastic lid. Lock turn-locks **A**.



H51-062

1. Using your finger nail or a small screwdriver, carefully lift off the cover of the key grip (arrow).
2. Replace the battery (paying attention to the polarity).
Replacement battery – Lithium CR 2032, 3 volts
3. Replace the cover and press together firmly. Please observe the disposal instructions for batteries.

Note

- f Please dispose batteries in compliance with any and all government regulations.

Replacing the remote-control battery

The battery should be changed when the range of the radio remote control becomes smaller or when the light-emitting diode no longer flashes when the remote control is operated.

Emergency Starting with Jumper Cables

If the battery is discharged, e.g. in winter or after the car has been parked for a long time, the battery of another car can be used for starting with the help of jumper cables.

Make sure the voltage of both batteries is the same. Both batteries must be 12 volt types. The capacity (Ampere hours, Ah) of the booster battery must not be substantially less than that of the discharged battery.

The discharged battery must be correctly connected to the vehicle's electrical system.

- f Please observe the chapter "BATTERY" on Page 258.
- f Please observe the chapter "EMERGENCY UNLOCKING OF THE LUGGAGE COMPARTMENT LID" on Page 257.

Note

- f Do not try to start the car by pushing or towing. Damage to the catalytic converters and other components of the car may result.

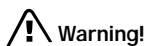

Warning!

Risk of damage and serious personal injury due to short circuit.

- f Use only jumper cables of adequate diameter cross-section and fitted with completely insulated alligator clips.
- f Follow all warnings and instructions of the jumper cable manufacturer.
- f When connecting jumper cables, make sure that they cannot get caught in any moving parts in the engine compartment. The jumper cables must be long enough so that neither vehicles nor cables touch another.
- f The vehicles must not be in contact, otherwise current might flow as soon as the positive terminals are connected.
- f The cable clamps must not be allowed to contact each other when one end of the jumper cables are connected to a battery.
- f Ensure that tools or conductive jewellery (rings, chains, watch straps) do not come into contact with the positive jumper cable or the positive battery post.
- f Improper hook-up of jumper cables can ruin the alternator.

Danger of caustic burns.

- f Do not lean over the battery.

Danger of gas explosion.

- f Improper use of booster battery to start a vehicle may cause an explosion, resulting in severe personal injuries.
- f Keep sources of ignition away from the battery, e.g. open flame, burning cigarettes or sparking due to cable contact or welding work.
- f A discharged battery can freeze even at 23°F/-5°C. Before connecting jumper cables, a frozen battery must be thawed out.

Connect jumper cables in the following sequence:

Always observe the sequence below:

1. Connect the **positive lead (red)** to the positive terminal of the discharged battery first, then connect it to the positive terminal of the donor battery.
2. First connect the **negative cable (black)** to the negative terminal of the donor battery, then connect it to a suitable grounding point on the vehicle with the discharged battery. This grounding point must lie as far as possible from the battery.
For example, a solid metal part or the engine block are suitable grounding points.

If no suitable grounding points are to be found on either vehicle, the negative cable must carefully be connected directly to the negative terminal of the battery.

If a suitable grounding point is to be found only on the donor vehicle, the negative cable must first be connected to the terminal of the discharged battery, then to the grounding point of the donor vehicle.

3. Run the engine of the donor car at a higher speed.

4. Start the engine.

An attempted start using jumper cables should not last more than 15 seconds. Then allow a waiting period of at least one minute.

Note

Before disconnecting the jumper cables, electrical loads such as the heated rear window and the heating fan blower should be switched on (the vehicle's lights must **not** be switched on). This reduces voltage peaks which may occur when disconnecting the jumper cables.

With the engine running, remove both jumper cables in reverse order.

Lights, Replacing Bulbs

Warning!

Risk of short circuit.

- f Always switch off the relevant consumer when changing bulbs.

Risk of injury. The Bi Xenon headlights are under high voltage when installed.

- f Be careful during all work in the area of the Bi Xenon headlights.

Risk of damage. Bulbs of a higher wattage can damage the lamp housing.

- f Only the bulbs shown in the chart may be used.
-
- f New bulbs must be clean and free from oil, grease and fingerprints. **Therefore, never touch bulbs with your bare hands.**
Use a cloth or soft paper while replacing bulbs.

Caution!

Risk of damage to headlights due to excessive temperatures and abrasion.

- f Attach no coverings (e.g. films, "stone guards") in the area of the headlights.
 - f Use soapy water only to clean light lenses and plastic headlight lenses.
In no case may chemical cleaners or other volatile cleaning fluids be used.
 - f To prevent scratches, do not rub with a dry or merely moist cloth, tissue or insect sponges.
-

Bulb chart

	Type, rating
Halogen low beam	H7, 55W
Low beam with Bi-Xenon headlight	Philips, D2S 35W
Halogen high beam	H9, 65W
Additional high beam with Bi-Xenon headlight	H11, 55W
Fog light	H8, 35W
Tail light, rear fog light	P21/4W
Brake light/tail light	P21/4W
Tail light, reflector	P21/5W
Make-up mirror light	K3W
Reversing light	P21
Trun signal indicator light, front and rear	PY21W
Turn signal indicator light, side	WY5W
Side marker light	W3W
Door guard/Curb light	W5W
Parking light	W5W Blue-Vision
License plate light	C5W
Luggage compartment/engine compartment light, interior light	K10W
Reading light	6W Xenon

Headlights

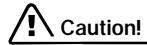

Caution!

Risk of damage to headlights due to abrasion and excessive temperatures.

f Do not fix any coverings (e.g. "stone guards" or films) in the area of the headlights.

Note

The headlights can mist up depending on the temperature and humidity.

f To ensure optimum ventilation, do not cover the gap between headlight and body (e.g. "stone guards" or films).



Removing headlights

1. Unscrew plastic nut **A**.
Detach the side carpeting.

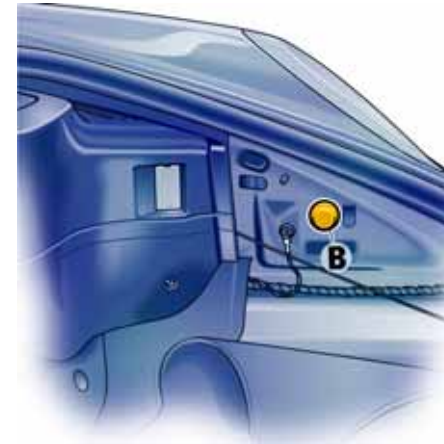

2. Remove rubber plug **B** from the unlocking opening.

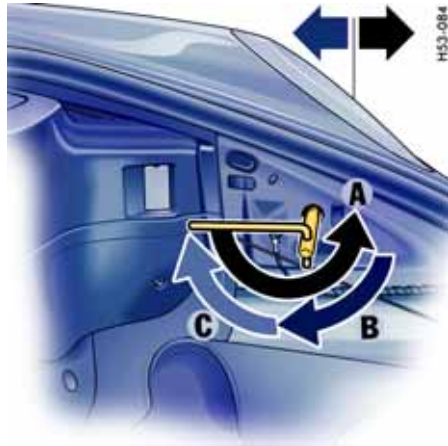

Installing

1. Insert headlight into the guide rails and push fully into the wing.
2. Push headlight to the rear and at the same time turn the socket wrench until it points horizontally to the rear **C**. The headlight locking device must perceptibly and audibly engage.
3. Insert the rubber plug into the unlocking opening and secure the carpet. Check the function of all lights.

3. Place socket wrench (tool kit) on the unlocking spindle.
The handle of the wrench should point horizontally to the rear.
4. Turn socket wrench approx. 180° **A**. The headlight is unlocked and pushed forward slightly during this process.
5. Turn socket wrench back until it is pointing vertically downward **B** and leave in position.
6. The headlight is now unlocked and can be pulled forward out of the wing.

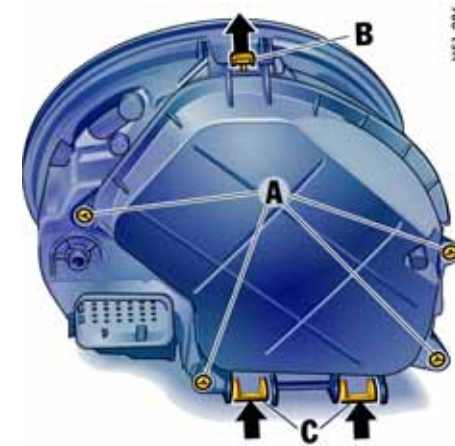

Low beam, high beam and additional high beam

Opening the lid of the headlight housing

1. Unscrew the 4 screws **A**.
2. First lift release tab **B**, then push both release tabs **C** upwards and take off lid.



Halogen headlights
Changing bulb for low beam

1. Pull off plug **A**.
2. Disengage fixing loop **B**.
3. Replace defective bulb.
 When doing so, ensure bulb is seated properly.
4. Reassemble in reverse order.



Bi-Xenon headlight
Changing bulb for low beam and high beam

1. Turn the plug counter-clockwise (bayonet lock) and pull it off.

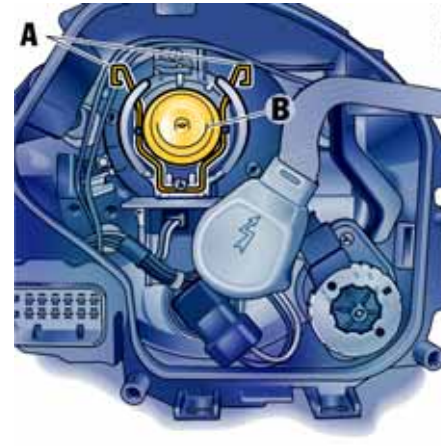

2. Disengage both fixing loops **A**.
3. Replace defective bulb **B**.
 When doing so, ensure bulb is seated properly.
4. Engage both fixing loops **A**, push on plug and turn right as far as the stop.



Changing bulb for high beam or additional high beam (Bi-Xenon headlight)

1. Turn the bulb holder.
Turn it counter-clockwise on the left headlight and clockwise on the right headlight.
Take bulb holder out of the headlight housing.

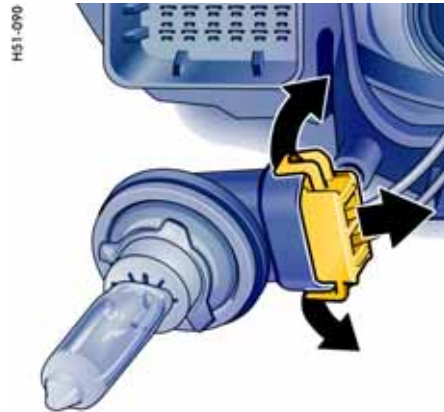

2. Pull both plug release tabs apart.
Pull plug out of the bulb holder.
3. Replace the defective bulb with bulb holder.
4. Reassemble in reverse order.

Closing lid of headlight housing

1. Push on lid until it perceptibly engages.
2. Fasten lid with the 4 screws.

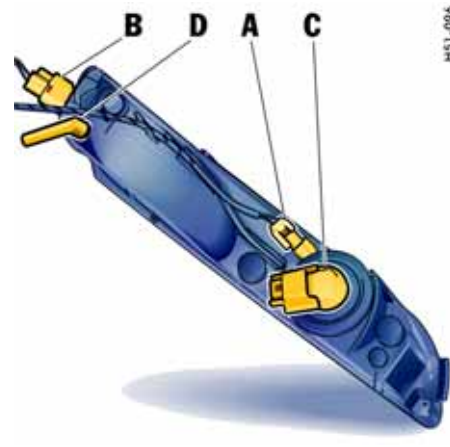

Changing bulbs for parking light, turn signal light and fog light

The release card for the auxiliary headlights is inside the vehicle folder.

1. Insert release card at the side of the auxiliary headlight.
The auxiliary headlight is released by pushing in the card.
The card may have to be pushed again to release the second connection.

2. Remove auxiliary headlight.
Ensure that the vent hose **D** is not lost when the auxiliary headlight is pulled out.

- A** - Parking light
- B** - Turn signal
- C** - Fog light
- D** - Vent hose

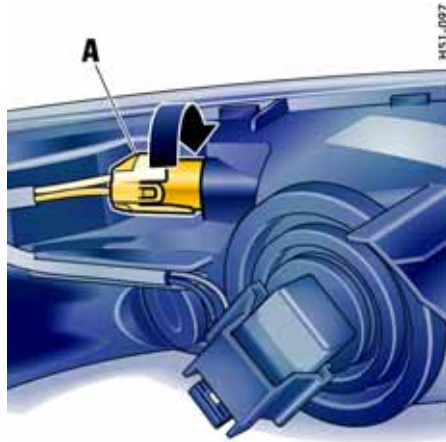

H51-097

Bulb for parking light A

1. Turn holder towards the left and pull it out to the rear.
2. Pull out and replace defective bulb.
3. Push holder back in and turn towards the right.

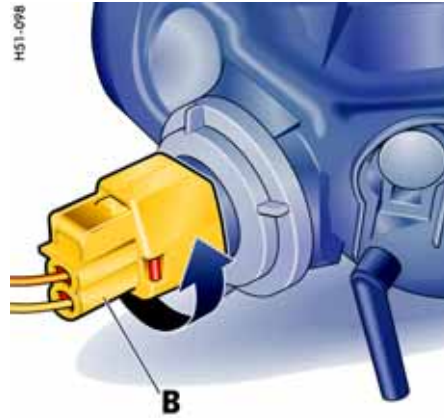

H51-098

Bulb for turn signal B

1. Turn holder counter-clockwise (bayonet lock) and remove it.
2. Turn the defective bulb counter-clockwise (bayonet lock) and replace it.
3. Insert holder and turn towards the right.

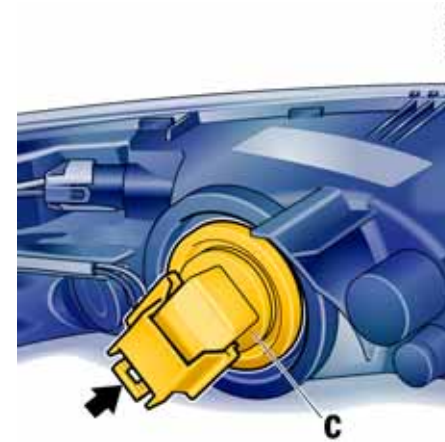

H51-099

Bulb for fog light C

1. Press the release tab of the plug and pull plug off.
2. Turn bulb of the defective left fog light towards the left and the bulb of the right fog light towards the right (bayonet lock) and replace them.
3. Push on plug.

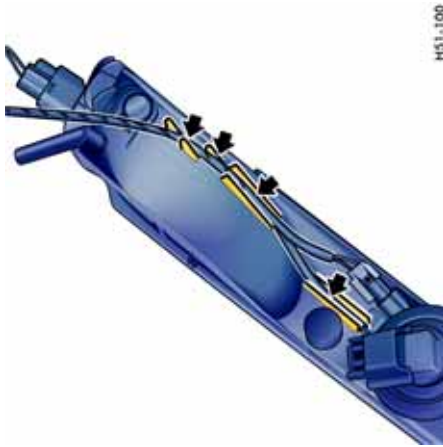

Installing auxiliary headlight

- f Ensure that the cables are inside the guide (arrows) properly.



! Caution!

Risk of paint damage if the auxiliary headlight is inserted into the front apron when tilted.

- f Exercise caution when inserting the auxiliary headlight into the guides of the front apron.
- f Ensure that the guide of the housing is inserted into the guide **A** of the front apron.



- f Push auxiliary headlight into the front apron until it is felt to engage.

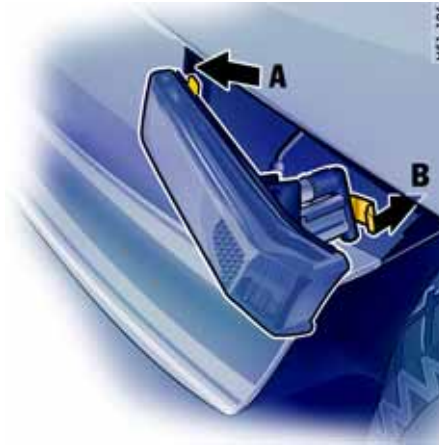
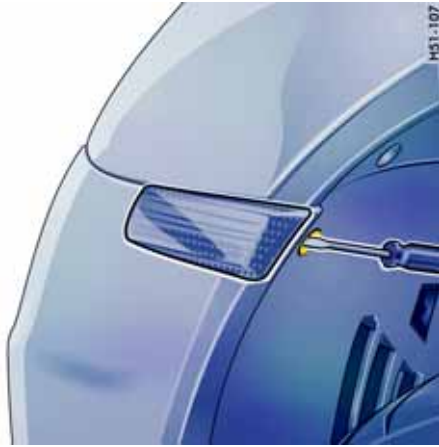

Changing bulb for side marker light

1. Remove the cap in the wheel housing liner with a screwdriver.
2. Insert the screwdriver into the opening in the wheel housing liner at right angles to the turn signal housing.
By pressing with the screwdriver, disengage the securing spring of the turn signal housing.
3. Swivel out the indicator light and undo bulb holder (bayonet lock).
4. Remove the bulb from the holder and replace it. Insert holder.
Check operation of the light.
5. Insert the turn signal's retaining lugs **A** into the side section at the front.
Push in turn signal until the securing spring **B** is felt to engage.
6. Press the cap into the wheel housing liner.

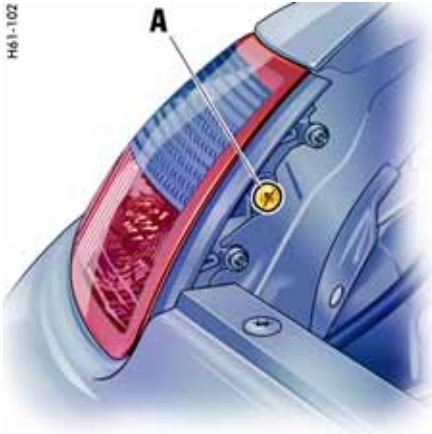

Tail Light

Changing bulb

1. Open the engine compartment lid.
2. Completely unscrew fastening screw **A**.
3. Pull tail light out towards the back.

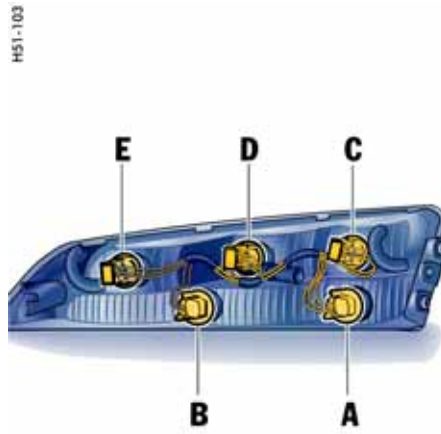

- A** - Reversing light
- B** - Turn signal
- C** - Tail light/brake light
- D** - Tail light/reflector
- E** - Rear fog light/side marker light

4. Turn the bulb holder in the tail light housing counter-clockwise and pull it out.
5. Turn the defective bulb counter-clockwise (bayonet lock) and replace it.
6. Insert the bulb holder and turn it clockwise.



7. Insert tail light into the side section. Ensure that the retaining lug has been inserted into the mounting guide properly.
8. Tighten fastening screw **A** on the tail light.
9. Check operation of the light.



License Plate Light

Changing bulb

1. Unscrew both screws **A** and remove the light lens.
2. Remove defective bulb from between the contact springs and replace it.
3. Reassemble in reverse order. Check operation of the light.



Example: Luggage compartment light

Luggage Compartment/Engine Compartment/Footwell Light

Changing bulb

1. With a screwdriver (**arrow**), carefully push out the light.
2. Remove defective bulb from between the contact springs and replace.
3. Insert the light into the cut-out, first from one side then from the other. Check operation.

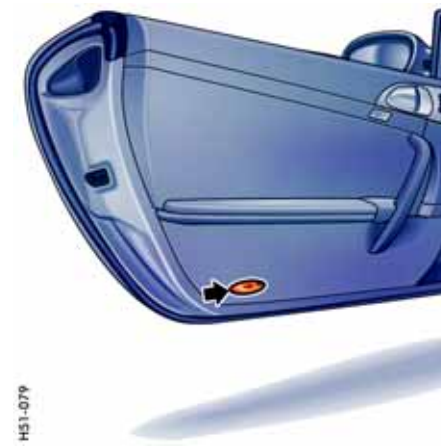

Door Guard/Curb Light

Changing bulb

1. With a screwdriver (**arrow**), carefully push out the light.
2. Pull bulb holder out of light housing. Remove defective bulb and replace.
3. Install bulb holder and insert light.

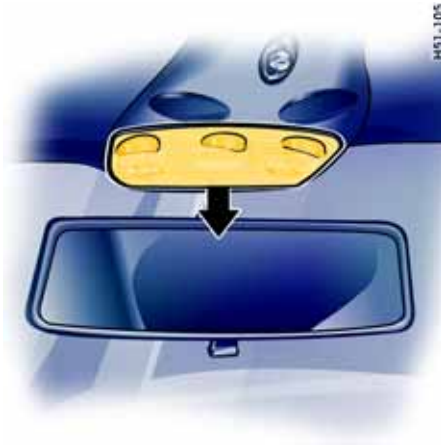

Interior Light, Reading Lights

Changing bulb

1. Carefully pull light housing out of the trim (arrow).



2. Reading light

Turn the holder **A** of the defective bulb counter-clockwise and pull it out. Remove bulb and replace.

Interior light

Carefully unclip the light lens on the switch side (**arrows**) and then detach it. Remove defective bulb from between the contact springs and replace. Clip light lens back in.

3. Insert the light housing into the trim, rear end first. Press front of housing up and click into place. Check operation of lights.

Additional brake lights

The light-emitting diodes of the additional brake lights cannot be replaced individually.

- f Have the defective brake light replaced at an authorized Porsche dealer.

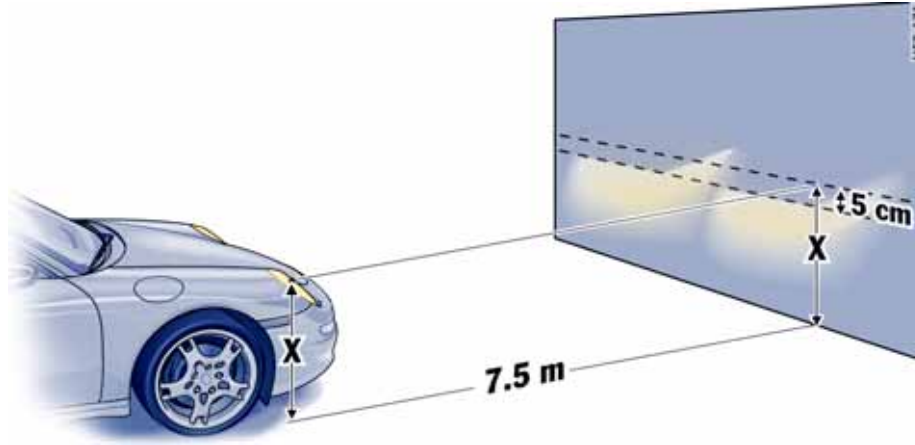

Adjusting Headlights

f Please observe the chapter "LIGHTS, REPLACING BULBS" on Page 266.

Adjustment

The adjustment is made with the vehicle ready to drive and the fuel tank completely filled.

The driver's seat must be loaded by a person or a 165 lbs. (75 kg) weight and the tire pressures must meet the prescribed values.

After being loaded, the car must be rolled a few meters so that the suspension can settle.

For checking the headlight adjustment, the vertical position of the cutoff of the lowbeam (see fig.) has to be projected on a vertical screen (wall) in distance of 7.5 m (24.6 ft.) from the front lens of the headlamp.

The correct position of the cutoff is 5 cm (2.0 in.) at 7.5 m or 24.6 ft. (0.4°) below a horizontal line, **x** cm from ground to the center of the headlamp lens.

Lateral adjustment of the headlights should be carried out at a specialist workshop with an optical adjustment unit.

Distance

Visual aim shall be performed at not less than 7.5 m (this value is a rounded down conversion from the 25-foot distance typical of field aim using a screen). The 7.5 m (24.6 ft.) distance is measured from the headlamp lens to the viewing screen.

f f f

Floor

The surface upon which the vehicle rests is flat and approximately level.

Screen

The screen upon which headlamp beams are projected is perpendicular to the floor and the vehicle's longitudinal axis, flat, uniformly light in color, unobstructed, and wide and high enough to accommodate the vehicle beam patterns to be aimed.

The screen should be wide enough to provide at least 1 m (3.3 ft.) of space outboard of the vehicle's headlamp spacing.



Adjustment screws

- f Detach side carpeting in luggage compartment.
Therefore unscrew plastic nut **A**.
Open the cover of the appropriate adjustment screw.
The setting is adjusted by turning the hexagon socket screws right or left, as appropriate.



B - Headlight vertical adjustment

Vertical adjustment (screw B)

- f turn clockwise = beam moves down
turn counter-clockwise = beam moves up

Note

- f Do not alter the lateral adjustment.

Towing

Certain state statutes and local ordinances prohibit towing with a chain, rope or even a tow bar. In addition, damage to your vehicle may result from improper procedures. Consult your authorized Porsche dealer for details.

Vehicle towing

Flat bed towing is the preferred type of towing to be used on Porsche vehicles.

Under certain circumstances, wheel lifts may be used when the vehicle will not roll.

The vehicle must be towed with all four wheels off the ground, otherwise damage to the vehicle may result.

Towing hook

The towing hook is contained in the tool kit.



Caution!

Risk of damage to the vehicle.

- f Use the towing hook only for an emergency to remove the vehicle off the road. The towing hook is to be used only to pull the vehicle onto the flat bed, tractor or towing apparatus if the vehicle will roll freely. Under no circumstances is the vehicle to be secured using the towing hook.



- f Never use the towing hook to tow this or any other vehicle.
- f Bear in mind the limited ground clearance of your car on uneven surfaces.

Front mounting

The towing hook is **A** stored in the tool box in the luggage compartment.

1. Press the lower edge of the appropriate plastic cover into the bumper until the cover disengages.
2. Pull cover out of the bumper and let it hang by its thread.
3. Completely screw in the towing hook.



Rear mounting

1. Remove license plate.
2. Unscrew the towing hook **A**.
3. Insert plastic cover at the lower edge of the opening.
4. Fold the cover up and press on its upper edge to engage it in the bumper.
5. Completely screw in the towing hook.



Pulling vehicle onto flat bed

1. Position wooden ramps at the base of the flat bed to reduce the angle of the pull.
2. Reel in the hoist cable and check the underside of the vehicle for any interference.



Tying down vehicle on flat bed

1. Carefully feed towing straps through the opening in the **rear wheels**.
Make sure metal parts of straps do not damage rim.
Make sure the strap is flat over the rim bead.
Make sure brake backing plate is not damaged.
2. Secure straps to rear of flat bed.
3. Reel in hoist cable only far enough to tension tie-down straps.

4. Carefully feed towing straps through the opening in the **front wheels**.
Make sure metal parts of straps do not damage rim.
Make sure the strap is flat over the rim bead.
Make sure brake backing plate is not damaged.
5. Secure straps to front of flat bed.
6. Release tension on hoist cable, but do not disconnect.
Use hoist cable as a safety cable.

Vehicle Identification, Technical Data

Vehicle Identification

When ordering spare parts or making inquiries, please always quote the vehicle identification number.

Vehicle data bank

The vehicle data bank is attached to the inside of the "Maintenance" booklet. It contains all important data about your vehicle.

Note

This data bank cannot be re-ordered if it is lost or damaged.

This label contains the following information:

1. Vehicle Identification No.
2. Type/Type description
3. Engine code/Transmission code
4. Paint No./Interior
5. Optional equipment

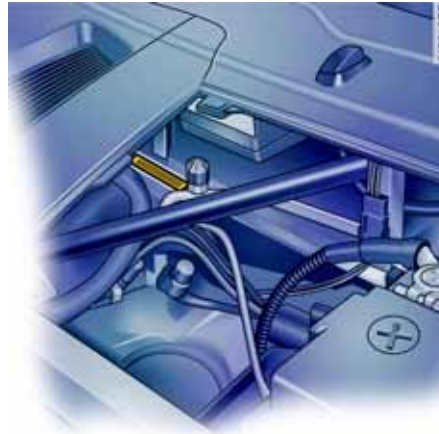

Vehicle identification number

In accordance with Federal Safety Regulations, the vehicle identification number of your car is located at the bottom left of the windshield frame and can be seen from the outside.

The vehicle identification number is in the luggage compartment under the battery cover and at the bottom left behind the windshield.

Removing the battery cover

f Please observe the chapter „BATTERY“ on page 258.



Safety compliance sticker

The safety compliance sticker is your assurance that your new Porsche complies with all applicable Federal Motor Vehicle Safety Standards which were in effect at the time the vehicle was manufactured.

The sticker also shows the month and year of production and the vehicle identification number of your car (perforations) as well as the **Gross Vehicle Weight Rating** and the **Gross Axle Weight Rating**.



Tire pressure plate

The tire pressure plate is attached to the left-hand door aperture.

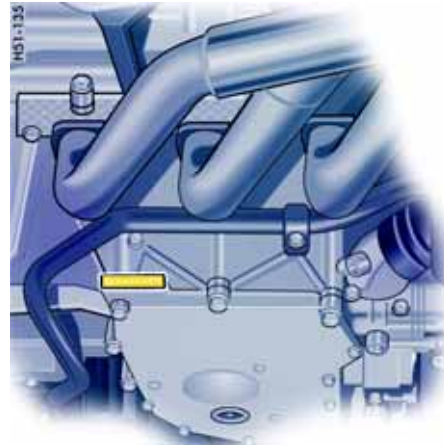

Engine number

The engine number is stamped on the underside of the crankcase.

Technical Data

Engine data

	911 Carrera, 911 Carrera 4	911 Carrera S, 911 Carrera 4S	911 Carrera S, 911 Carrera 4S (increased performance version)
Type	M 96/05 Horizontally opposed engine, liquid cooled	M 97/01 Horizontally opposed engine, liquid cooled	M 97/01S Horizontally opposed engine, liquid cooled
Number of cylinders	6	6	6
Bore	3.78 in./96 mm	3.90 in./99 mm	3.90 in./99 mm
Stroke	3.26 in./82.8 mm	3.26 in./82.8 mm	3.26 in./82.8 mm
Cubic capacity	219.4 cu. in./3596 cm ³	233.3 cu. in./3824 cm ³	233.3 cu. in./3824 cm ³
Net-horsepower, SAE J 1349 at crankshaft speed	325 hp/239 kW 6800 rpm	355 hp/261 kW 6600 rpm	381 hp/280 kW 7200 rpm
Net torque, SAE J 1349 at crankshaft speed	273 ft. lb./370 Nm 4250 rpm	295 ft. lb./400 Nm 4600 rpm	307 ft. lb./415 Nm 5500 rpm
Engine control	Stationary high-voltage distribution, sequential injection, cylinder-selective knock-control, stereo oxygen sensor closed-loop control, diagnostic system, 4 overhead camshafts, Porsche VarioCam Plus, hydraulic valve clearance compensation		

Transmission

		Manual transmission	Tiptronic S
1st gear		3.91	3.60
2nd gear		2.32	2.19
3rd gear		1.61	1.41
4th gear		1.28	1.00
5th gear		1.08	0.83
6th gear		0.88	
Reverse	1st gear	3.59	3.17
	2nd gear		1.93
Final drive ratio		3.44	3.56

Tires, Rims, Tracks 911 Carrera, 911 Carrera S

		Tire	Rim	Rim offset	Track
Summer tires*	front	235/40 ZR 18 (91Y)	8 J x 18 H2	57 mm	58.5 in./1486 mm
	rear	265/40 ZR 18 (101Y) XL	10 J x 18 H2	58 mm	60.4 in./1534 mm
or	front	235/35 ZR 19 (87Y)	8 J x 19 H2	57 mm	58.5 in./1486 mm
	rear	295/30 ZR 19 (100Y) XL	11 J x 19 H2	67 mm	59.7 in./1516 mm
or	front	235/35 ZR 19 (87Y)	8.5 J x 19 H2	55 mm	58.7 in./1490 mm
	rear	305/30 ZR 19 (102Y) XL	11.5 J x 19 H2	67 mm	59.7 in./1516 mm
Snow tires	front	235/40 R 18 91V M+S	8 J x 18 H2	57 mm	58.5 in./1486 mm
	rear	265/40 R 18 97V M+S**	10 J x 18 H2	58 mm	60.4 in./1534 mm
or	front	235/35 R 19 87V M+S	8 J x 19 H2	57 mm	58.5 in./1486 mm
	rear	295/30 R 19 100V XL M+S	11 J x 19 H2	67 mm	59.7 in./1516 mm

The load capacity coefficient (e.g. "91") and maximum speed code letter (e.g. "Y") are minimum requirements.

Snow chains Can be mounted only on the rear wheels; **maximum speed 30 mph (50 km/h)**.

Use only Porsche authorized fine-link cross-type or edge chains.

Snow chain clearance can be guaranteed only on the tire + rim combination marked without spacers.**

Tire and rim sizes Extensive tests are performed before specific tires and wheels are approved by Porsche. Your Porsche dealer has information about approved tires and wheels and is happy to assist you.

If aftermarket tires and/or wheels are installed which are not approved by Porsche, the vehicle's roadability and handling characteristics might be impaired. Since Porsche has no data on such combinations, Porsche cannot stand behind the safety or durability of these aftermarket combinations.

* 911 Carrera S: Summer tires 19-inch only

Tires, Rims, Tracks 911 Carrera 4, 911 Carrera 4S

		Tire	Rim	Rim offset	Track
Summer tires*	front	235/40 ZR 18 (91Y)	8 J x 18 H2	57 mm	58.6 in./1488 mm
	rear	295/35 ZR 18 (99Y)	11 J x 18 H2	51 mm	60.9 in./1548 mm
or	front	235/35 ZR 19 (87Y)	8 J x 19 H2	57 mm	58.6 in./1488 mm
	rear	305/30 ZR 19 (102Y) XL	11 J x 19 H2	51 mm	60.9 in./1548 mm
or	front	235/35 ZR 19 (87Y)	8.5 J x 19 H2	55 mm	58.7 in./1492 mm
	rear	305/30 ZR 19 (102Y) XL	11.5 J x 19 H2**	67 mm	61.0 in./1550 mm
Snow tires	front	235/40 R 18 91V M+S	8 J x 18 H2	57 mm	58.6 in./1488 mm
	rear	295/35 R 18 99V M+S***	11 J x 18 H2	51 mm	60.9 in./1548 mm
or	front	235/35 R 19 87V M+S	8 J x 19 H2	57 mm	58.6 in./1488 mm
	rear	295/30 R 19 100V XL M+S***	11 J x 19 H2	51 mm	60.9 in./1548 mm

The load capacity coefficient (e.g. "91") and maximum speed code letter (e.g. "Y") are minimum requirements.

Snow chains Can be mounted only on the rear wheels; **maximum speed 30 mph (50 km/h).**

Use only Porsche authorized fine-link cross-type or edge chains.

Snow chain clearance can be guaranteed only on the tire + rim combination marked*.**

Tire and rim sizes Extensive tests are performed before specific tires and wheels are approved by Porsche. Your Porsche dealer has information about approved tires and wheels and is happy to assist you.

If aftermarket tires and/or wheels are installed which are not approved by Porsche, the vehicle's roadability and handling characteristics might be impaired. Since Porsche has no data on such combinations, Porsche cannot stand behind the safety or durability of these aftermarket combinations.

* 911 Carrera 4S: Summer tires 19-inch only ** Only approved together with 17 mm spacers

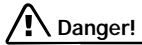

Danger!

Installation of sizes not authorized by Porsche may have a dangerous effect on the driving stability and could result in severe personal injury or death.

f Before mounting new tires, check with your Porsche dealer about the current release status.

Tire Pressures for cold tires

Summer and snow tires 911 Carrera, 911 Carrera S

18 inch wheels	front	36 psi (2.5 bar)
	rear	44 psi (3.0 bar)
19 inch wheels, partially loaded (up to 2 persons without luggage)	front	33 psi (2.3 bar)
	rear	39 psi (2.7 bar)
19 inch wheels, fully loaded (as of 2 persons with luggage)	front	36 psi (2.5 bar)
	rear	44 psi (3.0 bar)

Summer and snow tires 911 Carrera 4, 911 Carrera 4S

18 inch and 19 inch wheels, partially loaded (up to 2 persons without luggage)	front	33 psi (2.3 bar)
	rear	39 psi (2.7 bar)
18 inch and 19 inch wheels, fully loaded (as of 2 persons with luggage)	front	36 psi (2.5 bar)
	rear	44 psi (3.0 bar)

These tire filling pressures apply only to the tire makes and types approved by Porsche. Please observe the chapter "TIRES/WHEELS" on Page 229. Please observe the chapter "TPC TIRE PRESSURE MONITORING" on Page 109.

Capacities

Use only fluids and fuels authorized by Porsche. Your authorized Porsche dealer will gladly advise you.

Your Porsche has been designed so that it is not necessary to mix any additives with oils or fuels.

Engine	911 Carrera, 911 Carrera 4: Oil change quantity without oil filter approx. 8.5 quarts / 8.0 liters 911 Carrera, 911 Carrera 4: Oil change quantity with oil filter approx. 8.7 quarts / 8.25 liters 911 Carrera S, 911 Carrera 4S: Oil change quantity without oil filter approx. 8.7 quarts / 8.25 liters 911 Carrera S, 911 Carrera 4S: Oil change quantity with oil filter approx. 9 quarts / 8.5 liters Please observe the chapter "ENGINE OIL" on Page 201.
Coolant	approx. 8.45 U.S. gallons / 32 liters
Manual transmission and differential	approx. 3.1 quarts / 2.9 liters transmission oil
Tiptronic S	approx. 9.5 quarts / 9 liters ATF
Differential for Tiptronic S	approx. 1.3 quarts / 1.2 liter
Fuel tank	911 Carrera, 911 Carrera S: approx. 16.9 U.S. gallons / 64 liters 911 Carrera 4, 911 Carrera 4S: approx. 17.7 U.S. gallons / 67 liters
Fuel quality	Your engine is designed to provide optimum performance and fuel economy using unleaded premium fuel with an octane rating of 98 RON (93 CLC or AKI) . Porsche therefore recommends the use of these fuels in your vehicle. Porsche also recognizes that these fuels may not always be available. Be assured that your vehicle will operate properly on unleaded premium fuels with octane numbers of at least 95 RON (90 CLC or AKI) , since the engine's "Electronic Oktane™ knock control" will adapt the ignition timing, if necessary.
Power steering	approx. 1.35 quarts / 1.27 liter hydraulic fluid Pentosin CHF 11 S [®] or Pentosin CHF 202 [®]
Brake fluid	0.48 quarts / 0.45 liters; use only Original Porsche brake fluid.
Windshield washer	approx. 2.6 quarts / 2,5 liters without headlight washer approx. 6.3 quarts / 6 liters with headlight washer

Weights Coupé

911 Carrera

Empty weight (depending on equipment)

Manual transmission

1395 kg to 1495 kg
3075 lbs. to 3296 lbs.

Tiptronic S

1435 kg to 1535 kg
3164 lbs. to 3384 lbs.

Maximum gross weight

3990 lbs./1810 kg

4090 lbs./1855 kg

Maximum axle load, front*

1709 lbs./775 kg

1709 lbs./775 kg

Maximum axle load, rear*

2601 lbs./1180 kg

2601 lbs./1180 kg

Maximum useful load, Roof Transport System**

165 lbs./75 kg

165 lbs./75 kg

911 Carrera S

Empty weight (depending on equipment)

Manual transmission

1420 kg to 1510 kg
3131 lbs. to 3329 lbs.

Tiptronic S

1460 kg to 1550 kg
3219 lbs. to 3417 lbs.

Maximum gross weight

4012 lbs./1820 kg

4112 lbs./1865 kg

Maximum axle load, front*

1709 lbs./775 kg

1709 lbs./775 kg

Maximum axle load, rear*

2601 lbs./1180 kg

2601 lbs./1180 kg

Maximum useful load, Roof Transport System**

165 lbs./75 kg

165 lbs./75 kg

* The maximum gross weight must not be exceeded.

Note: If additional accessories are installed, the useful load will be correspondingly less.

** Use only Original Porsche Roof Transport System.

Weights Coupé

911 Carrera 4

	Manual transmission	Tiptronic S
Empty weight (depending on equipment)	1450 kg to 1550 kg 3197 lbs. to 3417 lbs.	1490 kg to 1590 kg 3285 lbs. to 3505 lbs.
Maximum gross weight	4112 lbs./1865 kg	4211 lbs./1910 kg
Maximum axle load, front*	1819 lbs./825 kg	1819 lbs./825 kg
Maximum axle load, rear*	2690 lbs./1220 kg	2690 lbs./1220 kg
Maximum useful load, Roof Transport System**	165 lbs./75 kg	165 lbs./75 kg

911 Carrera 4S

	Manual transmission	Tiptronic S
Empty weight (depending on equipment)	1475 kg to 1565 kg 3252 lbs. to 3450 lbs.	1515 kg to 1605 kg 3340 lbs. to 3538 lbs.
Maximum gross weight	4134 lbs./1875 kg	4233 lbs./1920 kg
Maximum axle load, front*	1819 lbs./825 kg	1819 lbs./825 kg
Maximum axle load, rear*	2690 lbs./1220 kg	2690 lbs./1220 kg
Maximum useful load, Roof Transport System**	165 lbs./75 kg	165 lbs./75 kg

* The maximum gross weight must not be exceeded.

Note: If additional accessories are installed, the useful load will be correspondingly less.

** Use only Original Porsche Roof Transport System.

Weights Cabriolet

911 Carrera

Empty weight (depending on equipment)

Maximum gross weight

Maximum axle load, front*

Maximum axle load, rear*

Manual transmission

1480 kg to 1560 kg

3263 lbs. to 3439 lbs.

4134 lbs./1875 kg

1709 lbs./775 kg

2690 lbs./1220 kg

Tiptronic S

1520 kg to 1600 kg

3351 lbs. to 3527 lbs.

4233 lbs./1920 kg

1709 lbs./775 kg

2690 lbs./1220 kg

911 Carrera S

Empty weight (depending on equipment)

Maximum gross weight

Maximum axle load, front*

Maximum axle load, rear*

Manual transmission

1505 kg to 1575 kg

3318 lbs. to 3472 lbs.

4156 lbs./1885 kg

1709 lbs./775 kg

2690 lbs./1220 kg

Tiptronic S

1545 kg to 1615 kg

3406 lbs. to 3560 lbs.

4255 lbs./1930 kg

1709 lbs./775 kg

2690 lbs./1220 kg

* The maximum gross weight must not be exceeded.

Note: If additional accessories are installed, the useful load will be correspondingly less.

Weights Cabriolet

911 Carrera 4

	Manual transmission	Tiptronic S
Empty weight (depending on equipment)	1535 kg to 1610 kg 3384 lbs. to 3549 lbs.	1575 kg to 1650 kg 3472 lbs. to 3638 lbs.
Maximum gross weight	4233 lbs./1920 kg	4332 lbs./1965 kg
Maximum axle load, front*	1819 lbs./825 kg	1819 lbs./825 kg
Maximum axle load, rear*	2690 lbs./1220 kg	2690 lbs./1220 kg

911 Carrera 4S

	Manual transmission	Tiptronic S
Empty weight (depending on equipment)	1560 kg to 1620 kg 3439 lbs. to 3571 lbs.	1600 kg to 1660 kg 3527 lbs. to 3660 lbs.
Maximum gross weight	4255 lbs./1930 kg	4354 lbs./1975 kg
Maximum axle load, front*	1819 lbs./825 kg	1819 lbs./825 kg
Maximum axle load, rear*	2690 lbs./1220 kg	2690 lbs./1220 kg

* The maximum gross weight must not be exceeded.

Note: If additional accessories are installed, the useful load will be correspondingly less.

Driving Performance Coupé*

911 Carrera

	Manual transmission	Tiptronic S
Top speed	177 mph (285 km/h)	174 mph (280 km/h)
Acceleration 0 - 100 km/h (62 mph)	5.0 seconds	5.5 seconds

911 Carrera S

	Manual transmission	Tiptronic S	Manual transmission (increased performance version)	Tiptronic S (increased performance version)
Top speed	182 mph (293 km/h)	177 mph (285 km/h)	187 mph (300 km/h)	183 mph (294 km/h)
Acceleration 0 - 100 km/h (62 mph)	4.8 seconds	5.3 seconds	4.6 seconds	5.1 seconds

911 Carrera 4

	Manual transmission	Tiptronic S
Top speed	174 mph (280 km/h)	171 mph (275 km/h)
Acceleration 0 - 100 km/h (62 mph)	5.1 seconds	5.6 seconds

911 Carrera 4S

	Manual transmission	Tiptronic S	Manual transmission (increased performance version)	Tiptronic S (increased performance version)
Top speed	179 mph (288 km/h)	174 mph (280 km/h)	184 mph (296 km/h)	180 mph (290 km/h)
Acceleration 0 - 100 km/h (62 mph)	4.8 seconds	5.3 seconds	4.6 seconds	5.1 seconds

* At DIN empty weight and half load, without performance-inhibiting extra equipment

Driving Performance Cabriolet*

911 Carrera

	Manual transmission	Tiptronic S
Top speed	177 mph (285 km/h)	174 mph (280 km/h)
Acceleration 0 - 100 km/h (62 mph)	5.2 seconds	5.7 seconds

911 Carrera S

	Manual transmission	Tiptronic S	Manual transmission (increased performance version)	Tiptronic S (increased performance version)
Top speed	182 mph (293 km/h)	177 mph (285 km/h)	187 mph (300 km/h)	183 mph (294 km/h)
Acceleration 0 - 100 km/h (62 mph)	4.9 seconds	5.4 seconds	4.7 seconds	5.2 seconds

911 Carrera 4

	Manual transmission	Tiptronic S
Top speed	174 mph (280 km/h)	171 mph (275 km/h)
Acceleration 0 - 100 km/h (62 mph)	5.3 seconds	5.8 seconds

911 Carrera 4S

	Manual transmission	Tiptronic S	Manual transmission (increased performance version)	Tiptronic S (increased performance version)
Top speed	179 mph (288 km/h)	174 mph (280 km/h)	184 mph (296 km/h)	180 mph (290 km/h)
Acceleration 0 - 100 km/h (62 mph)	4.9 seconds	5.4 seconds	4.7 seconds	5.2 seconds

* At DIN empty weight and half load, without performance-inhibiting extra equipment

Dimensions

	911 Carrera, 911 Carrera S	911 Carrera 4, 911 Carrera 4S
Length	175.6 in./4461 mm	175.6 in./4461 mm
Width	71.2 in./1808 mm	72.9 in./1852 mm
Height	51.6 in./1310 mm	51.6 in./1310 mm
Wheelbase	92.5 in./2350 mm	92.5 in./2350 mm
Ground clearance at maximum gross weight	911 Carrera: 4.1 in./104 mm	911 Carrera 4: 4.1 in./103 mm
Turning circle	35.8 ft./10.9 m	35.8 ft./10.9 m
Vehicles with PASM		
Height	51.2 in./1300 mm	51.2 in./1300 mm
Ground clearance at maximum gross weight	911 Carrera: 3.9 in./99 mm 911 Carrera S: 4.1 in./103 mm	911 Carrera 4: 3.7 in./95 mm 911 Carrera 4S: 3.9 in./98 mm

Diagrams

Acceleration diagram

Values have been determined at DIN empty weight and with a 50 % load without additional equipment.

Transmission diagram

The transmission diagram is based on standard values on the basis of a mean effective scrub radius. Changes of the scrub radius, the tire tolerance, wear and tear, deviating country equipment and tire slip have not been taken into account.

Engine diagram at full power – 911 Carrera, 911 Carrera 4

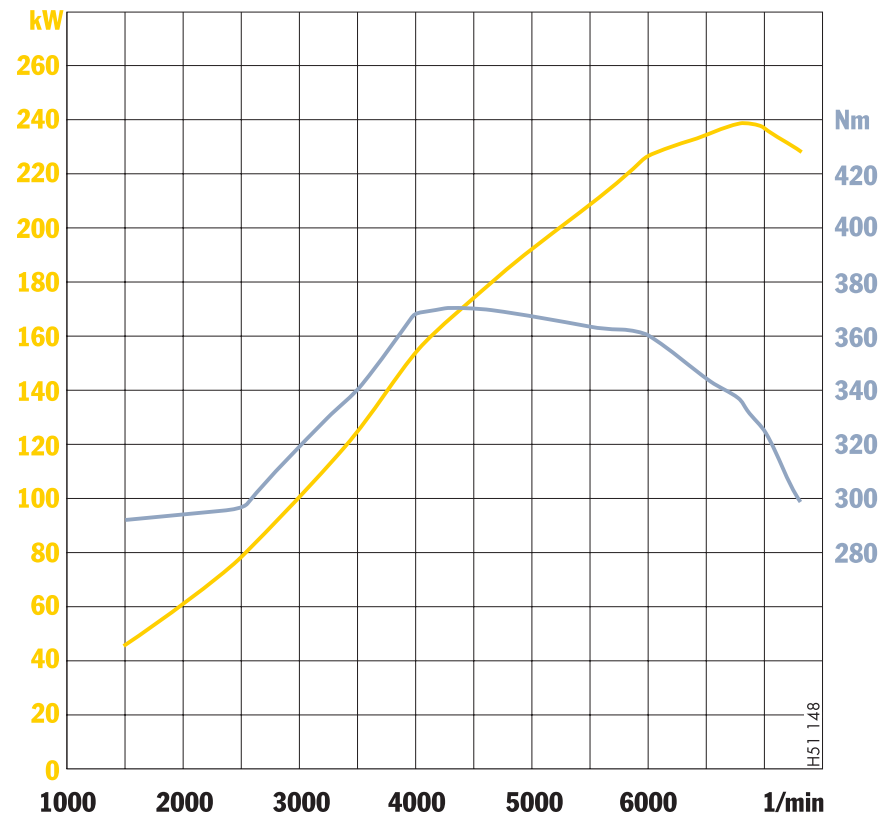

Engine diagram at full power – 911 Carrera S, 911 Carrera 4S

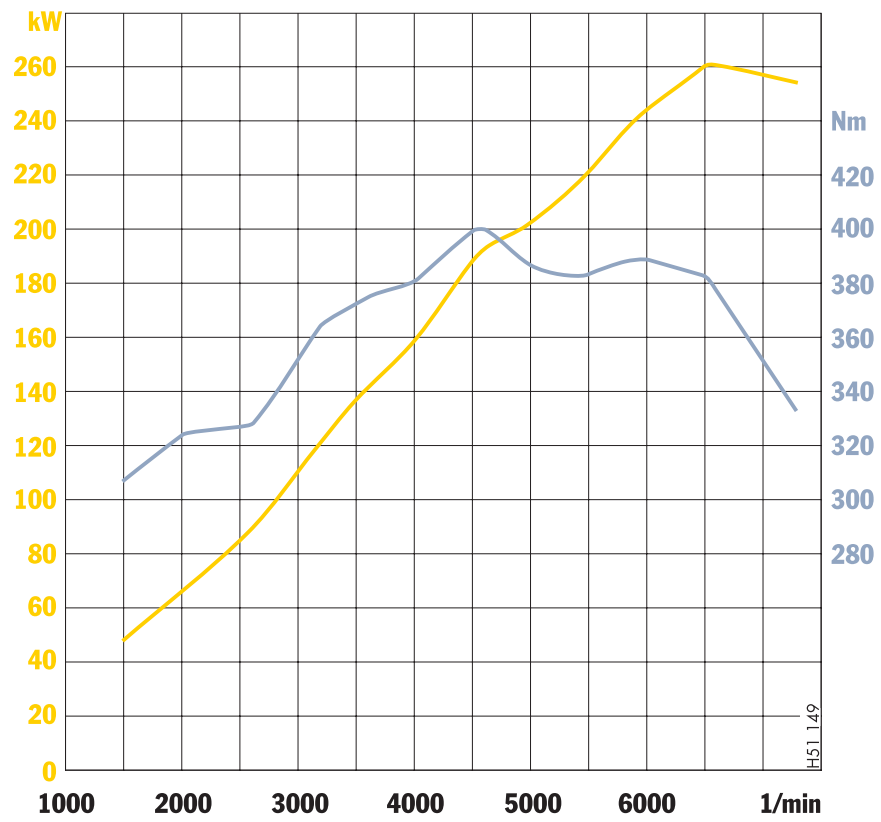

Acceleration diagram for manual transmission – 911 Carrera, 911 Carrera 4

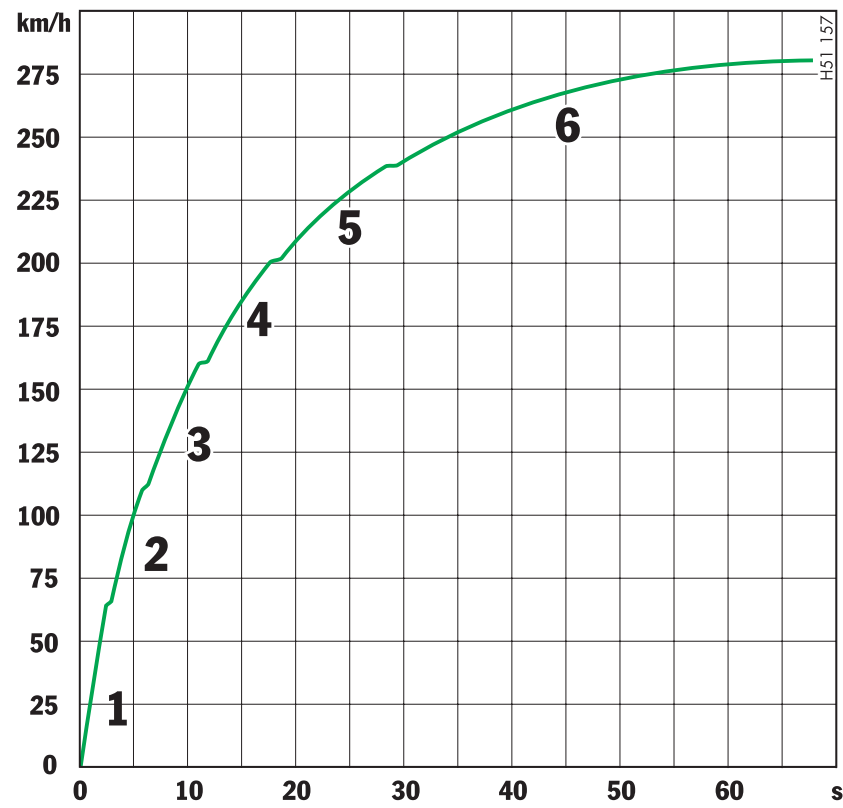

Acceleration diagram for manual transmission – 911 Carrera S, 911 Carrera 4S

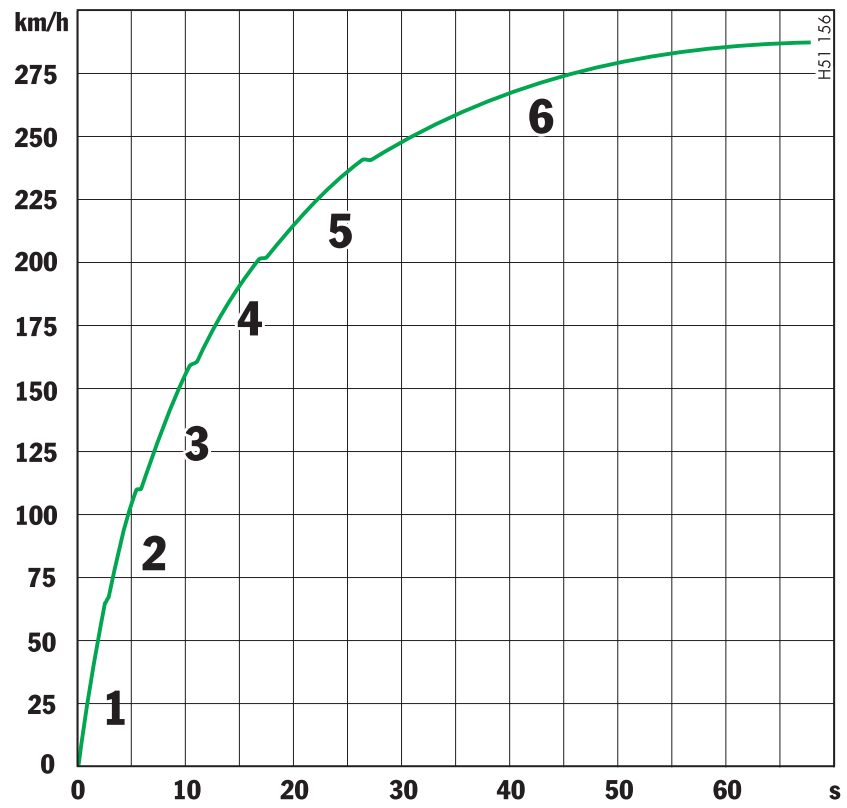

Index

A

ABS (antilock brake system)	69
Warning light	70
Air distribution	138
Air filter	215
Airbag	45
Function	46
Warning light	49, 57
Air-conditioning compressor	138, 140
Alarm system	26, 161
Alcantara	226
Antenna	161, 221
Antifreeze	199
Antilock brake system (ABS)	69
Warning light	70
Ashtray	142
Assembly aids for wheel changes	250
Audio operation	159, 160
Auto-button, air conditioning	138
Automatic	215
Air conditioning system	138
Anti-glare mirrors	32
Car washes	221
Door locking	21
Headlight adjustment	132
Speed control	88, 136, 137
Average consumption	99, 121
Average speed	99, 121

B

Backrest	
Adjustment	34
Release	34
Battery	258
Care	259
Charging	259
Putting vehicle into operation	261
Remote control	263
Removing	262
Warning light	96
Winter operation	260
Before driving off	14, 15
Belts	42, 226
Height adjustment	44
Tensioner	42
Warning light	43
Blower adjustment	139, 141
Brake light	276, 278
Brakes	205
Brake circuit division warning light	206
Brake pad warning light	97
Fluid	205, 291
Fluid warning light	116, 206
Pads	16, 68
Parking brake	65
Roller brake tester	62
Test stand	74
Break in hints	16
Bulbs, replacing	266

C

Cabriolet	176
Canholder	144
Capacities	291
Car care	218
Car telephone	161
Car washes	219
Carpet	225
Catalytic converters	212
Cautions	198, 228
Central locking	22
emergency operation	23
Central vents	141
Central warning light	97
Changing wheels	250
Check engine	
Warning light	97
Checking pressure	251
Child restraint	
Anchorage	56
Child restraint systems	51
Chime	131
CHRONO stopwatch	104
Cigarette lighter	143
Circulating-air button	139
Clock	95, 121
Clothes hook	146
Clutch	65, 164
Comfort seat	34
Coming Home mode	131

Compact disc		DVD navigation	151	F	
Player and Changer	160	Dynamometer testing	61	Filling pressure, tire	5, 290
Storage	147	E		Fire extinguisher	154
Compartment monitoring	26	Electrical system	254	Floor mats	225
Compressor	151	Emergency flasher	130	Fluids and fuels	291
Convertible top	176	Emergency operation		Fog lights	131
Care	220	Central locking	23	Footbrake	66
Coolant	92, 199	Lids	257	Footwell lights	277
Level	199	Sliding roof	174	Four-wheel drive	61, 62
Temperature gauge	92	Tank flap	208	Fresh air intake	141
Warning light	92	Emergency service	228	Front lid	149
Cooling system	92, 199	Emergency starting		Fuel	4, 94, 208
Cruise control	96, 136, 137	with jumper cables	264, 265	Containers	8, 210
Cupholder	144	Emission control system	7, 97, 211, 212	Economy	207
D		Engine		Evaporation control	213
Dashboard	78	Checking the oil level	118	Level gauge	94
Data bank	284	Exhaust	9	Level warning light	94
Defrosting windows	33, 139	Number	285	Recommendation	209, 210
Diagnostic socket	17, 256	Oil consumption	16, 201	Tank	209
Diagrams	299	Oil level	201	Function keys	40
Dimensions	298	Oil level indicator	118	Fuses	256
Door	21	Oil pressure	96	G	
Guard lights	277	Oil temperature	88	Garage door opener	155
Handles	21	Oils	201, 291	Garage lift	244
Locks	21, 221	Speeds	16, 296, 297	Glove compartment	147
Mirror	32	Starting	82	Gong	18, 81, 100, 131
Mirror heating	33	Stopping	83	Ground clearance	9
Windows	21, 28, 176, 223	Engine compartment			
Driving hints	14	Blower	83, 92		
Driving in winter	170	Lid	148, 149		
Driving performance	296, 297	Lid warning light	148		
Drop-center rim	241	Light	277		
DVD Navigation	150, 158	Environment	6		

H

Handbrake	65
Hardtop	189
Headlights	132, 268
Adjusting	279, 280
Cleaning system	133, 213, 291
Headlights beam adjustment	132
Heated rear window	33
Heater	138
High beam	
Indicator light	91
Lever	131
Home mode	131
HomeLink	155
Hoods	148, 149
Horn	17, 22, 24

I

Ignition lock	80
Immobilizer	19
Indicator lights	84
Instrument	84
Illumination	88
Lights	131
Panel	78, 122
Interior lights	76
Interior mirror	30, 32

J

Jumper cables	235, 264
---------------------	----------

K

Keys	19, 20
------------	--------

L

LATCH System	55
Leather care	225
License plate light	131, 277
Lids	149
Emergency unlocking	257
Lifting/sliding roof	172
Light	
Flasher	91, 131, 132
Low beam	131, 132
Sensor for instrument illumination	84
Switch	131, 132

Light alloy wheels

Inscription	241
Load switch-off	255
Loading information	242
Locking	22
Conditions	24
Lowering	57
Luggage carrier	292, 293
Luggage compartment	150
Lid	148
Lid warning light	148
Light	277

Luggage compartment/

engine compartment lid, warning lights	148
Luggage rack	195

M

Maintenance	198
Make-up mirror	41
Maximum permitted engine speeds	16, 164
Mirrors	30, 32, 60
Anti-glare	32
Multi-functional steering wheel	40

N

Navigation	158
Notes on	
Car care	218
Maintenance	198
Number plate light	131, 277

O

Octane rating	209, 210
Off delay	131
Oil	201
Checking level	118
Consumption	16
Level checks	201
Level indicator	118
Pressure	96
Temperature	88
On-board computer	98
Basic settings	120
Language versions	120
On-board literature	2
Orientation light	76
Outside temperatur indicator	95

P

Paint	
Care	218
Data	285
ParkAssistant	58
Parking	170
Parking aids	58, 60
Parking brake	65
Warning light	66
Parking light	131, 132
Particle filter	215
Passenger compartment monitoring	26
Plastic parts	224
Platform lift	244
Porsche Active Suspension Management (PASM)	75
Porsche Ceramic Composite Brake (PCCB)	8
Porsche Communication Management (PCM)	158
Porsche Stability Management (PSM)	72
Information light	74
Power measurement	61
Power measurements	198
Power steering fluid level	214, 291
Power windows	21, 28, 176
Practical tips	228

R

Radiator fan	83, 200
Radio reception	159
Rain sensor	133
Range on remaining fuel	99, 121
Reading light	76, 278
Rear fog light	131

Rear lid	148
Rear seat backrests	39
Rear spoiler	63
Rear view mirrors	30, 32
Rear window defogger	33
Rear window wiper	134
Recycling	7
Reduced driving program, Tiptronic	170
Relays	254
Release button	165
Remote control	20
Replacement key	19
Replacing bulbs	266
Replacing wiper blades	216
Rims	
Diameter	241
Rim width	241
Rollover Protection System	57
Roof Transport System	195, 292, 293
Running in	16

S

Safety belts	42, 226
Height adjustment	44
Tensioner	42
Warning light	43
Safety compliance sticker	284
Sealing set	246
Seals	224
Seat	
Adjustment	34
Heating	38
Memory	36
Selector lever	165

Selector lever position indicator	93, 166
Shifting gear	164
Side marker light	131, 275
Side vents	141
Sliding roof	172
Snow chains	239
Snow tires	238
Socket	254
Spacers	249, 252
Spare key	19, 20
Speed code letter	240
Speed control	88, 136, 137
Speed limit	100, 240
Speedometer	90
Spoiler	63
Sport Chrono Package	
CHRONO stopwatch	104
Sport mode	71
Sport mode	71, 75
Sports seat	34
Sport-type running gear	298
Stability management system	72
Starting	81
Starting engine	82
Steering lock	80
Steering wheel	
Adjustment	39
Function keys	40
Lock	81
Rocker switches	165
Stopping engine	83
Stopwatch	104
Storage options	146
Storing your Porsche	226
Sun visors	41

T

Tachometer	91
Tank	208, 209, 291
Ventilation system	213
Technical data	286
Telephone	161
Temperature setting	138
Temperature, outside indicator	95
Test stand, measurements	74
Theft protection	18
Tightening torque for wheel bolts	252
Tiptronic	165
Indicator	93
Tire pressure monitoring	109
Tires	16, 229, 288, 289
Care	229
Checking pressure	251
Inscription	240
Loading information	242
Pressure	5, 232, 290
Pressure monitoring	109
Pressure plate	285
Sealant	245, 246
Sidewall	240
Size	240
Tool kit	151
Tools	150, 151
Towing	170, 281, 282
Towing lug	151
Tow-starting	170
Tracks	288, 289
Transmission	164, 287
Fluid	215, 291
Trunk entrapment	152

Turn signals	91, 132
Tyre pressure	
Compressor	151
Tyres	
Sealant	151

U

Undercoating	211, 223
--------------------	----------

V

Valves	236
Vanity mirror	41
Vehicle	
Care	218
Data	284
Identification label	284
Identification number	284
Putting into operation	261
Washing	219
Ventilation	138
Vents	138, 141
Viscosity, engine oil	204

W

Warning lights and messages	122
Washer	
Fluid	213, 291
Lever	133
Washing	219
Weights	292, 293
Welcome Home Function	131
Wheel	16, 224, 229, 288, 289

Bolts	248
Care	229
Changing	245
Checking pressure	251
Inscription	240
Loading information	242
Securing wheel bolts	19
Security wheel bolts	151
Sidewall	240
Size	240
Tire pressure	5, 232, 290
Tire pressure plate	285
Tire sealant	245, 246
Windows	28, 176, 223
Washer nozzles	133
Washer system	133, 213, 291
Windshield wiper/washer lever	133
Windshield wipers	133, 216
Replacing	216
Windstop	185

Winter operation

Battery	260
Coolant	199
Engine oil	200
Jumper cables	264, 265
Locks	221
Seals	224
Snow chains	239
Tires	238, 288, 289
Washer fluid	213
Wiper blades	216
Wiper	
Blades	216
Rear	134