

Applications For Pass. Cars, Light Trucks, SUV's, & Vans

VEHICLE MAKE, MODEL & YEAR	GR-2		Gas-a-Just		MonoMax 56XXXX Series		STRUT & SHOCK			
MARQUE, MODELE ET	Excel-G				AGX		MOUNTS		BOOT KITS	
ANNEE DU VEHICULE					7XXXXX Series					
LA MARCA EL MODELO & ANO										

ACURA CL

2001-03	ALL Control Arm Bushing (Strut to Arm)		341257	341258			741049	741050	SM5058 SM5207	SM5059	SB108	SB107
1996-99	ALL Control Arm Bushing (Strut to Arm) Knuckle Shock Bushing Mount Plate w/ Insulator Upper Spring Seat Insulator	Right Hand Left Hand	341117 341118	341119 341119			741010 741011	741012 741012	SM5058 SM5058 SM5207	SM5059 SM5059	SB108 SB108	SB108 SB108
									SM5514 SM5486	SM5051 SM5515		

ACURA CSX

2006-10	ALL Lower Shock Bushing									SM5404	SB101	
---------	----------------------------	--	--	--	--	--	--	--	--	--------	-------	--

ACURA EL (Canadian Vehicle)

2002-03	ALL Control Arm Bushing (Strut to Arm)	Right Hand Left Hand	331008 331009	341311 341311			731003 731004	741060 741060	SM5402 SM5402	SM5400 SM5400	SB103 SB103	SB108 SB108
2001	ALL Control Arm Bushing (Strut to Arm)	Right Hand Left Hand	331008 331009	341311 341311			731003 731004	741060 741060	SM5403 SM5403	SM5400 SM5400	SB103 SB103	SB108 SB108
1997-00	ALL		341203	341198			741023	741024	SM5058	SM5058	SB108	SB108

ACURA Integra

1994-01	Mount Plate w/ Insulator ALL (Exc. TYPE-R) Control Arm Bushing (Strut to Arm) Mount Plate w/ Insulator Upper Spring Seat Insulator	Right Hand Left Hand	341138 341139	341094 341094			741005 741006	741007 741007	SM5538 ⁶³ SM5058 SM5058 SM5210	SM5058 SM5058	SB108 SB108	SB108 SB108
									SM5208 SM5516 SM5528			
1990-93	ALL Control Arm Bushing Control Arm Bushing (Strut to Arm)	Right Hand Left Hand	341135 341136	341137 341137			741008 741009		SM5058 SM5058 SM5210	SM5058 SM5058	SB108 SB108	SB108 SB108
									SM5166			
1986-89	ALL		234027	341050 ²					SM5293	SM5059	SB103	

ACURA Legend

1991-95	Sedan & Coupe Lower Shock Bushing	Right Hand Left Hand	344606 344607	344608 344608					SM5191 SM5191	SM5192 SM5192 SM5224	SB101 SB101	SB107 SB107
1989-90	Sedan Knuckle Shock Bushing	Right Hand Left Hand	341112 341113	341116 341116					SM5058 SM5058	SM5059 SM5059 SM5051	SB108 SB108	SB107 SB107
1986-90	Coupe Knuckle Shock Bushing	Right Hand Left Hand	341112 341113	341116 341116					SM5058 SM5058	SM5059 SM5059 SM5051	SB108 SB108	SB107 SB107
1986-88	Sedan	Right Hand Left Hand	341112 341113	234044 234045					SM5058 SM5058	SM5288 SM5288	SB108 SB108	SB107 SB107





ACURA MDX

2007-09	ALL (Exc. Electronic Adj. Susp.)	Right Hand Left Hand	339037 339038	349025 349025								
2003-06	ALL	Right Hand Left Hand	339072 339073	349039 349039					SM5211 SM5211		SB104 SB104	
2001-02	ALL	Right Hand Left Hand	334364 334365	344353 344353					SM5211 SM5211		SB104 SB104	

² The KYB replacement unit comes with a new dustcover/ bumper assembly.

⁶³ New Part Number; Available 4th Quarter 2010

Applications For Pass. Cars, Light Trucks, SUV's, & Vans

VEHICLE MAKE, MODEL & YEAR		GR-2 <i>Excel-G</i>		Gas-a-Just		MonoMax 56XXXX Series AGX 7XXXXX Series		STRUT & SHOCK MOUNTS		BOOT KITS	
MARQUE, MODELE ET ANNEE DU VEHICULE											
LA MARCA EL MODELO & ANO											

ACURA NSX

1991-05	NSX									SB108	SB108
---------	-----	--	--	--	--	--	--	--	--	-------	-------

ACURA RL

2005-10	ALL									SB108	SB108		
2002-04	ALL	Right Hand	341432	341437						SM5289	SM5290	SB108	SB107
		Left Hand	341433	341437						SM5289	SM5290	SB108	SB107
1996-01	ALL	Right Hand	341434	341437						SM5289	SM5290	SB108	SB107
		Left Hand	341435	341437						SM5289	SM5290	SB108	SB107

ACURA RDX

2007-10	ALL									SB102	
---------	-----	--	--	--	--	--	--	--	--	-------	--

ACURA RSX

2005-06	Strut Boot Mount & Bearing (Exc. Type S) Mount & Bearing (Type S) Shock Mount Kit									SM5403 SM5402	SM5400	SB104	
2002-04	ALL	Right Hand	331601 ⁶³	341376						SM5403	SM5400	SB104	SB108
		Left Hand	331602 ⁶³	341376						SM5403	SM5400	SB104	SB108

ACURA SLX

1996-99	ALL			KG54304	KG54308	565022	565023						
---------	-----	--	--	---------	---------	--------	--------	--	--	--	--	--	--

ACURA TL

2006	ALL		341330	341331						SM5058	SM5058	SB108	SB107
2004-05	ALL		341330	341331						SM5058	SM5058	SB108	SB108
1999-03	3.2L (Inc. Type S)		341257	341258			741049	741050		SM5058	SM5058	SB108	SB107
1996-98	3.2L	Right Hand	341430	341436						SM5289	SM5059	SB108	SB107
		Left Hand	341431	341436						SM5289	SM5059	SB108	SB107
	Mount Plate w/ Insulator										SM5515		
1995-98	2.5L	Right Hand	341446	341424						SM5058	SM5059	SB108	SB107
		Left Hand	341447	341424						SM5058	SM5059	SB108	SB107
	Mount Plate w/ Insulator (2.5L) Upper Spring Seat Insulator (2.5L)									SM5514 SM5486	SM5515		

ACURA TSX

2004-08	TSX		341330	341495								SB108	SB108
---------	-----	--	--------	--------	--	--	--	--	--	--	--	-------	-------

ACURA Vigor

1992-94	ALL Mount Plate w/ Insulator Upper Spring Seat Insulator									SM5058 SM5514 SM5486	SM5059 SM5515	SB108	SB107
---------	--	--	--	--	--	--	--	--	--	----------------------------	------------------	-------	-------

AMC Ambassador

1970-74	ALL		343156	343149	KG4505	KG5522							
1958-69	ALL (Exc. 1958 - 60 Air Susp.)			343149									











AMC American

1967-68	ALL			343135	KG4503	KG5521							
1958-66	ALL			343135									

⁶³ New Part Number; Available 4th Quarter 2010

Notes de bas de Page 259 - Guia de notas al calce del catalogo Pg. 260
 Bold part numbers indicate the most comparable KYB product to the original design & performance.
 (22) For vehicles with Electronic Susp., Leveling Control, and Air Suspensions refer to Appendix C.

Applications For Pass. Cars, Light Trucks, SUV's, & Vans

VEHICLE MAKE, MODEL & YEAR		GR-2		Gas-a-Just		MonoMax 56XXXX Series		STRUT & SHOCK			
MARQUE, MODELE ET		Excel-G				AGX 7XXXXX Series		MOUNTS		BOOT KITS	
ANNEE DU VEHICULE											
LA MARCA EL MODELO & ANO		 		 		 		 		 	

AMC AMX

1978-80	ALL	343156	344052	KG4505							
1970-74	ALL	343156	343135	KG4505	KG5521						
1968-69	ALL		343135	KG4503	KG5521						

AMC Classic

1961-66	ALL		343149								
---------	-----	--	--------	--	--	--	--	--	--	--	--

AMC Concord

1978-83	ALL	343156	344052	KG4505							
---------	-----	--------	--------	--------	--	--	--	--	--	--	--

AMC Eagle

1980-88	ALL	343156	343149	KG4505	KG5522						
---------	-----	--------	--------	--------	--------	--	--	--	--	--	--

AMC Gremlin

1971-78	ALL	343156	344052	KG4505							
1970	ALL	343156	343130	KG4505	KG5507						

AMC Hornet

1971-77	ALL	343156	344052	KG4505							
1970	ALL	343156	343130	KG4505	KG5507						

AMC Javelin

1970-74	ALL	343156	343135	KG4505	KG5521						
1968-69	ALL		343135	KG4503	KG5521						

AMC Marlin

1965-67	ALL		343149								
---------	-----	--	--------	--	--	--	--	--	--	--	--

AMC Matador

1971-78	ALL	343156	343149	KG4505	KG5522						
---------	-----	--------	--------	--------	--------	--	--	--	--	--	--

AMC Rambler

1969	ALL		343135	KG4503	KG5521						
------	-----	--	--------	--------	--------	--	--	--	--	--	--

AMC Rebel

1970	ALL	343156	343149	KG4505	KG5522						
1966-69	ALL		343149								

AMC Spirit

1979-83	ALL	343156	344052	KG4505							
---------	-----	--------	--------	--------	--	--	--	--	--	--	--

ASUNA Sedan SE/GT (Canadian Vehicle)











1992-94	ALL	365025			KG4543			SM5378	SM5010	SB101	SB105
---------	-----	--------	--	--	--------	--	--	--------	--------	-------	-------

ASUNA Sunfire (Canadian Vehicle)

1993-94	ALL (Exc. Lotus Susp.)	Right Hand	234041	232033				SM5081	SM5105	SB102	SB105
		Left Hand	234042	232034				SM5081	SM5105	SB102	SB105
	ALL w/ Lotus Susp.	Right Hand	234041	332076				SM5081	SM5105	SB102	SB105
		Left Hand	234042	332077				SM5081	SM5105	SB102	SB105

Notes de bas de Page 259 - Guia de notas al calce del catalogo Pg. 260
 Bold part numbers indicate the most comparable KYB product to the original design & performance.
 (2) For vehicles with Electronic Susp., Leveling Control, and Air Suspensions refer to Appendix C.

Applications For Pass. Cars, Light Trucks, SUV's, & Vans

VEHICLE MAKE, MODEL & YEAR	GR-2	Gas-a-Just	MonoMax 56XXXX Series	STRUT & SHOCK	
MARQUE, MODELE ET	Excel-G		AGX 7XXXX Series	MOUNTS	BOOT KITS
ANNEE DU VEHICULE	 	 	 	 	 
LA MARCA EL MODELO & ANO					

ASUNA Sunrunner (Canadian Vehicle)

1996-98	ALL w/ 4 Wheel ABS		343247		KG4745A			SM5082		
1993-98	ALL (Exc. ABS)	Right Hand	235035	343247		KG4745A		SM5082		
		Left Hand	235036	343247		KG4745A		SM5082		

AUDI 80/90 Series

1994-95	Cabriolet		365008					SM5034		SB102
9/91-95	ALL (Exc. Quattro) Quattro (Exc. 20V)		365008 365008	341130				SM5034 SM5034		SB102 SB121
1988-8/91	ALL (Exc. Quattro) Quattro (Exc. 20V)		365008 365008	366006		KG9006 ²		SM5034 SM5034		SB121 SB121
										SB105

AUDI 100 Series

1991-94	Strut Mount Bearing							SM5134		
12/90-95	ALL (Exc. Quattro, S4 & Sport Susp.)		366002	341133				SM5183	SM5120	SB105
12/90-94	Quattro (Exc. Sport Susp.)		366002	341205				SM5183	SM5120	SB120
1988-11/90	ALL (Exc. Quattro) Quattro		366002 366002	341016				SM5249 SM5249		SB104 SB101
1988-90	Strut Mount Bearing							SM5071		

AUDI 200 Series

1988-91	ALL (Exc. Quattro) Quattro Strut Mount Bearing		366002 366002	341016				SM5052 SM5052 SM5071	SM5120 SM5120	SB104 SB101
---------	--	--	------------------	--------	--	--	--	----------------------------	------------------	----------------

AUDI 4000 Series

1984-87	Quattro		365008	366006				SM5034		SB121
1980-87	ALL (Exc. Quattro)		365008			KG9006 ²		SM5034		SB121

AUDI 5000 Series

1986-88	Quattro		366002					SM5052		SB104
1984-88	ALL (Exc. Quattro)		366002	341016				SM5052		SB104
1980-88	Strut Mount Bearing							SM5071		
1980-83	ALL		366002	343013		KG5549		SM5052		SB104
Late 79-88	Front Strut Mounting Kit (Inc. Turbo & 1986-88 Quattro)							SM5249		
1977-79	ALL		366002	343013		KG5549				SB103

AUDI A3

2006-08	ALL									SB101
										SB125

AUDI A4













2007	Cabriolet		341676 ⁶³	343602 ⁶³						
11/04-08	Avant Wagon		341299	344807 ⁷⁰						
	Avant Wagon w/ Sport Susp. - From 11/04		341299	344808 ⁷⁰						
	Sedan		341299	344807 ⁷⁰						
	Sedan w/ Sport Susp. - From 11/04		341299	344808 ⁷⁰						
2003-06	Cabriolet		341299	341814				SM5446		SB122
2002-06	Shock Mount (Incl. Cabriolet)							SM5446		
2002-04	Strut Boot - A4 w/ Sport susp.									SB122
	Strut Boot - A4 w/o Sport susp.									SB124

² The KYB replacement unit comes with a new dustcover/ bumper assembly.

⁶³ New Part Number, Available 4th Quarter 2010

⁷⁰ New Part Number, Available 2nd Quarter 2010

Applications For Pass. Cars, Light Trucks, SUV's, & Vans

VEHICLE MAKE, MODEL & YEAR	  	STRUT & SHOCK		BOOT KITS	
MARQUE, MODELE ET		MOUNTS			
ANNEE DU VEHICULE					
LA MARCA EL MODELO & ANO					
	 	 	 	 	 

AUDI A4 (continued)

10/01-11/04	Avant Wagon (Inc. Quattro)	341299	341814						SB122		
2001-02	Cabriolet	341676 ⁶³	343602 ⁶³								
11/00-11/04	Sedan (Inc. Quattro)	341299	341814						SB122		
2/99-9/01	Avant Wagon w/o Sport Susp. (Exc. Quattro)	341842 ⁷²	343302					SM5236	SM5377	SB122	SB114
	Quattro Avant w/o Sport Susp.	341842 ⁷²	341909								
	Avant Wagon w/ Sport Susp. (Exc. Quattro)		343302					SM5236	SM5377	SB122	SB114
	Quattro Avant w/ Sport Susp.		341909								
2/99-11/00	Quattro Sedan w/o Sport Susp.	341842 ⁷²	341909					SM5236	SM5377	SB122	SB114
	Sedan w/o Sport Susp. (Exc. Quattro)	341842 ⁷²	343302								
	Quattro Sedan w/ Sport Susp.		341909								
	Sedan w/ Sport Susp. (Exc. Quattro)		343302					SM5236	SM5377	SB122	SB114
1998-99	Avant Wagon w/o Sport Susp. (Exc. Quattro)	341842 ⁷²	343271					SM5236	SM5377	SB122	SB114
	Quattro Avant Wagon	341842 ⁷²	341909					SM5236		SB122	
	Avant Wagon w/ Sport Susp. (Exc. Quattro)		343271					SM5236	SM5377	SB122	SB114
1995-1/99	Quattro Sedan	341842 ⁷²	341909					SM5236		SB122	
	Sedan w/o Sport Susp. (Exc. Quattro)	341842 ⁷²	343271					SM5236	SM5377	SB122	SB114
	Sedan w/ Sport Susp. (Exc. Quattro)		343271					SM5236	SM5377	SB122	SB114

AUDI A6

2005-08	ALL (Exc. Air Susp.) ALL								SM5237	SB122	SB115
1998-04	ALL (Exc. Quattro)	341207	343281					SM5236	SM5237	SB122	
	Quattro	341207	341677 ⁶³					SM5236	SM5237	SB122	
1995-97	ALL (Exc. Quattro)	366002	341133					SM5183	SM5237	SB120	
	Quattro	366002	341205					SM5183	SM5237	SB120	
	Strut Mount Bearing							SM5134			

AUDI A8, A8 Quattro

1997-04	ALL	NA	NA					SM5236			
---------	-----	----	----	--	--	--	--	--------	--	--	--

AUDI Allroad Quattro

2001-05	ALL	NA	NA								
---------	-----	----	----	--	--	--	--	--	--	--	--

AUDI Coupe

1981-87	ALL	365008			KG9006 ²			SM5034		SB121	
---------	-----	--------	--	--	---------------------	--	--	--------	--	-------	--

AUDI Fox

1973-79	Sedan	364001						SM5011		SB103	
	Station Wagon	364001			KG5532			SM5011		SB103	

AUDI S4, S6, S8

2007-08	ALL (Exc. Air Susp.)									SB122	
	ALL								SM5237		SB115
2004-06	S4							SM5446			
2002-04	S6 (Exc. Air Susp.)	341273									
2001-04	S6									SB122	
1996-02	Mounting Kit - ALL (Exc. Quattro)							SM5236	SM5377	SB122	
1995-97	S6									SB105	
1992-95	S4 (Exc. Quattro)							SM5249		SB105	

² The KYB replacement unit comes with a new dustcover/ bumper assembly.

⁶³ New Part Number: Available 4th Quarter 2010

⁷² Replaces [341904], when stock is depleted

Applications For Pass. Cars, Light Trucks, SUV's, & Vans

VEHICLE MAKE, MODEL & YEAR	GR-2		Gas-a-Just		MonoMax 56XXXX Series		STRUT & SHOCK		BOOT KITS	
MARQUE, MODELE ET	Excel-G				AGX		MOUNTS			
ANNEE DU VEHICULE					7XXXXX Series					
LA MARCA EL MODELO & ANO										

AUDI TT (Exc. Quattro)

2000-06	ALL w/ 18" Wheels w/o 18" Wheels	334676 ⁶³	343452				743029	SM5181	SM5182	SB123 SB103	SB125
---------	--	----------------------	--------	--	--	--	--------	--------	--------	----------------	-------

AUDI TT (Quattro)

2000-06	ALL w/ 18" Wheels w/o 18" Wheels	334676 ⁶³	343453					SM5181		SB123 SB103	
---------	--	----------------------	--------	--	--	--	--	--------	--	----------------	--

AUDI V8

1992-94	ALL	366002						SM5052		SB105	
1990-91	Strut Mounting Kit							SM5249			

AVANTI II

1989-91	ALL	343127	343130	KG4513	KG5507						
1986-88	ALL	343127	343157	KG4513	KG5548						
1965-85	ALL	343127		KG4550							

BERTONE X-1/9

1983-86	ALL	233003	233004								
---------	-----	--------	--------	--	--	--	--	--	--	--	--

BMW 1600/2, 2002, 2002Ti, 2002Tii

1966-76	ALL (E10)	363013			KG5540			SM5080			
---------	-----------	--------	--	--	--------	--	--	--------	--	--	--

BMW 2500,2800, 3.0S Sedan, 3.0 Bavaria

1969-76	ALL (E3)	365002			KG9303						SB107
---------	----------	--------	--	--	--------	--	--	--	--	--	-------

BMW 2800 CS, 3.0 CS Coupe

1969-76	ALL (E3)	365002			KG5541						
---------	----------	--------	--	--	--------	--	--	--	--	--	--

BMW 318 Series (Exc. M-Technik Susp.)

1995-99	318Ti (E36)	Right Hand	333909	343255		KG9136			SM5255	SM5013	SB101	SB107
		Left Hand	333910	343255		KG9136			SM5255	SM5013	SB101	SB107
1994-97	318i (E36) Convertible (Exc. Sport Susp.)	Right Hand	334901	343255		KG9136			SM5255	SM5013	SB112	SB107
		Left Hand	334902	343255		KG9136			SM5255	SM5013	SB112	SB107
		318i (E36) Convertible w/ Sport Susp.				KG9136			SM5255	SM5013	SB112	SB107
6/92-3/98	318i, is (E36) Sedan & Coupe	Right Hand	333909	343255		KG9136			SM5255	SM5013	SB112	SB107
		Left Hand	333910	343255		KG9136			SM5255	SM5013	SB112	SB107
1986-3/92	318iC, 318is (E30)		364021 ¹			KG4539			SM5053	SM5013	SB105	
1983-85	318i (E30) (Exc. Sport Susp.) (45mm Housing)		363044			KG4539			SM5053	SM5013	SB105	
		318is (E30) (51mm Housing)	364021			KG4539			SM5053	SM5013	SB105	

BMW 320 Series (Exc. M-Technik Susp.)











1993-1/95	320i (E36)	Right Hand	334901	343255		KG9136			SM5255	SM5013		
		Left Hand	334902	343255		KG9136			SM5255	SM5013		
1977-83	320i (E21)		363016			KG9004 ²			SM5080		SB112	SB113

¹ The original High Pressure Gas Strut Cartridge can be replaced by [364021] with Boot Kit # [SB101]

² The KYB replacement unit comes with a new dustcover/ bumper assembly.

⁶³ New Part Number; Available 4th Quarter 2010

Applications For Pass. Cars, Light Trucks, SUV's, & Vans

VEHICLE MAKE, MODEL & YEAR	GR-2	Gas-a-Just	MonoMax 56XXXX Series	STRUT & SHOCK	
MARQUE, MODELE ET	Excel-G		AGX 7XXXX Series	MOUNTS	BOOT KITS
ANNEE DU VEHICULE	 	 	 	 	 
LA MARCA EL MODELO & ANO					

BMW 323 Series (Exc. M-Technik Susp.)

2000	323Ci (E46) (Exc. Sport Susp.)	Right Hand Left Hand	334945 334946	343352 343352				SM5260 SM5260	SM5257 SM5257	SB112 SB112	SB107 SB107
1999-00	323i (E46)	Right Hand Left Hand	334945 334946	343352 343352				SM5260 SM5260	SM5257 SM5257	SB112 SB112	SB107 SB107
1998-99	323iC (E36)	Right Hand Left Hand	334901 334902	343255 343255		KG9136 KG9136		SM5255 SM5255		SB112 SB112	SB107 SB107
	323is (E36)							SM5255		SB112	SB107

BMW 325 (Exc. M-Technik Susp.)

9/87-88	ALL (E30) w/ High Pressure Strut NOTE: High Pressure Strut has 1 1/2" piston rod		364021 ¹			KG4539		SM5053	SM5013		
	ALL (E30) (Exc. High Pressure Strut)		364021			KG4539		SM5053	SM5013	SB105	
1984-8/87	ALL (E30)		364021			KG4539		SM5053	SM5013	SB105	

BMW 325Ci (Exc. M-Technik Susp.)

2002-06	Coupe		NA	NA							SB107
2001-06	Convertible (E46) (Exc. Sport Susp.)	Right Hand Left Hand	334945 334946	343352 343352				SM5260 SM5260	SM5257 SM5257	SB112 SB112	SB107 SB107
	Convertible (E46) w/Sport Susp.	Right Hand Left Hand	334614 334615	343352 343352				SM5260 SM5260	SM5257 SM5257	SB112 SB112	SB107 SB107
2001	Coupe (E46) (Exc. Sport Susp.)	Right Hand Left Hand	334945 334946	343352 343352						SB112 SB112	SB107 SB107
	Coupe (E46) w/ Sport Susp.	Right Hand Left Hand	334614 334615	343352 343352						SB101 SB101	SB107 SB107

BMW 325e (Exc. M-Technik Susp.)

9/87-88	ALL (E30) w/ High Pressure Strut NOTE: High Pressure Strut has 1 1/2" piston rod		364021 ¹			KG4539		SM5053	SM5013		
	ALL (E30) (Exc. High Pressure Strut)		364021			KG4539		SM5053	SM5013	SB105	
1984-8/87	ALL (E30)		364021			KG4539		SM5053	SM5013	SB105	

BMW 325i (Exc. M-Technik Susp.)

2006	ALL (Exc. Sport Susp.)	Right Hand Left Hand	334627 334628	349041 349041				SM5260 SM5260			
2001-05	ALL (E46) (Exc. Sport Susp.)	Right Hand Left Hand	334945 334946	343352 343352				SM5260 SM5260	SM5257 SM5257	SB112 SB112	SB107 SB107
	ALL (E46) w/ Sport Susp.	Right Hand Left Hand	334614 334615					SM5260 SM5260	SM5257 SM5257	SB112 SB112	SB107 SB107
2/95-96	ALL (E36) (Exc. Sport Susp.)	Right Hand Left Hand	333919 333920	343255 343255		KG9136 KG9136		SM5255 SM5255	SM5013 SM5013	SB112 SB112	SB107 SB107
6/92-1/95	ALL (E36) (Exc. Sport Susp.)	Right Hand Left Hand	334901 334902	343255 343255		KG9136 KG9136					
	ALL (E36) (w/Sport Susp.)	Right Hand Left Hand	334937 334938								
1988-91	ALL (E30)		364021 ¹			KG4539		SM5053	SM5013	SB105	

BMW 325ic (Exc. M-Technik Susp.)











1994-95	ALL (E36) (Exc. Sport Susp.)	Right Hand Left Hand	334901 334902	343255 343255		KG9136 KG9136		SM5255 SM5255	SM5013 SM5013	SB112 SB112	SB107 SB107
---------	------------------------------	-------------------------	------------------	------------------	--	------------------	--	------------------	------------------	----------------	----------------

¹ The original High Pressure Gas Strut Cartridge can be replaced by [364021] with Boot Kit # [SB101]

Notes de bas de Page 259 - Guia de notas al calce del catalogo Pg. 260

Bold part numbers indicate the most comparable KYB product to the original design & performance.
(22) For vehicles with Electronic Susp., Leveling Control, and Air Suspensions refer to Appendix C.

Applications For Pass. Cars, Light Trucks, SUV's, & Vans

VEHICLE MAKE, MODEL & YEAR	GR-2	Gas-a-Just	MonoMax 56XXX Series	STRUT & SHOCK	
MARQUE, MODELE ET	Excel-G		AGX 7XXXX Series	MOUNTS	BOOT KITS
ANNEE DU VEHICULE	 	 	 	 	 
LA MARCA EL MODELO & ANO					

BMW 325ic (Exc. M-Technik Susp.) (continued)

1994-95	ALL (E36) (w/Sport Susp.)	Right Hand	334937					SM5255	SM5013	SB112	SB107
		Left Hand	334938					SM5255	SM5013	SB112	SB107

BMW 325is (Exc. M-Technik Susp.)

2/95-96	ALL (E36) (Exc. Sport Susp.)	Right Hand	333919	343255		KG9136		SM5255	SM5013	SB112	SB107
		Left Hand	333920	343255		KG9136		SM5255	SM5013	SB112	SB107
6/92-1/95	ALL (E36) (Exc. Sport Susp.)	Right Hand	334901	343255		KG9136			SM5013		
		Left Hand	334902	343255		KG9136			SM5013		
	ALL (E36) (w/Sport Susp.)	Right Hand	334937								
		Left Hand	334938								
1988-91	ALL (E30)		364021 ¹			KG4539		SM5053	SM5013	SB105	

BMW 325iT (Exc. M-Technik Susp.)

2001-05	ALL (E46) w/ Sport Susp.	Right Hand	334614	343352				SM5260	SM5257	SB112	SB107
		Left Hand	334615	343352				SM5260	SM5257	SB112	SB107
2001-04	ALL (E46) (Exc. Sport Susp.)	Right Hand	334945	343352				SM5260	SM5257	SB112	SB107
		Left Hand	334946	343352				SM5260	SM5257	SB112	SB107

BMW 325ix (Exc. M-Technik Susp.)

1988-91	325ix 4WD (E30)					KG4539		SM5053	SM5013		
---------	-----------------	--	--	--	--	--------	--	--------	--------	--	--

BMW 328Ci (Exc. M-Technik Susp.)

2000	Coupe (E46)	Right Hand	334614	343352				SM5260	SM5257	SB112	SB107
		Left Hand	334615	343352				SM5260	SM5257	SB112	SB107

BMW 328i (Exc. M-Technik Susp.)

2007-08	Strut Mount							SM5260			
1999-00	ALL (E46) (Exc. Sport Susp.)	Right Hand	334945	343352				SM5260	SM5257	SB112	SB107
		Left Hand	334946	343352				SM5260	SM5257	SB112	SB107
	ALL (E46) w/ Sport Susp.	Right Hand	334614					SM5260	SM5257	SB112	SB107
		Left Hand	334615					SM5260	SM5257	SB112	SB107
2/95-3/98	ALL (E36) (Exc. Sport Susp.)	Right Hand	333919	343255		KG9136		SM5255	SM5013	SB112	SB107
		Left Hand	333920	343255		KG9136		SM5255	SM5013	SB112	SB107
	ALL (E36) (w/Sport Susp.)	Right Hand	334937					SM5255	SM5013	SB112	SB107
		Left Hand	334938					SM5255	SM5013	SB112	SB107

BMW 328ic (Exc. M-Technik Susp.)

1996-99	ALL (E36) (Exc. Sport Susp.)	Right Hand	334901	343255		KG9136		SM5255	SM5013	SB112	SB107
		Left Hand	334902	343255		KG9136		SM5255	SM5013	SB112	SB107
	ALL (E36) (w/Sport Susp.)	Right Hand	334937					SM5255	SM5013	SB112	SB107
		Left Hand	334938					SM5255	SM5013	SB112	SB107

BMW 328is (Exc. M-Technik Susp.)

2/95-3/98	ALL (E36) (Exc. Sport Susp.)	Right Hand	333919	343255		KG9136		SM5255	SM5013	SB112	SB107
		Left Hand	333920	343255		KG9136		SM5255	SM5013	SB112	SB107
	ALL (E36) (w/Sport Susp.)	Right Hand	334937					SM5255	SM5013	SB112	SB107
		Left Hand	334938					SM5255	SM5013	SB112	SB107

BMW 330 Series (Exc. M-Technik Susp.)

2006	330i (E46) (Exc. Sport Susp.)	Right Hand	334627	349041				SM5260			
		Left Hand	334628	349041				SM5260			
2001-06	330ci (E46) Convertible (Exc. Sport Susp.)	Right Hand	334945	343352				SM5260		SB112	SB107
		Left Hand	334946	343352				SM5260		SB112	SB107

¹ The original High Pressure Gas Strut Cartridge can be replaced by [364021] with Boot Kit # [SB101]

Notes de bas de Page 259 - Guia de notas al calce del catalogo Pg. 260

Bold part numbers indicate the most comparable KYB product to the original design & performance.

(22) For vehicles with Electronic Susp., Leveling Control, and Air Suspensions refer to Appendix C.

Applications For Pass. Cars, Light Trucks, SUV's, & Vans

VEHICLE MAKE, MODEL & YEAR	GR-2	Gas-a-Just	MonoMax 56XXXX Series	STRUT & SHOCK	
MARQUE, MODELE ET	Excel-G		AGX 7XXXXX Series	MOUNTS	BOOT KITS
ANNEE DU VEHICULE					
LA MARCA EL MODELO & ANO					

BMW 330 Series (Exc. M-Technik Susp.) (continued)

2001-05	330ci (E46) Convertible w/ Sport Susp.	Right Hand	334614	343352								
		Left Hand	334615	343352								
	330i (E46) (Exc. Sport Susp.)	Right Hand	334945	343352					SM5260	SM5257	SB101	SB107
		Left Hand	334946	343352					SM5260	SM5257	SB101	SB107
	330i (E46) w/ Sport Susp.	Right Hand	334614	343352							SB112	SB107
		Left Hand	334615	343352							SB112	SB107
2001-04	330Ci (E46)							SM5260	SM5257	SB112	SB107	
2001-03	330xi (E46)							SM5260	SM5257	SB112	SB107	
2001	330ci (E46) Coupe	Right Hand	334614	343352								
		Left Hand	334615	343352								

BMW 335i

2007-08	Strut Mount							SM5260			
---------	-------------	--	--	--	--	--	--	--------	--	--	--

BMW 524 Series (Exc. M-Technik Susp.)

8/90-9/92	524td	366007	341081								
1985-2/88	524td				KG9307			SM5053		SB105	SB107

BMW 525 Series (Exc. M-Technik Susp. & Electronic Susp.)

2004-06	ALL	NA	NA								
2001-9/03	525i Sedan (E39)	Right Hand	334674 ⁶³	341678 ⁶³				SM5260	SM5251	SB112	SB107
		Left Hand	334675 ⁶³	341678 ⁶³				SM5260	SM5251	SB112	SB107
	525iT Wagon (E39)	Right Hand	334674 ⁶³		552600 ⁶³			SM5260	SM5251	SB112	SB107
		Left Hand	334675 ⁶³		552600 ⁶³			SM5260	SM5251	SB112	SB107
10/92-1995	525i (E34) Sedan	365083	341081					SM5053	SM5256	SB112	SB107
1992-95	525iT Wagon (E34) (Exc. Adj. Susp.)	366007	341081					SM5053	SM5256	SB112	SB107
7/90-9/92	525i (E34) (Exc. Self-Leveling & M-Tronic)	366007	341081					SM5053	SM5251	SB105	SB107
8/90-9/92	525tds (E34)	366007	341081					SM5053	SM5251		
1990 - 6/90	525i (E34)	366005	341081					SM5053	SM5251	SB105	SB107
1/88-89	525i (E34)	366005	341081					SM5053	SM5251	SB105	

BMW 528 Series (Exc. Electronic Susp.)

1997-00	528i (E39) w/ EDC Susp.							SM5261		SB112	SB107
9/95-00	528i Sedan (E39) (Exc. EDC Susp.)	Right Hand	334674 ⁶³					SM5260	SM5251	SB112	SB107
		Left Hand	334675 ⁶³					SM5260	SM5251	SB112	SB107
	528iT Wagon (E39)	Right Hand	334674 ⁶³		552600 ⁶³			SM5260	SM5251	SB112	SB107
		Left Hand	334675 ⁶³		552600 ⁶³			SM5260	SM5251	SB112	SB107
1982-88	528e (E28) (Exc. Bilstein Equipped)	365043		KG9307				SM5053		SB105	SB107
1979-81	528i (E12)	365002		KG9303						SB105	SB107











BMW 530 Series (Exc. M-Technik Susp. & Electronic Susp.)

2001-9/03	530i Sedan (E39) To 9/03	Right Hand	334674 ⁶³	341678 ⁶³				SM5260	SM5251	SB112	SB107
		Left Hand	334675 ⁶³	341678 ⁶³				SM5260	SM5251	SB112	SB107
1994-95	530i (E34) Sedan (Exc. Self Leveling & M-Tronic)		366007	341081					SM5256	SB105	
		530iT (E34) Wagon	366007						SM5256	SB112	
1975-78	530i (E12)	365002		KG9302						SB105	SB107

⁶³ New Part Number; Available 4th Quarter 2010

Notes de bas de Page 259 - Guia de notas al calce del catalogo Pg. 260
 Bold part numbers indicate the most comparable KYB product to the original design & performance.
 (22) For vehicles with Electronic Susp., Leveling Control, and Air Suspensions refer to Appendix C.

Applications For Pass. Cars, Light Trucks, SUV's, & Vans

VEHICLE MAKE, MODEL & YEAR		GR-2		Gas-a-Just		MonoMax 56XXXX Series		STRUT & SHOCK			
MARQUE, MODELE ET		Excel-G				AGX 7XXXXX Series		MOUNTS		BOOT KITS	
ANNEE DU VEHICULE		 		 		 		 		 	
LA MARCA EL MODELO & ANO											

BMW 533 Series

1983-84	533i (E28)	365043			KG9307			SM5053		SB105	SB107
---------	------------	--------	--	--	--------	--	--	--------	--	-------	-------

BMW 535 Series (Exc. M-Technik Susp.)

7/90-9/92	535i (E34) (Exc. Self Leveling & M-Tronic)	366007	341081					SM5053	SM5256	SB112	SB107
1/88-6/90	535i (E34)	366005	341081							SB105	
1985-12/87	535i, 535is (E28) (Exc. M5)	365043			KG9307			SM5053		SB105	SB107

BMW 540 Series (Exc. Electronic Susp.)

2000-10/03	540iT (E39) Wagon	Right Hand	335600 ⁶³			552600 ⁶³			SM5261		SB108
		Left Hand	335601 ⁶³			552600 ⁶³			SM5261		SB108
	w/ Sport Susp.								SM5250	SB110	
	w/o Sport Susp.								SM5251	SB112	
1997-03	540i (E39) Sedan	Right Hand	335600 ⁶³	341678 ⁶³					SM5261	SM5251	SB112
		Left Hand	335601 ⁶³	341678 ⁶³					SM5261	SM5251	SB112
1994-95	540i (E34) (Exc. Self-leveling & M-Tronic)	366007							SM5256	SB105	SB107

BMW 545i

2004-06	ALL	NA	NA					SM5260			
---------	-----	----	----	--	--	--	--	--------	--	--	--

BMW 630 Series

1979-82	630CSI (E24)	365024			KG9303					SB105	SB107
1976-78	630CSI (E24)	365002			KG9303					SB105	SB107

BMW 633 Series

1979-82	633CSI (E24)	365024			KG9303					SB105	SB107
1976-78	633CSI (E24)	365002			KG9303					SB105	SB107

BMW 635 Series

1990	635CSI (E24) (Exc. Bilstein Equipped)	365043			KG9307					SB105	SB107
1985-89	635CSI (E24) (Exc. Bilstein Equipped)	365043			KG9307			SM5053		SB105	SB107

BMW 645Ci

2004-05	ALL	NA	NA					SM5260			
---------	-----	----	----	--	--	--	--	--------	--	--	--

BMW 650i

2006-08	ALL	NA	NA					SM5260			
---------	-----	----	----	--	--	--	--	--------	--	--	--

BMW 730 Series (Exc. M-Technik Susp.)

8/90-92	730 (E32) (Exc. Self Leveling & M-Tronic)	366007	341129						SM5121	SB105	SB107
---------	---	--------	--------	--	--	--	--	--	--------	-------	-------

BMW 733i

1982-84	733i (E23) (Exc. Self Leveling)	365024	341043							SB105	SB107
1977-81	733i (E23)	365024			KG9308					SB105	SB107









BMW 735 Series (Exc. M-Technik Susp.)

8/90-92	735i, 735iL (E32) (Exc. Self Leveling & M-Tronic)	366007	341129						SM5121	SB105	SB107
3/88-7/90	735i, 735iL (E32) (Exc. Self Leveling & M-Tronic)	366005	341129						SM5121	SB105	SB107

⁶³ New Part Number; Available 4th Quarter 2010

Notes de bas de Page 259 - Guia de notas al calce del catalogo Pg. 260
 Bold part numbers indicate the most comparable KYB product to the original design & performance.
 (22) For vehicles with Electronic Susp., Leveling Control, and Air Suspensions refer to Appendix C.

Applications For Pass. Cars, Light Trucks, SUV's, & Vans

VEHICLE MAKE, MODEL & YEAR		GR-2		Gas-a-Just		MonoMax 56XXXX Series		STRUT & SHOCK			
MARQUE, MODELE ET		Excel-G				AGX 7XXXXX Series		MOUNTS		BOOT KITS	
ANNEE DU VEHICULE		 		 		 		 		 	
LA MARCA EL MODELO & ANO											

BMW 735 Series (Exc. M-Technik Susp.) (continued)

9/86-2/88	735i, 735iL (E32) (Exc. Self Leveling & M-Tronic)	365082	341129						SM5121	SB105	SB107
9/84-8/86	735i (E23) (Exc. Self Leveling)	365024	341043							SB105	SB107

BMW 740 Series (Exc. M-Technik Susp.)

1995-01	740i & 740iL (E38) (Exc. Level Control & EDC Susp.)	Right Hand	335906	341211					SM5252	SM5250	SB102	SB107
		Left Hand	335907	341211					SM5252	SM5250	SB102	SB107
1993-94	740i (E32) (Exc. Self Leveling & M-Tronic)		366007	341129					SM5121		SB105	SB107
	740iL (E32) (Exc. Self Leveling & M-Tronic)		366005						SM5121		SB105	

BMW 745 Series

2002-05	745 (E65) w/ EDC										SB112	
---------	------------------	--	--	--	--	--	--	--	--	--	-------	--

BMW 750 Series (Exc. M-Technik Susp.)

1994-01	750iL (E38) w/o Level control & EDC Susp.	Right Hand	335906						SM5252			SB107
		Left Hand	335907						SM5252			SB107
7/90-94	750i, 750iL (E32) (Exc. Self Leveling & M-Tronic)		366005								SB105	
1988-6/90	750i, 750iL (E32) (Exc. Self Leveling & M-Tronic)		366005								SB105	

BMW 760 Series

2003-07	760iL w/ EDC	NA	NA								SB112	
---------	--------------	----	----	--	--	--	--	--	--	--	-------	--

BMW 840CI

1994-97	ALL	NA	NA									
---------	-----	----	----	--	--	--	--	--	--	--	--	--

BMW 850 Series

1991-97	ALL	NA	NA									
---------	-----	----	----	--	--	--	--	--	--	--	--	--

BMW M3 Series

2001-03	M3 (E46)									SM5257	SB112	SB107
1995-99	M3 (E36)	Right Hand							SM5258	SM5013	SB103	SB107
		Left Hand							SM5259	SM5013	SB103	SB107
1988-91	M3 (E30)	364021 ¹			KG4539				SM5053	SM5013		

BMW M5 Series

2000-03	M5 (E39)								SM5261		SB112	SB101
	M5 (E39) w/ M Susp.									SM5250		

BMW X3

2004-08	ALL	NA	344487						SM5260			
---------	-----	----	--------	--	--	--	--	--	--------	--	--	--

BMW X5

2001-06	ALL 3.0L	Right Hand	335924			555610 ⁶³			SM5254	SM5253	SB112	SB107
		Z										
		Left Hand	335925			555610 ⁶³			SM5254	SM5253	SB112	SB107
		Left Hand										

¹ The original High Pressure Gas Strut Cartridge can be replaced by [364021] with Boot Kit # [SB101]

⁶³ New Part Number; Available 4th Quarter 2010

Applications For Pass. Cars, Light Trucks, SUV's, & Vans

VEHICLE MAKE, MODEL & YEAR	GR-2		Gas-a-Just		MonoMax 56XXXX Series		STRUT & SHOCK		BOOT KITS	
MARQUE, MODELE ET	Excel-G				AGX		MOUNTS			
ANNEE DU VEHICULE					7XXXXX Series					
LA MARCA EL MODELO & ANO										

BMW X5 (continued)

2000-06	ALL 4.4, 4.6L	Right Hand Z	335924						SM5254	SM5253	SB112	SB107
		Left Hand	335925						SM5254	SM5253	SB112	SB107
	Upper Spring Seat Insulator	Left Hand							SM5342			

BMW Z Series

2003-05	Z4								SM5257			SB108
2000-03	Z8								SM5261		SB104	SB108
1998-02	Z3 (Exc. Sport Susp.)	Right Hand	334604	343330					SM5255	SM5257	SB112	
		Left Hand	334605	343330					SM5255	SM5257	SB112	
	M Roadster & M Coupe	Right Hand							SM5258	SM5257	SB103	
		Left Hand							SM5259	SM5257	SB103	
1996-97	Z3 (Exc. Sport Susp.)	Right Hand	334604	343330					SM5255	SM5013	SB112	
		Left Hand	334605	343330					SM5255	SM5013	SB112	

BRICKLIN SV-1

1974-76	ALL		343146	343219	KG4517	KG5517						
---------	-----	--	--------	--------	--------	--------	--	--	--	--	--	--

BUICK Allure (Canadian Vehicle)

2007-08	ALL	Right Hand							SM5143	SM5399	SB127	SB128
		Left Hand							SM5143	SM5398	SB127	SB128
	Universal Strut Mount w/ Boot									SM5394		
	Upper Spring Seat w/ Insulator								SM5470			
	Upper Spring Seat Insulator								SM5467			
2005-06	ALL	Right Hand	334227	334228					SM5143	SM5399	SB127	SB128
		Left Hand	334227	334228					SM5143	SM5398	SB127	SB128
	Universal Strut Mount w/ Boot									SM5394		
	Upper Spring Seat w/ Insulator								SM5470			
	Upper Spring Seat Insulator								SM5467			

BUICK Apollo

1974-75	ALL		343127	343132	KG4515	KG5506						
1973	ALL (Exc. HD Susp.)		343127	343132	KG4515							
	w/ HD Susp.		343127	343157	KG4515	KG5504						

BUICK Centurion

1971-73	ALL		343127	343130								
---------	-----	--	--------	--------	--	--	--	--	--	--	--	--













BUICK Century (also see STRUT-PLUS)

1997-05	ALL	Right Hand	334227	334228			734058	734059	SM5143	SM5399	SB127	SB128
		Left Hand	334227	334228			734058	734059	SM5143	SM5398	SB127	SB128
	Universal Strut Mount w/ Boot									SM5394		
	Upper Spring Seat w/ Insulator								SM5470			
	Upper Spring Seat Insulator								SM5467			
	Lower Spring Seat Insulator								SM5437	SM5440		
1990-96	ALL		234019	343160		KG5555			SM5043	SM5010	SB104	
	Upper Spring Seat w/ Insulator								SM5229			
1985-89	ALL		234019	343160		KG5555			SM5056	SM5010	SB104	
	Upper Spring Seat w/ Insulator								SM5229			
1984	ALL w/ HD Susp.		234019	343160		KG5555			SM5056	SM5010	SB104	
1982-84	ALL (Exc. 84 HD Susp.)		234002	343160		KG5555			SM5056	SM5010	SB104	
	Upper Spring Seat w/ Insulator								SM5229			
1978-81	ALL		343127	343157	KG4513	KG5548						
1973-77	Sedan & Coupe		343127	343157	KG4513	KG5504						

⁶³ New Part Number; Available 4th Quarter 2010

Notes de bas de Page 259 - Guia de notas al calce del catalogo Pg. 260
 Bold part numbers indicate the most comparable KYB product to the original design & performance.
 (22) For vehicles with Electronic Susp., Leveling Control, and Air Suspensions refer to Appendix C.

Applications For Pass. Cars, Light Trucks, SUV's, & Vans

VEHICLE MAKE, MODEL & YEAR	  	STRUT & SHOCK		BOOT KITS	
MARQUE, MODELE ET		MOUNTS			
ANNEE DU VEHICULE					
LA MARCA EL MODELO & ANO					
	 	 	 	 	 

BUICK Century (also see STRUT-PLUS) (continued)

1973-77	Station Wagon	343127	343157	KG4513						
---------	---------------	--------	--------	--------	--	--	--	--	--	--

BUICK Century - STRUT-PLUS

1997-05	ALL	Right Hand Left Hand	SR4002 SR4002	SR4003 SR4004						
---------	-----	-------------------------	------------------	------------------	--	--	--	--	--	--

BUICK Electra (also see STRUT-PLUS)

1987-90	Sedan & Coupe Sedan & Coupe (For Adapting Air Shock / Strut to Non-Air Suspension) Sedan & Coupe Strut Mount Bearing Mount Insulator & Bearing Upper Spring Seat w/ Insulator Lower Spring Seat Insulator	236002	SR1003 ⁶³ SR4023 ²¹					SM5281 SM5284 SM5026 SM5350 SM5411	SM5017	SB105
1985-86	Sedan & Coupe Lower Spring Seat Insulator	236002	235025 ²¹					SM5281 SM5411	SM5017	SB105
1977-84	Sedan, Coupe, Convertible & Hardtop	343127	343130	KG4515	KG5507					
1971-76	Sedan, Coupe & Hardtop	343127	343130	KG4515	KG5507					
1970	Sedan, Coupe, Convertible & Hardtop				KG5508					
1965-69	ALL				KG5508					

BUICK Electra - STRUT-PLUS

1987-90	ALL w/ FWD		NA ⁶⁰							
1985-86	ALL w/ FWD		NA ⁶⁰							

BUICK Enclave

2008-10	Strut Boot									SB101
---------	------------	--	--	--	--	--	--	--	--	-------

BUICK Estate Wagon (RWD)

1977-90	ALL	343127	343157	KG4515	KG5504					
1971-76	ALL	343127	343157	KG4515						
1970	ALL		343130		KG5507					

BUICK Grand National

1984-87	Grand National & GNX			KG4513	KG5548					
---------	----------------------	--	--	--------	--------	--	--	--	--	--

BUICK LaCrosse

2008-09	ALL w/ V6 Engine (Exc. 17" and Larger wheels)	Right Hand Left Hand	334227 334227	334228 334228				SM5143 SM5143	SM5399 SM5398	SB127 SB127	SB128 SB128
2005-09	Universal Strut Mount w/ Boot Upper Spring Seat w/ Insulator Upper Spring Seat Insulator							SM5470 SM5467	SM5394		
2005-07	ALL (Exc. 17" and Larger wheels)	Right Hand Left Hand	334227 334227	334228 334228				SM5143 SM5143	SM5399 SM5398	SB127 SB127	SB128 SB128

BUICK LeSabre (Exc. Elect. Adj. Susp.) (also see STRUT-PLUS)













2002-05	ALL w/ Self Leveling Rear Upper Spring Seat w/ Insulator Lower Spring Seat Insulator		335037	SR1002 ⁶³				SM5276 SM5435 SM5437	SM5334	SB103	
---------	--	--	--------	----------------------	--	--	--	----------------------------	--------	-------	--

²¹ To replace the Original Equipment self-leveling air strut: use KYB gas strut # [235025] with Strut Boot Kit # [SB128]. Deactivate the self-leveling system per Appendix B.

⁶⁰ To eliminate the Original Equipment Air Strut, Use STRUT PLUS [SR4023]

⁶³ New Part Number; Available 4th Quarter 2010

Applications For Pass. Cars, Light Trucks, SUV's, & Vans

VEHICLE MAKE, MODEL & YEAR	  	STRUT & SHOCK		BOOT KITS	
MARQUE, MODELE ET		MOUNTS			
ANNEE DU VEHICULE					
LA MARCA EL MODELO & ANO					
	 	 	 	 	 

BUICK LeSabre (Exc. Elect. Adj. Susp.) (also see STRUT-PLUS) (continued)

2000-01	ALL w/ Self Leveling Rear Upper Spring Seat w/ Insulator Lower Spring Seat Insulator	335037	SR1002 ⁶³					SM5276 SM5436 SM5437	SM5334	SB103	
1991-99	ALL w/ Self Leveling Rear ALL w/o Self Leveling Rear ALL (For Adapting Air Shock / Strut to Non-Air Suspension) Upper Spring Seat w/ Insulator Lower Spring Seat Insulator	236007 236007	SR1003 ⁶³ 235025 SR4023					SM5057 SM5057	SM5017 SM5017	SB104 SB104	SB128
1987-96	Strut Mount Bearing							SM5284			
1990	Late Design Front Struts (w/o SpringGuard) w/ Self-Level Rear Late Design Front Struts (w/o SpringGuard) w/o Self-Level Rear Late Design Front Struts (w/o SpringGuard) Lower Spring Seat Insulator Early Design Front Struts (w/ SpringGuard) w/ Self-Level Rear Early Design Front Struts (w/ SpringGuard) w/o Self-Level Rear Early Design Front Struts (w/ Spring Guard) Strut Mounting Kit Upper Spring Seat w/ Insulator Lower Spring Seat Insulator	236007 236007	SR1003 ⁶³ 235025					SM5057 SM5057 SM5412	SM5017 SM5017	SB104 SB104	SB104
	Early Design Front Struts (w/ SpringGuard) w/ Self-Level Rear Early Design Front Struts (w/ SpringGuard) w/o Self-Level Rear Early Design Front Struts (w/ Spring Guard) Strut Mounting Kit Upper Spring Seat w/ Insulator Lower Spring Seat Insulator	236002 236002	SR1003 ⁶³ 235025					SM5026 SM5026	SM5017 SM5017	SB105 SB105	SB104
1987-89	ALL w/ Self Leveling Rear ALL (For Adapting Air Shock / Strut to Non-Air Suspension) ALL w/o Self Leveling Rear Strut Mounting Kit Upper Spring Seat w/ Insulator Lower Spring Seat Insulator	236002 236002	SR1003 ⁶³ SR4023 235025					SM5026 SM5026 SM5281 SM5350 SM5411	SM5017	SB105 SB105	SB104
1986	ALL w/ Self Leveling Rear ALL w/o Self Leveling Rear Strut Mounting Kit Upper Spring Seat w/ Insulator Lower Spring Seat Insulator	236002 236002	235025 ²¹ 235025					SM5281 SM5350 SM5411	SM5017 SM5017	SB105 SB105	SB104
1977-85	Sedan & Coupe	343127	343130	KG4515	KG5507						
1971-76	Sedan, Coupe, Convertible & Hardtop	343127	343130	KG4515	KG5507						
1965-70	ALL				KG5508						

BUICK LeSabre (Exc. Elect. Adj. Susp.) - STRUT-PLUS











1991-99	ALL (For Adapting Air Shock / Strut to Non-Air Suspension) ALL w/o Self Leveling Rear	SR4022	SR4023								
1990	Late Design Front Struts (w/o SpringGuard) w/ Self-Level Rear Late Design Front Struts (w/o SpringGuard) w/o Self-Level Rear Early Design Front Struts (w/ Spring Guard) w/ Self-leveling Rear w/o Self-leveling Rear	SR4022 SR4022	NA ²¹ SR4023 NA ⁶⁰ SR4023								
1987-89	ALL w/ Self Leveling Rear ALL w/o Self Leveling Rear		NA ⁶⁰ SR4023								
1986	ALL w/ Self Leveling Rear ALL w/o Self Leveling Rear		NA ⁶⁰ SR4023								

²¹ To replace the Original Equipment self-leveling air strut: use KYB gas strut # [235025] with Strut Boot Kit # [SB128]. Deactivate the self-leveling system per Appendix B.

⁶⁰ To eliminate the Original Equipment Air Strut, Use STRUT PLUS [SR4023]

⁶³ New Part Number; Available 4th Quarter 2010

Applications For Pass. Cars, Light Trucks, SUV's, & Vans

VEHICLE MAKE, MODEL & YEAR	  	STRUT & SHOCK		BOOT KITS	
MARQUE, MODELE ET		MOUNTS			
ANNEE DU VEHICULE					
LA MARCA EL MODELO & ANO					
	 	 	 	 	 

BUICK Lucerne

2006-09	ALL w/o Magnetic Ride Control	335065	SR1002 ⁶³						SM5334	SB103	
---------	-------------------------------	--------	----------------------	--	--	--	--	--	--------	-------	--

BUICK Park Avenue (Exc. Elect. Adj. Susp.) (also see STRUT-PLUS)

2002-05	ALL Upper Spring Seat w/ Insulator Lower Spring Seat Insulator	335045	SR1002 ⁶³						SM5276 SM5435 SM5437	SM5334	SB101	
1998-01	ALL w/ Self Leveling Rear Upper Spring Seat w/ Insulator Lower Spring Seat Insulator	335045	SR1002 ⁶³						SM5276 SM5436 SM5437	SM5334	SB101	
1997	ALL w/ Self Leveling Rear Lower Spring Seat Insulator	334677 ⁶³	SR1002 ⁶³						SM5437		SB101	
1991-96	ALL ALL (For Adapting Air Shock / Strut to Non-Air Suspension) Strut Mount Bearing Upper Spring Seat w/ Insulator Lower Spring Seat Insulator	236007	SR1003 ⁶³ SR4023						SM5057 SM5284 SM5230 SM5412	SM5017	SB104	

BUICK Park Avenue (Exc. Elect. Adj. Susp.) - STRUT-PLUS

1991-96	ALL	SR4022	NA									
---------	-----	--------	----	--	--	--	--	--	--	--	--	--

BUICK Rainier

2004-07	ALL Strut Boot Mount w/ Spring Insulator Lower Spring Seat Insulator	331016 ⁸¹	343395		KG4162				SM5395 SM5548 ⁶³		SB108	
---------	---	----------------------	--------	--	--------	--	--	--	--------------------------------	--	-------	--

BUICK Reatta

1990-93	Strut Mounting Kit Strut Mount Bearing								SM5279 SM5284	SM5275		
1988	ALL	236004							SM5114	SM5275	SB105	

BUICK Regal (also see STRUT-PLUS)











1997-04	ALL Right Hand Left Hand Universal Strut Mount w/ Boot Upper Spring Seat w/ Insulator Upper Spring Seat Insulator	334227 334227	334228 334228			734058 734058	734059 734059		SM5143 SM5143 SM5470 SM5467	SM5399 SM5398 SM5394	SB127 SB127	SB128 SB128
1990-96	ALL (FWD) w/ HD Susp. ALL (FWD) w/ Std. Susp.	366004 ²⁰ 366004 ²⁰	236003 236003						SM5030 SM5029	SM5016 SM5016	SB104 SB104	SB106 SB106
1988-96	Strut Mount Bearing Strut Mounting Kit Lower Spring Seat Right Hand Left Hand Spring Seat w/ Bearing Right Hand Left Hand								SM5083 SM5226 SM5225 SM5384 SM5383	SM5277		
1988-89	ALL (FWD) w/ HD Susp. ALL (FWD) w/ Std. Susp.	366004 ²⁰ 366004 ²⁰	236003 236003						SM5031 SM5025	SM5016 SM5016	SB104 SB104	SB106 SB106
1978-87	ALL (Exc. Grand National)	343127	343157	KG4513	KG5548							
1973-77	ALL	343127	343157	KG4513	KG5504							

²⁰ See Special Installation Instructions Appendix A.

⁶³ New Part Number: Available 4th Quarter 2010

⁸¹ When [331016] stock is depleted, use [331043]

Applications For Pass. Cars, Light Trucks, SUV's, & Vans

VEHICLE MAKE, MODEL & YEAR	GR-2	Gas-a-Just	MonoMax 56XXXX Series	STRUT & SHOCK	
MARQUE, MODELE ET	Excel-G		AGX 7XXXX Series	MOUNTS	BOOT KITS
ANNEE DU VEHICULE	 	 	 	 	 
LA MARCA EL MODELO & ANO					

BUICK Regal - STRUT-PLUS

1997-04	ALL Right Hand Left Hand	SR4002 SR4002	SR4003 SR4004							
1990-96	ALL (FWD) w/ HD Susp. ALL (FWD) w/ Std. Susp.		SR4026 SR4026							
1988-89	ALL (FWD) w/ HD Susp. ALL (FWD) w/ Std. Susp.		SR4026 SR4026							

BUICK Rendezvous

2002-07	ALL (Exc. Automatic Rear Air Leveling System) ALL w/ Automatic Rear Air Leveling System Upper Spring Seat w/ Insulator Upper Spring Seat Insulator Lower Spring Seat Insulator	335044 335044	344438		KG5045			SM5143 SM5143 SM5470 SM5467 SM5437		SB127 SB127
---------	--	------------------	--------	--	--------	--	--	--	--	----------------

BUICK Riviera

1998-99	ALL	335045	SR1002 ⁶³					SM5276	SM5334	SB101
1997	ALL Strut / Shock Mount Strut Mount Bearing Upper Spring Seat w/ Insulator	334677 ⁶³	SR1002 ⁶³					SM5286 SM5284 SM5230	SM5334	SB101
1995-96	ALL Strut Mount Bearing Upper Spring Seat w/ Insulator Lower Spring Seat Insulator	236007	SR1002 ⁶³					SM5286 SM5284 SM5230 SM5412	SM5334	SB101
1990-93	Strut Mounting Kit Strut Mount Bearing							SM5279 SM5284	SM5275	
1986-89	ALL	236004						SM5114	SM5275	SB105
1979-85	ALL			KG4531	KG5573 ²⁵					
1971-78	ALL	343127	343130	KG4515	KG5507					
1963-65	ALL	343127		KG4550						

BUICK Roadmaster

1991-96	Sedan Station Wagon	343127 343127	343130 343157	KG4515 KG4515	KG5507 KG5504					
---------	------------------------	------------------	------------------	------------------	------------------	--	--	--	--	--

BUICK Skyhawk

1987-89	ALL Upper Springseat w/ Isolator	Right Hand Left Hand	231013 231014	343177 343177		KG4536 KG4536		SM5007 SM5007 SM5348	SM5010 SM5010	SB104 SB104
1984-86	ALL w/ Sealed Struts ALL w/ Rebuildable Struts Upper Springseat w/ Isolator	Right Hand Left Hand	231013 231014 366003 ¹⁸	343177 343177 343177		KG4536 KG4536 KG4536		SM5007 SM5007 SM5007 SM5348	SM5010 SM5010 SM5010	SB104 SB104 SB104
1982-83	ALL Upper Springseat w/ Isolator		365038 ¹⁸	343177		KG4536		SM5007 SM5348		SB104
1975-80	ALL		343129	343132						

BUICK Skylark (Exc. Electronic Susp.)













1995-98	ALL w/o Swaybar Bracket	Right Hand Left Hand	235604 235605	343402 343402		KG4552 KG4552		SM5142 SM5142	SM5010 SM5010	SB104 SB104
---------	-------------------------	-------------------------	------------------	------------------	--	------------------	--	------------------	------------------	----------------

¹⁸ Strut must be cut to install cartridge. Check strut for a cut line groove (20mm from strut top). If no cut line groove is found, do not cut strut open as there are no threads inside. The complete strut must be replaced.

²⁵ Eliminates OEM airshocks. See appendix B for special instructions.

⁶³ New Part Number; Available 4th Quarter 2010

Applications For Pass. Cars, Light Trucks, SUV's, & Vans

VEHICLE MAKE, MODEL & YEAR	  	STRUT & SHOCK		BOOT KITS	
MARQUE, MODELE ET		MOUNTS			
ANNEE DU VEHICULE					
LA MARCA EL MODELO & ANO					
	 	 	 	 	 

BUICK Skylark (Exc. Electronic Susp.) (continued)

1995-98	ALL w/ Swaybar Bracket Right Hand Left Hand Upper Spring Seat w/ Insulator		343402 343402		KG5576 KG5576			SM5142 SM5142 SM5228	SM5010 SM5010	SB104 SB104	
1992-98	Strut Mount Bearing (Exc. Electronic Adj. Susp.)							SM5284			
1992-94	ALL w/o Swaybar Bracket Right Hand Left Hand ALL w/ Swaybar Bracket (Exc. Adj. Susp.) Right Hand Left Hand Upper Springseat w/ Isolator		235604 235605	343177 343177	KG4536 KG4536			SM5073 SM5073	SM5010 SM5010	SB104 SB104	
1987-91	ALL Right Hand Left Hand		231013 231014	343177 343177	KG4536 KG4536			SM5007 SM5007	SM5010 SM5010	SB104 SB104	
1986	ALL w/ Sealed Struts Right Hand Left Hand ALL w/ Rebuildable Struts		231013 231014	343177 343177	KG4536 KG4536			SM5007 SM5007 SM5007	SM5010 SM5010 SM5010	SB104 SB104 SB104	
1985	ALL Upper Spring Seat w/ Insulator		234019	343160	KG5555			SM5056 SM5229	SM5010	SB104	
1984	ALL w/ HD Susp. ALL w/o HD Susp. Upper Spring Seat w/ Insulator		234019 234002	343160 343160	KG5555 KG5555			SM5056 SM5056 SM5229	SM5010 SM5010	SB104 SB104	
1982-83	ALL		234002	343160	KG5555			SM5056	SM5010	SB104	
1980-81	ALL		234002	343160	KG5555					SB104	
1975-79	ALL		343127	343132	KG4515	KG5506					
1970-72	ALL		343127	343157	KG4513	KG5504					
1968-69	ALL (Exc. Sportwagon)		343127	343157	KG4513	KG5504					
1967	ALL (Exc. HD Susp. & Sportwagon) ALL w/ HD Susp.		343128 343128	343130 343130	KG4515 KG4515	KG5507 KG5504					
1964-66	ALL (Exc. Sportwagon)		343128	343130	KG4515	KG5507					

BUICK Somerset

1985-87	ALL w/ Sealed Struts Right Hand Left Hand ALL w/ Rebuildable Struts Upper Springseat w/ Isolator		231013 231014 366003	343177 343177 343177	KG4536 KG4536 KG4536			SM5007 SM5007 SM5007 SM5348	SM5010 SM5010 SM5010	SB104 SB104 SB104	
---------	--	--	----------------------------	----------------------------	----------------------------	--	--	--------------------------------------	----------------------------	-------------------------	--

BUICK Special

1970-72	ALL		343127	343157	KG4513	KG5504					
1968-69	ALL (Exc. Sportwagon) Sportwagon		343127 343127	343157 343135	KG4513 KG4513	KG5504 KG5521					
1967	ALL (Exc. HD Susp. & Sportwagon) ALL w/ HD Susp.		343128 343128	343130 343130	KG4515 KG4515	KG5507 KG5504					
1964-67	Sportwagon		343128	343135	KG4515	KG5521					
1964-66	ALL (Exc. Sportwagon)		343128	343130	KG4515	KG5507					

BUICK Sportwagon

1970-72	ALL		343127	343157	KG4513	KG5504					
1968-69	ALL		343127	343135	KG4513	KG5521					
1967	ALL		343128	343135		KG5521					
1964-66	ALL		343128	343135		KG5521					

¹⁸ Strut must be cut to install cartridge. Check strut for a cut line groove (20mm from strut top). If no cut line groove is found, do not cut strut open as there are no threads inside. The complete strut must be replaced.

Applications For Pass. Cars, Light Trucks, SUV's, & Vans

VEHICLE MAKE, MODEL & YEAR	GR-2		Gas-a-Just		MonoMax 56XXXX Series		STRUT & SHOCK			
MARQUE, MODELE ET	Excel-G				AGX		MOUNTS		BOOT KITS	
ANNEE DU VEHICULE					7XXXXX Series					
LA MARCA EL MODELO & ANO										

BUICK Terraza (AWD)

2005-06	ALL Upper Spring Seat w/ Insulator Upper Spring Seat Insulator Lower Spring Seat Insulator	335061						SM5143 SM5470 SM5467 SM5437		SB127	
---------	---	--------	--	--	--	--	--	--------------------------------------	--	-------	--

BUICK Terraza (FWD)

2005-07	FWD (Exc. Self-Leveling Rear Suspension) Upper Spring Seat w/ Insulator Upper Spring Seat Insulator Upper Spring Seat Insulator Lower Spring Seat Insulator Lower Spring Seat Insulator	335061	344338		KG54325			SM5143 SM5470 SM5467 SM5437	SM5549 ⁶³ SM5549 ⁶³ SM5549 ⁶³	SB127	
---------	--	--------	--------	--	---------	--	--	--------------------------------------	--	-------	--

CADILLAC Allante

1989-93	Strut Mount Kit (Exc. Electronic Adj. Susp.)							SM5279	SM5275		
1987-93	Strut Mount Bearing (Exc. Electronic Adj. Susp.)							SM5284			
1987-88	ALL	236004						SM5279	SM5275	SB105	

CADILLAC Brougham (Exc. Electronic Susp.)

1987-92	ALL RWD (Exc. Limousine)	343127	343130	KG4515	KG5507						
---------	--------------------------	--------	--------	--------	--------	--	--	--	--	--	--

CADILLAC CTS

2008-09	ALL w/ FE1 Susp.				553603						
2003-07	ALL w/ FE1 Susp.			551605	553603						
2003-04	Strut Boot									SB108	

CADILLAC Calais

1971-76	ALL				KG5508						
---------	-----	--	--	--	--------	--	--	--	--	--	--

CADILLAC Catera

2000-01	ALL	334903						SM5285	SM5287	SB101	
1997-99	ALL (Exc. Sport)	334903						SM5285	SM5287	SB101	

CADILLAC Cimarron

1986-88	ALL	Right Hand	231013	343177		KG4536		SM5007	SM5010	SB104	
		Left Hand	231014	343177		KG4536		SM5007	SM5010	SB104	
1984-86	ALL w/ Rebuildable Struts		366003 ¹⁸	343177		KG4536		SM5007	SM5010	SB104	
1984-85	ALL w/ Sealed Struts	Right Hand	231013	343177		KG4536		SM5007	SM5010	SB104	
		Left Hand	231014	343177		KG4536		SM5007	SM5010	SB104	
1982-87	Upper Springseat w/ Isolator							SM5348			
1982-83	ALL		365038 ¹⁸	343177		KG4536				SB104	













CADILLAC Commercial Chassis

1975-84	ALL	NA	NA								
---------	-----	----	----	--	--	--	--	--	--	--	--

¹⁸ Strut must be cut to install cartridge. Check strut for a cut line groove (20mm from strut top). If no cut line groove is found, do not cut strut open as there are no threads inside. The complete strut must be replaced.

⁶³ New Part Number; Available 4th Quarter 2010

Applications For Pass. Cars, Light Trucks, SUV's, & Vans

VEHICLE MAKE, MODEL & YEAR	  	STRUT & SHOCK		BOOT KITS	
MARQUE, MODELE ET		MOUNTS			
ANNEE DU VEHICULE					
LA MARCA EL MODELO & ANO					
	 	 	 	 	 

CADILLAC DeVille (Exc. Adj. Susp.) (also see STRUT-PLUS)

2000-05	DeVille, DeVille DHS (Exc. Limo)	335037					SM5276	SM5334	SB103	
2000-04	Hearse & Limo Lower Spring Seat Insulator						SM5276 SM5437	SM5334		
1997-99	Limousine, Hearse Strut Mount Bearing						SM5282 SM5284			
1995-99	Concours Strut Mount Bearing						SM5282 SM5284			
1994-99	Deville						SM5282			
1991-93	ALL FWD w/ Self Leveling Rear ALL FWD w/o Self Leveling Rear Upper Spring Seat w/ Insulator Lower Spring Seat Insulator	236007 236007	SR1003 ⁶³ 235025				SM5057 SM5057 SM5230 SM5412	SM5017 SM5017	SB104 SB104	SB104
1987-99	Deville Strut Mount Bearing						SM5284			
1987-93	ALL (For Adapting Air Shock / Strut to Non-Air Suspension)		SR4023							
1987-90	ALL FWD w/ Self Leveling Rear ALL FWD w/o Self Leveling Rear Strut Mounting Kit Strut Mount Bearing Upper Springsseat w/ Isolator Lower Spring Seat Insulator	236002 236002	SR1003 ⁶³ 235025				SM5026 SM5026 SM5281 SM5284 SM5350 SM5411	SM5017 SM5017	SB105 SB105	SB104
1985-95	Limousine w/ Rear Wheel Drive			KG4515	KG5507					
1985-86	ALL FWD w/ Self Leveling Rear ALL FWD w/o Self Leveling Rear Lower Spring Seat Insulator	236002 236002	235025				SM5281 SM5281 SM5411	SM5017 SM5017	SB105 SB105	SB104
1977-84	ALL RWD (Exc. Limousine) Limousine	343127	343130	KG4515 KG4515	KG5507					
1971-76	ALL (Exc. Commercial Chassis)				KG5508					
1956-60	ALL (Exc. Commercial Chassis)			KG4515						

CADILLAC DeVille (Exc. Adj. Susp.) - STRUT-PLUS

1991-93	ALL FWD w/ Self Leveling Rear ALL FWD w/o Self Leveling Rear	SR4022 SR4022	SR4023							
1987-90	ALL FWD w/o Self Leveling Rear		SR4023							
1985-86	ALL FWD w/o Self Leveling Rear		SR4023							

CADILLAC DTS (Exc. Adj. Susp.)

2006-09	ALL w/ Soft Ride Susp. (Exc. Limo, Hearse, Armoured Body)	335065	NA					SM5334	SB103	
---------	--	--------	----	--	--	--	--	--------	-------	--

CADILLAC Eldorado

1997-02	ETC w/ Self Leveling Rear	NA	NA							
1996	ETC w/ Self Leveling Rear exc. ETC, w/ Self Leveling Rear	NA NA	NA NA							
1995	ALL w/ Self Leveling Rear	NA	NA							
1993-02	Strut Mounting Kit						SM5282			
1990-92	Strut Mounting Kit						SM5279	SM5275		
1987-02	Strut Mount Bearing						SM5284			
1987-89	ALL	236004					SM5279	SM5275	SB105	
1986	ALL	236004					SM5114	SM5275	SB105	
1979-85	ALL			KG4531	KG5573 ²⁵					

²⁵ Eliminates OEM airshocks. See appendix B for special instructions.

⁶³ New Part Number; Available 4th Quarter 2010

Applications For Pass. Cars, Light Trucks, SUV's, & Vans

VEHICLE MAKE, MODEL & YEAR	GR-2		Gas-a-Just		MonoMax 56XXXX Series		STRUT & SHOCK			
MARQUE, MODELE ET	Excel-G				AGX 7XXXXX Series		MOUNTS		BOOT KITS	
ANNEE DU VEHICULE										
LA MARCA EL MODELO & ANO										

CADILLAC Eldorado (continued)

1971-78	ALL		343130	KG4501	KG5507					
1967-70	ALL			KG4501						

CADILLAC Escalade

2008-09	ALL (Exc. Electronic Adj. Susp.)	341493		551121 ⁷⁰				SM5530 ⁶³		
2002-06	ALL (Exc. Electronic & Premium Smooth Ride Susp.) ALL w/ Premium Smooth Susp.			KG54327	KG54341	565067	565103			
1999-00	ALL	344266	344263	KG5480	KG5479	565062	565061			

CADILLAC Escalade - KYB Lift Kit Replacement Shocks

2002-04	ALL (Exc. Electronic & Premium Smooth Ride Susp.) Lift = 1-3"					565076				
1999-00	ALL Lift = 0-3"					565073	565074			

CADILLAC Fleetwood (Exc. Electronic Susp.) (also see STRUT-PLUS)

1991-93	Sedan & Coupe (FWD) FWD (Exc. FE1, F41 ,FX3) Strut Mount Bearing FWD w/ Self Leveling Rear Upper Spring Seat w/ Insulator Lower Spring Seat Insulator	236007	SR1003 ⁶³					SM5057 SM5284 SM5230 SM5412	SM5017	SB104
1987-90	Sedan & Coupe (FWD) Mount Insulator & Bearing FWD w/ Self Leveling Rear Upper Springseat w/ Isolator Lower Spring Seat Insulator	236002	SR1003 ⁶³					SM5281 SM5026 SM5350 SM5411	SM5017	SB105
1985-86	Sedan & Coupe (FWD) Lower Spring Seat Insulator	236002						SM5281 SM5411	SM5017	SB105
1977-96	Sedan & Coupe (RWD)	343127	343130	KG4515	KG5507					
1977-84	Limousine			KG4515						
1956-60	ALL (Exc. Commercial Chassis)			KG4515						

CADILLAC Fleetwood (Exc. Adj. Susp.) - STRUT-PLUS

1991-93	ALL FWD w/ Self Leveling Rear ALL FWD w/o Self Leveling Rear	SR4022 SR4022								
---------	---	------------------	--	--	--	--	--	--	--	--

CADILLAC Fleetwood, Limousine - Steering Stabilizer

1977-95	Steering Stabilizer	SS10200								
---------	---------------------	---------	--	--	--	--	--	--	--	--

CADILLAC SRX

2004-09	ALL (Exc. Magnetic Ride Control)		NA	551608						
---------	----------------------------------	--	----	--------	--	--	--	--	--	--

CADILLAC STS













2005-09	V6 (Incl. AWD) (Exc. Electronic, Magnetic Ride Control Susp.) V8 (Exc. Electronic, Magnetic Ride Control Susp.)			551607	NA					
				551606	NA					

CADILLAC Seville

1998-04	ALL (Exc. Electronic Adj. Susp.)	339016	SR1002 ⁶³					SM5276	SM5334	
1997	ALL w/ Self Leveling Rear	NA	NA							
1996	ALL w/ Self Leveling Rear	NA	NA							

⁶³ New Part Number; Available 4th Quarter 2010
⁷⁰ New Part Number; Available 2nd Quarter 2010

Applications For Pass. Cars, Light Trucks, SUV's, & Vans

VEHICLE MAKE, MODEL & YEAR	  	STRUT & SHOCK		BOOT KITS	
MARQUE, MODELE ET		MOUNTS			
ANNEE DU VEHICULE					
LA MARCA EL MODELO & ANO					
	 	 	 	 	 

CADILLAC Seville (continued)

1995	ALL w/ Self Leveling Rear	NA	NA								
1993-97	Strut Mounting Kit							SM5282			
1990-92	Strut Mounting Kit							SM5279	SM5275		
1987-97	Strut Mount Bearing							SM5284			
1987-89	ALL	236004						SM5279	SM5275	SB105	
1986	ALL	236004						SM5114	SM5275	SB105	
1980-85	ALL			KG4531	KG5573 ²⁵						SB107
1975-79	ALL	343127	343132 ²⁵	KG4513	KG5506 ²⁵						

CADILLAC XLR

2004-08	ALL	NA	NA								
---------	-----	----	----	--	--	--	--	--	--	--	--

CHECKER Marathon

1974-82	ALL (Exc. Aerobus)			KG5404	KG5429						
---------	--------------------	--	--	--------	--------	--	--	--	--	--	--

CHEVROLET Astro Mini-Van (2WD)

1996-05	ALL	344081	344082	KG5458	KG5459	565049	565050				
1990-95	ALL	344081	344082	KG5458	KG5459	565049	565050				
1985-89	ALL	344081	344082	KG5458	KG5459	565049	565050				
1985-05	ALL (Lowered 2" / 4")					565049	565037				

CHEVROLET Astro Mini-Van (AWD)

1996-05	ALL	344266	344082	KG5480	KG5459	565062	565050				
1990-95	ALL	344266	344082	KG5480	KG5459	565062	565050				

CHEVROLET Avalanche (2WD) (Exc. Electronic Ride Control)

2007-09	1500 (Exc. Electronic or Premium Smooth Ride Susp.)	341493	345073	551121 ⁷⁰	555054				SM5530 ⁶³		
2002-06	1500 (Exc. Self Leveling Rear) 2500	344381 344383	344384 344437	KG54327 KG54340	KG54341 KG5041	565067 565102	565103 565103				

CHEVROLET Avalanche (4WD) (Exc. Electronic Ride Control)

2007-09	1500 (Exc. Electronic or Premium Smooth Ride Susp.)	341493	345073	551121 ⁷⁰	555054				SM5530 ⁶³		
2002-06	1500 (Exc. Premium Smooth Ride or Off-Road Chassis Susp.)	344381	344384	KG54327	KG54341	565067	565103				
	1500 w/ Off-Road Chassis Package	344381	344436	KG54327	KG5195	565067	565103				
	1500 w/ Premium Smooth Ride Susp.	341343	SR2003	KG5040							
	2500	344383	344437	KG54340	KG5041	565102					

CHEVROLET Avalanche (4WD) (Exc. Electronic Ride Control) Lift Replacement Shocks

2002-06	1500 (Exc. Premium Smooth Ride or Off-Road Chassis Susp.) Lift = 1-3"					565076					
	1500 w/ Off-Road Chassis Package Lift = 1-3"					565076					

CHEVROLET Aveo











2009	ALL	Right Hand	333417	343423							
		Left Hand	333418	343423							

²⁵ Eliminates OEM airshocks. See appendix B for special instructions.

⁶³ New Part Number: Available 4th Quarter 2010

⁷⁰ New Part Number, Available 2nd Quarter 2010

Applications For Pass. Cars, Light Trucks, SUV's, & Vans

VEHICLE MAKE, MODEL & YEAR		GR-2 <i>Excel-G</i>		Gas-a-Just		MonoMax 56XXXX Series AGX 7XXXX Series		STRUT & SHOCK MOUNTS		BOOT KITS	
MARQUE, MODELE ET ANNEE DU VEHICULE		 		 		 		 		 	
LA MARCA EL MODELO & ANO											

CHEVROLET Aveo (continued)

2004-08	ALL	Right Hand Left Hand	333417 333418	343423 343423					SM5451 SM5451	SM5452 SM5452	SB101 SB101	SB107 SB107
---------	-----	-------------------------	------------------	------------------	--	--	--	--	------------------	------------------	----------------	----------------

CHEVROLET Aveo5

2009	ALL	Right Hand Left Hand	333417 333418	343423 343423								
2007-08	ALL	Right Hand Left Hand	333417 333418	343423 343423					SM5451 SM5451	SM5452 SM5452	SB101 SB101	SB107 SB107

CHEVROLET Bel Air

1977-81	Station Wagon		343127	343157	KG4515	KG5504						
1971-81	Police Car & Taxi Sedan (Exc. Police Car & Taxi)		344081 343127	343130 343130	KG5458 KG4515	KG5507 KG5507						
1971-76	Station Wagon		343127	343157	KG4515							
1967-70	ALL		343128	343130	KG4515	KG5507						
1965-66	ALL (Exc. Wagon & w/o HD Susp.) Station Wagon & w/ HD Susp.		343128 343128	343130 343130	KG4515 KG4515	KG5507						
1958-64	ALL (Exc. 58-60 Air Susp.)		343127	343130	KG4550	KG5507						
1955-57	ALL		343127	343149	KG4550	KG5522						

CHEVROLET Beretta

1995-96	ALL w/o Swaybar Bracket ALL w/ Swaybar Bracket Strut Mount Bearing Upper Spring Seat w/ Insulator Lower Spring Seat Insulator	Right Hand Left Hand	235604 235605	343402 343402 343402		KG4552 KG4552 KG5576			SM5142 SM5142 SM5142 SM5284 SM5228 SM5431	SM5010 SM5010 SM5010	SB104 SB104 SB104	
1992-94	ALL w/o Swaybar Bracket ALL w/ Swaybar Bracket Strut Mount Bearing Upper Springseat w/ Isolator Lower Spring Seat Insulator	Right Hand Left Hand	235604 235605	343177 343177 343177		KG4536 KG4536 KG4536			SM5073 SM5073 SM5073 SM5284 SM5349 SM5431	SM5010 SM5010 SM5010	SB104 SB104 SB104	
1987-91	ALL Upper Springseat w/ Isolator Lower Spring Seat Insulator	Right Hand Left Hand	231013 231014	343177 343177		KG4536 KG4536			SM5033 SM5033 SM5348 SM5431	SM5010 SM5010	SB104 SB104	

CHEVROLET Biscayne













1971-75	Police Car & Taxi Sedan (Exc. Police Car & Taxi) Station Wagon		344081 343127 343127	343130 343130 343157	KG5458 KG4515 KG4515	KG5507 KG5507						
1967-70	ALL		343128	343130	KG4515	KG5507						
1965-66	ALL (Exc. Wagon & w/o HD Susp.) Station Wagon & w/ HD Susp.		343128 343128	343130 343130	KG4515 KG4515	KG5507						
1958-64	ALL (Exc. 58-60 Air Susp.)		343127	343130	KG4550	KG5507						

CHEVROLET Blazer - Full Size (2WD) (Exc. S-Series)

1973-82	ALL		344068	344072	KG5409	KG5415	565032	565036				
1969-72	w/ Coil Spring w/ Leaf Spring		344068 344068	344085	KG5409 KG5409	KG5416 KG5419	565032 565032	565037				

Notes de bas de Page 259 - Guia de notas al calce del catalogo Pg. 260
 Bold part numbers indicate the most comparable KYB product to the original design & performance.
 (2) For vehicles with Electronic Susp., Leveling Control, and Air Suspensions refer to Appendix C.

Applications For Pass. Cars, Light Trucks, SUV's, & Vans

VEHICLE MAKE, MODEL & YEAR	  	STRUT & SHOCK		BOOT KITS	
MARQUE, MODELE ET		MOUNTS			
ANNEE DU VEHICULE					
LA MARCA EL MODELO & ANO					
	 	 	 	 	 

CHEVROLET Blazer - Full Size (4WD) (Exc. S-Series)

1992-94	ALL (Incl. Z-71 Off Road Package)	344266	344263	KG5480	KG5479	565062	565061				
1985-91	w/ Dual Front Shocks-Inside Shock		344072	KG5477	KG5415	565039	565036				
1980-91	w/ Dual Front Shocks-Outside Shock	344067	344072	KG5408	KG5415	565031	565036				
1980-84	w/ Dual Front Shocks-Inside Shock	344075	344072	KG5430	KG5415	565039	565036				
1973-91	ALL (Exc. w/ Dual Front Shocks)	344067	344072	KG5408	KG5415	565031	565036				
1969-72	ALL	344067		KG5408	KG5417	565031					

CHEVROLET Blazer - Full Size (4WD) Steering Stabilizers

1973-92	OEM Replacement Cylinder	SS10325									
---------	--------------------------	---------	--	--	--	--	--	--	--	--	--

CHEVROLET Blazer - Full Size (4WD) (Exc. S-Series) Lift Replacement Shocks

1992-94	ALL (Incl. Z-71 Off Road Package) Lift = 1-3" for Edelbrock # 6360 Lift = 4-6" for Rancho # RS5244 Lift = 4-6" for Rancho # RS9244 Lift = 4-6" for Rancho # RSX17316 Lift = 4-6" for Edelbrock # 63003 Lift = 4-6" for Edelbrock # 6460 Lift = 4-6" for Rancho # RS5227 Lift = 4-6" for Rancho # RS9227 Lift = 4-6" for Rancho # RSX17315 Lift = 4-6"					565073 565086 565092 565092 565086	565074 565087 565087 565087 565087				
---------	--	--	--	--	--	--	--	--	--	--	--

CHEVROLET Blazer (S-Series), S10 Blazer (2WD)

2004-05	ALL	344040	344041	KG5450	KG5451	565046	565047				
1999-03	ALL (Exc V4A Xtreme Sport Appearance Pkg.) ALL w/ V4A Xtreme Sport Appearance Pkg.	344040	344041	KG5450	KG5451	565046	565047				
1995-98	ALL	344040	344041	KG5450	KG5451	565046	565047				
1983-03	ALL (Lowered 2" / 4")					565046	565064				
1983-94	ALL	344040	344041	KG5450	KG5451	565046	565047				

CHEVROLET Blazer (S-Series), S10 Blazer (4WD & AWD)

1995-05	ALL (Exc. ZR2 Wide Stance Package) ALL w/ ZR2 Wide Stance Package	344042	344041	KG5452	KG5451	565048	565047				
1983-94	ALL	344042	344041	KG5452	KG5451	565048	565047				

CHEVROLET Brookwood

1971-72	ALL	343127	343157								
1969-70	ALL	343128	343130								

CHEVROLET C & K Series Pickups (See Silverado)

		----	----								
--	--	------	------	--	--	--	--	--	--	--	--













CHEVROLET Camaro, Z28, IROC

2010	ALL V6	Right Hand	334684 ⁶³	341681 ⁶³							
		Left Hand	334685 ⁶³	341681 ⁶³							
	SS	Right Hand	334686 ⁶³	341682 ⁶³							
		Left Hand	334687 ⁶³	341682 ⁶³							
1993-02	ALL V6	Right Hand	341356	343211	KG9310	KG5562	741034	743019	SM5119		SB103
		Left Hand	341356	343211	KG9310	KG5562	741034	743019	SM5118		SB103

⁶³ New Part Number; Available 4th Quarter 2010

Notes de bas de Page 259 - Guia de notas al calce del catalogo Pg. 260
 Bold part numbers indicate the most comparable KYB product to the original design & performance.
 (22) For vehicles with Electronic Susp., Leveling Control, and Air Suspensions refer to Appendix C.

Applications For Pass. Cars, Light Trucks, SUV's, & Vans

VEHICLE MAKE, MODEL & YEAR	  	STRUT & SHOCK		BOOT KITS	
MARQUE, MODELE ET		MOUNTS			
ANNEE DU VEHICULE					
LA MARCA EL MODELO & AÑO					
	 	 	 	 	 

CHEVROLET Camaro, Z28, IROC (continued)

1993-02	ALL V8	Right Hand Left Hand	341356 341356	343211 343211	KG9310 KG9310	KG5562 KG5562	741034 741034	743019 743019	SM5119 SM5118		SB103 SB103	
1982-92	ALL	Right Hand Left Hand	236001 236001	343211 343211		KG5562 KG5562	735001 735001	743019 743019	SM5028 SM5027			
1970-81	ALL		343128	343131	KG4515	KG5526						
1968-69	w/ Multi Leaf Spring w/ Single Leaf Spring Shock (Sleeve) Adapter Kit		343127 343127	343135 343135 ⁷ KIT107	KG4515 KG4515	KG5521 KG5524						
1967	ALL Shock (Sleeve) Adapter Kit		343127	343135 ⁷ KIT107	KG4515	KG5524						

CHEVROLET Caprice

1977-96	Station Wagon		343127	343157	KG4515	KG5504						
1971-96	Police Car & Taxi Sedan & Coupe (Exc. Police & Taxi)		344081 343127	343130 343130	KG5458 KG4515	KG5507 KG5507						
1971-76	Station Wagon		343127	343157	KG4515							
1966-70	ALL		343128	343130	KG4515	KG5507						

CHEVROLET Cavalier, Z24 (also see STRUT-PLUS)

1999-05	ALL Lower Spring Seat Insulator		334316	341244			734038	741061	SM5283 SM5418	SM5147	SB101	
1995-98	ALL Strut Mount Bearing Upper Spring Seat w/ Insulator Lower Spring Seat Insulator		334316	341244			734038	741061	SM5142 SM5284 SM5419 SM5418	SM5147	SB101	
1992-94	ALL Upper Springseat w/ Isolator	Right Hand Left Hand	231013 231014	343177 343177		KG4536 KG4536			SM5033 SM5033 SM5348	SM5010 SM5010	SB103 SB103	
1987-91	ALL Upper Springseat w/ Isolator	Right Hand Left Hand	231013 231014	343177 343177		KG4536 KG4536			SM5007 SM5007 SM5348	SM5010 SM5010	SB104 SB104	
1984-86	ALL w/ Sealed Struts ALL (Exc. Sealed Struts) Upper Springseat w/ Isolator	Right Hand Left Hand	231013 231014 366003 ¹⁸	343177 343177 343177		KG4536 KG4536 KG4536			SM5007 SM5007 SM5007 SM5348	SM5010 SM5010 SM5010	SB104 SB104 SB104	
1982-83	ALL Upper Springseat w/ Isolator		365038 ¹⁸	343177		KG4536			SM5007 SM5348		SB104	

CHEVROLET Cavalier - STRUT-PLUS

1999-05	ALL		SR4024	SR4025								
1995-98	ALL		SR4024	SR4025								

CHEVROLET Celebrity

1990	ALL Upper Spring Seat w/ Insulator		234019	343160		KG5555			SM5043 SM5229	SM5010	SB104	
1985-89	ALL Upper Spring Seat w/ Insulator		234019	343160		KG5555			SM5056 SM5229	SM5010	SB104	
1984	ALL w/ HD Susp. ALL w/ Std. Susp. Upper Spring Seat w/ Insulator		234019 234002	343160 343160		KG5555 KG5555			SM5056 SM5056 SM5229	SM5010 SM5010	SB104 SB104	
1982-83	ALL		234002	343160		KG5555			SM5056		SB104	

¹⁸ Strut must be cut to install cartridge. Check strut for a cut line groove (20mm from strut top). If no cut line groove is found, do not cut strut open as there are no threads inside. The complete strut must be replaced.

⁷ Use Kit #107

Applications For Pass. Cars, Light Trucks, SUV's, & Vans

VEHICLE MAKE, MODEL & YEAR	GR-2		Gas-a-Just		MonoMax 56XXXX Series		STRUT & SHOCK			
MARQUE, MODELE ET	Excel-G				AGX 7XXXXX Series		MOUNTS		BOOT KITS	
ANNEE DU VEHICULE										
LA MARCA EL MODELO & ANO										

CHEVROLET Chevelle

1973-77	Sedan & Coupe Station Wagon	343127 343127	343157 343157	KG4513 KG4513	KG5504						
1968-72	ALL	343127	343157	KG4513	KG5504						
1964-67	ALL	343128	343130	KG4515	KG5507						

CHEVROLET Chevette

1976-87	ALL	343145	343147								
---------	-----	--------	--------	--	--	--	--	--	--	--	--

CHEVROLET Chevy II

1968-69	ALL (Exc. HD Susp.) w/ HD Susp.	343127 343127	343132 343157	KG4515 KG4515	KG5506 KG5504						
1962-67	ALL Shock (Sleeve) Adapter Kit		343135 ⁷ KIT107								

CHEVROLET Citation

1985	ALL Upper Spring Seat w/ Insulator	234019	343160		KG5555			SM5056 SM5229	SM5010	SB104	
1984	ALL w/ Std. Susp. X11 & HD Susp. Upper Spring Seat w/ Insulator	234002 234019	343160 343160		KG5555 KG5555			SM5056 SM5056 SM5229	SM5010 SM5010	SB104 SB104	
1982-83	ALL	234002	343160		KG5555			SM5056		SB104	
1980-81	ALL	234002	343160		KG5555					SB104	

CHEVROLET Classic (also see STRUT-PLUS)

2004-05	ALL Lower Spring Seat Insulator	334229	334295			734056	734057	SM5146 SM5420	SM5145 SM5524	SB104	SB101
---------	------------------------------------	--------	--------	--	--	--------	--------	------------------	------------------	-------	-------

CHEVROLET Classic - STRUT-PLUS

2004-05	ALL	SR4001	SR4037 ⁶³								
---------	-----	--------	----------------------	--	--	--	--	--	--	--	--

CHEVROLET Cobalt

2010	ALL (Exc. SS 2.0L)		349043					SM5513		SB101	
2005-09	ALL (Exc. SS 2.0L)	Right Hand Left Hand	339084 339085	349043 349043				SM5513 SM5513		SB101 SB101	

CHEVROLET Colorado (2WD)

2004-09	ALL w/ Off-Road Package ALL w/o Off-Road Package	344465 341374	344466 344464	KG5781	KG5190 KG5191						
2004-07	Upper Spring Seat Insulator							SM5413			

CHEVROLET Colorado (4WD)

2004-09	ALL w/ Off-Road Package ALL w/o Off-Road Package	344465	344466	KG5781 KG5781	KG5190 KG5190						
---------	---	--------	--------	------------------	------------------	--	--	--	--	--	--













CHEVROLET Corsica

1995-96	ALL w/o Swaybar Bracket ALL w/ Swaybar Bracket Upper Spring Seat w/ Insulator	Right Hand Left Hand	235604 235605	343402 343402 343402	KG4552 KG4552 KG5576			SM5142 SM5142 SM5142 SM5228	SM5010 SM5010 SM5010	SB104 SB104 SB104	
1992-96	Strut Mount Bearing							SM5284			

⁶³ New Part Number; Available 4th Quarter 2010

⁷ Use Kit #107

Applications For Pass. Cars, Light Trucks, SUV's, & Vans

VEHICLE MAKE, MODEL & YEAR	  	STRUT & SHOCK		BOOT KITS	
MARQUE, MODELE ET		MOUNTS			
ANNEE DU VEHICULE					
LA MARCA EL MODELO & ANO					
	 	 	 	 	 

CHEVROLET Corsica (continued)

1992-94	ALL w/o Swaybar Bracket	Right Hand	235604	343177		KG4536			SM5073	SM5010	SB104	
		Left Hand	235605	343177		KG4536			SM5073	SM5010	SB104	
	ALL w/ Swaybar Bracket Upper Springseat w/ Isolator			343177		KG4536			SM5073 SM5349	SM5010	SB104	
1987-91	ALL	Right Hand	231013	343177		KG4536			SM5033	SM5010	SB104	
	Upper Springseat w/ Isolator	Left Hand	231014	343177		KG4536			SM5033 SM5348	SM5010	SB104	

CHEVROLET Corvair

1960-64	ALL		343127	343127	KG4550	KG4550						
---------	-----	--	--------	--------	--------	--------	--	--	--	--	--	--

CHEVROLET Corvette

1997-04	ALL (Exc Sport Susp., Electronic Susp., F55 Magnetic Selective Ride)				553601 ⁷³	555605 ⁷⁹						
	ALL w/ Sport Susp., (Exc Electronic Susp., F55 Magnetic Selective Ride)				555604	553602 ⁸⁰						
1990-96	ALL (For Adapting ERC to Non-ERC Suspension)				KG5570 ^C	KG5571 ^C						
1989-96	ALL (Exc. Electronic Susp.)				KG5570	KG5571						
1988	ALL				KG5569	KG5571						
1984-87	ALL				KG4537	KG5564						
1963-82	ALL		343127	343218	KG4550	KG5501						
1953-62	ALL			343211	KG4503	KG5562						

CHEVROLET Del Ray

1958	ALL		343127	343130								
------	-----	--	--------	--------	--	--	--	--	--	--	--	--

CHEVROLET El Camino

1978-87	ALL		343127	343157 ²⁵	KG4513	KG5548 ²⁵						
1968-77	ALL		343127	343157 ²⁵	KG4513	KG5504 ²⁵						
1959-67	ALL		343128	343130	KG4515	KG5507						

CHEVROLET Equinox

2007-09	ALL	Right Hand		345055		554353						
		Left Hand		345055		554353						
2005-06	ALL	Right Hand	339058	345055		554353					SB102	
		Left Hand	339057	345055		554353					SB102	

CHEVROLET Express 1500 (Van)

2003-10	2WD		344481	344483	KG5780	KG5188		565033				
	AWD		341343	344483	KG5040	KG5188		565033				
1996-02	ALL		344265	344273	KG5478	KG54100	565060	565033				

CHEVROLET Express 2500 (Van)

2003-10	ALL (Exc. 7300 GVW)		349046	349009	554356	554348						
2003-07	ALL w/ 7300 GVW		344481	344273	KG5780	KG54100		565033				
1996-02	ALL		344265	344273	KG5478	KG54100	565060	565033				

²⁵ Eliminates OEM airshocks. See appendix B for special instructions.

⁷³ When [553601] stock is depleted, use [555604]

⁷⁹ When [555605] stock is depleted, use [555609]

⁸⁰ When [553602] stock is depleted, use [555609]

^C To convert from Electronic Susp - See Appendix C

Applications For Pass. Cars, Light Trucks, SUV's, & Vans

VEHICLE MAKE, MODEL & YEAR	GR-2	Gas-a-Just	MonoMax 56XXXX Series	STRUT & SHOCK	
MARQUE, MODELE ET	Excel-G		AGX 7XXXXX Series	MOUNTS	BOOT KITS
ANNEE DU VEHICULE					
LA MARCA EL MODELO & ANO					

CHEVROLET Express 3500 (Van)

2006-10	ALL (Exc. Cutaway Chassis)	349046	349009	554356	554348					
	Cutaway Chassis w/ Lowered rear Leaf Susp.	349046	344483	554356	KG5188					
2003-05	ALL w/ Dual Rear Wheels	349046	344273	554356	KG5188		565033			
	ALL w/ Single Rear Wheels	349046	344262	554356	KG5188		565034			
1996-02	ALL w/ Dual Rear Wheels	344265	344273	KG5478	KG54100	565060	565033			
	ALL w/ Single Rear Wheels	344265	344262	KG5478	KG54101	565060	565034			

CHEVROLET G-Series (1/2 Ton) Van

1978-95	ALL	344068	344075	KG5409	KG5430	565032	565039			
1971-77	G10	344068		KG5409	KG5417	565032				
1967-70	G10		344085		KG5419		565037			
1964-66	G10				KG5416					

CHEVROLET G-Series (3/4 Ton) Van

1978-95	ALL	344068	344075	KG5409	KG5430	565032	565039			
1971-77	ALL	344068		KG5409	KG5417	565032				
1967-70	ALL		344085		KG5419		565037			

CHEVROLET G-Series (1 Ton) Van (Exc. Motorhome Chassis)

1993-96	G30 HD w/ Straight Front Axle Leaf Spring (P42, P62)	345030	344366	KG6001A	KG5420		565038			
	G30 HD w/ Independent Front Coil Spring (P42, P62)		344366	KG6412	KG5420		565038			
1978-95	G30 Series (Exc. Dual Rear wheels & G30 HD)	344068	344075	KG5409	KG5430	565032	565039			
	G30 Series w/ Dual Rear wheels	344068		KG5409	KG5488	565032				
1971-77	ALL	344068		KG5409	KG5417	565032				

CHEVROLET HHR













2010	LS & LT Models	Right Hand	339084	349043						
		Left Hand	339085	349043						
2006-09	LS & LT Models	Right Hand	339084	349043				SM5513		SB101
		Left Hand	339085	349043				SM5513		SB101

CHEVROLET Impala (also see STRUT-PLUS)

2010	ALL (Exc. Police Car & Taxi)	Right Hand	339015	334228							
		Left Hand	339015	334228							
2006-09	ALL (Exc. Models w/ 17" & 18" Wheels, Police, Taxi)	Right Hand	339015	334228				SM5143	SM5399	SB127	SB128
		Left Hand	339015	334228				SM5143	SM5398	SB127	SB128
	ALL w/ 17" or 18" Wheels	Right Hand	339015	339148				SM5143		SB127	
		Left Hand	339015	339148				SM5143		SB127	
	Universal Strut Mount w/ Boot Upper Spring Seat w/ Insulator Upper Spring Seat Insulator Lower Spring Seat Insulator						SM5470 SM5467 SM5437	SM5394 SM5440			
2004-05	ALL (Exc. Police, Taxi & Special Handling Package)	Right Hand	334227	334228		734058	734059	SM5143	SM5399	SB127	SB128
		Left Hand	334227	334228		734058	734059	SM5143	SM5398	SB127	SB128
	ALL w/ Special Handling Suspension	Right Hand	334227	339148		734058	734059	SM5143	SM5399	SB127	SB128
		Left Hand	334227	339148		734058	734059	SM5143	SM5398	SB127	SB128
	Universal Strut Mount w/ Boot						SM5143	SM5394			

Notes de bas de Page 259 - Guia de notas al calce del catalogo Pg. 260
 Bold part numbers indicate the most comparable KYB product to the original design & performance.
 (22) For vehicles with Electronic Susp., Leveling Control, and Air Suspensions refer to Appendix C.

Applications For Pass. Cars, Light Trucks, SUV's, & Vans

VEHICLE MAKE, MODEL & YEAR	  	STRUT & SHOCK		BOOT KITS	
MARQUE, MODELE ET		MOUNTS			
ANNEE DU VEHICULE					
LA MARCA EL MODELO & ANO	 	 	 	 	 

CHEVROLET Impala (also see STRUT-PLUS) (continued)

2004-05	Upper Spring Seat w/ Insulator Upper Spring Seat Insulator Lower Spring Seat Insulator							SM5470 SM5467 SM5437	SM5440			
2000-03	ALL Universal Strut Mount w/ Boot Upper Spring Seat w/ Insulator Upper Spring Seat Insulator Lower Spring Seat Insulator	Right Hand Left Hand	334227 334227	334228 334228			734058 734058	734059 734059	SM5143 SM5143 SM5470 SM5467 SM5437	SM5399 SM5398 SM5394 SM5440	SB127 SB127	SB128 SB128
1994-96	SS		344081	343130	KG5458	KG5507						
1977-85	Station Wagon		343127	343157	KG4515	KG5504						
1971-85	ALL (Exc. Wagon, Police Car & Taxi) Police Car & Taxi		343127 344081	343130 343130	KG4515 KG4515	KG5507 KG5507						
1971-76	Station Wagon		343127	343157	KG4515							
1965-70	ALL		343128	343130	KG4515	KG5507						
1958-64	ALL (Exc. 58-60 Air Susp.)		343127	343130	KG4550	KG5507						

CHEVROLET Impala - STRUT-PLUS

2004-06	ALL (Exc. Police, Taxi & Special Handling Package)		SR4002									
2001-03	3.4L (Exc. Police, Taxi & Special Handling Package) 3.8L (Exc. Police, Taxi & Special Handling Package)		SR4002									
		Right Hand Left Hand	SR4002 SR4002	SR4003 SR4004								
2000	ALL (Exc. Police, Taxi & Special Handling Package)		SR4002									

CHEVROLET Kingswood

1971-72	ALL		343127	343157								
1969-70	ALL		343128	343130								

CHEVROLET Laguna

1973-76	Sedan & Coupe		343127	343157	KG4513	KG5504						
1973	Station Wagon		343127	343157	KG4513							

CHEVROLET Lumina (Exc. APV) (also see STRUT-PLUS)

2000-01	ALL Lower Spring Seat w/ Insulator	Right Hand Left Hand Right Hand Left Hand	366004 ²⁰ 366004 ²⁰	335014 335014					SM5143 SM5143 SM5384 SM5383	SM5397 SM5396	SB104 SB104	SB104 SB104
1995-01	Universal Strut Mount Universal Strut Mount w/ Boot									SM5117 SM5393		
1995-99	ALL w/ HD Susp. ALL w/ Std. Susp.	Right Hand Left Hand Right Hand Left Hand	366004 ²⁰ 366004 ²⁰ 366004 ²⁰ 366004 ²⁰	335014 335014 335014 335014				SM5030 SM5030 SM5029 SM5029	SM5397 SM5396 SM5397 SM5396	SB104 SB104 SB104 SB104	SB104 SB104 SB104 SB104	
1990-99	Strut Mount Bearing Lower Spring Seat	Right Hand Left Hand							SM5083 SM5226 SM5225			
1990-94	90 Late Prod. w/ HD Susp. (10mm X 1.25 Studs on Front Upper Retainer) 90 Late Prod. w/ Std. Susp. (10mm X 1.25 Studs on Front Upper Retainer)		366004 ²⁰ 366004 ²⁰	236003 236003					SM5030 SM5029	SM5016 SM5016	SB104 SB104	SB106 SB106

²⁰ See Special Installation Instructions Appendix A.

Notes de bas de Page 259 - Guia de notas al calce del catalogo Pg. 260
 Bold part numbers indicate the most comparable KYB product to the original design & performance.
 (22) For vehicles with Electronic Susp., Leveling Control, and Air Suspensions refer to Appendix C.

Applications For Pass. Cars, Light Trucks, SUV's, & Vans

VEHICLE MAKE, MODEL & YEAR	GR-2	Gas-a-Just	MonoMax 56XXXX Series	STRUT & SHOCK	
MARQUE, MODELE ET	Excel-G		AGX 7XXXX Series	MOUNTS	BOOT KITS
ANNEE DU VEHICULE					
LA MARCA EL MODELO & ANO					

CHEVROLET Lumina (Exc. APV) (also see STRUT-PLUS) (continued)

1990	90 Early Prod. w/ H.D. Susp. (8mm X 1.25 Studs on Front Upper Retainer)	366004 ²⁰	236003					SM5031	SM5016	SB104	SB106
	90 Early Prod. w/ Std. Susp. (8mm X 1.25 Studs on Front Upper Retainer)	366004 ²⁰	236003					SM5025	SM5016	SB104	SB106

CHEVROLET Lumina (Exc. APV) - STRUT-PLUS

1990-94	90 Late Prod. w/ HD Susp. (10mm X 1.25 Studs on Front Upper Retainer)		SR4026								
	90 Late Prod. w/ Std. Susp. (10mm X 1.25 Studs on Front Upper Retainer)		SR4026								
1990	90 Early Prod. w/ H.D. Susp. (8mm X 1.25 Studs on Front Upper Retainer)		SR4026								
	90 Early Prod. w/ Std. Susp. (8mm X 1.25 Studs on Front Upper Retainer)		SR4026								

CHEVROLET Lumina APV Mini-Van (Footnote # 22)

1994-96	ALL w/o Rear Level Control Upper Spring Seat w/ Insulator		343160		KG5555			SM5043	SM5010	SB104	
								SM5229			
1990-93	ALL w/ Rear Level Control	234019	343160 ²²		KG5555 ²²			SM5043	SM5010	SB104	
	ALL w/o Rear Level Control Upper Spring Seat w/ Insulator	234019	343160		KG5555			SM5043	SM5010	SB104	

CHEVROLET Luv

1980-82	2WD	344043	344045	KG5446	KG5438	565045					
	4WD	344427	344044	KG5444	KG5445						
1972-79	ALL (Exc. Camper Model)		344044	KG4613A	KG4012						

CHEVROLET Luv - Lift Replacement Shocks

1980-82	2WD Lift = 1-3"					565083					
1972-79	ALL (Exc. Camper Model) Lift = 1-3"					565028					

CHEVROLET Malibu (Exc. Maxx) (also see STRUT-PLUS)











2010	ALL		349008								
2008-09	ALL (Exc. Classic)	Right Hand	339051	349008							
		Left Hand	339052	349008							
2008	Malibu Classic	Right Hand	339051	343454				SM5471	SM5476	SB101	
		Left Hand	339052	343454				SM5447	SM5476	SB101	
2006-07	ALL (Exc. SS Model)	Right Hand	339051	343454				SM5471	SM5476	SB101	
		Left Hand	339052	343454				SM5447	SM5476	SB101	
	SS	Right Hand	---- ⁷⁰	343454				SM5471	SM5476	SB101	
		Left Hand	---- ⁷⁰	343454				SM5447	SM5476	SB101	
2004-05	ALL	Right Hand	339051	343454				SM5471	SM5476	SB104	
		Left Hand	339052	343454				SM5447	SM5476	SB104	
1998-03	ALL w/ 2.50" Rear Strut Bolt Hole Spacing (From Late 1998)		334229	334295		734056	734057	SM5146	SM5145	SB104	SB101
	Upper Spring Seat Insulator							SM5438			
	Lower Spring Seat Insulator							SM5420	SM5524		
1997-98	ALL w/ 3.25" Rear Strut Bolt Hole Spacing (To Early 1998)		334229	334230		734056		SM5146	SM5145	SB104	SB101
	Upper Spring Seat Insulator							SM5438			
	Lower Spring Seat Insulator							SM5420	SM5524		
1978-83	ALL		343127	343157	KG4513	KG5548					
1973-77	Sedan, Coupe & Convertible Station Wagon		343127	343157	KG4513	KG5504					
			343127	343157	KG4513						

²⁰ See Special Installation Instructions Appendix A.

²² For vehicles with Electronic Susp., Leveling Control, and Air Suspensions refer to Appendix C.

⁷⁰ New Part Number, Available 2nd Quarter 2010

Applications For Pass. Cars, Light Trucks, SUV's, & Vans

VEHICLE MAKE, MODEL & YEAR	GR-2	Gas-a-Just	MonoMax 56XXXX Series	STRUT & SHOCK	
MARQUE, MODELE ET	Excel-G		AGX 7XXXXX Series	MOUNTS	BOOT KITS
ANNEE DU VEHICULE	 	 	 	 	 
LA MARCA EL MODELO & ANO					

CHEVROLET Malibu (Exc. Maxx) (also see STRUT-PLUS) (continued)

1968-72	ALL	343127	343157	KG4513	KG5504					
1964-67	ALL	343128	343130	KG4515	KG5507					

CHEVROLET Malibu (FWD) - STRUT-PLUS

1998-03	ALL w/ 2.50" Rear Strut Bolt Hole Spacing (From Late 1998)	SR4001	SR4037 ⁶³							
1997-98	ALL w/ 3.25" Rear Strut Bolt Hole Spacing (To Early 1998)	SR4001								

CHEVROLET Malibu Maxx

2006-07	ALL	Right Hand	339051	349008					SM5471	SM5476	SB101
		Left Hand	339052	349008					SM5447	SM5476	SB101
2004-05	ALL	Right Hand	339051	349008					SM5471	SM5476	SB104
		Left Hand	339052	349008					SM5447	SM5476	SB104

CHEVROLET Metro (Also See GEO)

1998-01	ALL	Right Hand	232025						SM5188	SM5189	SB103	SB101
		Left Hand	232026						SM5188	SM5189	SB103	SB101

CHEVROLET Monte Carlo (also see STRUT-PLUS)

2006-07	ALL (Exc. Models w/ 17" & 18" Wheels)	Right Hand	339015	334228					SM5143	SM5399	SB127	SB128
		Left Hand	339015	334228					SM5143	SM5398	SB127	SB128
	ALL w/ 17" or 18" Wheels	Right Hand	339015	339148					SM5143	SM5399	SB127	SB128
		Left Hand	339015	339148					SM5143	SM5398	SB127	SB128
	Universal Strut Mount w/ Boot Universal Strut Mount Upper Spring Seat w/ Insulator Upper Spring Seat Insulator Lower Spring Seat Insulator								SM5470 SM5467 SM5437	SM5394 SM5144 SM5440		
2004-05	ALL (Exc. Special Handling Pkg.)	Right Hand	334227	334228		734058	734059	SM5143	SM5399	SB127	SB128	
		Left Hand	334227	334228		734058	734059	SM5143	SM5398	SB127	SB128	
	ALL w/ Special Handling Suspension	Right Hand	339015	339148					SM5143	SM5399	SB127	SB128
		Left Hand	339015	339148					SM5143	SM5398	SB127	SB128
	Universal Strut Mount w/ Boot Universal Strut Mount Upper Spring Seat w/ Insulator Upper Spring Seat Insulator Lower Spring Seat Insulator								SM5470 SM5467 SM5437	SM5394 SM5144 SM5440		
2000-03	ALL	Right Hand	334227	334228		734058	734059	SM5143	SM5399	SB127	SB128	
		Left Hand	334227	334228		734058	734059	SM5143	SM5398	SB127	SB128	
	Universal Strut Mount w/ Boot Universal Strut Mount Upper Spring Seat w/ Insulator Upper Spring Seat Insulator Lower Spring Seat Insulator							SM5470 SM5467 SM5437	SM5394 SM5144 SM5440			
1995-99	ALL	Right Hand	366004 ²⁰	335014				SM5030	SM5397	SB104	SB128	
		Left Hand	366004 ²⁰	335014				SM5030	SM5396	SB104	SB128	
	Strut Mount Bearing Universal Strut Mount w/ Boot Universal Strut Mount Lower Spring Seat							SM5083	SM5393			
		Right Hand Left Hand						SM5384 SM5383	SM5117			
1978-88	ALL	343127	343157	KG4513	KG5548							
1970-77	ALL	343127	343157	KG4513	KG5504							

²⁰ See Special Installation Instructions Appendix A.











⁶³ New Part Number; Available 4th Quarter 2010

Notes de bas de Page 259 - Guia de notas al calce del catalogo Pg. 260

Bold part numbers indicate the most comparable KYB product to the original design & performance.

(22) For vehicles with Electronic Susp., Leveling Control, and Air Suspensions refer to Appendix C.

Applications For Pass. Cars, Light Trucks, SUV's, & Vans

VEHICLE MAKE, MODEL & YEAR	  	STRUT & SHOCK		BOOT KITS	
MARQUE, MODELE ET		MOUNTS			
ANNEE DU VEHICULE					
LA MARCA EL MODELO & ANO					
	 	 	 	 	 

CHEVROLET Monte Carlo - STRUT-PLUS

2006	ALL (Exc. Special Handling Pkg.)									
	Right Hand	SR4002								
	Left Hand	SR4002								
2000-05	ALL (Exc. Special Handling Pkg.)									
	Right Hand	SR4002	SR4003							
	Left Hand	SR4002	SR4004							

CHEVROLET Monza

1975-80	ALL (Incl. Station Wagon)	343129	343132							
---------	---------------------------	--------	--------	--	--	--	--	--	--	--

CHEVROLET Nova

1988	Twin Cam	365041	232030						SM5069	SB101	SB102	
1985-88	ALL (Exc. Twin Cam)								SM5019	SM5069	SB101	SB102
	Right Hand	234024	232028						SM5019	SM5069	SB101	SB102
	Left Hand	234025	232029						SM5019	SM5069	SB101	SB102
1974-79	ALL	343127	343132	KG4515	KG5506							
1968-73	ALL (Exc. HD Susp.)	343127	343132	KG4515	KG5506							
	w/ HD Susp.	343127	343157	KG4515	KG5504							
1962-67	ALL		343135 ⁷									
	Shock (Sleeve) Adapter Kit		KIT107									

CHEVROLET One-Fifty Series

1955-57	ALL	343127	343149							
---------	-----	--------	--------	--	--	--	--	--	--	--

CHEVROLET P10

1974-84	ALL	344068	344366	KG5409	KG5420	565032	565038			
1973	ALL	344068	344072	KG5409	KG5415	565032	565036			
1967-72	ALL	344068		KG5409	KG5416	565032				
1963-66	ALL	344068	344085	KG5409	KG5419	565032	565037			

CHEVROLET P20

1982-91	ALL	344068	344366	KG5409	KG5420	565032	565038			
1973-81	ALL	344068	344072	KG5409	KG5415	565032	565036			
1968-72	ALL	344068	344085	KG5409	KG5419	565032	565037			

CHEVROLET P30 (Exc. Motorhome Chassis)

1985-01	ALL (Exc. Monobeam Front Susp. & Camper Conversion)	344068	344366	KG5409	KG5420	565032	565038			
	w/ Monobeam Front Susp., Including Camper Conversion	345030	344366	KG6001A	KG5420		565038			
	w/ Camper Conversion (Exc. Monobeam Front Susp.)		344366		KG5420		565038			
1973-84	ALL Incl. Camper Conversion	344068	344366	KG5409	KG5420	565032	565038			
1968-72	ALL (Exc. w/ 157" WB & 11,000lb. Axle)	344068	344085	KG5409	KG5419	565032	565037			
	w/ 157" WB & 11,000lb. Axle	344068		KG5409	KG5417	565032				













CHEVROLET Prizm (Also See GEO)

1998-02	ALL											
	Right Hand	234057	234059						SM5049	SM5075	SB103	SB117
	Left Hand	234058	234060						SM5049	SM5074	SB103	SB117

⁷ Use Kit #107

Notes de bas de Page 259 - Guia de notas al calce del catalogo Pg. 260
 Bold part numbers indicate the most comparable KYB product to the original design & performance.
 (22) For vehicles with Electronic Susp., Leveling Control, and Air Suspensions refer to Appendix C.

Applications For Pass. Cars, Light Trucks, SUV's, & Vans

VEHICLE MAKE, MODEL & YEAR	  	STRUT & SHOCK		BOOT KITS	
MARQUE, MODELE ET		MOUNTS			
ANNEE DU VEHICULE					
LA MARCA EL MODELO & ANO					
	 	 	 	 	 

CHEVROLET S-Series (2WD) Pickup

1999-03	ALL (Exc V4A Xtreme Sport Appearance Pkg.)	344040	344041	KG5450	KG5451	565046	565047				
	ALL w/ V4A Xtreme Sport Appearance Pkg.	344040		KG5450							
1995-98	ALL	344040	344041	KG5450	KG5451	565046	565047				
1982-03	ALL (Lowered 2" / 4")					565046	565064				
1982-94	ALL	344040	344041	KG5450	KG5451	565046	565047				

CHEVROLET S-Series (4WD) Pickup

1995-04	ALL (Exc. ZR2 Wide Stance Package)	344042	344041	KG5452	KG5451	565048	565047				
1995-03	ALL w/ ZR2 Wide Stance Package	344042		KG5452		565048					
1982-94	ALL	344042	344041	KG5452	KG5451	565048	565047				

CHEVROLET S-Series (4WD) Pickup, Blazer - Lift Replacement Shocks

1982-05	ALL Lift = 1-3"					565075					
---------	-----------------	--	--	--	--	--------	--	--	--	--	--

CHEVROLET SSR

2003-06	ALL Mount w/ Spring Insulator Lower Spring Seat Insulator	331016 ⁸¹	343395		KG4162			SM5395 SM5548 ⁶³		SB108	
---------	---	-----------------------------	---------------	--	--------	--	--	--------------------------------	--	-------	--

CHEVROLET Silverado, C & R - Series 1/2 Ton (2WD)

2007-09	Silverado 1500 (Exc. Classic Series, HD & Electronic Susp.)	341493	345074	551121 ⁷⁰	555055			SM5530 ⁶³		SB129	
2007	Silverado Classic 1500 (Exc. Elec. Susp., QuadraSteer & HD)	344380	344365	KG54326	KG54104	565066	565016				
	Silverado 1500 Crew Cab Classic w/ Torsion Bar Front Susp. (Exc. Elec. Susp. & QuadraSteer)	344381	344386	KG54327	KG54341	565067	565103				
	Silverado 1500HD Crew Cab w/ Front Torsion Bar Susp. (Exc. Elec. Susp. & QuadraSteer)	344383	344385	KG54340	KG54342	565102	565104				
	Silverado 1500 Crew Cab Classic w/ Coil Spring Front Susp. (Exc. Elec. Susp.)	344402	344385	KG54339	KG54342	565101	565104				
2004-06	Silverado 1500 Crew Cab w/ Coil Spring Front Susp. (Exc. Elec. Susp. & QuadraSteer)	344402	344385	KG54339	KG54342	565101	565104				
2005-06	Silverado 1500HD Crew Cab (Exc. Elec. Susp. & QuadraSteer)	344383	344385	KG54340	KG54342	565102	565104				
2004-06	Silverado 1500 Crew Cab w/ Torsion Bar Front Susp. (Exc. Elec. Susp. & QuadraSteer)	344381	344386	KG54327	KG54341	565067	565103				
2001-03	Silverado 1500HD Crew Cab w/ Front Torsion Bar Susp. (Exc. Elec. Susp. & QuadraSteer)	344383	344385	KG54340	KG54342	565102	565104				
2001-02	Silverado 1500HD Crew Cab w/ Coil Spring Front Susp. (Exc. Elec. Suspension)	344402	344385	KG54339	KG54342	565101	565104				
1999-06	Silverado 1500 (Exc. HD, Crew Cab, Elec. Susp. & QuadraSteer)	344380	344365	KG54326	KG54104	565066	565016				
1988-99	C1500	344265	344263	KG5478	KG5479	565060	565061				
	C1500 (Lowered 2" / 4")					565060	565033				
1973-87	C10, R10	344068	344072	KG5409	KG5415	565032	565036				

⁶³ New Part Number; Available 4th Quarter 2010
⁷⁰ New Part Number, Available 2nd Quarter 2010
⁸¹ When [331016] stock is depleted, use [331043]

Applications For Pass. Cars, Light Trucks, SUV's, & Vans

VEHICLE MAKE, MODEL & YEAR						
MARQUE, MODELE ET	GR-2	Gas-a-Just	MonoMax 56XXXX Series	STRUT & SHOCK		
ANNEE DU VEHICULE	Excel-G		AGX 7XXXXX Series	MOUNTS		BOOT KITS
LA MARCA EL MODELO & ANO						

CHEVROLET Silverado, C & R - Series 1/2 Ton (2WD) (continued)

1967-72	C10 w/ Coil Spring	344068		KG5409	KG5416	565032				
	C10 w/ Leaf Spring	344068	344085	KG5409	KG5419	565032	565037			
1963-66	C10	344068	344085	KG5409	KG5419	565032	565037			

CHEVROLET Silverado, K & V - Series 1/2 Ton (4WD)

2007-09	Silverado 1500 (Exc. Classic Series, HD & Electronic Susp.)	341493	345074	551121 ⁷⁰	555055			SM5530 ⁶³		SB129
2007	Silverado Classic 1500 (Exc. HD, Elec. Susp. & QuadraSteer)	344381	344386	KG54327	KG5482	565067	565068			
	Silverado 1500 Classic w/ Z-71 Off Road Package			KG54327	KG5482	565067	565068			
	Silverado SS (AWD)			KG54327	NA	565067	NA			
2005-07	Silverado 1500HD Crew Cab (Incl. Classic) (Exc. Elec. Susp. & QuadraSteer)	344383	344385	KG54340	KG54342	565102	565104			
2003-06	Silverado SS (AWD)			KG54327	KG54341	565067	565103			
2001-03	Silverado 1500HD Crew Cab (Exc. Elec. Susp. & QuadraSteer)	344383	344385	KG54340	KG54342	565102	565104			
1999-06	Silverado 1500 (Exc. HD, Elec. Susp. & QuadraSteer)	344381	344386	KG54327	KG5482	565067	565068			
	Silverado 1500 (w/ Z-71 Off Road Package)			KG54327	KG5482	565067	565068			
1988-99	K1500 (Exc. Z-71 Off Road Package)	344266	344263	KG5480	KG5479	565062	565061			
	K1500 w/ Z-71 Off Road Package			KG5480	KG5479	565062	565061			
1985-91	ALL w/ Dual Front Shocks - inside shock		344072	KG5477	KG5415	565039	565036			
	ALL w/ Dual Front Shocks - outside shock	344067	344072	KG5408	KG5415	565031	565036			
1980-84	ALL w/ Dual Front Shocks - inside shock	344075	344072	KG5430	KG5415	565039	565036			
	ALL w/ Dual Front Shocks - outside shock	344067	344072	KG5408	KG5415	565031	565036			
1973-87	K10, V10 (Exc. w/ Dual Front Shocks)	344067	344072	KG5408	KG5415	565031	565036			
1969-72	K10	344067		KG5408	KG5417	565031				

CHEVROLET Silverado, K & V Series (1/2 Ton) (4WD) Steering Stabilizer

1988-05	Complete Kit	SS15326								
1988-98	w/ OE Unit (Cylinder only)	SS10317								
1973-87	OEM Replacement Cylinder	SS10325								

CHEVROLET Silverado, C & R - Series 3/4 Ton (2WD)













2005-10	Silverado 2500HD	344383	344385	KG54340	KG54342	565102	565104			
2000-04	Silverado 2500HD (9200GVW)	344383	344385	KG54340	KG54342	565102	565104			
1999-04	Silverado 2500 (up to 8600 GVW) (Exc. QuadraSteer)	344402	344385	KG54339	KG54342	565101	565104			
1988-00	C2500	344265	344263	KG5478	KG5479	565060	565061			
	C2500 (Lowered 2" / 4")					565060	565033			
1988-90	R2500	344068	344072	KG5409	KG5415	565032	565036			
1987-88	R20 (Exc. Crew Cab)	344068	344072	KG5409	KG5415	565032	565036			
	R20 Crew Cab	344068	344366	KG5409	KG5420	565032	565038			
1973-86	C20 (Exc. Crew Cab)	344068	344072	KG5409	KG5415	565032	565036			
	C20 Crew Cab	344068	344366	KG5409	KG5420	565032	565038			
1967-72	C20 w/ Coil Spring	344068		KG5409	KG5416	565032				

⁶³ New Part Number; Available 4th Quarter 2010

⁷⁰ New Part Number; Available 2nd Quarter 2010

Notes de bas de Page 259 - Guia de notas al calce del catalogo Pg. 260
 Bold part numbers indicate the most comparable KYB product to the original design & performance.
 (22) For vehicles with Electronic Susp., Leveling Control, and Air Suspensions refer to Appendix C.

Applications For Pass. Cars, Light Trucks, SUV's, & Vans

VEHICLE MAKE, MODEL & YEAR	  	STRUT & SHOCK		BOOT KITS	
MARQUE, MODELE ET		MOUNTS			
ANNEE DU VEHICULE					
LA MARCA EL MODELO & ANO					
	 	 	 	 	 

CHEVROLET Silverado, C & R - Series 3/4 Ton (2WD) (continued)

1967-72	C20 w/ Leaf Spring	344068	344085	KG5409	KG5419	565032	565037				
1963-66	C20	344068	344085	KG5409	KG5419	565032	565037				

CHEVROLET Silverado, K & V - Series 3/4 Ton (4WD)

2005-10	Silverado 2500HD	344383	344385	KG54340	KG54342	565102	565104				
2000-04	Silverado 2500HD (9200GVW)	344383	344385	KG54340	KG54342	565102	565104				
1999-04	Silverado 2500 (up to 8600 GVW) (Exc. Quadrasteer)	344383	344385	KG54340	KG54342	565102	565104				
1988-00	K2500	344266	344263	KG5480	KG5479	565062	565061				
1985-91	ALL w/ Dual Front Shocks - inside shock		344072	KG5477	KG5415	565039	565036				
	ALL w/ Dual Front Shocks - outside shock	344067	344072	KG5408	KG5415	565031	565036				
1980-84	ALL w/ Dual Front Shocks - inside shock	344075	344072	KG5430	KG5415	565039	565036				
	ALL w/ Dual Front Shocks - outside shock	344067	344072	KG5408	KG5415	565031	565036				
1973-87	K20, V20 (Exc. w/ Dual Front Shocks)	344067	344072	KG5408	KG5415	565031	565036				
1969-72	K20	344067		KG5408	KG5417	565031					

CHEVROLET Silverado, K & V Series (3/4 Ton) (4WD) Steering Stabilizer

2002-05	2500HD OEM Replacemant Cylinder	SS10318									
1988-04	Complete Kit	SS15326									
1988-98	w/ OE Unit (Cylinder only)	SS10317									
1973-87	OEM Replacement Cylinder	SS10325									

CHEVROLET Silverado, C & R - Series 1 Ton (2WD)













2007-10	Silverado 3500HD	344383	344384	KG54340	KG54341	565102	565103				
2001-07	Silverado 3500 (11400 GVW) w/ Ind. Front Susp. Inc. Classic	344383	344384	KG54340	KG54341	565102	565103				
1988-00	C3500 (Exc. HD Series)	344265	344263	KG5478	KG5479	565060	565061				
1988-99	C3500 (Lowered 2" / 4")					565060	565033				
1991-03	C3500 HD Series w/ I-Beam Front Axle		344263	KG54307	KG5479		565061				
1987-91	R30, R3500	344068	344366	KG5409	KG5420	565032	565038				
1973-86	C30	344068	344366	KG5409	KG5420	565032	565038				
1967-72	C30 (Exc. w/ 157" WB & 11,000lb. Axle)	344068	344085	KG5409	KG5419	565032	565037				
	C30 w/ 157" WB & 11,000lb. Axle	344068		KG5409	KG5417	565032					

CHEVROLET Silverado, K & V - Series 1 Ton (4WD)

2007-10	Silverado 3500HD	344383	344384	KG54340	KG54341	565102	565103				
2001-07	Silverado 3500 (11400 GVW) (Incl. Chassis Cab & Classic)	344383	344384	KG54340	KG54341	565102	565103				
1989-91	V3500		344386	KG5481	KG5482	565069	565068				
1988-00	K3500	344266	344263	KG5480	KG5479	565062	565061				
1987-88	V30		344386	KG5481	KG5482	565069	565068				
1977-86	K30		344386	KG5481	KG5482	565069	565068				

Notes de bas de Page 259 - Guia de notas al calce del catalogo Pg. 260
 Bold part numbers indicate the most comparable KYB product to the original design & performance.
 (22) For vehicles with Electronic Susp., Leveling Control, and Air Suspensions refer to Appendix C.

Applications For Pass. Cars, Light Trucks, SUV's, & Vans

VEHICLE MAKE, MODEL & YEAR	  	STRUT & SHOCK		BOOT KITS	
MARQUE, MODELE ET		MOUNTS			
ANNEE DU VEHICULE					
LA MARCA EL MODELO & ANO					
	 	 	 	 	 

CHEVROLET Silverado, K & V Series (1 Ton) (4WD) Steering Stabilizer

1973-87	OEM Replacement Cylinder	SS10325								
---------	--------------------------	---------	--	--	--	--	--	--	--	--

CHEVROLET K1500, K2500, K3500 (Exc. Suburban) - Lift Replacement Shocks

1988-99	K1500 w/ Z-71 Off Road Package Lift = 1-3" K1500, K2500, K3500 (Exc. Z-71 Off Road Package) (Exc. Suburban) Lift = 1-3" for Edelbrock # 6360 Lift = 4-6" for Rancho # RS5244 Lift = 4-6" for Rancho # RS9244 Lift = 4-6" for Rancho # RSX17316 Lift = 4-6" for Edelbrock # 63003 Lift = 4-6" for Edelbrock # 6460 Lift = 4-6" for Rancho # RS5227 Lift = 4-6" for Rancho # RS9227 Lift = 4-6" for Rancho # RSX17315 Lift = 4-6"					565073 565073 565086 565092 565086 565087 565087 565087 565087	565074				
---------	---	--	--	--	--	--	--------	--	--	--	--

CHEVROLET Silverado 1500 4WD (Incl. Crew Cab, Exc. 1500HD, Quadrateer) - Lift Replacement Shocks

2007	Silverado Classic 1500 (Exc. HD, Elec. Susp. & Quadrateer) Lift = 1-4"					565076	565077					
1999-06	ALL Lift = 1-4" for Edelbrock # 63005 Lift = 4" for Edelbrock # 63008 Lift = 4" for Rancho # RS9268 Lift = 4" for Rancho # RSX17337 Lift = 4" for Edelbrock # 6405 Lift = 4" for Edelbrock # 6408 Lift = 4" for Rancho # RS9269 Lift = 4" for Rancho # RSX17338 Lift = 4"					565076 565076 565076 565076 565076	565077	565095 565095 565095 565095				

CHEVROLET Spectrum (Also See GEO)

1985-88	ALL	Right Hand Left Hand	232015 232016			KG4542 KG4542			SM5297 SM5297		SB102 SB102
---------	-----	-------------------------	------------------	--	--	------------------	--	--	------------------	--	----------------

CHEVROLET Sprint

1987-88	ALL Inc. Turbo	Right Hand Left Hand	232019 232020	341075 341075							
1985-86	ALL	Right Hand Left Hand		342012 342012							

CHEVROLET Sprint (Canadian Vehicle)

1989-91	ALL	Right Hand Left Hand	232025 232026	232027 232027					SM5188 SM5188	SM5189 SM5189	SB103 SB103	SB101 SB101
---------	-----	-------------------------	------------------	------------------	--	--	--	--	------------------	------------------	----------------	----------------

CHEVROLET Storm (Canadian Vehicle)

1993	ALL	Right Hand Left Hand	234041 234042	232033 232034					SM5081 SM5081	SM5105 SM5105	SB102 SB102	SB105 SB105
------	-----	-------------------------	------------------	------------------	--	--	--	--	------------------	------------------	----------------	----------------

CHEVROLET Suburban 1/2 Ton (2WD) C & R Series

2007-09	1500 (Exc. Electronic or Premium Smooth Ride Susp.)		341493	345073	551121 ⁷⁰	555054			SM5530 ⁶³		SB129	
2000-06	1500 (Exc. Electronic or Premium Smooth Ride Susp.) 1500 w/ ZW7 Premium Smooth Ride Susp. (Exc. Z55 Autoride Susp.)		344381 341343	344384 SR2004	KG54327 KG5040	KG54341	565067	565103				













⁶³ New Part Number; Available 4th Quarter 2010

⁷⁰ New Part Number; Available 2nd Quarter 2010

Notes de bas de Page 259 - Guia de notas al calce del catalogo Pg. 260

Bold part numbers indicate the most comparable KYB product to the original design & performance.
(22) For vehicles with Electronic Susp., Leveling Control, and Air Suspensions refer to Appendix C.

Applications For Pass. Cars, Light Trucks, SUV's, & Vans

VEHICLE MAKE, MODEL & YEAR	  	STRUT & SHOCK		BOOT KITS	
MARQUE, MODELE ET		MOUNTS			
ANNEE DU VEHICULE					
LA MARCA EL MODELO & ANO					
	 	 	 	 	 

CHEVROLET Suburban 1/2 Ton (2WD) C & R Series (continued)

1992-99	C1500	344265	344273	KG5478	KG54100	565060	565033				
1989-91	R1500	344068	344072	KG5409	KG5415	565032	565036				
1987-88	R10	344068	344072	KG5409	KG5415	565032	565036				
1973-86	C10	344068	344072	KG5409	KG5415	565032	565036				
1967-72	C10	344068		KG5409	KG5416	565032					
1963-66	C10	344068	344085	KG5409	KG5419	565032	565037				

CHEVROLET Suburban 1/2 Ton (4WD) K & V Series

2007-09	1500 (Exc. Electronic or Premium Smooth Ride Susp.)	341493	345073	551121 ⁷⁰	555054				SM5530 ⁶³		SB129
2000-06	1500 (Exc. Electronic or Premium Smooth Ride Susp.)	344381	344384	KG54327	KG54341	565067	565103				
	1500 w/ ZW7 Premium Smooth Ride Susp. (Exc. Z55 Autoride Susp.)	341343	SR2004	KG5040							
	1500 w/ Z-71 Off Road Package			KG54327	KG54341	565067	565103				
1992-99	K1500	344266	344262	KG5480	KG54101	565062	565034				
1980-91	ALL w/ Dual Front Shocks - outside shock	344067	344072	KG5408	KG5415	565031	565036				
1985-91	ALL w/ Dual Front Shocks - inside shock		344072	KG5477	KG5415	565039	565036				
1980-84	ALL w/ Dual Front Shocks - inside shock	344075	344072	KG5430	KG5415	565039	565036				
1989-91	V1500 (Exc. w/ Dual Front Shocks)	344067	344072	KG5408	KG5415	565031	565036				
1987-88	V10 (Exc. w/ Dual Front Shocks)	344067	344072	KG5408	KG5415	565031	565036				
1973-86	K10 (Exc. w/ Dual Front Shocks)	344067	344072	KG5408	KG5415	565031	565036				
1969-72	K10	344067		KG5408	KG5417	565031					

CHEVROLET Suburban 3/4 Ton (2WD) C & R Series

2001-09	2500 w/ Torsion Bar Front Susp. (Exc. Z55 Autoride & QuadraSteer)	344383	344384	KG54340	KG54341	565102	565103				
2000-01	2500 w/ Coil Spring Front Susp. (Exc. Z55 Autoride)	344402	344384	KG54339	KG54341	565101	565103				
1992-99	C2500	344265	344273	KG5478	KG54100	565060	565033				
1989-91	R2500	344068	344072	KG5409	KG5415	565032	565036				
1987-88	R20	344068	344072	KG5409	KG5415	565032	565036				
1973-86	C20	344068	344072	KG5409	KG5415	565032	565036				
1967-72	C20	344068		KG5409	KG5416	565032					
1963-66	C20	344068	344085	KG5409	KG5419	565032	565037				

CHEVROLET Suburban 3/4 Ton (4WD) K & V Series

2000-09	2500 (Exc. Z55 Autoride Susp. & QuadraSteer)	344383	344384	KG54340	KG54341	565102	565103				
1992-99	K2500	344266	344262	KG5480	KG54101	565062	565034				
1980-91	ALL w/ Dual Front Shocks - outside shock	344067	344072	KG5408	KG5415	565031	565036				
1985-91	ALL w/ Dual Front Shocks - inside shock		344072	KG5477	KG5415	565039	565036				
1980-84	ALL w/ Dual Front Shocks - inside shock	344075	344072	KG5430	KG5415	565039	565036				
1989-91	V2500 (Exc. w/ Dual Front Shocks)	344067	344072	KG5408	KG5415	565031	565036				

⁶³ New Part Number; Available 4th Quarter 2010













⁷⁰ New Part Number; Available 2nd Quarter 2010

Notes de bas de Page 259 - Guia de notas al calce del catalogo Pg. 260

Bold part numbers indicate the most comparable KYB product to the original design & performance.

(22) For vehicles with Electronic Susp., Leveling Control, and Air Suspensions refer to Appendix C.

Applications For Pass. Cars, Light Trucks, SUV's, & Vans

VEHICLE MAKE, MODEL & YEAR	  	STRUT & SHOCK		BOOT KITS	
MARQUE, MODELE ET		MOUNTS			
ANNEE DU VEHICULE					
LA MARCA EL MODELO & ANO					
	 	 	 	 	 

CHEVROLET Suburban 3/4 Ton (4WD) K & V Series (continued)

1987-88	V20 (Exc. w/ Dual Front Shocks)	344067	344072	KG5408	KG5415	565031	565036				
1973-86	K20 (Exc. w/ Dual Front Shocks)	344067	344072	KG5408	KG5415	565031	565036				
1969-72	K20	344067		KG5408	KG5417	565031					

CHEVROLET Suburban (4WD) Steering Stabilizer

2000-05	Complete Unit	SS15326									
1993-98	w/ OE Unit (Cylinder only)	SS10317									
1973-92	OEM Replacement Cylinder	SS10325									

CHEVROLET Suburban (4WD) - Lift Replacement Shocks

2000-05	1500 Suburban (Exc. Z55 Autoride Susp. or Premium Smooth Ride Susp.) Lift = 1-3"					565076					
1992-99	Suburban Lift = 1-3" for Edelbrock # 6360 Lift = 4-6" for Rancho # RS5244 Lift = 4-6" for Rancho # RS9244 Lift = 4-6" for Rancho # RSX17316 Lift = 4-6" for Edelbrock # 63003 Lift = 4-6" for Edelbrock # 6460 Lift = 4-6" for Rancho # RS5227 Lift = 4-6" for Rancho # RS9227 Lift = 4-6" for Rancho # RSX17315 Lift = 4-6"					565073 565086 565092 565092 565086	565061				
							565093 565087 565093 565093 565093				

CHEVROLET Tahoe (2WD)

2007-09	ALL (Exc. Electronic, ZW7 Premium Smooth Ride Susp. & Police Package)	341493	345073	551121 ⁷⁰	555054			SM5530 ⁶³		SB129	
2001-06	ALL (Exc. Z55 Autoride Susp. or Premium Smooth Ride Susp.) ALL w/ ZW7 Premium Smooth Ride Susp. (Exc. Z55 Autoride Susp.)	344381 341343	344384 SR2003	KG54327 KG5040	KG54341	565067	565103				
2000	ALL 4 Door (New Style) (Exc. Z55 Autoride Susp. or Premium Smooth Ride Susp.) ALL 4 Door (New Style) w/ Premium Smooth Ride Susp. (Exc. Z55 Autoride Susp.) ALL (Old Style)	344381 341343 344265	344384 SR2003	KG54327 KG5040 KG5478	KG54341 KG54100	565067 565060	565103 565033				
1995-99	4 Door 2 Door 2 Door (Lowered 2" / 4")	344265 344265	344273 344263	KG5478 KG5478	KG54100 KG5479	565060 565060 565060	565033 565061 565033				

CHEVROLET Tahoe (4WD)

2007-09	ALL (Exc. Electronic, ZW7 Premium Smooth Ride Susp. & Police Package)	341493	345073	551121 ⁷⁰	555054			SM5530 ⁶³		SB129	
2001-06	ALL (Exc. Z55 Autoride Susp. or Premium Smooth Ride Susp.) ALL w/ ZW7 Premium Smooth Ride Susp. (Exc. Z55 Autoride Susp.) ALL (w/ Z71 Off Road Package)	344381 341343	344384 SR2003	KG54327 KG5040 KG54327	KG54341 KG54341	565067 565067	565103 565103				
2000	ALL 4 Door (New Style) (Exc. Z55 Autoride Susp. or Premium Smooth Ride Susp.) ALL 4 Door (New Style) w/ Premium Smooth Ride Susp. (Exc. Z55 Autoride Susp.)	344381 341343	344384 SR2003	KG54327 KG5040	KG54341	565067	565103				

⁶³ New Part Number; Available 4th Quarter 2010













⁷⁰ New Part Number; Available 2nd Quarter 2010

Notes de bas de Page 259 - Guia de notas al calce del catalogo Pg. 260

Bold part numbers indicate the most comparable KYB product to the original design & performance.

(22) For vehicles with Electronic Susp., Leveling Control, and Air Suspensions refer to Appendix C.

Applications For Pass. Cars, Light Trucks, SUV's, & Vans

VEHICLE MAKE, MODEL & YEAR	  	STRUT & SHOCK		BOOT KITS	
MARQUE, MODELE ET		MOUNTS			
ANNEE DU VEHICULE					
LA MARCA EL MODELO & ANO					
	 	 	 	 	 

CHEVROLET Tahoe (4WD) (continued)

2000	ALL (Old Style)	344266	344263	KG5480	KG5479	565062	565061				
1995-99	ALL 2 Door ALL 4 Door	344266 344266	344263 344262	KG5480 KG5480	KG5479 KG54101	565062 565062	565061 565034				

CHEVROLET Tahoe (4WD) Steering Stabilizer

1995-05	Complete Unit	SS15326									
---------	---------------	---------	--	--	--	--	--	--	--	--	--

CHEVROLET Tahoe (4WD) - Lift Replacement Shocks

2001-06	ALL (Exc. Z55 Autoride Susp. or Premium Smooth Ride Susp.) Lift = 1-3"					565076					
2000	ALL (New Style) (Exc. Z55 Autoride Susp. or Premium Smooth Ride Susp.) Lift = 1-3" ALL (Old Style) Lift = 1-3"					565076 565073	565074				
1995-99	ALL 2 Door Lift = 1-3" ALL 4 Door Lift = 1-3" for Edelbrock # 6360 Lift = 4-6" for Rancho # RS5244 Lift = 4-6" for Rancho # RS9244 Lift = 4-6" for Rancho # RSX17316 Lift = 4-6" for Edelbrock # 63003 Lift = 4-6" for Edelbrock # 6460 Lift = 4-6" for Rancho # RS5227 Lift = 4-6" for Rancho # RS9227 Lift = 4-6" for Rancho # RSX17315 Lift = 4-6"					565073 565073 565086 565092 565092 565086 565087 565087 565087 565087 565087	565074				

CHEVROLET Townsman

1971-72	ALL	343127	343157								
1969-70	ALL	343128	343130								

CHEVROLET Tracker (Also See GEO)

1999-04	ALL Right Hand Left Hand Strut Mount (1.6L) Strut Mount (2.0 & 2.5L)	334195 334196	343247 343247		KG4745A KG4745A			SM5367 SM5366			
1996-98	ALL w/ 4 Wheel ABS Right Hand Left Hand	334195 334196	343247 343247		KG4745A KG4745A			SM5082 SM5082			
1989-98	ALL (Exc. ABS) Right Hand Left Hand	235035 235036	343247 343247		KG4745A KG4745A			SM5082 SM5082			

CHEVROLET Trailblazer (2WD & 4WD)

2008-09	ALL		343395		KG4162					SB108	
2007	ALL	331043 ⁶⁸	343395		KG4162					SB108	
2002-09	Lower Spring Seat Insulator							SM5548 ⁶³			
2002-08	Mount w/ Spring Insulator							SM5395			
2002-06	ALL	331016 ⁸¹	343395		KG4162					SB108	

CHEVROLET Two-Ten Series

1955-57	ALL	343127	343149								
---------	-----	--------	--------	--	--	--	--	--	--	--	--

⁶³ New Part Number; Available 4th Quarter 2010
⁶⁸ New Part Number; Available 3rd Quarter 2010
⁸¹ When [331016] stock is depleted, use [331043]

Applications For Pass. Cars, Light Trucks, SUV's, & Vans

VEHICLE MAKE, MODEL & YEAR	GR-2	Gas-a-Just	MonoMax 56XXXX Series	STRUT & SHOCK	
MARQUE, MODELE ET	Excel-G		AGX 7XXXXX Series	MOUNTS	BOOT KITS
ANNEE DU VEHICULE					
LA MARCA EL MODELO & ANO					

CHEVROLET Uplander

2005-08	FWD (Exc. Self-Leveling Rear Suspension) Upper Spring Seat w/ Insulator Upper Spring Seat Insulator Lower Spring Seat Insulator	335061	344338		KG54325			SM5143		SB127	
								SM5470 SM5467 SM5437			
2005-06	AWD	335061						SM5143		SB127	

CHEVROLET Vega

1975-77	ALL	343129	343132								
1972-74	ALL		343132								
1971	ALL		343131								

CHEVROLET Venture Mini-Van

1997-05	ALL w/ Rear Level Control ALL w/o Rear Level Control Upper Spring Seat w/ Insulator Upper Spring Seat Insulator Lower Spring Seat Insulator	334227 334227	344338		KG54325			SM5143 SM5143 SM5470 SM5467 SM5437		SB127 SB127	
---------	---	------------------	--------	--	---------	--	--	--	--	----------------	--

CHRYSLER 300

2008-10	Strut Boot									SB101	
2005-09	AWD (Exc. Self-Leveling Rear Suspension) AWD with Self-Leveling Rear Suspension RWD (Exc. Self-Leveling Susp.) Right Hand Left Hand ALL w/ SRT8 Option ALL w/o SRT8 Option RWD w/o SRT8 Option	341673 ⁶³ 341673 ⁶³ 341608 341609	349086 349065 349065					SM5534 ⁶³ SM5533 ⁶³ SM5535 ⁶³			
2005-07	AWD RWD w/ 5.7L RWD w/o 5.7L									SB101 SB101 SB103	
1970-71	ALL				KG4507						
1965-69	ALL		343159		KG4507	KG5512					

CHRYSLER 300M (Exc. Performance Handling Package)

1998-04	ALL Right Hand Left Hand	235617 235618	235619 235619					SM5167 SM5167	SM5168 SM5168	SB101 SB101	SB101 SB101
---------	--------------------------------	------------------	------------------	--	--	--	--	------------------	------------------	----------------	----------------

CHRYSLER Aspen (SUV)

2007-09	ALL (Exc. Hybrid)			KG4160	KG4159						
---------	-------------------	--	--	--------	--------	--	--	--	--	--	--

CHRYSLER Cirrus

1995-00	ALL	344609	344610					SM5262	SM5137	SB108	SB107
---------	-----	--------	--------	--	--	--	--	--------	--------	-------	-------











CHRYSLER Concorde

1998-04	ALL Right Hand Left Hand	235617 235618	235619 235619					SM5167 SM5167	SM5168 SM5168	SB101 SB101	SB101 SB101
1993-97	ALL Upper Spring Seat Lower Spring Seat Insulator	Right Hand Left Hand 234601 234602	234603 234603					SM5110 SM5110 SM5231 SM5556 ⁶³	SM5111 SM5111 SM5111 SM5557 ⁶³	SB101 SB101 SB101 SB101	SB101 SB101 SB101 SB101

⁶³ New Part Number; Available 4th Quarter 2010

Notes de bas de Page 259 - Guia de notas al calce del catalogo Pg. 260
 Bold part numbers indicate the most comparable KYB product to the original design & performance.
 (22) For vehicles with Electronic Susp., Leveling Control, and Air Suspensions refer to Appendix C.

Applications For Pass. Cars, Light Trucks, SUV's, & Vans

VEHICLE MAKE, MODEL & YEAR	GR-2	Gas-a-Just	MonoMax 56XXXX Series	STRUT & SHOCK	
MARQUE, MODELE ET	Excel-G		AGX 7XXXX Series	MOUNTS	BOOT KITS
ANNEE DU VEHICULE	 	 	 	 	 
LA MARCA EL MODELO & ANO					

CHRYSLER Conquest

9/86-89	ALL (Exc. Adj. Susp.)	Right Hand Left Hand	365060 365060					SM5313 SM5313	SM5310 SM5310	SB102 SB102	SB101 SB101
1983-8/86	ALL (Exc. Adj. Susp.)	Right Hand Left Hand	365029 365029					SM5313 SM5313	SM5310 SM5310	SB102 SB102	SB102 SB102

CHRYSLER Cordoba

1980-83	ALL		343138	343139	KG4528	KG5546					
1977-79	ALL		343158	343139		KG5546					
1975-76	ALL		343158	343159		KG5512					

CHRYSLER Crossfire

2004-08	ALL		NA	NA							
---------	-----	--	----	----	--	--	--	--	--	--	--

CHRYSLER Daytona (Canadian Vehicle)

1/86-93	ALL Upper Spring Seat Spacer Upper Spring Seat Lower Spring Seat Insulator		235902	343164		KG5563			SM5003 SM5219 SM5130 SM5131		SB104
84-12/85	ALL		234003	343164		KG5563			SM5004		SB104

CHRYSLER Dynasty (Canadian Vehicle) (Footnote # 22)

1988-93	ALL w/ Air Leveling System ALL w/o Air Leveling System Upper Spring Seat Spacer Upper Spring Seat Lower Spring Seat Insulator		235902 235902	343164		KG5563 ²² KG5563			SM5003 SM5003 SM5219 SM5130 SM5131		SB103 SB103
---------	---	--	------------------	--------	--	--------------------------------	--	--	--	--	----------------

CHRYSLER E Class

1984	ALL		234003	343164		KG5563			SM5004		SB104
1983	ALL		234001	343164		KG5563			SM5002		SB101

CHRYSLER Executive Limousine

1/86	ALL Upper Spring Seat Spacer Upper Spring Seat Lower Spring Seat Insulator		235902	343164		KG5563			SM5003 SM5219 SM5130 SM5131		SB104
84-12/85	ALL		234003	343164		KG5563			SM5004		SB104
1983	ALL		234001	343164		KG5563			SM5002		SB101

CHRYSLER Fifth Avenue (New Yorker) (Exc. Air Suspension)

1990-93	ALL w/ Air Level ALL w/o Air Level Upper Spring Seat Spacer Upper Spring Seat Lower Spring Seat Insulator		235902 235902	343164		KG5563 ²² KG5563			SM5003 SM5003 SM5219 SM5130 SM5131		SB103 SB103
1983-89	ALL		343138	343139	KG4528	KG5546					

CHRYSLER Imperial

1990-93	ALL (Exc. Air Susp.) (Footnote #22) Upper Spring Seat Spacer Upper Spring Seat Lower Spring Seat Insulator		235902	343164		KG5563			SM5003 SM5219 SM5130 SM5131		SB103
1981-83	ALL		343138	343139	KG4528	KG5546					











²² For vehicles with Electronic Susp., Leveling Control, and Air Suspensions refer to Appendix C.

Notes de bas de Page 259 - Guia de notas al calce del catalogo Pg. 260

Bold part numbers indicate the most comparable KYB product to the original design & performance.

(22) For vehicles with Electronic Susp., Leveling Control, and Air Suspensions refer to Appendix C.

Applications For Pass. Cars, Light Trucks, SUV's, & Vans

VEHICLE MAKE, MODEL & YEAR	GR-2	Gas-a-Just	MonoMax 56XXXX Series	STRUT & SHOCK	
MARQUE, MODELE ET	Excel-G		AGX 7XXXX Series	MOUNTS	BOOT KITS
ANNEE DU VEHICULE	 	 	 	 	 
LA MARCA EL MODELO & ANO					

CHRYSLER Imperial (continued)

1974-75	ALL	343138	343159	KG4528	KG5512					
1970-73	ALL			KG4507						
1967-69	ALL		343159	KG4507	KG5512					

CHRYSLER Intrepid (Canadian Vehicle)

1999-02	R/T	NA	235619					SM5167	SM5168	SB101	
1998-04	ALL (Exc. R/T)	Right Hand	235617	235619				SM5167	SM5168	SB101	SB107
		Left Hand	235618	235619				SM5167	SM5168	SB101	SB107
1993-97	ALL	Right Hand	234601	234603				SM5110	SM5111	SB101	SB101
		Left Hand	234602	234603				SM5110	SM5111	SB101	SB101
	Upper Spring Seat							SM5231			
	Lower Spring Seat Insulator							SM5556 ⁶³	SM5557 ⁶³		

CHRYSLER LHS

1998-01	ALL	Right Hand	235617	235619				SM5167	SM5168	SB101	SB107
		Left Hand	235618	235619				SM5167	SM5168	SB101	SB107
1994-97	ALL	Right Hand	234601	234603				SM5110	SM5111	SB101	SB101
		Left Hand	234602	234603				SM5110	SM5111	SB101	SB101
	Upper Spring Seat							SM5231			

CHRYSLER Laser

1/86 - 86	ALL	Upper Spring Seat Spacer	235902	343164		KG5563		SM5003		SB104	
		Upper Spring Seat						SM5219			
		Lower Spring Seat Insulator						SM5130			
								SM5131			
84-12/85	ALL		234003	343164		KG5563		SM5004		SB104	

CHRYSLER Le Baron

1/86-95	ALL Inc. GTS, GTC, Convertible & Coupe	Upper Spring Seat Spacer	235902	343164		KG5563		SM5003		SB104	
		Upper Spring Seat						SM5219			
		Lower Spring Seat Insulator						SM5130			
								SM5131			
84-12/85	ALL		234003	343164		KG5563		SM5004		SB104	
1983	ALL		234001	343164		KG5563		SM5002		SB101	
1982	ALL		234001	343164		KG5563		SM5001		SB101	
1977-81	ALL		343138	343139	KG4528	KG5546					

CHRYSLER Neon (Canadian Vehicle)

2000-05	ALL (Exc. Performance Package)	Right Hand	235627	235628				SM5265	SM5198	SB104	SB101
		Left Hand	235627	235629				SM5265	SM5198	SB104	SB101
	Mount & Springseat w/ Insulator							SM5199			
	Upper Spring Seat w/ Insulator							SM5344			
	Lower Spring Seat Insulator							SM5417	SM5464		













CHRYSLER Newport

1979-81	ALL	343158	343139		KG5546						
1974-78	ALL	343138	343159	KG4528	KG5512						
1970-73	ALL			KG4507							
1965-69	ALL		343159	KG4507	KG5512						

⁶³ New Part Number; Available 4th Quarter 2010

Notes de bas de Page 259 - Guia de notas al calce del catalogo Pg. 260
 Bold part numbers indicate the most comparable KYB product to the original design & performance.
 (22) For vehicles with Electronic Susp., Leveling Control, and Air Suspensions refer to Appendix C.

Applications For Pass. Cars, Light Trucks, SUV's, & Vans

VEHICLE MAKE, MODEL & YEAR	  	STRUT & SHOCK		BOOT KITS	
MARQUE, MODELE ET		MOUNTS			
ANNEE DU VEHICULE					
LA MARCA EL MODELO & ANO					
	 	 	 	 	 

CHRYSLER New Yorker (Exc. Air Suspension) (Footnote # 22)

1994-97	ALL Upper Spring Seat Lower Spring Seat Insulator	Right Hand Left Hand	234601 234602	234603 234603					SM5110 SM5110 SM5231 SM5556 ⁶³	SM5111 SM5111 SM5557 ⁶³	SB101 SB101	SB101 SB101
1988-93	ALL (Exc. Turbo) (w/o Air Level) ALL (Exc. Turbo) w/ Air Level		235902 235902	343164		KG5563 KG5563 ²²			SM5003 SM5003		SB103 SB103	
1988	ALL w/ Turbo		235902	343164		KG5563			SM5003		SB104	
1/86-93	Upper Spring Seat Upper Spring Seat Spacer Lower Spring Seat Insulator								SM5130 SM5219 SM5131			
1/86-87	ALL (Exc. Fifth Avenue)		235902	343164		KG5563			SM5003		SB104	
1984-12/85	ALL (Exc. Fifth Avenue)		234003	343164		KG5563			SM5004		SB104	
1983	ALL (Exc. Fifth Avenue)		234001	343164		KG5563			SM5002		SB101	
1982	ALL		343138	343139	KG4528	KG5546						
1979-81	ALL		343158	343139		KG5546						
1974-78	ALL		343138	343159	KG4528	KG5512						
1970-73	ALL				KG4507							
1965-69	ALL			343159	KG4507	KG5512						

CHRYSLER PT Cruiser

2010	ALL (Incl. Turbo)		235626									
2001-09	ALL (Incl. Turbo)		235626	343385		553333			SM5265		SB104	
2001-08	Mount & Springseat w/ Insulator Upper Spring Seat w/ Insulator Lower Spring Seat Insulator								SM5199 SM5344 SM5417			

CHRYSLER Pacifica

2004-08	AWD FWD		339088 339088	SR2007 SR2006					SM5389 SM5389	SM5534 ⁶³ SM5534 ⁶³	SB126 SB126	
---------	------------	--	------------------	------------------	--	--	--	--	------------------	--	----------------	--

CHRYSLER Prowler

2001-02	ALL		NA	NA								
---------	-----	--	----	----	--	--	--	--	--	--	--	--

CHRYSLER Sebring

2007-09	FWD			341479							SB101	SB107
2003-06	Sedan & Convertible Sedan Mount Plate w/ Insulator		341604	344610					SM5264	SM5263 SM5512	SB108	SB107
2001-06	Convertible Mount Plate w/ Insulator								SM5532 ⁶³			
2001-05	Coupe Upper Spring Seat Insulator	Right Hand Left Hand	235630 235631	341293 341293					SM5388 SM5388	SM5091 SM5091 SM5433	SB103 SB103	SB101 SB101
2001-02	Sedan & Convertible Sedan Mount Plate w/ Insulator		344609	344610					SM5264	SM5238 SM5512	SB108	SB108
1997-00	Convertible		344609	344610					SM5262	SM5238	SB108	SB107
1996	Convertible		344609	344610					SM5262	SM5137		
1995-00	Coupe Upper Spring Seat Insulator		341141	341165			741018	741019	SM5091	SM5091 SM5433	SB108	SB108

²² For vehicles with Electronic Susp., Leveling Control, and Air Suspensions refer to Appendix C.

⁶³ New Part Number; Available 4th Quarter 2010

Applications For Pass. Cars, Light Trucks, SUV's, & Vans

VEHICLE MAKE, MODEL & YEAR									
MARQUE, MODELE ET	GR-2	Gas-a-Just	MonoMax 56XXXX Series	STRUT & SHOCK					
ANNEE DU VEHICULE	Excel-G		AGX 7XXXXX Series	MOUNTS		BOOT KITS			
LA MARCA EL MODELO & ANO									

CHRYSLER TC (Maserati)

1989-91	ALL Upper Spring Seat Spacer Upper Spring Seat Lower Spring Seat Insulator	235902	343164		KG5563				SM5003 SM5219 SM5130 SM5131		SB104	
---------	---	--------	--------	--	--------	--	--	--	--------------------------------------	--	-------	--

CHRYSLER Town & Country (Pre-1990)

1/86-88	ALL Upper Spring Seat Spacer Upper Spring Seat Lower Spring Seat Insulator	235902	343164		KG5563				SM5003 SM5219 SM5130 SM5131		SB104	
84-12/85	ALL	234003	343164		KG5563				SM5004		SB104	
1983	ALL	234001	343164						SM5002		SB101	
1982	ALL	343138	343139	KG4528	KG5546							
1979-81	ALL	343158	343139		KG5546							
1974-78	ALL	343138	343159	KG4528	KG5512							
1971-73	ALL			KG4507								
1965-70	ALL		343159	KG4507	KG5512							

CHRYSLER Town & Country Mini Van (also see STRUT-PLUS)

2008-09	ALL (Exc. Rear Self Leveling)		349073									
2001-07	ALL (Exc. AWD Model) (Exc. Nivomat Rear Susp.)	334335	344080		KG5457				SM5266		SB126	
	ALL w/ AWD Upper Spring Seat Insulator Lower Spring Seat Insulator	334335	SR2005						SM5266 SM5432 SM5434		SB126	
2001-06	ALL w/ Nivomat Rear Susp. (Exc. AWD)	334335	SR2002						SM5266		SB126	
1996-00	ALL (Exc. Nivomat Load Leveling Rear Susp.)	334188	344080		KG5457				SM5112		SB126	
	ALL w/ Nivomat Rear Susp. Upper Spring Seat Lower Spring Seat Insulator	334188	SR2001						SM5112 SM5157 SM5410		SB126	
1990-95	ALL (Incl. AWD) Upper Spring Seat Spacer Upper Spring Seat Lower Spring Seat Insulator	235901	344080		KG5457				SM5003 SM5219 SM5130 SM5131		SB126	

CHRYSLER Town & Country Mini Van - STRUT-PLUS











2006-07	ALL (Exc. Limited & Nivomat Load Leveling Rear Susp.) Right Hand Left Hand	SR4038 SR4039										
2001-05	ALL (Exc. Nivomat Load Leveling Rear Susp.) Right Hand Left Hand	SR4038 SR4039										
	ALL w/ Nivomat Rear Susp. (Exc. AWD) Right Hand Left Hand	SR4038 SR4039										
1996-00	ALL (Exc. Nivomat Load Leveling Rear Susp.) Right Hand Left Hand	SR4020 SR4021										

Notes de bas de Page 259 - Guia de notas al calce del catalogo Pg. 260

Bold part numbers indicate the most comparable KYB product to the original design & performance.

(22) For vehicles with Electronic Susp., Leveling Control, and Air Suspensions refer to Appendix C.

Applications For Pass. Cars, Light Trucks, SUV's, & Vans

VEHICLE MAKE, MODEL & YEAR	GR-2	Gas-a-Just	MonoMax 56XXXX Series	STRUT & SHOCK			
MARQUE, MODELE ET	Excel-G		AGX 7XXXX Series	MOUNTS		BOOT KITS	
ANNEE DU VEHICULE	 	 	 	 	 		
LA MARCA EL MODELO & ANO							

CHRYSLER Town & Country Mini Van - STRUT-PLUS (continued)

1996-00	ALL w/ Nivomat Rear Susp. (Exc. AWD)									
	Right Hand	SR4020								
	Left Hand	SR4021								
1990-95	ALL (Incl. AWD)	SR4019								

CHRYSLER Voyager & Grand Voyager Mini Van (also see STRUT-PLUS)

2001-03	ALL Upper Spring Seat Insulator Lower Spring Seat Insulator	334335	344080		KG5457				SM5266 SM5432 SM5434		SB126
2000	ALL Upper Spring Seat Lower Spring Seat Insulator	334188	344080		KG5457				SM5112 SM5157 SM5410		SB126

CHRYSLER Voyager & Grand Voyager Mini Van - STRUT-PLUS

2001-03	ALL V6 Eng.	Right Hand	SR4038								
		Left Hand	SR4039								
2000	ALL V6 Eng.	Right Hand	SR4020								
		Left Hand	SR4021								

DAEWOO Lanos

1999-02	ALL		365025	343177		KG4536					SB101
---------	-----	--	--------	--------	--	--------	--	--	--	--	-------

DAEWOO Nubira

1999-02	Wagon (w/o ABS Brakes)	Right Hand	334207								
		Left Hand	334208								
1999-01	ALL w/ ABS	Right Hand	334209	333254							
		Left Hand	334210	333255							

DAIHATSU Rocky

1990-92	ALL		344098	343219	KG5476	KG5517					
---------	-----	--	--------	--------	--------	--------	--	--	--	--	--

DATSUN See Nissan

			---	---							
--	--	--	-----	-----	--	--	--	--	--	--	--

DODGE 2000 GTX (Canadian Vehicle)

1989-90	ALL (Exc. 4WD)		235032	341114			734005	741013		SM5091	SB101	SB107
	ALL w/ 4WD		235032	341121			734005	741014		SM5091	SB101	SB107

DODGE 330

1963-64	ALL			343159	KG4510	KG5512					
---------	-----	--	--	--------	--------	--------	--	--	--	--	--

DODGE 400

1983	ALL		234001	343164		KG5563			SM5002		SB101
1982	ALL		234001	343164		KG5563			SM5001		SB101

DODGE 440









1963-64	ALL			343159	KG4510	KG5512					
---------	-----	--	--	--------	--------	--------	--	--	--	--	--

DODGE 600

1/86-88	ALL Upper Spring Seat Spacer Upper Spring Seat		235902	343164		KG5563			SM5003 SM5219 SM5130		SB104
---------	--	--	--------	--------	--	--------	--	--	----------------------------	--	-------

Notes de bas de Page 259 - Guia de notas al calce del catalogo Pg. 260
 Bold part numbers indicate the most comparable KYB product to the original design & performance.
 (2) For vehicles with Electronic Susp., Leveling Control, and Air Suspensions refer to Appendix C.

Applications For Pass. Cars, Light Trucks, SUV's, & Vans

VEHICLE MAKE, MODEL & YEAR	GR-2	Gas-a-Just	MonoMax 56XXXX Series	STRUT & SHOCK	
MARQUE, MODELE ET	Excel-G		AGX 7XXXX Series	MOUNTS	BOOT KITS
ANNEE DU VEHICULE	 	 	 	 	 
LA MARCA EL MODELO & ANO					

DODGE 600 (continued)

1/86-88	Lower Spring Seat Insulator							SM5131			
84-12/85	ALL	234003	343164		KG5563			SM5004		SB104	
1983	ALL	234001	343164		KG5563			SM5002		SB101	

DODGE Aries

1/86-89	ALL Upper Spring Seat Spacer Upper Spring Seat Lower Spring Seat Insulator	235902	343164		KG5563			SM5003 SM5219 SM5130 SM5131		SB104	
84-12/85	ALL	234003	343164		KG5563			SM5004		SB104	
1983	ALL	234001	343164		KG5563			SM5002		SB101	
1981-82	ALL	234001	343164		KG5563			SM5001		SB101	

DODGE Aspen (Car)

1976-80	ALL	343138	343139	KG4528	KG5546						
---------	-----	--------	--------	--------	--------	--	--	--	--	--	--

DODGE Avenger

2008	FWD		341479							SB101	SB107
1995-00	ALL Upper Spring Seat Insulator	341141	341165			741018	741019	SM5091	SM5091 SM5433	SB101	SB101

DODGE Caliber

2010	ALL (Exc. SRT-4)	Right Hand	334642	341654						SB101	SB107
		Left Hand	334643	341654						SB101	SB107
2007-09	ALL (Exc. SRT-4)	Right Hand	334642	341654						SB101	SB107
		Left Hand	334643	341654						SB101	SB107











DODGE Caravan, Grand Caravan Mini-Van (also see STRUT-PLUS)

2009	ALL (Exc. Rear Self Leveling)		349073								
2008	ALL (Exc. Rear Self Leveling)	334673 ⁶³	349073								
2001-07	ALL (Exc. AWD Model) (Exc. Nivomat Rear Susp.)	334335	344080		KG5457			SM5266		SB126	
	ALL w/ AWD Upper Spring Seat Insulator Lower Spring Seat Insulator	334335	SR2005					SM5266 SM5432 SM5434		SB126	
2001-06	ALL w/ Nivomat Rear Susp. (Exc. AWD) Upper Spring Seat Insulator Lower Spring Seat Insulator	334335	SR2002					SM5266 SM5432 SM5434		SB126	
1996-00	ALL (Exc. AWD Models w/ Self Leveling)	334188	344080		KG5457			SM5112		SB103	
	ALL w/ Nivomat Rear Susp. Upper Spring Seat Lower Spring Seat Insulator	334188	SR2001					SM5112 SM5157 SM5410		SB103	
1986-95	ALL (Incl. AWD) Upper Spring Seat Spacer Upper Spring Seat Lower Spring Seat Insulator	235901	344080		KG5457			SM5003 SM5219 SM5130 SM5131		SB126	
1984-85	ALL	234004	344080		KG5457			SM5004		SB103	

⁶³ New Part Number; Available 4th Quarter 2010

Notes de bas de Page 259 - Guia de notas al calce del catalogo Pg. 260
 Bold part numbers indicate the most comparable KYB product to the original design & performance.
 (22) For vehicles with Electronic Susp., Leveling Control, and Air Suspensions refer to Appendix C.

Applications For Pass. Cars, Light Trucks, SUV's, & Vans

VEHICLE MAKE, MODEL & YEAR	GR-2	Gas-a-Just	MonoMax 56XXXX Series	STRUT & SHOCK	
MARQUE, MODELE ET	Excel-G		AGX 7XXXX Series	MOUNTS	BOOT KITS
ANNEE DU VEHICULE	 	 	 	 	 
LA MARCA EL MODELO & ANO					

DODGE Caravan, Grand Caravan Mini Van - STRUT-PLUS

2001-07	ALL V6 Eng. (Exc. Nivomat Load Leveling Rear Susp.) Right Hand Left Hand	SR4038 SR4039								
	ALL V6 Eng. w/ Nivomat Rear Susp. (Exc. AWD) Right Hand Left Hand	SR4038 SR4039								
1996-00	ALL V6 Eng. (Exc. Nivomat Load Leveling Rear Susp.) Right Hand Left Hand	SR4020 SR4021								
	ALL V6 Eng. w/ Nivomat Rear Susp. (Exc. AWD) Right Hand Left Hand	SR4020 SR4021								
1986-95	ALL V6 Eng. (Incl. AWD)	SR4019								

DODGE Challenger

2008-09	ALL w/ SRT8 Option ALL w/o SRT8 Option							SM5535 ⁶³	SM5534 ⁶³ SM5533 ⁶³		
1981-83	ALL	365029						SM5312			
1970-74	ALL			KG4510	KG5512						

DODGE Charger

2008-10	Strut Boot									SB101	
2006-09	AWD (Exc. Self-Leveling Rear Suspension) AWD with Self-Leveling Rear Suspension RWD (Exc. Self-Leveling Susp.) Right Hand Left Hand	341673 ⁶³ 341673 ⁶³ 341608 341609	349086						SM5534 ⁶³ SM5533 ⁶³		
	ALL w/ SRT8 Option ALL w/o SRT8 Option RWD w/o SRT8 Option							SM5535 ⁶³			
2006-07	AWD RWD w/ 5.7L RWD w/o 5.7L									SB101 SB101 SB103	
1983-87	ALL	234001						SM5001	SM5018	SB101	
1977-78	ALL	343158	343139		KG5546						
1973-76	ALL	343158	343159		KG5512						
1966-72	ALL		343159	KG4510	KG5512						

DODGE Colt (Canadian Vehicle)

1989-92	Colt 100E Sedan & Hatchback Colt 200E	233025 235033	342014 341084		KG3200A			SM5063	SM5091	SB101 SB104	SB107
---------	--	------------------	------------------	--	---------	--	--	--------	--------	----------------	-------











DODGE Colt (Exc. Colt Vista)

1993-96	ALL (Exc. CA2A Model) Right Hand Left Hand	234061 234062	341140 341140					SM5109 SM5109	SM5091 SM5091	SB101 SB101	SB107 SB107
1989-92	Hatchback	235033	341084					SM5063	SM5091	SB101	SB107
1987-90	Station Wagon w/ Power Steering Mount Insulator & Bearing Station Wagon w/o Power Steering Mount Insulator & Bearing	233025 233025						SM5061 SM5317 SM5062 SM5318		SB104 SB104	
1987-88	ALL w/ Power Steering (Exc. Station Wagon) Mount Insulator & Bearing	233025	342014		KG3200A			SM5061 SM5317		SB104	

⁶³ New Part Number; Available 4th Quarter 2010

Notes de bas de Page 259 - Guia de notas al calce del catalogo Pg. 260
 Bold part numbers indicate the most comparable KYB product to the original design & performance.
 (22) For vehicles with Electronic Susp., Leveling Control, and Air Suspensions refer to Appendix C.

Applications For Pass. Cars, Light Trucks, SUV's, & Vans

VEHICLE MAKE, MODEL & YEAR	GR-2	Gas-a-Just	MonoMax 56XXXX Series	STRUT & SHOCK	
MARQUE, MODELE ET	Excel-G		AGX 7XXXXX Series	MOUNTS	BOOT KITS
ANNEE DU VEHICULE	 	 	 	 	 
LA MARCA EL MODELO & ANO					

DODGE Colt (Exc. Colt Vista) (continued)

1987-88	ALL w/o Power Steering (Exc. Station Wagon) Mount Insulator & Bearing	233025	342014		KG3200A			SM5062		SB104	
								SM5318			
1985-86	ALL	233013	342014		KG3200A			SM5316		SB104	
1984	ALL (Exc. Sealed Struts)	365027			KG4192			SM5032		SB103	
1982-83	ALL	365027						SM5032		SB103	
1979-81	Hatchback	365027			KG4192			SM5032		SB103	
1977-80	Station Wagon		343030		KG4006			SM5315		SB103	

DODGE Colt Vista

1986-91	4WD Station Wagon	235050			KG4192			SM5095		SB103	
1984-91	FWD Station Wagon	235006			KG4192			SM5095		SB103	

DODGE Conquest

9/86-89	ALL (Exc. Adj. Susp.)	Right Hand	365060					SM5313	SM5310	SB102	SB101
		Left Hand	365060					SM5313	SM5310	SB102	SB101
1983-8/86	ALL (Exc. Adj. Susp.)	Right Hand	365029					SM5313	SM5310	SB102	SB102
		Left Hand	365029					SM5313	SM5310	SB102	SB102

DODGE Coronet

1973-76	ALL	343158	343159		KG5512						
1965-72	ALL		343159	KG4510	KG5512						

DODGE D50 Pickup

1982-93	2WD	344047	344044	KG5433	KG5445						
	4WD	344047	344045	KG5433	KG5438						
1979-81	ALL	344047	344044	KG5433	KG5434						

DODGE D100, D150 (1/2 Ton) (2WD) Pickup

1979-93	ALL	344066	344086	KG5403	KG5423						
1972-78	ALL	344066	344070	KG5403	KG5413						

DODGE D200, D250 (3/4 Ton) (2WD) Pickup

1988-93	D200, D250 Diesel		344086	KG5404	KG5423						
1979-93	Gas (Exc. 165" WB & HD Package)	344066	344086	KG5403	KG5423						
	Gas w/ 165" WB & HD Package		344086	KG5404	KG5423						
1972-78	ALL (Exc. 165" WB & HD Package)	344066	344070	KG5403	KG5413						
	ALL w/ 165" WB & HD Package		344070	KG5404	KG5413						

DODGE D300, D400 (1 Ton) (2WD) Pickup

1979-93	ALL		344086	KG5404	KG5423						
1972-78	ALL		344070	KG5404	KG5413						





DODGE Dakota, Shelby Dakota

2008-09	ALL Upper Spring Seat		344378		KG54321		565040	SM5510 SM5546 ⁶³		SB103	
2005-07	ALL Upper Spring Seat	341484	344378		KG54321		565040	SM5510 SM5546 ⁶³		SB103	
1997-04	2WD	344081	344378	KG5458	KG54321	565049	565040				
	4WD	344049	344379	KG5440	KG54322	565043	565041				

⁶³ New Part Number; Available 4th Quarter 2010

Notes de bas de Page 259 - Guia de notas al calce del catalogo Pg. 260
 Bold part numbers indicate the most comparable KYB product to the original design & performance.
 (22) For vehicles with Electronic Susp., Leveling Control, and Air Suspensions refer to Appendix C.

Applications For Pass. Cars, Light Trucks, SUV's, & Vans

VEHICLE MAKE, MODEL & YEAR		GR-2		Gas-a-Just		MonoMax 56XXXX Series		STRUT & SHOCK			
MARQUE, MODELE ET		Excel-G				AGX 7XXXXX Series		MOUNTS		BOOT KITS	
ANNEE DU VEHICULE											
LA MARCA EL MODELO & ANO											

DODGE Dakota, Shelby Dakota (continued)

1986-96	2WD 4WD	344094 344093	344096 344095	KG5470 KG5469	KG5472 KG5471						
---------	------------	------------------	------------------	------------------	------------------	--	--	--	--	--	--

DODGE Dakota, Shelby Dakota - Lift Replacement Shocks

1997-04	4WD Lift = 2-3"					565078	565079				
---------	-----------------	--	--	--	--	--------	--------	--	--	--	--

DODGE Dart

1963-76	ALL			KG4509	KG5511						
1962	ALL			KG4509							

DODGE Daytona, Shelby Daytona

1/86-93	ALL Upper Spring Seat Spacer Upper Spring Seat Lower Spring Seat Insulator	235902	343164		KG5563			SM5003 SM5219 SM5130 SM5131		SB104	
84-12/85	ALL	234003	343164		KG5563			SM5004		SB104	

DODGE Diplomat

1977-89	ALL (Incl. Police Pkg.)	343138	343139	KG4528	KG5546						
---------	-------------------------	--------	--------	--------	--------	--	--	--	--	--	--

DODGE Durango

2004-09	ALL (Exc. Hybrid)			KG4160	KG4159						
1998-03	2WD 4WD	344081 344049	344378 344379	KG5458 KG5440	KG54321 KG54322	565049 565043	565040 565041				

DODGE Durango - Lift Replacement Shocks

1998-03	4WD Lift = 2-3"					565078	565079				
---------	-----------------	--	--	--	--	--------	--------	--	--	--	--

DODGE Dynasty

1988-93	ALL w/ Air Leveling System ALL w/o Air Leveling System Upper Spring Seat Spacer Upper Spring Seat Lower Spring Seat Insulator	235902 235902	343164		KG5563			SM5003 SM5003 SM5219 SM5130 SM5131		SB103 SB103	
---------	---	------------------	--------	--	--------	--	--	--	--	----------------	--

DODGE Expo (Canadian Vehicle)

1987-89	ALL	234001	341037 ²					SM5001	SM5018	SB101	
---------	-----	--------	---------------------	--	--	--	--	--------	--------	-------	--

DODGE Intrepid (Exc. Performance Handling Package)

1998-04	ALL	Right Hand Left Hand	235617 235618	235619 235619				SM5167 SM5167	SM5168 SM5168	SB101 SB101	SB107 SB107
1993-97	ALL	Right Hand Left Hand	234601 234602	234603 234603				SM5110 SM5110 SM5231 SM5556 ⁶³	SM5111 SM5111 SM5111 SM5557 ⁶³	SB101 SB101 SB101	SB101 SB101 SB101
		Upper Spring Seat Lower Spring Seat Insulator									













DODGE Lancer, Shelby Lancer

1/86-89	ALL Upper Spring Seat Spacer Upper Spring Seat Lower Spring Seat Insulator	235902	343164		KG5563			SM5003 SM5219 SM5130 SM5131		SB104	
84-12/85	ALL	234003	343164		KG5563			SM5004		SB104	

² The KYB replacement unit comes with a new dustcover/ bumper assembly.

⁶³ New Part Number; Available 4th Quarter 2010

Applications For Pass. Cars, Light Trucks, SUV's, & Vans

VEHICLE MAKE, MODEL & YEAR	  	STRUT & SHOCK		BOOT KITS	
MARQUE, MODELE ET		MOUNTS			
ANNEE DU VEHICULE					
LA MARCA EL MODELO & ANO					
	 	 	 	 	 

DODGE Magnum

2008	Strut Boot									SB101	
2005-08	AWD (Exc. Self-Leveling Rear Suspension)	341673 ⁶³	349086							SB101	
	AWD with Self-Leveling Rear Suspension	341673 ⁶³									
	RWD (Exc. Self-Leveling Susp.)										
	Right Hand	341608	349065								
	Left Hand	341609	349065								
	ALL w/ SRT8 Option										
	ALL w/o SRT8 Option										
	RWD w/o SRT8 Option							SM5535 ⁶³	SM5534 ⁶³ SM5533 ⁶³		
2005-07	RWD w/ 5.7L									SB101	
	RWD w/o 5.7L									SB103	
1978-79	ALL	343158	343139		KG5546						

DODGE Mirada

1979-83	ALL	343138	343139	KG4528	KG5546						
---------	-----	--------	--------	--------	--------	--	--	--	--	--	--

DODGE Monaco

1990-92	ALL		343220					SM5330		SB101	
1977-78	ALL (Exc. Police Package)	343158	343139		KG5546						
	ALL w/ Police Package	343158	343159		KG5512						
1974-76	ALL	343138	343159	KG4528	KG5512						
1973	Station Wagon			KG4507							
	Sedan, Hardtop & Convertible		343159	KG4507	KG5512						
1972	ALL		343159	KG4507	KG5512						
1971	ALL			KG4507							
1965-70	ALL		343159	KG4507	KG5512						

DODGE Neon

2004-05	R/T & SRT	Right Hand Left Hand	NA NA	NA NA				SM5265 SM5265	SM5198 SM5198	SB104 SB104	SB101 SB101
2000-05	ALL (Exc. R/T & SRT)	Right Hand Left Hand	235627 235627	235628 235629				SM5265 SM5265 SM5199 SM5344 SM5417	SM5198 SM5198	SB104 SB104	SB101 SB101
	Mount & Springseat w/ Insulator										
	Upper Spring Seat w/ Insulator										
	Lower Spring Seat Insulator								SM5464		
1995-99	ALL (Exc. Competition Model)		234902	234901				SM5136 SM5158	SM5135	SB101	SB104
	Upper Spring Seat										
	Lower Spring Seat Insulator								SM5464		

DODGE Nitro

2007-08	ALL	331017	344404		KG5039						
---------	-----	--------	--------	--	--------	--	--	--	--	--	--











DODGE Omni

1990	ALL		341037 ²					SM5001	SM5018	SB103	
1985-87	GLH, Shelby GLHS (4DR)	234001						SM5001	SM5018	SB101	
1981-89	ALL 4 Door (Exc. GLH)	234001	341037 ²					SM5001	SM5018	SB101	
1981-87	ALL 2 Door	234001	341036 ²					SM5001	SM5018	SB101	
1978-80	ALL 2 Door	234001						SM5001	SM5018	SB101	
	ALL 4 Door	234001	341035 ²					SM5001	SM5018	SB101	

² The KYB replacement unit comes with a new dustcover/ bumper assembly.

⁶³ New Part Number; Available 4th Quarter 2010

Applications For Pass. Cars, Light Trucks, SUV's, & Vans

VEHICLE MAKE, MODEL & YEAR	GR-2	Gas-a-Just	MonoMax 56XXXX Series	STRUT & SHOCK	
MARQUE, MODELE ET	Excel-G		AGX 7XXXXX Series	MOUNTS	BOOT KITS
ANNEE DU VEHICULE	 	 	 	 	 
LA MARCA EL MODELO & AÑO					

DODGE Polara

1973	Station Wagon Sedan, Hardtop & Convertible		343159	KG4507 KG4507	KG5512					
1972	ALL		343159	KG4507	KG5512					
1971	ALL			KG4507						
1965-70	ALL		343159	KG4507	KG5512					
1962-64	ALL		343159	KG4510	KG5512					

DODGE RD200

1978-80	ALL	344074	344086	KG5422	KG5423					
---------	-----	--------	--------	--------	--------	--	--	--	--	--

DODGE Raider

1989	w/ V6 Engine			KG5603A	KG5491					
1987-89	ALL (Exc. V6 Engine)		344045	KG5603A	KG4034					

DODGE Raider (4WD) - Steering Stabilizer

1987-88	Complete Kit	SS15345								
---------	--------------	---------	--	--	--	--	--	--	--	--

DODGE Ram 1500 Pickup (2WD)

2006-08	Mega Cab	344400	344401	KG5786	KG5196					
2002-08	ALL (Exc. Mega Cab & SRT-10)	344398	344385	KG5785	KG54342		565104			
1994-01	ALL	344372	344365	KG54102	KG54104	565015	565016			

DODGE Ram 1500 Pickup (4WD)

2006-08	ALL (Exc. Mega Cab) Commercial or Performance Use (Exc. Mega Cab); Upper Spring Seat	341485 341489	344385		KG54342 KG54342		565104 565104	SM5531 ⁶³ SM5531 ⁶³ SM5546 ⁶³		
2002-05	ALL	344399	344385	KG5784	KG54342		565104			
1994-01	ALL	344376	344365	KG54315	KG54104	565017	565016			

DODGE Ram 1500 Pickup (4WD) - Steering Stabilizer

1994-02	RAM 1500 Pickup (Cylinder Only)	SS10323								
---------	---------------------------------	---------	--	--	--	--	--	--	--	--

DODGE Ram 1500, 2500, 3500 Pickup (4WD) - Lift Replacement Shocks

1994-02	2500 Series (Exc. 8800 GVW) Lift = 0-1" 2500 Series w/ 8800 GVW Lift = 0-1" 3500 Series (Exc. Chassis Cab) Lift = 0-1"					565017	565016			
						565018	565019			
						565018	565019			
1994-01	1500 Series Lift = 0-1"					565017	565016			

DODGE Ram 2500 Pickup (2WD)

2003-09	ALL	344400	344401	KG5786	KG5196		565105			
1994-02	ALL	344372	344365	KG54102	KG54104	565015	565016			











DODGE Ram 2500 Pickup (4WD)

2003-09	ALL (Exc. Power Wagon Model)	344364	344401	KG54103	KG5196	565018	565105			
1994-02	ALL (Exc. 8800 GVW) ALL w/ 8800 GVW	344376 344364	344365 344373	KG54315 KG54103	KG54104 KG54306	565017 565018	565016 565019			

⁶³ New Part Number; Available 4th Quarter 2010

Notes de bas de Page 259 - Guia de notas al calce del catalogo Pg. 260
 Bold part numbers indicate the most comparable KYB product to the original design & performance.
 (22) For vehicles with Electronic Susp., Leveling Control, and Air Suspensions refer to Appendix C.

Applications For Pass. Cars, Light Trucks, SUV's, & Vans

VEHICLE MAKE, MODEL & YEAR	  	STRUT & SHOCK		BOOT KITS	
MARQUE, MODELE ET		MOUNTS			
ANNEE DU VEHICULE					
LA MARCA EL MODELO & ANO					
	 	 	 	 	 

DODGE Ram 2500 Pickup (4WD) - Steering Stabilizer

1994-09	RAM 2500 Pickup (Cylinder Only)	SS10323								
---------	---------------------------------	---------	--	--	--	--	--	--	--	--

DODGE Ram 3500 Pickup (2WD)

2003-09	ALL (Exc. Chassis Cab)	345061	345062	554359	554360					
1994-02	ALL (Exc. Chassis Cab)	344372	344365	KG54102	KG54104	565015	565016			
	ALL Chassis Cab w/ Ind. Front Susp.	344372	344373	KG54102	KG54306	565015	565019			
	ALL Chassis Cab w/ Solid Front Axle.	344364	344373	KG54103	KG54306	565018	565019			

DODGE Ram 3500 Pickup (2WD) - Steering Stabilizer

1997-01	3500 w/ OEM #52029280 Replacement Cylinder Only	SS10333								
1994-97	3500 w/ OEM #52038276 Replacement Cylinder Only	SS10323								

DODGE Ram 3500 Pickup (4WD)

2007-09	ALL (Exc. Chassis Cab)	344364	344401	KG54103	KG5196	565018	565105			
2007-08	Chassis Cab Series	344364		KG54103		565018				
2003-06	ALL	344364	344401	KG54103	KG5196	565018	565105			
1994-02	ALL	344364	344373	KG54103	KG54306	565018	565019			

DODGE Ram 3500 Pickup (4WD) - Steering Stabilizer

1997-09	RAM 3500 Pickup (Cylinder Only)	SS10323								
---------	---------------------------------	---------	--	--	--	--	--	--	--	--

DODGE RamVan Mini-Van (also see STRUT-PLUS)

1986-88	ALL Upper Spring Seat Spacer Upper Spring Seat Lower Spring Seat Insulator	235901	344080		KG5457			SM5003 SM5219 SM5130 SM5131		
1984-85	ALL	234004	344080		KG5457			SM5004		SB103

DODGE RamVan Mini Van - STRUT-PLUS

1987-88	ALL V6 Eng.	SR4019								
---------	-------------	--------	--	--	--	--	--	--	--	--

DODGE Ramcharger

1976-93	4WD	344074	344086	KG5422	KG5423					
1975-93	2WD	344066	344070	KG5403	KG5413					
1974-75	4WD	344074	344070	KG5422	KG5413					

DODGE Rampage

1982-85	ALL	234001						SM5001		SB101
---------	-----	--------	--	--	--	--	--	--------	--	-------

DODGE Royal Monaco

1975-77	ALL	343138	343159	KG4528	KG5512					
---------	-----	--------	--------	--------	--------	--	--	--	--	--

DODGE Shadow

1987-94	ALL Upper Spring Seat Spacer Upper Spring Seat Lower Spring Seat Insulator	235902	343164		KG5563			SM5003 SM5219 SM5130 SM5131		SB104
---------	---	--------	--------	--	--------	--	--	--------------------------------------	--	-------

Notes de bas de Page 259 - Guia de notas al calce del catalogo Pg. 260
 Bold part numbers indicate the most comparable KYB product to the original design & performance.
 (22) For vehicles with Electronic Susp., Leveling Control, and Air Suspensions refer to Appendix C.

Applications For Pass. Cars, Light Trucks, SUV's, & Vans

VEHICLE MAKE, MODEL & YEAR	GR-2		Gas-a-Just		MonoMax 56XXXX Series		STRUT & SHOCK			
MARQUE, MODELE ET	Excel-G				AGX 7XXXXX Series		MOUNTS		BOOT KITS	
ANNEE DU VEHICULE										
LA MARCA EL MODELO & ANO										

DODGE Spirit

1989-95	ALL Upper Spring Seat Spacer Upper Spring Seat Lower Spring Seat Insulator	235902	343164		KG5563			SM5003 SM5219 SM5130 SM5131		SB103	
---------	---	--------	--------	--	--------	--	--	--------------------------------------	--	-------	--

DODGE Sprinter 2500

2003-06	ALL (Exc. 118" WB, High Roof Option, Chassis Cab)	335810	349001								
	ALL w/ 118" WB & High Roof Option	335809	341339								
	ALL w/ 118" WB (Exc. High Roof Option)	335810	341339								
	ALL w/High Roof Option or Chassis Cab (Exc. 118" WB)	335809	349001								
	Mount Bushing							SM5445			

DODGE Sprinter 3500

2003-06	ALL (Exc. High Roof Option, Dual Rear Wheels, Chassis Cab)	335810	349001								
	ALL w/Dual Rear Wheels & High Roof Option or Chassis Cab	335809	344409								
	ALL w/Dual Rear Wheels (Exc. High Roof Option, Chassis Cab)	335810	344409								
	ALL w/High Roof Option or Chassis Cab (Exc. Dual Rear Wheels)	335809	349001								
	Mount Bushing							SM5445			

DODGE St.Regis

1979-81	ALL	343158	343139		KG5546						
---------	-----	--------	--------	--	--------	--	--	--	--	--	--

DODGE Stealth

1995-96	AWD (Exc. Adjustable Susp.)	335013						SM5096		SB101	
	FWD (Exc. Adjustable Susp.)	335013	341183					SM5096	SM5091	SB101	SB108
	FWD (For Adapting ECS to Non-ECS Suspension)	335013 ^c	341184 ^c					SM5096		SB101	SB108
1991-94	ALL (Exc. Adjustable Susp.)	335013	341183					SM5096	SM5091	SB101	SB108
	AWD (For Adapting ECS to Non-ECS Suspension)	335013 ^c	341185 ^c					SM5096		SB101	SB108
	FWD (For Adapting ECS to Non-ECS Suspension)	335013 ^c	341184 ^c					SM5096		SB101	SB108













DODGE Stratus

2004-06	Sedan Mount Plate w/ Insulator	341604	344610					SM5264	SM5263 SM5512	SB108	SB107
2003	Sedan Mount Plate w/ Insulator	341604	344610					SM5264	SM5263 SM5512	SB108	SB108
2001-05	Coupe Upper Spring Seat Insulator	235630 235631	341293 341293					SM5388 SM5388	SM5091 SM5091 SM5433	SB103 SB103	SB103 SB103
2001-02	Sedan Mount Plate w/ Insulator	344609	344610					SM5264	SM5263 SM5512	SB108	SB108
1999-00	ALL	344609	344610					SM5263	SM5137	SB108	SB108
1995-98	ALL	344609	344610					SM5262	SM5137	SB108	SB108

^c To convert from Electronic Susp - See Appendix C

Notes de bas de Page 259 - Guia de notas al calce del catalogo Pg. 260
 Bold part numbers indicate the most comparable KYB product to the original design & performance.
 (22) For vehicles with Electronic Susp., Leveling Control, and Air Suspensions refer to Appendix C.

Applications For Pass. Cars, Light Trucks, SUV's, & Vans

VEHICLE MAKE, MODEL & YEAR	  	STRUT & SHOCK		BOOT KITS	
MARQUE, MODELE ET		MOUNTS			
ANNEE DU VEHICULE					
LA MARCA EL MODELO & ANO					
	 	 	 	 	 

DODGE Van (1/2 Ton) B & Ram Series

1999-03	1500	344066	344073	KG5403	KG5418						
1995-98	B1500	344066	344073	KG5403	KG5418						
1971-94	B100, B150	344066	344073	KG5403	KG5418						

DODGE Van (3/4 Ton) B & Ram Series

1999-03	2500 (Exc. HD) 2500 HD Models	344066	344073	KG5403 KG5403	KG5418 KG5418						
1995-98	B2500 (Exc. HD) B2500 HD Models	344066	344073	KG5403 KG5403	KG5418 KG5418						
1971-94	B200, B250 (Exc. HD) B200, B250 HD Models	344066	344073	KG5403 KG5403	KG5418 KG5418						

DODGE Van (1 Ton) B & Ram Series (Exc. Motorhome Chassis)

1999-03	3500 (Exc. w/ 9000 GVW) 3500 w/ 9000 GVW	344066	344073	KG5403 KG5403	KG5418 KG5418						
1995-98	B3500 (Exc. w/ 9000 GVW) B3500 w/ 9000 GVW	344066	344073	KG5403 KG5403	KG5418 KG5418						
1971-94	B300, B350 (Exc. w/ 4000lb. Front Axle) B300, B350 w/ 4000lb. Front Axle		344073	KG5403	KG5418						
			344073	KG5404	KG5418						

DODGE Van (2WD) - Steering Stabilizer

1954-70	w/ Straight I-Beam axle Complete Kit	SS15345									
---------	---	---------	--	--	--	--	--	--	--	--	--

DODGE Viper

1992-08	ALL	NA	NA								
---------	-----	----	----	--	--	--	--	--	--	--	--

DODGE Vista (Canadian Vehicle)

1989-92	2WD Station Wagon 4WD Station Wagon ALL w/ Power Steering (Exc. Station Wagon) ALL w/o Power Steering (Exc. Station Wagon)	235006 235050 233025 233025	342014 342014		KG4192 KG4192 KG3200A KG3200A			SM5061 SM5062		SB103 SB103 SB104 SB104	
---------	---	--------------------------------------	------------------	--	--	--	--	------------------	--	----------------------------------	--

DODGE W100, W150 (1/2 Ton) (4WD) Pickup

1972-93	ALL	344074	344086	KG5422	KG5423						
1963-71	ALL	344074		KG5422							

DODGE W200, W250 (3/4 Ton) (4WD) Pickup

1972-93	ALL	344074	344086	KG5422	KG5423						
1963-71	ALL	344074		KG5422							

DODGE W300, W350 (1Ton) (4WD) Pickup











1972-93	ALL	344074	344086	KG5422	KG5423						
1963-71	ALL	344074		KG5422							

EAGLE 2000 GTX (Canadian Vehicle)

1991-93	ALL (Exc. 4WD) (Exc. Auto Leveling) ALL w/ 4WD	235032 235032	341114 341121			734005 734005	741013 741014		SM5091 SM5091	SB101 SB101	SB107 SB107
---------	---	------------------	------------------	--	--	------------------	------------------	--	------------------	----------------	----------------

Notes de bas de Page 259 - Guia de notas al calce del catalogo Pg. 260
 Bold part numbers indicate the most comparable KYB product to the original design & performance.
 (22) For vehicles with Electronic Susp., Leveling Control, and Air Suspensions refer to Appendix C.

Applications For Pass. Cars, Light Trucks, SUV's, & Vans

VEHICLE MAKE, MODEL & YEAR	GR-2	Gas-a-Just	MonoMax 56XXXX Series	STRUT & SHOCK	
MARQUE, MODELE ET	Excel-G		AGX 7XXXX Series	MOUNTS	BOOT KITS
ANNEE DU VEHICULE	 	 	 	 	 
LA MARCA EL MODELO & ANO					

EAGLE Medallion

1988-89	ALL		343220					SM5330		SB101	
---------	-----	--	--------	--	--	--	--	--------	--	-------	--

EAGLE Premier

1988-92	ALL		343220					SM5330		SB101	
---------	-----	--	--------	--	--	--	--	--------	--	-------	--

EAGLE Summit

1993-96	Sedan	Right Hand	234061	341140				SM5109	SM5091	SB101	SB107
		Left Hand	234062	341140				SM5109	SM5091	SB101	SB107
1992-96	Station Wagon 2WD		235032	343262				SM5195	SM5091	SB101	SB108
1989-92	Sedan & Hatchback (FWD)		235033	341084				SM5063	SM5091	SB101	SB107

EAGLE Talon

1995-98	AWD		341163	341164			741042	741020	SM5091	SM5091	SB108	SB108
	FWD		341163	341165			741042	741019	SM5091	SM5091	SB108	SB108
1990-94	AWD		235032	341121			734005	741014	SM5072	SM5091	SB101	SB108
	FWD		235032	341114			734005	741013	SM5072	SM5091	SB101	SB108

EAGLE Vision

1993-97	ALL	Right Hand	234601	234603					SM5110	SM5111	SB101	SB101
		Left Hand	234602	234603					SM5110	SM5111	SB101	SB101
	Upper Spring Seat								SM5231			
	Lower Spring Seat Insulator								SM5556 ⁶³	SM5557 ⁶³		

EAGLE Vista (Canadian Vehicle)

1989-92	2WD Station Wagon		235006			KG4192			SM5095		SB103	
	4WD Station Wagon		235050			KG4192			SM5095		SB103	
	ALL w/ Power Steering (Exc. Station Wagon)		233025	342014		KG3200A			SM5061		SB104	
	ALL w/o Power Steering (Exc. Station Wagon)		233025	342014		KG3200A			SM5062		SB104	

EDSEL Citation & Corsair

1958	ALL		343127	343219	KG4515	KG5517						
------	-----	--	--------	--------	--------	--------	--	--	--	--	--	--

EDSEL Corsair & Ranger

1959	ALL		343127		KG4515							
------	-----	--	--------	--	--------	--	--	--	--	--	--	--

EDSEL Pacer & Ranger

1958	ALL		343127	343219	KG4515	KG5517						
------	-----	--	--------	--------	--------	--------	--	--	--	--	--	--

EDSEL Ranger & Villager

1960	ALL		343127	343136	KG4515							
------	-----	--	--------	--------	--------	--	--	--	--	--	--	--

EDSEL Villager

1959	ALL		343127	343136	KG4515							
------	-----	--	--------	--------	--------	--	--	--	--	--	--	--

FIAT 124

1968-78	ALL From Chassis 066.059 (Exc.S/W)		343141	343142								
1966-76	Station Wagon		343141	344055		KG5538						
1966-68	ALL Thru Chassis 066.058 (Exc.S/W)		343141									

⁶³ New Part Number; Available 4th Quarter 2010

Notes de bas de Page 259 - Guia de notas al calce del catalogo Pg. 260
 Bold part numbers indicate the most comparable KYB product to the original design & performance.
 (22) For vehicles with Electronic Susp., Leveling Control, and Air Suspensions refer to Appendix C.

Applications For Pass. Cars, Light Trucks, SUV's, & Vans

VEHICLE MAKE, MODEL & YEAR	GR-2	Gas-a-Just	MonoMax 56XXXX Series	STRUT & SHOCK	
MARQUE, MODELE ET	Excel-G		AGX	MOUNTS	BOOT KITS
ANNEE DU VEHICULE			7XXXXX Series		
LA MARCA EL MODELO & ANO					

FIAT 131

1979-82	Brava Sedan		343142							
1975-78	Sedan (Exc. Sealed Struts)		343142							

FIAT 2000 (Also See Pininfarina)

1979-82	Spider Coupe	343141	343142							
---------	--------------	--------	--------	--	--	--	--	--	--	--

FIAT X1/9 (Also See Bertone)

1979-83	ALL	233003	233004							
1974-78	ALL	233003								

FORD Aerostar Mini-Van

1990-97	4WD & AWD		344290	KG5499	KG5492					
1989-97	2WD	344083	344290	KG5460	KG5492	565051				
1986-88	ALL	344083	344084	KG5460	KG5461	565051				

FORD Aspire

1994-97	ALL Strut Mount w/ Bearing							SM5040 SM5273	SM5139	SB101
---------	-------------------------------	--	--	--	--	--	--	------------------	--------	-------

FORD Bronco

1984-96	ALL (Exc. Quad Shock Option)	344049	344077	KG5440	KG5441	565043	565044			
	Quad Shock Option - Frontward Mounting of the Axle	344076	344077	KG5439	KG5441		565044			
1980-83	ALL (Exc. Quad Shock Option)	344049	344078	KG5440	KG5442	565043				
	Quad Shock Option - Frontward Mounting of the Axle	344076	344078	KG5439	KG5442					
1967-77	ALL	344272	344085	KG5406	KG5419		565037			
	ALL (From Serial# 830001)	344272	344085	KG5406	KG5419		565037			
1966	ALL (To Serial #830000)		344071		KG5414					

FORD Bronco - Steering Stabilizer











1980-96	Complete Kit	SS15342								
1970-79	OEM Replacement Cylinder	SS10344								

FORD Bronco - Lift Replacement Shocks

1984-96	ALL (Exc. Quad Shock Option) Lift = 2-3"					565078	565081			
	Quad Shock Option - Frontward Mounting of the Axle Lift = 2-3"					565080	565081			
	Quad Shock Option - Rearward Mounting of the Axle Lift = 2-3"					565078	565081			
1980-83	ALL (Exc. Quad Shock Option) Lift = 2-3"					565078				
	Quad Shock Option - Rearward Mounting of the Axle Lift = 2-3"					565078				

Notes de bas de Page 259 - Guia de notas al calce del catalogo Pg. 260
 Bold part numbers indicate the most comparable KYB product to the original design & performance.
 (22) For vehicles with Electronic Susp., Leveling Control, and Air Suspensions refer to Appendix C.

Applications For Pass. Cars, Light Trucks, SUV's, & Vans

VEHICLE MAKE, MODEL & YEAR	GR-2	Gas-a-Just	MonoMax 56XXXX Series	STRUT & SHOCK	
MARQUE, MODELE ET	Excel-G		AGX 7XXXX Series	MOUNTS	BOOT KITS
ANNEE DU VEHICULE	 	 	 	 	 
LA MARCA EL MODELO & ANO					

FORD Bronco II

10/89-90	ALL	344268	344396	KG5489	KG5487	565001	565011				
2/89 - 9/89	ALL	344049	344396	KG5440	KG5487	565043	565011				
1983-1/89	ALL	344049	344050	KG5440	KG5454	565043					

FORD Contour

3/97-00	ALL	235620	235621					SM5138	SM5140	SB105	SB102
1995-2/97	ALL	235910	235911					SM5138	SM5140	SB105	SB102

FORD Cougar (Canadian Vehicle)

2001-02	ALL	235620	235621					SM5138	SM5140	SB105	SB102
---------	-----	--------	--------	--	--	--	--	--------	--------	-------	-------

FORD Country Sedan

1965-74	ALL	343128	343149	KG4515	KG5522						
1959-64	ALL	343127	343136	KG4515							
1957-58	ALL	343127	343131	KG4515	KG5526						
1952-56	ALL			KG4503	KG5517						

FORD Country Squire

1979-91	ALL	343128	343135	KG4515	KG5521						
1965-78	ALL	343128	343149	KG4515	KG5522						
1959-64	ALL	343127	343136	KG4515							
1957-58	ALL	343127	343131	KG4515	KG5526						
1952-56	ALL			KG4503	KG5517						

FORD Courier

1972-82	ALL	343127	344052								
---------	-----	--------	--------	--	--	--	--	--	--	--	--

FORD Crestline

1952-54	ALL			KG4503	KG5517						
---------	-----	--	--	--------	--------	--	--	--	--	--	--

FORD Crown Victoria

2003-10	ALL (Incl. Rear Air Spring Susp.) (Exc. Police Car & Taxi) Police Car & Taxi			551600	555601 ⁵⁹			SM5392	SM5267		
				551602	555603 ⁵⁹			SM5392	SM5267		
2000-02	Police Car & Taxi	344081 ³²	343135	KG5458 ³²	KG5521			C052			
1995-02	ALL (Exc. Police Car & Taxi)	344424	343135	KG5572	KG5521						
1983-99	Police Car & Taxi	344081	343135	KG5458	KG5521						
1983-94	ALL (Exc. Police Car & Taxi)	343128	343135	KG4515	KG5521						

FORD Custom

1965-72	ALL	343128	343149								
1964	ALL	343127	343136								
1957	ALL	343127	343219								
1952	ALL			KG4503	KG5517						

³² bushing kit C052 required with [KG5458] on Police / Taxi











⁵⁹ Mount kit SM5267 required with [555601], or [555603]

Notes de bas de Page 259 - Guia de notas al calce del catalogo Pg. 260

Bold part numbers indicate the most comparable KYB product to the original design & performance.

(22) For vehicles with Electronic Susp., Leveling Control, and Air Suspensions refer to Appendix C.

Applications For Pass. Cars, Light Trucks, SUV's, & Vans

VEHICLE MAKE, MODEL & YEAR	GR-2 <i>Excel-G</i>	Gas-a-Just	MonoMax 56XXXX Series AGX 7XXXX Series	STRUT & SHOCK MOUNTS	BOOT KITS
MARQUE, MODELE ET ANNEE DU VEHICULE	 	 	 	 	 
LA MARCA EL MODELO & ANO					

FORD Custom 500

1965-77	ALL	343128	343149							
1964	ALL	343127	343136							

FORD Customline

1952-56	ALL			KG4503	KG5517					
---------	-----	--	--	--------	--------	--	--	--	--	--

FORD E Super Duty, E450 Econoline

1996-07	ALL			KG6413	KG6414					
---------	-----	--	--	--------	--------	--	--	--	--	--

FORD Econoline (Exc. Motorhome Chassis)

1992-07	E350 (Inc. Club Wagon) (Inc. Cutaway Van)			KG5497	KG5498	565014	565010			
1992-06	E150 (Inc. Club Wagon) E250 (Inc. Club Wagon) (Exc. 8600GVW) E250 w/ 8600 GVW (Inc. Club Wagon)	344388 344370	344369 344371	KG5495 KG5497	KG5496 KG5498	565012 565014	565013 565010			
1975-91	E100, E150 E250, E350 (Inc. HD & Camper Conv.)	344069 344272	344071 344264	KG5410 KG5406	KG5414 KG5421					
1968-74	ALL		344085		KG5419		565037			
1961-67	ALL		344426	KG5438	KG5401					

FORD Edge

2010	ALL	Right Hand Left Hand		349068 349068						SB102 SB102
2007-09	ALL	Right Hand Left Hand	334644 334645	349068 349068						SB102 SB102

FORD Elite

1975-76	ALL		343128	343135	KG4515	KG5521				
---------	-----	--	--------	--------	--------	--------	--	--	--	--

FORD Escape

2009-10	ALL	Right Hand Left Hand	235912 235913					SM5390 SM5390	SM5547 ⁶³	SB105 SB105
	Upper Spring Seat									
2001-08	ALL	Right Hand Left Hand	235912 235913	344356 344356				SM5390 SM5390	SM5547 ⁶³	SB105 SB105
	Upper Spring Seat									













FORD Escort, ZX2 (Exc. Street Racer) (also see STRUT-PLUS)

1998-03	ZX2 Coupe	Right Hand Left Hand	235916 235917	234903 234904				SM5044 SM5044 SM5170 SM5155	SM5046 SM5046	SB105 SB105	SB104 SB104
	Strut Mount w/ Bearing Upper Spring Seat Lower Spring Seat Insulator								SM5430		
1997-03	ALL (Exc. ZX2 Coupe)	Right Hand Left Hand	235914 235915	234903 234904				SM5044 SM5044 SM5170 SM5155	SM5046 SM5046	SB105 SB105	SB104 SB104
	Strut Mount w/ Bearing Upper Spring Seat Lower Spring Seat Insulator								SM5430		
1991-96	ALL (Exc. ABS & 4WD)	Right Hand Left Hand	234037 234038	234039 234040				SM5044 SM5044 SM5305 SM5155	SM5046 SM5046	SB101 SB101	SB102 SB102
	Strut Mounting Kit Upper Spring Seat Lower Spring Seat Insulator								SM5430		

⁶³ New Part Number; Available 4th Quarter 2010

Notes de bas de Page 259 - Guia de notas al calce del catalogo Pg. 260
 Bold part numbers indicate the most comparable KYB product to the original design & performance.
 (22) For vehicles with Electronic Susp., Leveling Control, and Air Suspensions refer to Appendix C.

Applications For Pass. Cars, Light Trucks, SUV's, & Vans

VEHICLE MAKE, MODEL & YEAR	  	STRUT & SHOCK		BOOT KITS	
MARQUE, MODELE ET		MOUNTS			
ANNEE DU VEHICULE					
LA MARCA EL MODELO & ANO					
	 	 	 	 	 

FORD Escort, ZX2 (Exc. Street Racer) (also see STRUT-PLUS) (continued)

3/1/85-90	ALL	333141	231002					SM5037		SB101	SB103
1985-90	Late 1985 Front Strut Mounting Kit							SM5270			
3/85-90	Strut Mount Bearing for SM5037							SM5006			
1983-85	ALL (Built 2/1/83 thru 3/1/85)	234018	231002							SB101	SB103
1981-90	Rear Strut Mounting Kit								SM5269		
81-Early 85	Strut Mount							SM5268			
1981-2/1/83	ALL		231002							SB101	SB103

FORD Escort (Exc. Street Racer), ZX2 - STRUT PLUS

1998-03	ZX2 Coupe	Right Hand Left Hand		SR4014 SR4015							
1997-02	ALL (Exc. ZX2 Coupe)	Right Hand Left Hand	SR4012 SR4013	SR4014 SR4015							
1991-96	ALL (Exc. ABS & 4WD)	Right Hand Left Hand	SR4005 SR4006	SR4007 SR4008							

FORD Excursion

2000-05	2WD 4WD	344370		KG5497 KG54330	KG54329 KG54331	565014 565098	565099				
---------	------------	--------	--	-------------------	--------------------	------------------	--------	--	--	--	--

FORD Excursion (4WD) - Steering Stabilizer

2000-04	Complete Kit Replacement Cylinder Only	SS15489 SS10309									
---------	---	--------------------	--	--	--	--	--	--	--	--	--

FORD Expedition

2007-08	4WD (Exc. Air Susp.) RWD (Exc. Air Susp.)	341671 ⁶³ 341671 ⁶³	341672 ⁶³ 341672 ⁶³								
2003-06	4WD (Exc. Air Susp.) RWD (Exc. Air Susp.) 4WD Strut Mount w/ Off Road Susp. (Includes Red Strut Boot) Strut Mount w/o Off Road Susp. (Incl. Black Boot & Bumper) Strut Mount (Includes Black Strut Boot) Strut Mount w/ Air Susp.	341606 341605	341607 341607					SM5425	SM5536 ⁶³ SM5536 ⁶³		
1997-02	2WD (Exc. Rear Air Leveling) 2WD w/ Rear Air Leveling 4WD (Exc. Four Corner Air-Leveling System)	344367 344367 344368	344267 344377 344267	KG54311 KG54311 KG54313	KG54320 KG54319 KG54320	565004 565004 565006	565007 565005 565007				

FORD Expedition - Lift Replacement Shocks

1997-02	4WD (Exc. Four Corner Air-Leveling System) Lift = 0-1"					565006	565007				
---------	--	--	--	--	--	--------	--------	--	--	--	--

FORD Explorer

2006-10	ALL	341474	341475								
2006-09	Upper Spring Seat Insulator							SM5520			
2004-05	ALL (Exc. Sport-Trac) Upper Spring Seat Insulator	341419 ⁶¹	341327 ⁶¹					SM5391 SM5519	SM5391		
2002-03	ALL (Exc. Sport-Trac) Upper Spring Seat Insulator	341326 ⁶¹	341327 ⁶¹					SM5391 SM5518	SM5391		

⁶¹ [SM5391] may be required to replace original bushings in mount

⁶³ New Part Number; Available 4th Quarter 2010

Applications For Pass. Cars, Light Trucks, SUV's, & Vans

VEHICLE MAKE, MODEL & YEAR	GR-2	Gas-a-Just	MonoMax 56XXXX Series	STRUT & SHOCK	
MARQUE, MODELE ET	Excel-G		AGX 7XXXXX Series	MOUNTS	BOOT KITS
ANNEE DU VEHICULE					
LA MARCA EL MODELO & AÑO					

FORD Explorer (continued)

1995-01	ALL (Exc. Adjustable Susp.) AXLE DAMPER (Rear Quad Shock)	341302	344269 SS10201 ⁶³	KG54309	KG5490	561001	565003				
1991-94	ALL	344268	344269	KG5489	KG5490	565001	565003				

FORD Explorer Sport

2001-03	2 Door Sport	341302	344269	KG54309	KG5490	561001	565003				
---------	--------------	--------	--------	---------	--------	--------	--------	--	--	--	--

FORD Explorer Sport-Trac

2007-09	ALL	341474	341475								
2001-05	ALL	341302	344269	KG54309	KG5490	561001	565003				

FORD F100, F150 (2WD)

2009	ALL	341674 ⁶³									
2004-08	F150 & Super Crew (Exc. Lightning) Strut Mount (Includes Black Strut Boot)	341602	344414		KG5193			SM5424			
2004-07	Strut Boot									SB101	
2004	F150 Heritage (Exc. 7700 GVW Package)	344367	344374	KG54311	KG54312	565004					
	F150 Heritage w/ 7700 GVW Package F150 SVT Lightning	344367	344615 ⁶³ 344374	KG54311 KG5042	KG54312	565004					
2000-03	F150 Super Crew	344367	344374	KG54311	KG54312	565004	565008				
	F150 Series w/ 7700 GVW Package	344367	344615 ⁶³	KG54311		565004					
1999-03	F150 SVT Lightning		344374	KG5042	KG54312	565004	565008				
1997-03	ALL (Exc. Lightning & 7700 GVW Package)	344367	344374	KG54311	KG54312	565004	565008				
	ALL (Lowered 2" / 4")					565004	565010				
1994-96	Lightning Model			KG5440	KG5441	565043	565044				
1984-96	ALL (Exc. Lightning)	344049	344077	KG5440	KG5441	565043	565044				
1980-83	ALL	344049	344078	KG5440	KG5442	565043					
1970-79	ALL	344272	344071	KG5406	KG5414						
1965-69	ALL	344272	344085	KG5406	KG5419		565037				

FORD F100, F150 (2WD) - Steering Stabilizer

1980-96	ALL	SS15342									
---------	-----	---------	--	--	--	--	--	--	--	--	--

FORD F100, F150 (4WD)

2009	ALL	341675 ⁶³									
2004-08	F150 & Super Crew Strut Mount w/o Off Road Susp. (Incl. Black Boot & Bumper)	341601	344415		KG5192			SM5424			
	Strut Mount w/ Off Road Susp. (Includes Red Strut Boot)							SM5425			
2004	F150 Heritage (Exc. 7700 GVW Package) (Exc. Off-Road Package)	344368	344375	KG54313	KG54314	565006					
	F150 Heritage w/ 7700 GVW Package	344368	344616 ⁶³	KG54313		565006					
2000-03	F150 Series w/ 7700 GVW Package	344368	344616 ⁶³	KG54313		565006					
1997-03	F150, F150 Super Cab & F150 Super Crew (Exc. 7700 GVW Package)	344368	344375	KG54313	KG54314	565006	565009				
1990-96	ALL (Exc. Quad Shock Option)	344049	344079	KG5440	KG5493	565043	565063				
	Quad Shock Option - Frontward Mounting of the Axle	344076	344079	KG5439	KG5493		565063				
	Quad Shock Option - Rearward Mounting of the Axle	344049	344079	KG5440	KG5493	565043	565063				

⁶³ New Part Number; Available 4th Quarter 2010

Notes de bas de Page 259 - Guia de notas al calce del catalogo Pg. 260
 Bold part numbers indicate the most comparable KYB product to the original design & performance.
 (22) For vehicles with Electronic Susp., Leveling Control, and Air Suspensions refer to Appendix C.

Applications For Pass. Cars, Light Trucks, SUV's, & Vans

VEHICLE MAKE, MODEL & YEAR	GR-2		Gas-a-Just		MonoMax 56XXXX Series		STRUT & SHOCK			
MARQUE, MODELE ET	Excel-G				AGX 7XXXXX Series		MOUNTS		BOOT KITS	
ANNEE DU VEHICULE										
LA MARCA EL MODELO & ANO										

FORD F100, F150 (4WD) (continued)

1980-89	ALL (Exc. Quad Shock Option) Quad Shock Option - Frontward Mounting of the Axle	344049 344076	344077 344077	KG5440 KG5439	KG5441 KG5441	565043 565044	565044 565044				
	Quad Shock Option - Rearward Mounting of the Axle	344049	344077	KG5440	KG5441	565043	565044				
1978-79	ALL (Exc. Quad Shock Option & Super Cab) Quad Shock Option - Frontward Mounting of the Axle		344264		KG5421						
	Quad Shock Option - Rearward Mounting of the Axle		344264		KG5421						
	Super Cab		344264	KG5429	KG5421						
1977	ALL		344264		KG5421						
1970-76	ALL		344264		KG5421						

FORD F100, F150 (4WD) - Steering Stabilizer

1980-96	w/ Coil or Leaf Spring Front Suspension	SS15342									
1971-76	w/ Front Coil Springs Complete Kit	SS15345									
1970-79	OEM Replacement Cylinder	SS10344									

FORD F100, F150 (4WD) - Lift Replacement Shocks











2000-03	F150 Series w/ 7700 GVW Package Lift = 0-1"					565006					
1997-03	F150, F150 Super Cab & F150 Super Crew (Exc. 7700 GVW Package) Lift = 0-1" for Edelbrock # 33986 Lift = 4-5" for Rancho # RS5237 Lift = 4-5" for Rancho # RS9237 Lift = 4-5" for Rancho # RSX17329 Lift = 4-5" for Edelbrock # 34986 Lift = 4-5" for Rancho # RS5238 Lift = 4-5" for Rancho # RS9238 Lift = 4-5" for Rancho # RSX17311 Lift = 4-5"					565006 565088 565088 565088 565088 565009 565009 565009 565009	565009				
1990-96	ALL (Exc. Quad Shock Option) Lift = 0-2" Quad Shock Option - Frontward Mounting of the Axle Lift = 2 1/2-4" Quad Shock Option - Rearward Mounting of the Axle Lift = 0-2"					565078 565080 565078	565063 565063 565063				
1980-89	ALL (Exc. Quad Shock Option) Lift = 1-3" Quad Shock Option - Frontward Mounting of the Axle Lift = 1-3" Quad Shock Option - Rearward Mounting of the Axle Lift = 1-3"					565078 565080 565078					

FORD F250 (Exc. Superduty Models) (2WD)

1997-99	ALL (Less Than 8500GVW) (Exc. Rear Air Leveling) ALL (Over 8500GVW)	344367 344049	344615 ⁶³ 344077	KG54311 KG5440	KG5441 KG5441	565004 565043	565044 565044				
1980-96	ALL	344049	344077	KG5440	KG5441	565043	565044				
1973-79	ALL (Exc. Crew Cab) Crew Cab	344272 344272	344071 344085	KG5406 KG5406	KG5414 KG5419		565037				
1970-72	ALL	344272	344071	KG5406	KG5414						

⁶³ New Part Number; Available 4th Quarter 2010

Applications For Pass. Cars, Light Trucks, SUV's, & Vans

VEHICLE MAKE, MODEL & YEAR	  	STRUT & SHOCK		BOOT KITS	
MARQUE, MODELE ET		MOUNTS			
ANNEE DU VEHICULE					
LA MARCA EL MODELO & ANO					
	 	 	 	 	 

FORD F250 (Exc. Superduty Models) (2WD) (continued)

1965-69	ALL	344272	344085	KG5406	KG5419		565037				
---------	-----	--------	--------	--------	--------	--	--------	--	--	--	--

FORD F250 (2WD) - Steering Stabilizer

1980-96	ALL	SS15342									
---------	-----	---------	--	--	--	--	--	--	--	--	--

FORD F250 (Exc. Superduty Models) (4WD)

1997-99	ALL (Less Than 8500GVW) (Exc. Rear Air Leveling)	344368	344616 ⁶³	KG54313		565006					
1997-98	ALL (Over 8500GVW)	344267	344079	KG54320	KG5493	565007	565063				
1992-96	ALL	344267	344079	KG54320	KG5493	565007	565063				
1987-91	ALL	344267	344079	KG54320	KG5443						
1980-86	ALL		344079	KG5456	KG5443						
1977-79	ALL From Serial No. Y20001		344264	KG5429	KG5421						

FORD F250 (Exc. Superduty Models) (4WD) - Lift Replacement Shocks

1997-98	ALL (Less Than 8500GVW) Lift = 0-1" ALL (Over 8500GVW) Lift = 0-1"					565006 565007	565063				
1992-96	ALL Lift = 0-1"					565007	565063				

FORD F250 (4WD) - Steering Stabilizer

1997-98	Heavy Duty	SS15342									
1980-96	w/ Coil or Leaf Spring Front Suspension	SS15342									

FORD F250 Superduty (2WD)

2005-09	ALL	344370	345072	KG5497	554366	565014	565091				
1999-04	ALL	344370	344382	KG5497	KG54332	565014	565100				

FORD F250 Superduty (4WD)

2005-09	ALL	349004	345070	554347	555056		565091				
2003-04	ALL (Exc. 137" & 156" WB, Inc. FX4 Package) ALL w/ 137" & 156" WB, Inc. FX4 Package	344077 344412	344419 344413	KG5441 KG5043	KG54333 KG5044	565044	565091				
1999-02	ALL	344077	344419	KG5441	KG54333	565044	565091				

FORD F250 Superduty (4WD) Steering Stabilizer

2008-09	Replacement Unit	SS10202 ⁶³									
2005-07	Replacement Unit	SS10322									
1999-04	Complete Kit Replacement Unit	SS15489 SS10309									













FORD F250 Superduty (4WD) - Lift Replacement Shocks

2003-04	ALL (Exc. 137" & 156" WB, Inc. FX4 Package) Lift = 1-3"					565081					
1999-04	for Edelbrock # 63202 Lift = 2 1/2- 4" for Rancho # RS9264 Lift = 2 1/2- 4" for Rancho # RSX17341 Lift = 2 1/2- 4" for Edelbrock # 64203 Lift = 2 1/2" for Rancho # RS5012 Lift = 2 1/2" for Rancho # RS9012 Lift = 2 1/2"					565090 565090 565090	565091 565091 565091				

⁶³ New Part Number; Available 4th Quarter 2010

Notes de bas de Page 259 - Guia de notas al calce del catalogo Pg. 260
 Bold part numbers indicate the most comparable KYB product to the original design & performance.
 (22) For vehicles with Electronic Susp., Leveling Control, and Air Suspensions refer to Appendix C.

Applications For Pass. Cars, Light Trucks, SUV's, & Vans

VEHICLE MAKE, MODEL & YEAR	  	STRUT & SHOCK		BOOT KITS	
MARQUE, MODELE ET		MOUNTS			
ANNEE DU VEHICULE					
LA MARCA EL MODELO & ANO					
	 	 	 	 	 

FORD F250 Superduty (4WD) - Lift Replacement Shocks (continued)

1999-04	for Rancho # RSX17342 Lift = 2 1/2"					565091				
---------	-------------------------------------	--	--	--	--	--------	--	--	--	--

FORD F350 (Exc. Superduty Models) (2WD)

1980-98	ALL (Exc. Motorhome & w/ Dual Rear wheels)	344049	344077	KG5440	KG5441	565043	565044				
	ALL w/ Dual Rear Wheels	344049	344078	KG5440	KG5442	565043					
1974-79	Super Cab	344272	344071	KG5406	KG5414						
1967-79	ALL (Exc. 74-79 Super Cab)	344272	344085	KG5406	KG5419		565037				

FORD F350 (Exc. Superduty Models) (2WD) - Steering Stabilizer

1980-96	ALL	SS15342								
---------	-----	---------	--	--	--	--	--	--	--	--

FORD F350 (Exc. Superduty Models) (4WD)

1985-98	ALL w/ Monobeam Front Susp. - Front	344267		KG54320		565007					
	ALL w/ Monobeam Front Susp. - Rear		344079		KG5443						
	w/ Dual Rear wheels		344079		KG5493		565063				
	ALL w/ Monobeam Front Susp. - Rear										
	w/ Single Rear wheels										
1980-85	ALL w/ Independent Front Susp.		344079	KG5456	KG5443						
1979	ALL		344264	KG5429	KG5421						

FORD F350 (Exc. Superduty Models) (4WD) - Steering Stabilizer

1980-96	w/ Coil or Leaf Spring Front Suspension	SS15342								
---------	---	---------	--	--	--	--	--	--	--	--

FORD F350 (Exc. Superduty Models) (4WD) - Lift Replacement Shocks

1985-98	ALL w/ Monobeam Front Susp. - Front Lift = 0-1"					565007				
---------	---	--	--	--	--	--------	--	--	--	--

FORD F350 Superduty (2WD)

2005-09	ALL (Exc. Chassis Cab)	344370	345072	KG5497	554366	565014				
2005-08	Chassis Cab Series	344370	345071	KG5497	555053	565014				
1999-04	ALL (Exc. Chassis Cab)	344370	344382	KG5497	KG54332	565014	565100			
	Chassis Cab Series	344370	344077	KG5497	KG5441	565014	565044			

FORD F350 Superduty (4WD)

2008-09	ALL (Exc. Chassis Cab)	349004	344419	554347	KG54333					
	Chassis Cab Series	349004		554347	554363					
2005-07	ALL (Incl. Dual Rear Wheels)	349004	344419	554347	KG54333		565091			
2003-04	ALL (Exc. 137" & 156" WB, Inc. FX4 Package)	344077	344419	KG5441	KG54333	565044	565091			
	ALL w/ 137" & 156" WB, Including FX4 Package	344412	344413	KG5043	KG5044					
1999-04	Chassis Cab Series	344077	344382	KG5441	KG54332	565044	565100			
1999-02	ALL (Exc. Chassis Cab)	344077	344419	KG5441	KG54333	565044	565091			













FORD F350 Superduty (4WD) - Steering Stabilizer

2008-09	Replacement Unit	SS10202 ⁶³								
2005-07	Replacement Unit	SS10322								
1999-04	Complete Kit	SS15489								
	Replacement Unit	SS10309								

⁶³ New Part Number; Available 4th Quarter 2010

Notes de bas de Page 259 - Guia de notas al calce del catalogo Pg. 260
 Bold part numbers indicate the most comparable KYB product to the original design & performance.
 (22) For vehicles with Electronic Susp., Leveling Control, and Air Suspensions refer to Appendix C.

Applications For Pass. Cars, Light Trucks, SUV's, & Vans

VEHICLE MAKE, MODEL & YEAR	  	STRUT & SHOCK		BOOT KITS	
MARQUE, MODELE ET		MOUNTS			
ANNEE DU VEHICULE					
LA MARCA EL MODELO & ANO					
	 	 	 	 	 

FORD F350 Superduty (4WD) - Lift Replacement Shocks

2003-04	ALL (Exc. 137" & 156" WB, Inc. FX4 Package) Lift = 1-3"					565081				
1999-04	for Edelbrock # 63202 Lift = 2 1/2- 4" for Rancho # RS9264 Lift = 2 1/2- 4" for Rancho # RSX17341 Lift = 2 1/2- 4" for Edelbrock # 64203 Lift = 2 1/2" for Rancho # RS5012 Lift = 2 1/2" for Rancho # RS9012 Lift = 2 1/2" for Rancho # RSX17342 Lift = 2 1/2"					565090 565090 565090	565091 565091 565091 565091			
1999-02	ALL Lift = 1-3"					565081				

FORD F450 Superduty

2008-10	Cab & Chassis Crew Cab Pickup	349004 349004	344413	554347 554347	554362 KG5044					
2005-07	4WD RWD	349004 349004		554347 554347	554363 554362					
1999-04	2WD & 4WD (F47 Model)			KG5441	KG5443	565044	565081			
1988-98	2WD (F47 Model)	344387	344078	KG5486	KG5442					

FORD F450 Superduty (2WD) - Steering Stabilizer

1993-97	OEM Replacement Cylinder	SS10334								
1988-97	Complete Kit	SS10344								

FORD F550 Superduty

2008-10	Cab & Chassis Crew Cab Pickup	349004 349004	344413	554347 554347	554362 KG5044					
2005-07	4WD RWD	349004 349004		554347 554347	554363 554362					
1999-04	2WD & 4WD			KG5441	KG5443	565044	565081			

FORD Fairlane

1966-70	ALL (Exc. Station Wagon) Station Wagon	343156 343156	343219 343135	KG4505 KG4505	KG5517					
1962-65	ALL		343219		KG5517					
1957-58	Retractable H/Top	343127	343131	KG4515	KG5526					
1955-56	ALL			KG4503						

FORD Fairmont











1983	ALL	235005	343163		KG5559			SM5036		SB103
1982	ALL (Exc. TRX Susp.)	235001	343163		KG5559			SM5036		SB103
1981-82	ALL w/ TRX Susp.	235005	343163		KG5559			SM5036		SB103
1978-81	ALL (Exc. TRX Susp.)	235001	343161		KG5551					SB103

FORD Falcon

1966-70	ALL (Exc. Station Wagon) Station Wagon	343156 343156	343219 343135	KG4505 KG4505	KG5517					
1960-65	ALL	343156	343219	KG4505	KG5517					

Notes de bas de Page 259 - Guia de notas al calce del catalogo Pg. 260
 Bold part numbers indicate the most comparable KYB product to the original design & performance.
 (2) For vehicles with Electronic Susp., Leveling Control, and Air Suspensions refer to Appendix C.

Applications For Pass. Cars, Light Trucks, SUV's, & Vans

VEHICLE MAKE, MODEL & YEAR		GR-2 <i>Excel-G</i>		Gas-a-Just		MonoMax 56XXXX Series AGX 7XXXX Series		STRUT & SHOCK MOUNTS		BOOT KITS	
MARQUE, MODELE ET ANNEE DU VEHICULE		 		 		 		 		 	
LA MARCA EL MODELO & ANO											

FORD Festiva

1988-93	ALL	Right Hand	232021	340009					SM5040	SM5139	SB103	
		Left Hand	232022	340009					SM5040	SM5139	SB103	

FORD Fiesta

1977-81	ALL		233001								SB101	
---------	-----	--	--------	--	--	--	--	--	--	--	-------	--

FORD Five Hundred

2005-07	AWD (Exc. Self-Leveling Rear Suspension)	Right Hand	334638	341462								
		Left Hand	334639	341462								
	AWD with Self-Leveling Rear Suspension	Right Hand	334638									
		Left Hand	334639									
	FWD (Exc. Self Leveling Rear Susp.)	Right Hand	334640	341472								
		Left Hand	334641	341473								
	FWD w/ Self Leveling Rear	Right Hand	334640									
		Left Hand	334641									

FORD Focus (Exc. SVT Model) (also see STRUT-PLUS)

2009	ALL		NA	343429								
2008	ALL	Right Hand	334682 ⁶³	343429								
		Left Hand	334683 ⁶³	343429								
2006-07	Sedan & Hatchback	Right Hand	334682 ⁶³	343290			741067	SM5169	SM5206	SB101		
		Left Hand	334683 ⁶³	343290			741067	SM5169	SM5206	SB101		
	Station Wagon	Right Hand	334682 ⁶³	343291			NA	SM5169		SB101		
		Left Hand	334683 ⁶³	343291			NA	SM5169		SB101		
2000-05	Sedan & Hatchback	Right Hand	333348	343290		733036	741067	SM5169	SM5206	SB101		
		Left Hand	333349	343290		733037	741067	SM5169	SM5206	SB101		
	Station Wagon	Right Hand	333348	343291		733036	NA	SM5169		SB101		
		Left Hand	333349	343291		733037	NA	SM5169		SB101		

FORD Focus (Exc. SVT Model) - STRUT-PLUS

2000-05	Sedan & Hatchback	Right Hand	SR4027									
		Left Hand	SR4028									
	Station Wagon	Right Hand	SR4027									
		Left Hand	SR4028									

FORD Freestar

2004-07	ALL		235921	344467							SB130	
2004-06	Mount, Spring Seat & Bearing Lower Spring Seat Insulator								SM5448 SM5463			

FORD Freestyle

2005-07	AWD	Right Hand	334636	341462								
		Left Hand	334637	341462								
	FWD	Right Hand	334636	341470								
		Left Hand	334637	341471								











FORD Fusion

2006-10	Mount, Spring Seat & Bearing								SM5540 ⁶³			
2006-09	AWD	Right Hand	341405	349033							SB101	
		Left Hand	341406	349033							SB101	
	FWD	Right Hand	341405	344363							SB101	
		Left Hand	341406	344363							SB101	

⁶³ New Part Number; Available 4th Quarter 2010

Notes de bas de Page 259 - Guia de notas al calce del catalogo Pg. 260
 Bold part numbers indicate the most comparable KYB product to the original design & performance.
 (22) For vehicles with Electronic Susp., Leveling Control, and Air Suspensions refer to Appendix C.

Applications For Pass. Cars, Light Trucks, SUV's, & Vans

VEHICLE MAKE, MODEL & YEAR		GR-2		Gas-a-Just		MonoMax 56XXXX Series		STRUT & SHOCK			
MARQUE, MODELE ET		Excel-G				AGX 7XXXXX Series		MOUNTS		BOOT KITS	
ANNEE DU VEHICULE											
LA MARCA EL MODELO & ANO		 		 		 		 		 	

FORD GT

2005-06	ALL	NA	NA								
---------	-----	----	----	--	--	--	--	--	--	--	--

FORD Galaxie

1965-74	ALL	343128	343149	KG4515	KG5522						
1960-64	ALL	343127	343136	KG4515							
1959	ALL (Exc. Retr. H/Top) Retractable H/Top	343127 343127	343219 343136	KG4515 KG4515	KG5517						

FORD Granada

1981-82	ALL	235005	343163		KG5559			SM5036		SB103	
1975-80	ALL	343133	343136								

FORD Grand Marquis (Canadian Vehicle)

2003-06	ALL (Incl. Rear Air Spring Susp.) (Exc. Police Car & Taxi) Police Car & Taxi			551600	555601 ⁵⁹			SM5392	SM5267		
				551602	555603 ⁵⁹			SM5392	SM5267		
2001-02	ALL	344424	343135	KG5572	KG5521						

FORD LTD

1983-86	ALL	235005	343163		KG5559			SM5036		SB103	
1979-82	ALL	343128	343135	KG4515	KG5521						
1965-78	ALL	343128	343149	KG4515	KG5522						

FORD LTD II

1977-79	ALL	343128	343135	KG4515	KG5521						
---------	-----	--------	--------	--------	--------	--	--	--	--	--	--

FORD Mainline

1952-56	ALL			KG4503	KG5517						
---------	-----	--	--	--------	--------	--	--	--	--	--	--

FORD Marauder (Canadian Vehicle)

2003-06	ALL			551602	555603 ⁵⁹			SM5392	SM5267		
---------	-----	--	--	--------	----------------------	--	--	--------	--------	--	--

FORD Maverick

1969-77	ALL	343146	343136	KG4517							
---------	-----	--------	--------	--------	--	--	--	--	--	--	--

FORD Mustang, Mustang II













2010	ALL (Exc. SHELBY GT500)	235920									
2005-09	ALL (Exc. Bullit, GT500, GT500KR, Shelby)	235920	349026		554355						
2003-04	Mach I	235060			KG9090			SM5036		SB103	
1999-04	ALL (Exc. '99-'04 Cobra, Bullitt & Mach I)	235060	344433		KG9023 ²	734014	743021	SM5036		SB103	
1994-98	ALL	235060	344433		KG9023 ²	734014	743021	SM5036		SB103	
1987-93	GT, LX 5.0L & Cobra LX w/ 2.3L	235009 235005	343161 343163		KG5551 KG5559	734013	743020	SM5036 SM5036		SB103 SB103	
1987-89	Saleen Mustang	235009	343161		KG5551	734013	743020	SM5036		SB103	
1984-02	AXLE DAMPER (Rear Quad Shock)				KG4521 ²³						
1984-86	SVO Model		343161		KG5551		743020	SM5036			
1983-86	ALL (Exc. SVO, GT & Special Handling)	235005	343163		KG5559			SM5036		SB103	

² The KYB replacement unit comes with a new dustcover/ bumper assembly.

²³ Install [KG4521] with the dustcover to the rear of the vehicle, the spacers (in box) to the inboard side of the shock, and the axle mounting bracket spread slightly (1-2mm).

⁵⁹ Mount kit SM5267 required with [555601], or [555603]

Applications For Pass. Cars, Light Trucks, SUV's, & Vans

VEHICLE MAKE, MODEL & YEAR	  	STRUT & SHOCK		BOOT KITS	
MARQUE, MODELE ET		MOUNTS			
ANNEE DU VEHICULE					
LA MARCA EL MODELO & ANO					
	 	 	 	 	 

FORD Mustang, Mustang II (continued)

1983-86	GT & Special Handling (Exc.SVO)	235005	343161		KG5551		743020	SM5036		SB103	
1982	ALL (Exc. GT) GT Model		343163 343161		KG5559 KG5551		743020			SB103 SB103	
1979-81	ALL		343161		KG5551		743020			SB103	
1974-78	ALL (Built From 11/5/73)	343134	343148	KG4511							
1974	ALL (Built Thru 11/5/73)	343134	343137	KG4511							
1971-73	ALL (Incl. Shelby)	343156	343219	KG4504	KG5517						
1964-70	ALL (Incl. Shelby)	343146	343219	KG4517	KG5517						

FORD Pinto

1975-80	Sedan, Coupe & Hatchback Station Wagon	343134 343134	343137	KG4511 KG4511	KG5514						
1972-74	Sedan, Coupe & Hatchback Station Wagon	343134 343134	343137	KG4511 KG4511	KG5514						
1971	ALL	343134	343137	KG4511	KG5514						

FORD Probe (Exc. Electronically-Adjustable Suspension)

1993-7/97	ALL Right Hand Left Hand Strut Mounting Kit Upper Spring Seat	235601 235602	235603 235603					SM5076 SM5076 SM5308 SM5346	SM5094 SM5093	SB101 SB101	SB101 SB101
1993-97	Strut Mount Bearing							SM5129			
1990-92	Springseat (GT w/ auto trans., Exc. V6 w/ auto trans.)							SM5341			
1989-92	ALL Right Hand Left Hand ALL (For Adapting PRC to Non-PRC Suspension) Right Hand Left Hand Front Strut Mount (Manual Trans. exc. adj. Susp.) Strut Mounting Kit (Auto Trans Exc. 3.0L) Strut Mount Bearing for SM5041 Springseat 3.0L (Exc. GT)	235046 235047 235046 ^c 235047 ^c	235048 235048 235606 ^c 235606 ^c					SM5041 SM5300 SM5127 SM5343	SM5035 SM5035	SB101 SB101 SB101 SB101	SB101 SB101 SB101 SB101
1989	Springseat GT only							SM5341			

FORD Ranchero

1972-79	ALL	343128	343135	KG4515	KG5521						
1966-71	ALL	343156	343135	KG4505							
1960-65	ALL	343156	343219	KG4505	KG5517						
1959	ALL	343127	343136	KG4515							
1957-58	ALL	343127	343131	KG4515	KG5526						











FORD Ranger (2WD) (Exc. High Ryder Option)

2001-09	ALL 2WD w/ Coil Spring Front Susp. (Exc. EDGE Model) ALL 2WD w/ Torsion Bar Front Susp., Incl. EDGE Model	344397 341302	344396 344079	KG54328 KG54309	KG5487 KG5493		565011 565063				
1998-00	2WD	344397	344396	KG54328	KG5487		565011				
10/89-97	2WD	344268	344396	KG5489	KG5487	565001	565011				
2/89 - 9/89	2WD	344049	344396	KG5440	KG5487	565043	565011				

^c To convert from Electronic Susp - See Appendix C

Notes de bas de Page 259 - Guia de notas al calce del catalogo Pg. 260
 Bold part numbers indicate the most comparable KYB product to the original design & performance.
 (22) For vehicles with Electronic Susp., Leveling Control, and Air Suspensions refer to Appendix C.

Applications For Pass. Cars, Light Trucks, SUV's, & Vans

VEHICLE MAKE, MODEL & YEAR	GR-2	Gas-a-Just	MonoMax 56XXXX Series	STRUT & SHOCK	
MARQUE, MODELE ET	Excel-G		AGX 7XXXXX Series	MOUNTS	BOOT KITS
ANNEE DU VEHICULE	 	 	 	 	 
LA MARCA EL MODELO & ANO					

FORD Ranger (2WD) (Exc. High Ryder Option) (continued)

1983-1/89	2WD	344049	344050	KG5440	KG5454	565043				
-----------	-----	--------	--------	--------	--------	--------	--	--	--	--

FORD Ranger (4WD) (Exc. High Ryder Option)

2002-09	ALL w/ FX4 Bilstein Suspension			KG54309	KG5493					
2002-07	ALL w/FX4 Rancho Suspension	341302	344079	KG54309	KG5493					
1998-09	ALL 4WD (Exc. FX4)	341302	344079	KG54309	KG5493	561001	565063			
10/89-97	4WD	344268	344079	KG5489	KG5493	565001	565063			
2/89 - 9/89	4WD	344049	344079	KG5440	KG5493	565043	565063			
1983-1/89	4WD	344049	344051	KG5440	KG5455	565043				

FORD Ranger (4WD) (Exc. High Ryder Option) - Lift Replacement Shocks

1998-06	ALL 4WD (Exc. FX4) Lift = 0-2"					565063				
10/89-97	4WD Lift = 0-2"					565082	565063			
2/89 - 9/89	4WD Lift = 0-2"					565078	565063			
1983-1/89	4WD Lift = 0-2"					565078				

FORD Skyliner

1959	Retractable H/Top	343127	343136	KG4515						
1957-58	Retractable H/Top	343127	343131	KG4515	KG5526					

FORD Sunliner

1952-56	ALL			KG4503	KG5517					
---------	-----	--	--	--------	--------	--	--	--	--	--













FORD Taurus (also see STRUT-PLUS)

2008-09	AWD FWD	Right Hand Left Hand		341462 340012 ⁶³ 340013 ⁶³							
2000-07	Sedan	Right Hand Left Hand	334292 334293	334294 334294				SM5113 SM5113 SM5227 SM5466	SM5055 SM5055	SB103 SB103	SB101 SB101
2000-05	Station Wagon	Right Hand Left Hand	334292 334293	344434 344434	KG5575 KG5575			SM5113 SM5113 SM5227	SM5267 SM5267	SB103 SB103	
1996-99	Sedan (Exc. SHO) Station Wagon		334168 334168	334169 344432	KG5574			SM5113 SM5113 SM5227	SM5055	SB103 SB103	SB103
1991-95	Sedan (Incl. Police & SHO)		235054	334325				SM5038 SM5005 SM5415	SM5055 SM5414	SB103	SB103
1986-95	Station Wagon		235054	344271	KG5567			SM5038 SM5271 SM5005 SM5156		SB103	
1986-90	Sedan (Incl. Police & SHO)		235054	334325				SM5038 SM5272 SM5005	SM5015	SB103	SB103

⁶³ New Part Number; Available 4th Quarter 2010

Notes de bas de Page 259 - Guia de notas al calce del catalogo Pg. 260
 Bold part numbers indicate the most comparable KYB product to the original design & performance.
 (22) For vehicles with Electronic Susp., Leveling Control, and Air Suspensions refer to Appendix C.

Applications For Pass. Cars, Light Trucks, SUV's, & Vans

VEHICLE MAKE, MODEL & YEAR	  	STRUT & SHOCK		BOOT KITS	
MARQUE, MODELE ET		MOUNTS			
ANNEE DU VEHICULE					
LA MARCA EL MODELO & ANO					
	 	 	 	 	 

FORD Taurus (also see STRUT-PLUS) (continued)

1986-90	Upper Spring Seat Insulator								SM5235		
---------	-----------------------------	--	--	--	--	--	--	--	--------	--	--

FORD Taurus - STRUT-PLUS

2000-07	Sedan	Right Hand Left Hand	SR4009 SR4010	SR4011 SR4011							
2000-05	Station Wagon	Right Hand Left Hand	SR4009 SR4010								
1996-99	Sedan (Exc. SHO) Station Wagon		SR4033 SR4033	SR4034							
1991-95	Sedan (Incl. Police & SHO)		SR4017	SR4018							
1986-95	Station Wagon		SR4017								
1986-90	Sedan (Incl. Police & SHO)		SR4017	SR4018							

FORD Taurus X

2008-09	AWD FWD	Right Hand Left Hand	---- ⁷⁰ ---- ⁷⁰ ---- ⁷⁰	341462 341470 341471							
---------	------------	-------------------------	--	----------------------------	--	--	--	--	--	--	--

FORD Tempo

1987-91	AWD		333141						SM5037	SM5014	SB103	SB103
3/1/85-94	ALL (Exc.4WD)		333141	234016					SM5037	SM5014	SB103	SB103
1984-94	Front Strut Mounting Kit Strut Mount Bearing Upper Spring Seat Insulator								SM5270 SM5006	SM5347		
1984-3/1/85	ALL		234015	234016					SM5037	SM5014	SB101	SB103

FORD Thunderbird

2002-05	ALL		341655	341656								
1989-97	ALL (Exc. Adj. Susp.) Lower Spring Seat Insulator		231015	344110					SM5187 SM5465			
1987-88	ALL (Exc. Turbo Coupe) Turbo Coupe (For Adapting PRC to Non-PRC Suspension)		235005 235008 ^C	343162		KG5556 KG5556 ^C			SM5054		SB103 SB103	
1984-88	AXLE DAMPER (Rear Quad Shock)					KG4521 ²³						
12/80-86	ALL		235002	343162		KG5556			SM5054		SB103	
1977-79	ALL		343128	343135	KG4515	KG5521						
1973-76	ALL		343128		KG4515	KG5519						
1972	ALL		343128	343135	KG4515	KG5521						
1967-71	ALL		343128	343135	KG4515	KG5522						
1959-60	ALL		343127									
1955-57	ALL		343137	343219	KG5514	KG5517						

FORD Torino & Grand Torino

1972-76	ALL		343128	343135	KG4515	KG5521						
1968-71	ALL (Exc. Station Wagon) Station Wagon		343156 343156	343219 343135	KG4505 KG4505	KG5517						

²³ Install [KG4521] with the dustcover to the rear of the vehicle, the spacers (in box) to the inboard side of the shock, and the axle mounting bracket spread slightly (1-2mm).

⁷⁰ New Part Number, Available 2nd Quarter 2010

^C To convert from Electronic Susp - See Appendix C

Applications For Pass. Cars, Light Trucks, SUV's, & Vans

VEHICLE MAKE, MODEL & YEAR	<i>GR-2</i>	<i>Gas-a-Just</i>	<i>MonoMax</i> 56XXXX Series	STRUT & SHOCK	
MARQUE, MODELE ET	<i>Excel-G</i>		<i>AGX</i> 7XXXX Series	MOUNTS	BOOT KITS
ANNEE DU VEHICULE	 	 	 	 	 
LA MARCA EL MODELO & ANO					

FORD Victoria

1952-56	ALL			KG4503	KG5517					
---------	-----	--	--	--------	--------	--	--	--	--	--

FORD Windstar (also see STRUT-PLUS)

1995-03	ALL (Exc. Self leveling) Lower Spring Seat Insulator	235903	344291		KG54310			SM5116 SM5463		
1999-03	Strut Boot									SB130

FORD Windstar - STRUT-PLUS

1995-03	ALL (Exc. Self leveling)	SR4016								
---------	--------------------------	--------	--	--	--	--	--	--	--	--

FREIGHTLINER Sprinter 2500

2002-06	ALL (Exc. 118" WB, High Roof Option, Chassis Cab)	335810	349001							
	ALL w/ 118" WB & High Roof Option	335809	341339							
	ALL w/ 118" WB (Exc. High Roof Option)	335810	341339							
	ALL w/High Roof Option or Chassis Cab (Exc. 118" WB)	335809	349001							
	Mount Bushing							SM5445		

FREIGHTLINER Sprinter 3500

2002-06	ALL (Exc. High Roof Option, Dual Rear Wheels, Chassis Cab)	335810	349001							
	ALL w/Dual Rear Wheels & High Roof Option or Chassis Cab	335809	344409							
	ALL w/Dual Rear Wheels (Exc. High Roof Option, Chassis Cab)	335810	344409							
	ALL w/High Roof Option or Chassis Cab (Exc. Dual Rear Wheels)	335809	349001							
	Mount Bushing							SM5445		

GEO Metro (Also See Chevrolet)

1996-97	ALL	Right Hand Left Hand	232025 232026					SM5188 SM5188	SM5189 SM5189	SB103 SB103	SB101 SB101
1989-95	ALL w/ Front Brake Bracket on Strut mounting bracket	Right Hand Left Hand	232025 232026	232027 232027				SM5188 SM5188	SM5189 SM5189	SB103 SB103	SB101 SB101

GEO Prizm (Also See Chevrolet)

1993-97	ALL	Right Hand Left Hand	234057 234058	234059 234060				SM5049 SM5049	SM5075 SM5074	SB103 SB103	SB102 SB102
1989-92	ALL	Right Hand Left Hand	234035 234036	234031 234032				SM5049 SM5049	SM5075 SM5074	SB103 SB103	SB105 SB105

GEO Spectrum (Also See Chevrolet)













1989	ALL	Right Hand Left Hand	232015 232016		KG4542 KG4542			SM5297 SM5297		SB102 SB102	
------	-----	-------------------------	------------------	--	------------------	--	--	------------------	--	----------------	--

GEO Storm

1990-93	ALL From: VIN # - L7513805	Right Hand Left Hand	234041 234042	232033 232034				SM5081 SM5081	SM5105 SM5105	SB102 SB102	SB101 SB101
1989-90	ALL Thru VIN # - L7513804	Right Hand Left Hand	234041 234042	232023 232024				SM5081 SM5081	SM5105 SM5105	SB102 SB102	SB101 SB101

Notes de bas de Page 259 - Guia de notas al calce del catalogo Pg. 260
 Bold part numbers indicate the most comparable KYB product to the original design & performance.
 (22) For vehicles with Electronic Susp., Leveling Control, and Air Suspensions refer to Appendix C.

Applications For Pass. Cars, Light Trucks, SUV's, & Vans

VEHICLE MAKE, MODEL & YEAR	  	STRUT & SHOCK		BOOT KITS	
MARQUE, MODELE ET		MOUNTS			
ANNEE DU VEHICULE					
LA MARCA EL MODELO & ANO					
	 	 	 	 	 

GEO Tracker (Also See Chevrolet)

1996-98	ALL w/ 4 Wheel ABS	Right Hand Left Hand	334195 334196	343247 343247		KG4745A KG4745A			SM5082 SM5082		
1989-98	ALL (Exc. 4 Wheel ABS)	Right Hand Left Hand	235035 235036	343247 343247		KG4745A KG4745A			SM5082 SM5082		

GMC C & K Series Pickups (See Sierra)

			---	---							
--	--	--	-----	-----	--	--	--	--	--	--	--

GMC Caballero

1978-87	ALL		343127	343157 ²⁵	KG4513	KG5548 ²⁵					
---------	-----	--	--------	----------------------	--------	----------------------	--	--	--	--	--

GMC Canyon (2WD)

2004-09	ALL w/ Off-Road Package ALL w/o Off-Road Package		344465 341374	344466 344464	KG5781	KG5190 KG5191					
2004-05	Upper Spring Seat Insulator								SM5413		

GMC Canyon (4WD)

2004-09	ALL w/ Off-Road Package ALL w/o Off-Road Package		344465	344466	KG5781 KG5781	KG5190 KG5190					
---------	---	--	--------	--------	------------------	------------------	--	--	--	--	--

GMC Envoy (2WD)

2002-09	Lower Spring Seat Insulator								SM5548 ⁶³		
2002-08	Mount w/ Spring Insulator								SM5395		
2002-06	ALL		331016 ⁸¹	343395		KG4162					SB108
2000-01	ALL		344040	344041	KG5450	KG5451	565046	565047			

GMC Envoy (4WD)

2007-08	ALL			343395		KG4162					SB108
2007	ALL		331043 ⁶⁸	343395		KG4162					SB108
2002-09	Lower Spring Seat Insulator								SM5548 ⁶³		
2002-08	Mount w/ Spring Insulator								SM5395		
2002-06	ALL		331016 ⁸¹	343395		KG4162					SB108
1998-01	ALL 4 Door (Exc. Auto Leveling)		344042	344041	KG5452	KG5451	565048	565047			

GMC Envoy (4WD) Lift Replacement Shocks

1998-01	ALL 4 Door (Exc. Auto Leveling) Lift = 0-2"						565075	565047			
---------	---	--	--	--	--	--	--------	--------	--	--	--

GMC Envoy XL, XUV (2WD & 4WD)

2003-06	ALL Strut Mount w/ Insulator Lower Spring Seat Insulator		331016 ⁸¹	343395		KG4162			SM5395 SM5548 ⁶³		SB108
---------	--	--	----------------------	--------	--	--------	--	--	--------------------------------	--	-------

GMC G-Series (1/2 Ton) Van

1978-95	ALL		344068	344075	KG5409	KG5430	565032	565039			
1971-77	ALL		344068		KG5409	KG5417	565032				
1967-70	ALL			344085		KG5419		565037			
1964-66	ALL					KG5416					













²⁵ Eliminates OEM airshocks. See appendix B for special instructions.

⁶³ New Part Number; Available 4th Quarter 2010

⁶⁸ New Part Number; Available 3rd Quarter 2010

⁸¹ When [331016] stock is depleted, use [331043]

Applications For Pass. Cars, Light Trucks, SUV's, & Vans

VEHICLE MAKE, MODEL & YEAR	  	STRUT & SHOCK		BOOT KITS	
MARQUE, MODELE ET		MOUNTS			
ANNEE DU VEHICULE					
LA MARCA EL MODELO & ANO					
	 	 	 	 	 

GMC G-Series (3/4 Ton) Van

1978-95	ALL	344068	344075	KG5409	KG5430	565032	565039				
1971-77	ALL	344068		KG5409	KG5417	565032					
1967-70	ALL		344085		KG5419		565037				

GMC G-Series Van (1 Ton) (Exc. Motorhome Chassis)

1993-96	G3500 HD w/ Straight Front Axle, Leaf Spring (P42, P62)	345030	344366	KG6001A	KG5420		565038				
	G3500 HD w/ Independent Front, Coil Spring (P42, P62)		344366	KG6412	KG5420		565038				
1978-95	ALL (Exc. Dual Rear Wheels & HD)	344068	344075	KG5409	KG5430	565032	565039				
	ALL w/ Dual Rear Wheels	344068		KG5409	KG5488	565032					
1971-77	ALL	344068		KG5409	KG5417	565032					

GMC Jimmy - Full Size (2WD) (Exc. S-Series)

1973-82	ALL	344068	344072	KG5409	KG5415	565032	565036				
1969-72	w/ Coil Spring	344068		KG5409	KG5416	565032					
	w/ Leaf Spring	344068	344085	KG5409	KG5419	565032	565037				

GMC Jimmy - Full Size (4WD) (Exc. S-Series)

1985-91	w/ Dual Front Shocks-Inside Shock		344072	KG5477	KG5415	565039	565036				
	w/ Dual Front Shocks-Outside Shock	344067	344072	KG5408	KG5415	565031	565036				
1980-84	w/ Dual Front Shocks-Inside Shock	344075	344072	KG5430	KG5415	565039	565036				
	w/ Dual Front Shocks-Outside Shock	344067	344072	KG5408	KG5415	565031	565036				
1973-91	ALL (Exc. w/ Dual Front Shocks)	344067	344072	KG5408	KG5415	565031	565036				
1969-72	ALL	344067		KG5408	KG5417	565031					

GMC Jimmy - Full Size (4WD) Steering Stabilizer

1973-91	OEM Replacement Cylinder	SS10325									
---------	--------------------------	---------	--	--	--	--	--	--	--	--	--

GMC Jimmy (S-Series), S15 Jimmy (2WD)

1995-05	ALL (Incl. ZQ8 Sport Susp.)	344040	344041	KG5450	KG5451	565046	565047				
1983-05	ALL (Lowered 2" / 4")					565046	565064				
1983-94	ALL (Incl. ZQ8 Sport Susp.)	344040	344041	KG5450	KG5451	565046	565047				

GMC Jimmy (S-Series), S15 Jimmy (4WD)

1995-03	ALL w/ ZR2 HighRider Package	344042		KG5452		565048					
1994-05	ALL (Exc. ZR2 HighRider Package)	344042	344041	KG5452	KG5451	565048	565047				
1983-94	ALL	344042	344041	KG5452	KG5451	565048	565047				

GMC P1000, P1500

1974-84	ALL	344068	344366	KG5409	KG5420	565032	565038				
1973	ALL	344068	344072	KG5409	KG5415	565032	565036				
1967-72	ALL	344068		KG5409	KG5416	565032					
1963-66	ALL	344068	344085	KG5409	KG5419	565032	565037				

GMC P2500

1982-91	ALL	344068	344366	KG5409	KG5420	565032	565038				
1973-81	ALL	344068	344072	KG5409	KG5415	565032	565036				
1968-72	ALL	344068	344085	KG5409	KG5419	565032	565037				

Notes de bas de Page 259 - Guia de notas al calce del catalogo Pg. 260
 Bold part numbers indicate the most comparable KYB product to the original design & performance.
 (22) For vehicles with Electronic Susp., Leveling Control, and Air Suspensions refer to Appendix C.

Applications For Pass. Cars, Light Trucks, SUV's, & Vans

VEHICLE MAKE, MODEL & YEAR	GR-2		Gas-a-Just		MonoMax 56XXXX Series		STRUT & SHOCK			
MARQUE, MODELE ET	Excel-G				AGX 7XXXXX Series		MOUNTS		BOOT KITS	
ANNEE DU VEHICULE										
LA MARCA EL MODELO & ANO										

GMC P3500 (Exc. Motorhome Chassis)

1985-01	ALL (Exc. Monobeam Front Susp. & Camper Conversion) w/ Camper Conversion (Exc. Monobeam Front Susp.) w/ Monobeam Front Susp., Including Camper Conversion	344068	344366	KG5409	KG5420	565032	565038				
			344366		KG5420		565038				
			344366		KG5420		565038				
1973-84	ALL Incl. Camper Conversion	344068	344366	KG5409	KG5420	565032	565038				
1968-72	ALL (Exc. w/ 157" WB & 11,000lb. Axle) w/ 157" WB & 11,000lb. Axle	344068	344085	KG5409	KG5419	565032	565037				
		344068		KG5409	KG5417	565032					

GMC P-Series Motorhome Chassis - Steering Stabilizer

1975-01	P30 GM Motorhome Chassis- OEM Replacement (Replaces DELCO #4984838)	SS10329									
---------	---	---------	--	--	--	--	--	--	--	--	--

GMC Safari (2WD)

1996-05	ALL	344081	344082	KG5458	KG5459	565049	565050				
1990-95	ALL	344081	344082	KG5458	KG5459	565049	565050				
1985-89	ALL	344081	344082	KG5458	KG5459	565049	565050				
1985-04	ALL (Lowered 2" / 4")					565049	565037				

GMC Safari (AWD)

1996-05	ALL	344266	344082	KG5480	KG5459	565062	565050				
1990-95	ALL	344266	344082	KG5480	KG5459	565062	565050				

GMC Savana 1500 (1/2 Ton) Van

2003-10	2WD	344481	344483	KG5780	KG5188		565033				
	AWD	341343	344483	KG5040	KG5188		565033				
1996-02	ALL	344265	344273	KG5478	KG54100	565060	565033				

GMC Savana 2500 (3/4 Ton) Van

2003-10	ALL (Exc. 7300 GVW)	349046	349009	554356	554348						
2003-07	ALL w/ 7300 GVW	344481	344273	KG5780	KG54100		565033				
1996-02	ALL (Including 8600 GVW)	344265	344273	KG5478	KG54100	565060	565033				

GMC Savana 3500 (1 Ton) Van

2006-10	ALL (Exc. Cutaway Chassis) Cutaway Chassis w/ Lowered rear Leaf Susp.	349046 349046	349009 344483	554356 554356	554348 KG5188						
2003-05	ALL w/ Dual Rear Wheels ALL w/ Single Rear Wheels	349046 349046	344263 344262	554356 554356	KG5188 KG5188		565061 565034				
1996-02	ALL w/ Dual Rear Wheels ALL w/ Single Rear Wheels	344265 344265	344273 344262	KG5478 KG5478	KG54100 KG54101	565060 565060	565033 565034				

GMC Sierra, C & R - Series 1/2 Ton (2WD)

2007-09	Sierra 1500 (Exc. Classic Series, HD & Electronic Susp.)	341493	345074	551121 ⁷⁰	555055			SM5530 ⁶³		SB129	
2007	Sierra Classic 1500 (Exc. HD, Crew Cab, Elec. Susp. & QuadraSteer) Sierra 1500HD Crew Cab w/ Torsion Bar Front Susp. (Exc. Elec. Susp. & QuadraSteer)	344380 344383	344365 344385	KG54326 KG54340	KG54104 KG54342	565066 565102	565016 565104				

⁶³ New Part Number; Available 4th Quarter 2010

⁷⁰ New Part Number, Available 2nd Quarter 2010

Notes de bas de Page 259 - Guia de notas al calce del catalogo Pg. 260

Bold part numbers indicate the most comparable KYB product to the original design & performance.

(22) For vehicles with Electronic Susp., Leveling Control, and Air Suspensions refer to Appendix C.

Applications For Pass. Cars, Light Trucks, SUV's, & Vans

VEHICLE MAKE, MODEL & YEAR	GR-2	Gas-a-Just	MonoMax 56XXXX Series	STRUT & SHOCK	
MARQUE, MODELE ET	Excel-G		AGX 7XXXXX Series	MOUNTS	BOOT KITS
ANNEE DU VEHICULE					
LA MARCA EL MODELO & ANO					

GMC Sierra, C & R - Series 1/2 Ton (2WD) (continued)

2005-06	Sierra 1500HD Crew Cab (Exc. Elec. Susp. & QuadraSteer)	344383	344385	KG54340	KG54342	565102	565104				
2004-06	Sierra 1500 Crew Cab w/ Coil Spring Front Susp. (Exc. Elec. Susp. & QuadraSteer)	344402	344385	KG54339	KG54342	565101	565104				
2004	Sierra 1500 Crew Cab w/ Torsion Bar Front Susp. (Exc. Elec. Susp. & QuadraSteer)	344381	344386	KG54327	KG54341	565067	565103				
2001-03	Sierra 1500HD Crew Cab w/ Coil Spring Front Susp. (Exc. Electronic Ride Control)	344402	344385	KG54339	KG54342	565101	565104				
	Sierra 1500HD Crew Cab w/ Torsion Bar Front Susp. (Exc. Elec. Susp. & QuadraSteer)	344383	344385	KG54340	KG54342	565102	565104				
1999-06	Sierra 1500 (Exc. HD, Crew Cab, Elect. Susp. & QuadraSteer)	344380	344365	KG54326	KG54104	565066	565016				
1999	C1500 C1500 (Lowered 2" / 4")	344265	344263	KG5478	KG5479	565060 565060	565061 565033				
1988-98	C1500 C1500 (Lowered 2" / 4")	344265	344263	KG5478	KG5479	565060 565060	565061 565033				
1987	R1500	344068	344072	KG5409	KG5415	565032	565036				
1973-86	C15, C1500	344068	344072	KG5409	KG5415	565032	565036				
1967-72	C15, C1500 w/ Coil Spring	344068		KG5409	KG5416	565032					
	C15, C1500 w/ Leaf Spring	344068	344085	KG5409	KG5419	565032	565037				
1963-66	ALL	344068	344085	KG5409	KG5419	565032	565037				

GMC Sierra, K & V - Series 1/2 Ton (4WD)

2007-09	Sierra 1500 (Exc. Classic Series, HD & Electronic Susp.)	341493	345074	551121 ⁷⁰	555055			SM5530 ⁶³		SB129	
2007	Sierra Classic 1500 (Exc. HD, Crew Cab, Elec. Susp. & QuadraSteer)	344381	344386	KG54327	KG5482	565067	565068				
	Sierra Classic 1500 w/ Z-71 Off Road Package			KG54327	KG5482	565067	565068				
2005-07	Sierra 1500HD Crew Cab, Incl. Classic (Exc. Elec. Susp. & QuadraSteer)	344383	344385	KG54340	KG54342	565102	565104				
2001-03	Sierra 1500HD Crew Cab (Exc. Elec. Susp. & QuadraSteer)	344383	344385	KG54340	KG54342	565102	565104				
1999-06	Sierra 1500 (Exc. HD, Elec. Susp. & QuadraSteer)	344381	344386	KG54327	KG5482	565067	565068				
	Sierra 1500 (w/ Z-71 Off Road Package)			KG54327	KG5482	565067	565068				
1988-99	K1500 (Exc. Z-71 Off Road Package)	344266	344263	KG5480	KG5479	565062	565061				
	K1500 w/ Z-71 Off Road Package			KG5480	KG5479	565062	565061				
1987	V1500 (Exc. w/ Dual Front Shocks)	344067	344072	KG5408	KG5415	565031	565036				
	V1500 w/ Dual Front Shocks - inside shock		344072	KG5477	KG5415	565039	565036				
	V1500 w/ Dual Front Shocks - outside shock	344067	344072	KG5408	KG5415	565031	565036				
1985-86	K1500 w/ Dual Front Shocks - inside shock		344072	KG5477	KG5415	565039	565036				
	K1500 w/ Dual Front Shocks - outside shock	344067	344072	KG5408	KG5415	565031	565036				
1980-84	K1500 w/ Dual Front Shocks - inside shock	344075	344072	KG5430	KG5415	565039	565036				
	K1500 w/ Dual Front Shocks - outside shock	344067	344072	KG5408	KG5415	565031	565036				

⁶³ New Part Number; Available 4th Quarter 2010

⁷⁰ New Part Number; Available 2nd Quarter 2010

Notes de bas de Page 259 - Guia de notas al calce del catalogo Pg. 260

Bold part numbers indicate the most comparable KYB product to the original design & performance.

(22) For vehicles with Electronic Susp., Leveling Control, and Air Suspensions refer to Appendix C.

Applications For Pass. Cars, Light Trucks, SUV's, & Vans

VEHICLE MAKE, MODEL & YEAR	GR-2		Gas-a-Just		MonoMax 56XXXX Series		STRUT & SHOCK			
MARQUE, MODELE ET	Excel-G				AGX		MOUNTS		BOOT KITS	
ANNEE DU VEHICULE					7XXXXX Series					
LA MARCA EL MODELO & ANO										

GMC Sierra, K & V - Series 1/2 Ton (4WD) (continued)

1973-86	K1500 (Exc. w/ Dual Front Shocks)	344067	344072	KG5408	KG5415	565031	565036				
1969-72	ALL	344067		KG5408	KG5417	565031					

GMC Sierra, K & V - Series (1/2 Ton) (4WD) Steering Stabilizer

1988-05	Complete Kit	SS15326									
1988-98	w/ OE Unit (Cylinder only)	SS10317									
1973-87	OEM Replacement Cylinder	SS10325									

GMC Sierra, C & R - Series 3/4 Ton (2WD)

2005-10	Sierra 2500HD	344383	344385	KG54340	KG54342	565102	565104				
2000-04	Sierra 2500HD (9200 GVW)	344383	344385	KG54340	KG54342	565102	565104				
1999-04	Sierra 2500 (up to 8600 GVW) (Exc. QuadrasTeer)	344402	344385	KG54339	KG54342	565101	565104				
1999-00	C2500 C2500 (Lowered 2" / 4")	344265	344263	KG5478	KG5479	565060 565060	565061 565033				
1988-98	C2500 C2500 (Lowered 2" / 4")	344265	344263	KG5478	KG5479	565060 565060	565061 565033				
1987-89	R2500 (Exc. Crew Cab) R2500 Crew Cab	344068 344068	344072 344366	KG5409 KG5409	KG5415 KG5420	565032 565032	565036 565038				
1973-86	C2500 (Exc. Crew Cab) C2500 Crew Cab	344068 344068	344072 344366	KG5409 KG5409	KG5415 KG5420	565032 565032	565036 565038				
1967-72	C25, C2500 w/ Coil Springs C25, C2500 w/ Leaf Springs	344068 344068	344085	KG5409 KG5409	KG5416 KG5419	565032 565032	565037				
1963-66	ALL	344068	344085	KG5409	KG5419	565032	565037				

GMC Sierra, K & V - Series (3/4 Ton) (4WD)

2005-10	Sierra 2500HD	344383	344385	KG54340	KG54342	565102	565104				
2000-04	Sierra 2500HD (9200 GVW)	344383	344385	KG54340	KG54342	565102	565104				
1999-04	Sierra 2500 (up to 8600 GVW) (Exc. QuadrasTeer)	344383	344385	KG54340	KG54342	565102	565104				
1999-00	K2500	344266	344263	KG5480	KG5479	565062	565061				
1987-98	K2500	344266	344263	KG5480	KG5479	565062	565061				
1987	V2500 (Exc. w/ Dual Front Shocks) V2500 w/ Dual Front Shocks - inside shock V2500 w/ Dual Front Shocks - outside shock	344067 344067 344067	344072 344072	KG5408 KG5477	KG5415 KG5415	565031 565039	565036 565036				
1985-86	K2500 w/ Dual Front Shocks - outside shock K2500 w/ Dual Front Shocks - inside shock	344067	344072	KG5408 KG5477	KG5415 KG5415	565031 565039	565036 565036				
1980-84	K2500 w/ Dual Front Shocks - inside shock K2500 w/ Dual Front Shocks - outside shock	344075 344067	344072	KG5430 KG5408	KG5415 KG5415	565039 565031	565036 565036				
1973-86	K2500 (Exc. w/ Dual Front Shocks)	344067	344072	KG5408	KG5415	565031	565036				
1969-72	ALL	344067		KG5408	KG5417	565031					

Notes de bas de Page 259 - Guia de notas al calce del catalogo Pg. 260

Bold part numbers indicate the most comparable KYB product to the original design & performance.
(22) For vehicles with Electronic Susp., Leveling Control, and Air Suspensions refer to Appendix C.

Applications For Pass. Cars, Light Trucks, SUV's, & Vans

VEHICLE MAKE, MODEL & YEAR	GR-2	Gas-a-Just	MonoMax 56XXXX Series	STRUT & SHOCK	
MARQUE, MODELE ET	Excel-G		AGX 7XXXXX Series	MOUNTS	BOOT KITS
ANNEE DU VEHICULE					
LA MARCA EL MODELO & ANO					

GMC Sierra, K & V - Series (3/4 Ton) (4WD) Steering Stabilizer

2002-05	2500HD OEM Replacemant Cylinder	SS10318								
1988-04	Complete Kit	SS15326								
1988-98	w/ OE Unit (Cylinder only)	SS10317								
1973-87	OEM Replacement Cylinder	SS10325								

GMC Sierra, C & R - Series (1 Ton) (2WD)

2007-10	Sierra 3500HD	344383	344384	KG54340	KG54341	565102	565103				
2001-07	Sierra 3500, Incl. Chassis Cab & Classic (11400 GVW)	344383	344384	KG54340	KG54341	565102	565103				
1999-00	C3500 (Exc. HD Series) C3500 (Lowered 2" / 4") (Exc. HD Series)	344265	344263	KG5478	KG5479	565060 565060	565061 565033				
1991-03	C3500 HD Series w/ I-Beam Front Axle		344263	KG54307	KG5479		565061				
1988-98	C3500 (Exc. HD Series) C3500 (Lowered 2" / 4") (Exc. HD Series)	344265	344263	KG5478	KG5479	565060 565060	565061 565033				
1987-91	R3500	344068	344366	KG5409	KG5420	565032	565038				
1973-86	C3500	344068	344366	KG5409	KG5420	565032	565038				
1967-72	C3500 (Exc. w/ 157" WB & 11,000lb. Axle)	344068	344085	KG5409	KG5419	565032	565037				
	C3500 w/ 157" WB & 11,000lb. Axle	344068		KG5409	KG5417	565032					

GMC Sierra, K & V - Series (1 Ton) (4WD)

2007-10	Sierra 3500HD	344383	344384	KG54340	KG54341	565102	565103				
2001-07	Sierra 3500, Incl. Chassis Cab & Classic (11400 GVW)	344383	344384	KG54340	KG54341	565102	565103				
1987-00	K3500	344266	344263	KG5480	KG5479	565062	565061				
1987-91	V3500		344386	KG5481	KG5482	565069	565068				
1977-86	K3500		344386	KG5481	KG5482	565069	565068				

GMC Sierra, K & V Series (1Ton) (4WD) Steering Stabilizer

1973-87	OEM Replacement Cylinder	SS10325								
---------	--------------------------	---------	--	--	--	--	--	--	--	--

GMC K1500, K2500, K3500 (Exc. Sub. & Elect. Ride Control Susp.) KYB Lift Kit Repl. Shocks













1988-99	ALL Lift = 1-3" for Edelbrock # 6360 Lift = 4-6" for Rancho # RS5244 Lift = 4-6" for Rancho # RS9244 Lift = 4-6" for Rancho # RSX17316 Lift = 4-6" for Edelbrock # 63003 Lift = 4-6" for Edelbrock # 6460 Lift = 4-6" for Rancho # RS5227 Lift = 4-6" for Rancho # RS9227 Lift = 4-6" for Rancho # RSX17315 Lift = 4-6"					565073 565086 565092 565092 565086	565074				
							565087 565087 565087 565087 565087				

GMC Sierra 1500 4WD (Exc. Crew Cab & Adj. Susp., Quadrasteer) KYB Lift Kit Replacement Shocks

2007	Sierra Classic 1500 (Exc. HD, Crew Cab, Elec. Susp. & Quadrasteer) Lift = 1-4"					565076	565077				
1999-07	Sierra 1500 (w/ Z-71 Off Road Package) Lift = 1-4"					565076	565077				

Notes de bas de Page 259 - Guia de notas al calce del catalogo Pg. 260
 Bold part numbers indicate the most comparable KYB product to the original design & performance.
 (22) For vehicles with Electronic Susp., Leveling Control, and Air Suspensions refer to Appendix C.

Applications For Pass. Cars, Light Trucks, SUV's, & Vans

VEHICLE MAKE, MODEL & YEAR	  	STRUT & SHOCK		BOOT KITS	
MARQUE, MODELE ET		MOUNTS			
ANNEE DU VEHICULE					
LA MARCA EL MODELO & ANO					
	 	 	 	 	 

GMC Sierra 1500 4WD (Exc. Crew Cab & Adj. Susp., QuadraSteer) KYB Lift Kit Replacement Shocks (continued)

1999-06	ALL Lift = 1-4" for Edelbrock # 63005 Lift = 4" for Edelbrock # 63008 Lift = 4" for Rancho # RS9268 Lift = 4" for Rancho # RSX17337 Lift = 4" for Edelbrock # 6405 Lift = 4" for Edelbrock # 6408 Lift = 4" for Rancho # RS9268 Lift = 4" for Rancho # RSX17338 Lift = 4"					565076 565076 565076 565076 565076	565077				
1999-00	Sierra Classic K1500, K2500, K3500 (Exc. Suburban) Lift = 1-3"					565073	565074				

GMC Sprint

1971-77	ALL	343127	343157 ²⁵	KG4513	KG5504 ²⁵						
---------	-----	--------	----------------------	--------	----------------------	--	--	--	--	--	--

GMC S-Series (2WD) Pickup, Sonoma

1995-04	ALL (Incl. ZQ8 Sport Susp.)	344040	344041	KG5450	KG5451	565046	565047				
1982-04	ALL (Lowered 2" / 4")					565046	565064				
1982-94	ALL (Incl. ZQ8 Sport Susp.)	344040	344041	KG5450	KG5451	565046	565047				

GMC S-Series (4WD) Pickup, Syclone, Typhoon

1994-04	ALL (Exc. ZR2 HighRider Package)	344042	344041	KG5452	KG5451	565048	565047				
1994-03	ALL w/ ZR2 HighRider Package	344042		KG5452		565048					
1991-93	Syclone, Typhoon			KG5452	KG5451	565048	565047				
1982-94	S15, Sonoma	344042	344041	KG5452	KG5451	565048	565047				

GMC S-Series (4WD) Pickup, Jimmy, Syclone, Typhoon - Lift Replacement Shocks

1982-05	ALL Lift = 1-3"					565075					
---------	-----------------	--	--	--	--	--------	--	--	--	--	--

GMC Suburban (1/2 Ton) (2WD) C & R Series

1992-99	C1500	344265	344273	KG5478	KG54100	565060	565033				
1987-91	R1500	344068	344072	KG5409	KG5415	565032	565036				
1973-86	ALL	344068	344072	KG5409	KG5415	565032	565036				
1967-72	ALL	344068		KG5409	KG5416	565032					
1963-66	ALL	344068	344085	KG5409	KG5419	565032	565037				

GMC Suburban (1/2 Ton) (4WD) K & V Series

1992-99	K1500	344266	344262	KG5480	KG54101	565062	565034				
1987-91	V1500 (Exc. w/ Dual Front Shocks)	344067	344072	KG5408	KG5415	565031	565036				
	V1500 w/ Dual Front Shocks - inside shock		344072	KG5477	KG5415	565039	565036				
	V1500 w/ Dual Front Shocks - outside shock	344067	344072	KG5408	KG5415	565031	565036				
1985-86	K1500 w/ Dual Front Shocks - inside shock		344072	KG5477	KG5415	565039	565036				
1980-84	K1500 w/ Dual Front Shocks - inside shock	344075	344072	KG5430	KG5415	565039	565036				
1980-86	K1500 w/ Dual Front Shocks - outside shock	344067	344072	KG5408	KG5415	565031	565036				
1973-86	K1500 (Exc. w/ Dual Front Shocks)	344067	344072	KG5408	KG5415	565031	565036				
1969-72	ALL	344067		KG5408	KG5417	565031					

²⁵ Eliminates OEM airshocks. See appendix B for special instructions.

Applications For Pass. Cars, Light Trucks, SUV's, & Vans

VEHICLE MAKE, MODEL & YEAR	GR-2	Gas-a-Just	MonoMax 56XXXX Series	STRUT & SHOCK	
MARQUE, MODELE ET	Excel-G		AGX 7XXXXX Series	MOUNTS	BOOT KITS
ANNEE DU VEHICULE					
LA MARCA EL MODELO & ANO					

GMC Suburban (3/4 Ton) (2WD) C & R Series

1992-99	C2500	344265	344273	KG5478	KG54100	565060	565033				
1987-91	R2500	344068	344072	KG5409	KG5415	565032	565036				
1973-86	ALL	344068	344072	KG5409	KG5415	565032	565036				
1967-72	ALL	344068		KG5409	KG5416	565032					
1963-66	ALL	344068	344085	KG5409	KG5419	565032	565037				

GMC Suburban (3/4 Ton) (4WD) K & V Series

1992-99	K2500	344266	344262	KG5480	KG54101	565062	565034				
1987-91	V2500 (Exc. w/ Dual Front Shocks)	344067	344072	KG5408	KG5415	565031	565036				
	V2500 w/ Dual Front Shocks - inside shock		344072	KG5477	KG5415	565039	565036				
	V2500 w/ Dual Front Shocks - outside shock	344067	344072	KG5408	KG5415	565031	565036				
1985-86	K2500 w/ Dual Front Shocks - inside shock		344072	KG5477	KG5415	565039	565036				
1980-84	K2500 w/ Dual Front Shocks - inside shock	344075	344072	KG5430	KG5415	565039	565036				
1980-86	K2500 w/ Dual Front Shocks - outside shock	344067	344072	KG5408	KG5415	565031	565036				
1973-86	K2500 (Exc. w/ Dual Front Shocks)	344067	344072	KG5408	KG5415	565031	565036				
1969-72	ALL	344067		KG5408	KG5417	565031					

GMC Suburban (4WD) Steering Stabilizer

1993-98	Complete Kit w/ OE Unit (Cylinder only)	SS15326 SS10317									
1973-92	OEM Replacement Cylinder	SS10325									

GMC Suburban (4WD) Lift Replacement Shocks

1992-99	ALL Lift = 1-3" for Edelbrock # 6360 Lift = 4-6" for Rancho # RS5244 Lift = 4-6" for Rancho # RS9244 Lift = 4-6" for Rancho # RSX17316 Lift = 4-6" for Edelbrock # 63003 Lift = 4-6" for Edelbrock # 6460 Lift = 4-6" for Rancho # RS5227 Lift = 4-6" for Rancho # RS9227 Lift = 4-6" for Rancho # RSX17315 Lift = 4-6"					565073 565086 565092 565092 565086	565061 565093 565087 565093 565093 565093				
---------	--	--	--	--	--	--	--	--	--	--	--

GMC Tracker

1996-98	ALL w/ 4 Wheel ABS	Right Hand	334195	343247		KG4745A			SM5082		
		Left Hand	334196	343247		KG4745A			SM5082		
1989-98	ALL (Exc. ABS)	Right Hand	235035	343247		KG4745A			SM5082		
		Left Hand	235036	343247		KG4745A			SM5082		

GMC Yukon (2WD)

2007-09	ALL (Exc. Electronic, ZW7 Premium Smooth Ride Susp. & Police Package)	341493	345073	551121 ⁷⁰	555054				SM5530 ⁶³		SB129
2001-06	ALL (Exc. Z55 Autoride Susp. or ZW7 Premium Smooth Ride Susp.)	344381	344384	KG54327	KG54341	565067	565103				
	ALL w/ ZW7 Premium Smooth Ride Susp. (Exc. Z55 Autoride Susp.)	341343	SR2003	KG5040							
2000	ALL 4 Door (New Style) (Exc. Z55 Autoride Susp. or Premium Smooth Ride Susp.)	344381	344384	KG54327	KG54341	565067	565103				

⁶³ New Part Number; Available 4th Quarter 2010













⁷⁰ New Part Number; Available 2nd Quarter 2010

Notes de bas de Page 259 - Guia de notas al calce del catalogo Pg. 260

Bold part numbers indicate the most comparable KYB product to the original design & performance.

(22) For vehicles with Electronic Susp., Leveling Control, and Air Suspensions refer to Appendix C.

Applications For Pass. Cars, Light Trucks, SUV's, & Vans

VEHICLE MAKE, MODEL & YEAR	  	STRUT & SHOCK		BOOT KITS	
MARQUE, MODELE ET		MOUNTS			
ANNEE DU VEHICULE					
LA MARCA EL MODELO & ANO					
	 	 	 	 	 

GMC Yukon (2WD) (continued)

2000	ALL 4 Door (New Style) w/ Premium Smooth Ride Susp. (Exc. Z55 Autoride Susp.)	341343	SR2003	KG5040						
	ALL (Old Style)	344265	344273	KG5478	KG54100	565060	565033			
1995-99	4 Door	344265	344273	KG5478	KG54100	565060	565033			
	2 Door	344265	344263	KG5478	KG5479	565060	565061			
	2 Door (Lowered 2" / 4")					565060	565033			

GMC Yukon (4WD)

2007-09	ALL (Exc. Electronic, ZW7 Premium Smooth Ride Susp. & Police Package)	341493	345073	551121 ⁷⁰	555054			SM5530 ⁶³		SB129
2001-06	ALL (Exc. Z55 Autoride Susp. or ZW7 Premium Smooth Ride Susp.)	344381	344384	KG54327	KG54341	565067	565103			
	ALL w/ ZW7 Premium Smooth Ride Susp. (Exc. Z55 Autoride Susp.)	341343	SR2003	KG5040						
2000	ALL 4 Door (New Style) (Exc. Z55 Autoride Susp. or Premium Smooth Ride Susp.)	344381	344384	KG54327	KG54341	565067	565103			
	ALL 4 Door (New Style) w/ Premium Smooth Ride Susp. (Exc. Z55 Autoride Susp.)	341343	SR2003	KG5040						
	ALL 4 Door (Old Style) (Incl. Denali)	344266	344262	KG5480	KG54101	565062	565034			
1995-99	All 4 Door (Incl. Denali)	344266	344262	KG5480	KG54101	565062	565034			
1992-99	ALL 2 Door (Incl. Z-71 Off Road Package)	344266	344263	KG5480	KG5479	565062	565061			

GMC Yukon (4WD) Steering Stabilizer

1993-05	Complete Unit	SS15326								
---------	---------------	---------	--	--	--	--	--	--	--	--

GMC Yukon (4WD) Lift Replacement Shocks

2001-06	Yukon (Exc. Z55 Autoride Susp., Denali or Premium Smooth Ride Susp.) Lift = 1-3"					565076				
1992-99	ALL 2 Door (Incl. Z-71 Off Road Package) Lift = 0-3" for Edelbrock # 6360 Lift = 4-6" for Rancho # RS5244 Lift = 4-6" for Rancho # RS9244 Lift = 4-6" for Rancho # RSX17316 Lift = 4-6" for Edelbrock # 63003 Lift = 4-6" for Edelbrock # 6460 Lift = 4-6" for Rancho # RS5227 Lift = 4-6" for Rancho # RS9227 Lift = 4-6" for Rancho # RSX17315 Lift = 4-6"					565073 565086 565092 565086	565074			
							565087 565087 565087 565087 565087			

GMC Yukon XL 1500 (1/2 Ton) (2WD)

2007-09	ALL (Exc. Electronic & Premium Smooth Ride Susp.)	341493	345073	551121 ⁷⁰	555054			SM5530 ⁶³		
2000-06	ALL (Exc. Z55 Autoride Susp. or ZW7 Premium Smooth Ride Susp.)	344381	344384	KG54327	KG54341	565067	565103			
	ALL w/ ZW7 Premium Smooth Ride Susp. (Exc. Z55 Autoride Susp.)	341343	SR2004	KG5040						

⁶³ New Part Number; Available 4th Quarter 2010













⁷⁰ New Part Number; Available 2nd Quarter 2010

Notes de bas de Page 259 - Guia de notas al calce del catalogo Pg. 260

Bold part numbers indicate the most comparable KYB product to the original design & performance.

(22) For vehicles with Electronic Susp., Leveling Control, and Air Suspensions refer to Appendix C.

Applications For Pass. Cars, Light Trucks, SUV's, & Vans

VEHICLE MAKE, MODEL & YEAR	  	STRUT & SHOCK		BOOT KITS	
MARQUE, MODELE ET		MOUNTS			
ANNEE DU VEHICULE					
LA MARCA EL MODELO & ANO					
	 	 	 	 	 

GMC Yukon XL 1500 (1/2 Ton) (4WD)

2007-09	ALL (Exc. Electronic & Premium Smooth Ride Susp.)	341493	345073	551121 ⁷⁰	555054			SM5530 ⁶³			
2000-06	ALL (Exc. Z55 Autoride Susp. or ZW7 Premium Smooth Ride Susp.)	344381	344384	KG54327	KG54341	565067	565103				
	ALL w/ ZW7 Premium Smooth Ride Susp. (Exc. Z55 Autoride Susp.)	341343	SR2004	KG5040							

GMC Yukon XL 2500 (3/4 Ton) (2WD)

2001-09	ALL w/ Torsion Bar Front Susp. (Exc. Z55 Autoride & QuadraSteer)	344383	344384	KG54340	KG54341	565102	565103				
2000-01	ALL w/ Coil Spring Front Susp. (Exc. Z55 Autoride)	344402	344384	KG54339	KG54341	565101	565103				

GMC Yukon XL 2500 (3/4 Ton) (4WD)

2000-09	ALL (Exc. Z55 Autoride Susp. or QuadraSteer)	344383	344385	KG54340	KG54341	565102	565103				
---------	--	--------	--------	---------	---------	--------	--------	--	--	--	--

GMC Yukon XL (4WD) Steering Stabilizer

2000-05	Complete Unit	SS15326									
---------	---------------	---------	--	--	--	--	--	--	--	--	--

HONDA Accord (also see STRUT-PLUS)

2008	ALL							SM5058	SM5058	SB108	
2007	ALL (Exc. Hybrid) Strut Boot - Exc. Sedan w/ 3.0L Eng. Strut Boot - Sedan w/ 3.0L Eng.	341330	341331					SM5058	SM5058	SB108	SB108 SB107
2006-07	Control Arm Bushing (Strut to Arm)							SM5207			
2005-07	Hybrid	341330	341369					SM5058	SM5058	SB108	SB108
2005-06	ALL (Exc. Hybrid)	341330	341331					SM5058	SM5058	SB108	SB108
2005	Control Arm Bushing (Strut to Arm)							SM5207			
2003-04	ALL Control Arm Bushing (Strut to Arm)	341330	341331					SM5058 SM5207	SM5058	SB108	SB108
1998-02	ALL Control Arm Bushing (Strut to Arm)	341257	341258			741049	741050	SM5058 SM5207	SM5058	SB108	SB107
1994-97	ALL (Incl. Station Wagon) Right Hand Left Hand Mount Plate w/ Insulator Control Arm Bushing (Strut to Arm) Knuckle Shock Bushing Upper Spring Seat Insulator Lower Spring Seat Insulator	341117 341118	341119 341119			741010 741011	741012 741012	SM5058 SM5058 SM5514 SM5207	SM5059 SM5059 SM5515	SB108 SB108	SB107 SB107
1990-93	ALL (Incl. Station Wagon) Right Hand Left Hand Mount Plate w/ Insulator Control Arm Bushing (Strut to Arm) Knuckle Shock Bushing Upper Spring Seat Insulator Lower Spring Seat Insulator	341117 341118	341119 341119			741010 741011	741012 741012	SM5058 SM5058 SM5514 SM5207	SM5059 SM5059 SM5515	SB108 SB108	SB107 SB107
1986-89	ALL Right Hand Left Hand Control Arm Bushing (Strut to Arm) Knuckle Shock Bushing	341072 341073	341074 341074					SM5058 SM5058 SM5209	SM5059 SM5059	SB108 SB108	SB108 SB108
1984-85	ALL Right Hand Left Hand	233019 233020	233021 233021					SM5292 SM5292	SM5059 SM5059	SB103 SB103	SB103 SB103

⁶³ New Part Number; Available 4th Quarter 2010

⁷⁰ New Part Number; Available 2nd Quarter 2010

Notes de bas de Page 259 - Guia de notas al calce del catalogo Pg. 260

Bold part numbers indicate the most comparable KYB product to the original design & performance.
(22) For vehicles with Electronic Susp., Leveling Control, and Air Suspensions refer to Appendix C.

Applications For Pass. Cars, Light Trucks, SUV's, & Vans

VEHICLE MAKE, MODEL & YEAR	GR-2	Gas-a-Just	MonoMax 56XXXX Series	STRUT & SHOCK	
MARQUE, MODELE ET	Excel-G		AGX 7XXXX Series	MOUNTS	BOOT KITS
ANNEE DU VEHICULE					
LA MARCA EL MODELO & AÑO					

HONDA Accord (also see STRUT-PLUS) (continued)

1982-83	ALL	Right Hand Left Hand	233017 233018	233021 233021					SM5292 SM5292	SM5059 SM5059	SB103 SB103	SB103 SB103
1979-81	ALL	Right Hand Left Hand	233009 233010	233011 233012						SM5059 SM5059	SB103 SB103	SB103 SB103
1976-78	ALL	Right Hand Left Hand	233009 233010							SM5059 SM5059	SB103 SB103	SB103 SB103

HONDA Accord - STRUT-PLUS

1994-97	ALL	Right Hand Left Hand	SR4047 ⁶³ SR4048 ⁶³	SR4049 ⁶³ SR4050 ⁶³								
1990-93	ALL	Right Hand Left Hand	SR4043 SR4044	SR4045 SR4046								

HONDA Civic (also see STRUT-PLUS)

2006-10	ALL (Exc. Si Model)	Right Hand Left Hand	339035 339036	343460 343460								
2003-05	ALL (Exc. Hybrid) Hybrid Hatchback Sedan & Coupe	Right Hand Left Hand Right Hand Left Hand	331010 331011 331008 331009	341362 341362 341362 341362					SM5402 SM5402 SM5403 SM5402	SM5400 SM5400 SM5401 SM5400	SB103 SB103 SB103 SB103	SB108 SB108 SB108 SB108
2002	ALL (Exc. Si Model) Si Model	Right Hand Left Hand Right Hand Left Hand	331008 331009 331010 331011	341311 341311 341311 341311		731003 731004	741060 741060 741060 741060		SM5402 SM5402 SM5403 SM5403	SM5400 SM5400 SM5401 SM5401	SB103 SB103 SB103 SB103	SB108 SB108 SB108 SB108
2001	ALL (Exc. Si Model)	Right Hand Left Hand	331008 331009	341311 341311		731003 731004	741060 741060		SM5403 SM5403	SM5400 SM5400	SB103 SB103	SB108 SB108
1996-00	ALL Control Arm Bushing (Strut to Arm) Mount Plate w/ Insulator Upper Spring Seat Insulator		341203	341198		741023	741024		SM5058 SM5210 SM5527	SM5058 SM5516 SM5208 SM5528	SB108	SB108
1992-00	Mount Plate w/ Insulator								SM5538 ⁶³			
1992-95	ALL Control Arm Bushing (Strut to Arm) Mount Plate w/ Insulator Upper Spring Seat Insulator	Right Hand Left Hand	341138 341139	341094 341094		741005 741006	741007 741007		SM5058 SM5058 SM5210 SM5527	SM5058 SM5058 SM5166 SM5516 SM5528	SB108 SB108	SB108 SB108
1989-91	ALL (Exc. Station Wagon) Control Arm Bushing (Strut to Arm)	Right Hand Left Hand	341135 341136	341094 341094		741008 741009	741007 741007		SM5058 SM5058	SM5058 SM5058 SM5166	SB108 SB108	SB108 SB108
1988	ALL (Exc. Station Wagon) Knuckle Shock Bushing	Right Hand Left Hand	341135 341136	340008 ² 340008 ²		741008 741009			SM5058 SM5058	SM5058 SM5058 SM5051	SB108 SB108	
1984-87	ALL (Exc. Station Wagon) S/W - 2WD (Includes WagoVan)	Right Hand Left Hand Right Hand Left Hand	234010 234011 234020 234021	341050 ² 341050 ² 340001 ² 340001 ²					SM5293 SM5293 SM5293 SM5293	SM5059 SM5059 SM5059 SM5059	SB103 SB103	SB103 SB103
1980-83	1300,1500 CVCC (Exc. Station Wagon) 1500 CVCC Station Wagon	Right Hand Left Hand	231010 231010	231011 231012						SM5059 SM5059	SB103 SB103	SB103 SB103
1976-79	1500 CVCC Station Wagon			343030		KG4006					SB103	

² The KYB replacement unit comes with a new dustcover/ bumper assembly.













⁶³ New Part Number; Available 4th Quarter 2010

Notes de bas de Page 259 - Guia de notas al calce del catalogo Pg. 260

Bold part numbers indicate the most comparable KYB product to the original design & performance.

(22) For vehicles with Electronic Susp., Leveling Control, and Air Suspensions refer to Appendix C.

Applications For Pass. Cars, Light Trucks, SUV's, & Vans

VEHICLE MAKE, MODEL & YEAR	  	STRUT & SHOCK		BOOT KITS	
MARQUE, MODELE ET		MOUNTS			
ANNEE DU VEHICULE					
LA MARCA EL MODELO & ANO					
	 	 	 	 	 

HONDA Civic (also see STRUT-PLUS) (continued)

1975	1200 Station Wagon w/ Sealed Strut		343030		KG4006						SB103	
	1500 CVCC Station Wagon w/ Sealed Strut		343030		KG4006						SB103	

HONDA Civic - STRUT-PLUS

1996-00	ALL	Right Hand		SR4042 ⁶³								
		Left Hand		SR4042 ⁶³								

HONDA CR-V

2007-09	ALL			341492 ⁶⁸						SM5400		SB108
2005-06	ALL	Right Hand	331037	341463						SM5403	SM5400	SB104
		Left Hand	331038	341463						SM5403	SM5400	SB104
2002-04	ALL	Right Hand	331035	341488						SM5403	SM5400	SB104
		Left Hand	331036	341488						SM5403	SM5400	SB104
1997-01	ALL		341260	341261						SM5058	SM5058	SB108
	Mount Plate w/ Insulator									SM5538 ⁶³		
	Upper Spring Seat Insulator									SM5527	SM5528	

HONDA CRX

1989-91	ALL	Right Hand	341135	341094			741008	741007	SM5058	SM5058	SB108	SB108
		Left Hand	341136	341094			741009	741007	SM5058	SM5058	SB108	SB108
	Control Arm Bushing (Strut to Arm)									SM5166		
1988	ALL	Right Hand	341135	340008 ²			741008		SM5058	SM5058	SB108	
		Left Hand	341136	340008 ²			741009		SM5058	SM5058	SB108	
1984-87	ALL	Right Hand	234010	341050 ²					SM5293	SM5059	SB103	
		Left Hand	234011	341050 ²					SM5293	SM5059	SB103	

HONDA Del Sol

1993-97	Mount Plate w/ Insulator								SM5538 ⁶³			
1992-97	ALL	Right Hand	341138	341094			741005	741007	SM5058	SM5058	SB108	SB108
		Left Hand	341139	341094			741006	741007	SM5058	SM5058	SB108	SB108
	Control Arm Bushing (Strut to Arm)								SM5210			
	Mount Plate w/ Insulator									SM5166		
	Upper Spring Seat Insulator								SM5527	SM5528		

HONDA Element

2007-10	EX & LX Models	Right Hand		344611					SM5403	SM5400	SB104	SB108
		Left Hand		344611					SM5403	SM5400	SB104	SB108
2003-06	ALL	Right Hand	331039	344611					SM5403	SM5400	SB104	SB108
		Left Hand	331040	344611					SM5403	SM5400	SB104	SB108

HONDA Fit

2007-08	ALL (Exc. Sport)	Right Hand	333474	343487								
		Left Hand	333475	343487								

HONDA Insight





2000-06	ALL		NA	NA								SB102
---------	-----	--	----	----	--	--	--	--	--	--	--	-------

² The KYB replacement unit comes with a new dustcover/ bumper assembly.

⁶³ New Part Number; Available 4th Quarter 2010

⁶⁸ New Part Number; Available 3rd Quarter 2010

Applications For Pass. Cars, Light Trucks, SUV's, & Vans

VEHICLE MAKE, MODEL & YEAR		GR-2 <i>Excel-G</i>		Gas-a-Just		MonoMax 56XXXX Series AGX 7XXXXX Series		STRUT & SHOCK MOUNTS		BOOT KITS	
MARQUE, MODELE ET ANNEE DU VEHICULE											
LA MARCA EL MODELO & AÑO											

HONDA Odyssey

2005-08	ALL		349091 ⁶³					SM5537 ⁶³		SB105	
1999-04	ALL	Right Hand	334317	344353				SM5211		SB105	
		Left Hand	334318	344353				SM5211		SB105	
1995-98	ALL	Right Hand	341200	344274				SM5058	SM5058	SB108	SB107
		Left Hand	341201	344274				SM5058	SM5058	SB108	SB107
	Control Arm Bushing (Strut to Arm)							SM5207			
	Lower Shock Bushing								SM5224		
	Mount Plate w/ Insulator							SM5514			
	Upper Spring Seat Insulator							SM5486			

HONDA Passport

1998-02	ALL		344298	344299	KG54337	KG54338					
1994-97	ALL		344430		KG5476	KG5534					

HONDA Pilot

2003-08	ALL	Right Hand	334364	344353				SM5211		SB104	
		Left Hand	334365	344353				SM5211		SB104	

HONDA Prelude

1997-01	ALL (Exc. Type SH)	Right Hand	341177	341179			741030	741032	SM5058	SM5059	SB108	SB108
		Left Hand	341178	341179			741031	741032	SM5058	SM5059	SB108	SB108
	Control Arm Bushing (Strut to Arm)							SM5207				
	Upper Spring Seat Insulator							SM5486	SM5209	SM5360		
1992-96	ALL	Right Hand	341177	341179			741030	741032	SM5058	SM5059	SB108	SB108
		Left Hand	341178	341179			741031	741032	SM5058	SM5059	SB108	SB108
	Control Arm Bushing (Strut to Arm)							SM5207				
	Upper Spring Seat Insulator							SM5486	SM5209	SM5360		
1988-91	ALL	Right Hand	341072						SM5058	SM5291	SB108	
		Left Hand	341073						SM5058	SM5291	SB108	
	Control Arm Bushing (Strut to Arm)							SM5209	SM5209			
1984-87	ALL	Right Hand	340002 ²	234022					SM5058	SM5059		SB103
		Left Hand	340002 ²	234023					SM5058	SM5059		SB103
1983	ALL		340002 ²	233021					SM5058	SM5059		SB103
1979-82	ALL		363058							SM5059	SB103	

HONDA Ridgeline

2009-10	ALL	Right Hand	339039									
		Left Hand	339040									
2006-08	ALL	Right Hand	339039	341402							SB105	SB107
		Left Hand	339040	341402							SB105	SB107

HONDA S2000

2000-08	ALL								SM5401	SM5401	SB108	SB108
	Mount Plate w/ Insulator								SM5538 ⁶³	SM5538 ⁶³		
	Upper Spring Seat Insulator								SM5527			











HUMMER H2

2003-07	ALL				KG5782	KG5194	565102	565095				
---------	-----	--	--	--	--------	--------	--------	--------	--	--	--	--

² The KYB replacement unit comes with a new dustcover/ bumper assembly.

⁶³ New Part Number; Available 4th Quarter 2010

Applications For Pass. Cars, Light Trucks, SUV's, & Vans

VEHICLE MAKE, MODEL & YEAR		GR-2		Gas-a-Just		MonoMax 56XXXX Series		STRUT & SHOCK			
MARQUE, MODELE ET		Excel-G				AGX 7XXXXX Series		MOUNTS		BOOT KITS	
ANNEE DU VEHICULE		 		 		 		 		 	
LA MARCA EL MODELO & ANO											

HUMMER H3

2006-08	ALL			555049	555050						
---------	-----	--	--	--------	--------	--	--	--	--	--	--

HYUNDAI Accent

2006-10	ALL (Exc. SE)	Right Hand Left Hand	333516 333517	348002 348002							
2003-05	ALL	Right Hand Left Hand	333497 333498	332135 ⁶⁸ 332136 ⁶⁸							
2000-02	ALL	Right Hand Left Hand	333304 333305	332108 332109				SM5201 SM5201		SB103 SB103	SB110 SB110
5/97-99	ALL	Right Hand Left Hand	333211 333212	332094 332095				SM5149 SM5149	SM5148 SM5148	SB101 SB101	SB103 SB103
1995-4/97	ALL	Right Hand Left Hand	333211 333212	332080 332081				SM5149 SM5149	SM5148 SM5148	SB101 SB101	SB103 SB103

HYUNDAI Azera

2006-08	Strut Boot									SB101	
---------	------------	--	--	--	--	--	--	--	--	-------	--

HYUNDAI Elantra

2009-10	ALL (Exc. Touring)			349085							
2007-08	ALL (Exc. Touring)	Right Hand Left Hand	333803 ⁶³ 333804 ⁶³	349085 349085						SB101 SB101	
	ALL w/ Touring Suspension	Right Hand Left Hand	333803 ⁶³ 333804 ⁶³							SB101 SB101	
7/00-06	ALL	Right Hand Left Hand	333205 333206	333500 333501			733020 733021	SM5193 SM5193	SM5240 SM5239	SB101 SB101	SB103 SB103
1996-6/00	ALL	Right Hand Left Hand	333205 333206	333207 333208			733020 733021	SM5193 SM5193	SM5240 SM5239	SB101 SB101	SB103 SB103
1992-95	ALL		235033	341084				SM5063	SM5091	SB101	SB103

HYUNDAI Entourage

2007-08	Strut Mount & Bearing							SM5539 ⁶³			
---------	-----------------------	--	--	--	--	--	--	----------------------	--	--	--

HYUNDAI Excel

1990-94	ALL		234043			KG4192		SM5060		SB116	
1989	ALL		365074			KG4192		SM5032		SB103	
1986-88	ALL		365027			KG4192		SM5032		SB103	

HYUNDAI Pony (Canadian Vehicle)

1984-87	ALL		343030			KG4006				SB103	
---------	-----	--	--------	--	--	--------	--	--	--	-------	--

HYUNDAI Santa Fe

2007-10	Strut Mount & Bearing							SM5539 ⁶³			
2007-09	ALL	Right Hand Left Hand	334506 334507	344500 344500						SB105 SB105	
2001-06	ALL	Right Hand Left Hand	334500 334501	344314 344314				SM5295 SM5295	SM5296 SM5296	SB102 SB105	SB108 SB108
	Strut Boot w/ 3.5L Eng.										
	Strut Boot w/o 3.5 L. Eng.										

⁶³ New Part Number; Available 4th Quarter 2010

⁶⁸ New Part Number; Available 3rd Quarter 2010

Applications For Pass. Cars, Light Trucks, SUV's, & Vans

VEHICLE MAKE, MODEL & YEAR	GR-2		Gas-a-Just		MonoMax 56XXXX Series		STRUT & SHOCK			
MARQUE, MODELE ET	Excel-G				AGX		MOUNTS		BOOT KITS	
ANNEE DU VEHICULE					7XXXXX Series					
LA MARCA EL MODELO & ANO										

HYUNDAI Scoupe

1991-95	ALL		234043			KG4192			SM5060		SB116	
---------	-----	--	--------	--	--	--------	--	--	--------	--	-------	--

HYUNDAI Sonata

2006-08	3.3L		341476	349060								
10/04-05	ALL (From 10/14/04)		341477	341478								
4/00-10/04	ALL (To 10/14/04)		341280	341281					SM5091	SM5091	SB101	SB101
1999-3/00	ALL		341245	341246					SM5091	SM5200	SB101	SB101
1995-98	ALL		334141	341192					SM5194	SM5294	SB101	SB101
1989-94	ALL (Exc. ABS)		235027			KG9011			SM5195	SM5294	SB101	

HYUNDAI Tiburon

2003-08	ALL	Right Hand	333508	333510						SM5240	SB103	SB101
		Left Hand	333509	333511						SM5239	SB103	SB101
1997-01	ALL	Right Hand	333205	333207			733020	733022	SM5193	SM5240	SB103	SB101
		Left Hand	333206	333208			733021	733023	SM5193	SM5239	SB103	SB101

HYUNDAI Tucson

2005-10	ALL	Right Hand	334502	334504					SM5295	SM5240	SB105	SB105
		Left Hand	334503	334505					SM5295	SM5240	SB105	SB105

HYUNDAI Veracruz

2007-09	Strut Mount & Bearing								SM5539 ⁶³			
2007-08	Strut Boot										SB102	

HYUNDAI XG300, XG350

2001-05	ALL		341280	341281					SM5091	SM5091	SB101	SB101
---------	-----	--	--------	--------	--	--	--	--	--------	--------	-------	-------

INFINITI FX35

2003-08	ALL	Right Hand	339055	349027							SB105	SB103
		Left Hand	339056	349027							SB105	SB103

INFINITI FX45

2003-08	ALL	Right Hand	339055	349027							SB105	SB103
		Left Hand	339056	349027							SB105	SB103

INFINITI G20

1999-02	ALL		341120	341194			741029	741021	SM5123	SM5123	SB101	SB108
1991-96	ALL	Right Hand	341120	235061			741029	734008	SM5123	SM5204	SB101	SB101
		Left Hand	341120	235062			741029	734009	SM5123	SM5204	SB101	SB101













INFINITI G35

2007	AWD	Right Hand	340010 ⁶⁸	349089 ⁶⁸								
		Left Hand	340011 ⁶⁸	349089 ⁶⁸								
	Strut Mount w/ Insulator (Coupe)								SM5542 ⁶³			
	Upper Spring Seat Insulator (Coupe)								SM5560 ⁶³			
2005-06	AWD	Right Hand	341379	344492						SM5482	SB103	SB108
		Left Hand	341380	344492						SM5482	SB103	SB108
	Coupe w/ Sport Susp.	Right Hand	341366	344455						SM5542 ⁶³	SM5482	SB101
		Left Hand	341367	344455						SM5542 ⁶³	SM5482	SB101
	Upper Spring Seat Insulator								SM5560 ⁶³			

⁶³ New Part Number; Available 4th Quarter 2010

⁶⁸ New Part Number; Available 3rd Quarter 2010

Applications For Pass. Cars, Light Trucks, SUV's, & Vans

VEHICLE MAKE, MODEL & YEAR	  	STRUT & SHOCK		BOOT KITS	
MARQUE, MODELE ET		MOUNTS			
ANNEE DU VEHICULE					
LA MARCA EL MODELO & ANO					
	 	 	 	 	 

INFINITI G35 (continued)

2003-06	Coupe (Exc. Sport Susp.)	Right Hand	341377	344491					SM5542 ⁶³	SM5482	SB101	SB108
		Left Hand	341378	344491					SM5542 ⁶³	SM5482	SB101	SB108
	Sedan (RWD)	Right Hand	341377	344491					SM5542 ⁶³	SM5482	SB101	SB108
		Left Hand	341378	344491					SM5542 ⁶³	SM5482	SB101	SB108
	Upper Spring Seat Insulator							SM5560 ⁶³				
2003-04	Coupe w/ Sport Susp.	Right Hand	341366	344455					SM5542 ⁶³	SM5482	SB101	SB108
		Left Hand	341367	344455					SM5542 ⁶³	SM5482	SB101	SB108
	Upper Spring Seat Insulator							SM5560 ⁶³				

INFINITI I30

2000-01	ALL	Right Hand	334265	341271					SM5409	SM5217	SB104	SB108
		Left Hand	334266	341271					SM5409	SM5217	SB104	SB108
1996-99	ALL	Right Hand	334150	341202			734017	741039	SM5324	SM5123	SB104	SB108
		Left Hand	334151	341202			734018	741039	SM5324	SM5123	SB104	SB108
	Strut Mount w/ Bearing Strut Mount Bearing								SM5122 SM5323			

INFINITI I35

2002-04	ALL (Exc. Sport Susp.)	Right Hand	334366	341341					SM5409	SM5217	SB104	SB108
		Left Hand	334367	341341					SM5409	SM5217	SB104	SB108

INFINITI M35

2008	RWD (Exc. Sport Susp.)	Right Hand		349053						SM5482		
		Left Hand		349053						SM5482		
2006-07	RWD (Exc. Sport Susp.)	Right Hand	341441	349053						SM5482		
		Left Hand	341442	349053						SM5482		

INFINITI M45

2008	ALL (Exc. Sport Susp.)	Right Hand		349053						SM5482		
		Left Hand		349053						SM5482		
2006-07	ALL (Exc. Sport Susp.)	Right Hand	341441	349053						SM5482		
		Left Hand	341442	349053						SM5482		

INFINITI Q45

1997-01	Sturt Mounting Kit (Exc. Touring)								SM5328	SM5123	SB101	SB101
1990-96	Strut / Shock Mount								SM5324	SM5123	SB101	

INFINITI QX4

2002-03	2WD	Right Hand	335035	343379		KG4163			SM5203		SB129	
		Left Hand	335036	343379		KG4163			SM5203		SB129	
	4WD	Right Hand	335032	343379		KG4163			SM5203		SB129	
		Left Hand	335033	343379		KG4163			SM5203		SB129	
12/98-01	ALL	Right Hand	335030	343379		KG4163			SM5203		SB129	
		Left Hand	335031	343379		KG4163			SM5203		SB129	
1997-03	Strut Mount, Bearing & Boot kit Strut Mount Bearing								SM5329 SM5323			
1997-11/98	ALL	Right Hand	335015	343388		KG54318			SM5203		SB129	
		Left Hand	335016	343388		KG54318			SM5203		SB129	











INFINITI QX56

2004-07	ALL (Exc. Auto Rear Leveling)		341600	NA								
---------	-------------------------------	--	--------	----	--	--	--	--	--	--	--	--

⁶³ New Part Number; Available 4th Quarter 2010

Notes de bas de Page 259 - Guia de notas al calce del catalogo Pg. 260
 Bold part numbers indicate the most comparable KYB product to the original design & performance.
 (22) For vehicles with Electronic Susp., Leveling Control, and Air Suspensions refer to Appendix C.

Applications For Pass. Cars, Light Trucks, SUV's, & Vans

VEHICLE MAKE, MODEL & YEAR	GR-2	Gas-a-Just	MonoMax 56XXXX Series	STRUT & SHOCK	
MARQUE, MODELE ET	Excel-G		AGX 7XXXXX Series	MOUNTS	BOOT KITS
ANNEE DU VEHICULE	 	 	 	 	 
LA MARCA EL MODELO & AÑO					

INTERNATIONAL Scout, Scout II (Incl. Traveler and Terra)

1971-80	ALL	344071	344085	KG5414	KG5419						
---------	-----	--------	--------	--------	--------	--	--	--	--	--	--

ISUZU Amigo

1998-00	ALL	344298	344299	KG54337	KG54338						
1989-95	ALL	344430	344090	KG5476	KG5466						

ISUZU Ascender

2007-08	ALL		343395		KG4162						
2003-08	Strut Boot Mount w/ Spring Insulator							SM5395			SB108
2003-06	ALL	331016 ⁸¹	343395		KG4162						
2003-04	Lower Spring Seat Insulator							SM5548 ⁶³			

ISUZU Axiom

2002-04	ALL (Exc. Electronic Susp.)	344298	344299	KG54337	KG54338						
---------	-----------------------------	--------	--------	---------	---------	--	--	--	--	--	--

ISUZU Hombre (2WD)

1996-00	ALL ALL (Lowered 2" / 4")	344040	344041	KG5450	KG5451	565046 565046	565047 565064				
---------	------------------------------	--------	--------	--------	--------	------------------	------------------	--	--	--	--

ISUZU Hombre (4WD)

1996-00	ALL	344042	344041	KG5452	KG5451	565048	565047				
---------	-----	--------	--------	--------	--------	--------	--------	--	--	--	--

ISUZU I-280

2006	2WD	341374	344464		KG5191						
------	-----	--------	--------	--	--------	--	--	--	--	--	--

ISUZU I-290

2007	2WD	341374	344464		KG5191						
------	-----	--------	--------	--	--------	--	--	--	--	--	--

ISUZU I-350

2006	4WD	344465	344466	KG5781	KG5190						
------	-----	--------	--------	--------	--------	--	--	--	--	--	--

ISUZU I-370

2007	ALL	344465	344466	KG5781	KG5190						
------	-----	--------	--------	--------	--------	--	--	--	--	--	--

ISUZU I-Mark

1985-91	ALL (Exc. Lotus Susp.)	Right Hand	232015		KG4542			SM5297			SB102
		Left Hand	232016		KG4542			SM5297			SB102
	ALL w/ Lotus Susp.	Right Hand	232015					SM5297			SB102
		Left Hand	232016					SM5297			SB102
1981-84	ALL			KG4773A	KG4772A						

ISUZU Impulse

1990-92	2WD w/ Lotus Susp.	Right Hand	234041	332076				SM5081	SM5105	SB102	SB101
		Left Hand	234042	332077				SM5081	SM5105	SB102	SB101
	ALL (Exc. Lotus Susp. & Exc. 4WD)	Right Hand	234041	232033				SM5081	SM5105	SB102	SB105
		Left Hand	234042	232034				SM5081	SM5105	SB102	SB105
	AWD	Right Hand	234041					SM5081	SM5105	SB102	SB101
		Left Hand	234042					SM5081	SM5105	SB102	SB101
1983-89	ALL (Exc. RS Model)		343039	KG4773A	KG5552						

⁶³ New Part Number; Available 4th Quarter 2010













⁸¹ When [331016] stock is depleted, use [331043]

Notes de bas de Page 259 - Guia de notas al calce del catalogo Pg. 260

Bold part numbers indicate the most comparable KYB product to the original design & performance.

(22) For vehicles with Electronic Susp., Leveling Control, and Air Suspensions refer to Appendix C.

Applications For Pass. Cars, Light Trucks, SUV's, & Vans

VEHICLE MAKE, MODEL & YEAR	  	STRUT & SHOCK		BOOT KITS	
MARQUE, MODELE ET		MOUNTS			
ANNEE DU VEHICULE					
LA MARCA EL MODELO & ANO					
	 	 	 	 	 

ISUZU Oasis Van

1995-99	ALL	Right Hand Left Hand	341200 341201	344274 344274					SM5058 SM5058 SM5207 SM5514 SM5486	SM5058 SM5058 SM5224	SB108 SB108	SB107 SB107
		Control Arm Bushing (Strut to Arm) Lower Shock Bushing Mount Plate w/ Insulator Upper Spring Seat Insulator										

ISUZU Pickup (2WD)

1988-95	ALL		343208	344090	KG4605A	KG5466	565029					
8/86-87	ALL		343208	344015	KG4605A	KG4026						
1981-7/86	ALL			344015	KG4625C	KG4026						

ISUZU Pickup (4WD)

1988-95	ALL		344098	344090	KG5476	KG5466						
1981-87	ALL			344015	KG4613A	KG4026						

ISUZU Rodeo

1998-04	ALL (Exc. Active Susp.)		344298	344299	KG54337	KG54338						
1991-97	ALL		344430		KG5476	KG5534						

ISUZU Stylus

1990-93	ALL (Exc. Lotus Susp.)	Right Hand Left Hand	234041 234042	232033 232034					SM5081 SM5081	SM5105 SM5105	SB102 SB102	SB105 SB105
	ALL w/ Lotus Susp.	Right Hand Left Hand	234041 234042	332076 332077					SM5081 SM5081	SM5105 SM5105	SB102 SB102	SB105 SB105

ISUZU Trooper

1992-02	ALL				KG54304	KG54308	565022	565023				
1989-91	ALL		344430		KG5476	KG5534						
11/86-88	ALL				KG4613A	KG5534						
1981-10/86	ALL			344015	KG4613A	KG4026						

ISUZU Trooper (4WD) - Steering Stabilizer

1984-91	Trooper II 4WD Complete Kit		SS15345									
---------	--------------------------------	--	---------	--	--	--	--	--	--	--	--	--

ISUZU Vehicross

1999-01	ALL				KG54304	KG54308	565022	565023				
---------	-----	--	--	--	---------	---------	--------	--------	--	--	--	--

JAGUAR S-Type

2000-07	Strut Mount w/ Insulator Mount w/ Insulator & Boot Upper Spring Seat w/ Insulator								SM5449 SM5450 SM5359	SM5449 SM5450 SM5359		
2000-05	ALL (Exc. Computer Active Technology Susp. (CATS))		551609 ⁶³	551610 ⁶³								











JAGUAR X-Type

2002-08	Strut / Shock Boot Upper Spring Seat w/ Insulator									SM5357	SB108	
---------	--	--	--	--	--	--	--	--	--	--------	-------	--

⁶³ New Part Number; Available 4th Quarter 2010

Notes de bas de Page 259 - Guia de notas al calce del catalogo Pg. 260
 Bold part numbers indicate the most comparable KYB product to the original design & performance.
 (22) For vehicles with Electronic Susp., Leveling Control, and Air Suspensions refer to Appendix C.

Applications For Pass. Cars, Light Trucks, SUV's, & Vans

VEHICLE MAKE, MODEL & YEAR	<i>GR-2</i> <i>Excel-G</i>	<i>Gas-a-Just</i>	<i>MonoMax</i> 56XXXX Series <i>AGX</i> 7XXXXX Series	STRUT & SHOCK MOUNTS	BOOT KITS
MARQUE, MODELE ET ANNEE DU VEHICULE	 	 	 	 	 
LA MARCA EL MODELO & ANO					

JAGUAR XJ8

1998-04	ALL			KG5783	KG6796					
1998-03	Spring Seat Insulator								SM5358	

JAGUAR XK8

1997-06	Coupe & Convertible									SB101
1997-04	Spring Seat Insulator (XK Coupe & Convertible)								SM5358	
1997-02	ALL				KG6798					

JAGUAR XKR

2000-06	Coupe & Convertible Spring Seat Insulator (XK Coupe & Convertible)								SM5358	SB101
2000-02	ALL				KG6798					

JAGUAR XJ6, XJ12, XJS, Sovereign, Vandenplas, MK II

1998-03	Spring Seat Insulator (XJR, Vanden Plas)								SM5358	
1995-97	Spring Seat Insulator (XJ6, XJ12, XJR, Vanden Plas)								SM5358	
12/94-97	XJ6, XJ12			KG4730	KG6797					
1987-95	XJ-S Model (4 Units Required on Rear)			KG4540	KG9122 ²					
10/86-9/94	XJ6, Sovereign, VandenPlas (Exc. Self Leveling Rear Susp.) XJ6, Sovereign, VandenPlas w/ Self Leveling Rear Susp. (Conversion Kit)			KG9135	KG9309 KG9309 ²⁶ KIT109 ²⁶					
1968-87	XJ6, XJ12, XJS (4 Units Required on Rear)			KG4540	KG9122 ²					
1962-66	MK II Series Pass.Car		343219		KG5517					

JEEP CJ Series

1982-86	CJ5, CJ7	344087	344085	KG5426	KG5419		565037			
1964-68	CJ5A, CJ6A (Exc. w/ 5 Leaf Front Spring)	344426	344085	KG5401	KG5419		565037			
	CJ5A, CJ6A w/ 5 Leaf Front Spring	344426	344426	KG5401	KG5401					
1955-81	CJ5, CJ6, CJ7 (Exc. w/ 5 Leaf Front Spring)	344426	344085	KG5401	KG5419		565037			
1955-71	CJ5, CJ6 w/ 5 Leaf Front Springs	344426	344426	KG5401	KG5401					
1945-65	CJ2A, 3A, 3B Series	344426	344426	KG5401	KG5401					

JEEP CJ - Steering Stabilizer

1976-86	OEM Replacement Cylinder	SS10316								
1942-86	Complete Kit	SS15345								









JEEP Cherokee

1997-01	ALL (101" W.B.)	344088	344089	KG5464	KG5465	565053	565054			
1984-96	ALL (101" W.B.)	344088	344418	KG5464	KG5465	565053	565054			
1976-83	ALL	344087	344085	KG5426	KG5419		565037			
1974-75	ALL	344087		KG5426						

² The KYB replacement unit comes with a new dustcover/ bumper assembly.

²⁶ Jaguar Rear Self-Leveling can be eliminated by using PN [KG9309] (2 req) and PN KIT109 (1. req) Worn-out self-leveling shocks may have fatigued rear springs. If necessary, Jaguar #JLM-11382 (from Jaguar) is required to restore proper ride height.

Applications For Pass. Cars, Light Trucks, SUV's, & Vans

VEHICLE MAKE, MODEL & YEAR	  	STRUT & SHOCK		BOOT KITS	
MARQUE, MODELE ET		MOUNTS			
ANNEE DU VEHICULE					
LA MARCA EL MODELO & ANO					
	 	 	 	 	 

JEEP Cherokee - Steering Stabilizer

1984-01	2WD & 4WD OEM Replacement Cylinder DANA #30 fits axles up to 2 3/4" diameter Complete Kit	SS10317									
		SS15345									

JEEP Comanche

1987-92	2WD	344088	344090	KG5464	KG5466	565053					
1986-92	4WD	344088	344090	KG5464	KG5466	565053					
1986	2WD	344088	344015	KG5464	KG4026	565053					

JEEP Comanche - Steering Stabilizer

1986-92	Replacement Unit	SS10317									
---------	------------------	---------	--	--	--	--	--	--	--	--	--

JEEP Commander

2010	ALL	341603									
2009	ALL	341603						SM5511			
2006-08	ALL	341603	344496					SM5511			

JEEP Compass

2010	ALL	Right Hand	334642	341654							
		Left Hand	334643	341654							
2007-09	ALL	Right Hand	334642	341654						SB101	SB107
		Left Hand	334643	341654						SB101	SB107

JEEP DJ Dispatcher

1965-74	DJ5, DJ6	344426	344085	KG5401	KG5419		565037				
1956-64	DJ3A	344426	344426	KG5401	KG5401						

JEEP DJ5 - Steering Stabilizer

1976-85	DJ5-A Mail Truck - 1/4 Ton - OEM Replacement Cylinder	SS10316									
---------	---	---------	--	--	--	--	--	--	--	--	--

JEEP Grand Cherokee

2009-10	ALL	341603						SM5511			
2005-08	ALL	341603	344496					SM5511			
1999-04	ALL (Exc. Up Country Susp.)	344341	344342	KG5744	KG5197	565106	565107				
	ALL w/ Up Country Susp.			555606	555607						
1992-98	ALL (Exc. Up Country Susp.)	344088	344396	KG5464	KG5487	565053	565011				

JEEP Grand Cherokee - Steering Stabilizer











1993-06	2WD & 4WD OEM Replacement Cylinder	SS10317									
---------	------------------------------------	---------	--	--	--	--	--	--	--	--	--

JEEP Grand Wagoneer

1993	ALL (Exc. Up Country Susp.)	344088	344396	KG5464	KG5487	565053	565011				
1984-91	ALL	344087	344085	KG5426	KG5419		565037				

Notes de bas de Page 259 - Guia de notas al calce del catalogo Pg. 260
 Bold part numbers indicate the most comparable KYB product to the original design & performance.
 (22) For vehicles with Electronic Susp., Leveling Control, and Air Suspensions refer to Appendix C.

Applications For Pass. Cars, Light Trucks, SUV's, & Vans

VEHICLE MAKE, MODEL & YEAR	<i>GR-2</i> <i>Excel-G</i>	<i>Gas-a-Just</i>	<i>MonoMax</i> 56XXXX Series <i>AGX</i> 7XXXX Series	STRUT & SHOCK MOUNTS	BOOT KITS
MARQUE, MODELE ET ANNEE DU VEHICULE	 	 	 	 	 
LA MARCA EL MODELO & ANO					

JEEP J-10, J-20

1974-90	ALL	344087	344085	KG5426	KG5419		565037				
---------	-----	--------	--------	--------	--------	--	--------	--	--	--	--

JEEP Jeepster - Steering Stabilizer

1966-73	Complete Kit	SS15345									
---------	--------------	---------	--	--	--	--	--	--	--	--	--

JEEP Liberty

2002-10	ALL	Right Hand	331017	344404		KG5039			SM5386		
		Left Hand	331017	344404		KG5039			SM5387		
	Upper / Lower Spring Seat Insulator								SM5421		

JEEP Military Jeep

1941-53	Military MA, MB, MC Series	344426	344426	KG5401	KG5401						
---------	----------------------------	--------	--------	--------	--------	--	--	--	--	--	--

JEEP Patriot

2010	ALL	Right Hand	334642	341654							
		Left Hand	334643	341654							
2007-09	ALL	Right Hand	334642	341654						SB101	SB107
		Left Hand	334643	341654						SB101	SB107

JEEP Scrambler

1982-86	ALL	344087	344085	KG5426	KG5419		565037				
1981	ALL	344426	344085	KG5401	KG5419		565037				

JEEP Scrambler - Steering Stabilizer

1981-86	Complete Kit	SS15345									
	OEM Replacement Cylinder	SS10316									

JEEP TJ (Canadian Vehicle)

1996-05	ALL	344435	344403	KG54323	KG54324	565020	565021				
---------	-----	--------	--------	---------	---------	--------	--------	--	--	--	--

JEEP TJ - Steering Stabilizers

1996-05	DANA #30 fits axles up to 2 3/4" diameter	SS15345									
	Complete Kit										
	Replacement Unit	SS10317									

JEEP Universal (CJ, DJ-Postal Dispatcher)









1961-65	CJ2A, 3A, 3B Series	344426	344426	KG5401	KG5401						
1961-67	CJ5, CJ6, CJ7 (Exc. w/ 5 Leaf Front Spring)	344426	344085	KG5401	KG5419		565037				
	CJ5, CJ6 w/ 5 Leaf Front Springs	344426	344426	KG5401	KG5401						
1964-67	CJ5A, CJ6A (Exc. w/ 5 Leaf Front Spring)	344426	344085	KG5401	KG5419		565037				
	CJ5A, CJ6A w/ 5 Leaf Front Spring	344426	344426	KG5401	KG5401						
1965-67	DJ5, DJ6	344426	344085	KG5401	KG5419		565037				
1961-64	Dispatcher DJ3A Series	344426	344426	KG5401	KG5401						

JEEP Wagoneer

1984-90	ALL (101" W.B.)	344088	344418	KG5464	KG5465	565053	565054				
1976-83	ALL	344087	344085	KG5426	KG5419		565037				
1974-75	ALL	344087		KG5426							
1966-73	ALL	344426	344426	KG5401	KG5401						

Notes de bas de Page 259 - Guia de notas al calce del catalogo Pg. 260
 Bold part numbers indicate the most comparable KYB product to the original design & performance.
 (22) For vehicles with Electronic Susp., Leveling Control, and Air Suspensions refer to Appendix C.

Applications For Pass. Cars, Light Trucks, SUV's, & Vans

VEHICLE MAKE, MODEL & YEAR	GR-2	Gas-a-Just	MonoMax 56XXXX Series	STRUT & SHOCK	
MARQUE, MODELE ET	Excel-G		AGX 7XXXX Series	MOUNTS	BOOT KITS
ANNEE DU VEHICULE	 	 	 	 	 
LA MARCA EL MODELO & ANO					

JEEP Wagoneer (continued)

1963-65	ALL (Exc. Independent Front Susp.)	344426	344426	KG5401	KG5401						
---------	------------------------------------	--------	--------	--------	--------	--	--	--	--	--	--

JEEP Wagoneer - Steering Stabilizer

1984-90	2WD & 4WD OEM Replacement Cylinder	SS10317									
	DANA #30 fits axles up to 2 3/4" diameter Complete Kit	SS15345									

JEEP Willys (CJ, DJ & Military)

1956-62	Dispatcher DJ3A Series	344426	344426	KG5401	KG5401						
1955-62	CJ5, CJ6 (Exc. w/ 5 Leaf Front Spring)	344426	344085	KG5401	KG5419		565037				
	CJ5, CJ6 w/ 5 Leaf Front Springs	344426	344426	KG5401	KG5401						
1945-62	CJ2A, 3A, 3B Series	344426	344426	KG5401	KG5401						
1941-53	Military MA, MB, MC Series	344426	344426	KG5401	KG5401						

JEEP Wrangler

2007-09	4WD	349071	349069	554364	554365						
	RWD	349071		554364							
1997-06	ALL	344435	344403	KG54323	KG54324	565020	565021				
1987-96	ALL	344091	344092	KG5467	KG5468	565055	565056				

JEEP Wrangler - Steering Stabilizer

2007-08	Replacement Unit	SS11318									
1987-06	DANA #30 fits axles up to 2 3/4" diameter Complete Kit	SS15345									
	Replacement Unit	SS10317									

JEEP Wrangler - Lift Replacement Shocks

1997-04	for Edelbrock # 63501 Lift = 2 1/2-4" for Rancho # RS5255 Lift = 2 1/2-4" for Rancho # RS9255 Lift = 2 1/2-4" for Rancho # RSX17339 Lift = 2 1/2-4" for Edelbrock # 64501 Lift = 2 1/2-4" for Rancho # RS5256 Lift = 2 1/2-4" for Rancho # RS9256 Lift = 2 1/2-4" for Rancho # RSX17340 Lift = 2 1/2-4"					565096 565096 565096 565096	565097 565097 565097 565097				
---------	--	--	--	--	--	--------------------------------------	--------------------------------------	--	--	--	--

JEEP YJ (Canadian Vehicle)

1987-96	ALL	344091	344092	KG5467	KG5468	565055	565056				
---------	-----	--------	--------	--------	--------	--------	--------	--	--	--	--

JEEP YJ - Steering Stabilizer

1987-96	DANA #30 fits axles up to 2 3/4" diameter Complete Kit	SS15345									
	Replacement Unit	SS10317									

KIA Amanti

2007-09	ALL	341482	349060					SM5517	SM5517	SB101	SB101
2004-06	ALL	341481	341483					SM5517	SM5517	SB101	SB101











KIA Magentis (Canadian Vehicle)

2007-09	ALL	Left Hand	334509 ⁶³	344501 ⁶³							
---------	-----	-----------	----------------------	----------------------	--	--	--	--	--	--	--

⁶³ New Part Number; Available 4th Quarter 2010

Notes de bas de Page 259 - Guia de notas al calce del catalogo Pg. 260
 Bold part numbers indicate the most comparable KYB product to the original design & performance.
 (22) For vehicles with Electronic Susp., Leveling Control, and Air Suspensions refer to Appendix C.

Applications For Pass. Cars, Light Trucks, SUV's, & Vans

VEHICLE MAKE, MODEL & YEAR	GR-2	Gas-a-Just	MonoMax 56XXXX Series	STRUT & SHOCK	
MARQUE, MODELE ET	Excel-G		AGX 7XXXX Series	MOUNTS	BOOT KITS
ANNEE DU VEHICULE	 	 	 	 	 
LA MARCA EL MODELO & AÑO					

KIA Magentis (Canadian Vehicle) (continued)

2007-09	ALL	Right Hand	334508 ⁶³	344501 ⁶³							
2006	ALL (New Style)	Right Hand	334508 ⁶³	344501 ⁶³							
		Left Hand	334509 ⁶³	344501 ⁶³							
	ALL (Old Style)		341280	341281					SM5460	SM5091	SB101 SB101
2001-05	ALL		341280	341281					SM5460	SM5091	SB101 SB101

KIA Optima

2007-09	ALL	Left Hand	334509 ⁶³	344501 ⁶³							
		Right Hand	334508 ⁶³	344501 ⁶³							
2006	ALL w/ Engine Vin 3 & 4 (New Style)	Right Hand	334508 ⁶³	344501 ⁶³							
		Left Hand	334509 ⁶³	344501 ⁶³							
		ALL w/ Engine Vin 6 & 8 (Old Style)	341280	341281					SM5460	SM5091	SB101 SB101
2001-05	ALL		341280	341281					SM5460	SM5091	SB101 SB101

KIA Rondo

2007-10	ALL	Right Hand	334508 ⁶³	344501 ⁶³							
		Left Hand	334509 ⁶³	344501 ⁶³							

KIA Rio

2006-08	ALL										SB102 SB107
2002-05	ALL	Right Hand	333512	343424					SM5477		SB102
		Left Hand	333513	343424					SM5478		SB102
2001-7/1/02	ALL	Right Hand	333502	343353					SM5454		SB102
		Left Hand	333503	343353					SM5454		SB102

KIA Sedona

2006-10	Strut Mount & Bearing								SM5539 ⁶³		
2002-05	ALL	Right Hand	335063	344296					SM5151		SB101
		Left Hand	335064	344296					SM5151		SB101

KIA Sephia

1998-01	Strut Mount w/ Bearing								SM5308		
1998-5/00	ALL	Right Hand	333262	333264					SM5076	SM5232	SB101
		Left Hand	333263	333265					SM5076	SM5233	SB101
	Strut Mount Bearing								SM5129		SB101
1994-97	ALL (Exc. ABS)	Right Hand	333109	333111					SM5234	SM5232	
		Left Hand	333110	333111					SM5234	SM5233	

KIA Sorento

2007-08	ALL									SM5455	SB101
2003-06	ALL (Exc. Self leveling)	Right Hand	341364	349005						SM5455	SB101
		Left Hand	341365	349005						SM5455	SB101

KIA Spectra











2009	ALL	Right Hand	333490								
		Left Hand	333491								
2007-08	ALL	Right Hand	333490						SM5193	SM5074	SB101 SB108
		Left Hand	333491						SM5193	SM5074	SB101 SB108
2005-06	ALL	Right Hand	333490	333492					SM5193	SM5074	SB101 SB108
		Left Hand	333491	333493					SM5193	SM5074	SB101 SB108

⁶³ New Part Number; Available 4th Quarter 2010

Notes de bas de Page 259 - Guia de notas al calce del catalogo Pg. 260

Bold part numbers indicate the most comparable KYB product to the original design & performance.
(22) For vehicles with Electronic Susp., Leveling Control, and Air Suspensions refer to Appendix C.

Applications For Pass. Cars, Light Trucks, SUV's, & Vans

VEHICLE MAKE, MODEL & YEAR	  	STRUT & SHOCK		BOOT KITS	
MARQUE, MODELE ET		MOUNTS			
ANNEE DU VEHICULE					
LA MARCA EL MODELO & ANO					
	 	 	 	 	 

KIA Spectra (continued)

2004	ALL 2.0L	Right Hand Left Hand	333490 333491	333492 333493					SM5193 SM5193	SM5074 SM5074	SB101 SB101	SB108 SB108
2003-04	ALL 1.8L	Right Hand Left Hand	333316 333317	333364 333365					SM5479 SM5479	SM5481 SM5480	SB101 SB101	SB108 SB108
2002	ALL w/ ABS Strut Mount (Sedan) Mount w/ Bearing (Hatchback)	Right Hand Left Hand	333316 333317	333364 333365					SM5479 SM5308	SM5481 SM5480	SB101 SB101	SB108 SB108
6/25/01-02	ALL (Exc. ABS) Mount w/ Bearing (Hatchback) Strut Mount (Sedan)	Right Hand Left Hand	333316 333317	333364 333365					SM5308 SM5479	SM5481 SM5480	SB101 SB101	SB108 SB108
00-6/25/01	ALL (Exc. ABS)	Right Hand Left Hand	333314 333315	333264 333265					SM5308 SM5308	SM5481 SM5480	SB101 SB101	SB108 SB108
2000-01	ALL w/ ABS	Right Hand Left Hand	333314 333315	333264 333265					SM5308 SM5308	SM5481 SM5480	SB101 SB101	SB108 SB108

KIA Spectra5

2009	ALL	Right Hand Left Hand	333490 333491									
2008	ALL	Right Hand Left Hand	333490 333491						SM5193 SM5193	SM5074 SM5074	SB101 SB101	SB108 SB108
2005-07	ALL	Right Hand Left Hand	333490 333491	333492 333493					SM5193 SM5193	SM5074 SM5074	SB101 SB101	SB108 SB108

KIA Sportage

2009-10	ALL	Right Hand Left Hand	334502 334503	334504 334505								
2005-08	ALL	Right Hand Left Hand	334502 334503	334504 334505					SM5295 SM5295	SM5239 SM5239	SB105 SB105	SB105 SB105
1999-02	ALL Upper Spring Seat Insulator	Right Hand Left Hand	341394 341395	344359 344359					SM5453 SM5453 SM5416		SB108 SB108	
1995-98	ALL Upper Spring Seat Insulator		341190			KG5745			SM5453 SM5416		SB108	

LANDROVER Discovery

1999-04	Series II w/ Air Susp. (Exc. Active Cornering Enhancement)		345036	345037								
	Series II w/ Coil Spring (Exc. Active Cornering Enhancement)		345036	345037								
	Series II w/ Air Susp. & Active Cornering Enhancement			345037								
	Series II w/ Coil Spring & Active Cornering Enhancement			345037								
1994-99	All (Exc. Series II)		345014	345005								

LANDROVER Freelander

2002-05	ALL	Right Hand Left Hand	335926 335927	334623 334624								
---------	-----	-------------------------	------------------	------------------	--	--	--	--	--	--	--	--

Notes de bas de Page 259 - Guia de notas al calce del catalogo Pg. 260
 Bold part numbers indicate the most comparable KYB product to the original design & performance.
 (22) For vehicles with Electronic Susp., Leveling Control, and Air Suspensions refer to Appendix C.

Applications For Pass. Cars, Light Trucks, SUV's, & Vans

VEHICLE MAKE, MODEL & YEAR	<i>GR-2</i>		<i>Gas-a-Just</i>		<i>MonoMax</i> 56XXXX Series		STRUT & SHOCK			
MARQUE, MODELE ET	<i>Excel-G</i>				<i>AGX</i>		MOUNTS		BOOT KITS	
ANNEE DU VEHICULE					7XXXXX Series					
LA MARCA EL MODELO & ANO										

LANDROVER LR3

2005-06	ALL	NA	NA								
---------	-----	----	----	--	--	--	--	--	--	--	--

LANDROVER Range Rover

1995-02	ALL w/ Air Susp.	345038	345039								
---------	------------------	--------	--------	--	--	--	--	--	--	--	--

LEXUS ES250

1990-92	ALL (Struts)	Right Hand	235041	235042					SM5049	SM5375	SB105	SB105
		Left Hand	235041	235043					SM5049	SM5375	SB105	SB105
	ALL (Cartridges)		365061	365062					SM5049	SM5375	SB105	SB105

LEXUS ES300

2002-03	ALL (Exc. Adj. Susp.)	Right Hand	334338	334340					SM5423	SM5175	SB102	SB101
		Left Hand	334339	334341					SM5423	SM5175	SB102	SB101
	Upper Spring Seat w/ Insulator								SM5485			
	Lower Spring Seat Insulator								SM5441	SM5469		
1997-01	ALL (Exc. Adj. Susp.)	Right Hand	334245	334133					SM5179	SM5175	SB101	SB101
		Left Hand	334246	334134					SM5180	SM5175	SB101	SB101
	Upper Spring Seat w/ Insulator								SM5485			
	Lower Spring Seat Insulator								SM5441	SM5469		
1995-96	ALL	Right Hand	334170	334133					SM5174	SM5185	SB101	SB101
		Left Hand	334171	334134					SM5174	SM5185	SB101	SB101
	Upper Spring Seat w/ Insulator								SM5485			
	Upper Spring Seat Insulator									SM5468		
	Lower Spring Seat Insulator									SM5469		
1992-94	ALL w/ Sealed struts	Right Hand	334131	334133					SM5385	SM5185	SB101	SB101
		Left Hand	334132	334134					SM5385	SM5185	SB101	SB101
	ALL w/ Serviceable Struts		365085	365062					SM5385	SM5185	SB101	SB101
	Strut Mount w/ Bearing								SM5126			
	Lower Spring Seat Bearing (Only)								SM5125			
	Lower Springseat Assembly								SM5173			
	Upper Spring Seat Insulator									SM5468		
	Lower Spring Seat Insulator									SM5469		

LEXUS ES330

2005-06	ALL (Exc. Adj. Susp.)	Right Hand	334386	334388					SM5423	SM5175		SB101
		Left Hand	334387	334389					SM5423	SM5175		SB101
2004-06	Upper Spring Seat w/ Insulator								SM5485			
2004	ALL (Exc. Adj. Susp.)	Right Hand	334386	334388					SM5423	SM5175	SB102	SB101
		Left Hand	334387	334389					SM5423	SM5175	SB102	SB101

LEXUS ES350

2007-08	ALL	Right Hand	339023	335059								SB101
		Left Hand	339024	335060								SB101
	Upper Spring Seat w/ Insulator								SM5485			

LEXUS GS300

2006	AWD	Right Hand				551108						
		Left Hand				551108						
	FWD	Right Hand			551106	551108						
		Left Hand			551107	551108						
1998-05	ALL		341266	341267					SM5205		SB103	SB103
1996-97	ALL		341196	341197					SM5205		SB103	SB103
1993-95	ALL		341196	341197								

Notes de bas de Page 259 - Guia de notas al calce del catalogo Pg. 260

Bold part numbers indicate the most comparable KYB product to the original design & performance.
(2) For vehicles with Electronic Susp., Leveling Control, and Air Suspensions refer to Appendix C.

Applications For Pass. Cars, Light Trucks, SUV's, & Vans

VEHICLE MAKE, MODEL & YEAR	GR-2	Gas-a-Just	MonoMax 56XXXX Series	STRUT & SHOCK	
MARQUE, MODELE ET	Excel-G		AGX 7XXXXX Series	MOUNTS	BOOT KITS
ANNEE DU VEHICULE					
LA MARCA EL MODELO & ANO					

LEXUS GS350

2007-10	AWD (Exc. Adaptive Control Suspension) Right Hand Left Hand					551108 551108					
	FWD (Exc. Adaptive Control Suspension) Right Hand Left Hand			551106 551107		551108 551108					

LEXUS GS400

1998-00	ALL	341266	341267					SM5205		SB103	
---------	-----	--------	--------	--	--	--	--	--------	--	-------	--

LEXUS GS430

2001-05	ALL (Exc. Adj. Susp.)	341266	341267					SM5205		SB103	
---------	-----------------------	--------	--------	--	--	--	--	--------	--	-------	--

LEXUS GX470

2003-2/04	Upper Spring Seat Isolator							SM5413			
-----------	----------------------------	--	--	--	--	--	--	--------	--	--	--

LEXUS IS300

2001-04	ALL	341262	341263					SM5490		SB101	SB103
---------	-----	--------	--------	--	--	--	--	--------	--	-------	-------

LEXUS LS400

1995-00	ALL (Exc. Elec. Pneumatic Susp.)	341159	341269					SM5563 ⁶³	SM5177	SB101	SB104
1990-94	ALL (Exc. Elec. Pneumatic Susp.)	341159	341268					SM5176	SM5178		

LEXUS LS430

2001-06	ALL (Exc. Adj. Susp.)	341392	341393					SM5565 ⁶³	SM5566 ⁶³		
---------	-----------------------	--------	--------	--	--	--	--	----------------------	----------------------	--	--

LEXUS LX450

1996-97	ALL (Coil Spring Front Susp.) (Exc. Adj. Susp.)			KG54300	KG54301	565026	565027				
---------	--	--	--	---------	---------	--------	--------	--	--	--	--

LEXUS LX470

1998-07	All (Torsion Bar Front Susp.) (Exc. Adj. Susp)	345022	345023								
---------	--	--------	--------	--	--	--	--	--	--	--	--

LEXUS RX300

1999-03	RX300 AWD	Right Hand	334261	334263					SM5179	SM5175	SB101	SB101
		Left Hand	334262	334264					SM5180	SM5175	SB101	SB101
	RX300 FWD	Right Hand	334261	334269					SM5179	SM5175	SB101	SB101
		Left Hand	334262	334270					SM5180	SM5175	SB101	SB101
	Upper Spring Seat w/ Insulator								SM5485			
	Lower Spring Seat Insulator									SM5469		

LEXUS RX330

2004-06	RX330 AWD w/o Air Susp.	Right Hand	334399 ⁶⁴	235908					SM5423	SM5491	SB102	SB104
		Left Hand	334400 ⁶⁵	235909					SM5423	SM5492	SB102	SB104
	RX330 FWD w/o Air Susp.	Right Hand	334399 ⁶⁴	235906					SM5423	SM5491	SB102	SB104
		Left Hand	334400 ⁶⁵	235907					SM5423	SM5492	SB102	SB104
	Upper Spring Seat w/ Insulator								SM5485			
	Lower Spring Seat Insulator									SM5469		

⁶³ New Part Number; Available 4th Quarter 2010

⁶⁴ Replaces [235904], when stock is depleted

⁶⁵ Replaces [235905], when stock is depleted

Applications For Pass. Cars, Light Trucks, SUV's, & Vans

VEHICLE MAKE, MODEL & YEAR		GR-2 <i>Excel-G</i>	Gas-a-Just	MonoMax 56XXXX Series AGX 7XXXXX Series	STRUT & SHOCK		BOOT KITS	
MARQUE, MODELE ET	ANNEE DU VEHICULE				MOUNTS			
LA MARCA EL MODELO & AÑO								

LEXUS RX350

2008-09	RX350 w/o Air Susp.	Right Hand Left Hand	334399 334400					SM5423 SM5423	SM5491 SM5492		
2007	RX350 AWD w/o Air Susp.	Right Hand Left Hand	334399 ⁶⁴ 334400 ⁶⁵	235908 235909				SM5423 SM5423	SM5491 SM5492	SB102 SB102	SB104 SB104
	RX350 FWD w/o Air Susp.	Right Hand Left Hand	334399 ⁶⁴ 334400 ⁶⁵	235906 235907				SM5423 SM5423	SM5491 SM5492	SB102 SB102	SB104 SB104
	Upper Spring Seat w/ Insulator							SM5485			

LEXUS RX400H

2006-08	ALL	Right Hand Left Hand						SM5423 SM5423 SM5485	SM5491 SM5492	SB102 SB102	SB104 SB104
	Upper Spring Seat w/ Insulator								SM5469		
	Lower Spring Seat Insulator										

LEXUS SC300

1992-00	ALL		341161	341162				SM5564 ⁶³	SM5186	SB101	SB103
---------	-----	--	--------	--------	--	--	--	----------------------	--------	-------	-------

LEXUS SC400

1994-00	ALL		341161	341162				SM5564 ⁶³	SM5186	SB101	SB103
1992-93	ALL		341161	341162					SM5186	SB101	SB104

LEXUS SC430

2002-08	ALL							SM5205		SB103	
---------	-----	--	--	--	--	--	--	--------	--	-------	--

LINCOLN Aviator

2003-05	ALL		341679 ⁶³	341680 ⁶³							
---------	-----	--	----------------------	----------------------	--	--	--	--	--	--	--

LINCOLN Blackwood

2002-03	ALL		NA	NA							
---------	-----	--	----	----	--	--	--	--	--	--	--

LINCOLN Continental

1997-02	ALL w/ Passive Suspension	Right Hand Left Hand	335929 335930	344614 344614							
1995-96	ALL w/ Semi-Active Suspension	Right Hand Left Hand	SR3001 SR3002	SR3003 SR3003							
1982-87	ALL		235008	343162		KG5556				SB103	
1970-81	ALL		343128	343149	KG4515	KG5522					

LINCOLN LS

2003-05	ALL		341655	341656							
---------	-----	--	--------	--------	--	--	--	--	--	--	--

LINCOLN MKX

2007-09	ALL	Right Hand Left Hand	334644 334645	349068 349068						SB102 SB102	
---------	-----	-------------------------	------------------	------------------	--	--	--	--	--	----------------	--

LINCOLN MKZ













2007-10	Mount & Springseat w/ Insulator							SM5540 ⁶³			
2007-09	AWD	Right Hand Left Hand	341405 341406	349033 349033						SB101 SB101	
	FWD	Right Hand Left Hand	341405 341406	344363 344363						SB101 SB101	

⁶³ New Part Number; Available 4th Quarter 2010

⁶⁴ Replaces [235904], when stock is depleted

⁶⁵ Replaces [235905], when stock is depleted

Applications For Pass. Cars, Light Trucks, SUV's, & Vans

VEHICLE MAKE, MODEL & YEAR	  	STRUT & SHOCK		BOOT KITS	
MARQUE, MODELE ET		MOUNTS			
ANNEE DU VEHICULE					
LA MARCA EL MODELO & ANO					
	 	 	 	 	 

LINCOLN Mark LT

2006-08	Strut Mount w/o Off Road Susp. (Incl. Black Boot & Bumper)							SM5424			
2006	ALL	341602	344414		KG5193						

LINCOLN Mark Series

1984-92	Mark VII	235008	343162		KG5556			SM5054		SB103	
1980-83	Mark VI	343128	343135	KG4515	KG5521						
1977-79	Mark V	343128		KG4515	KG5519						
1973-76	Mark IV	343128		KG4515	KG5519						
1972	Mark IV	343128	343135	KG4515	KG5521						
1969-71	Mark III	343128	343149	KG4515	KG5522						

LINCOLN Navigator

2003-05	2WD Strut Mount (Includes Black Strut Boot) 4WD Strut Mount w/ Off Road Susp. (Includes Red Strut Boot) Strut Mount w/o Off Road Susp. (Incl. Black Boot & Bumper) Strut Mount w/ Air Susp.							SM5424 SM5425 SM5424 SM5426	SM5536 ⁶³		
1998-02	2WD (Exc. Rear Air Leveling) 2WD w/ Rear Air Leveling 4WD w/ Four Corner Air-Leveling System	344367 344367	344267	KG54311 KG54311 NA	KG54320 KG54319 NA	565004 565004	565005				

LINCOLN Town Car

2003-08	ALL			551600	555601 ⁵⁹			SM5392	SM5267		
1990-02	ALL			KG5572	KG5521						
1982-89	ALL (Exc. Limousine) Limousine	343128	343149	KG4515 KG5458	KG5522 KG5522						
1981	ALL	343128	343149	KG4515	KG5522						

LINCOLN Versailles

1977-80	ALL	343133	343136								
---------	-----	--------	--------	--	--	--	--	--	--	--	--

LINCOLN Zephyr

2006	ALL Right Hand Left Hand Mount & Springseat w/ Insulator	341405 341406	344363 344363					SM5540 ⁶³		SB101 SB101	
------	---	------------------	------------------	--	--	--	--	----------------------	--	----------------	--

MAZDA 3

2004-09	ALL (Exc. Mazdaspeed) Right Hand Left Hand	334700 334701	343412 343412							SB101 SB101	
---------	--	------------------	------------------	--	--	--	--	--	--	----------------	--

MAZDA 323 (Exc. Elec. Adj. Suspension) (also see STRUT-PLUS)

1990-94	ALL (Exc. 4WD) Right Hand Left Hand Strut Mount w/ Bearing Upper Spring Seat	234037 234038	234039 234040					SM5044 SM5044 SM5305 SM5155	SM5046 SM5046	SB101 SB101	SB118 SB118
1990-91	ALL w/ 4WD Right Hand Left Hand	234037 234038						SM5044 SM5044	SM5046 SM5046	SB101 SB101	SB118 SB118











⁵⁹ Mount kit SM5267 required with [555601], or [555603]

⁶³ New Part Number; Available 4th Quarter 2010

Notes de bas de Page 259 - Guia de notas al calce del catalogo Pg. 260

Bold part numbers indicate the most comparable KYB product to the original design & performance.
(22) For vehicles with Electronic Susp., Leveling Control, and Air Suspensions refer to Appendix C.

Applications For Pass. Cars, Light Trucks, SUV's, & Vans

VEHICLE MAKE, MODEL & YEAR	GR-2	Gas-a-Just	MonoMax 56XXXX Series	STRUT & SHOCK	
MARQUE, MODELE ET	Excel-G		AGX 7XXXXX Series	MOUNTS	BOOT KITS
ANNEE DU VEHICULE	 	 	 	 	 
LA MARCA EL MODELO & AÑO					

MAZDA 323 (Exc. Elec. Adj. Suspension) (also see STRUT-PLUS) (continued)

1986-89	ALL (Exc. SW & 4WD)	Right Hand	234008	232011					SM5039	SM5045	SB102	SB118
		Left Hand	234009	232012					SM5039	SM5045	SB102	SB118
	SW & 4WD	Right Hand	234008								SB102	SB102
		Left Hand	234009								SB102	SB102
	Sedan & Hatchback (FWD) (For Adapting ASA to Non-ASA Suspension)	Right Hand	234008 ^C	232011 ^C							SB102	SB118
		Left Hand	234009 ^C	232012 ^C							SB102	SB118

MAZDA 323 (Exc. Elec. Adj. Suspension) - STRUT-PLUS

1990-94	ALL (Exc. 4WD)	Right Hand	SR4005	SR4007								
		Left Hand	SR4006	SR4008								

MAZDA 5

2006-07	ALL	Right Hand	334700	343412							SB101	
		Left Hand	334701	343412							SB101	

MAZDA 6

2009-10	ALL	Right Hand	341449	349063								
		Left Hand	341450	349063								
2005-08	ALL (Exc. Mazdaspeed)	Right Hand	341351	344363							SB101	
		Left Hand	341352	344363							SB101	
2003-04	ALL	Right Hand	341351	344363					SM5428		SB101	
		Left Hand	341352	344363					SM5428		SB101	

MAZDA 626 (Exc. Electronically-Adjustable Suspension)

2000-02	ALL	Right Hand	334401	334449					SM5459	SM5408	SB101	SB105
		Left Hand	334402	334449					SM5459	SM5407	SB101	SB105
1998-99	ALL	Right Hand	334401	334449					SM5459	SM5094	SB101	SB105
		Left Hand	334402	334449					SM5459	SM5093	SB101	SB105
1993-99	Strut Mount Bearing								SM5129			
1993-7/97	ALL	Right Hand	235601	235603					SM5076	SM5094	SB101	SB101
		Left Hand	235602	235603					SM5076	SM5093	SB101	SB101
1993-97	Strut Mounting Kit Upper Spring Seat								SM5308			
									SM5346			
1988-92	ALL (Exc. 4WS & Adj. Susp.)	Right Hand	235046	235048					SM5300	SM5035	SB104	SB101
		Left Hand	235047	235048					SM5300	SM5035	SB104	SB101
	ALL (Exc. 4WS) (For Adapting AAS to Non-AAS Suspension)	Right Hand	235046 ^C	235606 ^C					SM5300	SM5035	SB104	SB101
		Left Hand	235047 ^C	235606 ^C					SM5300	SM5035	SB104	SB101
	Front Strut Mount, Japan Built, Manual Trans. exc. 4WS & Adj. Susp.								SM5041			
	Strut Mount/Bearing Kit, Japan Built, Manual Trans. exc. 4WS & Adj. Susp.								SM5274			
	Strut Mount Bearing for SM5041								SM5127			
	Springseat 4 cyl. exc. Man. Trans. & 4WS Springseat								SM5341			
1988-91	Spring Seat (Man. Trans. w/ 4WS)								SM5343			
1986-87	ALL	Right Hand	233007	233016					SM5307	SM5298	SB101	SB101
		Left Hand	233008	233016					SM5307	SM5299	SB101	SB101
1983-87	ALL (For Adapting AAS to Non-AAS Suspension)	Right Hand	233007 ^C	234050 ^C							SB101	SB101
		Left Hand	233008 ^C	234050 ^C							SB101	SB101
1983-85	ALL	Right Hand	233007	233016					SM5047	SM5298	SB101	SB101
		Left Hand	233008	233016					SM5047	SM5299	SB101	SB101

^C To convert from Electronic Susp. - See Appendix C











Notes de bas de Page 259 - Guia de notas al calce del catalogo Pg. 260

Bold part numbers indicate the most comparable KYB product to the original design & performance.
(22) For vehicles with Electronic Susp., Leveling Control, and Air Suspensions refer to Appendix C.

PASSENGER CARS / VOITURES / AUTOMOVILES
LIGHT TRUCKS / CAMIONNETTE / CAMIONES LIGEROS

HEAVY DUTY, MOTORHOME / SERVICE INTENSIF, AUTOCARS ET
AUTOCARAVANES / EQUIPOS PESADOS, AUTOBUSES, Y CASAS RODANTES

Applications For Pass. Cars, Light Trucks, SUV's, & Vans

VEHICLE MAKE, MODEL & YEAR	GR-2	Gas-a-Just	MonoMax 56XXXX Series	STRUT & SHOCK	
MARQUE, MODELE ET	Excel-G		AGX 7XXXX Series	MOUNTS	BOOT KITS
ANNEE DU VEHICULE	 	 	 	 	 
LA MARCA EL MODELO & ANO					

MAZDA 626 (Exc. Electronically-Adjustable Suspension) (continued)

1979-82	ALL From Chassis No.CB2MS-543880	363022	343149					SM5304		SB103	
1979	ALL Thru Chassis No.CB2MS-543879		343149								

MAZDA 929 (Exc. Electronically-Adjustable Suspension)

1990-91	ALL	NA	NA					SM5306			
1988-89	ALL	NA	NA					SM5301	SM5302		

MAZDA CX-7

2007-09	ALL	Right Hand	339155	349076							
		Left Hand	339156	349076							

MAZDA CX-9

2007-09	ALL	Right Hand	339140	349070							
		Left Hand	339141	349070							

MAZDA GLC

1981-85	ALL FWD (Exc. Station Wagon)	Right Hand	233005	232001				SM5039	SM5045	SB103	SB101
		Left Hand	233006	232002				SM5039	SM5045	SB103	SB101

MAZDA MPV Mini-Van

8/00-06	ALL	Right Hand	334418	345024				SM5458		SB105	
		Left Hand	334419	345024				SM5458		SB105	
2000-06	Strut Mount Bearing							SM5127			
2000-7/00	FWD	Right Hand	334282	345024				SM5458		SB105	
		Left Hand	334283	345024				SM5458		SB105	
1996-98	2WD (Exc. Rear Self Leveling)	Right Hand	236005		KG5198A	KG5198A		SM5151		SB105	
		Left Hand	236006					SM5151		SB105	
	2WD w/ Rear Self Leveling	Right Hand	236005		SM5151	SB105					
		Left Hand	236006		SM5151	SB105					
	4WD (Exc. Rear Self Leveling)	Right Hand	236009		KG54305	KG54305		SM5151		SB104	
		Left Hand	236010					SM5151		SB104	
	4WD w/ Rear Self Leveling	Right Hand	236009		SM5151	SB104					
		Left Hand	236010		SM5151	SB104					
1989-95	2WD (Exc. Rear Self Leveling)	Right Hand	236005		KG5198A	KG5198A		SM5115		SB104	
		Left Hand	236006					SM5115		SB104	
	2WD w/ Rear Self Leveling	Right Hand	236005		SM5115	SB104					
		Left Hand	236006		SM5115	SB104					
	4WD (Exc. Rear Self Leveling)	Right Hand	236009		KG54305	KG54305		SM5115		SB104	
		Left Hand	236010					SM5115		SB104	
	4WD w/ Rear Self Leveling	Right Hand	236009		SM5115	SB104					
		Left Hand	236010		SM5115	SB104					

MAZDA MX3













1992-95	ALL (Exc. ABS)	Right Hand	234037	234039				SM5044	SM5046	SB105	SB118
		Left Hand	234038	234040				SM5044	SM5046	SB105	SB118
	Strut Mounting Kit							SM5305			

MAZDA MX6 (Exc. Electronically-Adjustable Suspension)

1993-97	ALL	Right Hand	235601	235603				SM5076	SM5094	SB104	SB101
		Left Hand	235602	235603				SM5076	SM5093	SB104	SB101
	Strut Mount w/ Bearing							SM5308			
	Strut Mount Bearing							SM5129			
	Upper Spring Seat							SM5346			

Notes de bas de Page 259 - Guia de notas al calce del catalogo Pg. 260
 Bold part numbers indicate the most comparable KYB product to the original design & performance.
 (22) For vehicles with Electronic Susp., Leveling Control, and Air Suspensions refer to Appendix C.

Applications For Pass. Cars, Light Trucks, SUV's, & Vans

VEHICLE MAKE, MODEL & YEAR	  	STRUT & SHOCK		BOOT KITS	
MARQUE, MODELE ET		MOUNTS			
ANNEE DU VEHICULE					
LA MARCA EL MODELO & ANO					
	 	 	 	 	 

MAZDA MX6 (Exc. Electronically-Adjustable Suspension) (continued)

1988-92	ALL (Exc. Elec. Susp. & 4WS) Right Hand Left Hand	235046 235047	235048 235048						SM5035 SM5035	SB104 SB104	SB101 SB101
	GT (Exc. 4WS) (For Adapting AAS to Non-AAS Suspension) Right Hand Left Hand	235046 ^c 235047 ^c	235606 ^c 235606 ^c							SB104 SB104	SB101 SB101
	Mount Kit, Auto Trans (Exc. 4WS) Mount, Manual Trans (Exc. 4WS) Strut Mount Bearing for SM5041 Springseat (Exc. Manual Trans. & 4WS)								SM5300 SM5041 SM5127 SM5341		

MAZDA Miata (MX5)

2009-10	ALL (Exc. Sport Susp.) (Exc. Run Flat Tires)				551118						
2006-08	ALL (Exc. Sport Susp.) (Exc. Run Flat Tires)			551117	551118						
1999-05	ALL (Exc. Sports Package)	341253	341254			741035	741036	SM5139	SM5139	SB108	SB108
1989-97	ALL ALL (Exc. ABS)	341143	341127			741015	741016	SM5077 SM5077	SM5077 SM5077	SB108 SB108	SB108 SB108

MAZDA Millenia

1997-00	ALL		341259								
1995-8/95	2.5L, 2.3L		341316								

MAZDA Navajo

1991-94	ALL	344268	344269	KG5489	KG5490	565001	565003				
---------	-----	--------	--------	--------	--------	--------	--------	--	--	--	--

MAZDA Navajo - Lift Replacement Shocks

1991-94	ALL Lift = 0-2"					565082	565003				
---------	-----------------	--	--	--	--	--------	--------	--	--	--	--

MAZDA Pickup (2WD)

2001-08	B2300	344397	344396	KG54328	KG5487						
2001-06	B3000, B4000 w/ Coil Spring Front Susp. (Exc. Dual Sport) B3000, B4000 w/ Torsion Bar Front Susp. (Inc. Dual Sport)	344397 341302	344396 344079	KG54328 KG54309	KG5487 KG5493						
2001	B2500	344397	344396	KG54328	KG5487						
1998-00	B2300, B2500, B3000, B4000	344397	344396	KG54328	KG5487						
1994-97	B2300, B2500, B3000, B4000	344268	344396	KG5489	KG5487						
1986-93	ALL	344098	344044	KG5476	KG4012						
1972-84	ALL	343127	344052								

MAZDA Pickup (4WD)

1998-06	B3000, B4000	341302	344079	KG54309	KG5493						
1994-97	B3000, B4000	344268	344079	KG5489	KG5493						
1987-93	ALL			KG5484	KG5485						
1972-84	ALL	343127	344052								



MAZDA Protege (also see STRUT-PLUS)

2003	ALL (Exc. Mazdaspeed) Right Hand Left Hand w/o 4 Wheel Disc	333350 333351	333276 333277						SM5457 SM5456	SB101 SB101	SB102 SB102
									SM5427		

^c To convert from Electronic Susp - See Appendix C

Notes de bas de Page 259 - Guia de notas al calce del catalogo Pg. 260
 Bold part numbers indicate the most comparable KYB product to the original design & performance.
 (22) For vehicles with Electronic Susp., Leveling Control, and Air Suspensions refer to Appendix C.

Applications For Pass. Cars, Light Trucks, SUV's, & Vans

VEHICLE MAKE, MODEL & YEAR	  	STRUT & SHOCK		BOOT KITS		
MARQUE, MODELE ET		MOUNTS				
ANNEE DU VEHICULE						
LA MARCA EL MODELO & ANO						

MAZDA Protege (also see STRUT-PLUS) (continued)

2003	w/ 4 Wheel Disc							SM5429			
8/00-02	ALL (Exc. MP3)	Right Hand	333350	333276				SM5427	SM5457	SB101	SB102
		Left Hand	333351	333277				SM5427	SM5456	SB101	SB102
1999-7/00	ALL	Right Hand	333274	333276				SM5427	SM5457	SB101	SB102
		Left Hand	333275	333277				SM5427	SM5456	SB101	SB102
1995-98	ALL	Right Hand	333182	333184				SM5150	SM5406	SB101	SB118
		Left Hand	333183	333185				SM5150	SM5405	SB101	SB118
1990-94	ALL (Exc. 4WD) Strut Mount w/ Bearing	Right Hand	234037	234039				SM5044	SM5046	SB101	SB118
		Left Hand	234038	234040				SM5044 SM5305	SM5046	SB101	SB118
1990-91	ALL w/ 4WD	Right Hand	234037					SM5044	SM5046	SB101	SB101
		Left Hand	234038					SM5044	SM5046	SB101	SB101

MAZDA Protege - STRUT-PLUS

1990-94	ALL (Exc. 4WD)	Right Hand	SR4005	SR4007							
		Left Hand	SR4006	SR4008							

MAZDA Protege 5

2001-03	ALL	Right Hand	333350	333276						SB101	SB102
		Left Hand	333351	333277						SB101	SB102

MAZDA RX-4

1974-78	ALL			344052							
---------	-----	--	--	--------	--	--	--	--	--	--	--

MAZDA RX-7 (Exc. Electronically-Adjustable Susp.)

1993-96	ALL	Right Hand	341168	341170							
		Left Hand	341169	341170							
1989-92	Turbo (For Adapting AAS to Non-AAS Suspension)	Right Hand	235012 ^c		KG9132 ^c	733012 ^c	741025 ^c	SM5303		SB103	SB107
		Left Hand	235013 ^c		KG9132 ^c	733013 ^c	741025 ^c	SM5303		SB103	SB107
1986-92	ALL	Right Hand	235012		KG9132	733012	741025	SM5303		SB103	SB107
		Left Hand	235013		KG9132	733013	741025	SM5303		SB103	SB107
1986-88	GXL (For Adapting AAS to Non-AAS Suspension)	Right Hand	235012 ^c		KG9132 ^c	733012 ^c	741025 ^c	SM5303		SB103	SB107
		Left Hand	235013 ^c		KG9132 ^c	733013 ^c	741025 ^c	SM5303		SB103	SB107
1984-85	GSL-SE			343140	KG4644A					SB103	
1981-85	ALL (Exc. GSL-SE)		363010	343140	KG4644A			SM5304		SB103	
1978-80	ALL		363003	343140	KG4644A						

MAZDA RX-8

2004-06	ALL (Exc. SHINKA Package)				551115	551116					
---------	---------------------------	--	--	--	--------	--------	--	--	--	--	--











MAZDA Tribute

2009-10	ALL Upper Spring Seat	Right Hand	235912					SM5390		SB105	
		Left Hand	235913					SM5390	SM5547 ⁶³	SB105	
2001-08	ALL Upper Spring Seat	Right Hand	235912	344356				SM5390		SB105	
		Left Hand	235913	344356				SM5390	SM5547 ⁶³	SB105	

⁶³ New Part Number; Available 4th Quarter 2010
^c To convert from Electronic Susp. - See Appendix C

Notes de bas de Page 259 - Guia de notas al calce del catalogo Pg. 260
 Bold part numbers indicate the most comparable KYB product to the original design & performance.
 (22) For vehicles with Electronic Susp., Leveling Control, and Air Suspensions refer to Appendix C.

Applications For Pass. Cars, Light Trucks, SUV's, & Vans

VEHICLE MAKE, MODEL & YEAR	GR-2 <i>Excel-G</i>	Gas-a-Just	MonoMax 56XXXX Series AGX 7XXXX Series	STRUT & SHOCK MOUNTS	BOOT KITS
MARQUE, MODELE ET ANNEE DU VEHICULE	 	 	 	 	 
LA MARCA EL MODELO & ANO					

MERCEDES BENZ 190 Series

1989-93	190E, 190D, 190 (W201)	235021		553177 ⁷⁶		SM5084		SB102	
1984-88	190E (W201) 2.3L 16 Valve 190E, 190D, 190 (W201) (Exc. 2.3L 16 Valve)	235021 235021		553178 553177 ⁷⁶		SM5084 SM5084		SB102 SB102	
1961-65	190c, 190Dc (W110) 190c, 190Dc Station Wagon		KG4523 KG4523	KG5534					

MERCEDES BENZ 200 Series

1985-93	200T, 200TD (W124) Station Wagon	235021				SM5084		SB119	
1984-93	200, 200D (W124)	235021		553178		SM5084		SB119	
1978-85	200T (W123) Station Wagon		KG4530						
1976-84	200, 200D (W123)		KG4530	KG5554					
1968-76	200, 200D (W115) (W114)		KG4522	KG5533					
1965-67	200, 200D (W111) 200, 200D Station Wagon		KG4523 KG4523	KG5534					

MERCEDES BENZ 220 Series

1976-84	220D (W123)		KG4530	KG5554					
1968-78	220, 220D (W115) Station Wagon		KG4522	KG5554					
1968-76	220, 220D (W115) (W114)		KG4522	KG5533					
1961-65	220b, 220Sb Station Wagon		KG4523						
1960-65	220Sb, 220SE, 220SEb (W111) (Exc. Hydromat Susp.) 220b (W111)		KG4523 KG4523	KG5534 KG5534					

MERCEDES BENZ 230 Series

1987-93	230CE (C124)	235021		553178		SM5084		SB102	
1985-93	230TE (W124) Station Wagon	235021				SM5084		SB119	
1984-93	230E (W124)	235021		553178		SM5084		SB119	
1978-85	230T, 230TD (W123) Station Wagon		KG4530						
1976-84	230 (W123) 230C, 230CE (C123)		KG4530 KG4530	KG5554 KG5554					
1973-76	230-4 (W115) Station Wagon		KG4522						
1968-76	230 (W115) (W114)		KG4522	KG5533					
1965-67	230, 230S (W111) 230, 230S Station Wagon		KG4523 KG4523	KG5534 KG5534					
1963-66	230SL (W113)		KG4523	KG5534					

MERCEDES BENZ 240 Series



1978-85	240TD (W123) Station Wagon		KG4530						
1976-84	240D (W123)		KG4530	KG5554					
1973-78	240D (W115) Station Wagon		KG4522	KG5554					
1973-76	240D (W115)		KG4522	KG5533					

MERCEDES BENZ 250 Series

1985-93	250TD (W124) Station Wagon	235021				SM5084		SB119	
1984-93	250D (W124)	235021		553178		SM5084		SB119	
1978-85	250T (W123) Station Wagon		KG4530						
1976-84	250 (W123)		KG4530	KG5554					

⁷⁶ Replaces [KG4548], when stock is depleted

Applications For Pass. Cars, Light Trucks, SUV's, & Vans

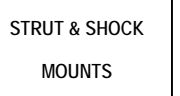
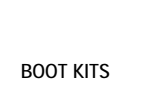
VEHICLE MAKE, MODEL & YEAR	  		
MARQUE, MODELE ET			
ANNEE DU VEHICULE			
LA MARCA EL MODELO & ANO			

MERCEDES BENZ 250 Series (continued)

1973-76	250C, 250CE (W114)			KG4522	KG5533				
1968-76	250 (W114)			KG4522	KG5533				
1968-8/72	250S (Exc. Hydromat Susp.)			KG4523	KG5534				
1967-81	250SL (W113)			KG4523	KG5534				
1965-67	250S, 250SE (Exc. Hydromat Susp.)			KG4523	KG5534				

MERCEDES BENZ 260 Series

1986-93	260E 4Matic				553178				
1985-91	260SE (W126) (Exc. Hydromat Susp.)			KG4530	KG5554				
1984-93	260E (W124) (Exc. 4Matic)	235021			553178		SM5084		SB119

MERCEDES BENZ 280 Series

1980-85	280S, 280SE, 280SEL (W126) (Exc. Hydromat Susp.)			KG4530	KG5554				
1978-85	280TE (W123) Station Wagon			KG4530					
1976-84	280, 280E (W123) 280C, 280CE (C123)			KG4530 KG4530	KG5554 KG5554				
1974-85	280SL, 280SLC (W107)			KG4523	KG5554				
1973-76	280C, 280CE (W115) 280E (W115)			KG4522 KG4522	KG5533 KG5533				
9/72-80	280S, 280SE, 280SEL (W116) (Exc. Hydromat Susp.)			KG4530	KG5554				
1968-8/72	280S, 280SE, 280SEL (W108) (Exc. Hydromat Susp.)			KG4523	KG5534				
1968-71	280SL (W113)			KG4523	KG5534				

MERCEDES BENZ 300 Series

1991-93	300SD, 300SE, 300SEL (W140) Sedan			553606 ⁶³	553178				
1987-93	300CE (C124)	235021			553178		SM5084		SB102
1986-93	300E, 300D (W124) 4Matic				553178				SB119
1985-93	300TE, 300TD (W124) Station Wagon (Exc. 4Matic)	235021					SM5084		SB119
1985-89	300SL (W107)			KG4522	KG5554				
1984-93	300E, 300D (W124) (Exc. 4Matic)	235021			553178		SM5084		SB119
1981-91	300SD, 300SDL, 300SE, 300SEL (W126) (Exc. Hydromat Susp.)			KG4530	KG5533				
1978-85	300TD (W123) Station Wagon			KG4530					
1976-85	300D, 300CD, 300CDT (W123)			KG4530	KG5554				
1975	300D (W115)			KG4522	KG5533				
9/72-80	300SD (W116)			KG4530	KG5554				
1965-8/72	300SE, 300SEL, 300SEb (W109) (Exc. Hydromat Susp.)				KG5534				













MERCEDES BENZ 350 Series

1991-93	350S (W140) Sedan			553606 ⁶³	KG5533				
1985-91	350S (W126) Sedan			KG4530	KG5533				
9/72-80	350SE (W126) (Exc. Hydromat Susp.)			KG4530	KG5554				
1971-81	350SL, 350SLC, 350SL-4.5, 350SLC-4.5 (W107)			KG4522	KG5554				

⁶³ New Part Number; Available 4th Quarter 2010

Notes de bas de Page 259 - Guia de notas al calce del catalogo Pg. 260
 Bold part numbers indicate the most comparable KYB product to the original design & performance.
 (22) For vehicles with Electronic Susp., Leveling Control, and Air Suspensions refer to Appendix C.

Applications For Pass. Cars, Light Trucks, SUV's, & Vans

VEHICLE MAKE, MODEL & YEAR	  	STRUT & SHOCK		BOOT KITS	
MARQUE, MODELE ET		MOUNTS			
ANNEE DU VEHICULE					
LA MARCA EL MODELO & ANO					
	 	 	 	 	 

MERCEDES BENZ 380 Series

1981-85	380SEC (W126) (Exc. Hydromat Susp.) 380SL, 380SLC (W107)			KG4530	KG5554						
1980-85	380SE, 380SEL, (W126) (Exc. Hydromat Susp.)			KG4530	KG5554						

MERCEDES BENZ 400 Series

1992-93	400SE, 400SEL (W140) Sedan 400E (W124) Sedan			553606 ⁶³	553178 553178			SM5084		SB119	
---------	---	--	--	----------------------	------------------	--	--	--------	--	-------	--

MERCEDES BENZ 420 Series

1985-92	420SEC (C126) (Exc. Hydromat Susp.)			KG4530	KG5554						
1985-91	420SE, 420SEL (W126) (Exc. Hydromat Susp.)			KG4530	KG5554						
1985-89	420SL (W107)			KG4522	KG5554						

MERCEDES BENZ 450 Series

1974-81	450SL, 450SLC, 450SLC-4.5 (W107)			KG4522	KG5554						
3/73-80	450SE, 450SEL, 450SEL-6.9 (W116) (Exc. Hydromat Susp.)			KG4530	KG5554						

MERCEDES BENZ 500 Series

1993	500SEC (C140) Coupe			553606 ⁶³							
1991-93	500SE, 500SEL (W140) Sedan			553606 ⁶³	553178						
1980-92	500SEC (W126) (C126) (Exc. Hydromat Susp.)			KG4530	KG5554						
1980-91	500SE, 500SEL (W126) (Exc. Hydromat Susp.)			KG4530	KG5554						
1980-89	500SL (W107)			KG4522	KG5554						

MERCEDES BENZ 560 Series

1985-92	560SEL (W126), 560SEC (C126) (Exc. Hydromat Susp.)			KG4530	KG5554						
9/85-90	560SL (R107)				KG5554						

MERCEDES BENZ 600 Series

1993	600SEC (C140) Coupe 600SEL (W140) Sedan			553606 ⁶³ 553606 ⁶³	553178						
------	--	--	--	--	--------	--	--	--	--	--	--









MERCEDES BENZ C Class (Exc. 4 Matic)

2006-07	C280 (W203) C350 (W203)	335920 335920									
2002-05	C230 (CL203) Coupe (Exc. Sport Susp.) C230 (CL203) Coupe w/ Sport Susp. C240, C320 (S203) Wagon	335920 335920 335920			553605 ⁶³ 553306						
2001-06	C Class (W203) (Exc. Self Leveling)	335920			553306						
2001-05	C320 (W203) Sedan	335920			553306						
1997-3/01	C230 (W202) w/ Sport Susp. (Exc. Self Leveling) C230 (W202) w/o Sport Susp. (Exc. Self Leveling)			KG4729 KG4739	KG4728 KG4740						

⁶³ New Part Number; Available 4th Quarter 2010

Notes de bas de Page 259 - Guia de notas al calce del catalogo Pg. 260
 Bold part numbers indicate the most comparable KYB product to the original design & performance.
 (22) For vehicles with Electronic Susp., Leveling Control, and Air Suspensions refer to Appendix C.

Applications For Pass. Cars, Light Trucks, SUV's, & Vans

VEHICLE MAKE, MODEL & YEAR	  	STRUT & SHOCK MOUNTS	BOOT KITS
MARQUE, MODELE ET			
ANNEE DU VEHICULE			
LA MARCA EL MODELO & ANO			
	    		

MERCEDES BENZ C Class (Exc. 4 Matic) (continued)

1993-00	C220 (W202) w/ Sport Susp. (Exc. Self Leveling)			KG4729	KG4728					
	C220 (W202) w/o Sport Susp. (Exc. Self Leveling)			KG4739	KG4740					
	C280 (W202) (Exc. Self Leveling)			KG4739	KG4740					

MERCEDES BENZ CLK Class

2007-09	CLK550 Convertible	335932 ⁷⁰			553367					
	CLK550 Coupe	335920			553366					
2006-09	CLK350 (Exc. Sport Suspension)	335920			553366					
	CLK350 with Sport Suspension	335932 ⁷⁰			553367					
2004-05	CLK320 & CLK500	335920								
2003-06	CLK55 AMG Convertible	335932 ⁷⁰			553367					
	CLK55 AMG Coupe	335920			553366					
2003	CLK320 with Sport Suspension	335932 ⁷⁰			553367					
1999-03	CLK430			KG4731	KG4740					
1998-02	CLK320 (Exc. Sport Susp.)			KG4731	KG4740					

MERCEDES BENZ E Class

2006-09	E350 Sedan 4Matic (Exc. Air Susp. and CDI)				553380 ⁶⁸					
	E350 Sedan RWD (Exc. Air Susp.)				553356 ⁶⁸					
2004-05	E320 Sedan 4Matic (Exc. Air Susp. and CDI)				553380 ⁶⁸					
2003-09	E320 Sedan RWD (Exc. Air Susp.)				553356 ⁶⁸					
1998-02	E320 (W210) Wagon (Exc. 4Matic)			KG4727						
	E430 (W210) (Exc. 4Matic & Sport Susp.)			KG4742	KG4743					
	E430 (W210) w/ Sport Susp. (Exc. 4Matic)			KG4727	KG4726					
1997	E420 (W210) (Exc. Self Leveling & Sport Susp.)			KG4742	KG4743					
	E420 (W210) w/ Sport Susp. (Exc. Self Leveling)			KG4727	KG4726					
1996-02	E320 (W210) Sedan (Exc. 4Matic & Self Leveling)			KG4742	KG4743					
1996-99	E300D W210 (Exc. Rear Level Control)			KG4742	KG4743					
1993-95	E300D, E320, E420 (W124) 4 Door (Exc. Rear Level Control)	235021			553178			SM5084		SB102
	E320 (S124) Station Wagon	235021						SM5084		SB102
	E320, E420 (V124) w/ Rear Level Control	235021						SM5084		SB102
	E320c (C124) 2 Door	235021			553178			SM5084		SB102
	E500 (W124)	235021						SM5084		SB102
	E320 (A124) Convertible				553178					

MERCEDES BENZ ML55 AMG

2002-03	ALL	349055	341657							
2000-01	ALL	349055								

MERCEDES BENZ ML320

2001-03	ALL	349055	341657							
1998-00	ALL	349055								

⁶⁸ New Part Number; Available 3rd Quarter 2010

⁷⁰ New Part Number; Available 2nd Quarter 2010

Notes de bas de Page 259 - Guia de notas al calce del catalogo Pg. 260

Bold part numbers indicate the most comparable KYB product to the original design & performance.

(22) For vehicles with Electronic Susp., Leveling Control, and Air Suspensions refer to Appendix C.

Applications For Pass. Cars, Light Trucks, SUV's, & Vans

VEHICLE MAKE, MODEL & YEAR	GR-2		Gas-a-Just		MonoMax 56XXXX Series		STRUT & SHOCK			
MARQUE, MODELE ET	Excel-G				AGX		MOUNTS		BOOT KITS	
ANNEE DU VEHICULE					7XXXXX Series					
LA MARCA EL MODELO & ANO										

MERCEDES BENZ ML350

2003-05	ALL	349055	341657							
---------	-----	--------	--------	--	--	--	--	--	--	--

MERCEDES BENZ ML430

1999-01	ALL	349055								
---------	-----	--------	--	--	--	--	--	--	--	--

MERCEDES BENZ ML500

2002-05	ALL	349055	341657							
---------	-----	--------	--------	--	--	--	--	--	--	--

MERCEDES BENZ S Class

1994-99	S320, S350D, S420, S500, S600 (W140) Sedan (Exc. Rear Level Control or w/ Active Damping System)			553606 ⁶³	553178					
	S500, S600 (C140) Coupe (Exc. w/ Rear Level Control or Adaptive Damping System)			553606 ⁶³	553178					
1993-99	S320, S420, S500 (V140) Sedan w/ Rear Level Control			553606 ⁶³						

MERCEDES BENZ SL Class

1990-02	ALL SL129 Chassis- 300SL, 500SL, 600SL, SL320, SL600 w/ self leveling			NA	NA			SM5309		
---------	---	--	--	----	----	--	--	--------	--	--

MERCEDES BENZ SLK Class

1997-04	SLK230 & SLK320			KG4731	KG4732					
---------	-----------------	--	--	--------	--------	--	--	--	--	--

MERCEDES BENZ Sprinter 2500

2002-06	ALL (Exc. 118" WB, High Roof Option, Chassis Cab)	335810	349001					SM5445		
	ALL w/ 118" WB & High Roof Option	335809	341339					SM5445		
	ALL w/ 118" WB (Exc. High Roof Option)	335810	341339					SM5445		
	ALL w/High Roof Option or Chassis Cab (Exc. 118" WB)	335809	349001					SM5445		

MERCEDES BENZ Sprinter 3500

2002-06	ALL (Exc. High Roof Option, Dual Rear Wheels, Chassis Cab)	335810	349001					SM5445		
	ALL w/Dual Rear Wheels & High Roof Option or Chassis Cab	335809	344409					SM5445		
	ALL w/Dual Rear Wheels (Exc. High Roof Option, Chassis Cab)	335810	344409					SM5445		
	ALL w/High Roof Option or Chassis Cab (Exc. Dual Rear Wheels)	335809	349001					SM5445		

MERCURY Bobcat

1975-80	Sedan, Coupe & Hatchback Station Wagon	343134 343134	343137	KG4511 KG4511	KG5514					
---------	--	------------------	--------	------------------	--------	--	--	--	--	--

MERCURY Capri

1991-94	ALL Right Hand Left Hand	234008 234009						SM5141 SM5141	SM5045 SM5045	SB105 SB105	SB103 SB103
1984-86	AXLE DAMPER (Rear Quad Shock)				KG4521 ²³						
1983-86	ALL (Exc. Special Handling) w/ Special Handling Pkg.	235005 235005	343163 343161		KG5559 KG5551			SM5036 SM5036		SB103 SB103	
1982	ALL		343163		KG5559					SB103	

²³ Install [KG4521] with the dustcover to the rear of the vehicle, the spacers (in box) to the inboard side of the shock, and the axle mounting bracket spread slightly (1-2mm).

⁶³ New Part Number; Available 4th Quarter 2010

Notes de bas de Page 259 - Guia de notas al calce del catalogo Pg. 260

Bold part numbers indicate the most comparable KYB product to the original design & performance.

(22) For vehicles with Electronic Susp., Leveling Control, and Air Suspensions refer to Appendix C.

Applications For Pass. Cars, Light Trucks, SUV's, & Vans

VEHICLE MAKE, MODEL & YEAR	GR-2		Gas-a-Just		MonoMax 56XXXX Series		STRUT & SHOCK		BOOT KITS	
MARQUE, MODELE ET	Excel-G				AGX		MOUNTS			
ANNEE DU VEHICULE					7XXXXX Series					
LA MARCA EL MODELO & ANO										

MERCURY Capri (continued)

1979-81	ALL	235001	343161		KG5551					SB103	
1971-78	ALL Shock (Sleeve) Adapter Kit		343135 ⁷ KIT107							SB101	

MERCURY Comet

1971-77	ALL	343146	343136	KG4517							
1966-70	Sedan & Coupe Station Wagon	343156 343156	343219 343135	KG4505 KG4505	KG5517						
1960-65	ALL	343156	343219	KG4505	KG5517						

MERCURY Cougar

1998-02	ALL	235620	235621					SM5138	SM5140	SB105	SB102
1989-97	ALL (Exc. Adjustable Susp.) ALL (Exc. XR-7) Lower Spring Seat Insulator	231015	344110					SM5187 SM5465			
1987-88	ALL (Exc. Turbo) XR7 (For Adapting PRC to Non-PRC Suspension)	235005 235008 ^C	343162		KG5556 KG5556 ^C			SM5054 SM5054		SB103 SB103	
1984-88	AXLE DAMPER (Rear Quad Shock)				KG4521 ²³						
1983-86	ALL	235002	343162		KG5556			SM5054		SB103	
1981-82	ALL (Exc. XR-7)	235005	343163		KG5559			SM5036		SB103	
12/80-82	XR-7	235002	343162		KG5556			SM5054		SB103	
1974-79	ALL	343128	343135	KG4515	KG5521						
1971-73	ALL	343156	343219	KG4504	KG5517						
1967-70	ALL	343146	343219	KG4517	KG5517						

MERCURY Colony Park

1969-74	ALL	343128	343149		KG5522						
1965-68	ALL	343128	343149		KG5522						
1961-64	ALL	343127	343136								
1957-60	ALL	343127	343219		KG5517						

MERCURY Cyclone

1972-76	ALL	343128	343135	KG4515	KG5521						
1968-71	ALL (Exc. Station Wagon) Station Wagon	343156 343156	343219 343135	KG4505 KG4505	KG5517						

MERCURY Grand Marquis

2003-08	ALL (Incl. Rear Air Spring Susp.)			551600	555601 ⁵⁹			SM5392	SM5267		
2000-02	Police Car & Taxi	344081 ³²	343135	KG5458 ³²	KG5521						
1995-02	ALL (Exc. Police Car & Taxi)	344424	343135	KG5572	KG5521						
1983-99	Police Car & Taxi	344081	343135	KG5458	KG5521						
1983-94	ALL (Exc. Police Car & Taxi)	343128	343135	KG4515	KG5521						
1979-82	ALL	343128	343135	KG4515	KG5521						
1975-78	ALL	343128	343149	KG4515	KG5522						

²³ Install [KG4521] with the dustcover to the rear of the vehicle, the spacers (in box) to the inboard side of the shock, and the axle mounting bracket spread slightly (1-2mm).











³² bushing kit C052 required with [KG5458] on Police / Taxi

⁵⁹ Mount kit SM5267 required with [555601], or [555603]

⁷ Use Kit #107

^C To convert from Electronic Susp - See Appendix C

Applications For Pass. Cars, Light Trucks, SUV's, & Vans

VEHICLE MAKE, MODEL & YEAR	GR-2	Gas-a-Just	MonoMax 56XXXX Series	STRUT & SHOCK	
MARQUE, MODELE ET	Excel-G		AGX 7XXXXX Series	MOUNTS	BOOT KITS
ANNEE DU VEHICULE	 	 	 	 	 
LA MARCA EL MODELO & ANO					

MERCURY Lynx, LN7

3/1/85-88	ALL	333141	231002					SM5037	SM5269	SB101	SB103
1985-88	Strut Mount Bearing for SM5037							SM5006			
1983-85	ALL (Built 2/1/83 thru 3/1/85)	234018	231002					SM5268	SM5269	SB101	SB103
1981-2/1/83	ALL		231002					SM5268	SM5269	SB101	SB103

MERCURY Marauder

2003-06	ALL			551602	555603 ⁵⁹					SM5392	SM5267		
---------	-----	--	--	--------	----------------------	--	--	--	--	--------	--------	--	--

MERCURY Mariner

2009-10	ALL	Right Hand Left Hand	235912 235913							SM5390 SM5390	SM5547 ⁶³	SB105 SB105	
	Upper Spring Seat												
2005-08	ALL	Right Hand Left Hand	235912 235913	344356 344356						SM5390 SM5390	SM5547 ⁶³	SB105 SB105	
	Upper Spring Seat												

MERCURY Marquis

1983-86	ALL		235005	343163		KG5559				SM5036		SB103	
1979-82	ALL		343128	343135	KG4515	KG5521							
1967-78	ALL		343128	343149	KG4515	KG5522							

MERCURY Milan

2007-09	AWD	Right Hand Left Hand	341405 341406	349033 349033								SB101 SB101	
2006-10	Mount & Springseat w/ Insulator									SM5540 ⁶³			
2006-09	FWD	Right Hand Left Hand	341405 341406	344363 344363								SB101 SB101	

MERCURY Monarch

1975-80	ALL		343133	343136									
---------	-----	--	--------	--------	--	--	--	--	--	--	--	--	--

MERCURY Montclair

1965-68	ALL		343128	343149		KG5522							
1964	ALL		343127	343136									
1959-60	ALL		343128	343219									
1957-58	ALL		343127										

MERCURY Montego

2007	FWD (Exc. Self Leveling Rear Susp.)	Right Hand Left Hand	334640 334641	341472 341473									
2005-07	AWD	Right Hand Left Hand	334638 334639	341462 341462									
	FWD w/ Self Leveling Rear	Right Hand Left Hand	334640 334641										
2005-06	FWD (Exc. Self Leveling Rear Susp.)	Right Hand Left Hand	334640 334641	341472 341473									
1972-76	ALL		343128	343135	KG4515	KG5521							
1968-71	ALL (Exc. Station Wagon) Station Wagon		343156 343156	343219 343135	KG4505 KG4505	KG5517							

⁵⁹ Mount kit SM5267 required with [555601], or [555603]

⁶³ New Part Number; Available 4th Quarter 2010

Applications For Pass. Cars, Light Trucks, SUV's, & Vans

VEHICLE MAKE, MODEL & YEAR	GR-2	Gas-a-Just	MonoMax 56XXXX Series	STRUT & SHOCK	
MARQUE, MODELE ET	Excel-G		AGX 7XXXXX Series	MOUNTS	BOOT KITS
ANNEE DU VEHICULE					
LA MARCA EL MODELO & ANO					

MERCURY Monterey (Car)

1965-74	ALL	343128	343149		KG5522					
1961-64	ALL	343127	343136							
1959-60	ALL	343127	343219		KG5517					
1957-58	ALL	343127								

MERCURY Monterey (Van)

2007	Mount, Spring Seat & Bearing Lower Spring Seat Insulator Strut Boot							SM5448 SM5463		SB130
2004-07	ALL	235921	344467							SB130
2004-06	Mount, Spring Seat & Bearing Lower Spring Seat Insulator							SM5448 SM5463		

MERCURY Mountaineer

2006-09	ALL Upper Spring Seat Insulator	341474	341475					SM5520		
2004-05	ALL Upper Spring Seat Insulator	341419 ⁶¹	341327 ⁶¹					SM5391 SM5519	SM5391	
2002-03	ALL Upper Spring Seat Insulator	341326 ⁶¹	341327 ⁶¹					SM5391 SM5518	SM5391	
1996-01	ALL (Exc. Electronic Adj. Susp.) AXLE DAMPER (Rear Quad Shock)	341302	344269 SS10201 ⁶³	KG54309	KG5490	561001	565003			

MERCURY Mystique

3/97-00	ALL	235620	235621					SM5138	SM5140	SB105
1995-2/97	ALL	235910	235911					SM5138	SM5140	SB105











MERCURY Sable (also see STRUT-PLUS)

2008-09	AWD FWD		341462 340012 ⁶³ 340013 ⁶³								
2000-05	Sedan	Right Hand	334292	334294	KG5575			SM5113	SM5055	SB103	SB101
		Left Hand	334293	334294				SM5113	SM5055	SB103	SB101
	Station Wagon	Right Hand	334292	344434	KG5575			SM5113	SM5267		
		Left Hand	334293	344434				SM5113	SM5267		
	Upper Spring Seat Upper Spring Seat Insulator (Wagon) Lower Spring Seat Insulator (Wagon) Lower Spring Seat Insulator							SM5227	SM5551 ⁶³ SM5551 ⁶³		
1996-99	Sedan		334168	334169	KG5574			SM5113	SM5055	SB103	SB103
	Station Wagon		334168	344432				SM5113	SM5267	SB103	
	Upper Spring Seat Upper Spring Seat Insulator (Wagon) Lower Spring Seat Insulator (Wagon) Lower Spring Seat Insulator							SM5227	SM5551 ⁶³ SM5551 ⁶³		
								SM5466			
1991-95	Sedan Lower Spring Seat Insulator	235054	334325					SM5038 SM5415	SM5055 SM5414	SB103	SB103
1988-95	Lower Spring Seat Insulator							SM5415			
1986-95	Station Wagon Strut Mount & Bearing Strut Mount Bearing for SM5038 Upper Spring Seat	235054	344271		KG5567			SM5038 SM5271 SM5005 SM5156	SM5267	SB103	
1986-90	ALL (Exc. Station Wagon) Strut Mount (Adjustable)	235054	334325					SM5038 SM5272	SM5015	SB103	SB103

⁶¹ [SM5391] may be required to replace original bushings in mount

⁶³ New Part Number; Available 4th Quarter 2010

Applications For Pass. Cars, Light Trucks, SUV's, & Vans

VEHICLE MAKE, MODEL & YEAR	GR-2	Gas-a-Just	MonoMax 56XXXX Series	STRUT & SHOCK	
MARQUE, MODELE ET	Excel-G		AGX 7XXXX Series	MOUNTS	BOOT KITS
ANNEE DU VEHICULE	 	 	 	 	 
LA MARCA EL MODELO & ANO					

MERCURY Sable (also see STRUT-PLUS) (continued)

1986-90	Upper Spring Seat Insulator							SM5235		
---------	-----------------------------	--	--	--	--	--	--	--------	--	--

MERCURY Sable - STRUT-PLUS

2000-06	Sedan	Right Hand	SR4009	SR4011						
		Left Hand	SR4010	SR4011						
	Station Wagon	Right Hand	SR4009							
		Left Hand	SR4010							
1996-99	Sedan		SR4033	SR4034						
	Station Wagon		SR4033							
1991-95	Sedan		SR4017	SR4018						
1986-95	Station Wagon		SR4017							
1986-90	Sedan		SR4017	SR4018						

MERCURY Topaz

1987-91	AWD		333141					SM5037	SM5014	SB103	SB103
3/1/85-94	ALL (Exc.4WD)		333141	234016				SM5037	SM5014	SB103	SB103
1984-3/1/85	ALL		234015	234016				SM5037	SM5014	SB101	SB103
1984-94	Front Strut Mounting Kit Strut Mount Bearing Upper Spring Seat Insulator							SM5270			
								SM5006	SM5347		

MERCURY Tracer (Canadian Vehicle)

1987	Sedan & Hatchback	Right Hand	234008	232011				SM5039	SM5045	SB102	SB102
		Left Hand	234009	232012				SM5039	SM5045	SB102	SB102
	Station Wagon	Right Hand	234008					SM5039	SM5045	SB102	SB102
		Left Hand	234009					SM5039	SM5045	SB102	SB102

MERCURY Tracer (also see STRUT-PLUS)

1997-99	ALL (Exc. ABS)	Right Hand	235914	234903				SM5044	SM5046	SB105	SB104
		Left Hand	235915	234904				SM5044	SM5046	SB105	SB104
1991-99	Strut Mount w/ Bearing Upper Spring Seat Springseat Insulator							SM5170 SM5155	SM5430		
1991-96	ALL (Exc. ABS & 4WD)	Right Hand	234037	234039				SM5044	SM5046	SB101	SB102
		Left Hand	234038	234040				SM5044	SM5046	SB101	SB102
1988-90	Sedan & Hatchback	Right Hand	234008	232011				SM5039	SM5045	SB102	SB102
		Left Hand	234009	232012				SM5039	SM5045	SB102	SB102
	Station Wagon	Right Hand	234008					SM5039	SM5045	SB102	SB102
		Left Hand	234009					SM5039	SM5045	SB102	SB102

MERCURY Tracer - STRUT-PLUS

1997-99	ALL (Exc. ABS)	Right Hand	SR4012	SR4014							
		Left Hand	SR4013	SR4015							
1991-96	ALL (Exc. ABS & 4WD)	Right Hand	SR4005	SR4007							
		Left Hand	SR4006	SR4008							











MERCURY Villager Mini-Van

1999-02	ALL	Right Hand	334321	344055		KG5538		565065	SM5098		SB101
		Left Hand	334322	344055		KG5538		565065	SM5098		SB101
	Strut Mount w/ Bearing Strut Mount Bearing Lower Spring Seat Insulator								SM5326 SM5064 SM5521		

Notes de bas de Page 259 - Guia de notas al calce del catalogo Pg. 260

Bold part numbers indicate the most comparable KYB product to the original design & performance.
(2) For vehicles with Electronic Susp., Leveling Control, and Air Suspensions refer to Appendix C.

Applications For Pass. Cars, Light Trucks, SUV's, & Vans

VEHICLE MAKE, MODEL & YEAR	GR-2	Gas-a-Just	MonoMax 56XXXX Series	STRUT & SHOCK	
MARQUE, MODELE ET	Excel-G		AGX 7XXXXX Series	MOUNTS	BOOT KITS
ANNEE DU VEHICULE	 	 	 	 	 
LA MARCA EL MODELO & ANO					

MERCURY Villager Mini-Van (continued)

1993-98	ALL	Right Hand Left Hand	235058 235059	344055 344055		KG5538 KG5538		565065 565065	SM5098 SM5098 SM5326 SM5064 SM5521		SB101 SB101	
	Strut Mount w/ Bearing Strut Mount Bearing Lower Spring Seat Insulator											

MERCURY Zephyr

1983	ALL		235005	343163		KG5559			SM5036		SB103	
1982	ALL (Exc. TRX Susp.)		235001	343163		KG5559			SM5036		SB103	
1981-82	ALL w/ TRX Susp.		235005	343163		KG5559			SM5036		SB103	
1978-81	ALL (Exc. TRX Susp.)		235001	343161		KG5551					SB103	

MERKUR Scorpio

1987-89	ALL		235022			KG4546					SB101	
---------	-----	--	--------	--	--	--------	--	--	--	--	-------	--

MERKUR XR4Ti

1985-89	ALL		234026			KG4545					SB101	
---------	-----	--	--------	--	--	--------	--	--	--	--	-------	--

MINI Cooper

2007-08	ALL	Right Hand Left Hand	334621 334622	341924 341924						SM5444 SM5444		
3/02-06	ALL	Right Hand Left Hand	334621 334622	341924 341924					SM5443 SM5443	SM5444 SM5444	SB103 SB103	
	Coupe											SB108

MITSUBISHI 3000GT

1991-99	ALL (Exc. Adjustable Susp. & VR4) FWD (For Adapting ECS to Non-ECS Suspension) VR4 Model w/o Adjustable Susp.		335013 335013 ^c 335013	341183 341184 ^c					SM5096 SM5096 SM5096	SM5091 SM5091 SM5091	SB101 SB101 SB101	SB108 SB108 SB108
1991-95	AWD (For Adapting ECS to Non-ECS Suspension)		335013 ^c	341185 ^c					SM5096	SM5091	SB101	SB108

MITSUBISHI Cordia

1983-88	ALL		235006			KG4192					SB103	
---------	-----	--	--------	--	--	--------	--	--	--	--	-------	--

MITSUBISHI Diamante

2004	ALL		NA	NA								
2001-03	ALL	Right Hand Left Hand	334271 334272	341274 341274					SM5295 SM5295	SM5460 SM5460	SB101 SB101	SB101 SB101
1997-00	ALL	Right Hand Left Hand	334271 334272	341274 341274					SM5194 SM5194	SM5460 SM5460	SB101 SB101	SB101 SB101
1993-96	Station Wagon (Exc. Adj. Damping/Air Height System)		236008						SM5194		SB101	SB108
1992-96	Sedan (Exc. Adj. Damping/Air Height System)		236008	341134					SM5194		SB101	SB108













MITSUBISHI Eclipse

2010	ALL w/ 4 Cyl. Engine ALL w/ 6 Cyl. Engine	Right Hand Left Hand Right Hand Left Hand	339041 339042 335057 335058	341404 341404 341404 341404								
------	--	--	--------------------------------------	--------------------------------------	--	--	--	--	--	--	--	--

^c To convert from Electronic Susp. - See Appendix C

Notes de bas de Page 259 - Guia de notas al calce del catalogo Pg. 260
 Bold part numbers indicate the most comparable KYB product to the original design & performance.
 (22) For vehicles with Electronic Susp., Leveling Control, and Air Suspensions refer to Appendix C.

Applications For Pass. Cars, Light Trucks, SUV's, & Vans

VEHICLE MAKE, MODEL & YEAR	  	STRUT & SHOCK		BOOT KITS	
MARQUE, MODELE ET		MOUNTS			
ANNEE DU VEHICULE					
LA MARCA EL MODELO & ANO					
	 	 	 	 	 

MITSUBISHI Eclipse (continued)

2006-09	ALL w/ 4 Cyl. Engine	Right Hand Left Hand	339041 339042	341404 341404					SM5460 SM5460	SB101 SB101	SB101 SB101	
	ALL w/ 6 Cyl. Engine	Right Hand Left Hand	335057 335058	341404 341404					SM5460 SM5460	SB101 SB101	SB101 SB101	
	Strut Mount & Bearing								SM5441 ⁶³			
2000-05	ALL	Right Hand Left Hand	334267 334268	341164 341164			734019 734020	741020 741020	SM5388 SM5388	SM5091 SM5091 SM5433	SB103 SB103	SB103 SB103
	Upper Spring Seat Insulator											
1995-99	AWD		341163	341164			741042	741020	SM5091	SM5091	SB103	SB103
	FWD		341163	341165			741042	741019	SM5091	SM5091 SM5433	SB103	SB103
	Upper Spring Seat Insulator											
1990-94	AWD		235032	341121			734005	741014	SM5072	SM5091	SB101	SB108
	FWD		235032	341114			734005	741013	SM5072	SM5091	SB101	SB108

MITSUBISHI Endeavor

2004-08	ALL		NA	NA					SM5441 ⁶³		SB102	SB102
	Strut Mount & Bearing											

MITSUBISHI Expo & Expo LRV

1992-96	Wagon 2WD		235032	343262			734005		SM5195	SM5091	SB101	SB108
---------	-----------	--	--------	--------	--	--	--------	--	--------	--------	-------	-------

MITSUBISHI Galant (Exc. Adj. Suspensions)

2009-10	ES & SE Models	Right Hand Left Hand	334432 334433	341373 341373								
2004-09	Strut Mount & Bearing								SM5441 ⁶³			
2004-08	DE, ES & SE Models	Right Hand Left Hand	334432 334433	341373 341373						SM5460 SM5460	SB101 SB101	SB101 SB101
2004-06	LS Model	Right Hand Left Hand	335052 335053								SB101 SB101	
1999-03	ALL	Right Hand Left Hand	235630 235631	341293 341293					SM5388 SM5388	SM5091 SM5091 SM5433	SB103 SB103	SB107 SB107
	Upper Spring Seat Insulator											
1994-98	FWD		341141	341142			741018	741022	SM5091	SM5091	SB101	SB108
1989-93	FWD		235032	341054			734005	741013	SM5242	SM5091	SB101	SB107
1989-92	AWD		235032	341121			734005	741014	SM5242	SM5091	SB101	SB107
1985-88	ALL (Exc. Adj. Susp.) (Exc. ABS Brakes)		235007	341054						SM5091	SB104	SB107
	ALL w/ ECS								SM5321			











MITSUBISHI Lancer

2008-10	DE & ES Models	Right Hand Left Hand	339104 339105	341444 341444								
2008	GTS Model	Right Hand Left Hand	339082 339083	341425 341425								
2006-07	ES Model		334420	341368								
2006	SE Model		334420	341368								
2004-06	Ralliart (Exc. Sportback)		334369						SM5461	SM5091	SB101	SB108
2004	Sportback LS (Wagon)		334420	341368					SM5461	SM5091	SB101	SB108
	Sportback Ralliart Wagon		334369	341368					SM5461	SM5091	SB101	SB108
2002-06	LS Model		334420	341368					SM5461	SM5091	SB101	SB108
	OZ Rally		334420	341368 341349					SM5461	SM5091	SB101 SB104	SB108
	Evolution											
	Strut Mount Bearing Only (Exc. Evolution)								SM5323			

⁶³ New Part Number; Available 4th Quarter 2010

Notes de bas de Page 259 - Guia de notas al calce del catalogo Pg. 260
 Bold part numbers indicate the most comparable KYB product to the original design & performance.
 (22) For vehicles with Electronic Susp., Leveling Control, and Air Suspensions refer to Appendix C.

Applications For Pass. Cars, Light Trucks, SUV's, & Vans

VEHICLE MAKE, MODEL & YEAR		GR-2		Gas-a-Just		MonoMax 56XXXX Series		STRUT & SHOCK			
MARQUE, MODELE ET		Excel-G				AGX 7XXXXX Series		MOUNTS		BOOT KITS	
ANNEE DU VEHICULE											
LA MARCA EL MODELO & ANO		 		 		 		 		 	

MITSUBISHI Lancer (continued)

2002-05	ES Model	333382	341342					SM5461	SM5091	SB101	SB108
---------	----------	--------	--------	--	--	--	--	--------	--------	-------	-------

MITSUBISHI Mirage

4/97-02	1.8 L Eng. w/ 6" Spring O.D.	Right Hand	333318	341140				741033	SM5320	SM5091	SB103	SB108
		Left Hand	333319	341140				741033	SM5320	SM5091	SB103	SB108
	ALL 1.5 L Eng.	Right Hand	332112	341140				741033	SM5320	SM5091	SB103	SB108
		Left Hand	332113	341140				741033	SM5320	SM5091	SB103	SB108
	Strut Mount w/ Bearing								SM5152			
1997 - 3/97	ALL	Right Hand	333224	341140				741033	SM5311	SM5091	SB103	SB108
		Left Hand	333225	341140				741033	SM5311	SM5091	SB103	SB108
1993-9/94	1.5L, 1.8L w/ 6" Spring O.D.	Right Hand	234061	341140					SM5109	SM5091	SB101	SB108
		Left Hand	234062	341140					SM5109	SM5091	SB101	SB108
1989-92	ALL		235033	341084					SM5063	SM5091	SB101	SB108
1987-88	ALL w/ Power Steering		233025	342014		KG3200A			SM5061		SB104	
	ALL w/o Power Steering		233025	342014		KG3200A			SM5062		SB104	
1985-86	ALL		233013	342014		KG3200A			SM5316		SB104	

MITSUBISHI Montero

2005-06	Strut Mounting Kit; Upper Spring Seat Insulator								SM5314			
	Strut Mounting Kit; Upper Spring Seat Insulator								SM5345			
2001-04	ALL	341251	344300	KG9144	KG5743				SM5314		SB104	
	Upper Spring Seat Insulator								SM5345			
1997-00	ALL (Exc. Adjustable Susp.)			KG54302	KG54303	565024	565025					
1992-96	ALL (Exc. Adjustable Susp.)			KG54302	KG54303	565024	565025					
	ALL (For Adapting VSA to Non-VSA Suspension)			KG54302 ^c	KG54303 ^c	565024 ^c	565025 ^c					
1989-91	ALL w/ V6 Engine			KG5603A	KG5491							
1983-89	ALL (Exc. V6 Engine)		344045	KG5603A	KG4034							

MITSUBISHI Montero (4WD) - Steering Stabilizer

1986-88	Complete Kit	SS15345										
---------	--------------	---------	--	--	--	--	--	--	--	--	--	--

MITSUBISHI Montero Sport

2000-04	ALL	344294	344295									
1997-99	ALL		344045	KG54302	KG4034	565024						

MITSUBISHI Outlander

2010	ALL	Right Hand	339080	349040					SM5091	SB101	SB108	
		Left Hand	339081	349040					SM5091	SB101	SB108	
2007-09	ALL	Right Hand	339080	349040					SM5091	SB101	SB108	
		Left Hand	339081	349040					SM5091	SB101	SB108	
2007-08	Strut Mount Bearing								SM5128			
2005-06	ALL	334368	341348						SM5461	SM5091	SB101	SB108
	Strut Mount Bearing								SM5128			
2003-04	ALL	334368	341361						SM5461	SM5091	SB101	SB108
	Strut Mount Bearing								SM5128			

^c To convert from Electronic Susp - See Appendix C

Notes de bas de Page 259 - Guia de notas al calce del catalogo Pg. 260
 Bold part numbers indicate the most comparable KYB product to the original design & performance.
 (22) For vehicles with Electronic Susp., Leveling Control, and Air Suspensions refer to Appendix C.

Applications For Pass. Cars, Light Trucks, SUV's, & Vans

VEHICLE MAKE, MODEL & YEAR	GR-2		Gas-a-Just		MonoMax 56XXXX Series		STRUT & SHOCK			
MARQUE, MODELE ET	Excel-G				AGX 7XXXX Series		MOUNTS		BOOT KITS	
ANNEE DU VEHICULE										
LA MARCA EL MODELO & ANO										

MITSUBISHI Pickup

1982-96	2WD 4WD	344047 344047	344044 344045	KG5433 KG5433	KG5445 KG5438						
1979-81	ALL	344047	344044	KG5433	KG5434						

MITSUBISHI Precis

1990-94	ALL	234043			KG4192			SM5060		SB116	
1989	ALL	365074			KG4192			SM5032		SB116	
1987-88	ALL	365027			KG4192			SM5032		SB103	

MITSUBISHI Raider

2008-09	Strut Boot Upper Spring Seat							SM5546 ⁶³		SB103	
2006-07	ALL Upper Spring Seat	---- ⁷⁰	344378		KG54321			SM5510 SM5546 ⁶³		SB103	

MITSUBISHI Sigma

1989-90	ALL (Exc. Adj. Susp.) (Exc. ABS Brakes) Mount Insulator & Bearing	235007	341054					SM5091 SM5319		SB101	SB107
1988	ALL (Exc. Adj. Susp.) (Exc. ABS Brakes)	235007	341054					SM5316	SM5091	SB104	SB107

MITSUBISHI Starion

9/86-89	ALL (Exc. Adj. Susp.)	Right Hand Left Hand	365060 365060					SM5313 SM5313	SM5310 SM5310	SB102 SB102	SB101 SB101
1983-8/86	ALL (Exc. Adj. Susp.)	Right Hand Left Hand	365029 365029					SM5313 SM5313	SM5310 SM5310	SB102 SB102	SB102 SB102

MITSUBISHI Tredia

1983-88	ALL	235006			KG4192			SM5095		SB103	
---------	-----	--------	--	--	--------	--	--	--------	--	-------	--

MITSUBISHI Van, Wagon

1987-90	ALL	344427	344426	KG5444	KG5401						
---------	-----	--------	--------	--------	--------	--	--	--	--	--	--

NISSAN 110

1970-73	110-Coupe 1200 Shock (Sleeve) Adapter Kit 110-Sedan 1200		343143 ⁵ KIT105 343140							SB103 SB103	
---------	--	--	---	--	--	--	--	--	--	----------------	--

NISSAN 200SX











1995-99	ALL	Right Hand Left Hand	333219 333220	341194 341194			733008 733009	741021 741021	SM5066 SM5066 SM5153 SM5128 SM5559 ⁶³	SM5154 SM5154	SB101 SB101	SB108 SB108
1985-88	ALL		365031	343210		KG4754A						
1984-88	Strut Mounting Kit								SM5322			
1984	1.8L Turbo ALL (Exc. 1.8L Turbo)		365031 365031	343210		KG4754A			SM5064 SM5064		SB103 SB103	
1980-83	ALL		364003	343140		KG4764A					SB103	
1976-79	ALL			343140							SB103	

⁵ Use Kit #105

⁶³ New Part Number; Available 4th Quarter 2010

⁷⁰ New Part Number; Available 2nd Quarter 2010

Applications For Pass. Cars, Light Trucks, SUV's, & Vans

VEHICLE MAKE, MODEL & YEAR	GR-2	Gas-a-Just	MonoMax 56XXXX Series	STRUT & SHOCK	
MARQUE, MODELE ET	Excel-G		AGX 7XXXXX Series	MOUNTS	BOOT KITS
ANNEE DU VEHICULE	 	 	 	 	 
LA MARCA EL MODELO & ANO					

NISSAN 210

1979-82	ALL	364003	343140		KG4764A					SB103	
1973-78	Hatchback	364003	343143 ⁵							SB103	
	Shock (Sleeve) Adapter Kit	364003	KIT105							SB103	
	Sedan		343140							SB103	

NISSAN 240SX

1995-98	ALL	Right Hand	334184	341222			734023	741045	SM5101	SM5154	SB104	SB108
		Left Hand	334185	341222			734024	741045	SM5101	SM5154	SB104	SB108
1989-94	ALL (Exc. Hicas Susp.)	Right Hand	234051	341099			733006	741017	SM5101	SM5154	SB103	SB108
		Left Hand	234052	341099			733007	741017	SM5101	SM5154	SB103	SB108
	ALL w/ Hicas Susp.	Right Hand	234051				733006		SM5101		SB103	
		Left Hand	234052				733007		SM5101		SB103	

NISSAN 240Z

1970-74	ALL		361002	361001					SM5064		SB103	SB103
	Strut Mount Bearing											

NISSAN 260Z

1974-75	ALL (Exc.2+2) From Chassis No. RLS30-060001		361002	361003					SM5064		SB103	SB103
	Strut Mount Bearing											
1974	ALL (Exc.2+2) Thru Chassis No. RLS30-060000		361002	361001							SB103	SB103

NISSAN 280Z

1975-78	ALL		361002	361003					SM5064		SB103	SB103
	Strut Mount Bearing											

NISSAN 280ZX

9/81-83	ALL		365013			KG9113 ²					SB103	
12/80-8/81	ALL w/ Turbo		365013			KG9113 ²					SB103	
1979-83	Strut Mount Bearing								SM5064			
1979-8/81	ALL (Exc. Turbo)		365013	341012		KG9101 ²					SB103	

NISSAN 300ZX

1990-96	ALL (Exc. Adjustable Susp.)	Right Hand	341149	341151			741026	741028	SM5196	SM5154	SB101	SB108
		Left Hand	341150	341151			741027	741028	SM5196	SM5154	SB101	SB108
	ALL (For Adapting ECVSA to Non-ECVSA Suspension)	Right Hand	341149 ^C	341151 ^C			741026 ^C	741028 ^C			SB101	SB108
		Left Hand	341150 ^C	341151 ^C			741027 ^C	741028 ^C			SB101	SB108
1984-89	ALL (Exc. Adjustable Susp.)		365056			KG5787A			SM5097	SM5325	SB104	SB107
	ALL (For Adapting ECVSA to Non-ECVSA Suspension)		365056 ^C			KG5787A ^C					SB104	
	Conversion Kit		KIT108A ^C			KIT108A ^C						
	Strut Mount Bearing								SM5064			

NISSAN 350Z

2006-08	ALL								SM5542 ⁶³	SM5482	SB101	
	Upper Spring Seat Insulator								SM5560 ⁶³			
2004-05	ALL	Right Hand	341366	344455					SM5542 ⁶³	SM5482	SB101	
		Left Hand	341367	344455					SM5542 ⁶³	SM5482	SB101	
	Upper Spring Seat Insulator								SM5560 ⁶³			





² The KYB replacement unit comes with a new dustcover/ bumper assembly.

⁵ Use Kit #105

⁶³ New Part Number; Available 4th Quarter 2010

^C To convert from Electronic Susp. - See Appendix C

Applications For Pass. Cars, Light Trucks, SUV's, & Vans

VEHICLE MAKE, MODEL & YEAR		GR-2 <i>Excel-G</i>		Gas-a-Just		MonoMax 56XXXX Series AGX 7XXXX Series		STRUT & SHOCK MOUNTS		BOOT KITS	
MARQUE, MODELE ET ANNEE DU VEHICULE											
LA MARCA EL MODELO & ANO											

NISSAN 350Z (continued)

2003	ALL	Right Hand	341366	344455					SM5542 ⁶³	SM5482	SB101	SB108
		Left Hand	341367	344455					SM5542 ⁶³	SM5482	SB101	SB108
	Upper Spring Seat Insulator								SM5560 ⁶³			

NISSAN 410, 411

1964-69	ALL		343127	343135	KG4515							
---------	-----	--	--------	--------	--------	--	--	--	--	--	--	--

NISSAN 510

1978-81	ALL (Exc. Station Wagon) Station Wagon		364003 364003	343140							SB103 SB103	
1968-73	Sedan & Coupe			343149							SB103	
1968-72	Station Wagon			343135							SB103	

NISSAN 610

1972-76	ALL (Exc. Station Wagon) Station Wagon			343149 343157							SB103 SB103	
---------	---	--	--	------------------	--	--	--	--	--	--	----------------	--

NISSAN 710

1973-77	ALL (Exc. Station Wagon) Station Wagon			343149 343157							SB103 SB103	
---------	---	--	--	------------------	--	--	--	--	--	--	----------------	--

NISSAN 810

1981	Sedan Station Wagon		365013 365013	341012		KG9101 ²				SM5064		SB103 SB103
1977-80	Sedan & Coupe Station Wagon			341012 343157		KG9101 ²				SM5064 SM5064		SB103 SB103

NISSAN Altima

2008-09	Coupe			349075								
2007-09	Sedan (Exc. Hybrid) Hybrid	Right Hand Left Hand	339146 339147	349075 349075 349075								
2002-06	ALL	Right Hand Left Hand	334336 334337	344395 344395					SM5409 SM5409	SM5381 SM5381	SB104 SB104	SB108 SB108
1998-01	ALL	Right Hand Left Hand	235607 235608	334135 334136					SM5218 SM5218	SM5107 SM5107	SB101 SB101	SB103 SB103
1993-97	ALL	Right Hand Left Hand	235607 235608	334135 334136					SM5106 SM5106	SM5107 SM5107	SB101 SB101	SB103 SB103

NISSAN Armada

2005-09	ALL (Exc. Auto Rear Leveling & Off Road Package)		341600	345066								
2005-07	ALL w/ Off-Road Package		341600									











NISSAN Axxess

1990-94	AWD	Right Hand Left Hand	235051 235052						SM5102 SM5102			
	FWD	Right Hand Left Hand	235051 235052						SM5102 SM5102	SM5100 SM5099	SB103 SB103	SB103 SB103
	Strut Mount Bearing								SM5102 SM5064			

² The KYB replacement unit comes with a new dustcover/ bumper assembly.

⁶³ New Part Number; Available 4th Quarter 2010

Applications For Pass. Cars, Light Trucks, SUV's, & Vans

VEHICLE MAKE, MODEL & YEAR	GR-2	Gas-a-Just	MonoMax 56XXXX Series	STRUT & SHOCK			
MARQUE, MODELE ET	Excel-G		AGX 7XXXXX Series	MOUNTS		BOOT KITS	
ANNEE DU VEHICULE	 	 	 	 	 		
LA MARCA EL MODELO & ANO							

NISSAN Datsun 1600/1800/2000 Roadsters (310, 311 SPL)

1962-70	Datsun 1600, 1800, 2000 Roadsters	343138	343136	KG4528						
---------	-----------------------------------	--------	--------	--------	--	--	--	--	--	--

NISSAN Frontier (2WD)

2009	ALL (Exc. PRO-4X)	341467	345067		555051					
9/2005-08	ALL (Exc. Nismo Off Road)	341467	345067		555051					
2005-08	ALL w/ Nismo Off Road		345067		555051					
05 - 9/2005	ALL (Exc. Nismo Off Road)	341467	345075							
2000-04	ALL w/ 3.3L (Exc. Supercharger)	344469	344015	KG5615	KG4026					
2002-04	ALL w/ Supercharger	344469	344429	KG5615	KG5473					
2001	ALL w/ Supercharger	344043	344044	KG5446	KG4012	565045	565028			
3/2003-04	ALL w/ 2.4L	344468	344429	KG5614	KG5473					
98-3/2003	ALL w/ 2.4L	344427	344429	KG5444	KG5473					

NISSAN Frontier (4WD)

2009	ALL (Exc. PRO-4X)	341467	345067		555051					
9/2005-08	ALL (Exc. Nismo Off Road)	341467	345067		555051					
2005-08	ALL w/ Nismo Off Road		345067		555051					
05 - 9/2005	ALL (Exc. Nismo Off Road)	341467	345075							
2002-04	ALL	344469	344015	KG5615	KG4026					
2001	ALL w/ Supercharger	344043	344044	KG5446	KG4012	565045	565028			
2000-01	ALL (Exc. Crew Cab & Supercharger)	344043	344044	KG5446	KG4012	565045	565028			
	ALL w/ Crew Cab (Exc. Supercharger)	344469	344015	KG5615	KG4026					
1998-99	ALL	344043	344044	KG5446	KG4012	565045	565028			

NISSAN Maxima (Exc. Electronically Adj. Susp.)













2009-10	Strut Boot								SB102	SB108	
2004-08	ALL	Right Hand Left Hand	334336 334337	344450 344450				SM5409 SM5381	SM5381 SB104	SB108 SB108	
2002-03	ALL	Right Hand Left Hand	334366 334367	341341 341341				SM5409 SM5409	SM5217 SM5217	SB104 SB108	
2000-01	ALL	Right Hand Left Hand	334265 334266	341271 341271				SM5409 SM5409	SM5217 SM5217	SB104 SB108	
1995-99	ALL	Right Hand Left Hand	334150 334151	341202 341202			734017 734018	741039 741039	SM5324 SM5324 SM5122 SM5323	SM5123 SM5123	SB104 SB108
	Strut Mount w/ Bearing Strut Mount Bearing Upper Spring Seat Insulator								SM5529		
1989-94	ALL	Right Hand Left Hand	235051 235052	365079 365079				SM5102 SM5102	SM5100 SM5099	SB103 SB101	
	ALL (For Adapting Sonar II to Non-Sonar Suspension II)	Right Hand Left Hand	235051 ^c 235052 ^c	365079 ^c 365079 ^c						SB103 SB101	
	Strut Mount Bearing							SM5064		SB101	
1986-88	ALL	Right Hand Left Hand	235019 235020	361008 361008				SM5065 SM5065	SM5100 SM5099	SB104 SB103	
	ALL (For Adapting ECVSA to Non-ECVSA Suspension)	Right Hand Left Hand	235019 ^c 235020 ^c	365080 ^c 365080 ^c				SM5065 SM5065		SB104 SB103	
1985	ALL	Right Hand Left Hand	235030 235031	361008 361008				SM5065 SM5065	SM5100 SM5099	SB104 SB103	

^c To convert from Electronic Susp - See Appendix C

Notes de bas de Page 259 - Guia de notas al calce del catalogo Pg. 260

Bold part numbers indicate the most comparable KYB product to the original design & performance.
(22) For vehicles with Electronic Susp., Leveling Control, and Air Suspensions refer to Appendix C.

Applications For Pass. Cars, Light Trucks, SUV's, & Vans

VEHICLE MAKE, MODEL & YEAR	  	STRUT & SHOCK		BOOT KITS	
MARQUE, MODELE ET		MOUNTS			
ANNEE DU VEHICULE					
LA MARCA EL MODELO & ANO					
	 	 	 	 	 

NISSAN Maxima (Exc. Electronically Adj. Susp.) (continued)

1985	ALL (For Adapting ECVSA to Non-ECVSA Suspension)	Right Hand Left Hand	235030 ^c 235031 ^c	365080 ^c 365080 ^c					SM5065 SM5065		
1981-84	Sedan Station Wagon		365013 365013	341012		KG9101 ²			SM5064		SB103 SB103

NISSAN Micra (Canadian Vehicle)

1983-92	ALL	Right Hand Left Hand	232017 232018	341056 341056							
---------	-----	-------------------------	------------------	------------------	--	--	--	--	--	--	--

NISSAN Multi (Canadian Vehicle)

1986-89	2WD			344055		KG5538			SM5048		
1986-88	Strut Mounting Kit								SM5327		
1982-85	2WD		364004	344055		KG5538			SM5048		SB102

NISSAN Murano

2009-10	Strut Boot										SB101	
2003-07	ALL	Right Hand Left Hand	334380 334381	344439 344439					SM5409 SM5409	SM5462 SM5462	SB104 SB104	SB103 SB103

NISSAN NX

1991-95	ALL	Right Hand Left Hand	234048 234049	232031 232032			733014 733015	732001 732002		SM5085 SM5085	SB103 SB103	SB103 SB103
---------	-----	-------------------------	------------------	------------------	--	--	------------------	------------------	--	------------------	----------------	----------------

NISSAN Pathfinder (Exc. Armada) (Exc. Adjustable Suspension)

2005-09	ALL		341468	345056 ⁶⁸		555057 ⁶⁸						
2004	2WD	Right Hand	335035	343379		KG4163			SM5203		SB129	
		Left Hand	335036	343379		KG4163			SM5203		SB129	
	4WD	Right Hand	335032	343379		KG4163			SM5203		SB129	
		Left Hand	335033	343379		KG4163			SM5203		SB129	
2002-03	2WD	Right Hand	335035	343379		KG4163			SM5203		SB129	
		Left Hand	335036	343379		KG4163			SM5203		SB129	
	4WD	Right Hand	335032	343379		KG4163			SM5203		SB129	
		Left Hand	335033	343379		KG4163			SM5203		SB129	
12/98-01	ALL	Right Hand	335030	343379		KG4163			SM5203		SB129	
		Left Hand	335031	343379		KG4163			SM5203		SB129	
1996-04	Strut Mount, Bearing & Boot kit Strut Mount Bearing								SM5329 SM5323			
1996-11/98	ALL	Right Hand	335015	343388		KG54318			SM5203		SB129	
		Left Hand	335016	343388		KG54318			SM5203		SB129	
1987-95	ALL ALL (For Adapting ASA to Non-ASA Suspension)		344430	344045	KG5476 KG5476 ^c	KG5438 KG5438 ^c						

NISSAN Pathfinder Armada

2004	Pathfinder Armada (Exc. Auto Rear Leveling)		341600	345066								
------	---	--	--------	--------	--	--	--	--	--	--	--	--

NISSAN Pickup

12/85-97	2WD (Exc. Pathfinder)		343208	344097	KG4605A	KG5473	565029	565057				
	4WD (Exc. Pathfinder)		344043	344044	KG5446	KG4012	565045	565028				
1982-11/85	2WD		343208	344046	KG4605A	KG5447	565029					
	4WD		344043	344045	KG5446	KG5438	565045					

² The KYB replacement unit comes with a new dustcover/ bumper assembly.

⁶⁸ New Part Number: Available 3rd Quarter 2010

^c To convert from Electronic Susp - See Appendix C

Applications For Pass. Cars, Light Trucks, SUV's, & Vans

VEHICLE MAKE, MODEL & YEAR	GR-2		Gas-a-Just		MonoMax 56XXXX Series		STRUT & SHOCK		BOOT KITS	
MARQUE, MODELE ET	Excel-G				AGX		MOUNTS			
ANNEE DU VEHICULE					7XXXXX Series					
LA MARCA EL MODELO & ANO										

NISSAN Pickup (continued)

1981	2WD	343208	344046	KG4605A	KG5447	565029				
	4WD	344043	344046	KG5446	KG5447	565045				
1965-80	ALL	343208	344046	KG4605A	KG5447	565029				

NISSAN Pickup - KYB Lift Kit Replacement Shocks

12/85-97	4WD (Exc. Pathfinder) Lift = 0-2"					565083	565028			
----------	-----------------------------------	--	--	--	--	--------	--------	--	--	--

NISSAN Pulsar

1987-90	ALL	Right Hand	232009	232007				SM5048	SM5048	SB101	SB103
	Strut Mounting Kit	Left Hand	232010	232008				SM5048	SM5048	SB101	SB103
1983-90	Strut Mount Bearing							SM5128			
1983-86	ALL (Exc. Turbo)	Right Hand	232003	342008		KG3792A		SM5048		SB101	
		Left Hand	232004	342008		KG3792A		SM5048		SB101	

NISSAN Quest Mini-Van

2004-09	ALL	Right Hand	334454	344479				SM5409	SM5462	SB101	SB103
		Left Hand	334455	344479				SM5409	SM5462	SB101	SB103
1999-02	ALL	Right Hand	334321	344055		KG5538	565065	SM5098		SB103	
	Strut Mount w/ Bearing	Left Hand	334322	344055		KG5538	565065	SM5098		SB103	
	Strut Mount Bearing							SM5326			
	Lower Spring Seat Insulator							SM5064			
								SM5521			
1993-98	ALL	Right Hand	235058	344055		KG5538	565065	SM5098		SB103	
	Strut Mount w/ Bearing	Left Hand	235059	344055		KG5538	565065	SM5098		SB103	
	Strut Mount Bearing							SM5326			
	Lower Spring Seat Insulator							SM5064			
								SM5521			

NISSAN Sentra

2009-10	Strut Boot									SB101	
2007-08	ALL (Exc. SE-R Spec-V)	Right Hand	333604	341659						SB101	
		Left Hand	333605	341659						SB101	
2002-06	ALL (Exc. SE-R & Spec-V)	Right Hand	333310	341279				SM5216	SM5213	SB101	SB108
		Left Hand	333311	341279				SM5216	SM5213	SB101	SB108
	SE-R, SE-R Spec-V	Right Hand	333394	341279				SM5216	SM5213	SB101	SB108
		Left Hand	333395	341279				SM5216	SM5213	SB101	SB108
2000-01	ALL	Right Hand	333344	341279				SM5216	SM5213	SB101	SB108
		Left Hand	333345	341279				SM5216	SM5213	SB101	SB108
1995-99	ALL (B14)	Right Hand	333219	341194			733008	SM5066	SM5154	SB101	SB108
	Strut Mount Bearing	Left Hand	333220	341194			733009	SM5066	SM5154	SB101	SB108
	Upper Spring Seat w/ Insulator							SM5128			
								SM5559 ⁶³			
1991-95	ALL (B13)	Right Hand	234048	232031			733014	SM5066	SM5085	SB101	SB101
		Left Hand	234049	232032			733015	SM5066	SM5085	SB101	SB101
	Strut Mount Bearing							SM5128			
1987-90	4WD Station Wagon	Right Hand	232009					SM5048		SB103	
		Left Hand	232010					SM5048		SB103	
	ALL (Exc. 4WD Station Wagon)	Right Hand	232009	232007				SM5048		SB101	SB101
		Left Hand	232010	232008				SM5048		SB101	SB101
1/1/86-90	Strut Mounting Kit							SM5327			
1982-86	ALL	Right Hand	232003	342008		KG3792A		SM5048		SB117	
		Left Hand	232004	342008		KG3792A		SM5048		SB117	
	Strut Mount Bearing for SM5048							SM5128			













⁶³ New Part Number; Available 4th Quarter 2010

Notes de bas de Page 259 - Guia de notas al calce del catalogo Pg. 260

Bold part numbers indicate the most comparable KYB product to the original design & performance.

(22) For vehicles with Electronic Susp., Leveling Control, and Air Suspensions refer to Appendix C.

Applications For Pass. Cars, Light Trucks, SUV's, & Vans

VEHICLE MAKE, MODEL & YEAR	  	STRUT & SHOCK		BOOT KITS	
MARQUE, MODELE ET		MOUNTS			
ANNEE DU VEHICULE					
LA MARCA EL MODELO & ANO					
	 	 	 	 	 

NISSAN Sentra Classic (Canadian Vehicle)

1991-92	ALL	Right Hand Left Hand	232009 232010	232007 232008					SM5048 SM5048 SM5327 SM5128	SM5048 SM5048	SB101 SB101	SB101 SB101
	Strut Mounting Kit Strut Mount Bearing for SM5048											

NISSAN Stanza

1990-92	ALL	Right Hand Left Hand		365079 365079						SM5100 SM5099	SB103 SB103	SB104 SB104
1987-89	Sedan & Hatchback	Right Hand Left Hand	235019 235020	361008 361008					SM5065 SM5065	SM5099 SM5100	SB104 SB104	SB103 SB103
1986-90	Strut Mount Kit, 2WD Station Wagon								SM5327			
1986-89	2WD Station Wagon			344055		KG5538			SM5048			
1982-86	Sedan & Hatchback		364004	364005						SM5325	SB102	SB102
1982-85	2WD Station Wagon		364004	344055		KG5538					SB102	

NISSAN Titan

2008-10	2WD 4WD		341600 341600									
2004-07	2WD 4WD		341600 341600	345042 345043		KG6197 KG6196						

NISSAN Versa

2007-10	S & SL Models	Right Hand Left Hand	333390 333391	343465 343465								
---------	---------------	-------------------------	------------------	------------------	--	--	--	--	--	--	--	--

NISSAN X-Trail (Canadian Vehicle)

2005-06	ALL	Right Hand Left Hand	335602 ⁶³ 335603 ⁶³	335604 ⁶³ 335605 ⁶³								
---------	-----	-------------------------	--	--	--	--	--	--	--	--	--	--

NISSAN Xterra

2005-10	4WD RWD		341468 341468	345068 345075		555052						
2000-04	ALL			344015	KG5446	KG4026	565045					

NISSAN Xterra - KYB Lift Kit Replacement Shocks

2000-04	ALL Lift = 0-2"						565083					
---------	-----------------	--	--	--	--	--	--------	--	--	--	--	--

OLDSMOBILE 442

1968-71	ALL		343127	343157	KG4513	KG5504						
1965-67	ALL		343128	343130	KG4515	KG5507						













OLDSMOBILE 88, Delta 88 (Exc. Electronic Susp.) (also see STRUT-PLUS)

1991-99	ALL w/ Self Leveling Rear ALL w/o Self Leveling Rear Upper Spring Seat w/ Insulator Lower Spring Seat Insulator		236007 236007	SR1003 ⁶³ 235025					SM5057 SM5057 SM5230 SM5412	SM5017 SM5017	SB104 SB104	SB128
1990	Early Design Front Struts (w/ SpringGuard) w/ Self-Level Rear Early Design Front Struts (w/ SpringGuard) w/o Self-Level Rear Late Design Front Struts (w/o SpringGuard) w/ Self-Level Rear Late Design Front Struts (w/o SpringGuard) w/o Self-Level Rear		236002 236002 236007 236007	SR1003 ⁶³ 235025 SR1003 ⁶³ 235025					SM5026 SM5026 SM5057 SM5057	SM5017 SM5017	SB105 SB105 SB104 SB104	SB104

⁶³ New Part Number; Available 4th Quarter 2010

Notes de bas de Page 259 - Guia de notas al calce del catalogo Pg. 260
 Bold part numbers indicate the most comparable KYB product to the original design & performance.
 (22) For vehicles with Electronic Susp., Leveling Control, and Air Suspensions refer to Appendix C.

Applications For Pass. Cars, Light Trucks, SUV's, & Vans

VEHICLE MAKE, MODEL & YEAR	  	STRUT & SHOCK		BOOT KITS	
MARQUE, MODELE ET		MOUNTS			
ANNEE DU VEHICULE					
LA MARCA EL MODELO & ANO					
	 	 	 	 	 

OLDSMOBILE 98 (Exc. Electronic Susp.) (also see STRUT-PLUS) (continued)

1985-90	Lower Spring Seat Insulator							SM5411			
1985-86	Coupe & Sedan (FWD)	236002	235025 ²¹					SM5026	SM5017	SB105	
1977-84	Coupe & Sedan (RWD)	343127	343130	KG4515	KG5507						
1971-76	ALL	343127	343130	KG4515	KG5507						
1969-70	ALL	343128	343130	KG4515							
1965-68	ALL	343128		KG4515	KG5508						

OLDSMOBILE 98 (Exc. Electronic Susp.) STRUT-PLUS

1991-96	ALL	SR4022	NA ⁶⁰								
1987-90	ALL		NA ⁶⁰								
1985-86	Coupe & Sedan (FWD)		NA ⁶⁰								

OLDSMOBILE Achieva

1995-98	ALL w/o Swaybar Bracket	Right Hand	235604	343402	KG4552				SM5142	SM5010	SB103
		Left Hand	235605	343402							
	ALL w/ Swaybar Bracket			343402	KG5576				SM5142	SM5010	SB103
	Strut Mount Bearing								SM5142	SM5010	SB103
	Upper Spring Seat w/ Insulator								SM5284		
	Lower Spring Seat Insulator								SM5228		
									SM5431		
1992-94	ALL w/o Swaybar Bracket	Right Hand	235604	343177	KG4536				SM5073	SM5010	SB103
		Left Hand	235605	343177							
	ALL w/ Swaybar Bracket (Exc. Adj. Susp.)			343177	KG4536				SM5073	SM5010	SB103
	Strut Mount Bearing								SM5073	SM5010	SB103
	Upper Springseat w/ Isolator								SM5284		
	Lower Spring Seat Insulator								SM5349		
									SM5431		

OLDSMOBILE Alero (also see STRUT-PLUS)

1999-04	ALL	334229	334295			734056	734057	SM5146	SM5145	SB104	SB101
	Upper Spring Seat Insulator							SM5438			
	Lower Spring Seat Insulator							SM5420	SM5524		

OLDSMOBILE Alero - STRUT-PLUS

1999-04	ALL	SR4001									
---------	-----	--------	--	--	--	--	--	--	--	--	--

OLDSMOBILE Aurora









2001-03	ALL w/ Self Leveling Rear	335037	SR1002 ⁶³						SM5276	SM5334	SB103
	ALL w/o Self Leveling Rear	335037							SM5276	SM5334	SB103
	Upper Spring Seat w/ Insulator (02-03)							SM5435			
	Upper Spring Seat w/ Insulator (2001)							SM5436			
	Lower Spring Seat Insulator							SM5437			
1998-99	ALL	339016							SM5276	SM5334	SB101
	Upper Spring Seat w/ Insulator								SM5436		
	Lower Spring Seat Insulator							SM5437			
1997	Shock Mount									SM5334	
	Upper Spring Seat w/ Insulator							SM5230			
	Lower Spring Seat Insulator							SM5437			
1995-96	ALL	236007							SM5286	SM5334	SB101
	Strut Mount Bearing							SM5284			
	Upper Spring Seat w/ Insulator							SM5230			
	Lower Spring Seat Insulator							SM5412			

²¹ To replace the Original Equipment self-leveling air strut: use KYB gas strut # [235025] with Strut Boot Kit # [SB128]. Deactivate the self-leveling system per Appendix B.

⁶⁰ To eliminate the Original Equipment Air Strut, Use STRUT PLUS [SR4023]

⁶³ New Part Number; Available 4th Quarter 2010

Applications For Pass. Cars, Light Trucks, SUV's, & Vans

VEHICLE MAKE, MODEL & YEAR	GR-2	Gas-a-Just	MonoMax 56XXXX Series	STRUT & SHOCK			
MARQUE, MODELE ET	Excel-G		AGX 7XXXX Series	MOUNTS		BOOT KITS	
ANNEE DU VEHICULE	 	 	 	 	 		
LA MARCA EL MODELO & ANO							

OLDSMOBILE Bravada

2002-04	ALL Mount w/ Spring Insulator Lower Spring Seat Insulator	331016 ⁸¹	343395		KG4162			SM5395 SM5548 ⁶³		SB108	
1991-01	ALL	344042	344041	KG5452	KG5451	565048	565047				

OLDSMOBILE Bravada - KYB Lift Kit Replacement Shocks

1991-01	ALL Lift = 0-2"					565075	565047				
---------	-----------------	--	--	--	--	--------	--------	--	--	--	--

OLDSMOBILE Calais

1987-91	ALL Upper Springseat w/ Isolator	Right Hand Left Hand	231013 231014	343177 343177		KG4536 KG4536		SM5007 SM5007 SM5348	SM5010 SM5010	SB104 SB104	
1985-86	ALL w/ Sealed Struts ALL w/ Rebuildable Struts Upper Springseat w/ Isolator	Right Hand Left Hand	231013 231014 366003 ¹⁸	343177 343177 343177		KG4536 KG4536 KG4536		SM5007 SM5007 SM5007 SM5348	SM5010 SM5010 SM5010	SB104 SB104 SB104	

OLDSMOBILE Custom Cruiser

1977-92	ALL		343127	343157	KG4515	KG5504					
1971-76	ALL		343127	343157	KG4515						

OLDSMOBILE Cutlass (also see STRUT-PLUS)

1998-99	ALL w/ 2.50" Rear Strut Bolt Hole Spacing From Late 1998 Upper Spring Seat Insulator Lower Spring Seat Insulator		334229	334295			734056	734057	SM5146 SM5438 SM5420	SM5145 SM5524	SB104	SB101
1997-98	ALL w/ 3.25" Rear Strut Bolt Hole Spacing to Early 1998 Upper Spring Seat Insulator Lower Spring Seat Insulator		334229	334230			734056		SM5146 SM5438 SM5420	SM5145	SB104	SB101
1978-88	ALL (RWD)		343127	343157	KG4513	KG5548						
1968-77	ALL		343127	343157	KG4513	KG5504						
1964-67	ALL		343128	343130	KG4515	KG5507						

OLDSMOBILE Cutlass - STRUT-PLUS

1998-99	Cutlass w/ 2.50" Rear Strut Bolt Hole Spacing From Late 1998		SR4001									
1997-98	Cutlass w/ 3.25" Rear Strut Bolt Hole Spacing to Early 1998		SR4001									

OLDSMOBILE Cutlass Ciera

1990-96	ALL (Incl. Cruiser)		234019	343160		KG5555			SM5043	SM5010	SB104	
1985-89	ALL		234019	343160		KG5555			SM5056	SM5010	SB104	
1984-96	Upper Spring Seat w/ Insulator								SM5229			
1984	ALL w/ HD Susp. ALL w/ Std. Susp.		234019 234002	343160 343160		KG5555 KG5555			SM5056 SM5056	SM5010 SM5010	SB104 SB104	
1982-83	ALL		234002	343160		KG5555			SM5056		SB104	

OLDSMOBILE Cutlass Supreme (also see STRUT-PLUS)

1990-97	ALL (FWD) w/ HD Susp. ALL (FWD) w/ Std. Susp. Strut Mount Bearing Mount w/ Boot		366004 ²⁰ 366004 ²⁰	236003 236003					SM5030 SM5029 SM5083	SM5016 SM5016	SB104 SB104	SB106 SB106
										SM5277		













¹⁸ Strut must be cut to install cartridge. Check strut for a cut line groove (20mm from strut top). If no cut line groove is found, do not cut strut open as there are no threads inside. The complete strut must be replaced.

²⁰ See Special Installation Instructions Appendix A.

⁶³ New Part Number; Available 4th Quarter 2010

⁸¹ When [331016] stock is depleted, use [331043]

Applications For Pass. Cars, Light Trucks, SUV's, & Vans

VEHICLE MAKE, MODEL & YEAR	  	STRUT & SHOCK		BOOT KITS	
MARQUE, MODELE ET		MOUNTS			
ANNEE DU VEHICULE					
LA MARCA EL MODELO & ANO					
	 	 	 	 	 

OLDSMOBILE Cutlass Supreme (also see STRUT-PLUS) (continued)

1990-97	Lower Spring Seat w/ Bearing Right Hand Left Hand Lower Spring Seat Right Hand Left Hand								SM5384 SM5383 SM5226 SM5225			
1988-89	ALL (FWD) w/ HD Susp. ALL (FWD) w/ Std. Susp. Strut Mount Bearing Mount w/ Boot Lower Spring Seat w/ Bearing Right Hand Left Hand Lower Spring Seat Right Hand Left Hand	366004 ²⁰ 366004 ²⁰	236003 236003						SM5031 SM5025 SM5083 SM5384 SM5383 SM5226 SM5225	SM5016 SM5016 SM5277	SB104 SB104	SB106 SB106
1978-88	ALL (RWD)	343127	343157	KG4513	KG5548							
1968-77	ALL	343127	343157	KG4513	KG5504							
1967	ALL	343128	343130	KG4515	KG5507							

OLDSMOBILE Cutlass Supreme - STRUT-PLUS

1990-97	ALL (FWD) w/ HD Susp. ALL (FWD) w/ Std. Susp.		SR4026 SR4026									
1988-89	ALL (FWD) w/ HD Susp. ALL (FWD) w/ Std. Susp.		SR4026 SR4026									

OLDSMOBILE F85

1968-72	ALL	343127	343157	KG4513	KG5504							
1964-67	ALL	343128	343130	KG4515	KG5507							

OLDSMOBILE Firenza

1987-88	ALL Right Hand Left Hand Upper Springseat w/ Isolator	231013 231014	343177 343177		KG4536 KG4536				SM5007 SM5007 SM5348	SM5010 SM5010	SB104 SB104	
1986	ALL w/ Sealed Struts Right Hand Left Hand ALL w/ Rebuildable Struts Upper Springseat w/ Isolator	231013 231014 366003	343177 343177 343177		KG4536 KG4536 KG4536				SM5007 SM5007 SM5007 SM5348	SM5010 SM5010 SM5010	SB104 SB104 SB104	
1984-85	ALL Upper Springseat w/ Isolator	366003	343177		KG4536				SM5007 SM5348	SM5010	SB104	
1982-83	ALL Upper Springseat w/ Isolator	365038	343177		KG4536				SM5007 SM5348		SB104	

OLDSMOBILE Intrigue

1998-02	ALL Right Hand Left Hand Universal Strut Mount w/ Boot Upper Spring Seat w/ Insulator Upper Spring Seat Insulator Lower Spring Seat Insulator	334227 334227	334228 334228			734058 734058	734059 734059		SM5143 SM5143 SM5470 SM5467	SM5399 SM5398 SM5394 SM5440	SB127 SB127	SB105 SB105
---------	--	------------------	------------------	--	--	------------------	------------------	--	--	--	----------------	----------------











OLDSMOBILE LSS (also see STRUT-PLUS)

1996-99	ALL ALL (For Adapting Air Shock / Strut to Non-Air Suspension)	236007	SR1003 ⁶³ SR4023						SM5057	SM5017	SB104	SB128
---------	--	--------	--------------------------------	--	--	--	--	--	--------	--------	-------	-------

²⁰ See Special Installation Instructions Appendix A.

⁶³ New Part Number; Available 4th Quarter 2010

Applications For Pass. Cars, Light Trucks, SUV's, & Vans

VEHICLE MAKE, MODEL & YEAR	  	STRUT & SHOCK		BOOT KITS	
MARQUE, MODELE ET		MOUNTS			
ANNEE DU VEHICULE					
LA MARCA EL MODELO & ANO					
	 	 	 	 	 

OLDSMOBILE LSS - STRUT-PLUS

1996-99	ALL	SR4022	NA ⁶⁰							
---------	-----	--------	------------------	--	--	--	--	--	--	--

OLDSMOBILE Omega

1984	ALL	234002	343160		KG5555			SM5056	SM5010	SB104
1982-83	ALL	234002	343160		KG5555			SM5056		SB104
1980-81	ALL	234002	343160		KG5555					SB104
1974-79	ALL	343127	343132	KG4515	KG5506					
1973	ALL	343127	343132	KG4515						

OLDSMOBILE Regency (Exc. Elec. Adj. Susp.) (also see STRUT-PLUS)

1997-98	ALL w/ Air Leveling System (Exc. Elec. Adj. Susp.)	236007	SR1003 ⁶³					SM5057	SM5017	SB104	SB128
	ALL w/o Air Leveling System & Elec. Adj. Susp.	236007	235025					SM5057	SM5017	SB104	SB128
	ALL (For Adapting Air Shock / Strut to Non-Air Suspension)		SR4023								
	Upper Spring Seat w/ Insulator							SM5230			
	Lower Spring Seat Insulator							SM5412			

OLDSMOBILE Regency (Exc. Elec. Adj. Susp.) - STRUT-PLUS

1997-98	ALL	SR4022	NA ⁶⁰							
---------	-----	--------	------------------	--	--	--	--	--	--	--

OLDSMOBILE Silhouette Mini-Van (Footnote # 22)

1997-04	ALL w/ Rear Level Control	334227						SM5143		SB127
	ALL w/o Rear Level Control	334227	344338		KG54325			SM5143		SB127
	Upper Spring Seat w/ Insulator							SM5470		
	Upper Spring Seat Insulator							SM5467		
1994-96	ALL w/o Rear Level Control		343160		KG5555			SM5043	SM5010	SB104
	Upper Spring Seat w/ Insulator							SM5229		
1990-93	ALL w/ Rear Level Control	234019	NA ²²					SM5043	SM5010	SB104
	ALL w/o Rear Level Control	234019	343160		KG5555			SM5043	SM5010	SB104
	Upper Spring Seat w/ Insulator							SM5229		

OLDSMOBILE Starfire

1975-80	ALL	343129	343132							
---------	-----	--------	--------	--	--	--	--	--	--	--

OLDSMOBILE Toronado

1990-92	Strut Mounting Kit							SM5279	SM5275	
	Strut Mount Bearing							SM5284		
1986-89	ALL	236004						SM5114		SB105
1979-85	ALL			KG4531	KG5573 ²⁵					
1971-78	ALL (Vertical)		343157	KG4501	KG5504					
1966-70	ALL (Vertical)			KG4501						

OLDSMOBILE Vista Cruiser

1973-77	ALL	343127	343157	KG4513						
1968-72	ALL	343127	343135	KG4513	KG5521					
1964-67	ALL	343128	343135	KG4515	KG5521					





²² For vehicles with Electronic Susp., Leveling Control, and Air Suspensions refer to Appendix C.

²⁵ Eliminates OEM airshocks. See appendix B for special instructions.

⁶⁰ To eliminate the Original Equipment Air Strut, Use STRUT PLUS [SR4023]

⁶³ New Part Number; Available 4th Quarter 2010

Applications For Pass. Cars, Light Trucks, SUV's, & Vans

VEHICLE MAKE, MODEL & YEAR		GR-2		Gas-a-Just		MonoMax 56XXXX Series		STRUT & SHOCK			
MARQUE, MODELE ET		Excel-G				AGX 7XXXXX Series		MOUNTS		BOOT KITS	
ANNEE DU VEHICULE											
LA MARCA EL MODELO & ANO											

OPEL 1900 Sedan & S/W

1971-75	ALL	343141									
---------	-----	--------	--	--	--	--	--	--	--	--	--

OPEL GT

1969-73	ALL		343039		KG5552						
---------	-----	--	--------	--	--------	--	--	--	--	--	--

OPEL Isuzu

1976-79	ALL	343145									
---------	-----	--------	--	--	--	--	--	--	--	--	--

OPEL Kadett

1968-72	ALL		343039		KG5552						
---------	-----	--	--------	--	--------	--	--	--	--	--	--

OPEL Manta, Rallye & Sport Coupe

1973-75	ALL (Exc. Station Wagon)	343141									
---------	--------------------------	--------	--	--	--	--	--	--	--	--	--

PASSPORT I Mark (Canadian Vehicle)

1988-89	ALL (Exc. Lotus Susp.)	Right Hand	232015			KG4542 KG4542			SM5297 SM5297	SB102 SB102	
		Left Hand	232016								
	ALL w/ Lotus Susp.	Right Hand	232015						SM5297 SM5297	SB102 SB102	
		Left Hand	232016								

PASSPORT Impulse (Canadian Vehicle)

1990-92	2WD w/ Lotus Susp.	Right Hand	234041	332076					SM5081 SM5081	SB102 SB102	SB105 SB105
		Left Hand	234042	332077							
	ALL (Exc. Lotus Susp. & Exc. 4WD)	Right Hand	234041	232033					SM5081 SM5081	SB102 SB102	SB105 SB105
		Left Hand	234042	232034							
	AWD	Right Hand	234041						SM5081 SM5081	SB102 SB102	SB105 SB105
		Left Hand	234042								

PASSPORT Optima (Canadian Vehicle)

1988-93	Strut / Shock Mount								SM5278	SM5010	
1988-91	ALL	365025			KG4543						SB101

PASSPORT Stylus (Canadian Vehicle)

1991-93	ALL (Exc. Lotus Susp.)	Right Hand	234041	232033					SM5081 SM5081	SB102 SB102	SB105 SB105
		Left Hand	234042	232034							
	ALL w/ Lotus Susp.	Right Hand	234041	332076					SM5081 SM5081	SB102 SB102	SB105 SB105
		Left Hand	234042	332077							

PEUGEOT 405, 504, 505, 604

1989-91	405	235026	341102								SB101
10/85-88	505 Sedan				KG5566						SB117
1980-9/85	505 Sedan(Exc. Turbo)	364002			KG5566						SB117
	505 Station Wagon(Exc. Turbo)	364002									SB105
1980-83	504 Station Wagon	364002									SB105
1976-82	604SL, TI, STI	364002			KG5566						SB105
1976-79	504, 505 Sedans	364002			KG5566						SB105





PININFARINA Azzura (Spider)

1983-85	ALL	343141	343142								
---------	-----	--------	--------	--	--	--	--	--	--	--	--

Notes de bas de Page 259 - Guia de notas al calce del catalogo Pg. 260

Bold part numbers indicate the most comparable KYB product to the original design & performance.
(2) For vehicles with Electronic Susp., Leveling Control, and Air Suspensions refer to Appendix C.

Applications For Pass. Cars, Light Trucks, SUV's, & Vans

VEHICLE MAKE, MODEL & YEAR		GR-2		Gas-a-Just		MonoMax 56XXXX Series		STRUT & SHOCK			
MARQUE, MODELE ET		Excel-G				AGX 7XXXXX Series		MOUNTS		BOOT KITS	
ANNEE DU VEHICULE											
LA MARCA EL MODELO & ANO											
											

PLYMOUTH Acclaim

1989-95	ALL Upper Spring Seat Spacer Upper Spring Seat Lower Spring Seat Insulator	235902	343164		KG5563				SM5003 SM5219 SM5130 SM5131		SB103	
---------	---	--------	--------	--	--------	--	--	--	--------------------------------------	--	-------	--

PLYMOUTH Arrow (Car)

1976-81	ALL		343030		KG4006						SB103	
---------	-----	--	--------	--	--------	--	--	--	--	--	-------	--

PLYMOUTH Arrow (Truck)

1982-83	2WD 4WD	344047 344047	344044 344045	KG5433 KG5433	KG5445 KG5438							
1979-81	ALL	344047	344044	KG5433	KG5434							

PLYMOUTH Barracuda

1970-74	ALL			KG4510	KG5512							
1964-69	ALL			KG4509	KG5511							

PLYMOUTH Belvedere

1962-70	ALL		343159	KG4510	KG5512							
---------	-----	--	--------	--------	--------	--	--	--	--	--	--	--

PLYMOUTH Breeze

2000	ALL	344609	344610						SM5263	SM5137	SB108	SB107
1996-99	ALL	344609	344610						SM5262	SM5137	SB108	SB107

PLYMOUTH Caravelle (FWD)

1/86-88	ALL Upper Spring Seat Spacer Upper Spring Seat Lower Spring Seat Insulator	235902	343164		KG5563				SM5002 SM5219 SM5130 SM5131		SB104	
84-12/85	ALL	234003	343164		KG5563				SM5004		SB104	
1983	ALL	234001	343164		KG5563				SM5004		SB104	

PLYMOUTH Caravelle (RWD)

1977-89	ALL	343138	343139	KG4528	KG5546							
---------	-----	--------	--------	--------	--------	--	--	--	--	--	--	--

PLYMOUTH Champ











1984	w/ Turbo ALL (Exc. Turbo)	233013 365027			KG4192 KG4192				SM5032 SM5032		SB103 SB103	
1982-83	ALL	365027							SM5032		SB103	
1979-81	ALL	365027			KG4192				SM5032		SB103	

PLYMOUTH Colt (Exc. Colt Vista)

1993-94	ALL (Exc. CA2A Model)	Right Hand Left Hand	234061 234062	341140 341140					SM5109 SM5109	SM5091 SM5091	SB101 SB101	SB107 SB107
1989-92	ALL (Exc. Station Wagon)		235033	341084					SM5063	SM5091	SB101	SB107
1987-90	Station Wagon w/ Power Steering Station Wagon w/o Power Steering		233025 233025						SM5061 SM5062		SB104 SB104	
1987-88	ALL w/ Power Steering (Exc. Station Wagon) ALL w/o Power Steering (Exc. Station Wagon)		233025 233025	342014 342014	KG3200A KG3200A				SM5061 SM5062		SB104 SB104	
1985-86	ALL		233013	342014	KG3200A				SM5316		SB104	

Notes de bas de Page 259 - Guia de notas al calce del catalogo Pg. 260
 Bold part numbers indicate the most comparable KYB product to the original design & performance.
 (22) For vehicles with Electronic Susp., Leveling Control, and Air Suspensions refer to Appendix C.

Applications For Pass. Cars, Light Trucks, SUV's, & Vans

VEHICLE MAKE, MODEL & YEAR	GR-2	Gas-a-Just	MonoMax 56XXXX Series	STRUT & SHOCK	
MARQUE, MODELE ET	Excel-G		AGX 7XXXX Series	MOUNTS	BOOT KITS
ANNEE DU VEHICULE	 	 	 	 	 
LA MARCA EL MODELO & ANO					

PLYMOUTH Colt (Exc. Colt Vista) (continued)

1984	ALL (Exc. Sealed Struts)	365027			KG4192			SM5032		SB103	
1982-83	ALL	365027						SM5032		SB103	
1979-81	ALL (Exc. Station Wagon)	365027			KG4192			SM5032		SB103	
1977-80	Station Wagon		343030		KG4006			SM5315		SB103	

PLYMOUTH Colt Vista

1992-94	FWD	235032	343262					SM5195	SM5091	SB101	SB108
1986-91	4WD Station Wagon	235050			KG4192			SM5095		SB103	
1984-91	FWD Station Wagon	235006			KG4192			SM5095		SB103	

PLYMOUTH Conquest

1984-8/86	ALL (Exc. Adj. Susp.)	Right Hand	365029					SM5313	SM5310	SB102	SB102
		Left Hand	365029					SM5313	SM5310	SB102	SB102

PLYMOUTH Cuda

1970-74	ALL				KG4510	KG5512					
---------	-----	--	--	--	--------	--------	--	--	--	--	--

PLYMOUTH Duster

1970-76	ALL				KG4509	KG5511					
---------	-----	--	--	--	--------	--------	--	--	--	--	--

PLYMOUTH Fury

1977-78	ALL (Exc. Police Package)	343158	343139								
	ALL w/ Police Package	343158	343159			KG5546					
						KG5512					
1975-76	ALL	343158	343159			KG5512					
1974	ALL	343138	343159	KG4528		KG5512					
1965-73	ALL		343159	KG4507		KG5512					
1962-64	ALL		343159	KG4510		KG5512					
1957-61	ALL		343159			KG5511					

PLYMOUTH GTX

1967-71	ALL		343159	KG4510	KG5512						
---------	-----	--	--------	--------	--------	--	--	--	--	--	--

PLYMOUTH Gran Fury

1982-89	ALL	343138	343139	KG4528		KG5546					
1980-81	ALL	343158	343139			KG5546					
1975-77	ALL	343138	343159	KG4528		KG5512					
1972-73	ALL		343159	KG4507		KG5512					

PLYMOUTH Horizon









1990	ALL		341037					SM5001	SM5018	SB103	
1981-89	ALL 4 Door	234001	341037					SM5001	SM5018	SB101	
1981-87	ALL 2 Door	234001	341036					SM5001	SM5018	SB101	
1978-80	ALL 2 Door	234001						SM5001	SM5018	SB101	
	ALL 4 Door	234001	341035					SM5001	SM5018	SB101	

PLYMOUTH Laser

1992-94	AWD	235032	341121			734005	741014	SM5072	SM5091	SB101	SB108
1990-94	FWD	235032	341114			734005	741013	SM5072	SM5091	SB101	SB108

Notes de bas de Page 259 - Guia de notas al calce del catalogo Pg. 260
 Bold part numbers indicate the most comparable KYB product to the original design & performance.
 (2) For vehicles with Electronic Susp., Leveling Control, and Air Suspensions refer to Appendix C.

Applications For Pass. Cars, Light Trucks, SUV's, & Vans

VEHICLE MAKE, MODEL & YEAR	  	STRUT & SHOCK		BOOT KITS	
MARQUE, MODELE ET		MOUNTS			
ANNEE DU VEHICULE					
LA MARCA EL MODELO & ANO					
	 	 	 	 	 

PLYMOUTH Neon

2000-01	ALL Right Hand Left Hand	235627 235627	235628 235629					SM5265 SM5265 SM5199 SM5344 SM5417	SM5198 SM5198 SM5464	SB104 SB104	SB101 SB101
	Mount & Springseat w/ Insulator Upper Spring Seat w/ Insulator Lower Spring Seat Insulator										
1995-99	ALL (Exc. Competition Model) Upper Spring Seat Lower Spring Seat Insulator	234902	234901					SM5136 SM5158	SM5135 SM5464	SB101	SB103

PLYMOUTH Prowler

1997-01	ALL	NA	NA								
---------	-----	----	----	--	--	--	--	--	--	--	--

PLYMOUTH Reliant

1/86-89	ALL Upper Spring Seat Spacer Upper Spring Seat Lower Spring Seat Insulator	235902	343164		KG5563			SM5003 SM5219 SM5130 SM5131		SB104	
84-12/85	ALL	234003	343164		KG5563			SM5004		SB104	
1983	ALL	234001	343164		KG5563			SM5002		SB101	
1981-82	ALL	234001	343164		KG5563			SM5001		SB101	

PLYMOUTH Roadrunner, Superbird

1976-79	ALL	343138	343139	KG4528	KG5546						
1973-75	ALL	343158	343159		KG5512						
1971-72	ALL			KG4510	KG5512						
1968-70	ALL		343159	KG4510	KG5512						

PLYMOUTH Sapporo

1981-83	ALL	365029						SM5312			
---------	-----	--------	--	--	--	--	--	--------	--	--	--

PLYMOUTH Satellite

1973-74	ALL	343158	343159		KG5512						
1965-72	ALL		343159	KG4510	KG5512						

PLYMOUTH Scamp

1983	ALL	234001						SM5001		SB101	
1971-76	ALL			KG4509	KG5511						

PLYMOUTH Sundance

1987-94	ALL Upper Spring Seat Spacer Upper Spring Seat Lower Spring Seat Insulator	235902	343164		KG5563			SM5003 SM5219 SM5130 SM5131		SB104	
---------	---	--------	--------	--	--------	--	--	--------------------------------------	--	-------	--

PLYMOUTH Trail Duster

1976-83	4WD	344074	344086	KG5422	KG5423						
1975-83	2WD	344066	344070	KG5403	KG5413						
1974-75	4WD	344074	344070	KG5422	KG5413						

Notes de bas de Page 259 - Guia de notas al calce del catalogo Pg. 260
 Bold part numbers indicate the most comparable KYB product to the original design & performance.
 (2) For vehicles with Electronic Susp., Leveling Control, and Air Suspensions refer to Appendix C.

Applications For Pass. Cars, Light Trucks, SUV's, & Vans

VEHICLE MAKE, MODEL & YEAR	GR-2		Gas-a-Just		MonoMax 56XXXX Series		STRUT & SHOCK			
MARQUE, MODELE ET	Excel-G				AGX		MOUNTS		BOOT KITS	
ANNEE DU VEHICULE					7XXXXX Series					
LA MARCA EL MODELO & AÑO										

PLYMOUTH VIP

1967	ALL		343159	KG4507	KG5512						
------	-----	--	--------	--------	--------	--	--	--	--	--	--

PLYMOUTH Valiant

1960-76	ALL			KG4509	KG5511						
---------	-----	--	--	--------	--------	--	--	--	--	--	--

PLYMOUTH Volare

1976-80	ALL	343138	343139	KG4528	KG5546						
---------	-----	--------	--------	--------	--------	--	--	--	--	--	--

PLYMOUTH Voyager Van PB100, PB150

1974-83	ALL	344066	344073	KG5403	KG5418						
---------	-----	--------	--------	--------	--------	--	--	--	--	--	--

PLYMOUTH Voyager Van PB200, PB250

1974-83	ALL	344066	344073	KG5403	KG5418						
---------	-----	--------	--------	--------	--------	--	--	--	--	--	--

PLYMOUTH Voyager Van PB300, PB350

1974-83	ALL (Exc. w/ 4000 lb. Front Axle)	344066	344073	KG5403	KG5418						
	ALL w/ 4000 lb. Front Axle			KG5404	KG5418						

PLYMOUTH Voyager, Grand Voyager Mini-Van (also see STRUT-PLUS)

1997-00	ALL w/ Nivomat Rear Susp.	334188	SR2001					SM5112		SB126	
1996-00	ALL (Exc. AWD Model) (Exc. Nivomat Rear Susp.) Upper Spring Seat Lower Spring Seat Insulator	334188	344080		KG5457			SM5112 SM5157 SM5410		SB126	
1986-95	ALL (Incl. AWD) Upper Spring Seat Spacer Upper Spring Seat Strut Lower Springseat Insulator	235901	344080		KG5457			SM5003 SM5219 SM5130 SM5131		SB126	
1984-85	ALL	234004	344080		KG5457			SM5004		SB126	

PLYMOUTH Voyager, Grand Voyager Mini Van - STRUT-PLUS

1996-00	ALL V6 Eng. (Exc. Nivomat Load Leveling Rear Susp.) Right Hand Left Hand ALL V6 Eng. w/ Nivomat Rear Susp. (Exc. AWD) Right Hand Left Hand	SR4020 SR4021 SR4020 SR4021									
1987-95	ALL V6 Eng. (Incl. AWD)	SR4019									

PONTIAC 6000

1990-91	ALL (Exc. All Wheel Drive)	234019	343160		KG5555			SM5043	SM5010	SB104	
1990	AWD	234019						SM5043	SM5010	SB104	
1989	AWD	234019						SM5056	SM5010	SB104	
1985-89	ALL (Exc. STE)	234019	343160		KG5555			SM5056	SM5010	SB104	
1984-91	Upper Spring Seat w/ Insulator							SM5229			
1984-88	STE Model (Exc. AWD)	234019	343160 ²²		KG5555 ²²			SM5056	SM5010	SB104	
1984	ALL (Exc. HD Susp. & STE)	234002	343160		KG5555			SM5056	SM5010	SB104	
	ALL w/ HD Susp. (Exc. STE)	234019	343160		KG5555			SM5056	SM5010	SB104	
1982-83	ALL	234002	343160		KG5555			SM5056		SB104	

²² For vehicles with Electronic Susp., Leveling Control, and Air Suspensions refer to Appendix C.

Notes de bas de Page 259 - Guia de notas al calce del catalogo Pg. 260

Bold part numbers indicate the most comparable KYB product to the original design & performance.

(22) For vehicles with Electronic Susp., Leveling Control, and Air Suspensions refer to Appendix C.

Applications For Pass. Cars, Light Trucks, SUV's, & Vans

VEHICLE MAKE, MODEL & YEAR									
MARQUE, MODELE ET	GR-2	Gas-a-Just	MonoMax 56XXXX Series	STRUT & SHOCK					
ANNEE DU VEHICULE	Excel-G		AGX 7XXXXX Series	MOUNTS		BOOT KITS			
LA MARCA EL MODELO & ANO									

PONTIAC Acadian (Canadian Vehicle)

1976-87	ALL	343145	343147						
---------	-----	--------	--------	--	--	--	--	--	--

PONTIAC Astre

1975-77	ALL	343129	343132						
---------	-----	--------	--------	--	--	--	--	--	--

PONTIAC Aztek

2001-05	AWD (Exc. Rear Air Leveling) FWD (Exc. Rear Air Leveling) Upper Spring Seat w/ Insulator Upper Spring Seat Insulator Lower Spring Seat Insulator	335044 335044	344338					SM5143 SM5143 SM5470 SM5467 SM5437	SB127 SB127
---------	--	------------------	--------	--	--	--	--	--	----------------













PONTIAC Bonneville (Exc. Elect. Adj. Susp.) (also see STRUT-PLUS)

2002-05	ALL Upper Spring Seat w/ Insulator Lower Spring Seat Insulator	335037	SR1002 ⁶³					SM5276 SM5435 SM5437	SM5334	SB101	
2000-01	ALL Upper Spring Seat w/ Insulator Lower Spring Seat Insulator	335037	SR1002 ⁶³					SM5276 SM5436 SM5437	SM5334	SB101	
1991-99	ALL w/ Self Leveling Rear ALL w/o Self Leveling Rear ALL (For Adapting Air Shock / Strut to Non-Air Suspension) Upper Spring Seat w/ Insulator	236007 236007	SR1003 ⁶³ 235025 SR4023					SM5057 SM5057	SM5017 SM5017	SB104 SB104	SB128 SB128
1990-99	Lower Spring Seat Insulator Fits the 2nd Design Spring Seat w/o Bracket							SM5230			
Late 90-96	Strut Mount Bearing (Exc. FE2 or FW1 Susp.)							SM5412			
1990	Early Design Front Struts (w/ SpringGuard) w/ Self-Level Rear Early Design Front Struts (w/ SpringGuard) w/o Self-Level Rear Late Design Front Struts (w/o SpringGuard) w/ Self-Level Rear Late Design Front Struts (w/o SpringGuard) w/o Self-Level Rear ALL (For Adapting Air Shock / Strut to Non-Air Suspension)	236002 236002 236007 236007	SR1003 ⁶³ 235025 SR1003 ⁶³ 235025 SR4023					SM5026 SM5026 SM5057 SM5057	SM5017 SM5017 SM5017 SM5017	SB105 SB105 SB104 SB104	SB104 SB104
87-Early 90	Strut Mounting Kit Strut Mount Bearing Upper Springs/seat w/ Isolator							SM5281 SM5284 SM5350			
1987-90	Lower Spring Seat Insulator Fits the 1st Design Spring Seat w/ bracket							SM5411			
1987-89	ALL w/ Self Leveling Rear ALL w/o Self Leveling Rear ALL (For Adapting Air Shock / Strut to Non-Air Suspension)	236002 236002	SR1003 ⁶³ 235025 SR4023					SM5026 SM5026	SM5017 SM5017	SB105 SB105	SB104 SB104
1982-86	Bonneville Model G	343127	343157	KG4513	KG5548						
1971-81	Sedan & Coupe Station Wagon	343127 343127	343130 343157	KG4515 KG4515	KG5507 KG5504						
1963-70	ALL	343128	343130	KG4515	KG5507						
1961-62	ALL	343128		KG4550							
1958-60	Sedan & Coupe (Exc. Air Susp.) Station Wagon (Exc. Air Susp.)	343128 343128	344045 344044	KG4550 KG4550							

⁶³ New Part Number; Available 4th Quarter 2010

Notes de bas de Page 259 - Guia de notas al calce del catalogo Pg. 260
 Bold part numbers indicate the most comparable KYB product to the original design & performance.
 (22) For vehicles with Electronic Susp., Leveling Control, and Air Suspensions refer to Appendix C.

Applications For Pass. Cars, Light Trucks, SUV's, & Vans

VEHICLE MAKE, MODEL & YEAR	  	STRUT & SHOCK		BOOT KITS	
MARQUE, MODELE ET		MOUNTS			
ANNEE DU VEHICULE					
LA MARCA EL MODELO & ANO	 	 	 	 	 

PONTIAC Bonneville (Exc. Adj. Susp.) - STRUT-PLUS

1991-99	Bonneville w/ Self Leveling Rear Bonneville w/o Self Leveling Rear	SR4022 SR4022	NA ⁶⁰ SR4023							
1990	Bonneville Late Design Front Struts (w/o SpringGuard) w/ Self-Level Rear Bonneville Late Design Front Struts (w/o SpringGuard) w/o Self-Level Rear Bonneville Early Design Front Struts (w/ SpringGuard) w/ Self-Level Rear Bonneville Early Design Front Struts (w/ SpringGuard) w/o Self-Level Rear	SR4022 SR4022	NA ⁶⁰ SR4023 NA ⁶⁰ SR4023							
1987-89	Bonneville w/ Self Leveling Rear Bonneville w/o Self Leveling Rear		NA ⁶⁰ SR4023							

PONTIAC Catalina

1971-81	Sedan & Coupe Station Wagon	343127 343127	343130 343157	KG4515 KG4515	KG5507 KG5504					
1971-72	Convertible	343127	343130	KG4515	KG5507					
1963-70	ALL	343128	343130	KG4515	KG5507					
1958-62	ALL	343128		KG4550						

PONTIAC Fiero

1988	ALL	343127		KG4513				SM5190		SB103
1984-87	ALL		234005	KG4538				SM5190		SB103

PONTIAC Firebird, Trans Am

1993-02	ALL V6 ALL V8	Right Hand Left Hand Right Hand Left Hand	341356 341356 341356 341356	343211 343211 343211 343211	KG9310 KG9310 KG9310 KG9310	KG5562 KG5562 KG5562 KG5562	741034 741034 741034 741034	743019 743019 743019 743019	SM5119 SM5118 SM5119 SM5118	SB103 SB103 SB103 SB103
1982-92	ALL	Right Hand Left Hand	236001 236001	343211 343211		KG5562 KG5562	735001 735001	743019 743019	SM5028 SM5027	
1970-81	ALL		343128	343131	KG4515	KG5526				
1968-69	ALL		343127	343135	KG4515	KG5521				
1967	ALL Shock (Sleeve) Adapter Kit		343127	343135 ⁷ KIT107	KG4515	KG5524				

PONTIAC Firefly (Canadian Vehicle)

1989-92	ALL	Right Hand Left Hand	232025 232026	232027 232027					SM5188 SM5188	SM5189 SM5189	SB103 SB103	SB101 SB101
1987-88	ALL	Right Hand Left Hand	232019 232020	341075 341075								
1985-86	ALL	Right Hand Left Hand		342012 342012								

PONTIAC G3

2009	ALL	Right Hand Left Hand	333417 333418	343423 343423					SM5451 SM5451	SM5452 SM5452	SB101 SB101	SB107 SB107
------	-----	-------------------------	------------------	------------------	--	--	--	--	------------------	------------------	----------------	----------------



PONTIAC G5

2009	ALL			349043					SM5513		SB101	
2007-08	ALL	Right Hand Left Hand	339084 339085	349043 349043					SM5513 SM5513		SB101 SB101	

⁶⁰ To eliminate the Original Equipment Air Strut, Use STRUT PLUS [SR4023]

⁷ Use Kit #107

Applications For Pass. Cars, Light Trucks, SUV's, & Vans

VEHICLE MAKE, MODEL & YEAR		  	STRUT & SHOCK		BOOT KITS		
MARQUE, MODELE ET			MOUNTS				
ANNEE DU VEHICULE							
LA MARCA EL MODELO & ANO							

PONTIAC G6												
2006-09	ALL	Right Hand	339051	349008					SM5471	SM5476	SB101	
		Left Hand	339052	349008					SM5447	SM5476	SB101	
2005	ALL	Right Hand	339051	349008					SM5471	SM5476	SB101	
		Left Hand	339052	349008					SM5447	SM5476	SB101	

PONTIAC G8												
2008-09	ALL								SM5146		SB103	

PONTIAC GTO												
2004-06	ALL	Right Hand	334680 ⁶³	341670 ⁶³					SM5285		SB103	
		Left Hand	334681 ⁶³	341670 ⁶³					SM5285		SB103	
1974	ALL		343127	343132	KG4515	KG5506						
1968-73	ALL		343127	343157	KG4513	KG5504						
1964-67	ALL (Exc. HD Susp.) w/ HD Susp.		343128	343130	KG4515	KG5507						
			343128	343130	KG4515	KG5504						

PONTIAC Grand Am (also see STRUT-PLUS)												
1999-05	ALL		334229	334295			734056	734057	SM5146	SM5145	SB104	SB101
	Upper Spring Seat Insulator								SM5438			
	Lower Spring Seat Insulator								SM5420	SM5524		
1995-98	ALL w/o Swaybar Bracket	Right Hand	235604	343402		KG4552			SM5142	SM5010	SB103	
		Left Hand	235605	343402		KG4552			SM5142	SM5010	SB103	
	ALL w/ Swaybar Bracket			343402		KG5576			SM5142	SM5010	SB103	
	Strut Mount Bearing								SM5284			
	Upper Spring Seat w/ Insulator								SM5228			
	Lower Spring Seat Insulator								SM5431			
1992-94	ALL w/o Swaybar Bracket	Right Hand	235604	343177		KG4536			SM5073	SM5010	SB104	
		Left Hand	235605	343177		KG4536			SM5073	SM5010	SB104	
	ALL w/ Swaybar Bracket (Exc. Adj. Susp.)			343177		KG4536			SM5073	SM5010	SB104	
	Strut Mount Bearing								SM5284			
	Upper Springseat w/ Isolator								SM5349			
	Lower Spring Seat Insulator								SM5431			
1987-91	ALL	Right Hand	231013	343177		KG4536			SM5007	SM5010	SB104	
		Left Hand	231014	343177		KG4536			SM5007	SM5010	SB104	
	Upper Springseat w/ Isolator								SM5348			
	Lower Spring Seat Insulator								SM5431			
1985-86	ALL w/ Sealed Struts	Right Hand	231013	343177		KG4536			SM5007	SM5010	SB104	
		Left Hand	231014	343177		KG4536			SM5007	SM5010	SB104	
	ALL w/ Rebuildable Struts		366003 ¹⁸	343177		KG4536			SM5007	SM5010	SB104	
	Upper Springseat w/ Isolator								SM5348			
	Lower Spring Seat Insulator								SM5431			
1978-80	ALL		343127	343157	KG4513	KG5548						
1973-75	ALL		343127	343157	KG4513	KG5504						













PONTIAC Grand Am (FWD) - STRUT-PLUS												
1999-05	ALL		SR4001	SR4037 ⁶³								

PONTIAC Grand LeMans												
1978-83	ALL		343127	343157	KG4513	KG5548						
1975-77	Sedan & Coupe Station Wagon		343127	343157	KG4513	KG5504						
			343127	343157	KG4513							

¹⁸ Strut must be cut to install cartridge. Check strut for a cut line groove (20mm from strut top). If no cut line groove is found, do not cut strut open as there are no threads inside. The complete strut must be replaced.

⁶³ New Part Number; Available 4th Quarter 2010

Applications For Pass. Cars, Light Trucks, SUV's, & Vans

VEHICLE MAKE, MODEL & YEAR	  	STRUT & SHOCK		BOOT KITS	
MARQUE, MODELE ET		MOUNTS			
ANNEE DU VEHICULE					
LA MARCA EL MODELO & ANO					
	 	 	 	 	 

PONTIAC Grand Prix (also see STRUT-PLUS)

2004-08	ALL (Exc. GXP) Upper Spring Seat w/ Insulator Upper Spring Seat Insulator Lower Spring Seat Insulator	Right Hand Left Hand	339089 339089	334228 334228					SM5143 SM5143 SM5470 SM5467 SM5437	SM5399 SM5398 SM5440	SB127 SB127	SB104 SB104
1999-03	ALL Upper Spring Seat w/ Insulator Upper Spring Seat Insulator Lower Spring Seat Insulator	Right Hand Left Hand	339015 339015	334228 334228			734058 734058	734059 734059	SM5143 SM5143 SM5470 SM5467 SM5437	SM5399 SM5398 SM5440	SB127 SB127	SB105 SB105
1997-08	Universal Strut Mount Universal Strut Mount w/ Boot									SM5144 SM5394		
1997-98	ALL Upper Spring Seat w/ Insulator Upper Spring Seat Insulator Lower Spring Seat Insulator	Right Hand Left Hand	334227 334227	334228 334228			734058 734058	734059 734059	SM5143 SM5143 SM5470 SM5467 SM5437	SM5399 SM5398 SM5440	SB127 SB127	SB105 SB105
1990-96	ALL (FWD) w/ HD Susp. ALL (FWD) w/ Std. Susp.		366004 ²⁰ 366004 ²⁰	236003 236003					SM5030 SM5029	SM5016 SM5016	SB104 SB104	SB106 SB106
1988-96	Strut Mount Bearing Mount w/ Boot Lower Spring Seat Spring Seat w/ Bearing	Right Hand Left Hand Right Hand Left Hand							SM5083 SM5226 SM5225 SM5384 SM5383	SM5277		
1988-89	ALL (FWD) w/ HD Susp. ALL (FWD) w/ Std. Susp. Strut Mount Bearing Lower Spring Seat	Right Hand Left Hand	366004 ²⁰ 366004 ²⁰	236003 236003					SM5031 SM5025 SM5083 SM5226 SM5225	SM5016 SM5016	SB104 SB104	SB106 SB106
1978-87	ALL		343127	343157	KG4513	KG5548						
1969-77	ALL		343127	343157	KG4513	KG5504						
1963-68	ALL		343128	343130	KG4515							
1962	ALL		343128		KG4515							

PONTIAC Grand Prix - STRUT-PLUS

2006-07	ALL (Exc. GT, GXP)	Right Hand Left Hand		SR4003 SR4004								
2004-05	ALL (Exc. GTP & GXP)	Right Hand Left Hand		SR4003 SR4004								
1997-03	ALL (Exc. GTP)	Right Hand Left Hand	SR4002 SR4002	SR4003 SR4004								
1990-96	ALL (FWD) w/ HD Susp. ALL (FWD) w/ Std. Susp.			SR4026 SR4026								
1988-89	ALL (FWD) w/ HD Susp. ALL (FWD) w/ Std. Susp.			SR4026 SR4026								

PONTIAC Grand Safari

1971-78	ALL		343127	343157	KG4515	KG5504						
---------	-----	--	--------	--------	--------	--------	--	--	--	--	--	--

PONTIAC Grandville

1971-75	ALL		343127	343157								
---------	-----	--	--------	--------	--	--	--	--	--	--	--	--

²⁰ See Special Installation Instructions Appendix A.

Notes de bas de Page 259 - Guia de notas al calce del catalogo Pg. 260
 Bold part numbers indicate the most comparable KYB product to the original design & performance.
 (22) For vehicles with Electronic Susp., Leveling Control, and Air Suspensions refer to Appendix C.

Applications For Pass. Cars, Light Trucks, SUV's, & Vans

VEHICLE MAKE, MODEL & YEAR		GR-2		Gas-a-Just		MonoMax 56XXXX Series		STRUT & SHOCK			
MARQUE, MODELE ET		Excel-G				AGX 7XXXXX Series		MOUNTS		BOOT KITS	
ANNEE DU VEHICULE											
LA MARCA EL MODELO & ANO											

PONTIAC J2000

1985-86	ALL w/ Sealed Struts	Right Hand	231013	343177		KG4536			SM5007	SM5010	SB104	
		Left Hand	231014	343177		KG4536			SM5007	SM5010	SB104	
	ALL w/ Rebuildable Struts		366003 ¹⁸	343177		KG4536			SM5007	SM5010	SB104	
1984	ALL		366003 ¹⁸	343177		KG4536			SM5007	SM5010	SB104	
1982-83	ALL		365038 ¹⁸	343177		KG4536			SM5007		SB104	

PONTIAC Laurentian (Canadian Vehicle)

1971-81	Sedan & Coupe		343127	343130	KG4515	KG5507						
	Station Wagon		343127	343157	KG4515	KG5504						

PONTIAC Lemans

1988-93	FWD		365025			KG4543			SM5278		SB101	
1978-81	ALL		343127	343157	KG4513	KG5548						
1973-77	Sedan & Coupe		343127	343157	KG4513	KG5504						
	Station Wagon		343127	343157	KG4513							
1968-72	ALL		343127	343157	KG4513	KG5504						
1964-67	ALL (Exc. HD Susp.)		343128	343130	KG4515	KG5507						
	w/ HD Susp.		343128	343130	KG4515	KG5504						

PONTIAC Montana Mini-Van

1999-05	ALL w/ Rear Level Control		334227			KG54325			SM5143		SB127	
	ALL w/o Rear Level Control		334227	344338					SM5143		SB127	
	Upper Spring Seat w/ Insulator								SM5470			
	Upper Spring Seat Insulator								SM5467			
	Lower Spring Seat Insulator								SM5437			

PONTIAC Montana SV6 Mini-Van

2005-09	ALL w/ AWD		335061			KG54325			SM5143		SB127	
	FWD (Exc. Self Leveling Rear Susp.)		335061	344338					SM5143		SB127	
	Upper Spring Seat w/ Insulator								SM5470			
	Upper Spring Seat Insulator								SM5467			
	Lower Spring Seat Insulator								SM5437			

PONTIAC Parisienne

1971-86	Sedan		343127	343130	KG4515	KG5507						
	Station Wagon		343127	343157	KG4515	KG5504						

PONTIAC Phoenix

1984	ALL		234002	343160		KG5555			SM5056	SM5010	SB104	
	Upper Spring Seat w/ Insulator								SM5229			
1980-83	ALL		234002	343160		KG5555			SM5056		SB104	
1977-79	ALL		343127	343132	KG4515	KG5506						

PONTIAC Pursuit (Canadian Vehicle)













2005-06	ALL	Right Hand	339084	349043					SM5513		SB101	
		Left Hand	339085	349043					SM5513		SB101	

PONTIAC Safari

1987-90	ALL		343127	343157	KG4515	KG5504						
1963-70	ALL		343128	343130								
1961-62	ALL		343128		KG4550							

¹⁸ Strut must be cut to install cartridge. Check strut for a cut line groove (20mm from strut top). If no cut line groove is found, do not cut strut open as there are no threads inside. The complete strut must be replaced.

Applications For Pass. Cars, Light Trucks, SUV's, & Vans

VEHICLE MAKE, MODEL & YEAR	  	STRUT & SHOCK		BOOT KITS	
MARQUE, MODELE ET		MOUNTS			
ANNEE DU VEHICULE					
LA MARCA EL MODELO & ANO					
	 	 	 	 	 

PONTIAC Solstice

2006-08	ALL	NA	NA								
---------	-----	----	----	--	--	--	--	--	--	--	--

PONTIAC Sunbird

1992-94	ALL	Right Hand Left Hand	231013 231014	343177 343177		KG4536 KG4536			SM5033 SM5033	SM5010 SM5010	SB104 SB104	
1987-91	ALL	Right Hand Left Hand	231013 231014	343177 343177		KG4536 KG4536			SM5007 SM5007	SM5010 SM5010	SB104 SB104	
1985-86	ALL w/ Sealed Struts ALL w/ Rebuildable Struts	Right Hand Left Hand	231013 231014 366003 ¹⁸	343177 343177 343177		KG4536 KG4536 KG4536			SM5007 SM5007 SM5007	SM5010 SM5010 SM5010	SB104 SB104 SB104	
1984	ALL		366003 ¹⁸	343177		KG4536			SM5007	SM5010	SB104	
1982-94	Upper Springseat w/ Isolator								SM5348			
1982-83	ALL		365038 ¹⁸	343177		KG4536			SM5007		SB104	
1976-80	ALL		343129	343132								

PONTIAC Sunburst (Canadian Vehicle)

1985-88	ALL	Right Hand Left Hand	232015 232016			KG4542 KG4542			SM5297		SB102 SB102	
---------	-----	-------------------------	------------------	--	--	------------------	--	--	--------	--	----------------	--

PONTIAC Sunfire (also see STRUT-PLUS)

1999-05	ALL Lower Spring Seat Insulator		334316	341244			734038	741061	SM5283 SM5418	SM5147	SB101	
1995-98	ALL Strut Mount Bearing Upper Spring Seat w/ Insulator Lower Spring Seat Insulator		334316	341244			734038	741061	SM5142 SM5284 SM5419 SM5418	SM5147	SB101	

PONTIAC Sunfire - STRUT-PLUS

1995-05	ALL		SR4024	SR4025								
---------	-----	--	--------	--------	--	--	--	--	--	--	--	--

PONTIAC Sunrunner (Canadian Vehicle)

1993-98	ALL (Exc. ABS) ALL w/ 4 Wheel ABS	Right Hand Left Hand	235035 235036	343247 343247		KG4745A KG4745A KG4745A			SM5082 SM5082 SM5082			
---------	--------------------------------------	-------------------------	------------------	------------------	--	-------------------------------	--	--	----------------------------	--	--	--

PONTIAC T1000

1981-87	ALL		343145	343147								
---------	-----	--	--------	--------	--	--	--	--	--	--	--	--

PONTIAC Tempest

1968-70	ALL		343127	343157	KG4513	KG5504						
1964-67	ALL (Exc. HD Susp.) w/ HD Susp.		343128 343128	343130 343130	KG4515 KG4515	KG5507 KG5504						

PONTIAC Tempest (Canadian Vehicle)

1992-94	ALL	Right Hand Left Hand	235604 235605	343177 343177		KG4536 KG4536			SM5073 SM5073	SM5010 SM5010	SB103 SB103	
1987-91	ALL	Right Hand Left Hand	231013 231014	343177 343177		KG4536 KG4536			SM5280 SM5280	SM5010 SM5010	SB104 SB104	

¹⁸ Strut must be cut to install cartridge. Check strut for a cut line groove (20mm from strut top). If no cut line groove is found, do not cut strut open as there are no threads inside. The complete strut must be replaced.

Applications For Pass. Cars, Light Trucks, SUV's, & Vans

VEHICLE MAKE, MODEL & YEAR		GR-2		Gas-a-Just		MonoMax 56XXXX Series		STRUT & SHOCK			
MARQUE, MODELE ET		Excel-G				AGX 7XXXXX Series		MOUNTS		BOOT KITS	
ANNEE DU VEHICULE											
LA MARCA EL MODELO & ANO											

PONTIAC Torrent

2007-09	ALL	Right Hand Left Hand		345055 345055		554353 554353					
2006	ALL	Right Hand Left Hand	339058 339057	345055 345055		554353 554353					SB102 SB102

PONTIAC Trans Sport Mini-Van (Footnote # 22)

1997-98	ALL w/ Rear Level Control ALL w/o Rear Level Control Upper Spring Seat w/ Insulator Upper Spring Seat Insulator		334227 334227	344338		KG54325			SM5143 SM5143 SM5470 SM5467		SB127 SB127
1994-96	ALL w/o Rear Level Control Upper Spring Seat w/ Insulator			343160		KG5555			SM5043 SM5229	SM5010	SB104
1990-93	ALL w/ Rear Level Control ALL w/o Rear Level Control Upper Spring Seat w/ Insulator		234019 234019	---- ²² 343160		KG5555			SM5043 SM5043 SM5229	SM5010 SM5010	SB104 SB104

PONTIAC Ventura

1974-77	ALL		343127	343132	KG4515	KG5506					
1973	ALL (Exc. HD Susp.) w/ HD Susp.		343127 343127	343132 343157	KG4515 KG4515	KG5504					
1971-72	w/ Multi Leaf Spring w/ Single Leaf Spring		343127 343127	343157 343132	KG4515 KG4515	KG5504					

PONTIAC Vibe

2009-10	ALL								SM5382		SB108
2007-08	ALL								SM5215	SM5382	SB102 SB108
2003-06	AWD FWD	Right Hand Left Hand Right Hand Left Hand	235703 235704 235703 235704	344613 344613 344612 344612					SM5215 SM5215 SM5215 SM5215	SM5382 SM5382 SM5382 SM5382	SB102 SB108 SB102 SB108

PONTIAC Wave (Canadian Vehicle)

2005-08	ALL		NA	343423					SM5451	SM5452	SB101 SB107
---------	-----	--	----	--------	--	--	--	--	--------	--------	----------------

PORSCHE 911, 912, 930

1985-7/88	ALL					KG5542					
1972-84	ALL (Exc. Bilstein Equipped) Bilstein Equipped		361004			KG5542 KG5542					
1969-71	ALL (Exc. 911E w/ Self Leveling System)		361004			KG5543					
1965-68	ALL					KG5543					

PORSCHE 914

1969-76	ALL		361004			KG9003					SB108
---------	-----	--	--------	--	--	--------	--	--	--	--	-------





PORSCHE 924, 944, 924S

1989-91	944					KG4544					SB102
1986-88	924S		363014			KG4544					SB102
1/85-88	944 (Exc. Turbo & Sealed Strut)		363014			KG4544					SB102
1985-88	944 Turbo (Exc. M474 Sport Susp.)		363014			KG4544					SB102
1983-12/84	944		363014			KG4529					SB102
1976-83	924 (Exc. Sport Susp.)		363014			KG4529					SB102

²² For vehicles with Electronic Susp., Leveling Control, and Air Suspensions refer to Appendix C.

Notes de bas de Page 259 - Guia de notas al calce del catalogo Pg. 260
 Bold part numbers indicate the most comparable KYB product to the original design & performance.
 (22) For vehicles with Electronic Susp., Leveling Control, and Air Suspensions refer to Appendix C.

Applications For Pass. Cars, Light Trucks, SUV's, & Vans

VEHICLE MAKE, MODEL & YEAR		GR-2 <i>Excel-G</i>		Gas-a-Just		MonoMax 56XXXX Series AGX 7XXXXX Series		STRUT & SHOCK MOUNTS		BOOT KITS	
MARQUE, MODELE ET ANNEE DU VEHICULE											
LA MARCA EL MODELO & AÑO											

PORSCHE Boxster

1997-08	ALL	NA	NA								
---------	-----	----	----	--	--	--	--	--	--	--	--

RENAULT Alliance

1983-87	ALL	234017	343152		KG4541			SM5331			
---------	-----	--------	--------	--	--------	--	--	--------	--	--	--

RENAULT Encore

1984-86	ALL	234017	343152		KG4541			SM5331			
---------	-----	--------	--------	--	--------	--	--	--------	--	--	--

RENAULT Fuego

1982-85	ALL	341047	343180								
---------	-----	--------	--------	--	--	--	--	--	--	--	--

RENAULT LeCar (R5)

1972-83	ALL			KG4533	KG4534						
---------	-----	--	--	--------	--------	--	--	--	--	--	--

RENAULT Medallion

1987	Sedan		343220							SB101	
------	-------	--	--------	--	--	--	--	--	--	-------	--

RENAULT R18i

1984-86	ALL	341047	343180								
1981-83	ALL		343180								

RENAULT Sportwagon

1984-86	Sportwagon	341047	343180								
---------	------------	--------	--------	--	--	--	--	--	--	--	--

SAAB 9-2X

2005-06	ALL							SM5361	SM5422	SB101	SB102
---------	-----	--	--	--	--	--	--	--------	--------	-------	-------













SAAB 9-3 Series

2009	Strut / Shock Boot									SB101	
2007-08	ALL	Right Hand Left Hand	334688 ⁶³ 334689 ⁶³							SB101 SB101	
2004-09	Lower Springseat Insulator w/ Bumper (Convertible)								SM5354		
2003-06	ALL	Right Hand Left Hand	334688 ⁶³ 334689 ⁶³	349007 349007					SM5354	SB101 SB101	
2003	Convertible Strut Mount w/ Bearing Strut Mount Bearing							SM5339 SM5340 SM5338			
2001-02	Upper Springseat w/ Bumper 3 Dr., 5 Dr. w/o Viggen Left Rear Upper Springseat w/ Bumper 3 Dr., 5 Dr. w/o Viggen Right Rear Upper Springseat w/ Bumper, Convertible w/o Viggen Left Rear Upper Springseat w/ Bumper, Convertible w/o Viggen Right Rear								SM5352 SM5353 SM5352 SM5353		
1999-02	ALL Strut Mount w/ Bearing Strut Mount Bearing Upper Springseat Insulator w/ Bumper w/ Viggen (Left Rear)		366012	343270				SM5339 SM5340 SM5338	SM5352	SB101	

⁶³ New Part Number; Available 4th Quarter 2010

Notes de bas de Page 259 - Guia de notas al calce del catalogo Pg. 260
 Bold part numbers indicate the most comparable KYB product to the original design & performance.
 (22) For vehicles with Electronic Susp., Leveling Control, and Air Suspensions refer to Appendix C.

Applications For Pass. Cars, Light Trucks, SUV's, & Vans

VEHICLE MAKE, MODEL & YEAR	  	STRUT & SHOCK		BOOT KITS	
MARQUE, MODELE ET		MOUNTS			
ANNEE DU VEHICULE					
LA MARCA EL MODELO & ANO					
	 	 	 	 	 

SAAB 9-3 Series (continued)

1999-02	Upper Springsseat Insulator w/ Bumper w/ Viggen (Right Rear)							SM5353		
---------	--	--	--	--	--	--	--	--------	--	--

SAAB 9-5 Series

2007-09	ALL							SM5335		SB101
2006	ALL	334679 ⁶³						SM5335		SB101
2002-09	ALL w/ Automatic Rear Air Leveling System									SB107
	ALL w/o Air Leveling System									SB108
	Strut Mount w/ Bearing							SM5336		
2002-05	ALL (Exc. Sport Susp.)	334679 ⁶³	341917 ⁷⁷					SM5335		SB101
1999-09	Strut Mount Bearing							SM5338		
1999-01	ALL (Exc. Sport Susp.)	335921	341917 ⁷⁷					SM5335		SB101
	Strut Mount w/ Bearing							SM5336		SB108

SAAB 900 Series

1994-98	ALL	366010			KG4741			SM5337		
	Strut Mount w/ Bearing							SM5172		
1979-93	ALL	343023	343024	KG4532	KG5558					

SAAB 9000 Series

1987-98	ALL (Exc. Self Leveling Rear) From VIN# -H1015470 & VIN# - H8000556	235034			KG4549			SM5103		SB105
1987-93	ALL w/ Self Leveling Rear From VIN# - H1015470 & VIN# - H8000556	235034			KG4549 ¹²			SM5103		SB105
1986-87	ALL (Exc. Self Leveling Rear) Before VIN# -H1015470 & VIN# - H8000556	235053			KG4549			SM5103		SB102

SAAB 93 Series

1956-59	ALL		343030	KG4524	KG4006					
---------	-----	--	--------	--------	--------	--	--	--	--	--

SAAB 95 Series

1959-66	ALL			KG4524						
---------	-----	--	--	--------	--	--	--	--	--	--

SAAB 96 Series

1961-66	ALL			KG4524	KG4616					
---------	-----	--	--	--------	--------	--	--	--	--	--

SAAB 9-7X

2005-08	ALL							SM5395		SB108
2005-07	Lower Spring Seat Insulator							SM5548 ⁶³		

SAAB 99 Series

1979-80	ALL		343024	KG4524	KG5558					
1969-78	ALL		343219	KG4524	KG5517					

SAAB GT Series & 896 Sport











1960-66	ALL			KG4524	KG4616					
1958-59	ALL		343030	KG4524	KG4006					

¹² On models originally equipped with Nivomat self-leveling rear shocks, to install [KG4549] replace the original rear coil spring with Saab P/N 8960940

⁶³ New Part Number: Available 4th Quarter 2010

⁷⁷ When [341917] stock is depleted, use [341847]

Applications For Pass. Cars, Light Trucks, SUV's, & Vans

VEHICLE MAKE, MODEL & YEAR	<i>GR-2</i> <i>Excel-G</i>	<i>Gas-a-Just</i>	<i>MonoMax</i> 56XXXX Series <i>AGX</i> 7XXXXX Series	STRUT & SHOCK MOUNTS	BOOT KITS
MARQUE, MODELE ET ANNEE DU VEHICULE	 	 	 	 	 
LA MARCA EL MODELO & ANO					

SAAB Sonnett (97)

1968-74	ALL			KG4524	KG4616						
---------	-----	--	--	--------	--------	--	--	--	--	--	--

SATURN Astra

2008-09	2 Door Hatchback		349043								
---------	------------------	--	--------	--	--	--	--	--	--	--	--

SATURN Aura

2009	ALL	Right Hand	339051	349008					SM5471	SM5476	SB101	
		Left Hand	339052	349008					SM5447	SM5476	SB101	
2007-08	ALL (Exc. Green Line)	Right Hand	339051	349008					SM5471	SM5476	SB101	
		Left Hand	339052	349008					SM5447	SM5476	SB101	
	Green Line	Right Hand	339051						SM5471	SM5476	SB101	
		Left Hand	339052						SM5447	SM5476	SB101	

SATURN Ion

2003-07	ALL (Exc. Red Line)	Right Hand	333461	343308					SM5483		SB101	
		Left Hand	333462	343308					SM5483	SM5356	SB101	
	Upper Springseat Insulator w/ Bumper, w/ 16" wheels									SM5355		
	Upper Springseat Insulator w/ Bumper, w/o 16" wheels											

SATURN L Series

2003-05	L-Series		NA	341907					SM5333	SM5332	SB103	SB107
2000-02	L-Series	Right Hand	235701	341907					SM5333	SM5332	SB103	SB107
		Left Hand	235702	341907					SM5333	SM5332	SB103	SB107

SATURN Outlook

2007-09	Strut / Shock Boot										SB101	
---------	--------------------	--	--	--	--	--	--	--	--	--	-------	--

SATURN Relay

2005-07	AWD		335061						SM5143		SB127	
	FWD (Exc. Self-Leveling Rear Suspension)		335061	344338		KG54325			SM5143		SB127	
	FWD w/ Self Leveling Rear Lower Spring Seat Insulator		335061						SM5143		SB127	
									SM5437			

SATURN S Series

1991-02	ALL Inc. Station Wagon		234055	234056					SM5078	SM5079	SB101	SB103
---------	------------------------	--	--------	--------	--	--	--	--	--------	--------	-------	-------

SATURN Vue

2006-07	ALL	Right Hand	339054	343433					SM5484		SB101	
		Left Hand	339053	343433					SM5484		SB101	
2002-05	ALL	Right Hand	339054	343433					SM5283		SB101	
		Left Hand	339053	343433					SM5283		SB101	

SCION xA

2004-06	ALL		333385	343426					SM5561 ⁶³		SB102	
---------	-----	--	--------	--------	--	--	--	--	----------------------	--	-------	--











SCION xB

2004-06	Strut Mount								SM5562 ⁶³			
2003-06	ALL		333385	343426								

⁶³ New Part Number; Available 4th Quarter 2010

Notes de bas de Page 259 - Guia de notas al calce del catalogo Pg. 260
 Bold part numbers indicate the most comparable KYB product to the original design & performance.
 (22) For vehicles with Electronic Susp., Leveling Control, and Air Suspensions refer to Appendix C.

Applications For Pass. Cars, Light Trucks, SUV's, & Vans

VEHICLE MAKE, MODEL & YEAR		  	STRUT & SHOCK		BOOT KITS	
MARQUE, MODELE ET			MOUNTS			
ANNEE DU VEHICULE						
LA MARCA EL MODELO & ANO						
		 	 	 	 	 

SCION xD

2008-10	ALL	Right Hand Left Hand	339134 339135	348001 348001								
---------	-----	-------------------------	------------------	------------------	--	--	--	--	--	--	--	--

SCION iC

2009-10	ALL	Right Hand Left Hand	339128 339129	341457 341457						SM5382 SM5382		SB108 SB108
2007-08	ALL	Right Hand Left Hand	339128 339129	341457 341457						SM5382 SM5382		SB108 SB108
2005-06	ALL	Right Hand Left Hand	339128 339129	341457 341457						SM5382 SM5382	SB102 SB102	SB108 SB108

SMART Fortwo (Canadian Vehicle)

2005-06	ALL			NA								
---------	-----	--	--	----	--	--	--	--	--	--	--	--

STERLING 825 & 827S

1987-89	ALL (Exc. Nivomat Susp.)	Right Hand Left Hand		234044 234045								
---------	--------------------------	-------------------------	--	------------------	--	--	--	--	--	--	--	--

SUBARU B9 Tribeca

2006-07	ALL	Right Hand Left Hand	335054 335055	341403 341403								
---------	-----	-------------------------	------------------	------------------	--	--	--	--	--	--	--	--

SUBARU Baja

2005-06	ALL	Right Hand Left Hand							SM5361 SM5361	SM5214 SM5214	SB103 SB103	SB103 SB103
2003-04	ALL	Right Hand Left Hand	334447 334448	341276 341276					SM5361 SM5361	SM5214 SM5214	SB103 SB103	SB103 SB103

SUBARU Brat

1981-87	ALL		234028	343056		KG4183A			SM5365		SB103	
---------	-----	--	--------	--------	--	---------	--	--	--------	--	-------	--













SUBARU DL, GL, Loyale Models

1990-94	Strut Mounting Kit Loyale (Exc. w/ Air Susp.) 4WD Sedan			341065					SM5364	SM5362		SB108
1987-92	4WD Wagon (Exc. Air Susp.)			341065								SB108
1987-89	4WD 2Dr. Sedan 4WD 4Dr. Sedan (Exc. Turbo) 4WD 4Dr. Sedan w/ Turbo			341216 341065 341065					SM5364 SM5364 SM5364			SB108 SB108 SB108
1985-93	2WD Sedan Left Hand 2WD Wagon Right Hand Left Hand	Right Hand Left Hand Right Hand Left Hand	233022 233023 233022 233023	341063 341063 341216 341216							SB105 SB105 SB105 SB105	SB108 SB108 SB108 SB108
1985-90	Strut Mounting Kit All DL/ GL 4-dr. (Exc. w/ air Susp.) Strut Mounting Kit All DL/ GL 3-dr. (Exc. w/ air Susp.)									SM5362 SM5363		
1985-89	2WD Hatchback Model (Rear Shock w/o Springseat)		233024	343056		KG4183A			SM5364		SB105	
1985-87	4WD Hatchback Model (Rear Shock w/o Springseat)		234028	343056		KG4183A			SM5364		SB105	
1985-86	4WD Sedan (Exc. Hatchback Model & Air Susp.) Right Hand Left Hand	Right Hand Left Hand	234046 234047	341065 341065							SB105 SB105	SB108 SB108

Notes de bas de Page 259 - Guia de notas al calce del catalogo Pg. 260

Bold part numbers indicate the most comparable KYB product to the original design & performance.
(22) For vehicles with Electronic Susp., Leveling Control, and Air Suspensions refer to Appendix C.

Applications For Pass. Cars, Light Trucks, SUV's, & Vans

VEHICLE MAKE, MODEL & YEAR	  	STRUT & SHOCK		BOOT KITS	
MARQUE, MODELE ET		MOUNTS			
ANNEE DU VEHICULE					
LA MARCA EL MODELO & ANO					
	 	 	 	 	 

SUBARU DL, GL, Loyale Models (continued)

1985-86	4WD Wagon (Exc. Air Susp.)	Right Hand Left Hand	234046 234047	341065 341065					SM5364 SM5364		SB105 SB105	SB108 SB108
1982-84	2WD ALL w/ Sealed Strut		233024	343056		KG4183A					SB103	
1980-84	4WD ALL w/ Sealed Strut		234028	343056		KG4183A			SM5365		SB103	
1980-83	2WD ALL w/ Serviceable Strut		363027	343056		KG4183A					SB103	

SUBARU Forester

2009-10	Strut / Shock Boot										SB103	
2006-08	ALL	Right Hand Left Hand	334468 334469	339149 339150					SM5361 SM5361		SB103 SB103	SB102 SB102
2004-05	All w/Front Spring Seat Guards (Exc Self-Leveling Rear)	Right Hand Left Hand	334370 334371	334344 334345					SM5361 SM5361	SM5422 SM5422	SB103 SB103	SB102 SB102
	All w/Front Spring Seat Guards and Self-Leveling Rear	Right Hand Left Hand	334370 334371						SM5361 SM5361	SM5422 SM5422	SB103 SB103	SB102 SB102
2003	ALL (Exc. Self Leveling Rear)	Right Hand Left Hand	334342 334343	334344 334345					SM5361 SM5361	SM5422 SM5422	SB103 SB103	SB102 SB102
1998-02	ALL (Exc. Self Leveling Rear)	Right Hand Left Hand	334189 334190	334191 334192							SB103 SB103	SB101 SB101
	ALL w/ Self Leveling Rear	Right Hand Left Hand	334189 334190								SB103 SB103	
	Strut Mount, AWD only	Right Hand Left Hand							SM5361 SM5361	SM5245 SM5244		

SUBARU Impreza AWD (Exc. Outback Model)

2007	Station Wagon	Right Hand Left Hand		334356 334357					SM5361 SM5361	SM5422 SM5422	SB103 SB103	
2005-07	Sedan	Right Hand Left Hand	334470 334471	334358 334359							SB103 SB103	
2005-06	Station Wagon	Right Hand Left Hand	339121 339122	334356 334357					SM5361 SM5361	SM5422 SM5422	SB103 SB103	
2004	Sedan	Right Hand Left Hand	334460 334461	334358 334359					SM5361 SM5361	SM5422 SM5422	SB103 SB103	
	Station Wagon	Right Hand Left Hand	334462 334463	334356 334357					SM5361 SM5361	SM5422 SM5422	SB103 SB103	
2002-03	Sedan	Right Hand Left Hand	334304 334305	334306 334307			734034 734035	734036 ¹⁰ 734037 ¹⁰	SM5361 SM5361	SM5245 SM5244	SB103 SB103	SB102 SB102
	Station Wagon	Right Hand Left Hand	334300 334301	334302 334303					SM5361 SM5361	SM5245 SM5244	SB103 SB103	SB102 SB102
1993-01	ALL (Exc. ABS)	Right Hand Left Hand	235065 235066	235069 235070			734006 734007	733010 733011	SM5361 SM5361	SM5243 SM5243	SB103 SB103	SB102 SB102
	ALL w/ ABS	Right Hand Left Hand	334255 334256	235069 235070			734006 734007	733010 733011	SM5361 SM5361	SM5243 SM5243	SB103 SB103	SB102 SB102

SUBARU Impreza FWD

1993-01	2WD ALL (Exc. ABS)	Right Hand Left Hand	235065 235066	235073 235074			734006 734007		SM5361 SM5361		SB103 SB103	SB102 SB102
	2WD ALL w/ ABS	Right Hand Left Hand	334255 334256	235073 235074			734006 734007		SM5361 SM5361		SB103 SB103	SB102 SB102

SUBARU Impreza Outback

2005-07	ALL	Right Hand Left Hand	339121 339122	334356 334357					SM5361 SM5361	SM5422 SM5422	SB103 SB103	SB102 SB102
---------	-----	-------------------------	------------------	------------------	--	--	--	--	------------------	------------------	----------------	----------------

¹⁰ See the special instruction sheet packed with the AGX strut. To install and adjust the rear AGX struts on Subaru WRX, the rear seat cushions need to be removed and reinstalled per Factory specifications.

Applications For Pass. Cars, Light Trucks, SUV's, & Vans

VEHICLE MAKE, MODEL & YEAR	GR-2	Gas-a-Just	MonoMax 56XXXX Series	STRUT & SHOCK	
MARQUE, MODELE ET	Excel-G		AGX 7XXXXX Series	MOUNTS	BOOT KITS
ANNEE DU VEHICULE					
LA MARCA EL MODELO & ANO					

SUBARU Impreza Outback (continued)

2004	ALL	Right Hand	334462	334356				SM5361	SM5422	SB103	SB102	
		Left Hand	334463	334357				SM5361	SM5422	SB103	SB102	
2002-03	ALL	Right Hand	334300	334302				SM5361	SM5245	SB103	SB102	
		Left Hand	334301	334303				SM5361	SM5244	SB103	SB102	
1993-01	ALL (Exc. ABS)	Right Hand	235065	334109			734006	733010	SM5361	SM5243	SB103	SB102
		Left Hand	235066	334110			734007	733011	SM5361	SM5243	SB103	SB102
	ALL w/ ABS	Right Hand	334255	334109			734006	733010	SM5361	SM5243	SB103	SB102
		Left Hand	334256	334110			734007	733011	SM5361	SM5243	SB103	SB102

SUBARU Justy

1989-94	Strut Mount w/ Bearing							SM5368			
---------	------------------------	--	--	--	--	--	--	--------	--	--	--

SUBARU Legacy (Exc. Outback Model)

2009	ALL (Exc. GT Spec B)	Right Hand	339096	341353							
		Left Hand	339097	341353							
2005-08	ALL (Exc. GT Spec B)	Right Hand	339096	341353					SM5214	SB103	SB101
		Left Hand	339097	341353					SM5214	SB103	SB101
2003-04	ALL	Right Hand	334445	341275				SM5361	SM5214	SB103	SB101
		Left Hand	334446	341275				SM5361	SM5214	SB103	SB101
2000-02	ALL	Right Hand	334273	341275				SM5361	SM5214	SB103	SB101
		Left Hand	334274	341275				SM5361	SM5214	SB103	SB101
1999	30th Anniversary	Right Hand	339151	335020				SM5361	SM5245	SB103	SB102
		Left Hand	339152	335021				SM5361	SM5244	SB103	SB102
	4WD (Exc. Air Susp., GT & 30th Anniversary)	Right Hand	334111	334115				SM5361	SM5245	SB103	SB102
		Left Hand	334112	334116				SM5361	SM5244	SB103	SB102
GT Model	Right Hand	334253	334115				SM5361	SM5245	SB103	SB102	
	Left Hand	334254	334116				SM5361	SM5244	SB103	SB102	
1995-98	2WD (Exc. Air Susp.)	Right Hand	334111	334164				SM5361	SM5246	SB103	SB102
		Left Hand	334112	334165				SM5361	SM5247	SB103	SB102
	4WD (Exc. Air Susp.)	Right Hand	334111	334115				SM5361	SM5245	SB103	SB102
		Left Hand	334112	334116				SM5361	SM5244	SB103	SB102
1992-94	2WD (Exc. Air Susp.)	Right Hand	235065	235073			734006		SM5361		SB101
		Left Hand	235066	235074			734007		SM5361		SB101
	4WD (Exc. Air Susp.)	Right Hand	235065	235069			734006	733010	SM5361	SM5243	SB101
		Left Hand	235066	235070			734007	733011	SM5361	SM5243	SB101
1990-91	2WD ALL	Right Hand	235063	235071					SM5361		SB101
		Left Hand	235064	235072					SM5361		SB101
	4WD (Exc. Air Susp.)	Right Hand	235063	235067					SM5361		SB101
		Left Hand	235064	235068					SM5361		SB101

SUBARU Legacy Outback, Outback





2009	ALL	Right Hand	339098	341443							
		Left Hand	339099	341443							
2005-08	ALL	Right Hand	339098	341443					SM5214	SB103	SB101
		Left Hand	339099	341443					SM5214	SB103	SB101
6/02-04	ALL	Right Hand	334447	341276				SM5361	SM5214	SB103	SB101
		Left Hand	334448	341276				SM5361	SM5214	SB103	SB101
2000-5/02	ALL	Right Hand	334275	341276				SM5361	SM5214	SB103	SB101
		Left Hand	334276	341276				SM5361	SM5214	SB101	SB103
1999	ALL	Right Hand	339151	335020				SM5361	SM5245	SB103	SB101
		Left Hand	339152	335021				SM5361	SM5244	SB103	SB101
1996-98	ALL	Right Hand	235632	335020				SM5361	SM5245	SB103	SB101
		Left Hand	235633	335021				SM5361	SM5244	SB103	SB101

Notes de bas de Page 259 - Guia de notas al calce del catalogo Pg. 260

Bold part numbers indicate the most comparable KYB product to the original design & performance.

(22) For vehicles with Electronic Susp., Leveling Control, and Air Suspensions refer to Appendix C.

Applications For Pass. Cars, Light Trucks, SUV's, & Vans

VEHICLE MAKE, MODEL & YEAR		GR-2		Gas-a-Just		MonoMax 56XXXX Series		STRUT & SHOCK			
MARQUE, MODELE ET		Excel-G				AGX 7XXXX Series		MOUNTS		BOOT KITS	
ANNEE DU VEHICULE											
LA MARCA EL MODELO & AÑO											
											

SUBARU Legacy Outback, Outback (continued)

1995	ALL	Right Hand	334111	334115					SM5361			
		Left Hand	334112	334116					SM5361			

SUBARU SVX

1992-97	ALL		NA	NA								
---------	-----	--	----	----	--	--	--	--	--	--	--	--

SUBARU Tribeca

2008	ALL	Right Hand	335054	341403								
		Left Hand	335055	341403								

SUBARU WRX

2004-07	Sedan (Exc. WRX-Sti)	Right Hand	334470	334358					SM5361	SM5422	SB101	SB102
		Left Hand	334471	334359					SM5361	SM5422	SB101	SB102
	Station Wagon	Right Hand	339121	334356					SM5361	SM5422	SB101	SB102
		Left Hand	339122	334357					SM5361	SM5422	SB101	SB102
2002-03	Sedan (Exc. WRX-Sti)	Right Hand	334304	334306			734034	734036 ¹⁰	SM5361	SM5245	SB101	SB102
		Left Hand	334305	334307			734035	734037 ¹⁰	SM5361	SM5244	SB101	SB102
	Station Wagon	Right Hand	334300	334302					SM5361	SM5245	SB101	SB102
		Left Hand	334301	334303					SM5361	SM5244	SB101	SB102

SUBARU XT

1985-91	Strut Mounting Kit 4WD (Exc. Air Susp.) 2WD (Exc. XT6 & Air Susp.) XT6 (Exc. Air Susp.)								SM5363			
		Right Hand	234029	341063					SM5364	SM5362	SB108	SB105
		Left Hand	234030	341063					SM5364	SM5362	SB108	SB105
				341063					SM5364	SM5362	SB108	SB105

SUZUKI Aerio

2004-07	ALL	Right Hand	333431	333356					SM5489	SM5489	SB101	SB101
		Left Hand	333432	333357					SM5489	SM5489	SB101	SB101
2002-03	ALL (Exc. SX Wagon)	Right Hand	333354	333356					SM5489	SM5489	SB101	SB101
		Left Hand	333355	333357					SM5489	SM5489	SB101	SB101

SUZUKI Esteem

2000-02	ALL	Right Hand	333312	333215					SM5487	SM5489	SB101	SB101
		Left Hand	333313	333216					SM5487	SM5489	SB101	SB101
1995-99	ALL	Right Hand	333312	333215					SM5487	SM5488	SB101	SB101
		Left Hand	333313	333216					SM5487	SM5488	SB101	SB101

SUZUKI Foreza

2004-08	Sedan	Right Hand	339142 ⁷⁰	333481 ⁷⁰							SB101	
		Left Hand	339143 ⁷⁰	333482 ⁷⁰							SB101	

SUZUKI Forsa (Canadian Vehicle)

1987-88	ALL	Right Hand	232019	341075								
		Left Hand	232020	341075								











SUZUKI Grand Vitara

2006-08	ALL	Right Hand	334464	343435							SB105	
		Left Hand	334465	343435							SB105	
1999-05	ALL	Right Hand	334195	343247			KG4745A		SM5366			
		Left Hand	334196	343247			KG4745A		SM5366			

¹⁰ See the special instruction sheet packed with the AGX strut. To install and adjust the rear AGX struts on Subaru WRX, the rear seat cushions need to be removed and reinstalled per Factory specifications.

⁷⁰ New Part Number, Available 2nd Quarter 2010

Applications For Pass. Cars, Light Trucks, SUV's, & Vans

VEHICLE MAKE, MODEL & YEAR		GR-2 <i>Excel-G</i>		Gas-a-Just		MonoMax 56XXXX Series AGX 7XXXXX Series		STRUT & SHOCK MOUNTS		BOOT KITS	
MARQUE, MODELE ET ANNEE DU VEHICULE		 		 		 		 		 	
LA MARCA EL MODELO & ANO											

SUZUKI Reno

2005-08	ALL	Right Hand	339142 ⁷⁰	333481 ⁷⁰							SB101
		Left Hand	339143 ⁷⁰	333482 ⁷⁰							SB101

SUZUKI Samurai

1986-95	ALL		343030	KG4616	KG4006						
---------	-----	--	--------	--------	--------	--	--	--	--	--	--

SUZUKI Samurai (4WD) - Steering Stabilizer

1985-91	Complete Kit		SS15345								
---------	--------------	--	---------	--	--	--	--	--	--	--	--

SUZUKI Sidekick

1996-98	ALL w/ 4 Wheel ABS	Right Hand	334195	343247							
		Left Hand	334196	343247		KG4745A				SM5082	
1989-98	ALL (Exc. 4 Wheel ABS)	Right Hand	235035	343247							
		Left Hand	235036	343247		KG4745A				SM5082	

SUZUKI Swift

1992-94	ALL (Exc. GT Model & Canada 2DR Model)	Right Hand	232025	232027								
		Left Hand	232026	232027						SM5188	SM5189	SB112
										SM5188	SM5189	SB112
										SM5188	SM5189	SB112
1989-91	ALL	Right Hand	232025	232027								
		Left Hand	232026	232027						SM5188	SM5189	SB112

SUZUKI SX4

2007-08	Strut Boot										SB101
---------	------------	--	--	--	--	--	--	--	--	--	-------

SUZUKI Verona

2004-06	ALL		NA	NA							
---------	-----	--	----	----	--	--	--	--	--	--	--

SUZUKI Vitara

1999-04	ALL	Right Hand	334195	343247							
		Left Hand	334196	343247		KG4745A					
	Strut Mount (1.6L)										
	Strut Mount (2.0 & 2.5L)									SM5367	

SUZUKI X90

1996-98	ALL	Right Hand	334139	343247							
		Left Hand	334140	343247		KG4745A				SM5082	

SUZUKI XL-7

2007-08	Strut Boot										SB102
2002-06	ALL	Right Hand	334195	344440							
		Left Hand	334196	344440						SM5366	
2001	ALL	Right Hand	334195	344440							
		Left Hand	334196	344440						SM5366	

TOYOTA 4-Runner

2003-09	ALL (Exc X-REAS, Self-Leveling Air Susp.)		341340	344410							
1998-02	ALL				KG9025	KG54317	564002	565002	SM5184		
1996-97	ALL				KG9025	KG54317	564002	565002			

⁷⁰ New Part Number, Available 2nd Quarter 2010

Notes de bas de Page 259 - Guia de notas al calce del catalogo Pg. 260
 Bold part numbers indicate the most comparable KYB product to the original design & performance.
 (22) For vehicles with Electronic Susp., Leveling Control, and Air Suspensions refer to Appendix C.

Applications For Pass. Cars, Light Trucks, SUV's, & Vans

VEHICLE MAKE, MODEL & YEAR	GR-2		Gas-a-Just		MonoMax 56XXXX Series		STRUT & SHOCK			
MARQUE, MODELE ET	Excel-G				AGX 7XXXXX Series		MOUNTS		BOOT KITS	
ANNEE DU VEHICULE										
LA MARCA EL MODELO & ANO										

TOYOTA 4-Runner (continued)

1996-97	Shock Mount (4WD) Upper Spring Seat Insulator (2WD)							SM5184 SM5413				
1990-95	ALL	344202		KG5474	KG5475	565058	565059					
1986-89	ALL	344202	344428	KG5474	KG5462	565058	565052					
1984-85	ALL	344054	344428	KG5437	KG5462	565042	565052					

TOYOTA 4-Runner - KYB Lift Kit Replacement Shocks

1990-95	ALL Lift = 0-2"					565084	565059					
1986-89	ALL Lift = 0-2"					565084	565085					
1984-85	ALL Lift = 0-2"						565085					

TOYOTA 4-Runner - Steering Stabilizer

1986-95	OEM Replacement Cylinder	SS10351										
---------	--------------------------	---------	--	--	--	--	--	--	--	--	--	--

TOYOTA Avalon









2008-09	ALL	Right Hand Left Hand		339043 339044								
2005-01/06	ALL (Exc. Touring & XL Sport Package)	Right Hand Left Hand	339177 ⁶³ 339178 ⁶³	334388 334389								
	Touring & XL Sport Package	Right Hand Left Hand	339181 ⁶³ 339182 ⁶³	334388 334389								
2004-07	Upper Spring Seat w/ Insulator							SM5485				
2004	ALL	Right Hand Left Hand	339136 339137	339138 339139				SM5179 SM5180 SM5485	SM5175 SM5175	SB101 SB101	SB101 SB101	
1997-03	ALL	Right Hand Left Hand	334245 334246	334133 334134				SM5179 SM5180 SM5485 SM5441	SM5175 SM5175 SM5469	SB101 SB101	SB101 SB101	
1995-96	ALL	Right Hand Left Hand	334170 334171	334133 334134				SM5174 SM5174 SM5485 SM5441	SM5133 SM5133	SB101 SB101	SB101 SB101	
	Upper Spring Seat w/ Insulator Lower Spring Seat Insulator Upper Spring Seat Insulator											

TOYOTA Camry (also see STRUT-PLUS)

2010	Hybrid	Right Hand Left Hand	339023 339024	339043 339044								
2007-09	ALL (Exc. SE)	Right Hand Left Hand	339023 339024	339043 339044								
	SE Model	Right Hand Left Hand	339183 ⁶³ 339184 ⁶³	335070 ⁶³ 335071 ⁶³								
2007-08	Upper Spring Seat w/ Insulator							SM5485				
2004-06	ALL	Right Hand Left Hand	334386 334387	334388 334389				SM5423 SM5423 SM5485	SM5175 SM5175	SB102 SB102	SB101 SB101	
2002-03	ALL	Right Hand Left Hand	334338 334339	334340 334341				SM5423 SM5423 SM5485	SM5175 SM5175	SB102 SB102	SB101 SB101	
	Upper Spring Seat w/ Insulator Lower Spring Seat Insulator								SM5469			
1997-01	ALL	Right Hand Left Hand	334245 334246	334133 334134				SM5179 SM5180 SM5485	SM5175 SM5175	SB101 SB101	SB101 SB101	
	Upper Spring Seat w/ Insulator											

⁶³ New Part Number; Available 4th Quarter 2010

Applications For Pass. Cars, Light Trucks, SUV's, & Vans

VEHICLE MAKE, MODEL & YEAR <hr/> MARQUE, MODELE ET <hr/> ANNEE DU VEHICULE <hr/> LA MARCA EL MODELO & ANO				STRUT & SHOCK <hr/> MOUNTS	BOOT KITS
					

TOYOTA Camry (also see STRUT-PLUS) (continued)

1997-01	Lower Spring Seat Insulator							SM5441	SM5469			
1995-96	ALL	Right Hand	334170	334133				SM5174	SM5133	SB101	SB101	
		Left Hand	334171	334134				SM5174	SM5133	SB101	SB101	
	Upper Spring Seat w/ Insulator							SM5485				
	Upper Spring Seat Insulator								SM5468			
1992-94	ALL w/ Sealed Struts	Right Hand	334131	334133				SM5126	SM5133	SB117	SB117	
		Left Hand	334132	334134				SM5126	SM5133	SB117	SB117	
	Mount only, Bearing not inc.							SM5385				
	Sedan w/ Serviceable Struts		365085	365016				SM5126	SM5133	SB117	SB117	
	Lower Spring Seat Bearing (Only)							SM5125				
	Lower Springseat Assembly							SM5173				
1987-91	2WD Sedan w/ Sealed Struts	Right Hand	235041	235042				SM5090	SM5375	SB117	SB117	
		Left Hand	235041	235043				SM5090	SM5375	SB117	SB117	
	2WD Station Wagon w/ Sealed Struts											
		Right Hand	235041	235042				SM5090	SM5375	SB117	SB117	
		Left Hand	235041	235043				SM5090	SM5375	SB117	SB117	
	4WD All-Trac		235041					SM5090	SM5069	SB117	SB117	
	2WD Sedan w/ Serviceable Struts		365061	365062				SM5090	SM5375	SB117	SB117	
	2WD Station Wagon w/ Serviceable Struts		365061	365063				SM5090	SM5375	SB117	SB117	
	1983-86	ALL	Right Hand	365037	233014				SM5019	SM5069	SB102	SB102
			Left Hand	365037	233015				SM5019	SM5069	SB102	SB102

TOYOTA Camry - STRUT-PLUS

1997-01	ALL V6	Right Hand	SR4031	SR4035 ⁶³							
		Left Hand	SR4032	SR4036 ⁶³							
	ALL w/ 4 Cyl. Engine	Right Hand	SR4029	SR4035 ⁶³							
		Left Hand	SR4030	SR4036 ⁶³							

TOYOTA Carina

1971-73	ALL			343149							SB103
---------	-----	--	--	--------	--	--	--	--	--	--	-------













TOYOTA Celica

2000-05	ALL	Right Hand	334277	341277			734021	741041	SM5215	SM5382	SB101	SB108
		Left Hand	334278	341277			734022	741041	SM5215	SM5382	SB101	SB108
1995-99	ALL w/ Sealed Struts	Right Hand	334378	334125					SM5372	SM5087	SB103	SB103
		Left Hand	334379	334126					SM5372	SM5087	SB103	SB103
1994-99	ALL (Exc. All-Trac) (w/ Rebuildable Struts)	Right Hand	365092	334125					SM5372	SM5087	SB103	SB103
		Left Hand	365092	334126					SM5372	SM5087	SB103	SB103
1990-93	Strut Mount w/ Bearing								SM5164			
	ALL (Exc. All-Trac)	Right Hand	365075	235037					SM5086	SM5087	SB103	SB101
1990-92		Left Hand	365075	235038					SM5086	SM5087	SB103	SB101
	All-Trac		365075						SM5086	SM5087	SB103	SB101
1988-89	ALL (Exc. All-Trac)	Right Hand	365064	235028			765015		SM5086	SM5069	SB103	SB117
		Left Hand	365064	235029			765015		SM5086	SM5069	SB103	SB117
	All-Trac		365064				765015		SM5086	SM5069	SB103	SB117
1986-87	ALL (Exc. GTS)	Right Hand	365058	235017					SM5086	SM5069	SB103	SB117
		Left Hand	365058	235018					SM5086	SM5069	SB103	SB117
	GTS	Right Hand	365058	235028					SM5086	SM5069	SB103	SB117
		Left Hand	365058	235029					SM5086	SM5069	SB103	SB117
1982-85	ALL (Exc. GTS)		365005	343039					SM5370		SB101	
	GTS w/ I.R.S.		365005	343042			KG5552		SM5370		SB101	
							KG5561		SM5370		SB101	

⁶³ New Part Number; Available 4th Quarter 2010

Notes de bas de Page 259 - Guia de notas al calce del catalogo Pg. 260
 Bold part numbers indicate the most comparable KYB product to the original design & performance.
 (22) For vehicles with Electronic Susp., Leveling Control, and Air Suspensions refer to Appendix C.

Applications For Pass. Cars, Light Trucks, SUV's, & Vans

VEHICLE MAKE, MODEL & YEAR	  	STRUT & SHOCK		BOOT KITS	
MARQUE, MODELE ET		MOUNTS			
ANNEE DU VEHICULE					
LA MARCA EL MODELO & ANO					
	 	 	 	 	 

TOYOTA Celica (continued)

1982-85	GTS w/ Solid Rear Axle	365005	343039		KG5552			SM5370		SB101	
1978-81	ALL	365005	343039		KG5552					SB103	
10/75-77	ALL	365005	343149					SM5370		SB101	
6/73-9/75	ALL		343149							SB103	
1971-6/73	ALL		343149							SB103	













TOYOTA Corolla (Exc. FX Series & All Trac)

2003-08	ALL	Right Hand Left Hand	334450 334451	344612 344612				SM5215 SM5215	SM5382 SM5382	SB102 SB102	SB108 SB108
1993-02	ALL (Exc. Performance & S)	Right Hand Left Hand	333236 333237	234059 234060				SM5049 SM5049	SM5075 SM5074	SB103 SB103	SB117 SB117
	Performance, Incl. S model	Right Hand Left Hand	234057 234058	234059 234060				SM5049 SM5049	SM5075 SM5074	SB103 SB103	SB117 SB117
	Lower Spring Seat Insulator							SM5522	SM5523		
1988-92	ALL w/ FWD (Exc. GTS) w/ Sealed Strut	Right Hand Left Hand	234035 234036	234031 234032				SM5104 SM5104	SM5075 SM5074	SB103 SB103	SB102 SB102
	ALL w/ FWD (Exc. GTS) w/ Serviceable Strut										
	Frnt. Cartridges	Right Hand Left Hand	363060 363060	234031 234032				SM5104 SM5104	SM5075 SM5074	SB103 SB103	SB102 SB102
	GTS Model	Right Hand Left Hand		234031 234032					SM5075 SM5074		SB102 SB102
	GTS Model (Frnt. Cartridges)		365064					SM5049		SB103	
	Lower Spring Seat Insulator							SM5522			
1986-87	RWD w/ Power Steering	Right Hand Left Hand	365076 365076	343149 343149		KG4762 KG4762		SM5020 SM5021			SB101
	RWD w/o Power Steering	Right Hand Left Hand	365076 365076	343149 343149		KG4762 KG4762		SM5022 SM5023			SB101
1984-87	ALL w/ FWD (Exc. Diesel) w/ Sealed Strut	Right Hand Left Hand	234024 234025	232028 232029				SM5019 SM5019	SM5069 SM5069		SB102 SB102
	ALL w/ FWD (Exc. Diesel) w/ Serviceable Strut										
	Frnt. Cartridges	Right Hand Left Hand	363039 363039	232028 232029				SM5019 SM5019	SM5069 SM5069		SB102 SB102
	FWD Diesel	Right Hand Left Hand	365041 365041	232028 232029				SM5019 SM5019	SM5069 SM5069	SB101 SB101	SB102 SB102
1984-85	RWD w/ Power Steering	Right Hand Left Hand	365015 365015	343149 343149		KG4762 KG4762		SM5020 SM5021			SB101
	RWD w/o Power Steering	Right Hand Left Hand	365015 365015	343149 343149		KG4762 KG4762		SM5022 SM5023			SB101
1982-83	Sedan, Coupe & Hatchback	Right Hand Left Hand	365015 365015	343149 343149		KG4762 KG4762		SM5022 SM5023			SB101 SB101
1980-83	1800 Model Station Wagon		365015								SB101
1980-81	Sedan, Coupe & Hatchback		365015	343149		KG4762		SM5371			SB101
1975-79	1200 Model			343147				SM5369			SB101
	1600 Model (Exc. Station Wagon)		365015	343147				SM5369			SB101
	1600 Model Station Wagon		365015	343039				SM5369			SB101
	SR-5 Model		365015	343147				SM5369			SB101
1973-74	SR-5			343140							SB103
1967-4/70	ALL (Exc. Station Wagon)			343140							
5/70-74	ALL (Exc. SW & SR-5) Station Wagon			343140				SM5371			SB103
	Shock (Sleeve) Adapter Kit			343143 ⁵ KIT105				SM5371			SB103

⁵ Use Kit #105

Notes de bas de Page 259 - Guia de notas al calce del catalogo Pg. 260
 Bold part numbers indicate the most comparable KYB product to the original design & performance.
 (22) For vehicles with Electronic Susp., Leveling Control, and Air Suspensions refer to Appendix C.

Applications For Pass. Cars, Light Trucks, SUV's, & Vans

VEHICLE MAKE, MODEL & YEAR	  	STRUT & SHOCK		BOOT KITS	
MARQUE, MODELE ET		MOUNTS			
ANNEE DU VEHICULE					
LA MARCA EL MODELO & ANO	 	 	 	 	 

TOYOTA Corolla FX Series (Exc.4WD)

1987-89	FX16, FX16 GTS	365041	232030					SM5019	SM5069	SB101	SB117
1987-88	FX	Right Hand	234024	232028				SM5019	SM5069	SB101	SB117
		Left Hand	234025	232029				SM5019	SM5069	SB101	SB117

TOYOTA Corona

1979-83	ALL	365016	343039					SM5370		SB103	
8/73-78	ALL (Exc. Station Wagon) Station Wagon	343127	343149	KG4611A							
		343127	344044	KG4611A	KG4012						
2/70-7/73	ALL	343127	343147	KG4611A							
1964-1/70	ALL (Exc. Station Wagon) Station Wagon	343127	343147	KG4611A							
		343127	344044	KG4611A	KG4012						

TOYOTA Corona Mark II

1972-76	ALL (Exc. Station Wagon) Station Wagon	343127	343147	KG4611A	KG4012						
1969-71	ALL	343127		KG4611A							

TOYOTA Cressida (Exc. Electronically-Adjustable Suspension)

1989-92	ALL	365076	341111					SM5374	SM5373	SB103	SB107
1985-88	Strut Mount ALL (Exc. TEMS)							SM5374			
1983-88	Sedan	365076	343042		KG5561					SB103	
1983-87	Station Wagon	365076	343039		KG5552					SB103	
1981-82	Sedan Station Wagon	365017			KG4766			SM5065		SB103	
		365017	343039		KG5552			SM5065		SB103	
1978-80	Sedan Station Wagon	365016			KG4766			SM5065		SB103	
		365016	343039		KG5552			SM5065		SB103	

TOYOTA Echo

2003-05	Strut Mount							SM5561 ⁶³			
2000-05	ALL	333258	343295							SB102	
2000-02	Strut Mount w/ Bearing w/ 23.4mm opening / cover Strut Mount w/ Bearing w/ 26mm opening / cover							SM5473			
								SM5472			

TOYOTA FJ Cruiser

2007-09	ALL	341340	344410								
---------	-----	--------	--------	--	--	--	--	--	--	--	--

TOYOTA Highlander (AWD)

2004-07	ALL	Right Hand	334399	334394				SM5423	SM5491	SB102	SB104
		Left Hand	334400	334395				SM5423	SM5492	SB102	SB104
2001-03	ALL	Right Hand	334399	334263				SM5423	SM5175	SB102	SB101
		Left Hand	334400	334264				SM5423	SM5175	SB102	SB101
								SM5485	SM5469		

TOYOTA Highlander (FWD)













2004-07	ALL	Right Hand	334399 ⁶⁴	334384				SM5423	SM5491	SB102	SB104
		Left Hand	334400 ⁶⁵	334385				SM5423	SM5492	SB102	SB104
								SM5485			

⁶³ New Part Number; Available 4th Quarter 2010

⁶⁴ Replaces [235904], when stock is depleted

⁶⁵ Replaces [235905], when stock is depleted

Applications For Pass. Cars, Light Trucks, SUV's, & Vans

VEHICLE MAKE, MODEL & YEAR	  	STRUT & SHOCK		BOOT KITS	
MARQUE, MODELE ET		MOUNTS			
ANNEE DU VEHICULE					
LA MARCA EL MODELO & ANO					
	 	 	 	 	 

TOYOTA Highlander (FWD) (continued)

2004-07	Lower Spring Seat Insulator								SM5469			
2001-03	ALL	Right Hand	334399	334428					SM5423	SM5175	SB102	SB101
		Left Hand	334400	334429					SM5423	SM5175	SB102	SB101
	Upper Spring Seat w/ Insulator								SM5485			
	Lower Spring Seat Insulator								SM5469			

TOYOTA Land Cruiser

1/98-06	HJ95 S/W (Torsion Bar Front Susp.)		345022	345023								
1991-1/98	FJ80 SW (Coil Spring Front Susp.)				KG54300	KG54301	565026	565027				
1988-90	FJ60 SW			344428	KG5475	KG5462	565059	565052				
1985-87	FJ60 SW			344015	KG5475	KG4026	565059					
1981-84	FJ40		344426	344090	KG5401	KG5466						
	FJ60 SW			344015	KG5475	KG4026	565059					
1969-80	FJ40		344426	344090	KG5401	KG5466						
	FJ55 SW			344015	KG5475	KG4026						

TOYOTA Land Cruiser - KYB Lift Kit Replacement Shocks

1988-90	FJ60 SW Lift = 0-2"							565085				
---------	---------------------	--	--	--	--	--	--	--------	--	--	--	--

TOYOTA MR2

1/90-95	ALL (Exc. Sealed Struts)		365064	365100			765015	765016	SM5161		SB103	SB103
1987-89	ALL (Exc. Sealed Struts)		363045	365061							SB103	SB103
1985-86	ALL (Exc. Sealed Struts)		363045	363046							SB103	SB103

TOYOTA MR2 Spyder

2000-05	ALL	Right Hand	333320	334310							SB101	SB101
		Left Hand	333321	334311							SB101	SB101

TOYOTA Matrix

2003-08	FWD	Right Hand	235703	344612					SM5215	SM5382	SB105	SB108
		Left Hand	235704	344612					SM5215	SM5382	SB105	SB108
2003-06	AWD	Right Hand	235703	344613					SM5215	SM5382	SB105	SB108
		Left Hand	235704	344613					SM5215	SM5382	SB105	SB108

TOYOTA Paseo











8/95-97	ALL	Right Hand	333209	341191					SM5089	SM5163	SB103	SB108
		Left Hand	333210	341191					SM5089	SM5163	SB103	SB108
1992-7/95	ALL	Right Hand	234053	341125					SM5089	SM5088	SB103	SB108
		Left Hand	234054	341125					SM5089	SM5088	SB103	SB108

TOYOTA Pickup (Exc. T100, Tacoma & 4Runner)

1990-95	2WD (1 Ton)		343209	344090	KG4752	KG5438	565030					
1986-95	4WD		344202	344428	KG5474	KG5462	565058	565052				
1985-95	2WD (Exc. Diesel & 1 Ton)		343209	344044	KG4752	KG4012	565030	565028				
1985-89	2WD (1 Ton)		343209	344090	KG4752	KG5466	565030					
1984-85	4WD		344054	344428	KG5437	KG5462	565042	565052				
1984	2WD (Exc. Diesel)		343209	344044	KG4752	KG4012	565030	565028				
	2WD Diesel			344044		KG4012		565028				
1982-83	2WD (Exc. Diesel)		343127	344044	KG4611A	KG5434						
	2WD Diesel			344044		KG5434						
1979-83	4WD		344054	344045	KG5437	KG5438	565042					

Notes de bas de Page 259 - Guia de notas al calce del catalogo Pg. 260
 Bold part numbers indicate the most comparable KYB product to the original design & performance.
 (2) For vehicles with Electronic Susp., Leveling Control, and Air Suspensions refer to Appendix C.

Applications For Pass. Cars, Light Trucks, SUV's, & Vans

VEHICLE MAKE, MODEL & YEAR	GR-2	Gas-a-Just	MonoMax 56XXXX Series	STRUT & SHOCK	
MARQUE, MODELE ET	Excel-G		AGX 7XXXXX Series	MOUNTS	BOOT KITS
ANNEE DU VEHICULE	 	 	 	 	 
LA MARCA EL MODELO & ANO					

TOYOTA Pickup (Exc. T100, Tacoma & 4Runner) (continued)

1979-81	2WD	343127	344055	KG4611A	KG5538					
1977-78	ALL	343127	344055	KG4611A	KG5538					
1970-76	ALL	343127		KG4611A						

TOYOTA Pickup (Exc. T100, Tacoma & 4Runner) KYB Lift Kit Replacement Shocks

1986-95	4WD Lift = 0-2"					565084	565085			
1984-85	4WD Lift = 0-2"						565085			

TOYOTA Pickup 4WD (Exc. T100, Tacoma & 4Runner) - Steering Stabilizer

1986-95	OEM Replacement Cylinder	SS10351								
---------	--------------------------	---------	--	--	--	--	--	--	--	--

TOYOTA Previa

1991-97	ALL	Right Hand	235039	344431		KG5494			SM5090		SB101
		Left Hand	235040	344431		KG5494			SM5090		SB101

TOYOTA Prius

2009	ALL	Right Hand	333388	341322							
		Left Hand	333389	341322							
2004-08	ALL	Right Hand	333388	341322					SM5215	SM5382	SB108
		Left Hand	333389	341322					SM5215	SM5382	SB108
2001-03	ALL	Right Hand	333360	341321					SM5474	SM5382	SB101
		Left Hand	333361	341321					SM5474	SM5382	SB101

TOYOTA RAV4

2006-08	ALL	Right Hand	339031	349024							
		Left Hand	339032	349024							
2001-05	ALL	Right Hand	335040	343272		KG4738			SM5162		SB102
		Left Hand	335041	343272		KG4738			SM5162		SB102
1996-00	2 Door w/ 16" Wheels	Right Hand	334241	343313					SM5162		SB103
		Left Hand	334242	343313					SM5162		SB103
	4 Door w/ 16" Wheels	Right Hand	334251	343314					SM5162		SB103
		Left Hand	334252	343314					SM5162		SB103
	ALL w/o 16" wheels, w/ Sealed Struts	Right Hand	334241	343272		KG4738			SM5162		SB103
		Left Hand	334242	343272		KG4738			SM5162		SB103
1996-99	ALL w/ Serviceable Struts		365093	343272		KG4738			SM5162		SB103

TOYOTA Sequoia

2003-07	ALL (Exc. Self Leveling Rear)		341466	344406					SM5442		
2001-02	ALL		341312 ⁸	344358					SM5442		

TOYOTA Sienna













2009-10	AWD	Right Hand	339102	344480					SM5423		
		Left Hand	339103	344480					SM5423		
	FWD w/ 7 Passenger Seating	Right Hand	339100	344308					SM5423		
		Left Hand	339101	344308					SM5423		
	FWD w/ 8 Passenger Seating	Right Hand	339102	344480							
		Left Hand	339103	344480							
7/05-08	AWD	Right Hand	339102	344480					SM5423		
		Left Hand	339103	344480					SM5423		
	FWD w/ 7 Passenger Seating	Right Hand	339100	344308					SM5423		
		Left Hand	339101	344308					SM5423		

⁸ When [341312] stock is depleted, use [341466]

Notes de bas de Page 259 - Guia de notas al calce del catalogo Pg. 260

Bold part numbers indicate the most comparable KYB product to the original design & performance.
(22) For vehicles with Electronic Susp., Leveling Control, and Air Suspensions refer to Appendix C.

Applications For Pass. Cars, Light Trucks, SUV's, & Vans

VEHICLE MAKE, MODEL & YEAR	  	STRUT & SHOCK		BOOT KITS	
MARQUE, MODELE ET		MOUNTS			
ANNEE DU VEHICULE					
LA MARCA EL MODELO & ANO					
	 	 	 	 	 

TOYOTA Sienna (continued)

7/05-08	FWD w/ 8 Passenger Seating	Right Hand Left Hand	339102 339103	344480 344480					SM5423 SM5423			
2004-08	Upper Spring Seat w/ Insulator								SM5485			
2004-6/05	AWD	Right Hand	334452	344480					SM5423			
		Left Hand	334453	344480					SM5423			
	FWD w/ 8 Passenger Seating	Right Hand	334452	344480					SM5423			
		Left Hand	334453	344480					SM5423			
1/03-6/05	FWD w/ 7 Passenger Seating	Right Hand Left Hand	334430 334431	344308 344308								
1998-05	Lower Spring Seat Insulator								SM5441			
1998-12/02	ALL	Right Hand	235624	343149					SM5179			SB101
		Left Hand	235625	343149					SM5180			SB101
1998-03	Upper Spring Seat w/ Insulator								SM5485			

TOYOTA Solara

7/06-08	ALL	Right Hand							SM5423			SB102
		Left Hand							SM5423			SB102
	Upper Spring Seat w/ Insulator								SM5485			
2004-6/06	ALL	Right Hand	334386	334388					SM5423	SM5175		SB102
		Left Hand	334387	334389					SM5423	SM5175		SB102
	Upper Spring Seat w/ Insulator								SM5485			SB101
1999-03	ALL	Right Hand	334245	334133					SM5179	SM5175		SB101
		Left Hand	334246	334134					SM5180	SM5175		SB101
		Upper Spring Seat w/ Insulator							SM5485			SB101
	Lower Spring Seat Insulator							SM5441	SM5469			

TOYOTA Starlet

1981-84	ALL		363038			KG3765						SB103
---------	-----	--	--------	--	--	--------	--	--	--	--	--	-------

TOYOTA Supra

1994-98	ALL (Exc. Adjustable Susp.)				KG6800	KG6799	725001	725002		SM5186		SB101	SB104
3/86-93	ALL (Exc. Adjustable Susp.) ALL (For Adapting TEMS to Non-TEMS Suspension)		341069	341070						SM5160	SM5159	SB101	SB107
			341069 ^c	341070 ^c						SM5160	SM5159	SB101	SB107
1982-2/86	ALL		365076	343042		KG5561				SM5374		SB101	

TOYOTA T100

1995-98	2WD Extra Cab		343209	344090	KG4752	KG5466	565030						
1993-98	2WD (1 Ton)		343209	344090	KG4752	KG5438	565030						
	2WD (Exc. Extra Cab & Exc. 1 Ton)		343209	344044	KG4752	KG5434	565030						
	4WD		344202	343403	KG5474	KG54105	565058	565035					

TOYOTA T100 - KYB Lift Kit Replacement Shocks

1993-98	4WD Lift = 0-2"						565084					
---------	-----------------	--	--	--	--	--	--------	--	--	--	--	--

TOYOTA Tacoma (2WD)

2005-10	2WD (Exc. Off Road Susp. X-Runner)	Right Hand	341458	349011		554351						
		Left Hand	341459	349011		554351						
	X-Runner		NA	349011		554351						
2005-08	2WD PreRunner & Off-Road Package		341340	349010	551104	554350						
1998-04	2WD PreRunner & Off-Road Package			344428	KG9024	KG5462	564001	565052				
1999-04	2WD w/ Extended Cab (Exc. Pre-Runner)		343410	344448	553360	553361						













^c To convert from Electronic Susp - See Appendix C

Notes de bas de Page 259 - Guia de notas al calce del catalogo Pg. 260

Bold part numbers indicate the most comparable KYB product to the original design & performance.

(22) For vehicles with Electronic Susp., Leveling Control, and Air Suspensions refer to Appendix C.

Applications For Pass. Cars, Light Trucks, SUV's, & Vans

VEHICLE MAKE, MODEL & YEAR	  	STRUT & SHOCK		BOOT KITS	
MARQUE, MODELE ET		MOUNTS			
ANNEE DU VEHICULE					
LA MARCA EL MODELO & ANO	 	 	 	 	 

TOYOTA Tacoma (2WD) (continued)

1995-98	2WD w/ Extended Cab (Exc. Pre-Runner)	343209	344055	KG4752	KG5538	565030	565065				
2003-04	2WD w/ Regular Cab (Exc. Pre-Runner)	343209	344447	KG4752	KG4161						
1995-02	2WD w/ Regular Cab (Exc. Pre-Runner & Off Road Package)	343209	344055	KG4752	KG5538	565030	565065				

TOYOTA Tacoma (4WD)

2005-08	4WD w/o TRD Package 4WD w/ TRD Package	341340	349010	551104 551104	554350 554350						
1998-04	4WD w/ TRD Package		344428	KG9024	KG5462	564001	565052				
1995-04	4WD w/o TRD Package Upper Spring Seat Insulator		344428	KG9024	KG5462	564001	565052	SM5413			

TOYOTA Tacoma - KYB Lift Kit Replacement Shocks

1998-02	2WD PreRunner & Off-Road Package Lift = 0-2"						565085				
1995-04	4WD Lift = 0-2"						565085				

TOYOTA Tercel

1995-99	ALL	Right Hand Left Hand	333209 333210	341191 341191				SM5089 SM5089	SM5163 SM5163		
1991-94	ALL	Right Hand Left Hand	234053 234054	341125 341125				SM5089 SM5089	SM5088 SM5088	SB103 SB103	SB108 SB108
1987-90	ALL (Exc. Station Wagon)		363047		KG9129			SM5068	SM5088	SB103	SB107
1983-88	4WD Station Wagon		363037	343149	KG4762			SM5067		SB103	
1983-87	2WD Station Wagon	Right Hand Left Hand	363030 363030	232005 232006				SM5067 SM5067	SM5069 SM5069	SB103 SB103	SB101 SB101
1983-86	ALL (Exc. Station Wagon)	Right Hand Left Hand	363030 363030	232005 232006				SM5067 SM5067	SM5069 SM5069	SB103 SB103	SB101 SB101
1980-82	ALL		363063							SB103	

TOYOTA Tundra (2WD)

2007-09	w/o Off Road Package	341480	349054	551125 ⁶⁸	554367						
2004-06	Double Cab	341440		551119	KG54335			SM5442			
2000-06	w/o Double Cab & TRD			KG9026	KG54335			SM5442			

TOYOTA Tundra (4WD)

2007-09	ALL w/o Off-Road Package	341480	349054	551125 ⁶⁸	554367						
2004-06	Double Cab	341440		551119	KG54336			SM5442			
2000-06	ALL w/o Double Cab & TRD TRD w/o Double Cab			KG9026 551119	KG54335 KG54336			SM5442 SM5442			





TOYOTA Van

1987-89	4WD		343140		KG4644A						
1984-89	2WD w/ Rear Coil Springs 2WD w/ Rear Leaf Springs		344055	KG4652A KG4652A	KG5463 KG5538						

⁶⁸ New Part Number; Available 3rd Quarter 2010

Notes de bas de Page 259 - Guia de notas al calce del catalogo Pg. 260
 Bold part numbers indicate the most comparable KYB product to the original design & performance.
 (22) For vehicles with Electronic Susp., Leveling Control, and Air Suspensions refer to Appendix C.

Applications For Pass. Cars, Light Trucks, SUV's, & Vans

VEHICLE MAKE, MODEL & YEAR		GR-2 <i>Excel-G</i>		Gas-a-Just		MonoMax 56XXXX Series AGX 7XXXXX Series		STRUT & SHOCK MOUNTS		BOOT KITS	
MARQUE, MODELE ET ANNEE DU VEHICULE											
LA MARCA EL MODELO & ANO											

TOYOTA Yaris

2006-08	ALL	Right Hand Left Hand	334472 334473	343442 343442							
---------	-----	-------------------------	------------------	------------------	--	--	--	--	--	--	--

TRIUMPH Spitfire, GT6, Herald, TR7, TR8

1976-83	TR7, TR8		363015			KG5550					
1969-73	GT6-Plus					KG9125					
1959-80	Spitfire, GT6 (Exc.Plus), Herald					KG9125	KG3198				

U.S. POSTAL VEHICLE All Models

1999-03	Ford Chassis		341302	344269	KG54309	KG5490					
1995-00	GMC Chassis		344265	344041	KG5478	KG5451					
---	AM General Model FJ-8A AM General Model FJ-9 AM General Models DJ-5A,B,C,D LLV Model by Grumman		344426 344040	344426 344041	KG5401 KG5419 KG5401 KG5450	KG5401 KG5426	565037 565046	565047			

UTILIMASTER All Models

---	Aeromate		235901			KG4524			SM5003		SB103
-----	----------	--	--------	--	--	--------	--	--	--------	--	-------

VOLKSWAGEN Beetle (New)

1998-08	ALL		334812	343280			734033	743029	SM5181	SM5182	SB123	SB125
---------	-----	--	--------	--------	--	--	--------	--------	--------	--------	-------	-------

VOLKSWAGEN Cabrio

1995-02	ALL Upper Spring Seat		235614	343191		KG9130			SM5378	SM5070 SM5132	SB109	SB115
---------	--------------------------	--	--------	--------	--	--------	--	--	--------	------------------	-------	-------

VOLKSWAGEN Cabriolet

1990-93	ALL w/ Sealed Struts			341007		KG9105 ²			SM5011	SM5070	SB109	SB115
1985-93	ALL (Exc. Sealed Struts)		361005 ¹⁵	341007		KG9105 ²			SM5011	SM5070	SB109	SB115

VOLKSWAGEN Corrado (Exc.V6)

1992-95	VR6 Strut Mounting Kit								SM5378	SM5070		
1990-94	Upper Spring Seat ALL w/ Sealed Struts ALL (Exc. Sealed Struts)		235614 364014 ¹⁵	343191 343191		KG9130 KG9130			SM5012 SM5012	SM5132 SM5070 SM5070	SB109 SB109	SB115 SB115

VOLKSWAGEN Dasher

1974-81	ALL		364001			KG5532			SM5011		SB103	
---------	-----	--	--------	--	--	--------	--	--	--------	--	-------	--

VOLKSWAGEN Eos

2008-09	Standard Susp. From VIN 1F-8-015001		335808									
2007-09	ALL			349022								

VOLKSWAGEN Eurovan

1993-03	ALL		344261									
---------	-----	--	--------	--	--	--	--	--	--	--	--	--

VOLKSWAGEN Fox

1987-93	Sedan Station Wagon		365008 365008						SM5024 SM5024	SM5376 SM5376	SB101 SB101	
---------	------------------------	--	------------------	--	--	--	--	--	------------------	------------------	----------------	--

¹⁵ Reuse original internal-threaded strut body nut on certain applications; or replace with VW P/N 823412047.

² The KYB replacement unit comes with a new dustcover/ bumper assembly.

Notes de bas de Page 259 - Guia de notas al calce del catalogo Pg. 260

Bold part numbers indicate the most comparable KYB product to the original design & performance.

(22) For vehicles with Electronic Susp., Leveling Control, and Air Suspensions refer to Appendix C.

Applications For Pass. Cars, Light Trucks, SUV's, & Vans

VEHICLE MAKE, MODEL & YEAR		GR-2		Gas-a-Just		MonoMax 56XXXX Series		STRUT & SHOCK			
MARQUE, MODELE ET		Excel-G				AGX 7XXXX Series		MOUNTS		BOOT KITS	
ANNEE DU VEHICULE											
LA MARCA EL MODELO & ANO											

VOLKSWAGEN GTI

2006-09	ALL	335808	344459								
---------	-----	--------	--------	--	--	--	--	--	--	--	--

VOLKSWAGEN City Golf (Canadian Vehicle)

2007-09	City Golf (Canada Only)	334812	343280				743029				
---------	-------------------------	--------	--------	--	--	--	--------	--	--	--	--

VOLKSWAGEN City Jetta (Canadian Vehicle)

2007-09	City Jetta (Canada Only)	334812	343280				743029				
---------	--------------------------	--------	--------	--	--	--	--------	--	--	--	--

VOLKSWAGEN Golf

1999-05	Golf IV Strut Boot (Exc. R32 Performance Package) Shock Mount (Exc. R32 Performance Package) (IV)	334812	343280			734033	743029	SM5181	SM5182	SB123	SB125
1997-99	Strut Mounting Kit 4 cyl. Gas (III)							SM5378			
1996-98	Strut Mounting Kit 4 cyl. Diesel (III)							SM5378			
1995-99	Strut Mounting Kit 6 cyl. Gas (III)							SM5378			
1993-99	Upper Spring Seat (III) Golf III (Exc. VR6) Golf III w/ VR6	235614 235614	343191 343191		KG9130 KG9130			SM5012	SM5132 SM5070 SM5070	SB109 SB109	SB115 SB115
1990-92	ALL w/ Sealed Struts	235614	343191		KG9130			SM5012	SM5070	SB109	SB115
1985-92	Upper Spring Seat ALL (Exc. Sealed Struts)	364014 ¹⁵	343191		KG9130			SM5012	SM5132 SM5070	SB109	SB115

VOLKSWAGEN Jetta

2006-09	ALL	335808	344459							SB101	SB107
1999-05	Jetta (IV)	334812	343280			734033	743029	SM5181	SM5182	SB123	SB125
1997-99	Strut Mounting Kit 4 cyl. Gas (III)							SM5378			
1996-99	Upper Spring Seat (III) Jetta III	235614	343191		KG9130				SM5132 SM5070	SB109	SB115
1995-99	Strut Mounting Kit 6 cyl. Gas (III)							SM5378			
1990-95	ALL	235614	343191		KG9130			SM5012	SM5070	SB109	SB115
1985-95	Upper Spring Seat								SM5132		
1985-89	ALL	364014 ¹⁵	343191		KG9130			SM5012	SM5070	SB109	SB115
1980-84	ALL	361005 ¹⁵	341007		KG9105 ²			SM5011	SM5070	SB109	SB113

VOLKSWAGEN Passat

2009-10	Strut Boot									SB101	
2006-08	AWD FWD	335808 335808	344459 344459							SB101 SB101	
2001-05	Strut Mounting Kit from VIN #3B1300001 Strut Mounting Kit from VIN #3B1300001 (exc. AWD)							SM5380	SM5379		
2000-05	Sedan (FWD) From VIN # 3B-Y-200001	341273	343281					SM5380	SM5379	SB122	SB124
1998-01	Shock Mount To VIN #3B1300001 (Exc. AWD)								SM5237		
1998-00	Sedan (FWD) To VIN # 3B-Y-200000	341207	343281					SM5236	SM5237	SB122	SB124
1993-97	Strut Mounting Kit VR6							SM5378	SM5197		
1990-97	ALL (Exc. V6 Models) (Exc. Sealed Strut)	365070	341124					SM5012	SM5197	SB109	SB115

¹⁵ Reuse original internal-threaded strut body nut on certain applications; or replace with VW P/N 823412047.



² The KYB replacement unit comes with a new dustcover/ bumper assembly.

Notes de bas de Page 259 - Guia de notas al calce del catalogo Pg. 260

Bold part numbers indicate the most comparable KYB product to the original design & performance.

(22) For vehicles with Electronic Susp., Leveling Control, and Air Suspensions refer to Appendix C.

Applications For Pass. Cars, Light Trucks, SUV's, & Vans

VEHICLE MAKE, MODEL & YEAR		GR-2		Gas-a-Just		MonoMax 56XXXX Series		STRUT & SHOCK			
MARQUE, MODELE ET		Excel-G				AGX 7XXXXX Series		MOUNTS		BOOT KITS	
ANNEE DU VEHICULE											
LA MARCA EL MODELO & ANO											

VOLKSWAGEN Quantum, Quantum Synchro

1986-88	Quantum Synchro	365008						SM5034	SM5377	SB101	
4/83-88	ALL (Exc. Quantum Synchro)	365008	341123		KG9124			SM5034	SM5377	SB101	SB107
1982-3/83	ALL	365008	341122		KG9111			SM5034	SM5377	SB101	SB107

VOLKSWAGEN Rabbit

2006-09		335808	344459								
1975-84	ALL	361005 ¹⁵	341007		KG9105 ²			SM5011	SM5070	SB109	SB113

VOLKSWAGEN Rabbit (Truck)

1980-84	ALL	361005 ¹⁵			KG5449			SM5011		SB102	
---------	-----	----------------------	--	--	--------	--	--	--------	--	-------	--

VOLKSWAGEN Routan

2009-10	Strut Boot									SB101	
---------	------------	--	--	--	--	--	--	--	--	-------	--

VOLKSWAGEN Scirocco, Scirocco 16V

1975-90	ALL	361005 ¹⁵	341007		KG9105 ²			SM5011	SM5070	SB109	SB113
---------	-----	----------------------	--------	--	---------------------	--	--	--------	--------	-------	-------

VOLKSWAGEN Thing

1973-75	ALL Shock (Sleeve) Adapter Kit	343143 ³ KIT103	343144	KG4520 ³ KIT103	KG5529						
---------	-----------------------------------	-------------------------------	--------	-------------------------------	--------	--	--	--	--	--	--

VOLKSWAGEN Type 1 - Beetle (Original), SuperBeetle, Karmann Ghia

1973-80	Super Beetle From Chassis No. 1,333,003,657	363002	343144		KG5529					SB101	
1971-73	Super Beetle Thru Chassis No. 1,333,003,656	363012	343144		KG5529					SB101	
1967-77	ALL (Exc. Super Beetle)	343143	343144	KG4520	KG5529					SB101	
1966	1200 Model ALL (Exc. 1200 Model)	343144 343143	343144 343144	KG4521 KG4520	KG5529 KG5529						
1952-65	ALL	343144	343144	KG4521	KG5529						

VOLKSWAGEN Type 2 - Van, Vanagon

1986-91	Synchro		344082		KG5459		565050				
1980-91	ALL (Exc. Synchro)	345006			KG5557						
1955-67	ALL	343144	343144	KG4521	KG5529						
1968-79	ALL Shock (Sleeve) Adapter Kit	343144	344045 ⁷ KIT107	KG4521	KG5530						

VOLKSWAGEN Type 3 - Squareback, Fastback

1966-73	ALL	343144	343144	KG4521	KG5529						
---------	-----	--------	--------	--------	--------	--	--	--	--	--	--

VOLVO 120, 130, 220 Series

1961-70	120 Station Wagon ALL (Exc. 120 Station Wagon)	343137 343137	343030 343219	KG5514 KG5514	KG4006 KG5517						
---------	---	------------------	------------------	------------------	------------------	--	--	--	--	--	--

VOLVO 140, 160 Series

1975	164 Model	343127	343010	KG4550	KG5553						
1967-74	ALL	343127		KG4550	KG5535						











¹⁵ Reuse original internal-threaded strut body nut on certain applications; or replace with VW P/N 823412047.

² The KYB replacement unit comes with a new dustcover/ bumper assembly.

³ Use Kit #103

⁷ Use Kit #107

Applications For Pass. Cars, Light Trucks, SUV's, & Vans

VEHICLE MAKE, MODEL & YEAR		GR-2		Gas-a-Just		MonoMax 56XXXX Series		STRUT & SHOCK			
MARQUE, MODELE ET		Excel-G				AGX 7XXXXX Series		MOUNTS		BOOT KITS	
ANNEE DU VEHICULE		 		 		 		 		 	
LA MARCA EL MODELO & ANO											

VOLVO 1800S , E , ES Series

1961-73	ALL	343137	343219	KG5514	KG5517						
---------	-----	--------	--------	--------	--------	--	--	--	--	--	--

VOLVO 240, 260 Series

1979-93	ALL (Exc. w/ High Pressure) High Pressure Gas Strut Equipped	365006 365006 ¹³	343010 343010		KG5553 KG5553			SM5050 SM5050		SB101	
1979-85	265 Model (Exc. Nivomat Rear Susp.)	365006	343010		KG5553			SM5050		SB101	
1975-78	ALL	365006	343010		KG5553			SM5050		SB101	

VOLVO 740 Series

1985-92	ALL (Exc. Nivomat Susp.)	365053	344270		KG5565 ¹⁴			SM5092		SB111	
1983-84	ALL (Exc. Nivomat Susp.)		344270		KG5565 ¹⁴			SM5092		SB111	

VOLVO 760 Series

1988-93	Sedan	365053						SM5092		SB111	
1985-92	Station Wagon (Exc. Nivomat Susp.)	365053	344270		KG5565 ¹⁴			SM5092		SB111	
1985-87	Sedan (Exc. Nivomat Susp.)	365053	344270		KG5565 ¹⁴			SM5092		SB111	
1983-84	ALL (Exc. Nivomat Susp.)		344270		KG5565 ¹⁴			SM5092		SB111	

VOLVO 780 Series

1988-93	ALL	365053						SM5092		SB111	
---------	-----	--------	--	--	--	--	--	--------	--	-------	--

VOLVO 850 Series

1993-97	FWD (Exc. Self Leveling Rear Susp.) FWD w/ Self Leveling Rear Springseat	SR1001 ³¹ SR1001 ³¹			KG5747			SM5165 SM5165 SM5351	SM5220	SB103 SB103	
---------	--	--	--	--	--------	--	--	----------------------------	--------	----------------	--

VOLVO 940 Series

1995	ALL (Exc. Nivomat Susp.)	365053	344270		KG5565 ¹⁴			SM5092		SB111	
1991-95	ALL w/ Nivomat Rear Susp.	365053						SM5092		SB111	
1991-94	ALL (Exc. Nivomat Rear Susp.)	365053	344270		KG5565			SM5092		SB111	

VOLVO 960 Series

1991-9/94	ALL (Exc. Nivomat Rear Susp.) ALL w/ Nivomat Rear Susp.	365053 365053	344270		KG5565			SM5092 SM5092		SB111 SB111	
-----------	--	------------------	--------	--	--------	--	--	------------------	--	----------------	--

VOLVO C70 (Exc. Self-Leveling Susp.)

1998-04	ALL Springseat	SR1001 ³¹			KG5747			SM5165 SM5351	SM5220	SB103	
---------	-------------------	----------------------	--	--	--------	--	--	------------------	--------	-------	--

VOLVO Coupe

1991	ALL	365053						SM5092		SB102	
------	-----	--------	--	--	--	--	--	--------	--	-------	--

VOLVO PV-444, PV-544 Series

1945-66	Sedans		343039		KG5552						
---------	--------	--	--------	--	--------	--	--	--	--	--	--

VOLVO S40













2005-09	ALL (Exc. Sport Susp.)	Right Hand Left Hand	334842 334843	343419 343419							
---------	------------------------	-------------------------	------------------	------------------	--	--	--	--	--	--	--

¹³ If originally equipped with High Pressure Gas Cartridges; These parts are required to install [365006]:1) PN 1229423-7 (from Volvo) installed under the cartridge, 2) Strut Boot # [SB 101] installed on the cartridge piston rod.

¹⁴ On models with Nivomat self-leveling rear shocks, to install [KG5565] replace the original coil spring

³¹ When [SR1001] stock is depleted, use [334678]

Applications For Pass. Cars, Light Trucks, SUV's, & Vans

VEHICLE MAKE, MODEL & YEAR	  	STRUT & SHOCK		BOOT KITS	
MARQUE, MODELE ET		MOUNTS			
ANNEE DU VEHICULE					
LA MARCA EL MODELO & ANO					
	 	 	 	 	 

VOLVO S40 (continued)

2004	ALL w/ 2.4L & 2.5L	Right Hand Left Hand	334842 334843	343419 343419							
2001-04	ALL 1.9L	Right Hand Left Hand	334438 334439	341217 341217							
2000-04	Upper Mount Kit First Generation Upper Spring Seat Insulator First Generation								SM5091 SM5439		
2000	Strut Mount Bearing First Generation								SM5128		

VOLVO S60

2001-08	2.5T AWD FWD Strut Mount w/ Bearing Exc. AWD & Adj. Susp. Springseat		334611 334611		551918				SM5475 SM5351	SM5493	SB103
---------	--	--	------------------	--	--------	--	--	--	------------------	--------	-------

VOLVO S70

1998-00	FWD Springseat		SR1001 ³¹		KG5747				SM5165 SM5351	SM5220	SB103
---------	-------------------	--	----------------------	--	--------	--	--	--	------------------	--------	-------

VOLVO S80

2001-05	Strut Mount w/ Bearing (from chassis # 153440)								SM5475		
1999-06	ALL (Exc. Nivomat Rear Susp.) Exc. AWD & Adj. Susp. from Chassis 13723		334611		551918					SM5493	SB103
1999-05	Springseat								SM5351		
1999-01	Strut Mount To Chassis # 153439								SM5165		

VOLVO S90

1997-98	Strut Mount w/ Bearing								SM5092		
---------	------------------------	--	--	--	--	--	--	--	--------	--	--

VOLVO V40

2001-04	ALL	Right Hand Left Hand	334438 334439	341217 341217							
---------	-----	-------------------------	------------------	------------------	--	--	--	--	--	--	--

VOLVO V50

2005-09	ALL	Right Hand Left Hand	334842 334843	343419 343419							
---------	-----	-------------------------	------------------	------------------	--	--	--	--	--	--	--

VOLVO V70









2001-06	Exc. AWD & Adj. Susp.									SM5493	
2001-05	Strut Mount w/ Bearing								SM5475		
3/00-07	Station Wagon 2WD		334611		551918						SB103
1998-04	Springseat								SM5351		
1998-2/00	V70 FWD Station Wagon (Exc. Cross Country or Nivomat Rear Susp.)		SR1001 ³¹		KG5747				SM5165	SM5220	SB103

VOLVO V90

1997-98	Strut Mount w/ Bearing								SM5092		
---------	------------------------	--	--	--	--	--	--	--	--------	--	--

³¹ When [SR1001] stock is depleted, use [334678]

Applications For Pass. Cars, Light Trucks, SUV's, & Vans

VEHICLE MAKE, MODEL & YEAR	GR-2	Gas-a-Just	MonoMax 56XXXX Series	STRUT & SHOCK	
MARQUE, MODELE ET	Excel-G		AGX 7XXXXX Series	MOUNTS	BOOT KITS
ANNEE DU VEHICULE	 	 	 	 	 
LA MARCA EL MODELO & AÑO					

VOLVO XC90

2003-05	ALL Springseat	NA	NA					SM5475 SM5351		SB101	
---------	-------------------	----	----	--	--	--	--	------------------	--	-------	--

Notes de bas de Page 259 - Guia de notas al calce del catalogo Pg. 260

Bold part numbers indicate the most comparable KYB product to the original design & performance.
(22) For vehicles with Electronic Susp., Leveling Control, and Air Suspensions refer to Appendix C.

APPENDIX A

SUBJECT: MacPherson strut cartridge replacement on GM-10 series ("W"-car) vehicles. This includes 1988 and later Pontiac Grand Prix, Oldsmobile Cutlass and Buick Regal, 1989 and later Chevrolet Lumina.

PROBLEM: A MacPherson strut spring compressor is not required to replace the MacPherson struts on these vehicles. The strut cartridge is removed and replaced through the body shock tower. Special tools are required.

W-CAR TOOL SUPPLIERS

COMPANY	PHONE
Branick #GMW-594	1-800-437-4394
GP Tool # GP2013-8 w/ #GP2013-12	1-800-223-0555
Schley #88400	1-714-693-7666
Specialty #88802 w/ # 88805	1-800-525-6505



CAUTION:

Do not service the strut unless the vehicle is on the floor. All 4 tires must be on the floor and facing straight ahead, otherwise the coil spring can fly free.

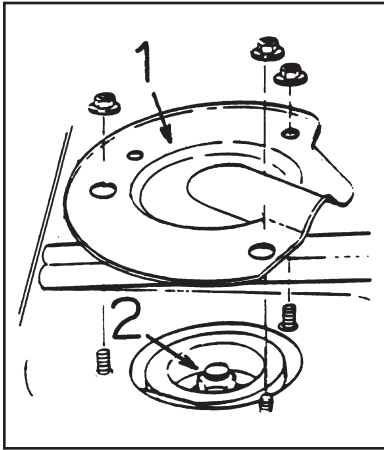

1. Remove the three nuts and the strut mount cover (Item 1). Remove the strut piston rod nut (Item 2).

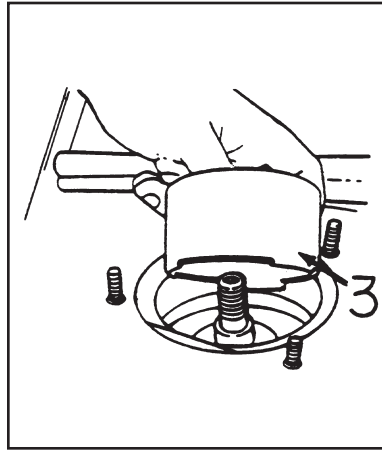

2. Remove the strut mount bushing (Item 3) by prying with a suitable tool.

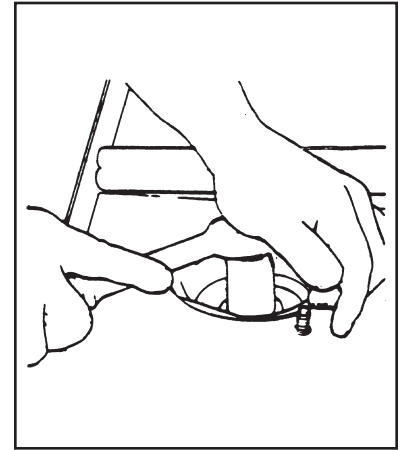

3. Remove the jounce bumper retaining plate using a special tool. Rotate tool counterclockwise to remove.

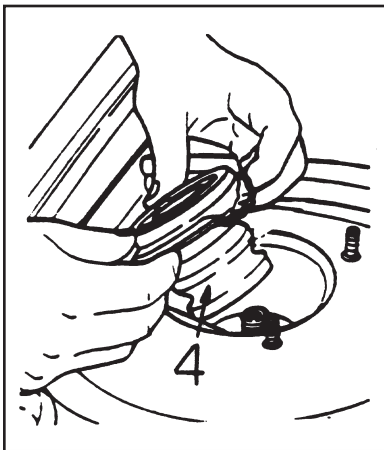

4. Remove the jounce bumper (Item 4).

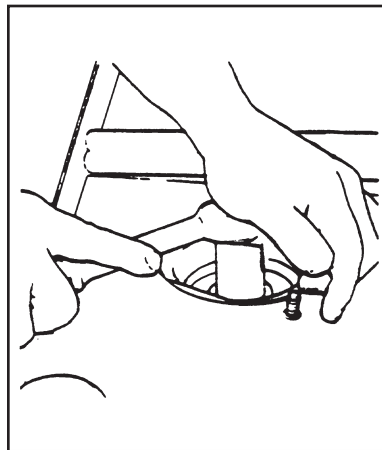

5. Remove the strut cartridge retaining nut using a special tool.

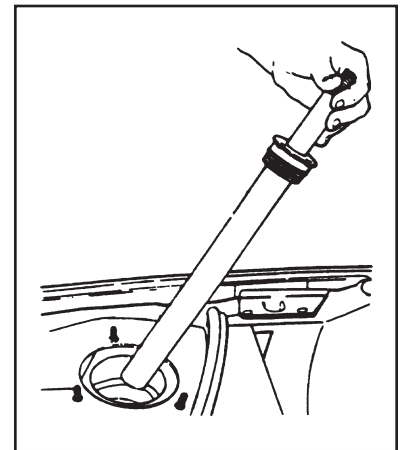

6. Remove the strut cartridge and replace with a new unit. Replace all components in reverse order of disassembly. Torque cartridge retaining nut and all nuts and bolts to manufacturer's specifications.

APPENDIX B

SELF LEVELING SYSTEM ELECTRONIC COMPRESSOR DEACTIVATION PROCEDURE FOR GM MODELS

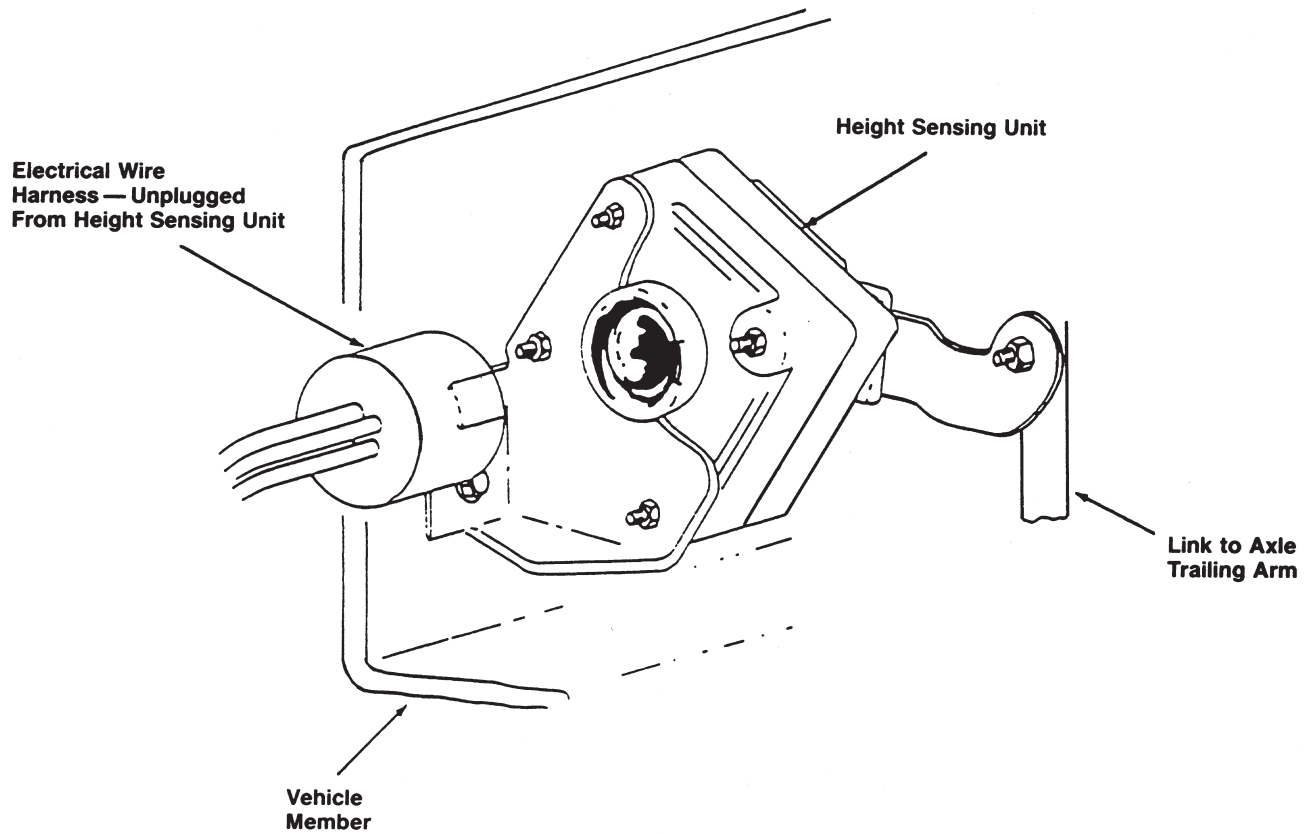

When installing conventional shock absorbers on GM models equipped with self-leveling rear suspension that uses an electronic compressor, the following procedure should be used:

- 1) Locate height sensing unit on under body of vehicle approximately above the rear axle. Locate a small link connected to the rear axle trailing arm. The upper end of this link will be connected to the electronic height sensing unit.
- 2) Unplug electrical wire harness from the height sensing unit. System is now deactivated.
- 3) Cover exposed electrical connector with tape or other suitable material and secure to underside of vehicle.
- 4) It is Not necessary to disconnect link to axle trailing arm.

APPENDIX C

ELECTRONIC SUSPENSIONS AIR SUSPENSIONS AND ELECTRONIC LEVEL CONTROLS

Occasionally a customer will inquire if their vehicle's electronic suspension, air suspension or rear electronic level control can be replaced with standard components. The following chart will assist you in determining answers to these inquiries.

VEHICLE/SYSTEM

GM, FORD, CHRYSLER FULLSIZE AND INTERMEDIATES

Electronic level control ELC; known also as air shocks, air struts.

In most cases, standard shocks and struts can be installed if the ELC System is disarmed. Refer to Appendix B for one such disarming procedure.

LINCOLN CONTINENTAL, MITSUBISHI GALANT, SUBARU

Air suspension struts; i.e.,

These systems cannot be substituted for without extensive vehicle modification. KYB does not recommend removal.

DODGE STEALTH 1991-96 with ECS (Electronic Controlled Suspension)

1. Remove front struts and rear shock activators.
 2. Unplug control module behind right rear trim panel.
 3. Remove and install struts and shocks per instruction sheet supplied with units.
 4. Use the following units: 335013 Front, 341184 Rear (2 W/D), 341185 Rear (4 W/D).
-

CHEVROLET CORVETTE 1990-94 — with ERC (Electronic Ride Control)

1. Remove shock actuators.
 2. Unplug ERC module located in rear cargo area.
 3. Remove & install shocks per instruction sheet supplied with units.
 4. Use the following units: KG5570 Front, KG5571 Rear.
-

FORD PROBE GT 1989-92 — with PRC (Programmed Ride Control)

1. Remove strut actuators.
 2. Unplug PRC module located under the passenger seat.
 3. Remove & install struts per instruction sheet supplied with units.
 4. Use the following units: 235046 Right Front, 235047 Left Front, 235606 Rear.
-

FORD THUNDERBIRD SUPER COUPE 1989-96 with PRC (Programmed Ride Control)

This system cannot be substituted without extensive vehicle modification. KYB Does Not Recommend Removal.

FORD THUNDERBIRD TURBO COUPE 1987-88 with PRC (Programmed Ride Control)

1. Remove strut and shock actuators.
 2. Unplug PRC module located in the trunk behind rear seat.
 3. Remove & install struts and shocks per instruction sheet supplied with units.
 4. Use the following units: 235008 Front, KG5556 Rear.
-

MAZDA MX6 GT 1988-92 — with AAS (Auto Adjust Suspension)

1. Remove strut actuators.
 2. Unplug AAS module located in the trunk.
 3. Remove & install struts per instruction sheet supplied with units.
 4. Use the following units: 235046 Right Front, 235047 Left Front, 235606 Rear.
-

MAZDA RX7 TURBO 1989-92 & MAZDA RX7 GXL 1986-88 with AAS (Auto Adjust Suspension)

1. Remove strut and shock actuators.
 2. Unplug AAS module located in the trunk.
 3. Remove and install struts & shocks per instruction sheet supplied with units.
 4. Use the following units: 235012 Right Front, 235013 Left Front, KG9132 Rear.
-

MAZDA 323 1986-89 — with ASA (Adjustable Shock Absorber)

1. Remove strut actuators.
 2. Unplug control switch connector behind the dash.
 3. Remove & install struts per instruction sheet supplied with units.
 4. Use the following units: 234008 Right Front, 234009 Left Front, 232011 Right Rear, 232012 Left Rear.
 5. NOTE: The front upper mount must be replaced with a standard OE upper mount.
-

MAZDA 626 1988-92 with AAS (Auto Adjust Suspension)

1. Remove strut actuators.
 2. Unplug AAS module located in the trunk.
 3. Remove & install shocks per instruction sheet supplied with units.
 4. Use the following units: 235046 Right Front, 235047 Left Front, 235606 Rear.
-

MAZDA 626 1983-87 — with AAS (Auto Adjust Suspension)

1. Remove strut actuators.
 2. Unplug AAS module located in the trunk.
 3. Remove & install struts per instruction sheet supplied with units.
 4. Use the following units: 233007 Right Front, 233008 Left Front, 234050 Rear.
-

MERCURY COUGAR XR7 1987-88 with PRC (Programmed Ride Control)

1. Remove strut and shock actuators.
 2. Unplug PRC module located in the trunk behind rear seat.
 3. Remove & install struts and shocks per instruction sheet supplied with units.
 4. Use the following units: 235008 Front, KG5556 Rear.
-

MERCURY COUGAR XR7 1989-96 with PRC (Programmed Ride Control)

This system cannot be substituted without extensive vehicle modification. KYB Does Not Recommend Removal.

MITSUBISHI 3000 GT 1991-99 with ECS (Electronic Controlled Suspension)

1. Remove front struts and rear shock activators.
 2. Unplug control module behind right rear trim panel.
 3. Remove and install struts and shocks per instruction sheet supplied with units.
 4. Use the following units: 335013 Front, 341184 Rear (2 W/D), 341185 Rear (4 W/D).
-

MITSUBISHI MONTERO 1992-96 with VSA (Variable Shock Absorbers)

1. Remove shock activators.
 2. Unplug control module behind left rear trim panel.
 3. Remove and install shocks per instruction sheet supplied with units.
 4. Use the following units: KG54302 Front, KG54303 Rear.
-

NISSAN 300ZX 1984-89 with ECVSA (Electronically Controlled Variable Shock Absorber)

1. Remove strut and shock actuators.
 2. Unplug ECVSA control module per Kit 108A instruction.
 3. Remove & install cartridges and shocks per instruction sheet supplied with units and Kit 108A.
 4. Use the following units: 365056 Front, KG5787A Rear.
 5. NOTE: Conversion Kit 108A (1 req.) necessary to convert entire vehicle. The original rear shock bumpers are not reusable.
-

NISSAN 300ZX 1990-95 with ECVSA (Electronically Controlled Variable Shock Absorber)

1. Remove shock actuators.
 2. Unplug the ECVSA control module.
 3. Remove & install shocks per instruction sheet supplied with units.
 4. Fire/drill open round hole ($\frac{1}{2}$ " i.d.) in front shock upper insulator.
 5. Fire/drill open ($\frac{7}{16}$ " i.d.) the rear shock upper mount spacer.
 6. Use the following units: 341149 Right Front 341150 Left Front, 341151 Rear.
-

NISSAN MAXIMA 1989-94 with Nissan Sonar Suspension II

1. Remove strut actuators.
 2. Unplug NSS module located in the console.
 3. Remove and install struts & shocks per instruction sheet supplied with units.
 4. Use the following units: 235051 Right Front, 235052 Left Front, 365079 Rear.
-

NISSAN MAXIMA 1985 with ECVSA (Electronically Controlled Variable Shock Absorber)

1. Remove the strut actuators.
 2. Unplug ECVSA module located in the trunk.
 3. Remove & install struts per instruction sheet supplied with units.
 4. Replace the front strut mounts with KYB #SM5065 and the front upper spring seats, thrust seats, and strut tower covers with Nissan P/N's: 54040-05E00, 54043-01E00, and 54380-05E00. Two each of these 4 P/N's are required.
 5. Use the following units: 235030 Right Front, 235031 Left Front, and 365080 Rear.
-

NISSAN MAXIMA 1986-88 with ECVSA (Electronically Controlled Variable Shock Absorber)

1. Remove the strut actuators.
 2. Unplug ECVSA module located in the trunk.
 3. Remove & install struts per instruction sheet supplied with the units.
 4. Replace the front strut mounts with KYB #SM5065 and the front upper spring seats, thrust seats, and strut tower covers with Nissan P/N's: 54040-05E00, 54043-01E00, and 54380-05E00. Two each of these 4 P/N's are required.
 5. Use the following units: 235019 Right Front, 235020 Left Front, and 365080 Rear.
-

NISSAN PATHFINDER 1987-95 with ASA (Adjustable Shock Absorber)

1. Remove shock actuators.
 2. Unplug control switch located in console.
 3. Remove & install shocks per instruction sheet supplied with units.
 4. Use the following units: KG5476 Front, KG5438 Rear.
-

TOYOTA CRESSIDA 1986-88 with TEMS (Toyota Electronic Modulated Suspension)

1. Remove shock actuators.
 2. Unplug TEMS module located behind the right rear trim panel.
 3. Remove & install shocks per instruction sheet supplied with units.
 4. Use the following units: N/A Front, 343042 Rear.
-

TOYOTA SUPRA MAR. 1986-91 with TEMS (Toyota Electronic Modulated Suspension)

1. Remove shock actuators.
 2. Unplug TEMS module located under the dash.
 3. Remove & install shocks per instruction sheet supplied with units.
 4. Use the following units: 341069 Front, 341070 Rear.
-