

## GROUP 90

## CIRCUIT DIAGRAMS

## CONTENTS

HOW TO READ CIRCUIT DIAGRAMS	90-4	TAILLIGHT, POSITION LIGHT, FRONT SIDE MARKER LIGHT AND LICENSE PLATE LIGHT	90-90
JUNCTION BLOCK	90-10	FOG LIGHT	90-96
JOINT CONNECTOR	90-12	FRONT DOME LIGHT, REAR DOME LIGHT, TRUNK LIGHT AND IGNITION KEY HOLE ILLUMINATION LIGHT	90-102
CENTRALIZED JUNCTION	90-15	GLOVE BOX LIGHT	90-110
POWER DISTRIBUTION SYSTEM	90-22	VANITY MIRROR LIGHT	90-111
STARTING SYSTEM	90-28	TURN-SIGNAL LIGHT AND HAZARD WARNING LIGHT	90-112
IGNITION SYSTEM <2.4L ENGINE>	90-30	BACKUP LIGHT	90-120
IGNITION SYSTEM <3.8L ENGINE>	90-32	STOPLIGHT	90-122
CHARGING SYSTEM	90-34	HORN	90-123
MULTIPOINT FUEL INJECTION (MFI) SYSTEM <2.4L ENGINE>	90-36	METER AND GAUGE	90-124
MULTIPOINT FUEL INJECTION (MFI) SYSTEM <3.8L ENGINE>	90-46	BRAKE WARNING LIGHT, OIL PRESSURE WARNING LIGHT, FUEL WARNING LIGHT	90-130
COOLING SYSTEM	90-56	POWER WINDOWS	90-134
INVECS-II 4A/T <2.4L ENGINE>	90-58	CENTRAL DOOR LOCKING SYSTEM	90-138
INVECS-II 4A/T <3.8L ENGINE>	90-68		
HEADLIGHT <2-BULB TYPE>	90-78		
HEADLIGHT <4-BULB TYPE>	90-84		

Continued on next page

MANUAL AIR CONDITIONING SYSTEM <LOW> . . . . .	90-152	ELECTRONIC BRAKE-FORCE DISTRIBUTION (EBD) AND ANTI-LOCK BRAKING SYSTEM (ABS) <VEHICLES WITH TRACTION CONTROL (TCL)>. . . . .	90-230
MANUAL AIR CONDITIONING SYSTEM <MIDDLE> . . . . .	90-162	SUPPLEMENTAL RESTRAINT SYSTEM (SRS) . . . . .	90-236
AUTOMATIC AIR CONDITIONING SYSTEM. . . . .	90-172	ENGINE IMMOBILIZER SYSTEM . . . . .	90-246
WINDSHIELD WIPER AND WASHER	90-182	POWER SEAT . . . . .	90-250
REAR WINDOW DEFOGGER AND DOOR MIRROR HEATER . . . . .	90-188	HEATED SEAT . . . . .	90-252
REMOTE CONTROLLED MIRROR. . . . .	90-191	FORGOTTEN KEY PREVENTION FUNCTION . . . . .	90-256
AUDIO SYSTEM <VEHICLES WITHOUT AUDIO AMPLIFIER> . . . . .	90-192	LIGHTING MONITOR TONE ALARM	90-260
AUDIO SYSTEM <VEHICLES WITH AUDIO AMPLIFIER> . . . . .	90-196	IGNITION KEY REMINDER TONE ALARM . . . . .	90-262
ACCESSORY SOCKET. . . . .	90-202	SEAT BELT WARNING TONE ALARM . . . . .	90-264
MULTI-CENTER DISPLAY <LOW>. . . . .	90-204	DOOR AJAR WARNING TONE ALARM . . . . .	90-268
MULTI-CENTER DISPLAY <MIDDLE> . . . . .	90-206	RHEOSTAT. . . . .	90-273
SUNROOF . . . . .	90-212	CONTROLLER AREA NETWORK (CAN) . . . . .	90-274
AUTO-CRUISE CONTROL SYSTEM	90-216		
ELECTRONIC BRAKE-FORCE DISTRIBUTION (EBD) AND ANTI-LOCK BRAKING SYSTEM (ABS) <VEHICLES WITHOUT TRACTION CONTROL (TCL)> . . . . .	90-224		

NOTES

# HOW TO READ CIRCUIT DIAGRAMS

M1901000100704

The circuit of each system from the fuse (or fusible link) to ground is shown. The power supply is shown at the top and the ground at the bottom to facilitate understanding of how the current flows. Some variations are included in one circuit diagram. Accordingly, some diagrams may not be applicable for individual vehicles.

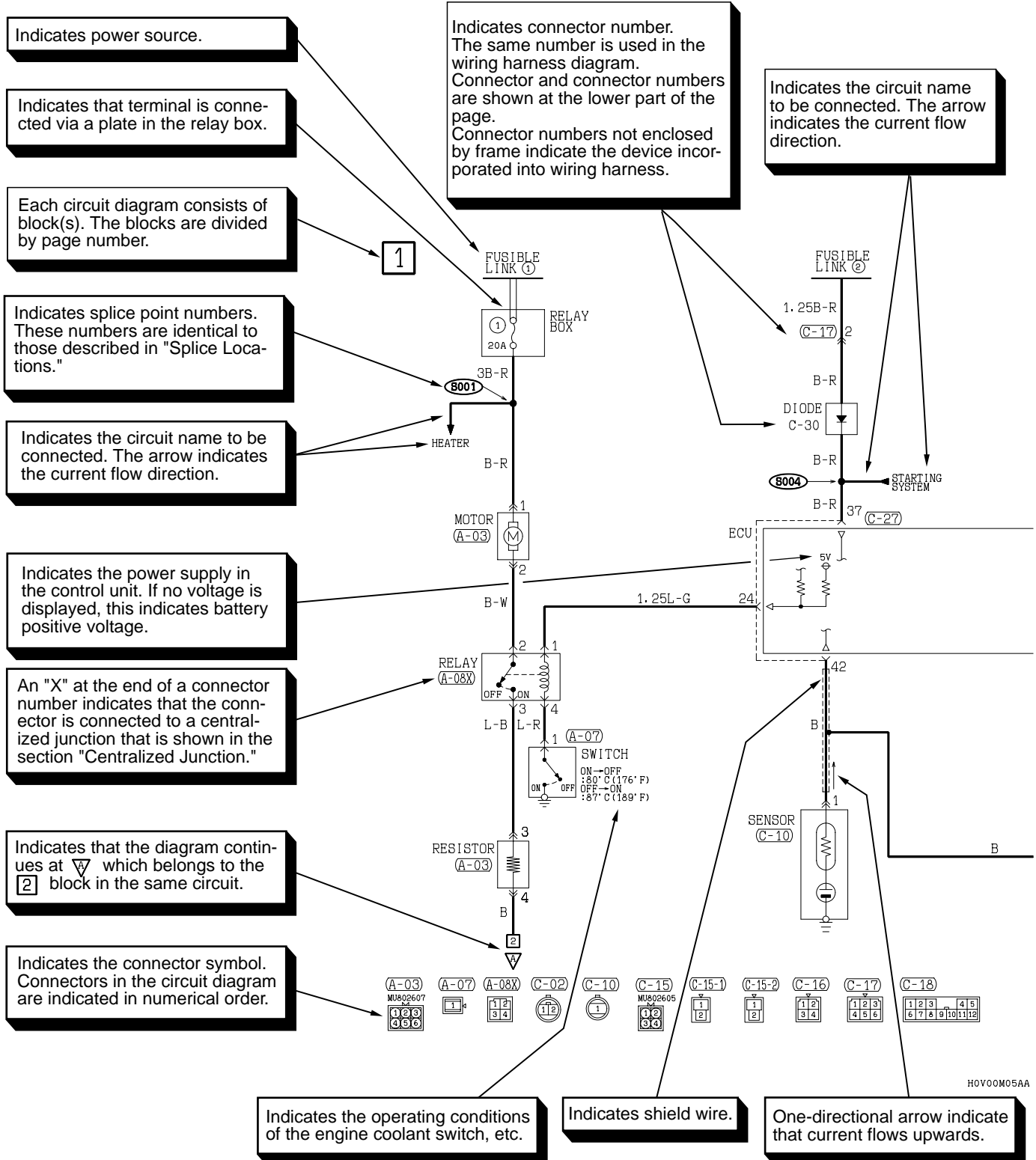

HOV00M05AA

AC106603AF

Indicates input/output to/from control unit (current flow direction).

Input Output Input/output

Indicates a wiring connector which is inside the equipment and which is not shown in the wiring harness configuration diagram.

Example C-15-2 Indicates a connector which is inside the equipment, numbered in order starting from 1.

Indicates the connector number shown in the wiring harness configuration diagram.

Indicates that the diagram comes from which belongs to the block in the same circuit.

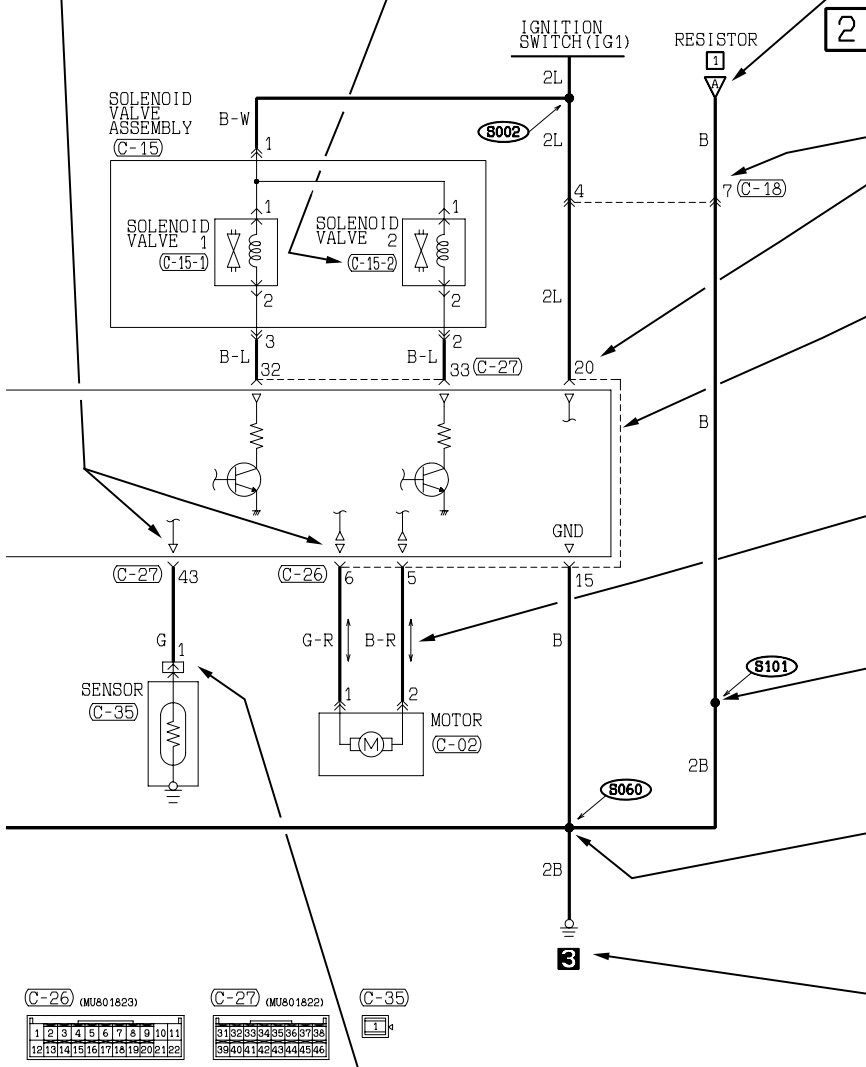

Indicates terminal number.

In case two or more connectors are connected to the same device, markings indicating the same connector is connected by a broken line.

Bi-directional arrow indicates that current flows in both directions due to control by an ECU.

Indicates harness junction where wire diameter or color changes.

Indicates intersections at which the lead wires are not connected.

Indicates intersections at which the lead wires are connected.

Indicates representative vehicle body ground point. (Same number as that of ground point in GROUNDING LOCATION).

(C-26) (MU/601823)

1	2	3	4	5	6	7	8	9	10	11
12	13	14	15	16	17	18	19	20	21	22

(C-27) (MU/601822)

31	32	33	34	35	36	37	38
39	40	41	42	43	44	45	46

(C-35)

1
---





Indicates that the terminal is a spare one if the device (sensor in this case) is not provided.

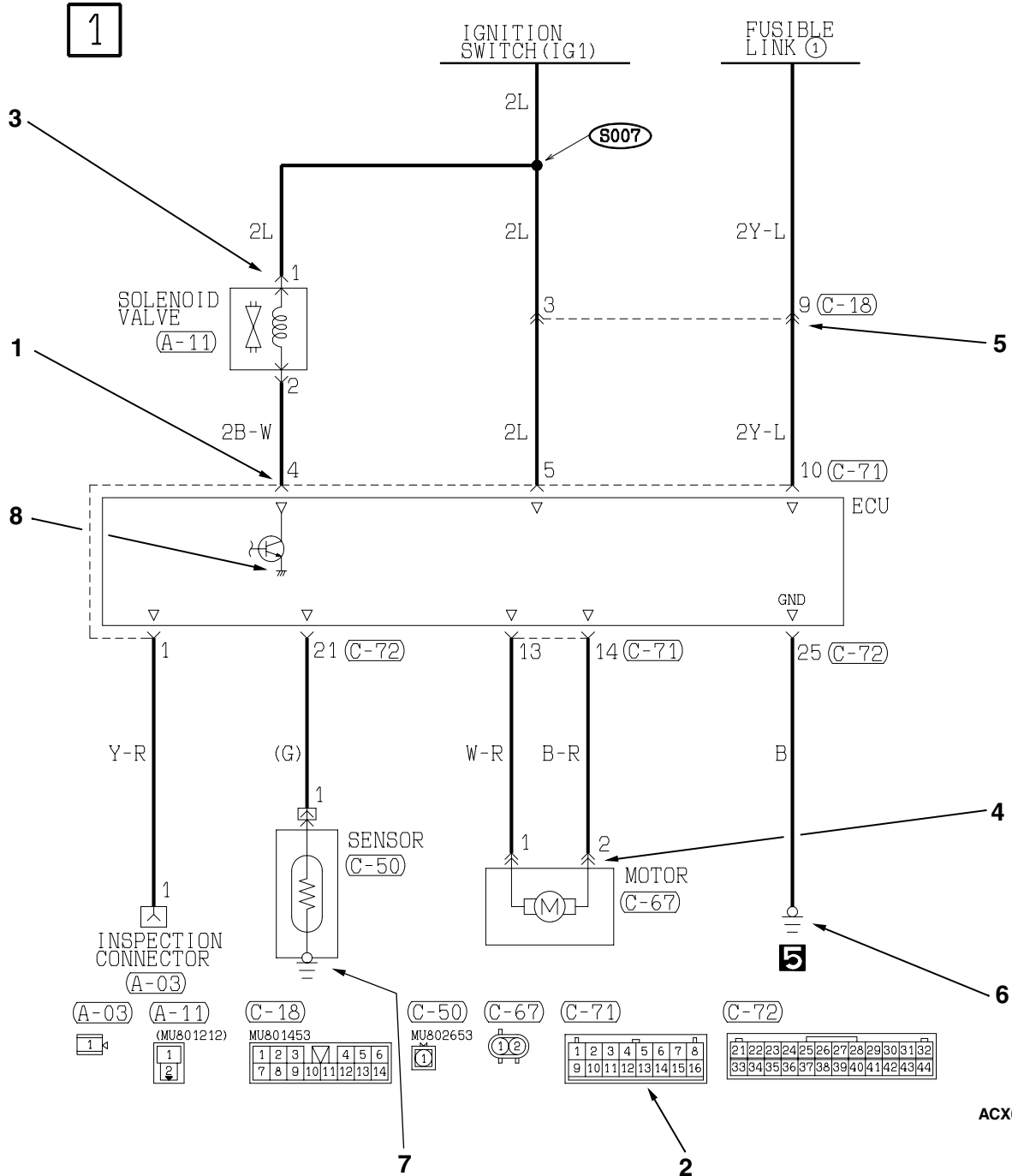



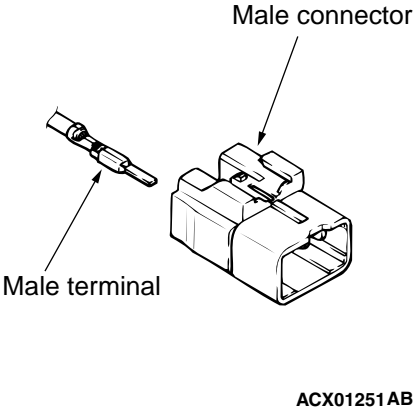

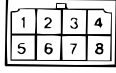
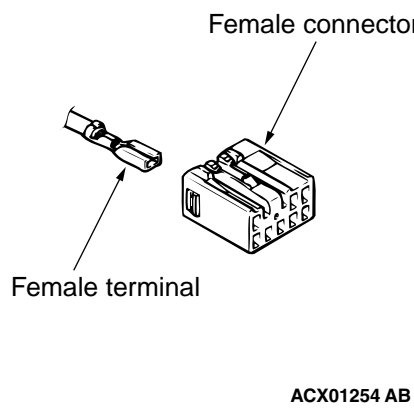

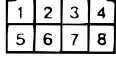
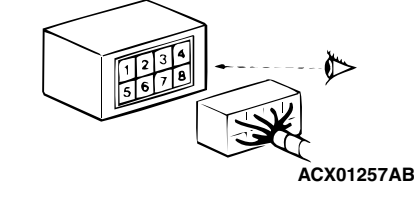
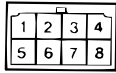
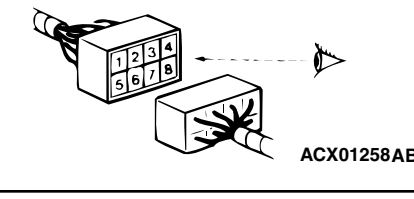
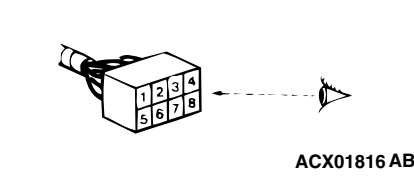
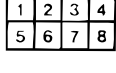
H0V00M05AB

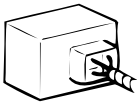
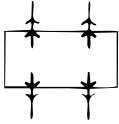
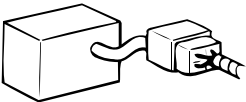
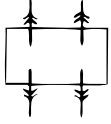
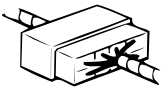
CONNECTOR/GROUNDING INDICATIONS



ACX02364 AC

























ITEM	NO.	CONNECTOR/ GROUNDING	SYMBOL	CONTENTS
Connector and terminal marking	1		Male terminal  ACX01252 AB	The male and female terminals are indicated as shown. The connector with male terminal(s) is called as male connector and indicated by two connector contour lines, while the connector with female terminal(s) is called as female connector and indicated by single connector contour line.
			Female connector  ACX01253 AB	
			Female terminal  ACX01255 AB	
			Female connector  ACX01256 AB	
Connector symbol marking	2	Device 	 ACX01253	The symbol indicates the connector is viewed as shown. At a device connection, the connector symbol on the device side is shown. For an intermediate connector, the male connector symbol is shown. For spare connectors and check connectors, no device is connected, and so the harness-side connector symbol is shown for these connectors.
		Intermediate connector 		
		Spare connector, check connector 	 ACX01256	

ITEM	NO.	CONNECTOR/ GROUNDING	SYMBOL	CONTENTS
Connector connection marking	3	Direct connection type  ACX01260 AB	 ACX01261	Connection between a device and the harness is either by direct insertion in the device (direct connection type) or by connection with a harness connector furnished on the device side (harness connection type). The two types are indicated as illustrated.
	4	Harness connection type  ACX01262 AB	 ACX01263	
	5	Intermediate connector  ACX01264 AB	 ACX01265	
Ground marking	6	Body ground  ACX01273 AB	 ACX01274	Grounding is either by body ground, device ground or control unit interior ground. These are indicated as illustrated.
	7	Device ground  ACX01275 AB	 ACX01276	
	8	Ground in control unit  ACX01277 AB	 ACX01278	

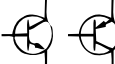

## SYMBOLS (EXCEPT CONNECTOR AND GROUNDING)

Devices appearing in circuit diagrams are indicated by the following symbols.

<p>Battery</p>  <p>ACX02377AB</p>	<p>Buzzer</p>  <p>ACX02378AB</p>	<p>Capacitor</p>  <p>ACX02379AB</p>	<p>Electrolytic capacitor</p>  <p>ACX02380AB</p>	<p>Variable capacitor</p>  <p>ACX02381AB</p>	<p>Coil</p>  <p>ACX02382AB</p>
<p>Diode</p>  <p>ACX02383AB</p>	<p>Light emitting diode</p>  <p>ACX02384AB</p>	<p>Photo diode</p>  <p>ACX02385AB</p>	<p>Zener diode</p>  <p>ACX02386AB</p>	<p>Dual filament bulb</p>  <p>ACX02387AC</p>	<p>Single filament bulb</p>  <p>ACX02388AC</p>
<p>Fuse</p>  <p>ACX02389AB</p>	<p>Fusible link</p>  <p>ACX02390AB</p>	<p>Horn</p>  <p>ACX02391AB</p>	<p>Motor</p>  <p>ACX02392AB</p>	<p>Pulse generator</p>  <p>ACX02393AB</p>	<p>Piezoelectric device</p>  <p>ACX02394AB</p>
<p>Resistor</p>  <p>ACX02395AB</p>	<p>Variable resistor</p>  <p>ACX02396AB</p>	<p>Speaker</p>  <p>ACX02397AB</p>	<p>Thermistor</p>  <p>ACX02398AB</p>	<p>Transistor</p>  <p>ACX02399AB</p>	<p>Photo transistor</p>  <p>ACX02400AB</p>

## WIRE COLOR CODES

Wire colors are identified by the following color codes.

CODE	WIRE COLOR	CODE	WIRE COLOR	CODE	WIRE COLOR	CODE	WIRE COLOR
B	Black	L	Blue	R	Red	Y	Yellow
BR	Brown	LG	Light green	SB	Sky blue	-	-
G	Green	O	Orange	V	Violet	-	-
GR	Gray	P	Pink	W	White	-	-

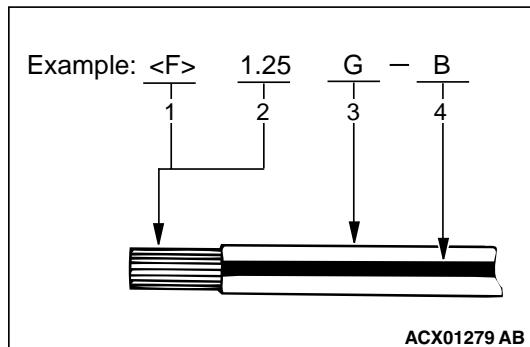

If a cable has two colors, the first of the two color code characters indicates the basic color (color of the cable coating) and the second indicates the marking (tracer) color.

NO.	MEANING
1	<F>: Flexible wire
	<T>: Twisted wire
2	Wire size (mm <sup>2</sup> )*
3	Basic color (color of the cable coating)
4	Marking color

**NOTE:**

\*: No code indicates 0.5 mm<sup>2</sup> (0.0008 in<sup>2</sup>). Cable color code in parentheses indicates 0.3 mm<sup>2</sup> (0.0005 in<sup>2</sup>).

# JUNCTION BLOCK

M1901000201027

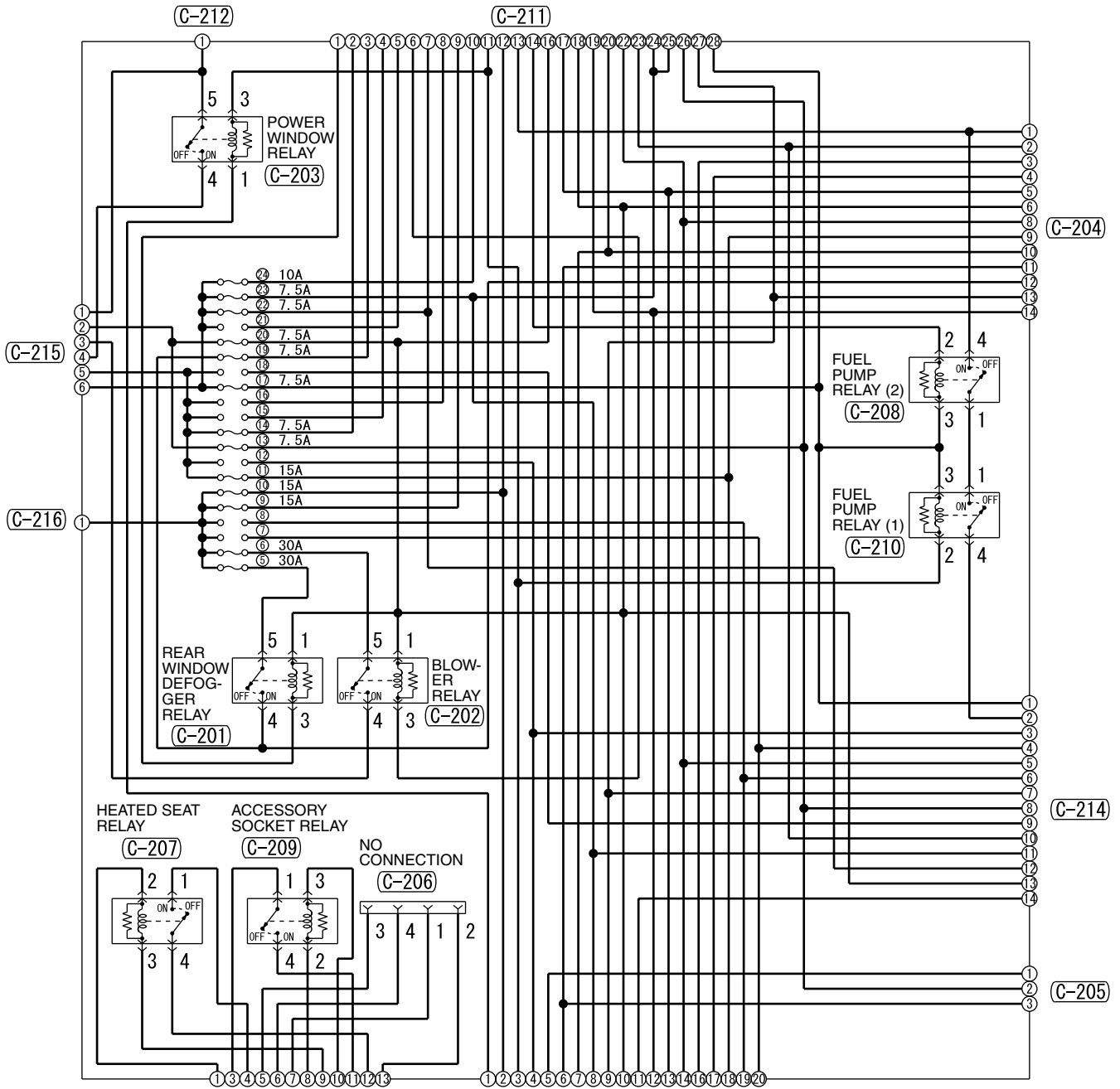

(C-201)

(C-202)

(C-213)

(C-219)

NOTE  
CONNECTOR NUMBERS ARE KEYED TO THE CONFIGURATION  
DIAGRAM (DASH PANEL) AND EACH CIRCUIT DIAGRAM.



(C-205)

(C-206)

(C-207)

(C-208)

(C-209)

(C-210)

(C-211)

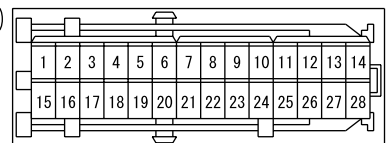

(C-212)

(C-213)

(C-214)

(C-215)

(C-216)

(C-219)

JUNCTION BLOCK SIDE



H5P00M00AA

**FRONT VIEW**

**REAR VIEW**

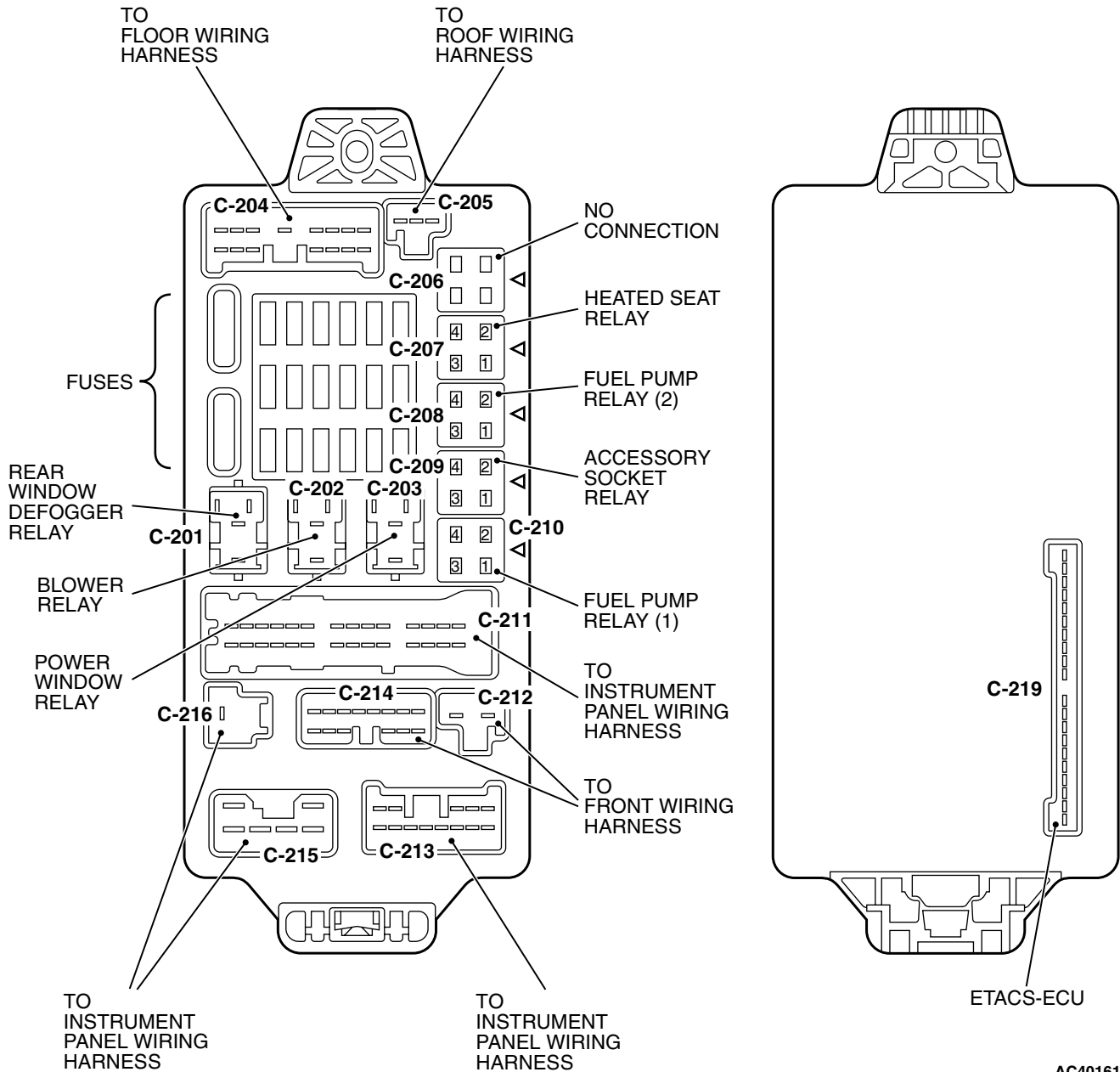

AC401614AB

NOTE: The triangle mark on the relay housing should face that on the junction block.

# JOINT CONNECTOR

M1901014201138

NOTE: IN THE ACTUAL VEHICLES, SOME OF THE JOINT CONNECTOR TERMINALS IN THE SAME BUS ARE USED, SO IN SOME CASES, THE TERMINAL ARRANGEMENT INDICATED ON THE CIRCUIT DIAGRAMS DOSE NOT COINSIDE WITH THE ONES IN THE ACTUAL VEHICLES.  
HOWEVER, ON JOINT CONNECTOR (3), THE ACTUAL TERMINAL AGREEMENT SHOULD ALWAYS AGREE WITH THE CIRCUIT DIAGRAMS.

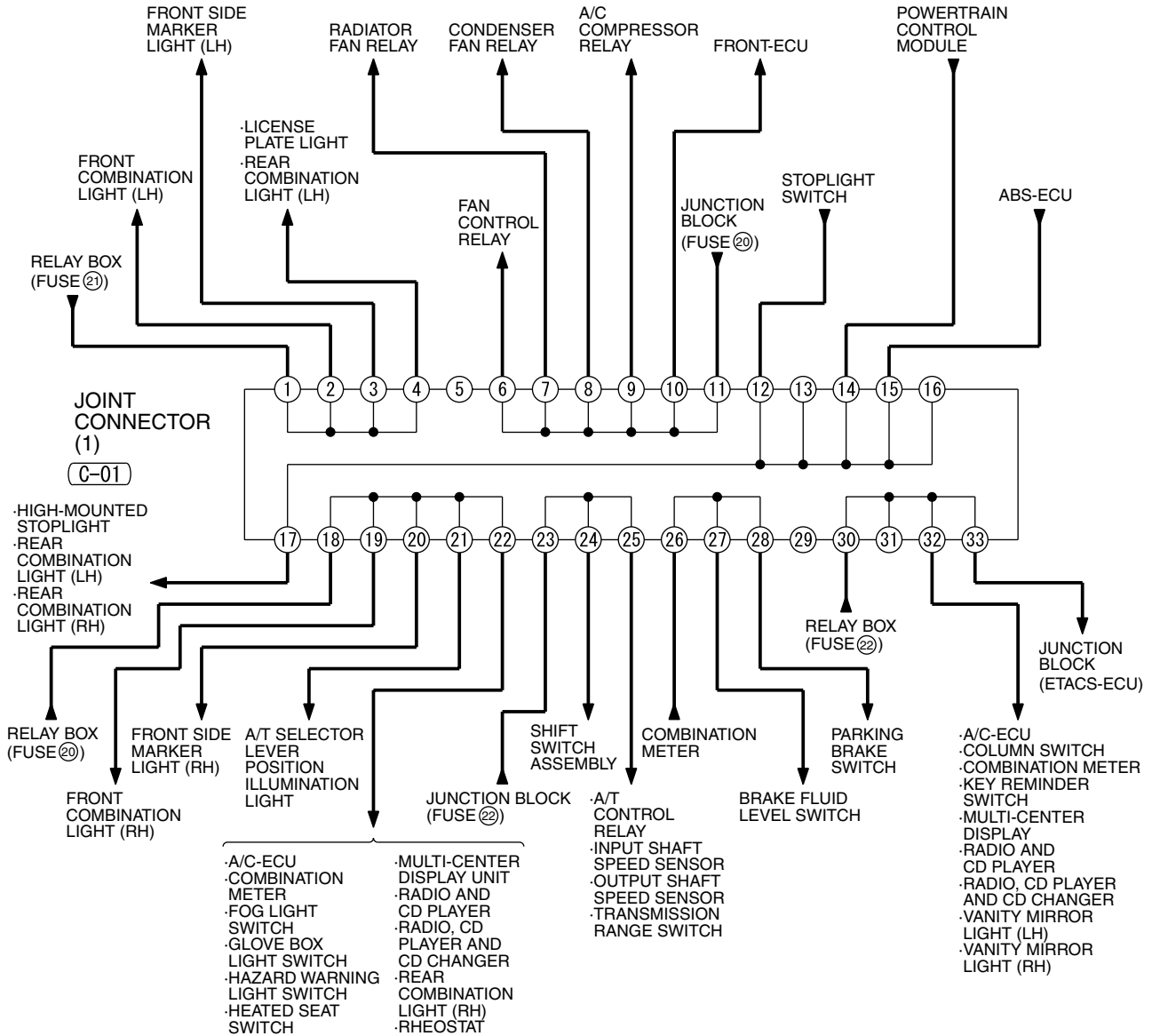

(C-01)

1	2	3	4	5	6	7	8	9	10	11
12	13	14	15	16	17	18	19	20	21	22
23	24	25	26	27	28	29	30	31	32	33

(C-03)

1	2	3	4	5	6	7	8	9	10	11
12	13	14	15	16	17	18	19	20	21	22
23	24	25	26	27	28	29	30	31	32	33

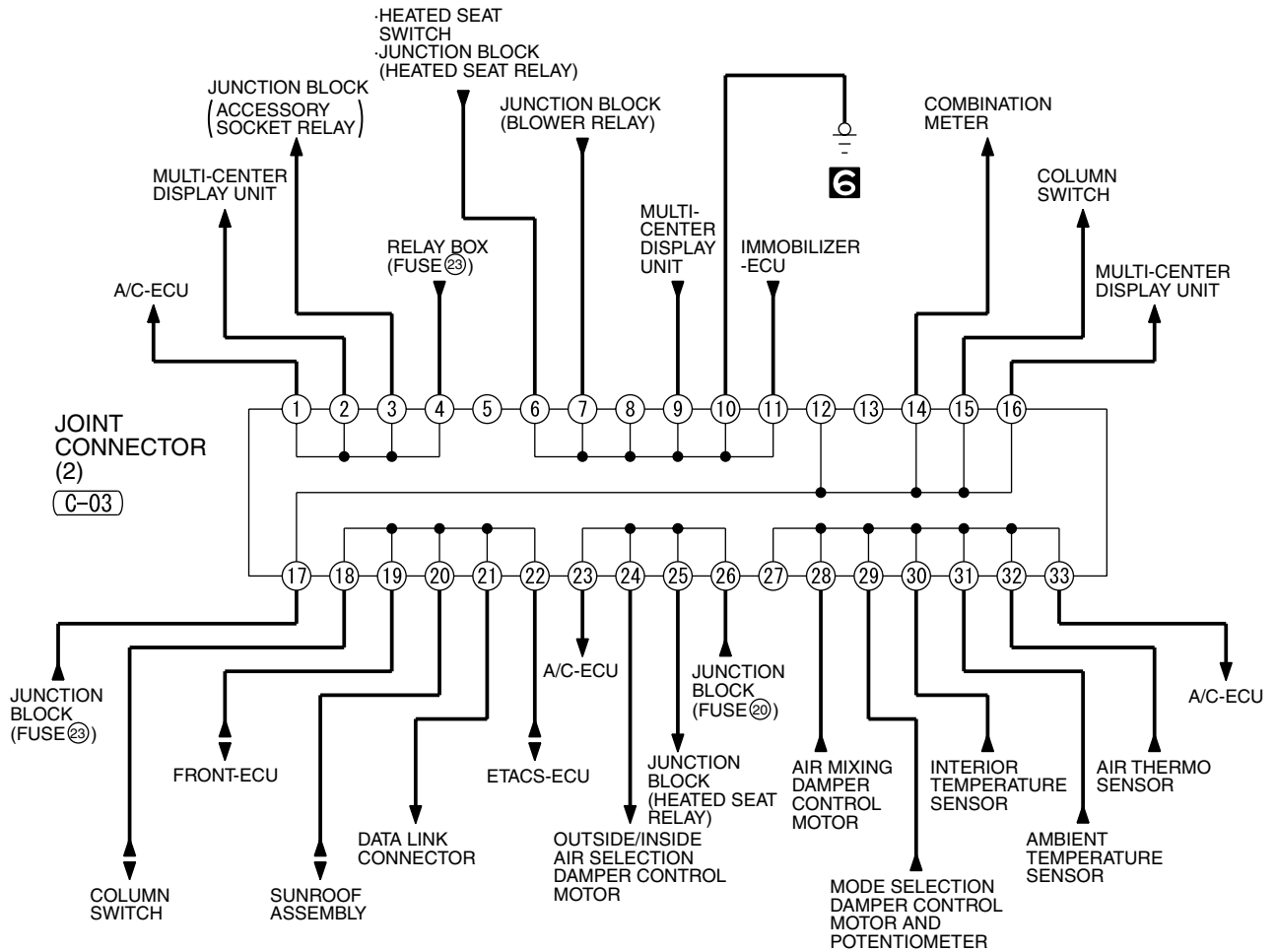

JOINT CONNECTOR (CONTINUED)

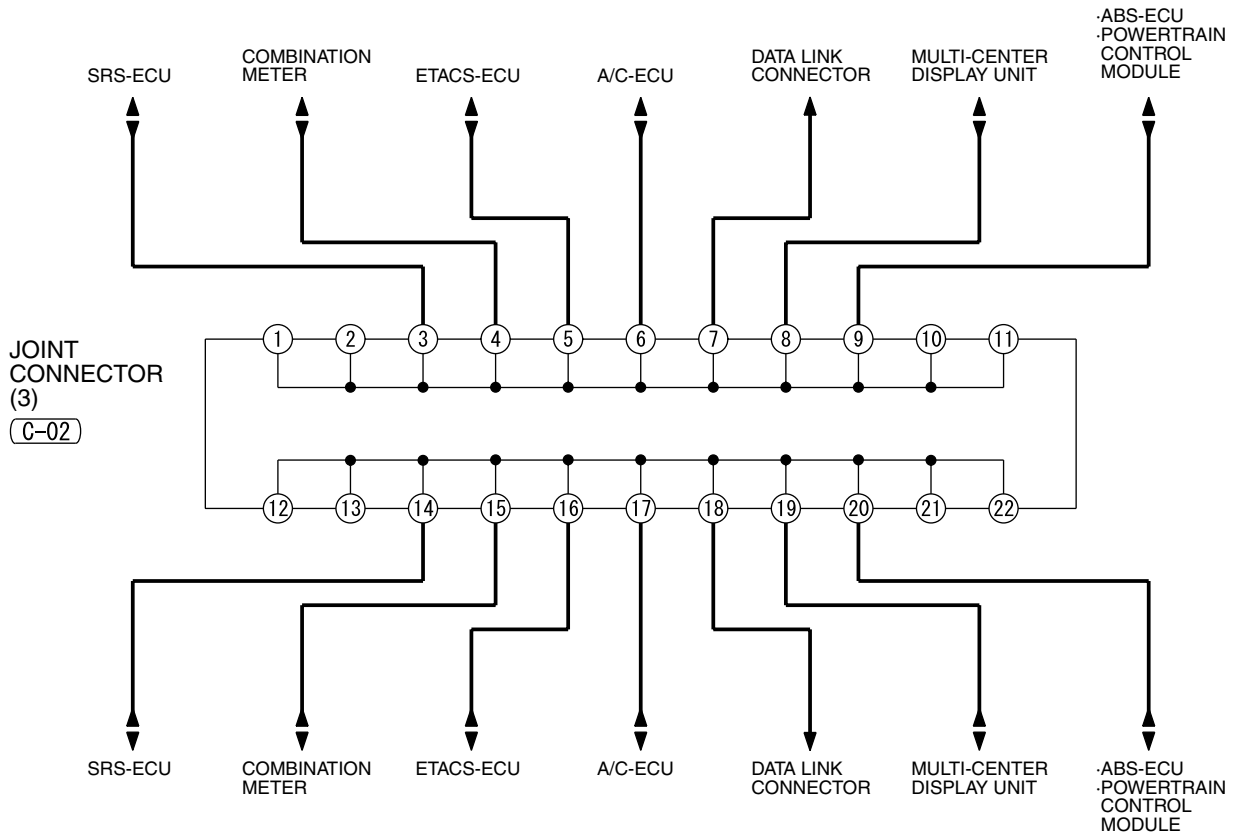

(C-02)

1	2	3	4	5	6	7	8	9	10	11
12	13	14	15	16	17	18	19	20	21	22

**CENTRALIZED JUNCTION**

M1901000301013

**FUSIBLE LINK AND FUSE  
ENGINE COMPARTMENT**

NO.	POWER SUPPLY CIRCUIT	NAME	RATED CAPACITY (A)	HOUSING COLOR	LOAD CIRCUIT
1	Battery/Generator (Fusible link No.27)	Fusible link	80	Black	Fuse Nos.5, 6, 9 and 10 (in junction block) circuit
2			30	Pink	Radiator fan motor
3			60	Yellow	ABS-ECU and ABS/TCL-ECU
4			40	Green	Ignition switch circuit
5			30	Pink	Fuse Nos.3 and 4 (in junction block circuit), front power window regulator motor, power seat assembly, power window main switch and rear power window regulator motor
6		Fuse	15	Blue	Fog light and fog light relay
7			20	Yellow	Heated seat assembly and heated seat switch
8			15	Red	Hom (High), hom (Low) and hom relay
9			20	Yellow	Camshaft position sensor, crankshaft position sensor, engine oil control valve, evaporative emission purge solenoid, evaporative emission ventilation solenoid, exhaust gas recirculation valve, heated oxygen sensor, immobilizer-ECU, injector, mass airflow sensor, MFI relay, powertrain control module and throttle actuator control motor relay
10			10	Red	A/C compressor assembly and A/C-ECU
11			15	Blue	ABS-ECU, ABS/TCL-ECU, high-mounted stoplight, powertrain control module and rear combination light
12			—	—	—
13			7.5	Brown	Generator
14			10	Red	ETACS-ECU
15			20	Yellow	A/T control solenoid valve and powertrain control module
16	Front-ECU (Headlight relay: High)		10	Red	Headlight (RH) and headlight (High: RH)
17			10	Red	Headlight (LH) and headlight (High: LH)
18	Front-ECU (Field effect transistor for headlight: Low)		10	Red	Headlight (RH) and headlight (Low: RH)

NO.	POWER SUPPLY CIRCUIT	NAME	RATED CAPACITY (A)	HOUSING COLOR	LOAD CIRCUIT
19	Front-ECU (Field effect transistor for headlight: Low)	Fuse	10	Red	Headlight (LH) and headlight (Low: LH)
20	Front-ECU (Taillight relay)		7.5	Brown	A/C-ECU, A/T selector lever position illumination light, air bag off indicator light (passenger's side), combination meter, fog light switch, front combination light (RH), front side marker light (RH), glove box light, hazard warning light switch, heated seat switch, multi-center display unit, radio, CD player, CD changer, rear combination light (RH), rheostat, seat belt warning light (passenger's side) and TCL switch
21			7.5	Brown	Front combination light (LH), front side marker light (LH), license plate light and rear combination light (LH)
22			Battery/Generator (Fusible link No.27)	10	Red
23	Ignition switch (ACC)		10	Red	A/C-ECU, accessory socket relay, ETACS-ECU, multi-center display unit, radio, CD player and CD changer
24	Battery/Generator (Fusible link No.27)		15	Blue	Fuel pump module
25	Ignition switch (ACC)		30	Green	Front-ECU and windshield wiper motor
26	Battery/Generator (Fusible link No.27)	Fusible link	20	Light blue	Condenser fan motor
27	Generator		120	–	Battery, front-ECU, fusible link Nos.1, 2, 3, 4, 5 and 26 and fuse Nos.6, 7, 8, 9, 10, 11, 13, 14, 15, 22 and 24 (in relay box)



(RELAY BOX IN ENGINE COMPARTMENT)

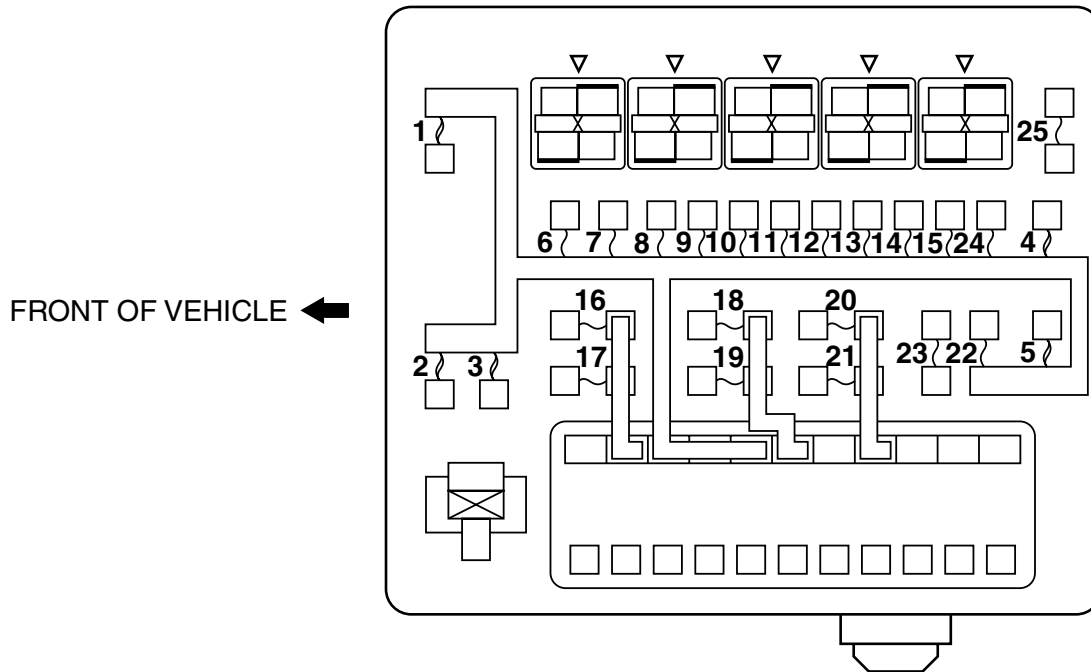

AC208462AB

(RELAY BOX IN ENGINE COMPARTMENT)

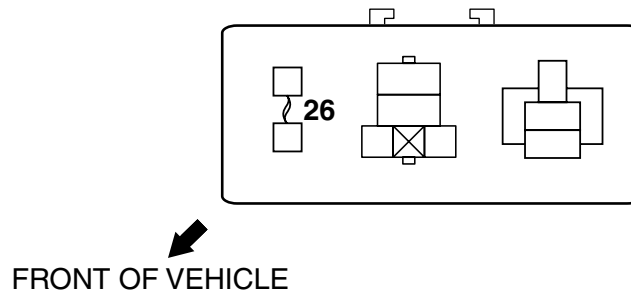

AC303418AB

(CONNECTED DIRECTLY TO BATTERY POSITIVE TERMINAL)

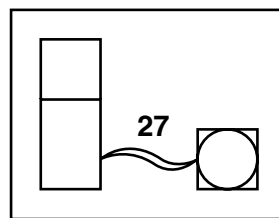

AC207745AG

## PASSENGER COMPARTMENT

NO.	POWER SUPPLY CIRCUIT	NAME	RATED CAPACITY (A)	HOUSING COLOR	LOAD CIRCUIT
1	–	Fuse	–	–	–
2	–		–	–	–
3	Fusible link No.5		20	Yellow	Audio amplifier
4			20	Yellow	Sunroof assembly
5	Fusible link No.1		30	Green	Capacitor and rear window defogger
6			30	Green	Blower motor and resistor
7			–	–	–
8			–	–	–
9			15	Blue	Accessory socket
10			15	Blue	Data link connector and ETACS-ECU
11			Ignition switch (ACC)	15	Blue
12	–			–	–
13	Ignition switch (IG2)		7.5	Brown	Sunroof assembly
14	Ignition switch (ACC)		7.5	Brown	Remote controlled mirror
15			–	–	–
16			–	–	–
17	Ignition switch (IG1)		7.5	Brown	Fuel pump relay and powertrain control module
18	Ignition switch (ACC)		–	–	–
19	Fusible link No.1 (Fuse No.5 in junction block)		7.5	Brown	Remote controlled mirror (mirror heater)
20	Ignition switch (IG2)		7.5	Brown	A/C compressor clutch relay, A/C-ECU, blower relay, condenser fan motor, fan control relay, front-ECU, heated seat relay, outside/inside air selection damper control motor, radiator fan relay and rear window defogger relay
21	Ignition switch (IG1)		–	–	–
22			7.5	Brown	A/T control relay, air bag off indicator light (passenger's side), input shaft speed sensor, occupant classification-ECU, output shaft speed sensor, powertrain control module, rear combination light, seat belt warning light (passenger's side) and SRS-ECU
23			7.5	Brown	ABS-ECU, ABS/TCL-ECU, column switch, combination meter, ETACS-ECU, multi-center display unit and SRS-ECU
24			10	Red	Ignition coil

(IN JUNCTION BLOCK)

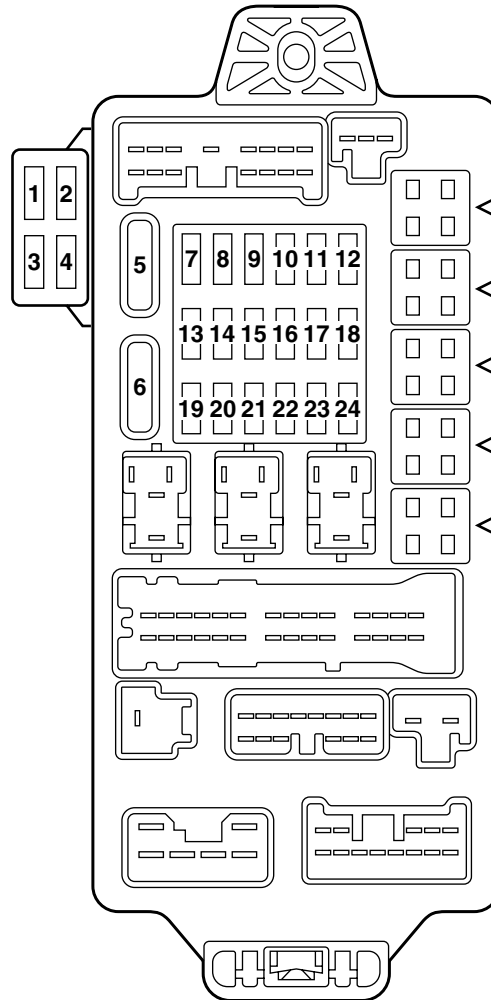

AC401615AB

### CENTRALIZED RELAY

CONNECTOR NO.	NAME	CONNECTOR NO.	NAME
A-05X	Fog light relay	A-16X	Radiator fan relay
A-06X	Hom relay	B-11X	–
A-07X	–	B-12X	–
A-08X	–	B-13X	–
A-09X	–	B-14X	Throttle actuator control motor relay
A-10X	Fan control relay	B-15X	–
A-11X	Front-ECU	B-16X	A/T control relay
A-12X	Front-ECU	B-17X	MFI relay
A-15X	Condenser fan relay	B-18X	A/C compressor clutch relay

(RELAY BOX IN ENGINE COMPARTMENT)

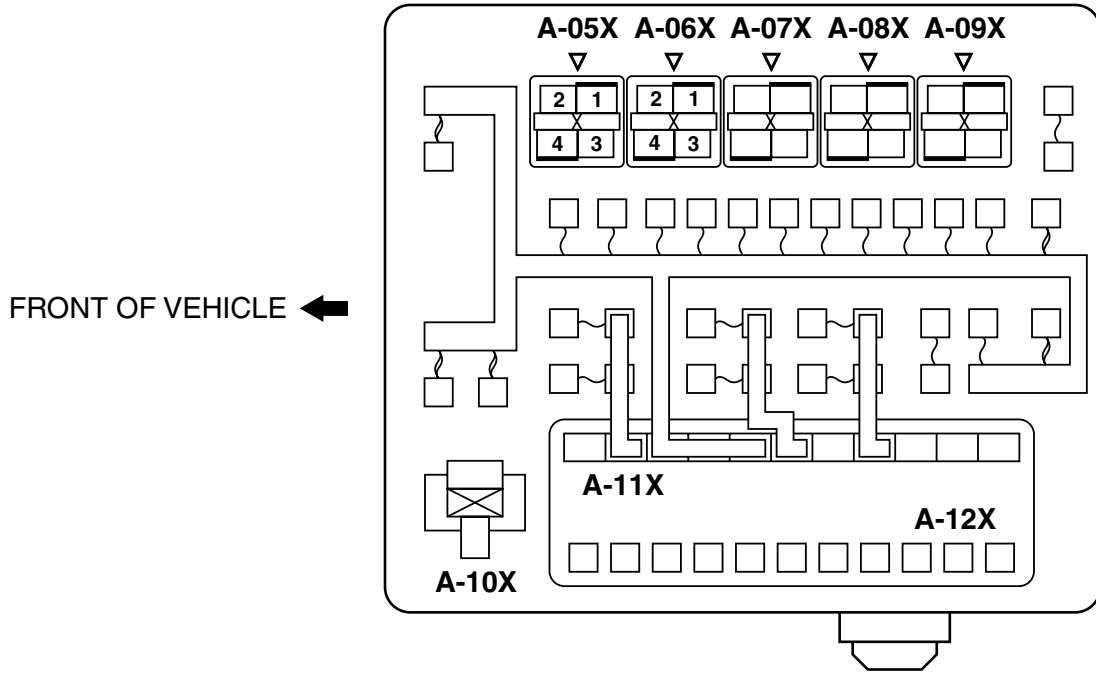

AC208462AC

(RELAY BOX IN ENGINE COMPARTMENT)

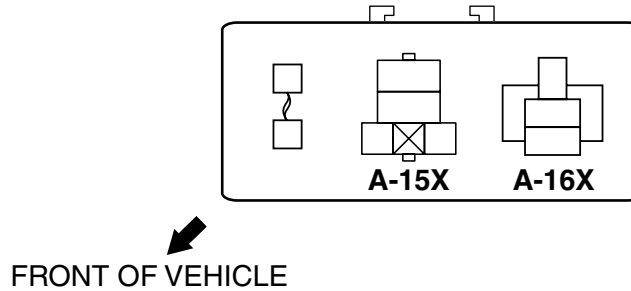

AC303418AC

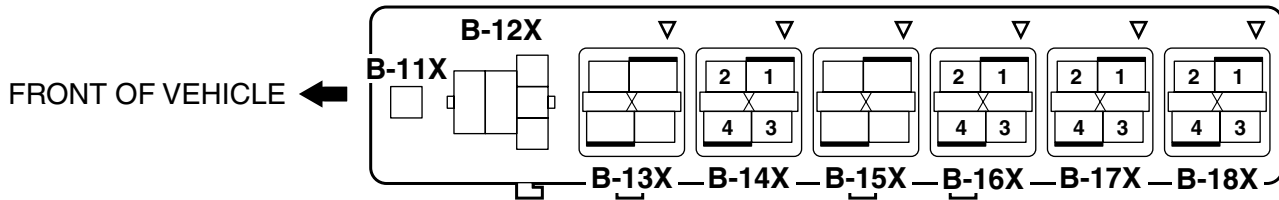

AC208464AL

NOTE: The triangle mark on the relay housing should face that on the relay box.

NOTES

# POWER DISTRIBUTION SYSTEM

M1901000401140

1

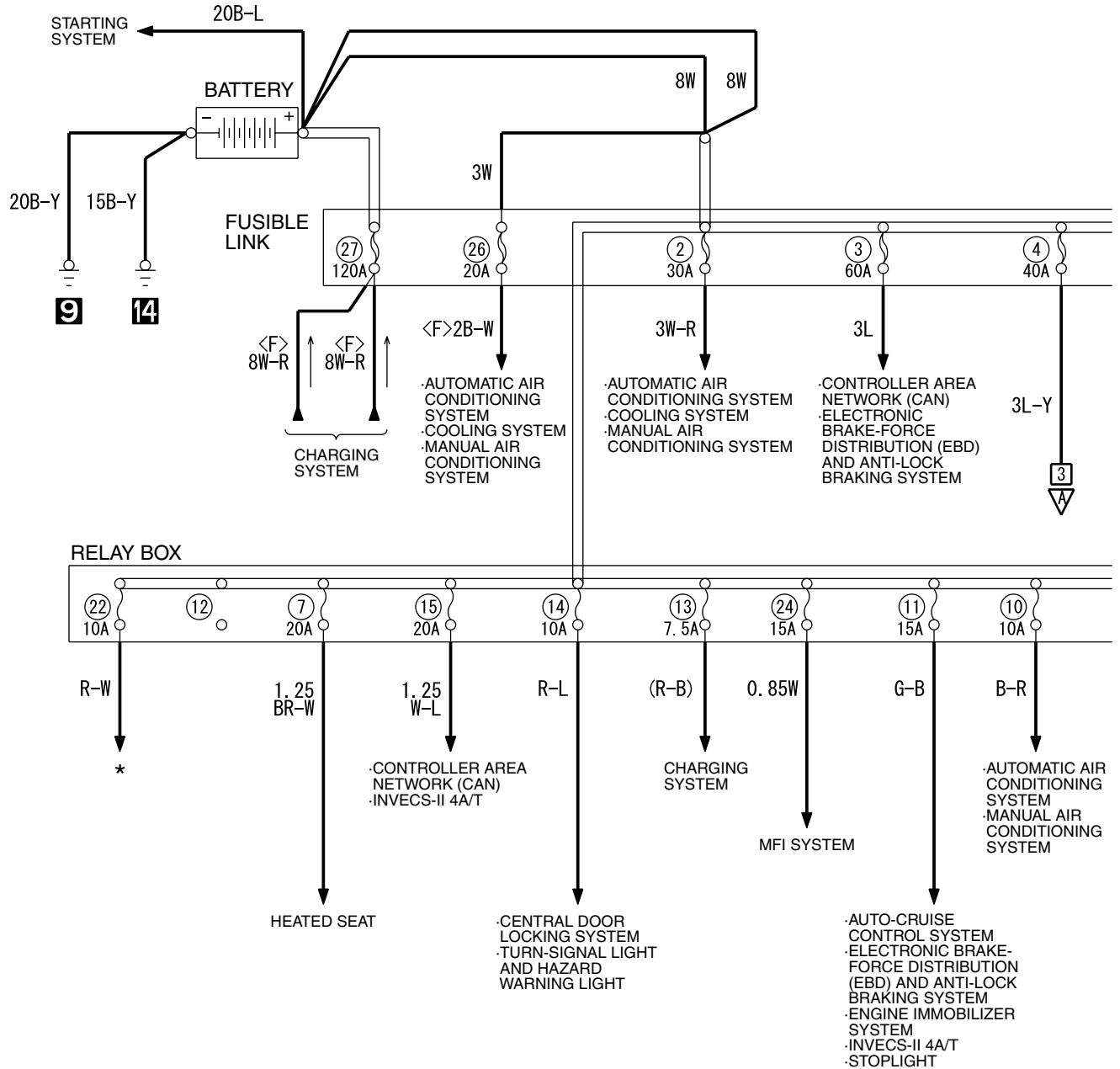

(A-11X)

1 2 3 4 5 6 7 8 9 10 11

H5P01M00AA

TSB Revision

2

**NOTE**

- |   |  |  |  |
|---|--|--|--|
| <ul style="list-style-type: none"> <li>*: .AUDIO SYSTEM</li> <li>.AUTO-CRUISE CONTROL SYSTEM</li> <li>.AUTOMATIC AIR CONDITIONING SYSTEM</li> <li>.BRAKE WARNING LIGHT, OIL PRESSURE WARNING LIGHT, FUEL WARNING LIGHT</li> <li>.CENTRAL DOOR LOCKING SYSTEM</li> <li>.CHARGING SYSTEM</li> <li>.CONTROLLER AREA NETWORK (CAN)</li> </ul> | <ul style="list-style-type: none"> <li>.DOOR AJAR WARNING TONE ALARM</li> <li>.ELECTRONIC BRAKE-FORCE DISTRIBUTION (EBD) AND ANTI-LOCK BRAKING SYSTEM (ABS)</li> <li>.ENGINE IMMOBILIZER SYSTEM</li> <li>.FOG LIGHT</li> <li>.FRONT DOME LIGHT, REAR DOME LIGHT, TRUNK LIGHT AND IGNITION KEY HOLE ILLUMINATION LIGHT</li> <li>.HEADLIGHT</li> </ul> | <ul style="list-style-type: none"> <li>.IGNITION KEY REMINDER TONE ALARM</li> <li>.INVECS-II 4A/T LIGHTING MONITOR TONE ALARM</li> <li>.MANUAL AIR CONDITIONING SYSTEM</li> <li>.METER AND GAUGE</li> <li>.MFI SYSTEM</li> <li>.MULTI-CENTER DISPLAY</li> <li>.POWER WINDOWS</li> <li>.SEAT BELT WARNING TONE ALARM</li> <li>.SUNROOF</li> </ul> | <ul style="list-style-type: none"> <li>.SUPPLEMENTAL RESTRAINT SYSTEM (SRS)</li> <li>.TAILLIGHT, POSITION LIGHT, FRONT SIDE MARKER LIGHT AND LICENSE PLATE LIGHT</li> <li>.TURN-SIGNAL LIGHT AND HAZARD WARNING LIGHT</li> <li>.VANITY MIRROR LIGHT</li> <li>.WINDSHIELD WIPER AND WASHER</li> </ul> |
|---|--|--|--|

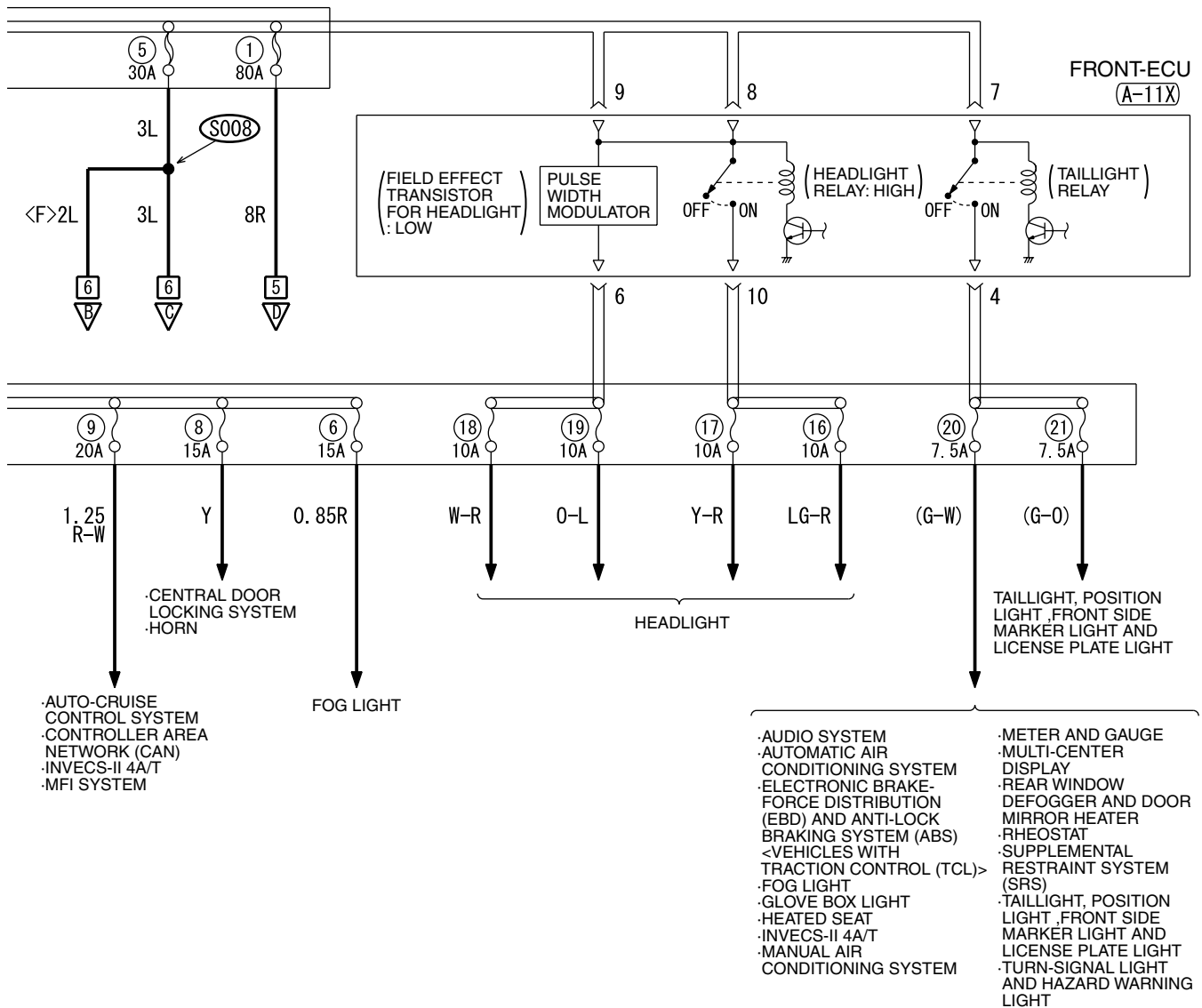

**WIRE COLOR CODE**

B : BLACK    LG : LIGHT GREEN    G : GREEN    L : BLUE    W : WHITE    Y : YELLOW  
 SB : SKY BLUE    BR : BROWN    O : ORANGE    GR : GRAY    R : RED    P : PINK    V : VIOLET

POWER DISTRIBUTION SYSTEM (CONTINUED)

3

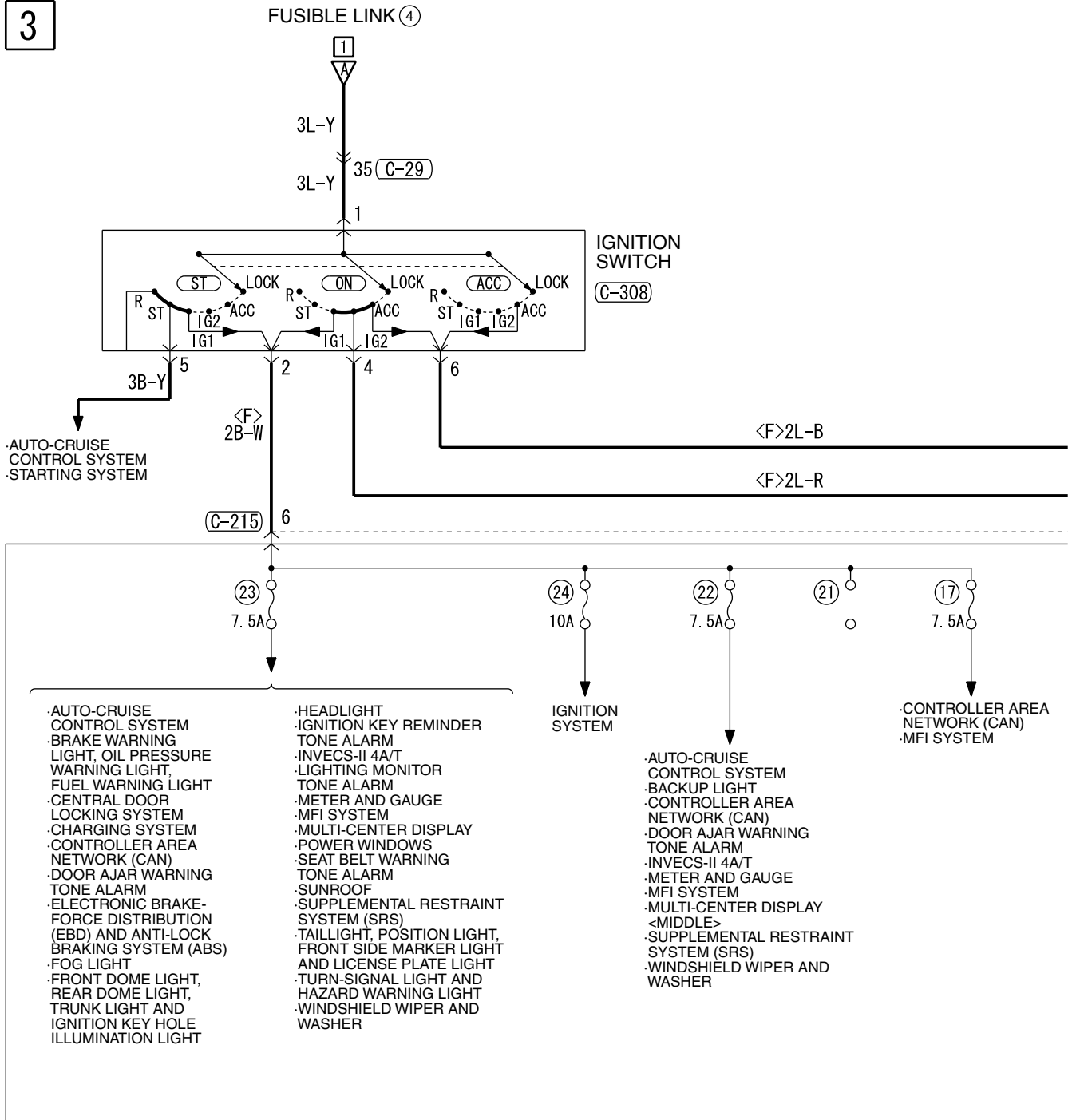

(C-29)

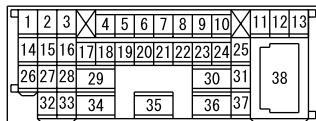

(C-215)



(C-308)





4

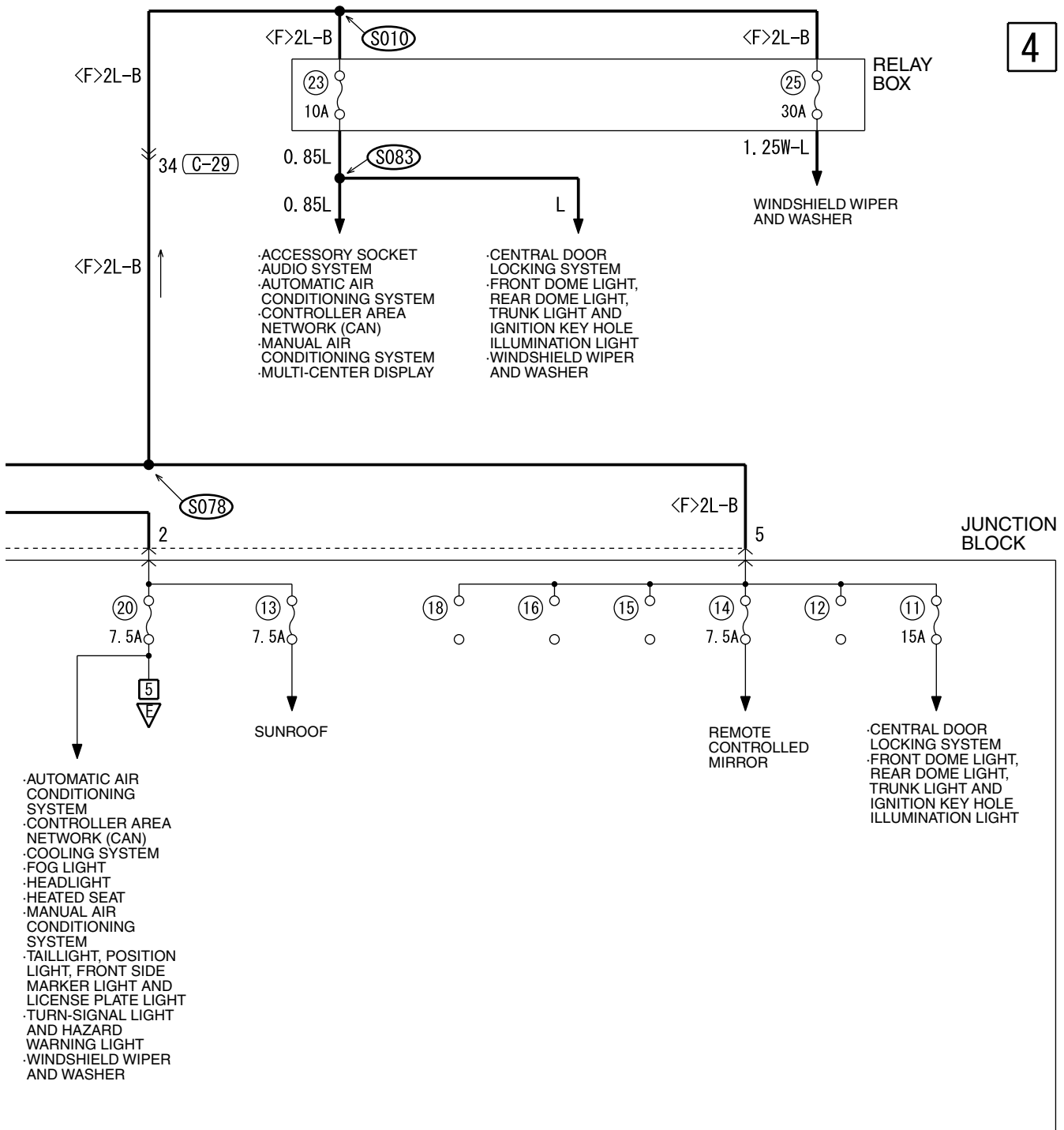

WIRE COLOR CODE  
 B : BLACK LG : LIGHT GREEN G : GREEN L : BLUE W : WHITE Y : YELLOW  
 SB : SKY BLUE BR : BROWN O : ORANGE GR : GRAY R : RED P : PINK V : VIOLET

H5P01M00BB

TSB Revision

POWER DISTRIBUTION SYSTEM (CONTINUED)

5

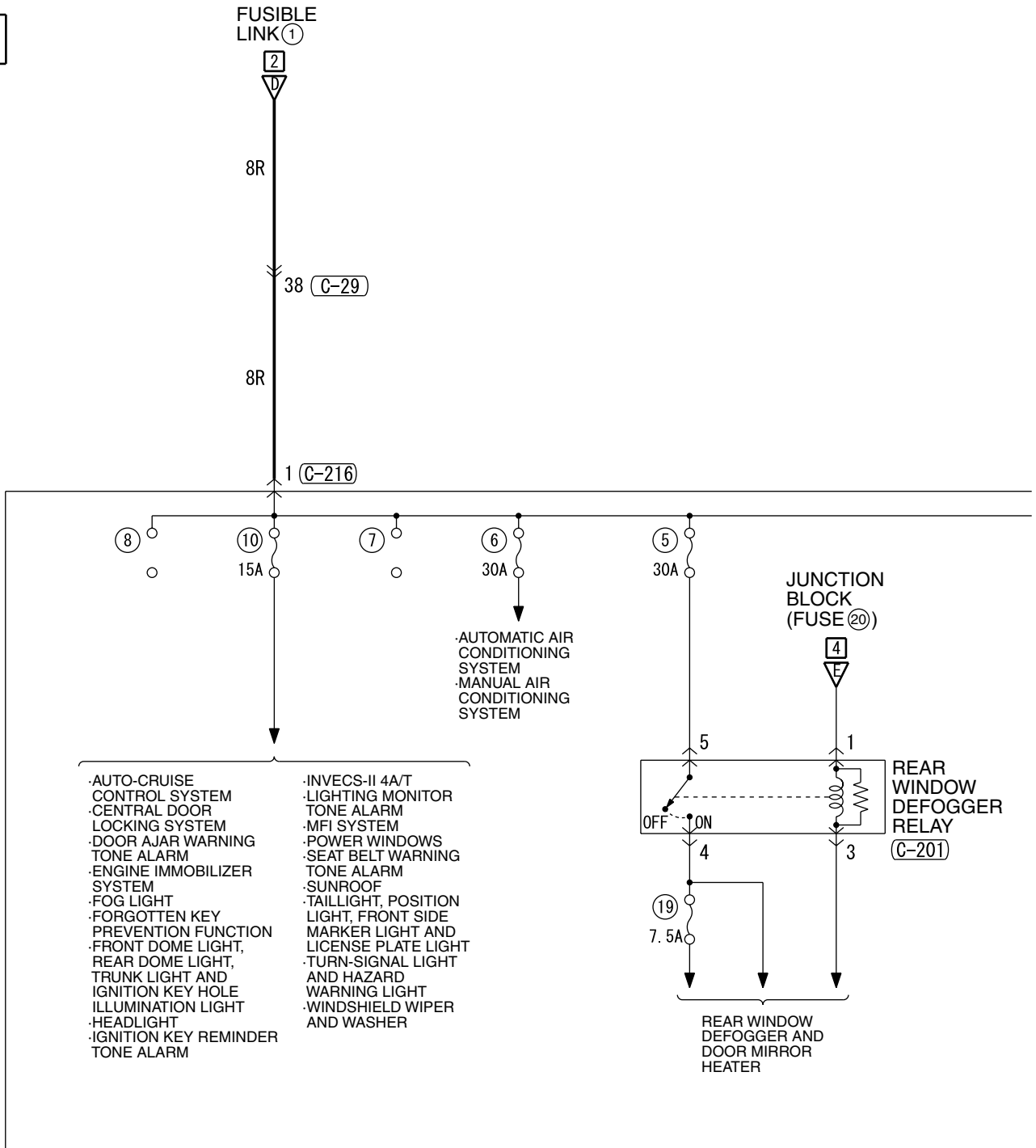

(C-29)

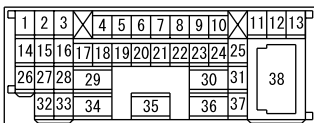

(C-201)



(C-203)



(C-209)



(C-211)

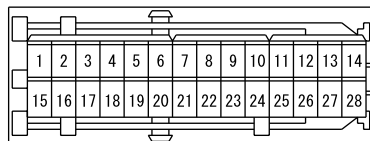

(C-212)



(C-213)

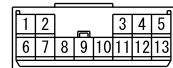

6

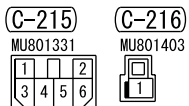
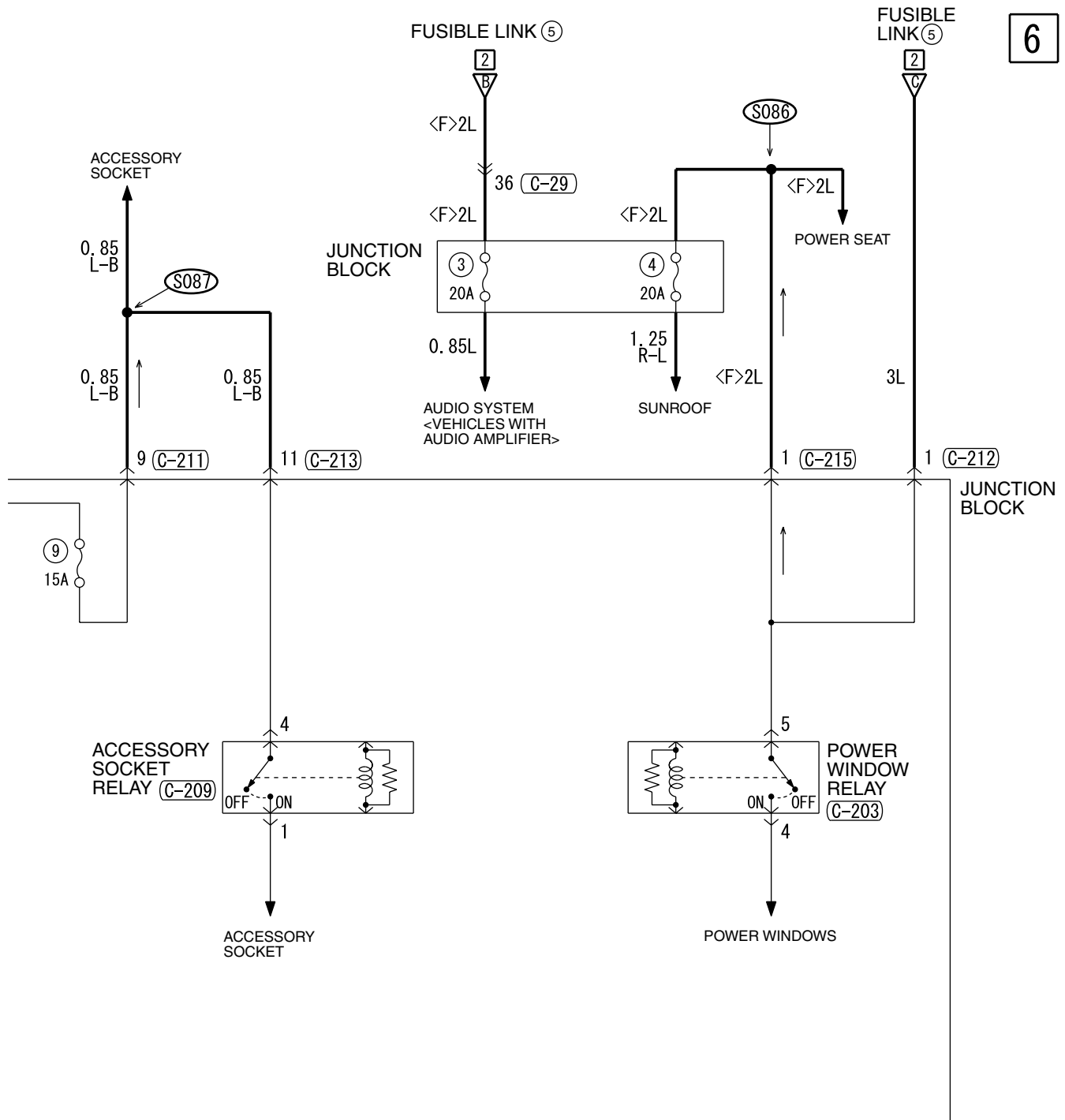

WIRE COLOR CODE  
 B : BLACK LG : LIGHT GREEN G : GREEN L : BLUE  
 BR : BROWN O : ORANGE GR : GRAY R : RED W : WHITE  
 SB : SKY BLUE P : PINK Y : YELLOW V : VIOLET

# STARTING SYSTEM

M1901000501352

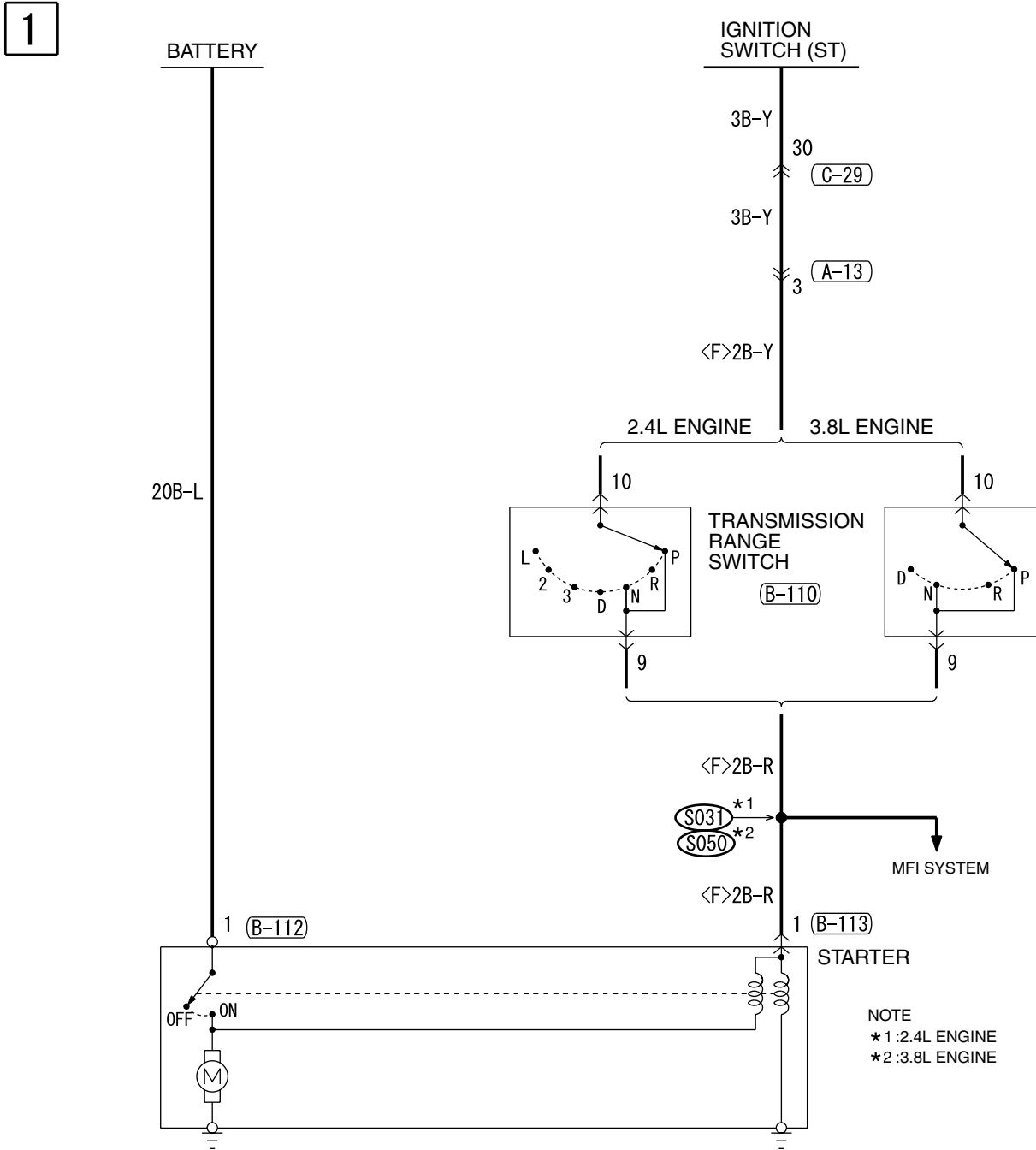

NOTE  
\* 1 : 2.4L ENGINE  
\* 2 : 3.8L ENGINE

(A-13)

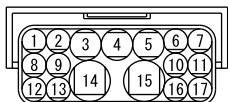

(B-110)

MU802355

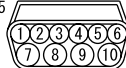

(B-112)

①

(B-113)

(MU801211)



(C-29)

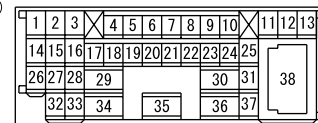

WIRE COLOR CODE

B : BLACK LG : LIGHT GREEN G : GREEN L : BLUE W : WHITE Y : YELLOW  
SB : SKY BLUE BR : BROWN O : ORANGE GR : GRAY R : RED P : PINK V : VIOLET

H5P02M00AA

---

NOTES

IGNITION SYSTEM <2.4L ENGINE>

M1901000601917

1

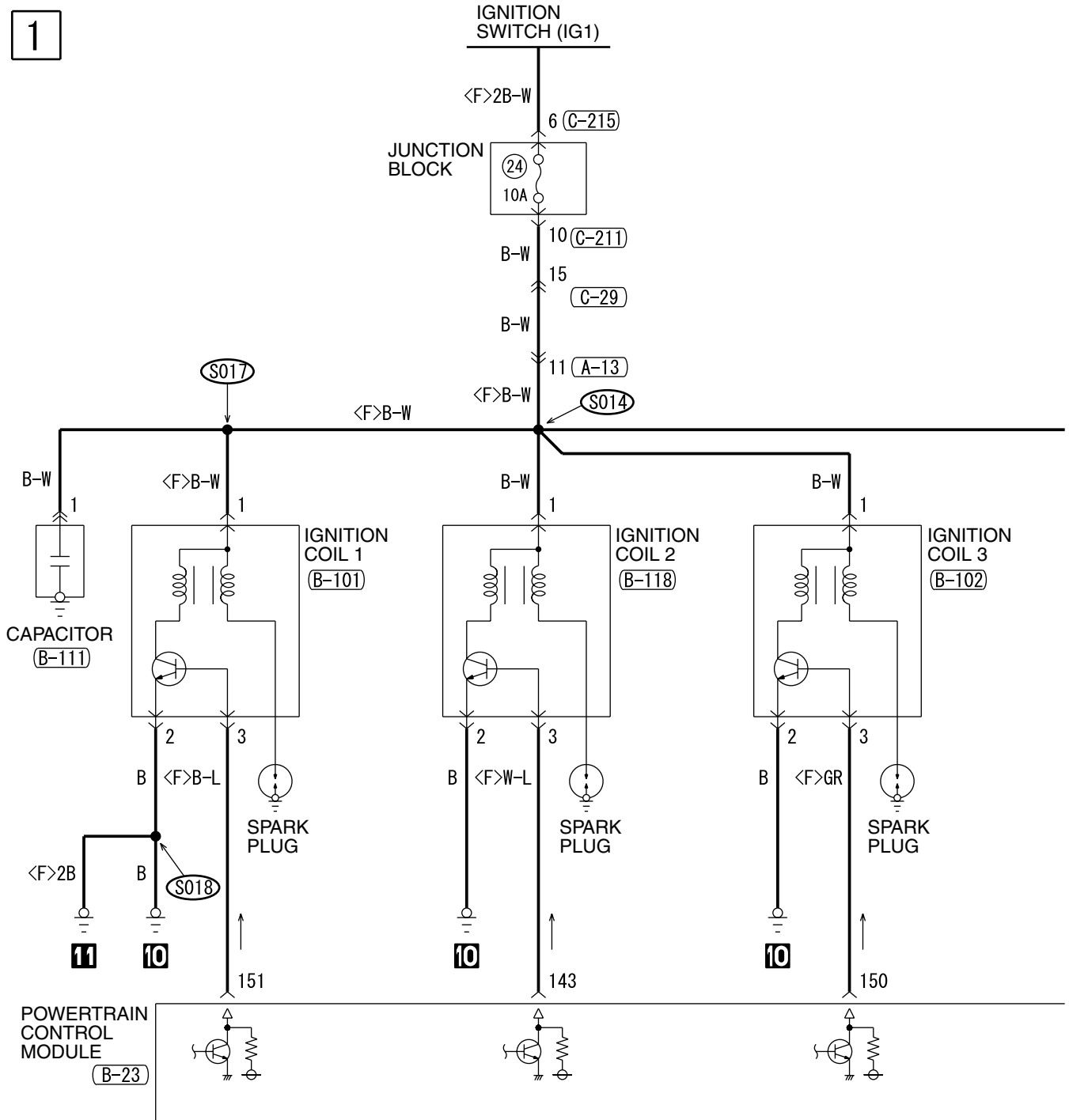

(A-13)

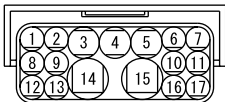

(B-23)

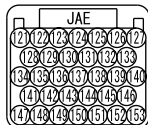

(B-101)



(B-102)



(B-117)



(B-118)



(C-29)

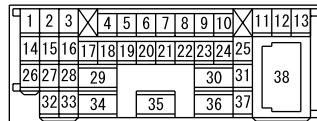

H5P03M00AA

2

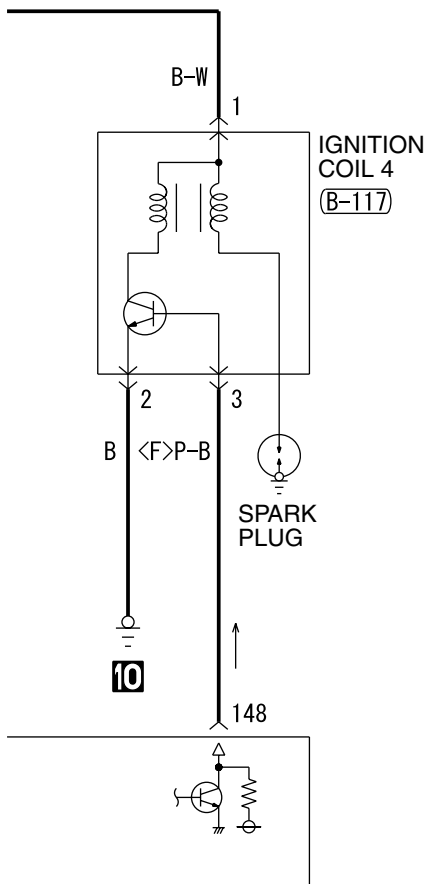

POWERTRAIN CONTROL MODULE INPUT SIGNAL	
·ACCELERATOR PEDAL POSITION SENSOR	·IGNITION SWITCH (ST)
·CAMSHAFT POSITION SENSOR	·INTAKE AIR TEMPERATURE SENSOR
·CRANKSHAFT POSITION SENSOR	·KNOCK SENSOR
·ENGINE COOLANT TEMPERATURE SENSOR	·MANIFOLD ABSOLUTE PRESSURE SENSOR
·FUEL TANK DIFFERENTIAL PRESSURE SENSOR	·MASS AIRFLOW SENSOR
·HEATED OXYGEN SENSOR	·TRANSMISSION RANGE SWITCH
	·THROTTLE POSITION SENSOR
	·OUTPUT SHAFT SPEED SENSOR

(C-211)

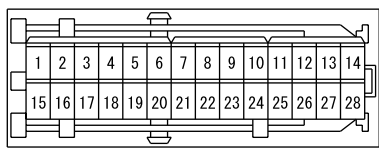

(C-215)



WIRE COLOR CODE  
 B : BLACK LG : LIGHT GREEN G : GREEN L : BLUE  
 BR : BROWN O : ORANGE GR : GRAY R : RED W : WHITE  
 SB : SKY BLUE P : PINK Y : YELLOW V : VIOLET

**IGNITION SYSTEM <3.8L ENGINE>**

M1901000601928

1

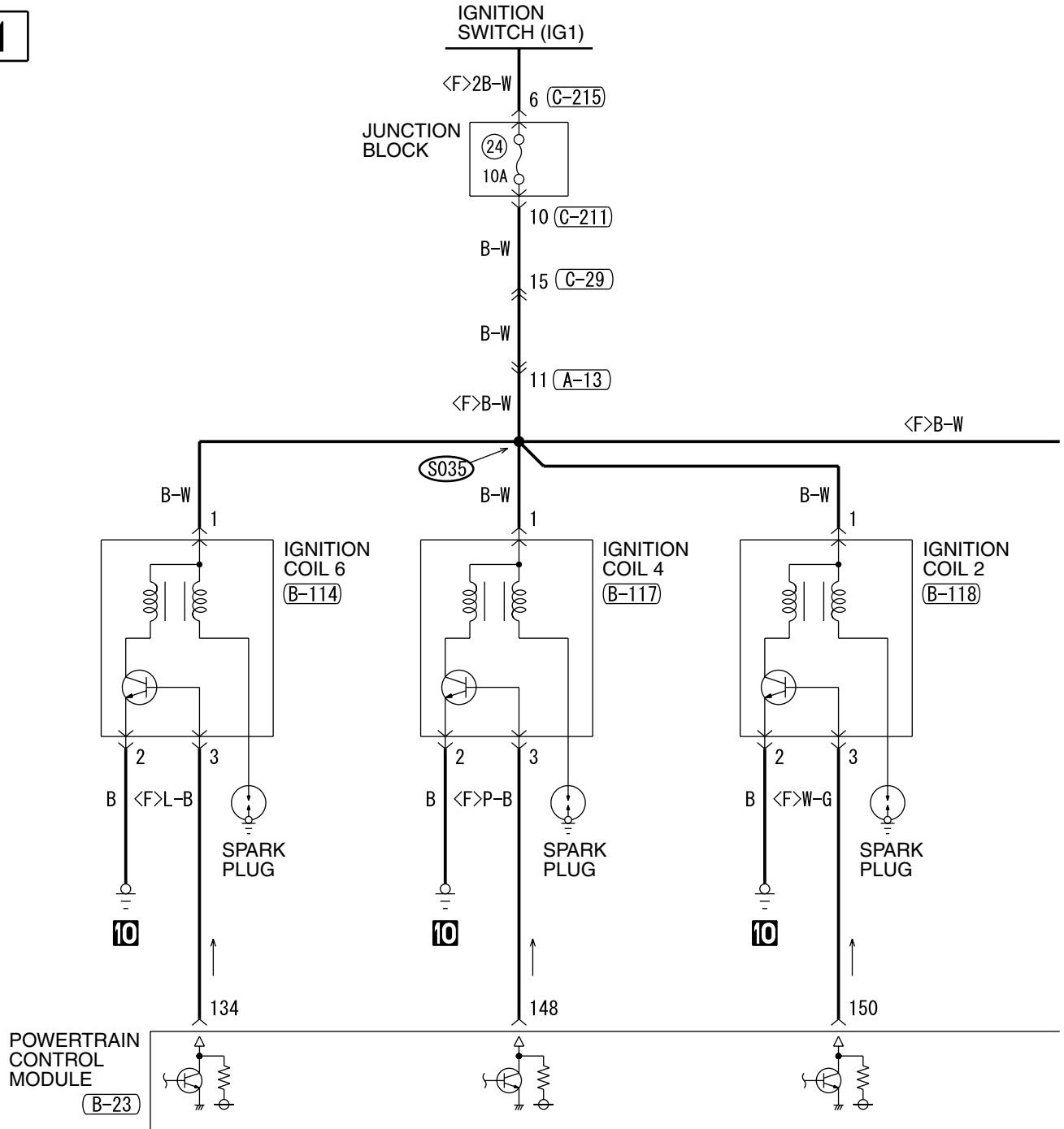

(A-13)

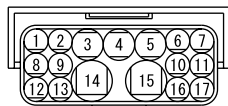

(B-23)



(B-32)

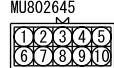

(B-101)



(B-102)



(B-103)



(B-114)



(B-117)



(B-118)





2

POWERTRAIN CONTROL MODULE INPUT SIGNAL	
·ACCELERATOR PEDAL POSITION SENSOR	·IGNITION SWITCH (ST)
·CAMSHAFT POSITION SENSOR	·INTAKE AIR TEMPERATURE SENSOR
·CRANKSHAFT POSITION SENSOR	·KNOCK SENSOR
·ENGINE COOLANT TEMPERATURE SENSOR	·MANIFOLD ABSOLUTE PRESSURE SENSOR
·FUEL TANK DIFFERENTIAL PRESSURE SENSOR	·MASS AIRFLOW SENSOR
·HEATED OXYGEN SENSOR	·TRANSMISSION RANGE SWITCH
	·THROTTLE POSITION SENSOR
	·OUTPUT SHAFT SPEED SENSOR

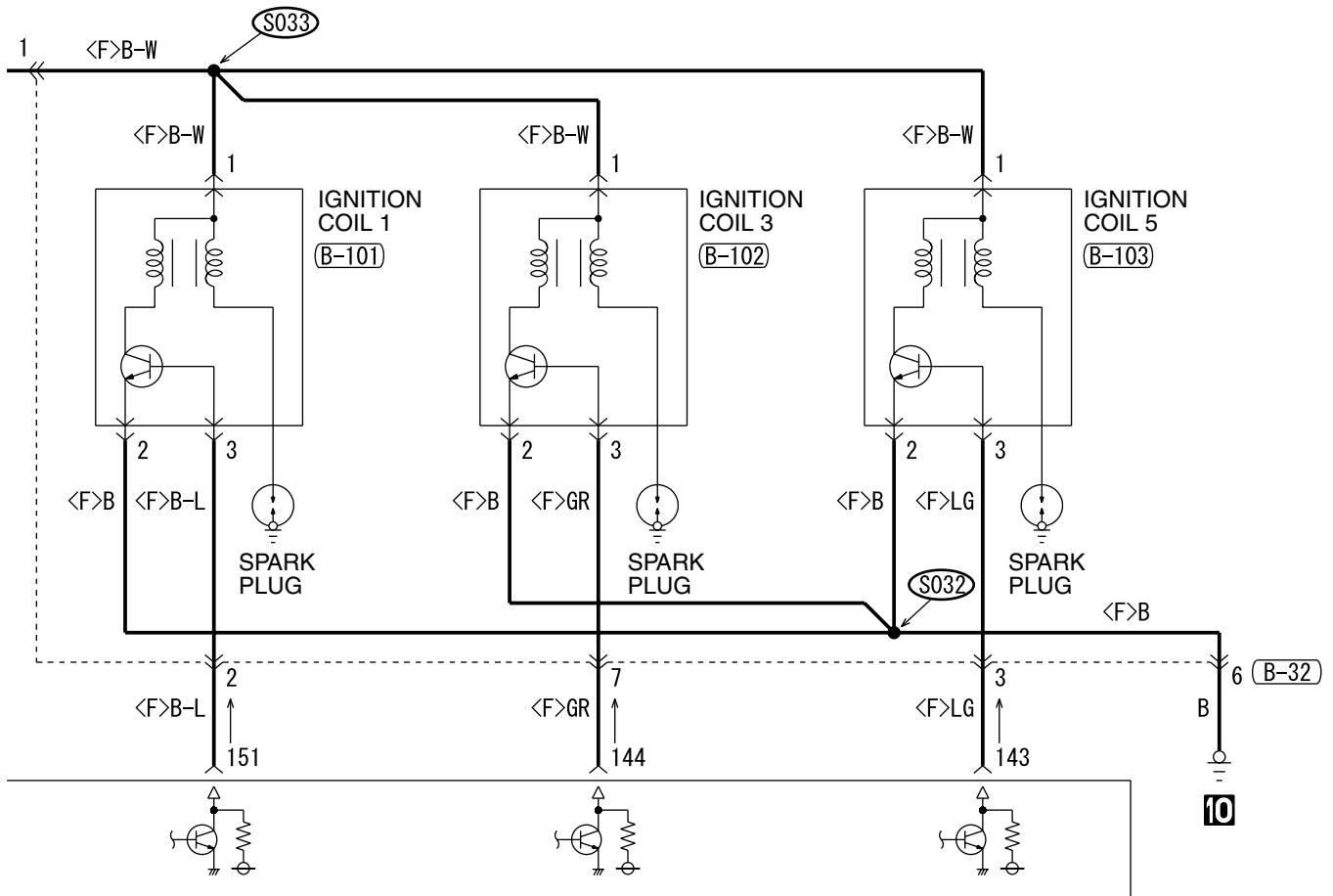

(C-29)

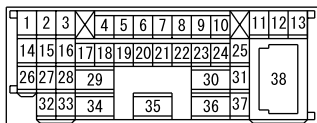

(C-211)

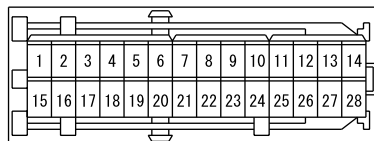

(C-215)



WIRE COLOR CODE  
 B : BLACK SB : SKY BLUE  
 BR : BROWN LG : LIGHT GREEN  
 G : GREEN P : PINK GR : GRAY  
 R : RED L : BLUE Y : YELLOW  
 V : VIOLET W : WHITE O : ORANGE

H5P03M01AB

TSB Revision

# CHARGING SYSTEM

1

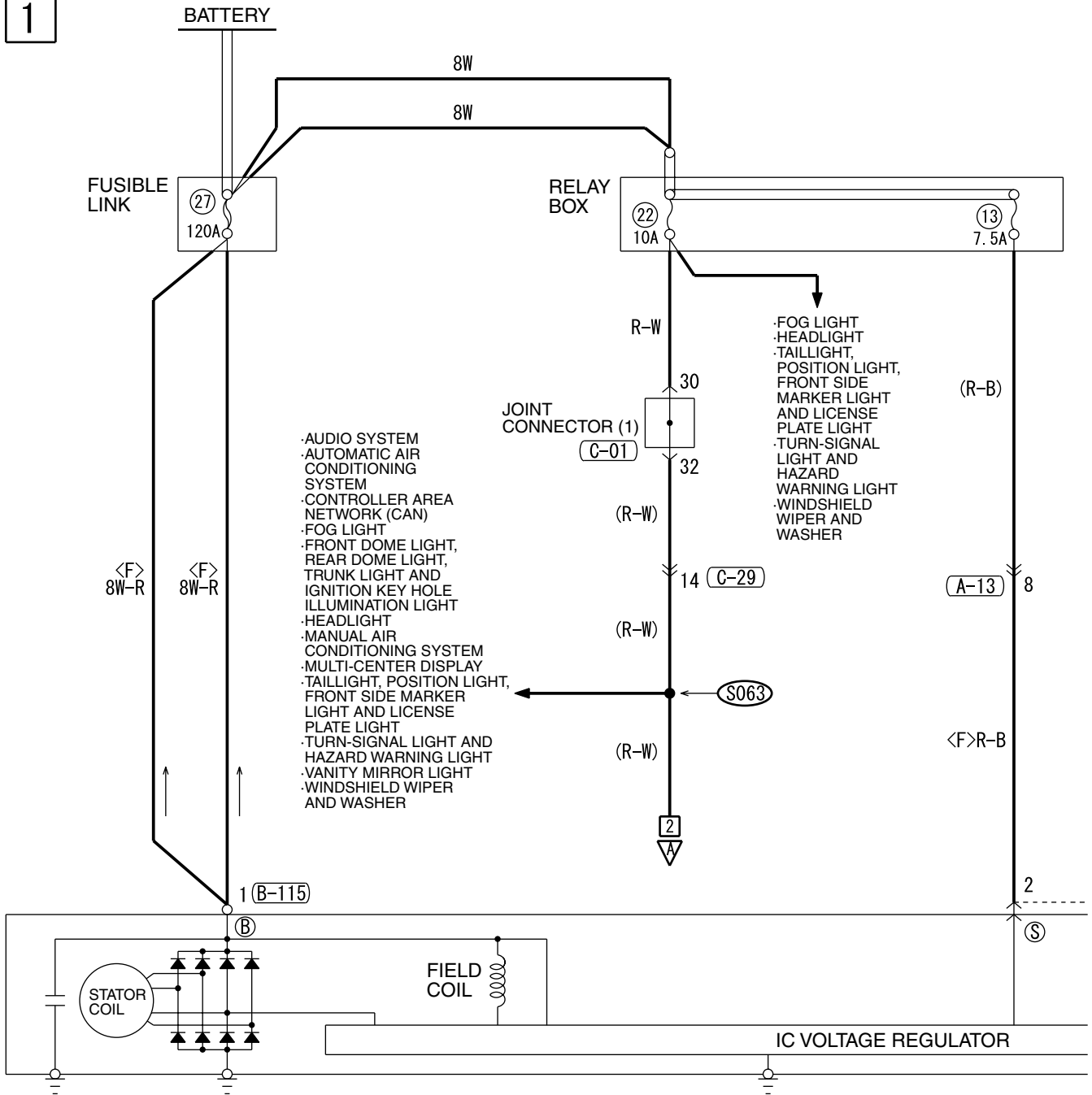

(A-13)

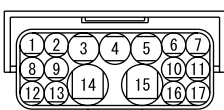

(B-23)

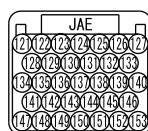

(B-115)

(1)

(B-116)

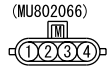

(C-01)



(C-03)

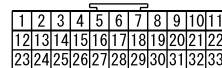

2

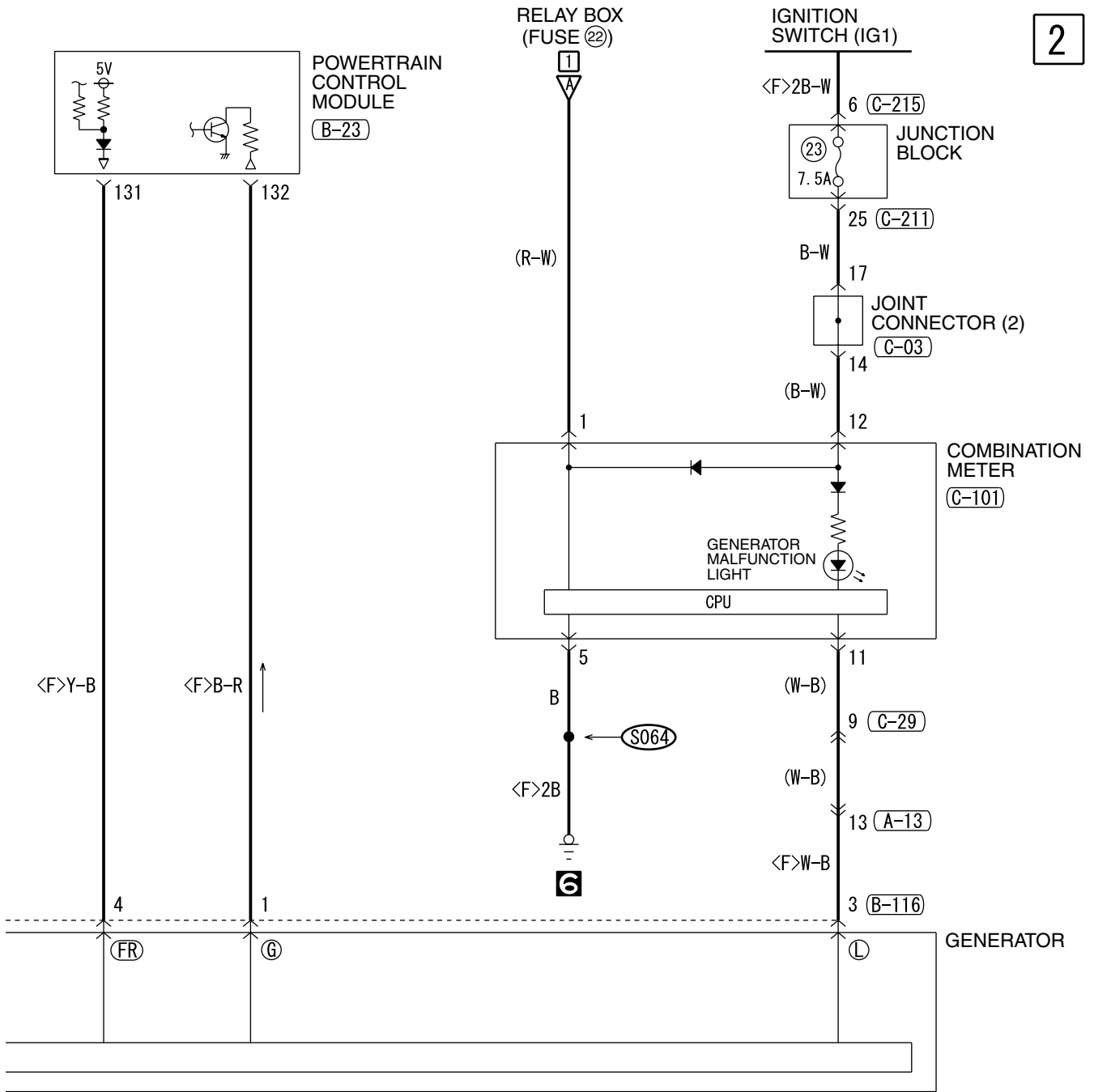

(C-29)

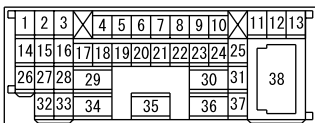

(C-101)

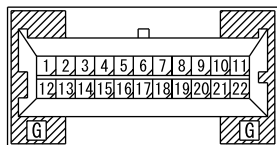

(C-211)

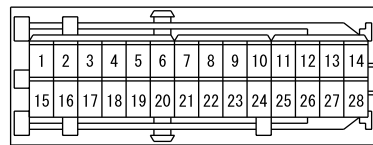

(C-215)



# MULTIPOINT FUEL INJECTION (MFI) SYSTEM <2.4L ENGINE>

M1901000802389

1

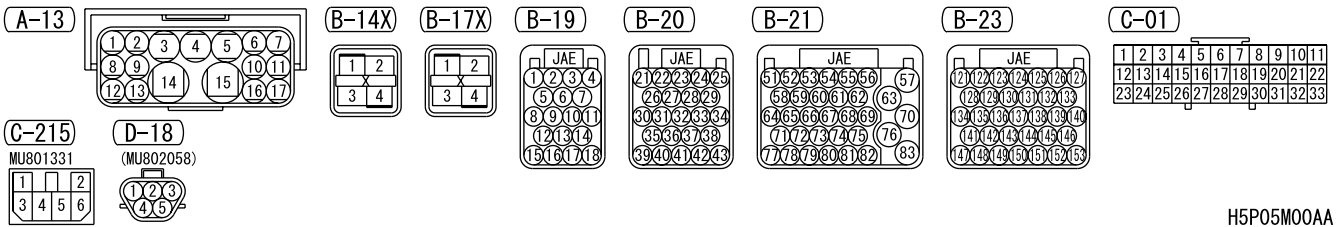
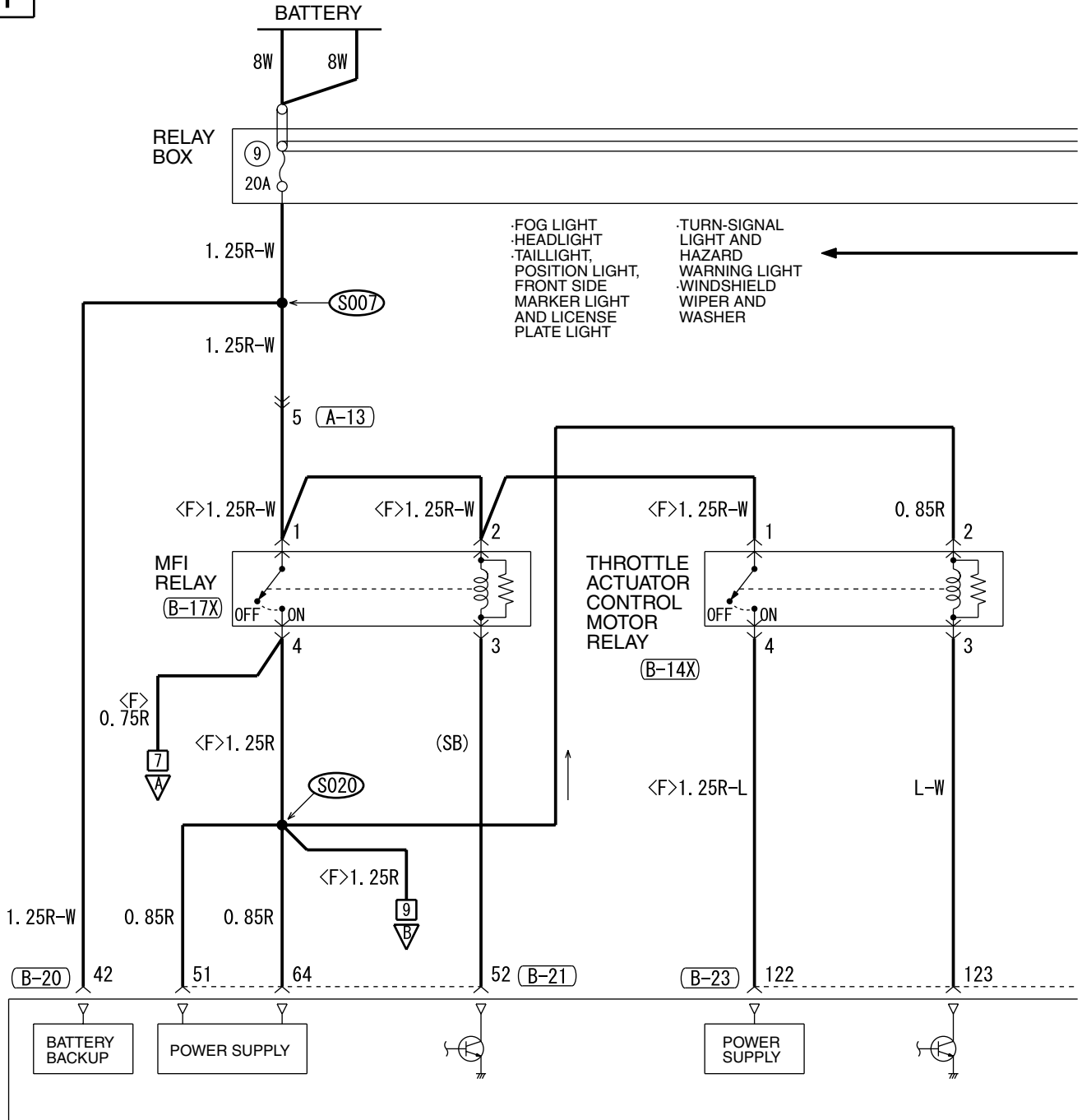

H5P05M00AA

TSB Revision

2

NOTE

- \* : ·AUDIO SYSTEM
- AUTOMATIC AIR CONDITIONING SYSTEM
- CONTROLLER AREA NETWORK (CAN)
- FOG LIGHT
- FRONT DOME LIGHT, REAR DOME LIGHT, TRUNK LIGHT AND IGNITION KEY HOLE ILLUMINATION LIGHT
- HEADLIGHT
- MANUAL AIR CONDITIONING SYSTEM
- MULTI-CENTER DISPLAY
- TAILLIGHT, POSITION LIGHT, FRONT SIDE MARKER LIGHT AND LICENSE PLATE LIGHT
- TURN-SIGNAL LIGHT AND HAZARD WARNING LIGHT
- VANITY MIRROR LIGHT
- WINDSHIELD WIPER AND WASHER

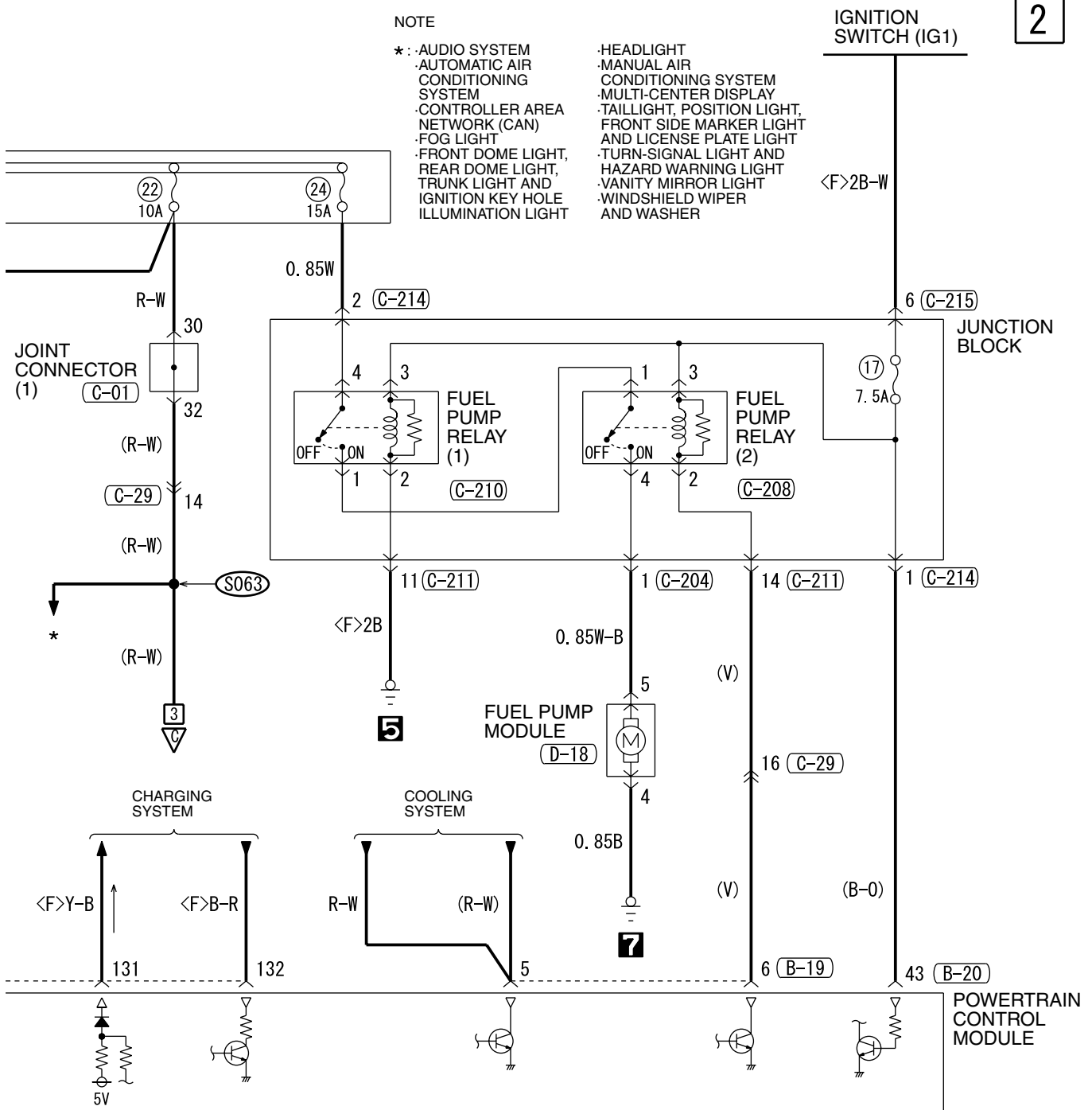

(C-29)

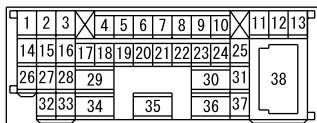

(C-204)

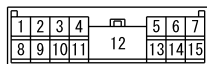

(C-208)



(C-210)



(C-211)

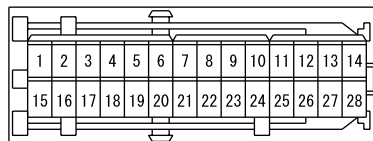

(C-214)

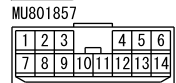



**4**

**NOTE**

- \*1 : WITHOUT ELECTRONIC BRAKE-FORCE DISTRIBUTION (EBD) AND ANTI-LOCK BRAKING SYSTEM (ABS)
- \*2 : WITH ELECTRONIC BRAKE-FORCE DISTRIBUTION (EBD) AND ANTI-LOCK BRAKING SYSTEM (ABS)

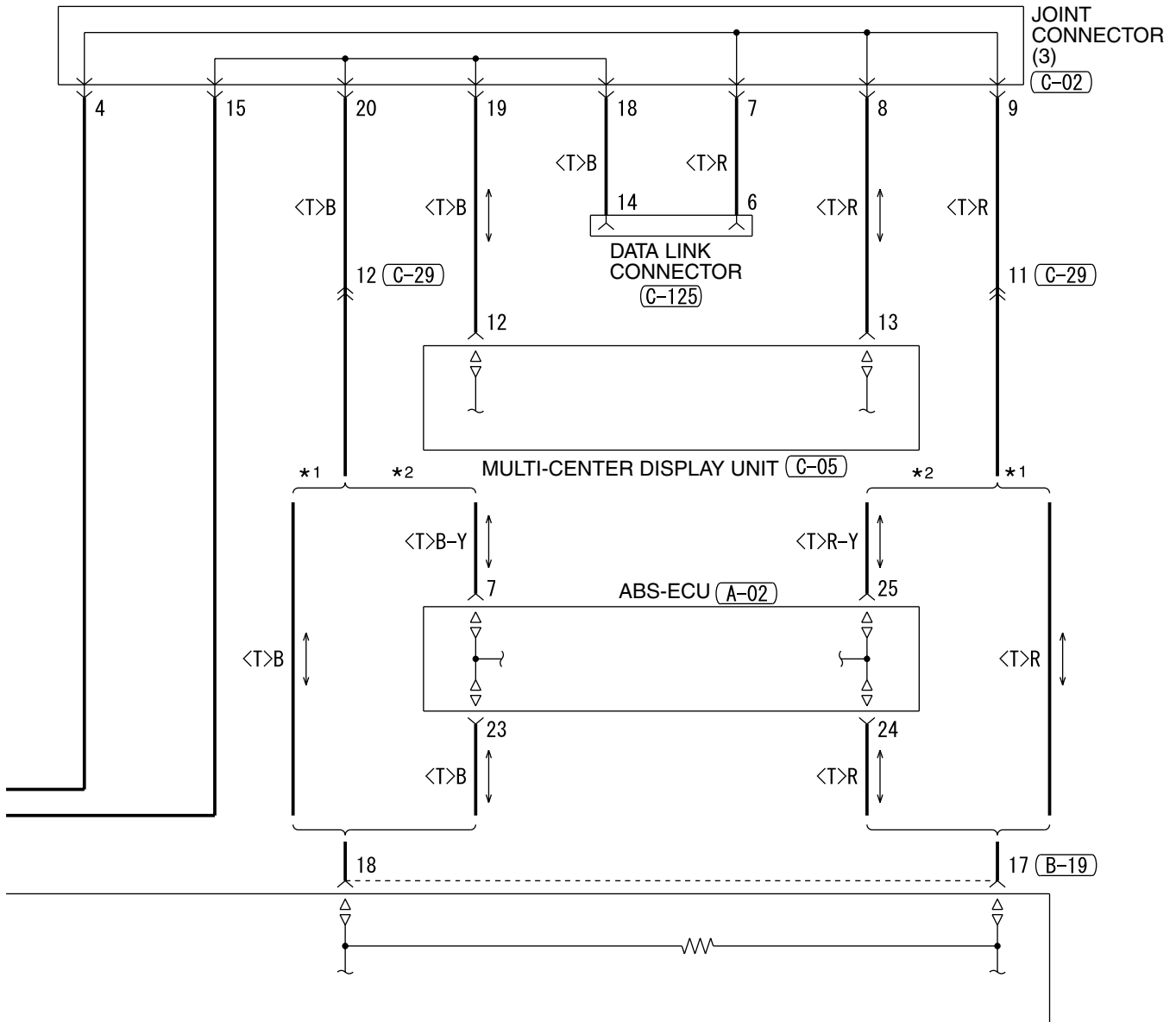

**(C-01)**

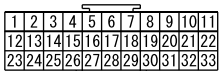

**(C-02)**

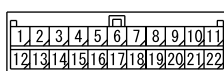

**(C-03)**



**(C-05)**

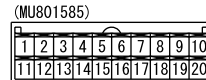

**(C-29)**

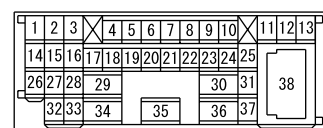

**(C-214)**

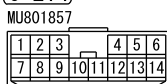

**(C-215)**



**WIRE COLOR CODE**

B : BLACK    LG : LIGHT GREEN    G : GREEN    L : BLUE  
 BR : BROWN    O : ORANGE    GR : GRAY    R : RED    W : WHITE  
 SB : SKY BLUE    P : PINK    Y : YELLOW    V : VIOLET

H5P05M00BB

**TSB Revision**

MULTIPOINT FUEL INJECTION (MFI) SYSTEM <2.4L ENGINE>

5

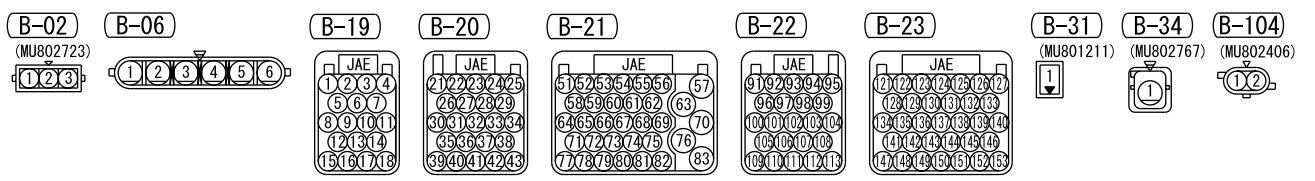
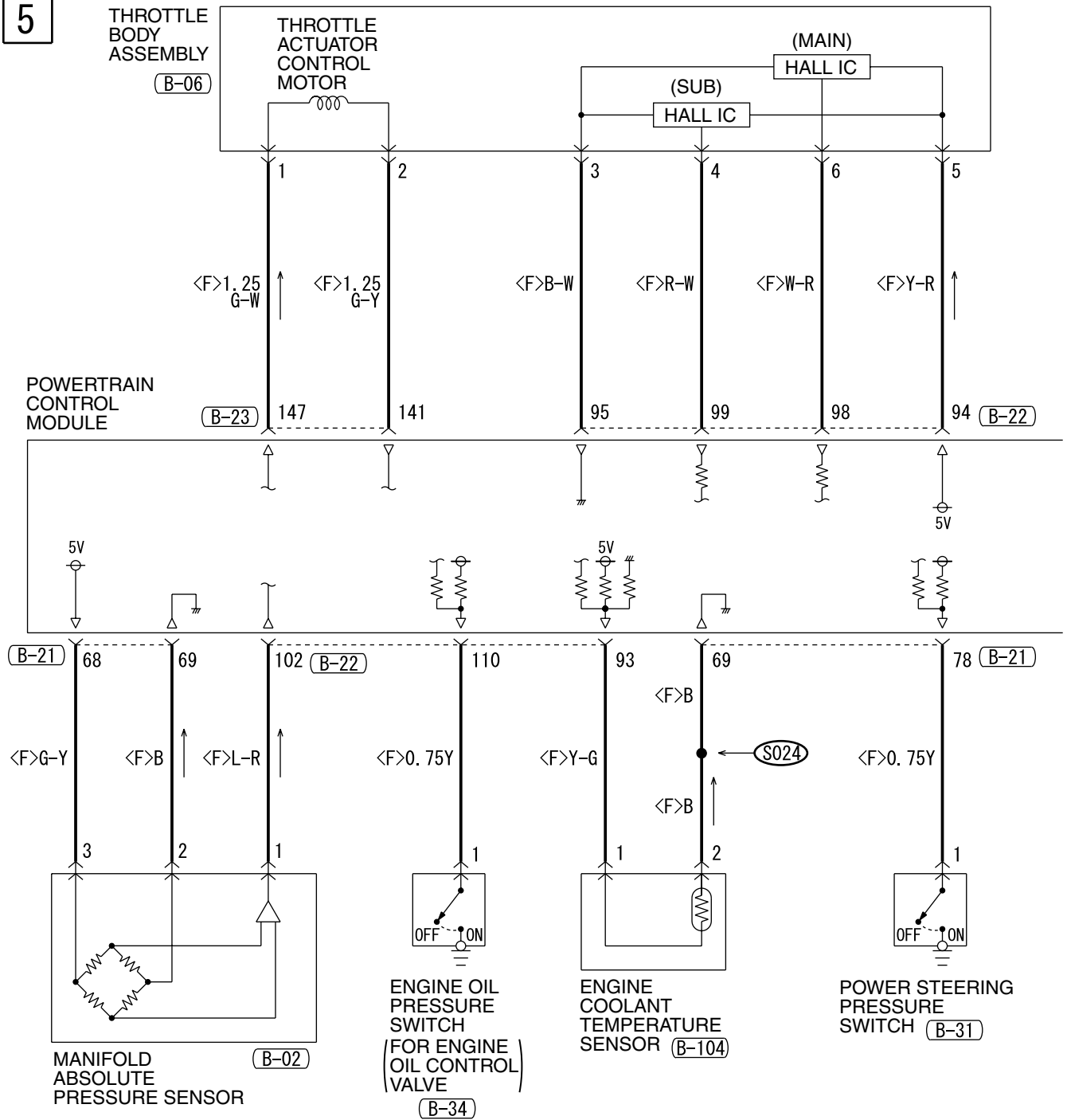



**6**

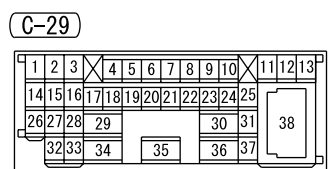
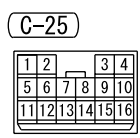
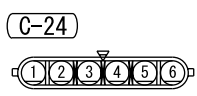
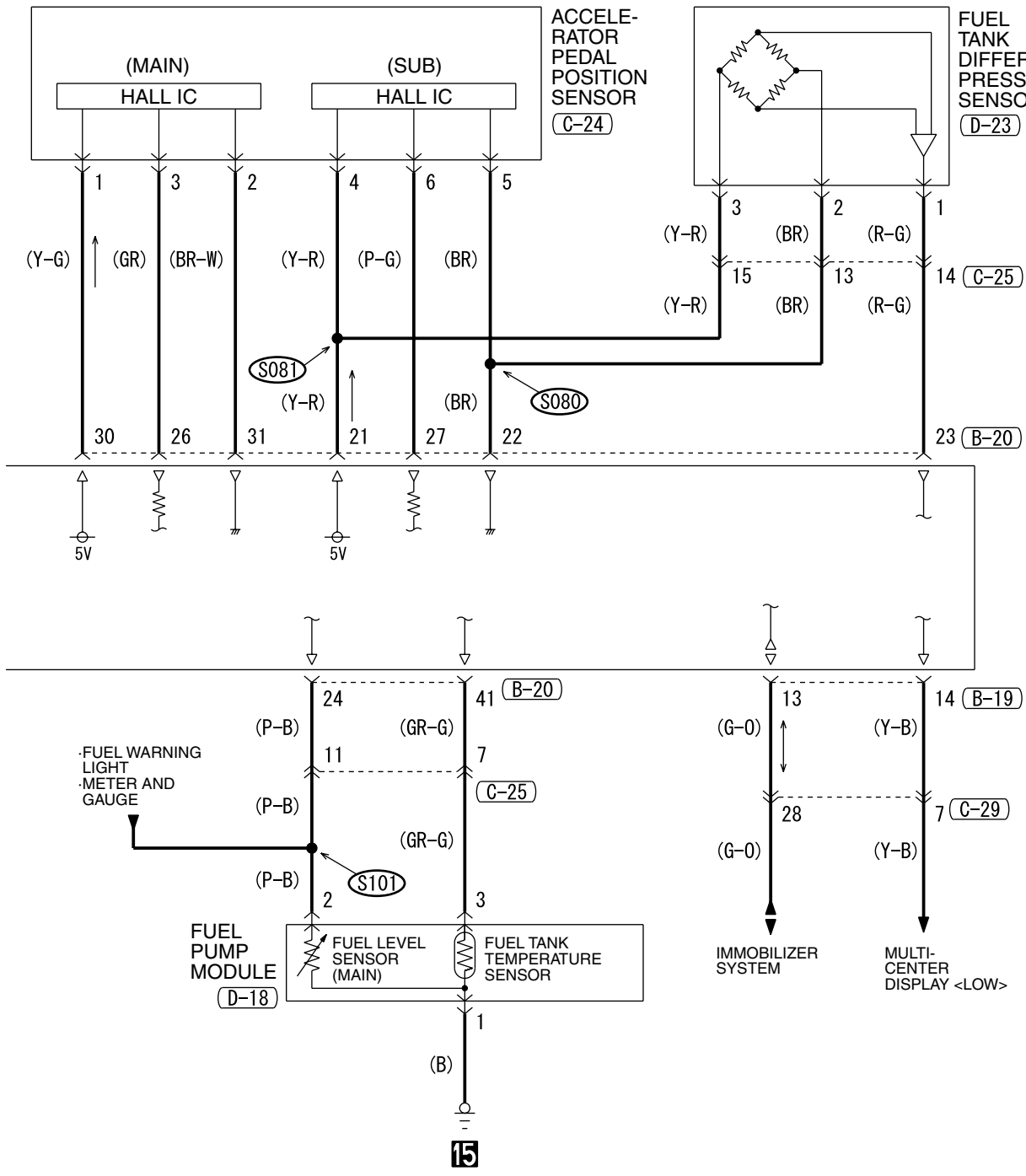

**WIRE COLOR CODE**  
 B : BLACK SB : SKY BLUE  
 BR : BROWN LG : LIGHT GREEN  
 G : GREEN P : PINK GR : GRAY  
 R : RED L : BLUE Y : YELLOW  
 V : VIOLET W : WHITE O : ORANGE

H5P05M00CB

**TSB Revision**

MULTIPOINT FUEL INJECTION (MFI) SYSTEM <2.4L ENGINE>

7

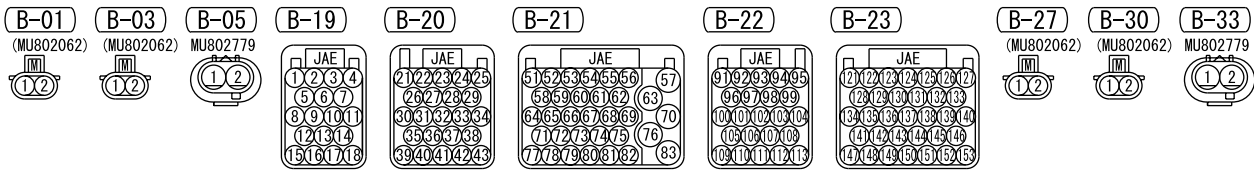
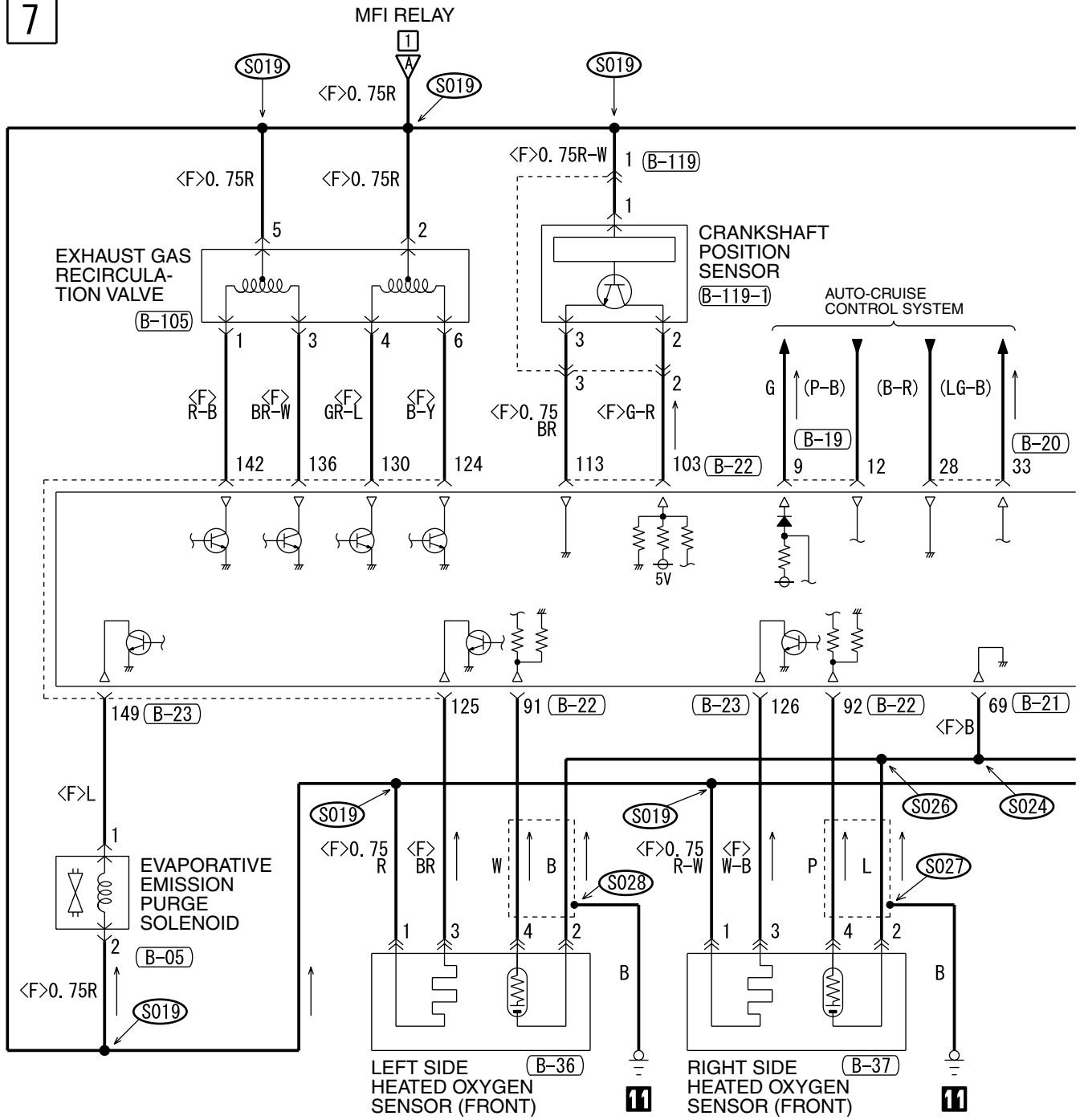

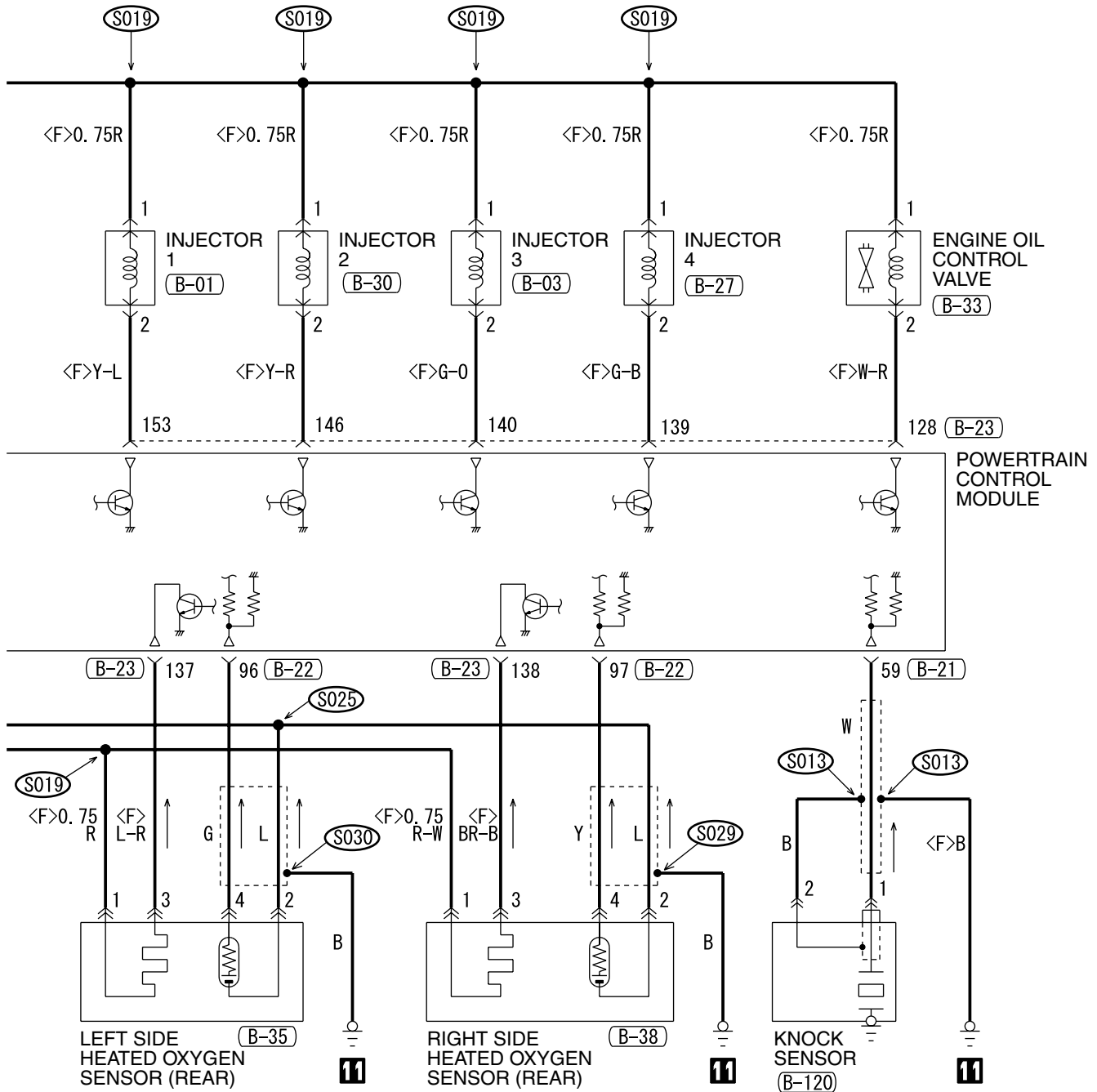

(B-35)	(B-36)	(B-37)	(B-38)	(B-105)	(B-119)	(B-119-1)	(B-120)
MU802605	MU802665	MU802665	MU802605	(MU802056)	(MU802064)	(1X2X3)	MU802661

WIRE COLOR CODE  
 B: BLACK LG: LIGHT GREEN G: GREEN L: BLUE W: WHITE Y: YELLOW  
 SB: SKY BLUE BR: BROWN O: ORANGE GR: GRAY R: RED P: PINK V: VIOLET

H5P05M00DB

MULTIPOINT FUEL INJECTION (MFI) SYSTEM <2.4L ENGINE>

9

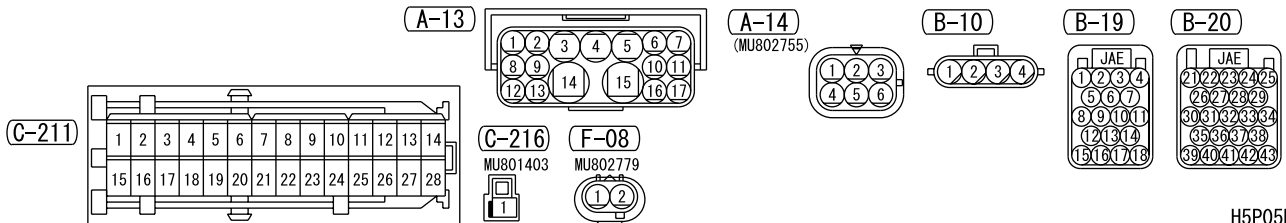
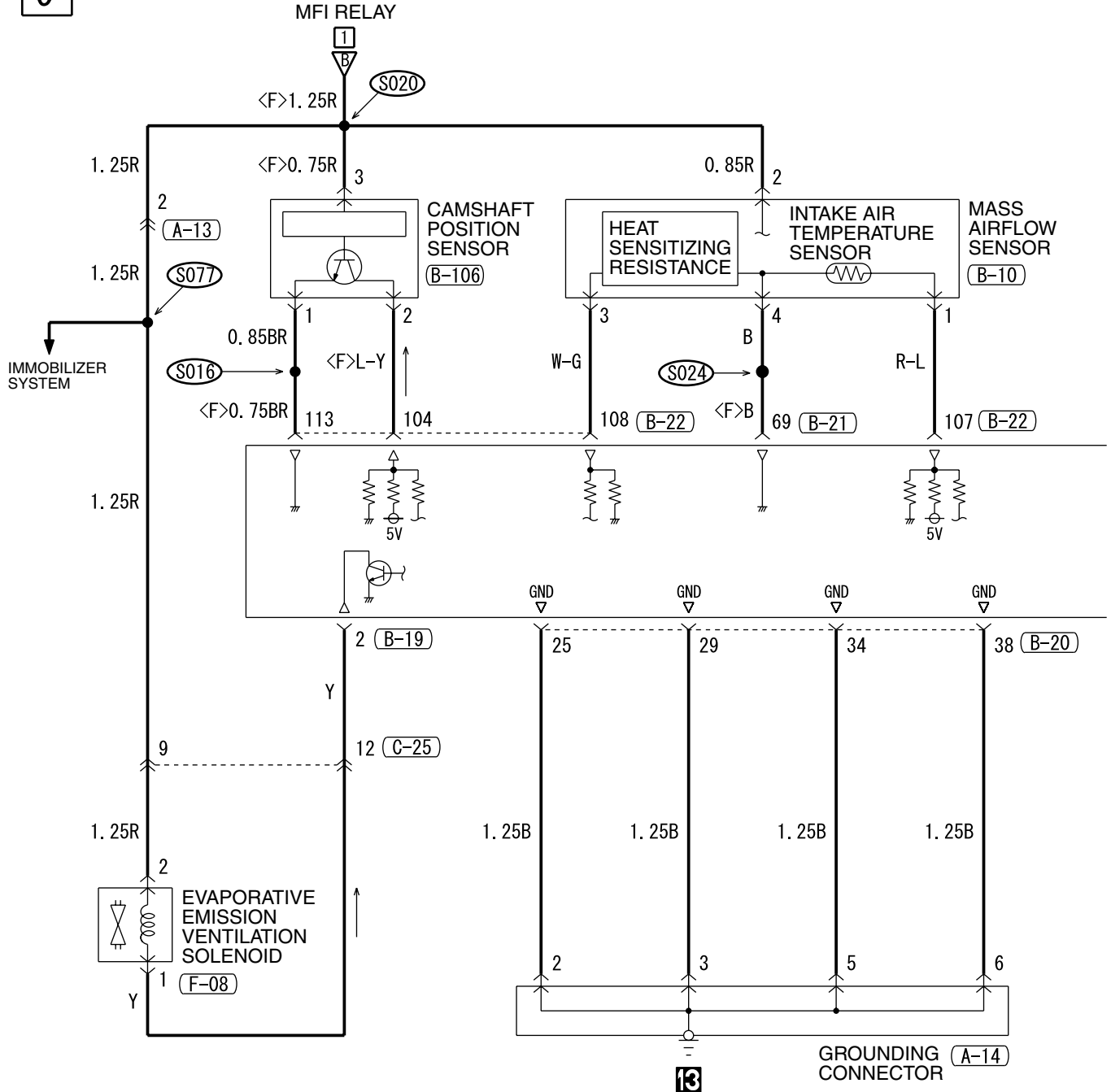

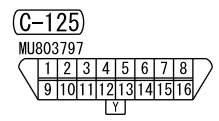
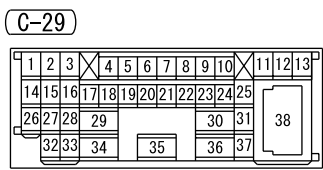
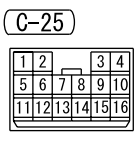
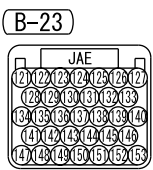
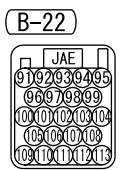
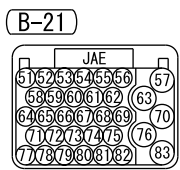
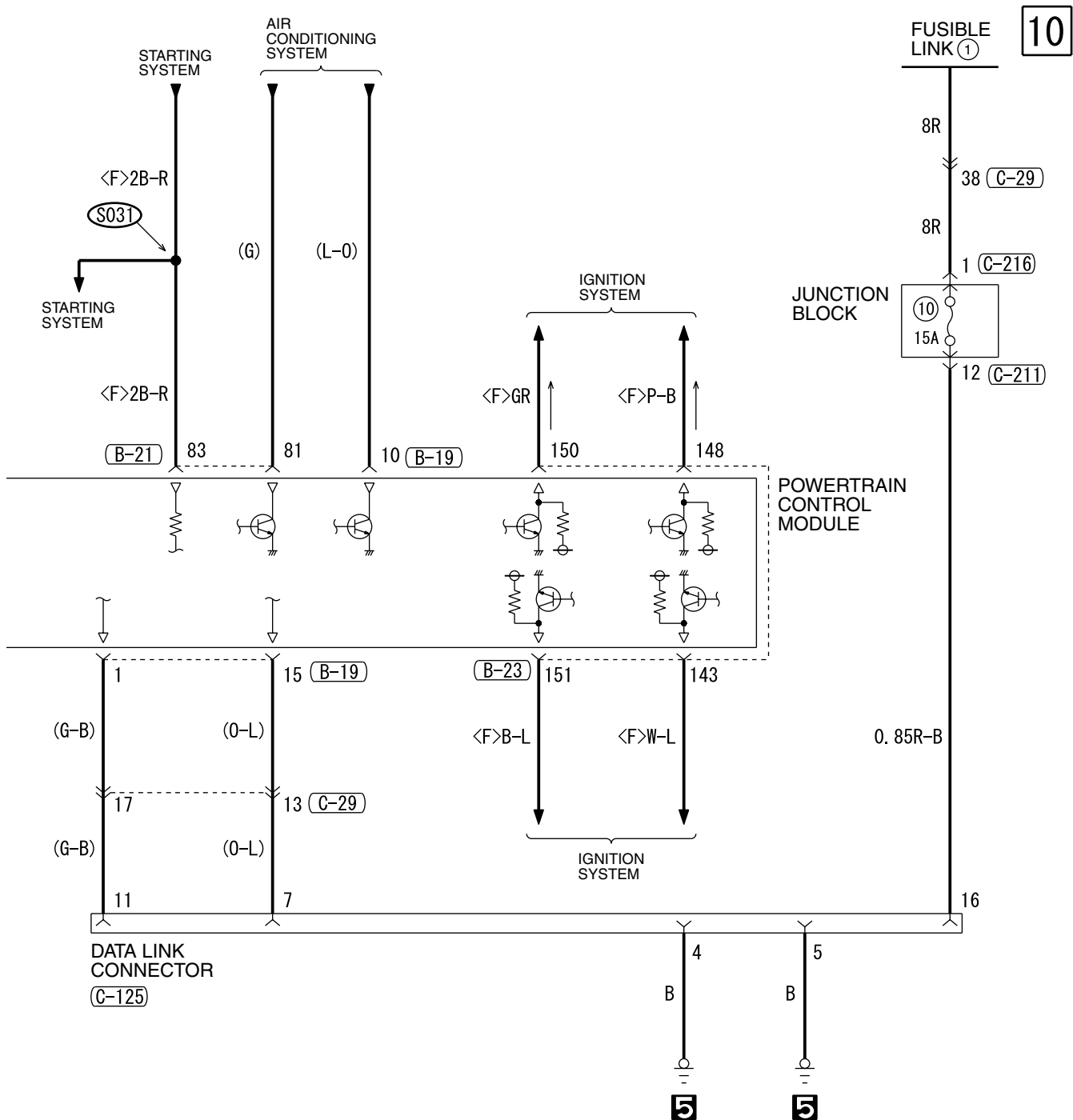

# MULTIPOINT FUEL INJECTION (MFI) SYSTEM <3.8L ENGINE>

M1901000802390

1

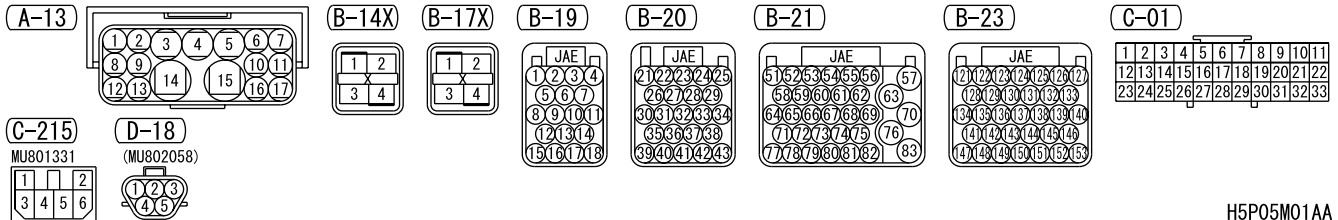
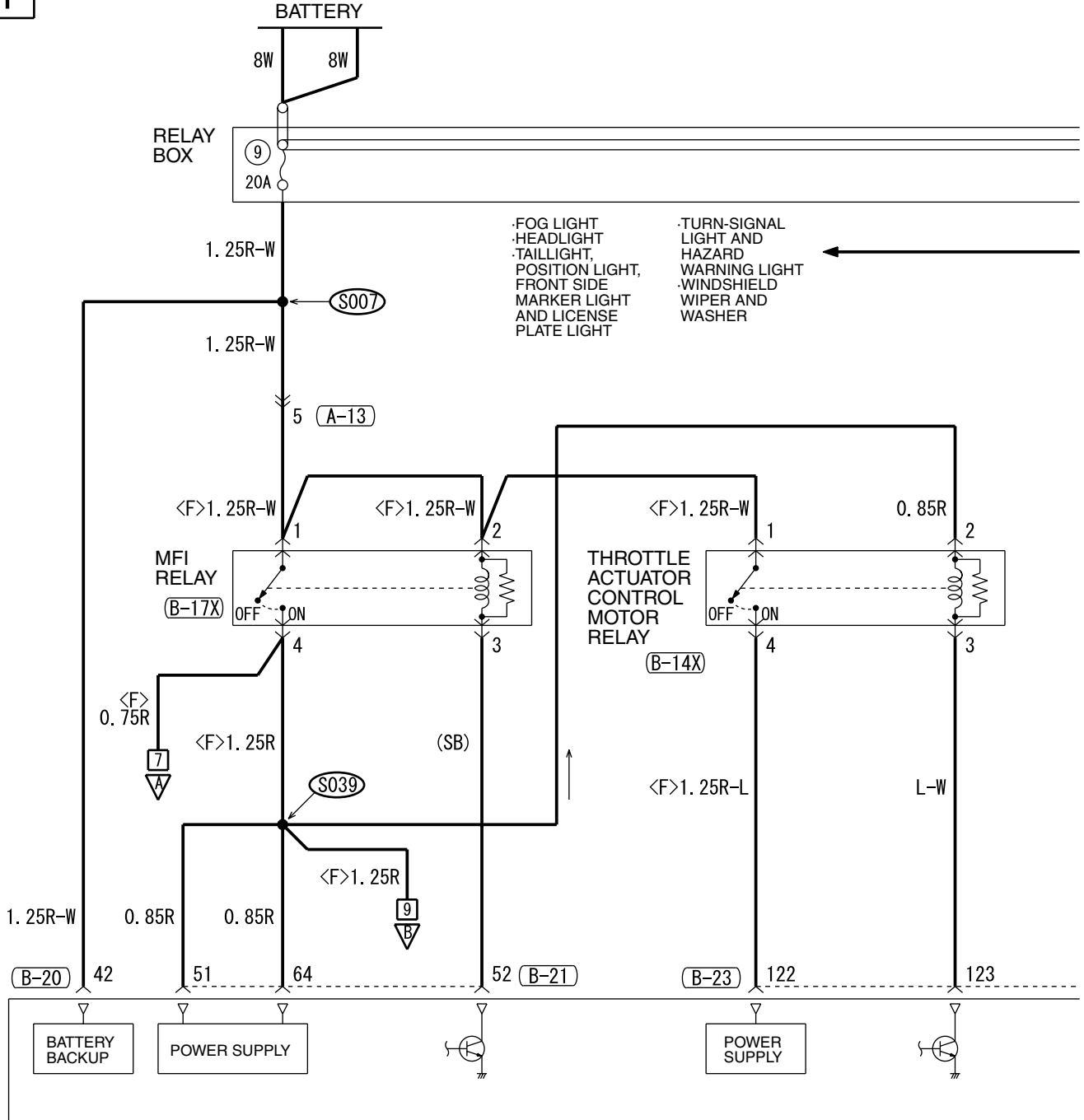

H5P05M01AA

2

NOTE

- \* : AUDIO SYSTEM
- AUTOMATIC AIR CONDITIONING SYSTEM
- CONTROLLER AREA NETWORK (CAN)
- FOG LIGHT
- FRONT DOME LIGHT, REAR DOME LIGHT, TRUNK LIGHT AND IGNITION KEY HOLE ILLUMINATION LIGHT
- HEADLIGHT
- MANUAL AIR CONDITIONING SYSTEM
- MULTI-CENTER DISPLAY
- TAILLIGHT, POSITION LIGHT, FRONT SIDE MARKER LIGHT AND LICENSE PLATE LIGHT
- TURN-SIGNAL LIGHT AND HAZARD WARNING LIGHT
- VANITY MIRROR LIGHT
- WINDSHIELD WIPER AND WASHER

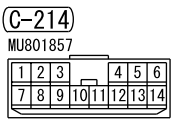
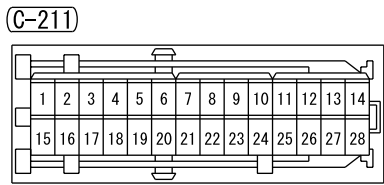
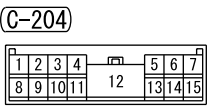
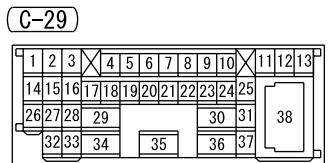
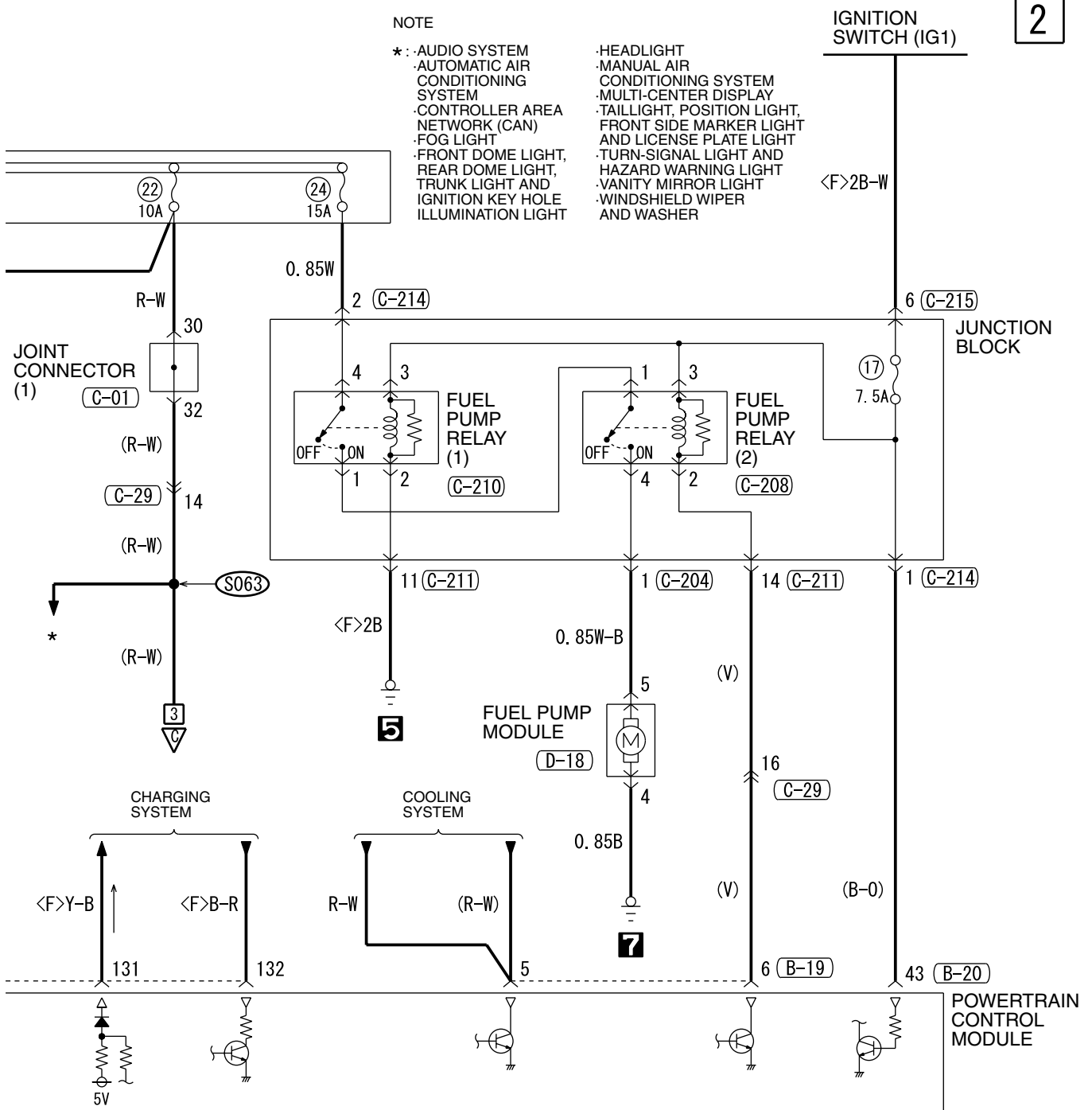

MULTIPOINT FUEL INJECTION (MFI) SYSTEM <3.8L ENGINE> (CONTINUED)

3

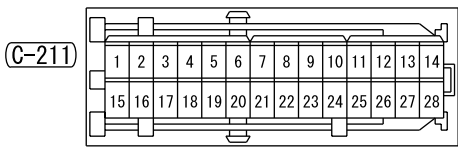
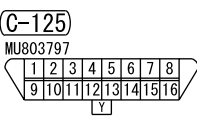
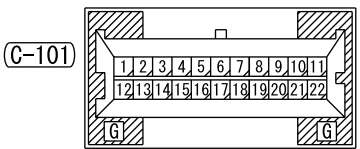
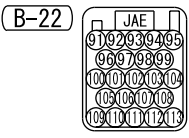
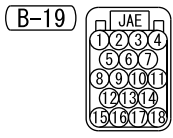
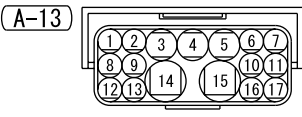
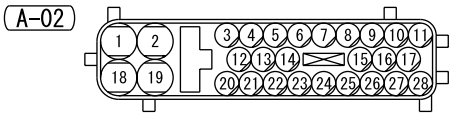
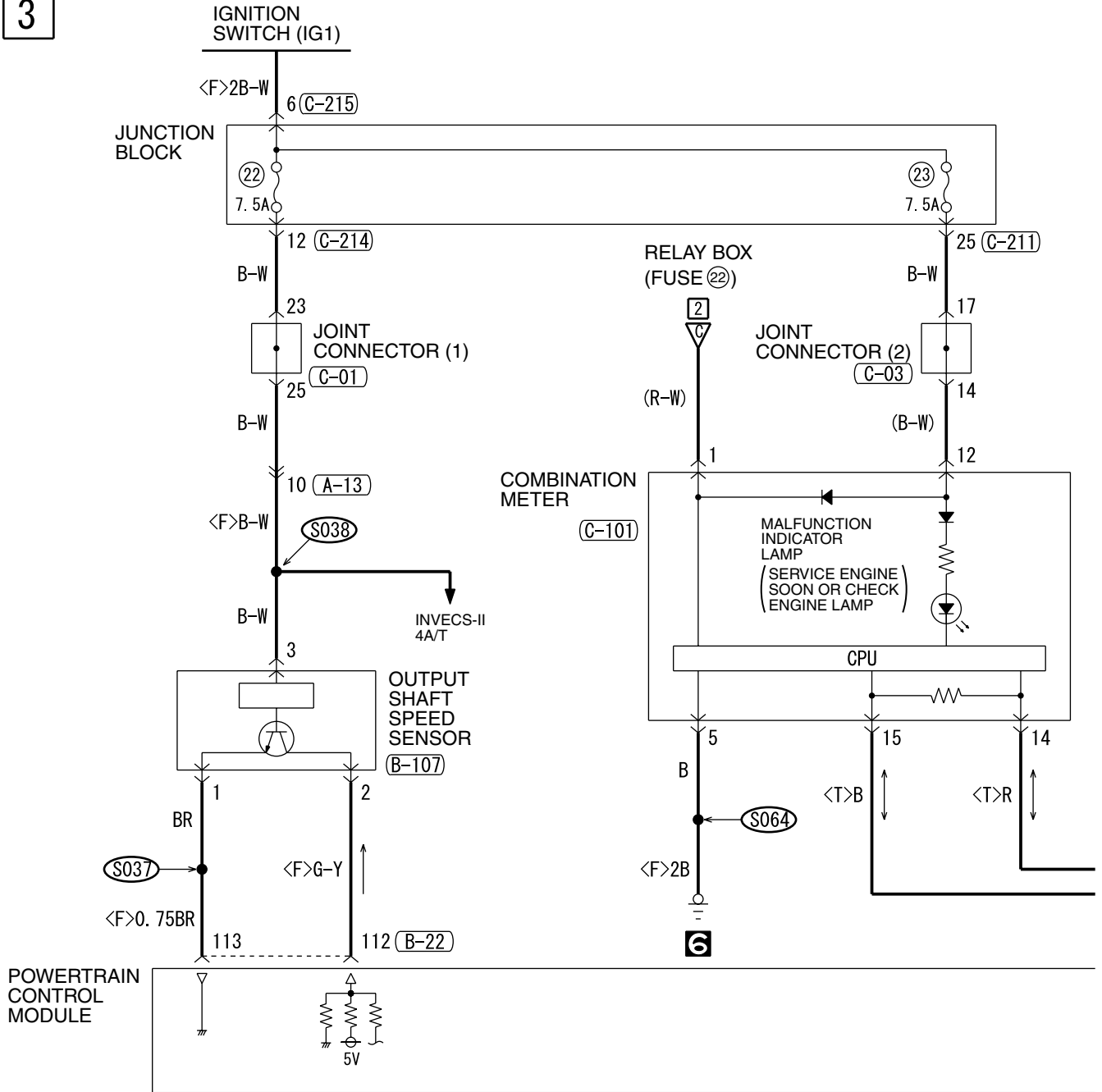



4

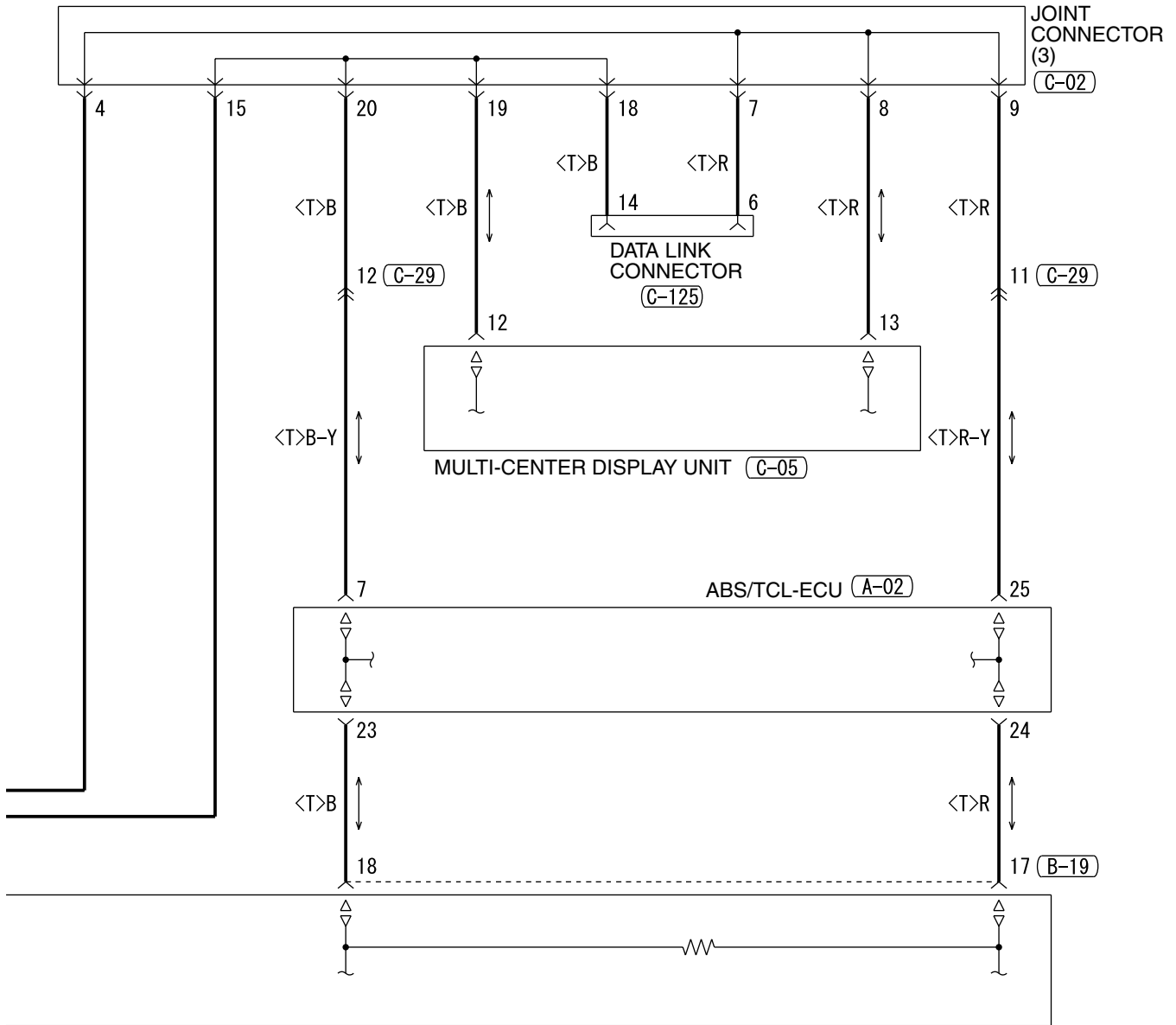

(C-01)

1	2	3	4	5	6	7	8	9	10	11
12	13	14	15	16	17	18	19	20	21	22
23	24	25	26	27	28	29	30	31	32	33

(C-02)

1	2	3	4	5	6	7	8	9	10	11
12	13	14	15	16	17	18	19	20	21	22

(C-03)

1	2	3	4	5	6	7	8	9	10	11
12	13	14	15	16	17	18	19	20	21	22
23	24	25	26	27	28	29	30	31	32	33

(C-05)

(MU801585)

1	2	3	4	5	6	7	8	9	10
11	12	13	14	15	16	17	18	19	20

(C-29)

1	2	3	4	5	6	7	8	9	10	11	12	13
14	15	16	17	18	19	20	21	22	23	24	25	
26	27	28	29					30	31		38	
32	33	34				35			36	37		

(C-214)

MU801857

1	2	3	4	5	6
7	8	9	10	11	12

(C-215)

MU801331

1	2
3	4
5	6

WIRE COLOR CODE  
 B : BLACK LG : LIGHT GREEN G : GREEN L : BLUE  
 BR : BROWN O : ORANGE GR : GRAY R : RED W : WHITE  
 SB : SKY BLUE P : PINK Y : YELLOW V : VIOLET

H5P05M01BB

MULTIPOINT FUEL INJECTION (MFI) SYSTEM <3.8L ENGINE> (CONTINUED)

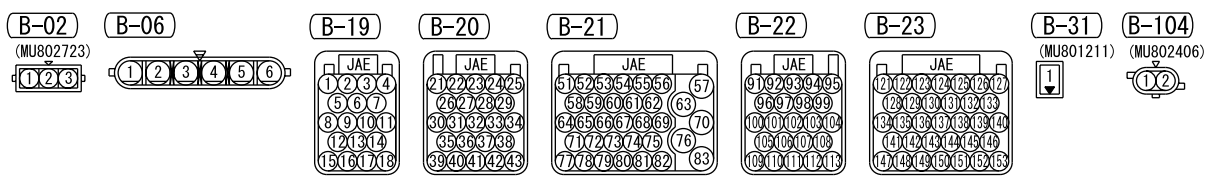
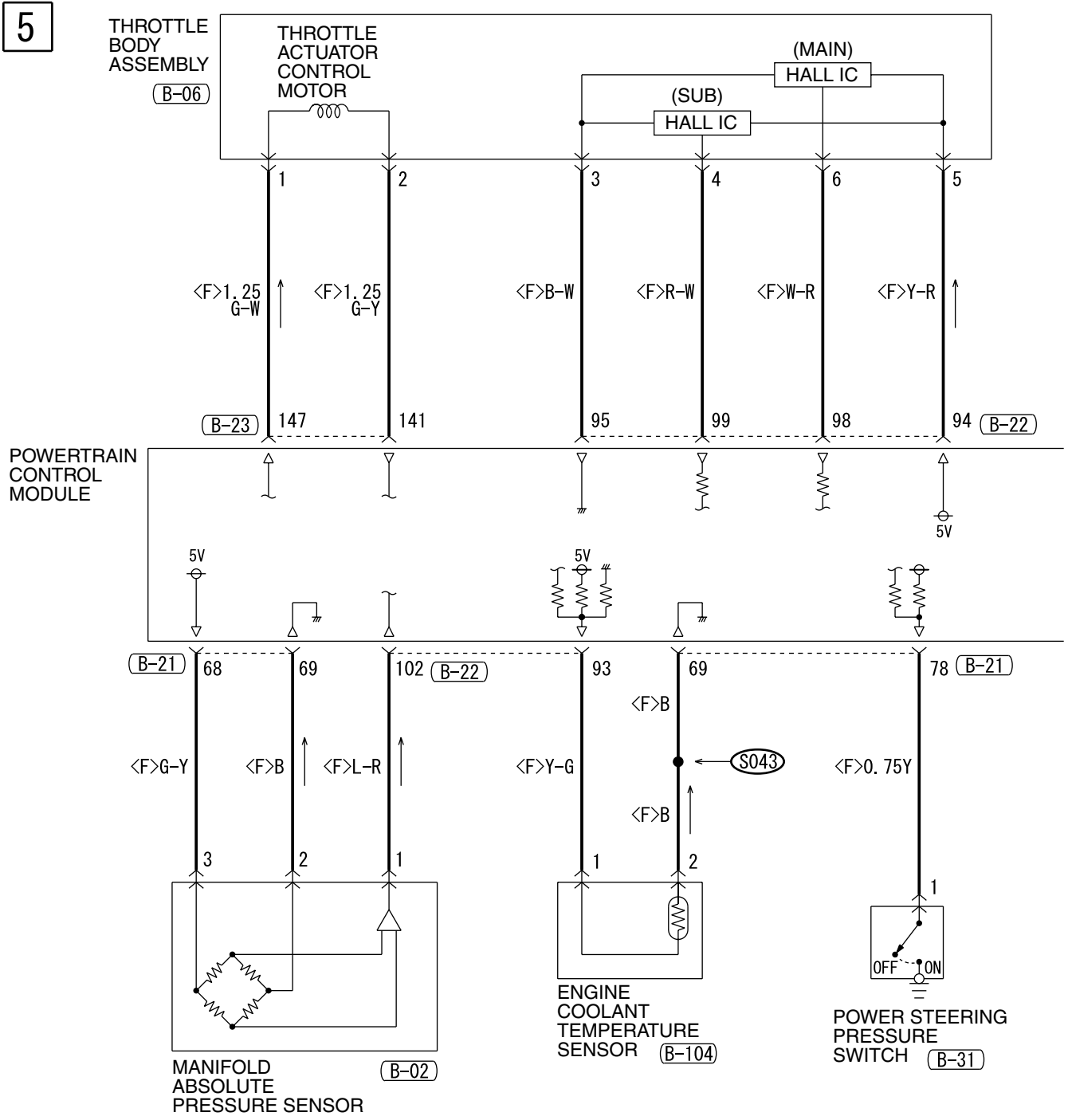

**6**

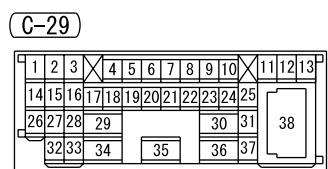
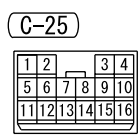
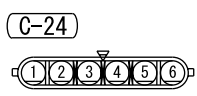
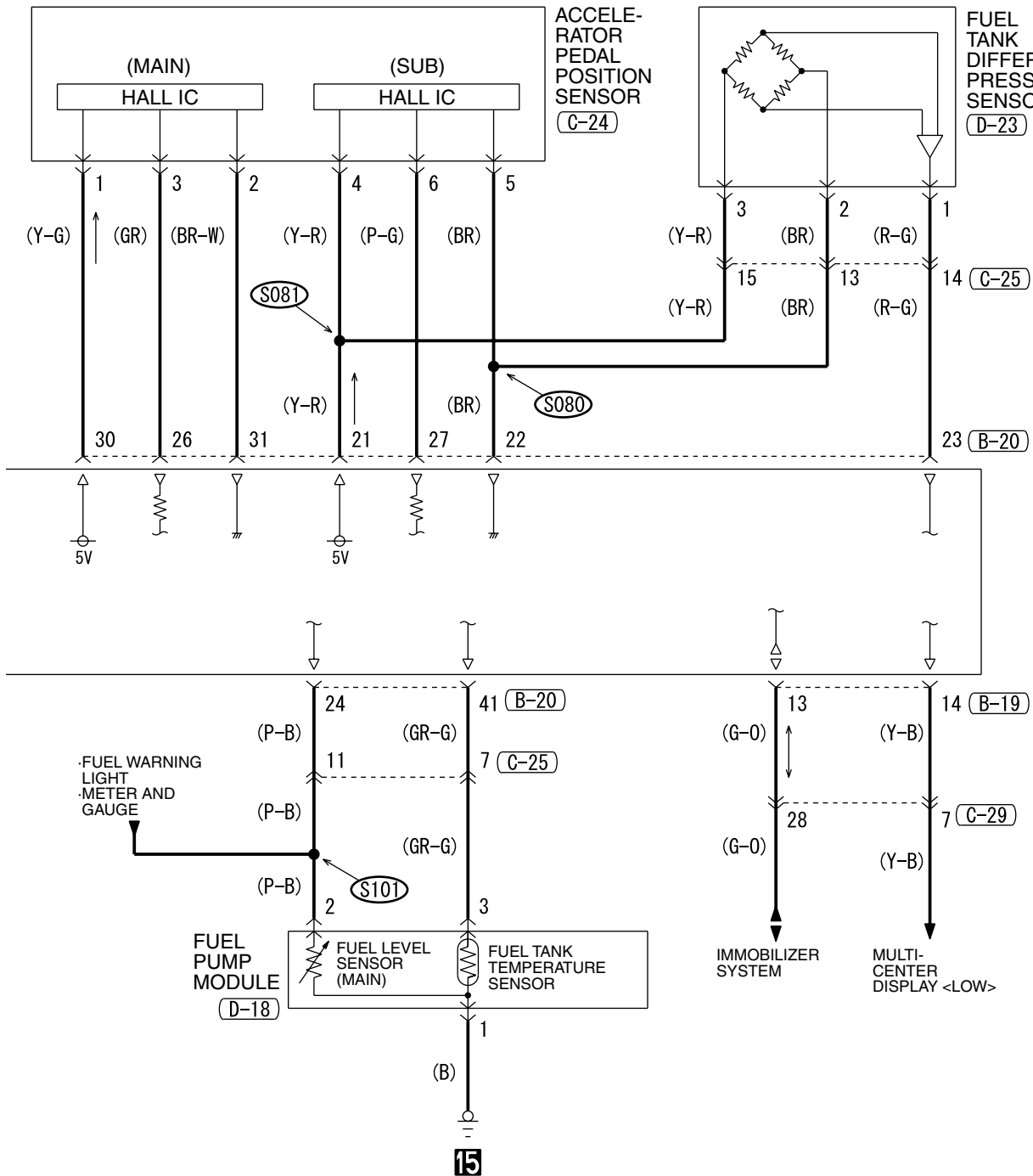

**WIRE COLOR CODE**  
 B : BLACK SB : SKY BLUE  
 BR : BROWN LG : LIGHT GREEN  
 G : GREEN P : PINK GR : GRAY  
 R : RED L : BLUE Y : YELLOW  
 V : VIOLET W : WHITE O : ORANGE

MULTIPOINT FUEL INJECTION (MFI) SYSTEM <3.8L ENGINE> (CONTINUED)

7

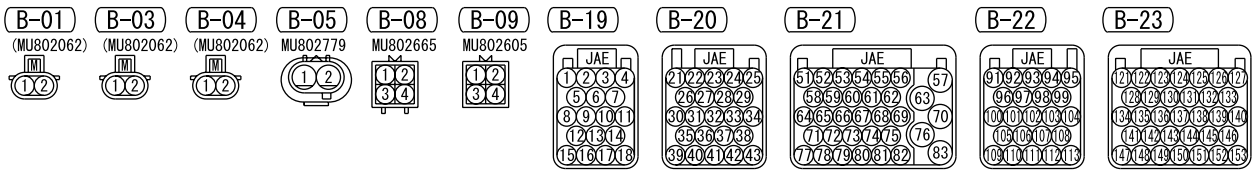
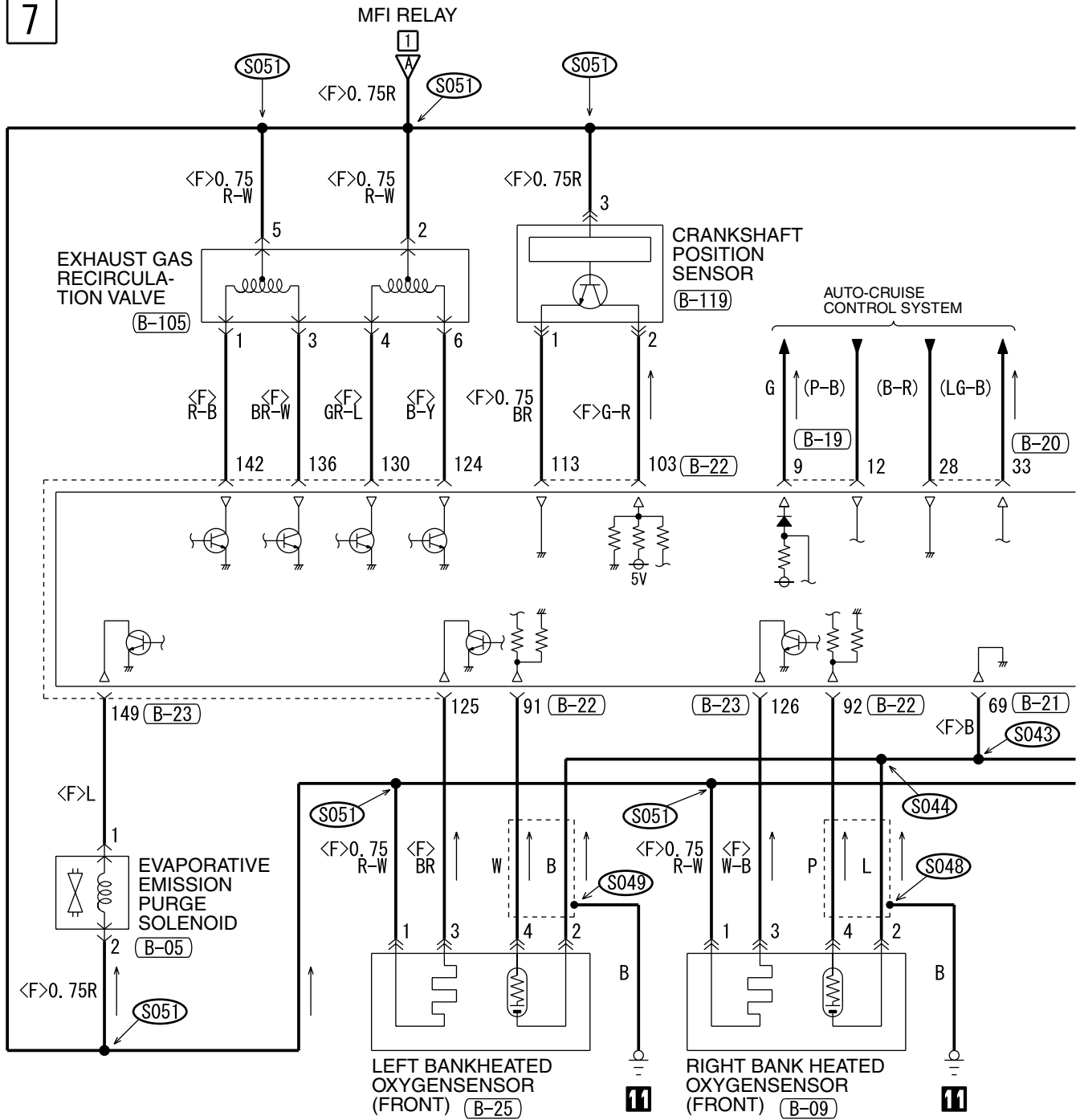

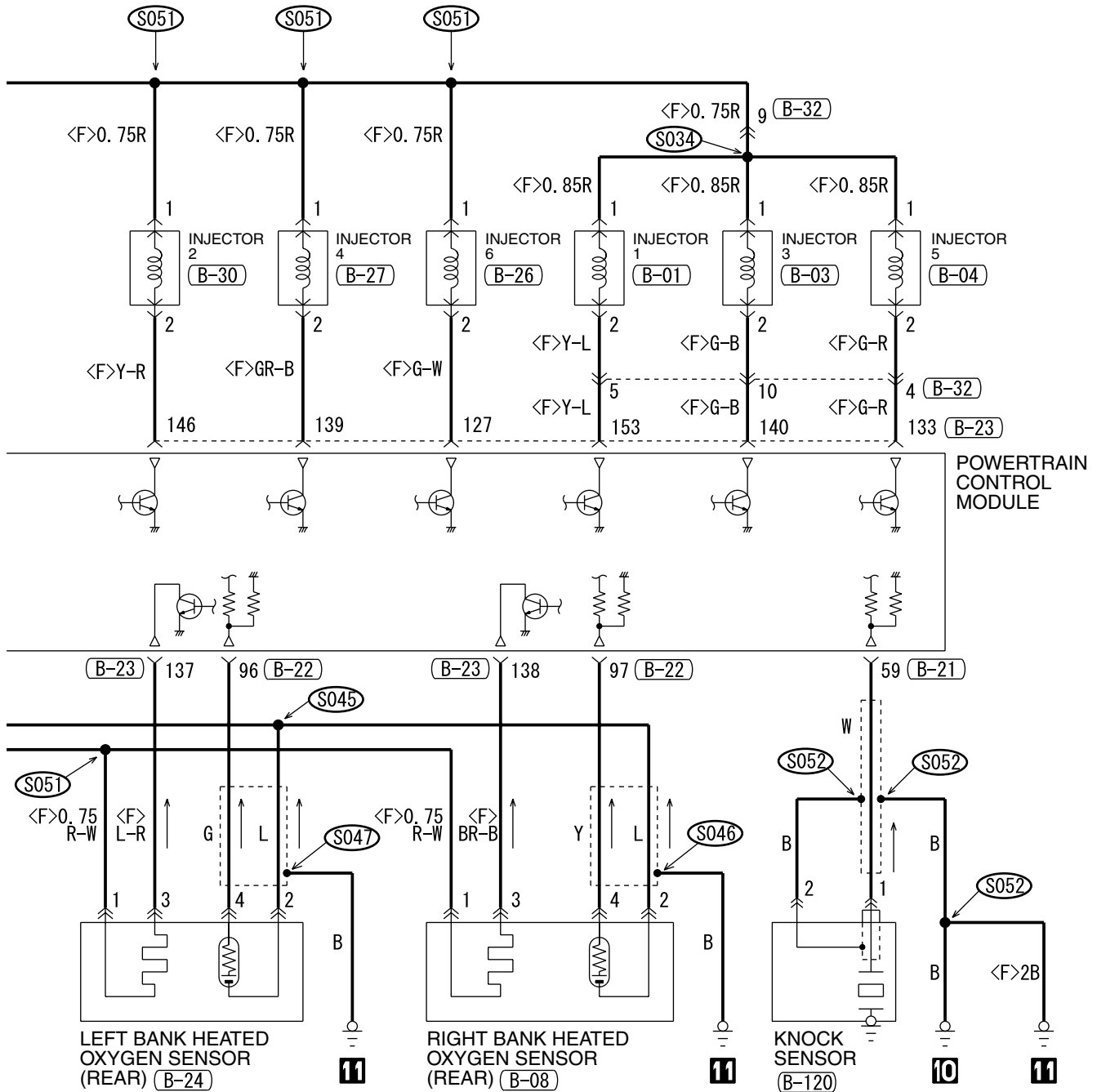

B-24	B-25	B-26	B-27	B-30	B-32	B-105	B-119	B-120
MU802665	MU802605	(MU802062)	(MU802062)	(MU802062)	MU802645	(MU802056)	MU802603	MU802661

WIRE COLOR CODE  
 B: BLACK LG: LIGHT GREEN G: GREEN L: BLUE W: WHITE Y: YELLOW  
 SB: SKY BLUE BR: BROWN O: ORANGE GR: GRAY R: RED P: PINK V: VIOLET

H5P05M01DB

MULTIPOINT FUEL INJECTION (MFI) SYSTEM <3.8L ENGINE> (CONTINUED)

9

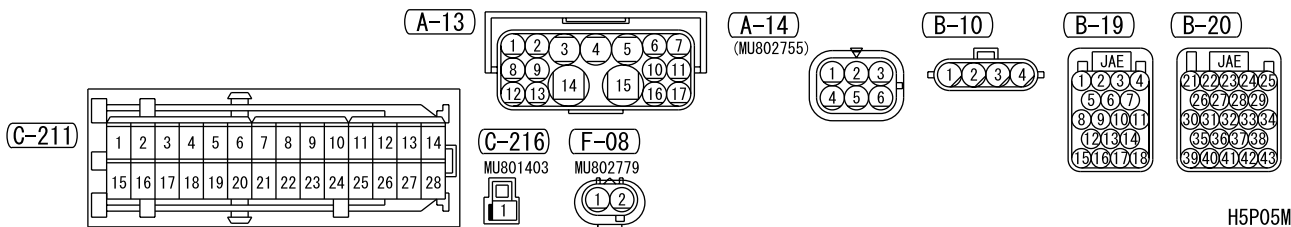
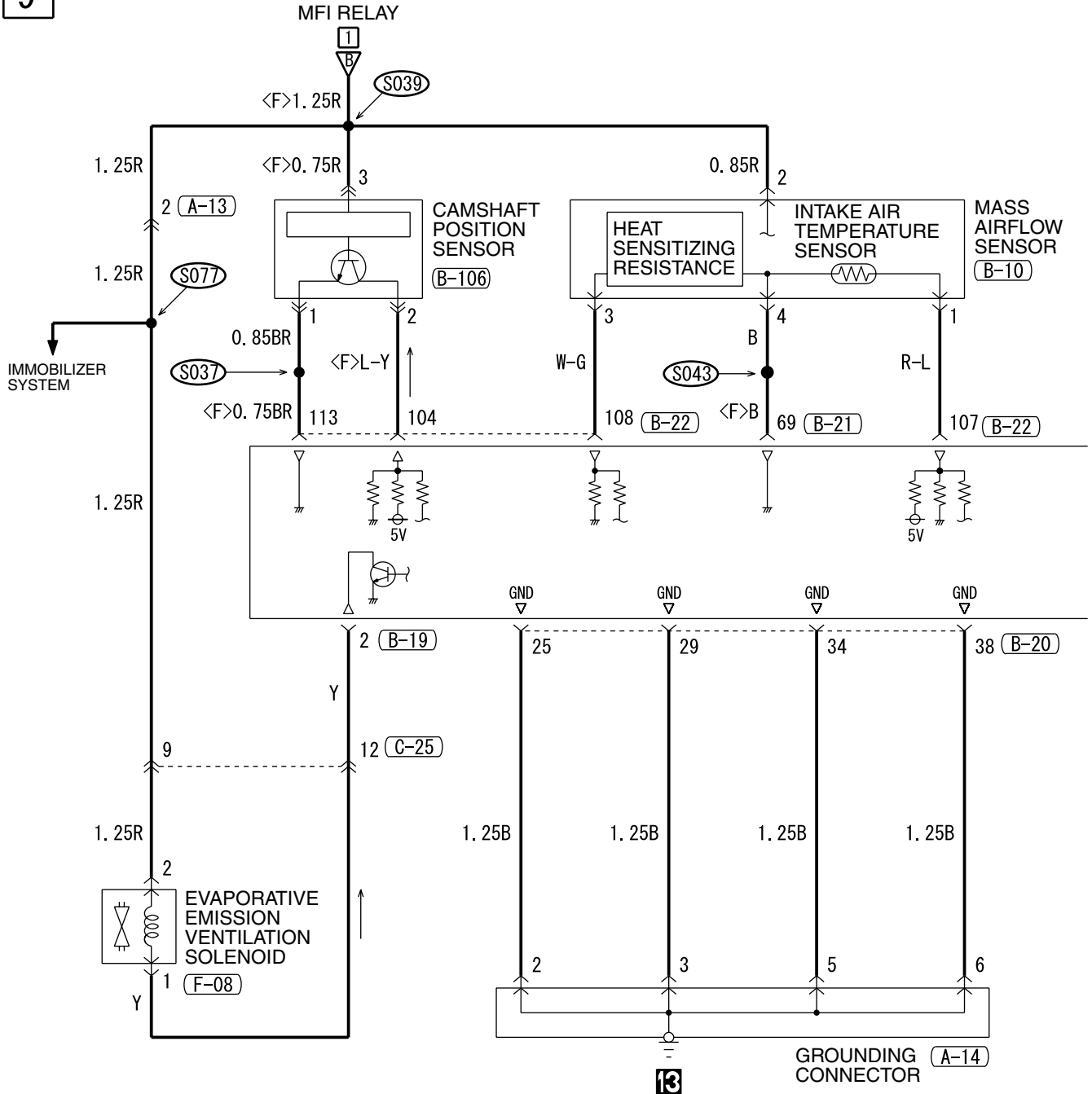

H5P05M01EA

TSB Revision

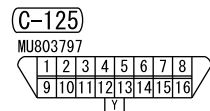
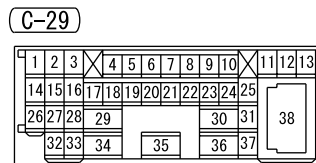
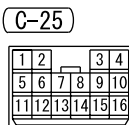
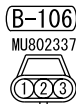
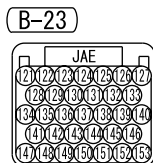
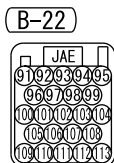
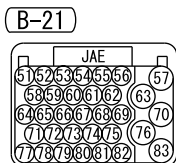
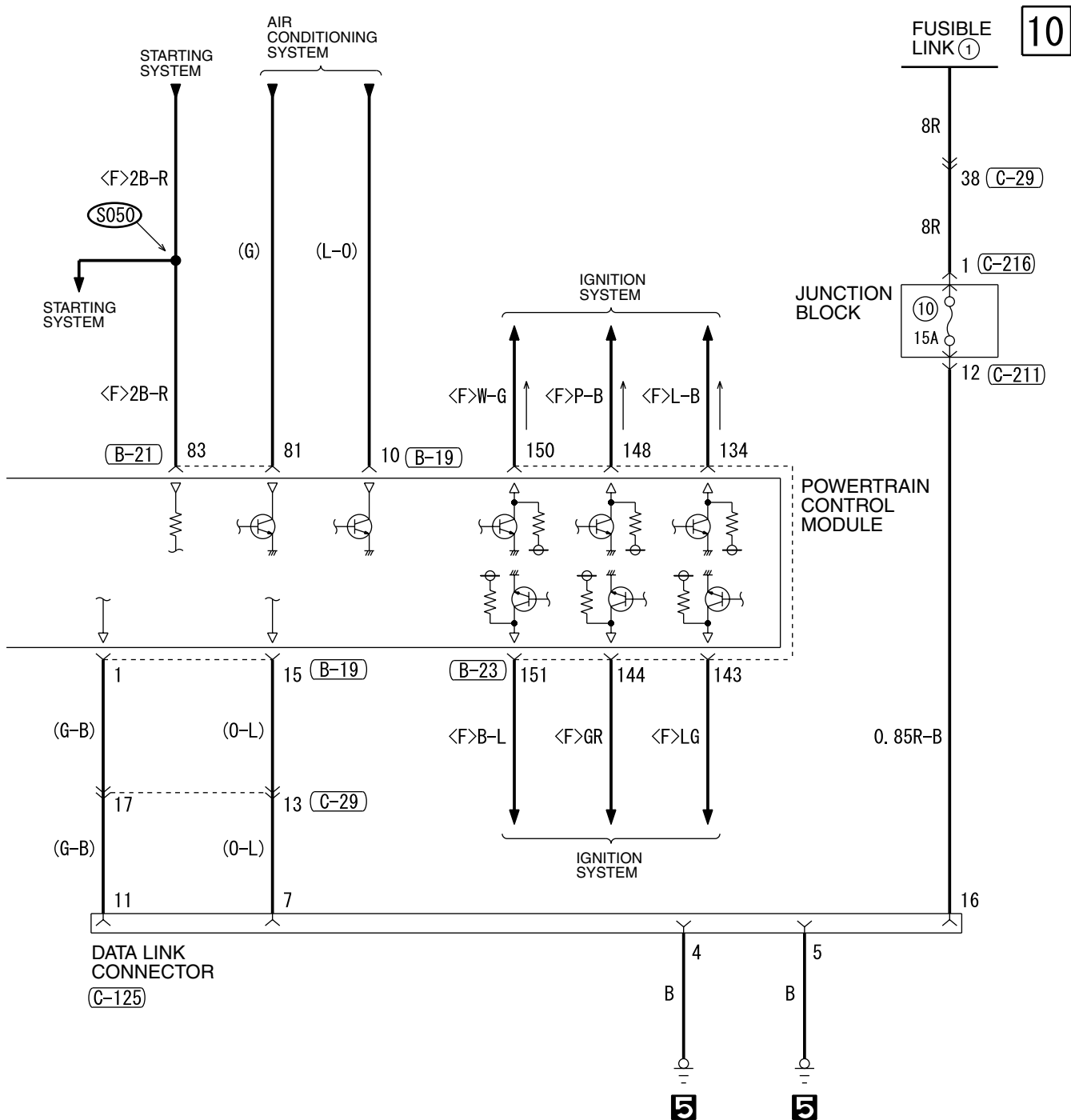

# COOLING SYSTEM

M1901001000937

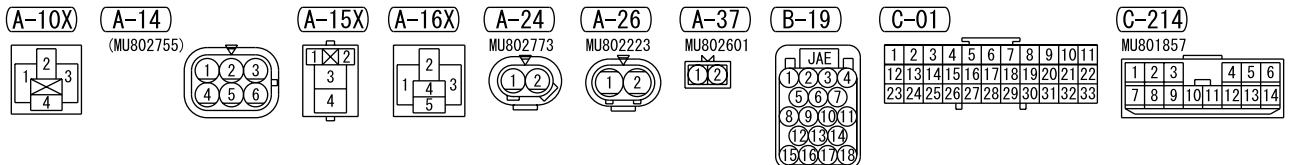
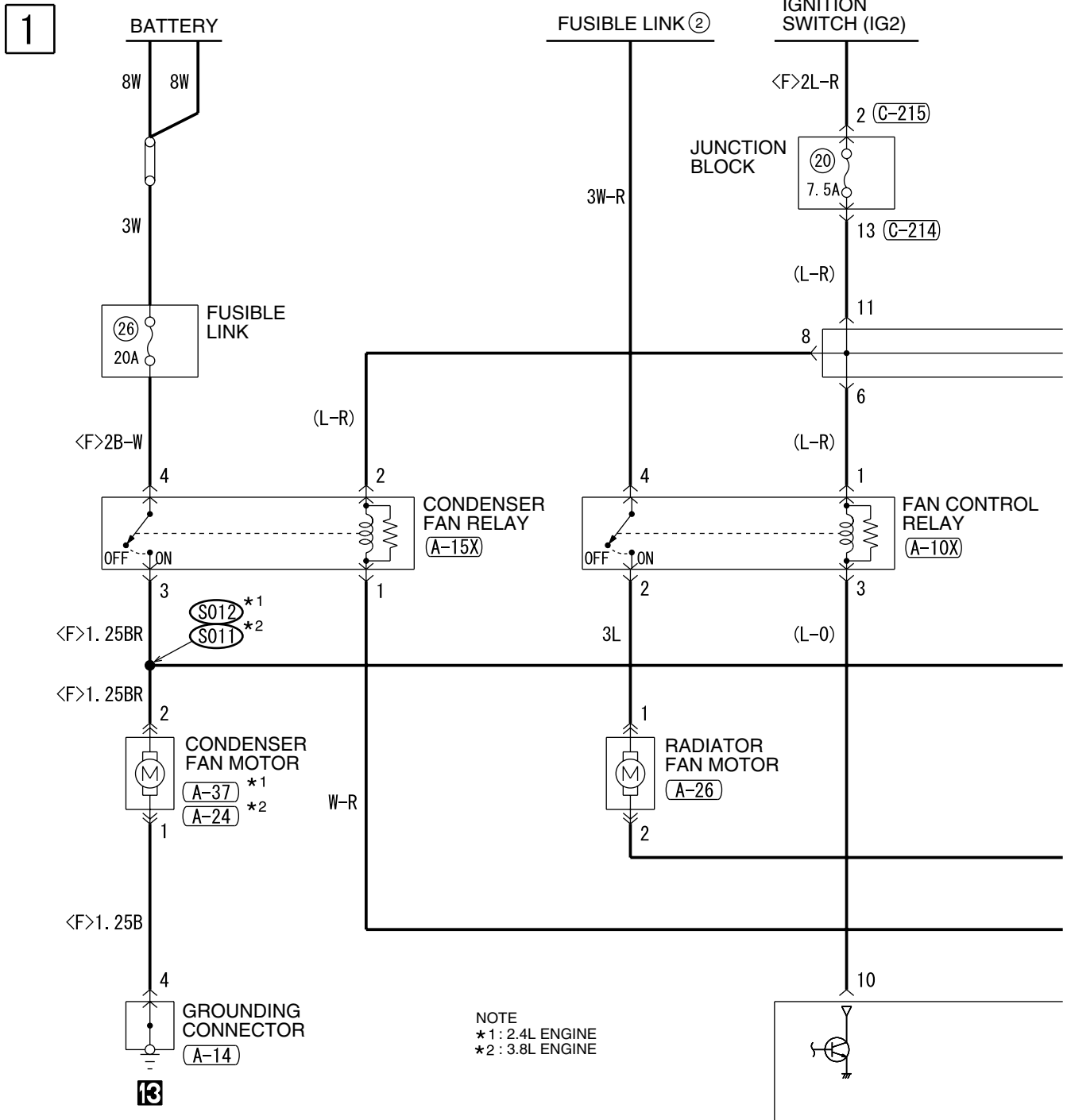

H5P06M00AA





INVECS-II 4A/T <2.4L ENGINE>

M1901016201297

1

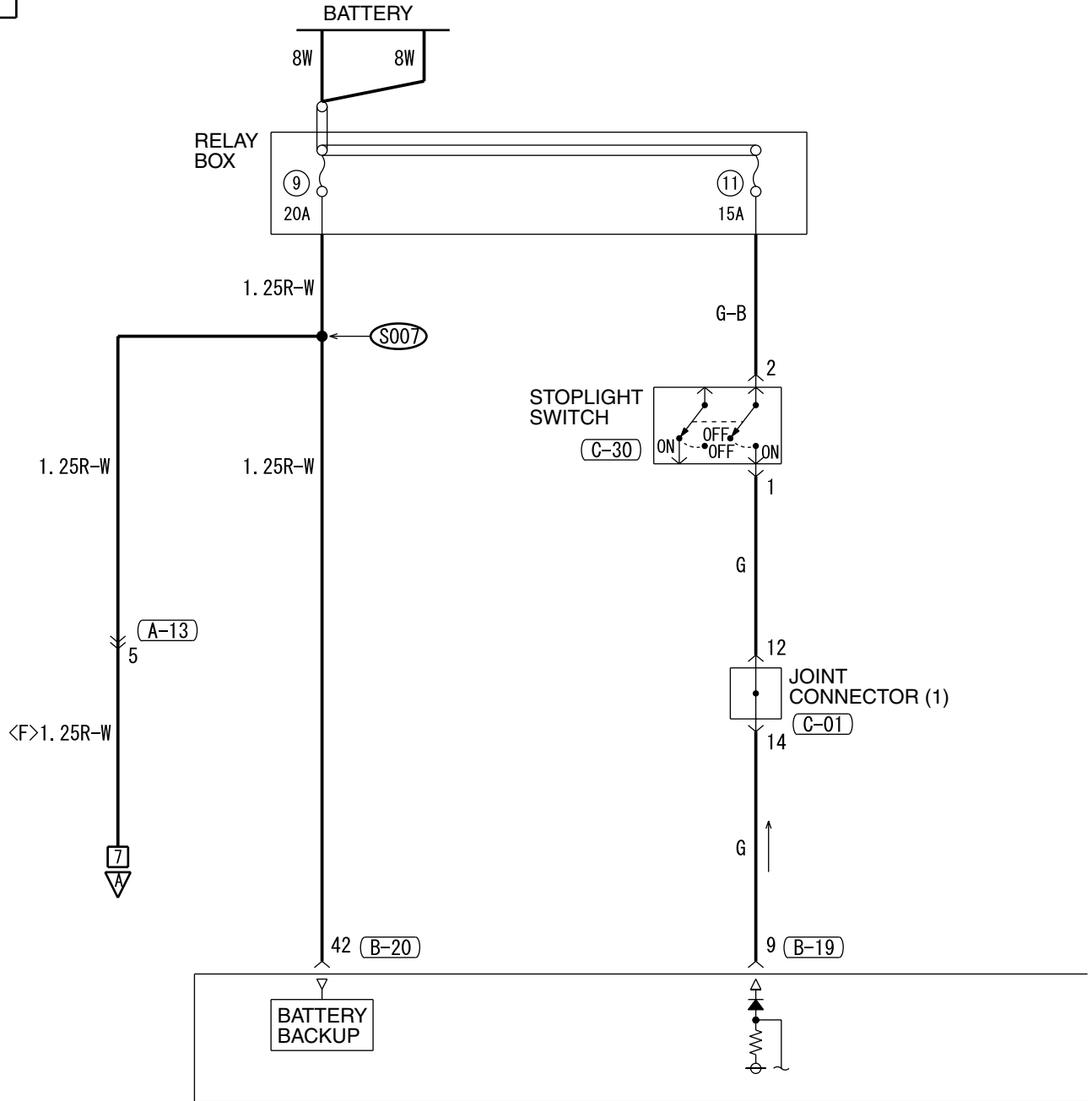

(A-13)

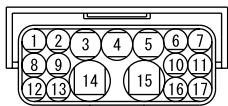

(B-19)

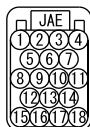

(B-20)

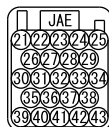

(B-22)

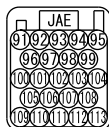

(B-107)  
(MU802348)



(B-109)  
MU802337



(C-01)

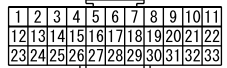

(C-03)

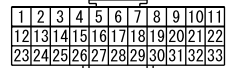

H5P07M00AA

TSB Revision

2

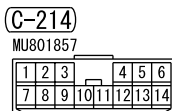
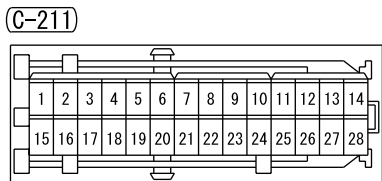
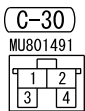
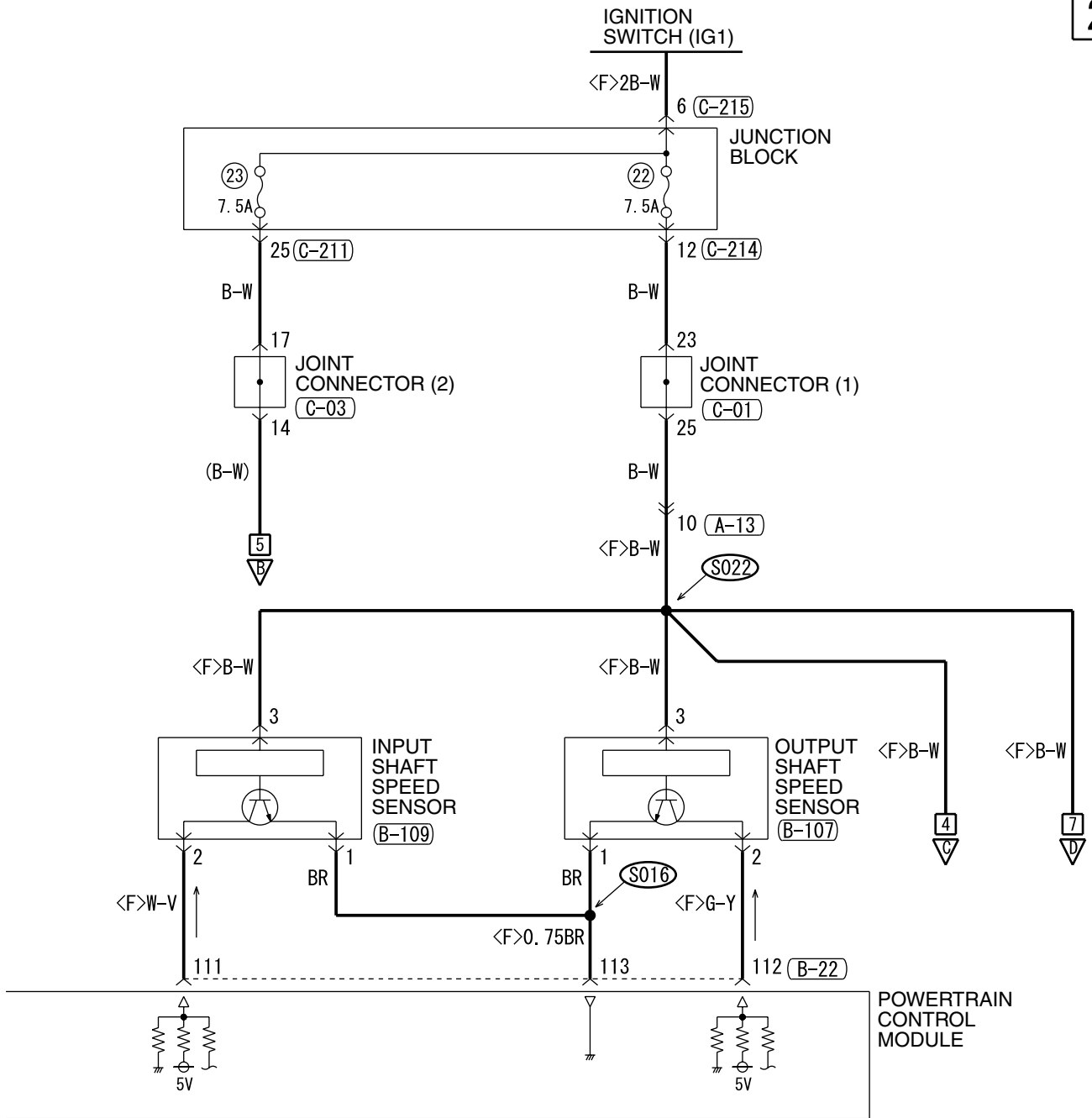

WIRE COLOR CODE  
 B : BLACK SB : SKY BLUE  
 BR : BROWN LG : LIGHT GREEN  
 G : GREEN P : PINK GR : GRAY  
 R : RED L : BLUE Y : YELLOW  
 V : VIOLET W : WHITE O : ORANGE

INVECS-II 4A/T <2.4L ENGINE> (CONTINUED)

3

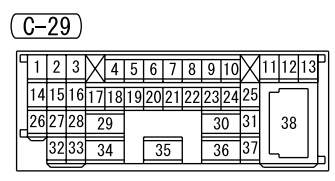
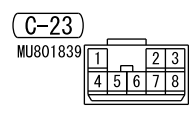
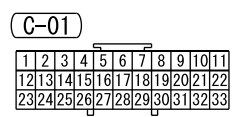
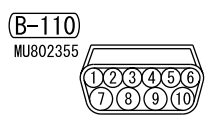
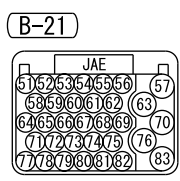
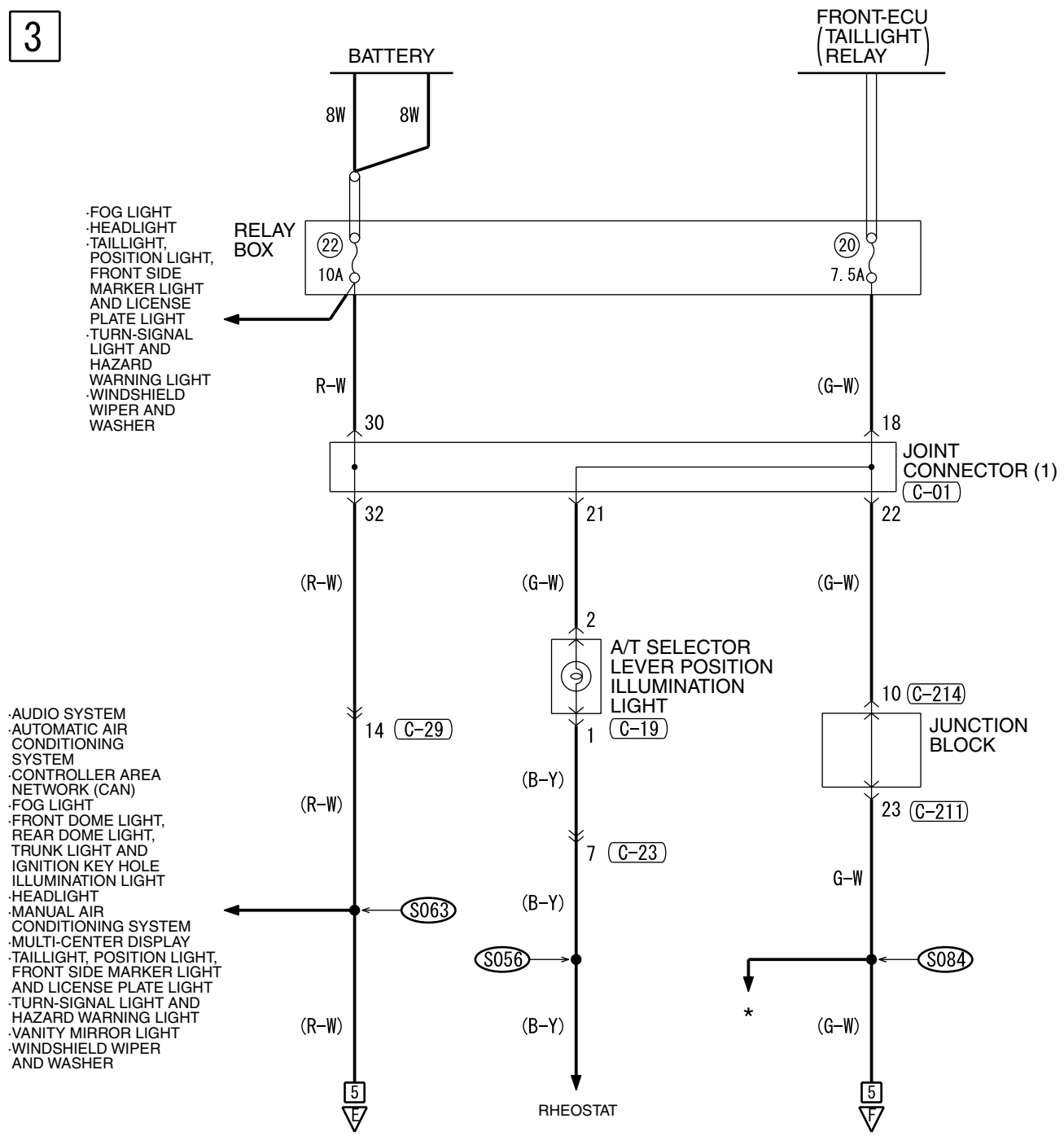

4

NOTE

- \* : -AUDIO SYSTEM
- AUTOMATIC AIR CONDITIONING SYSTEM
- ELECTRONIC BRAKE-FORCE DISTRIBUTION (EBD) AND ANTI-LOCK BRAKING SYSTEM (ABS)
- <VEHICLES WITH TRACTION CONTROL (TCL)>
- FOG LIGHT
- GLOVE BOX LIGHT
- HEATED SEAT
- MANUAL AIR CONDITIONING SYSTEM
- MULTI-CENTER DISPLAY
- REAR WINDOW DEFOGGER AND DOOR MIRROR HEATER
- RHEOSTAT
- SUPPLEMENTAL RESTRAINT SYSTEM (SRS)
- TURN-SIGNAL LIGHT AND HAZARD WARNING LIGHT

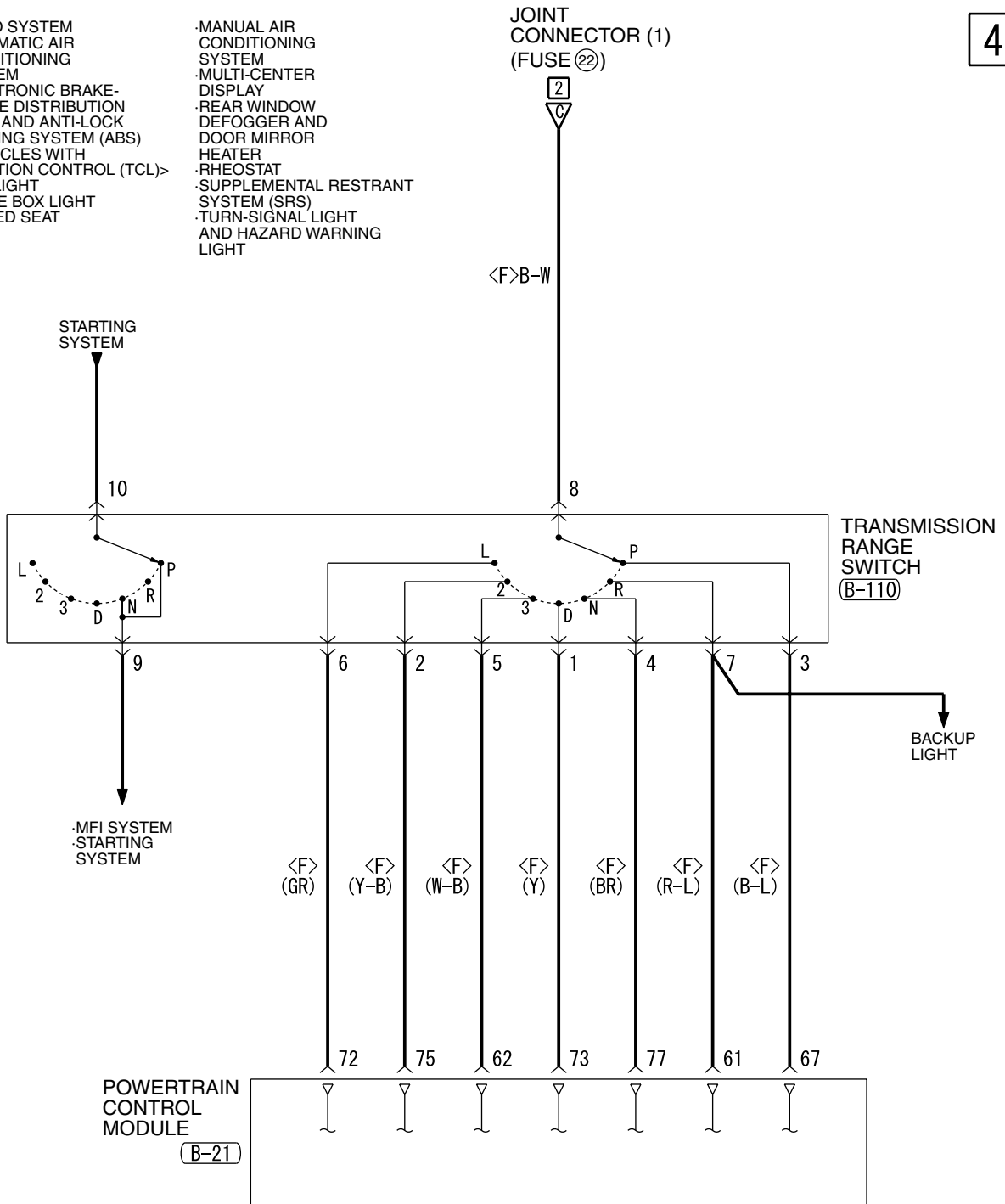

(C-211)

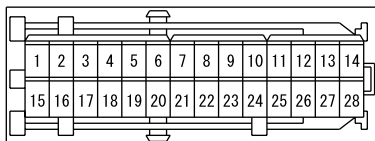

(C-214)

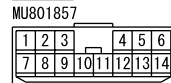

WIRE COLOR CODE

B : BLACK SB : SKY BLUE  
 BR : BROWN LG : LIGHT GREEN  
 G : GREEN P : PINK GR : GRAY  
 R : RED L : BLUE Y : YELLOW  
 V : VIOLET W : WHITE O : ORANGE

INVECS-II 4A/T <2.4L ENGINE> (CONTINUED)

5

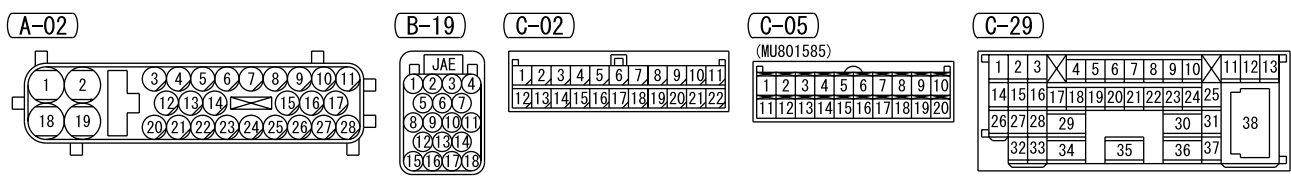
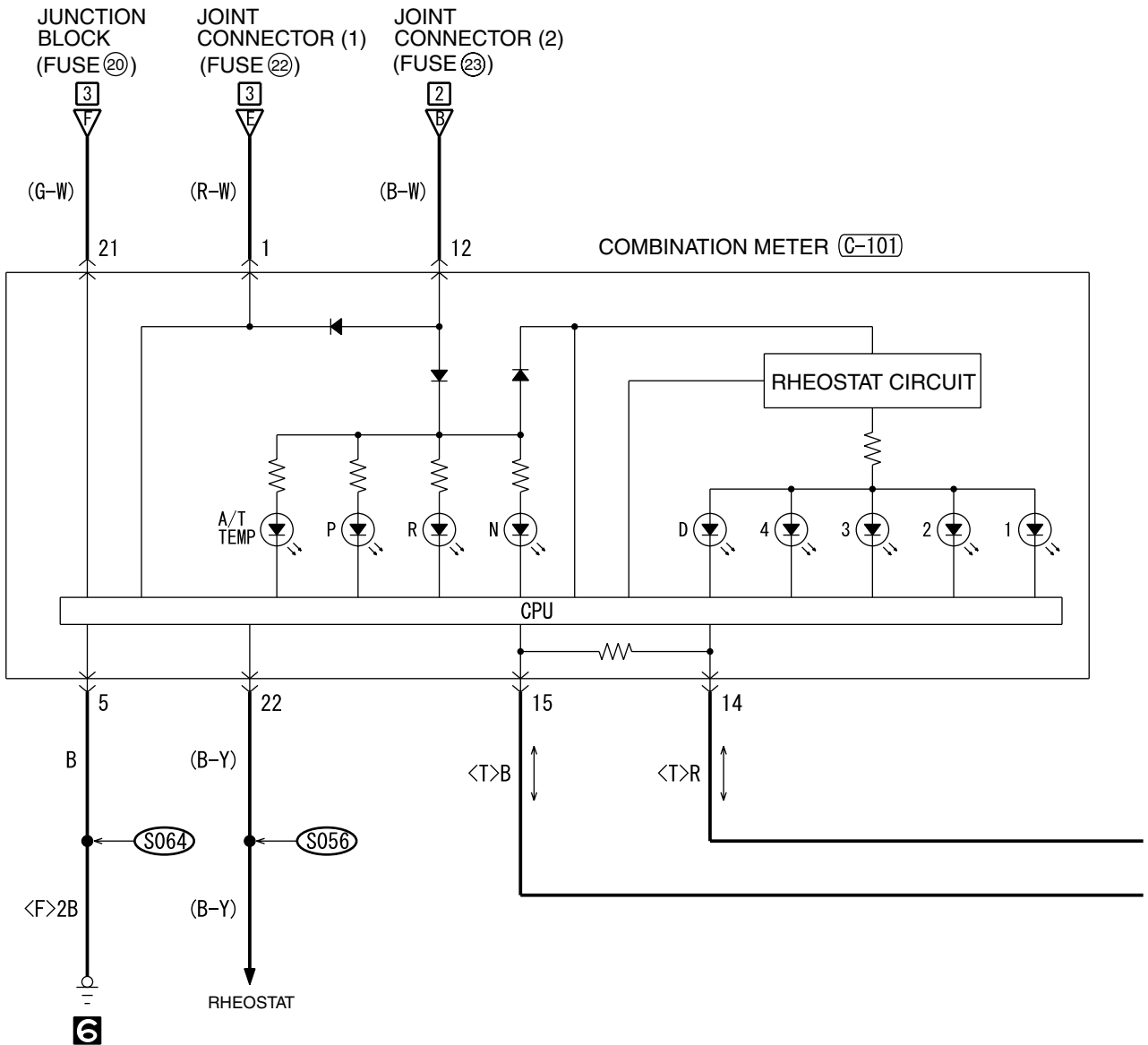

H5P07M00CA

NOTE

- \*1: WITHOUT ELECTRONIC BRAKE-FORCE DISTRIBUTION (EBD) AND ANTI-LOCK BRAKING SYSTEM (ABS)
- \*2: WITH ELECTRONIC BRAKE-FORCE DISTRIBUTION (EBD) AND ANTI-LOCK BRAKING SYSTEM (ABS)

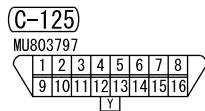
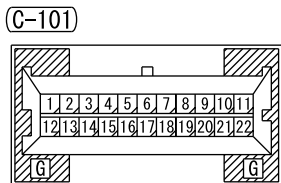
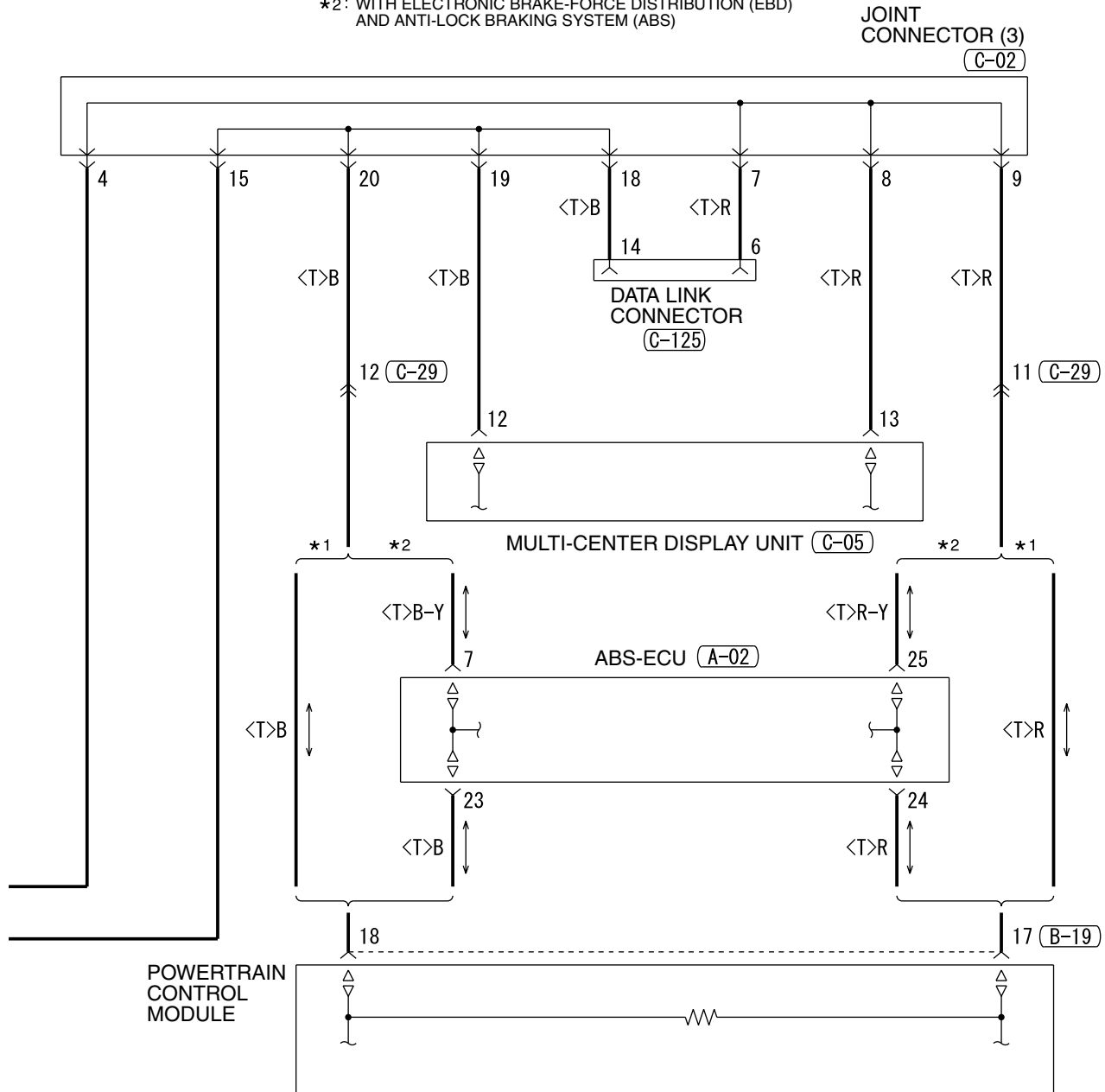

WIRE COLOR CODE  
 B : BLACK LG : LIGHT GREEN G : GREEN L : BLUE  
 BR : BROWN O : ORANGE GR : GRAY R : RED W : WHITE  
 SB : SKY BLUE P : PINK Y : YELLOW V : VIOLET

INVECS-II 4A/T <2.4L ENGINE> (CONTINUED)

7

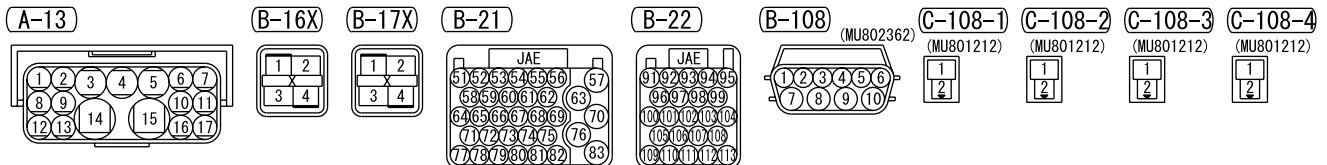
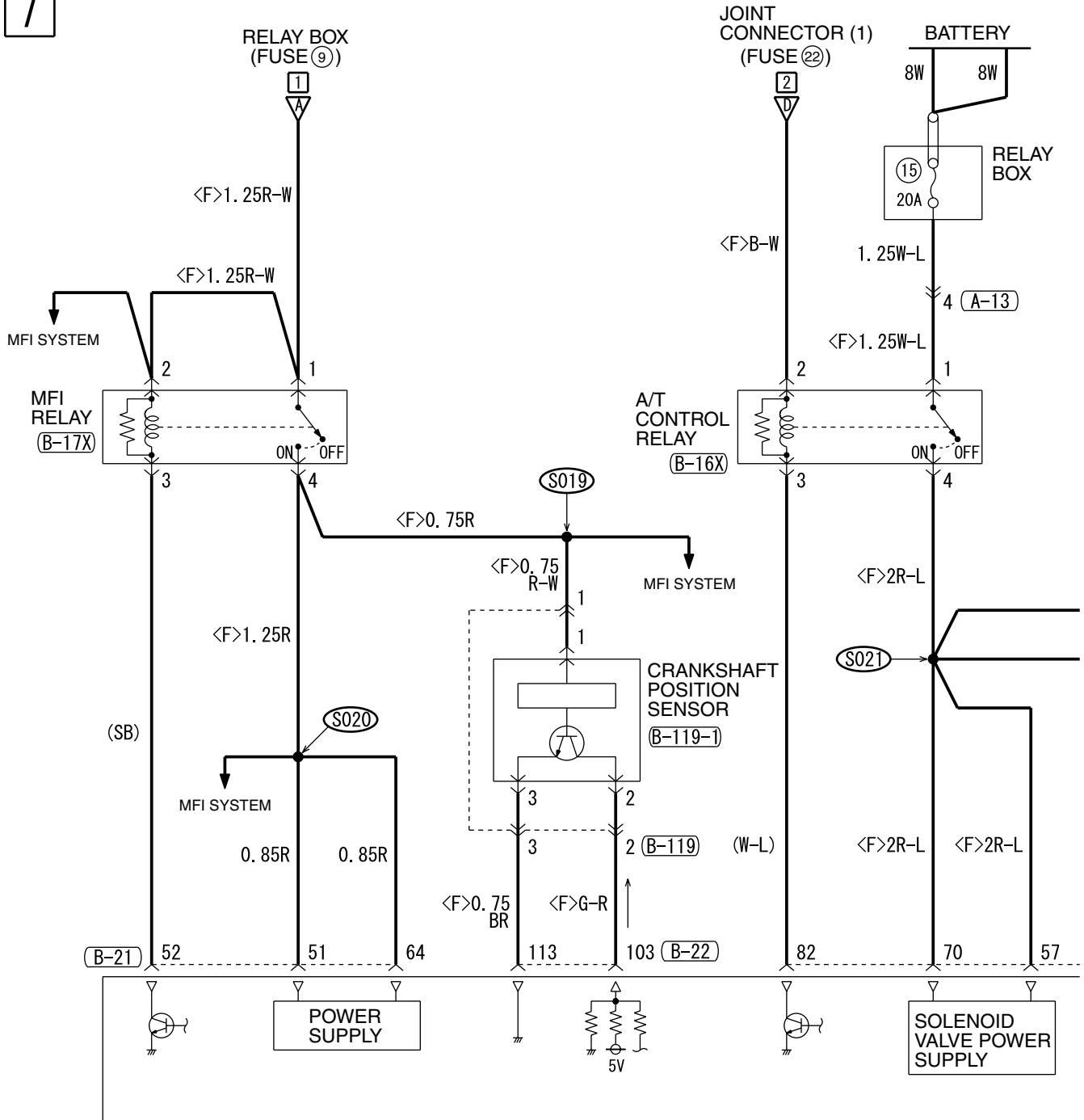



8

NOTE

- \*1: UNDERDRIVE SOLENOID VALVE
- \*2: SECOND SOLENOID VALVE
- \*3: OVERDRIVE SOLENOID VALVE
- \*4: TORQUE CONVERTER CLUTCH CONTROL SOLENOID VALVE
- \*5: LOW AND REVERSE SOLENOID VALVE

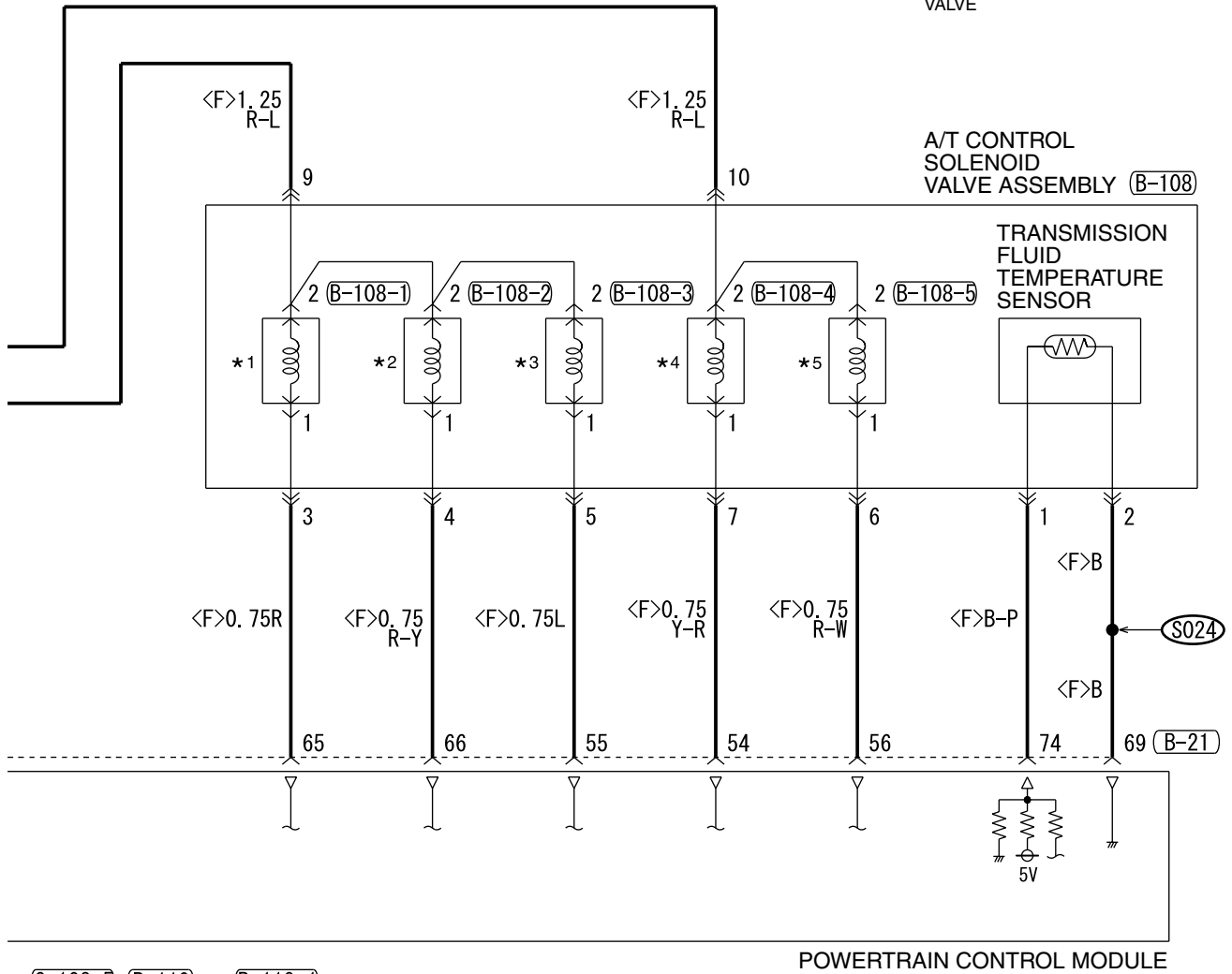

WIRE COLOR CODE

B : BLACK   LG : LIGHT GREEN   G : GREEN   L : BLUE   W : WHITE   Y : YELLOW  
SB : SKY BLUE   BR : BROWN   O : ORANGE   GR : GRAY   R : RED   P : PINK   V : VIOLET

INVECS-II 4A/T <2.4L ENGINE> (CONTINUED)

9

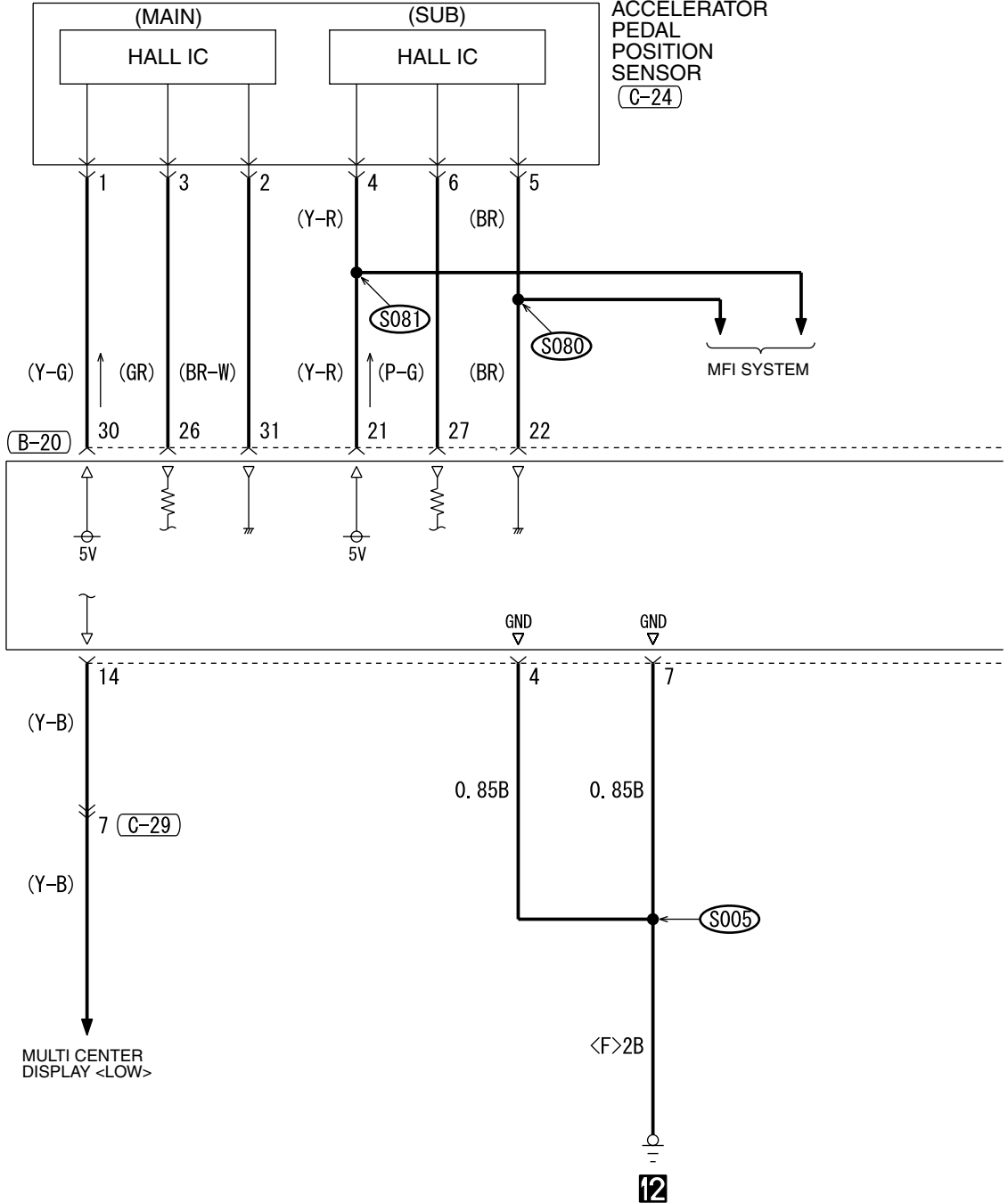

B-19

B-20

C-24

C-29

C-125

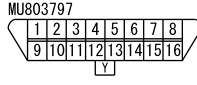
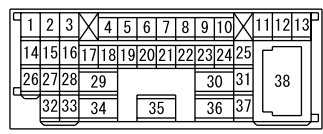
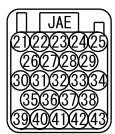
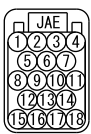

10

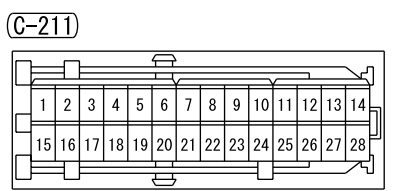
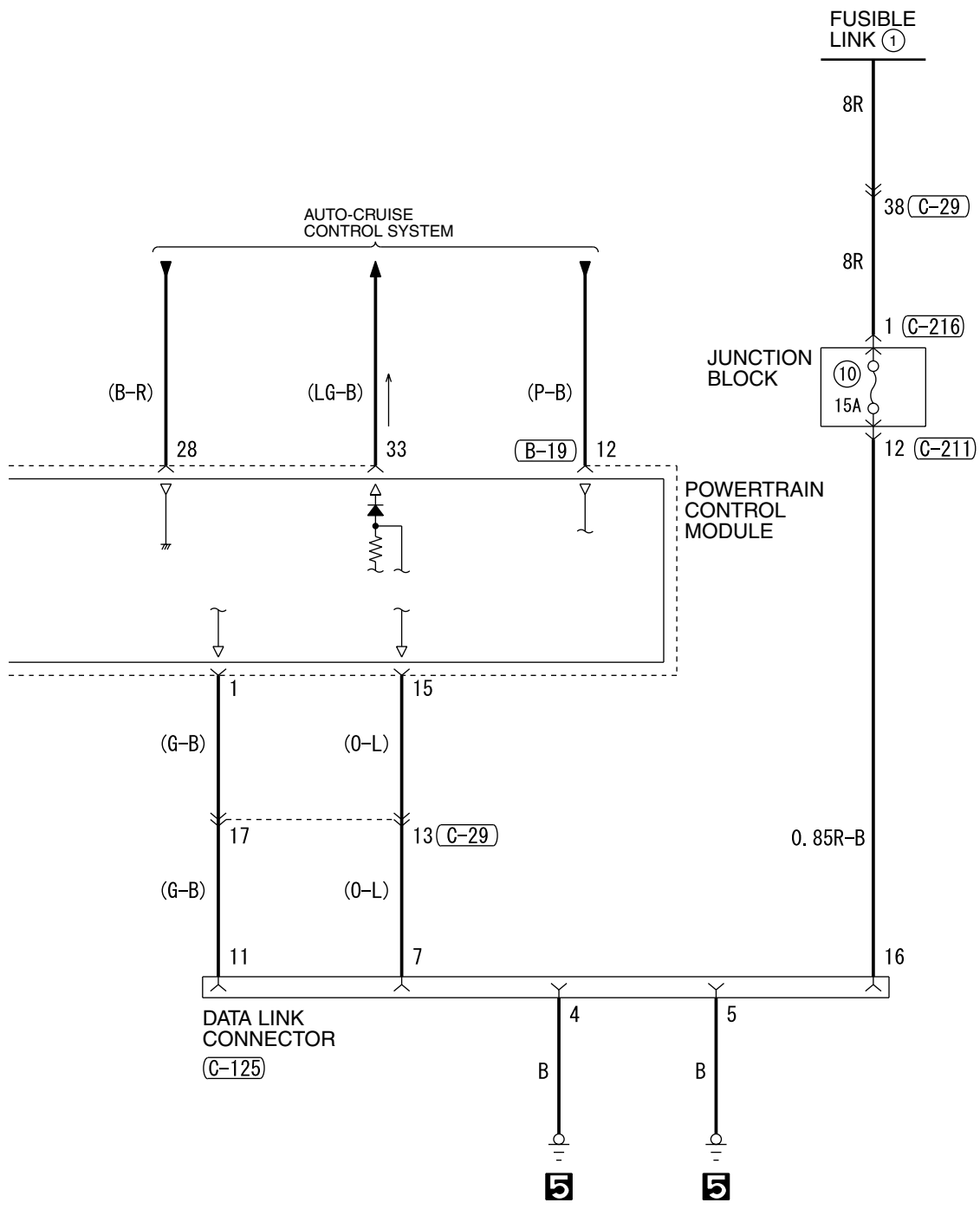

WIRE COLOR CODE  
 B : BLACK LG : LIGHT GREEN G : GREEN L : BLUE  
 BR : BROWN O : ORANGE GR : GRAY R : RED W : WHITE  
 SB : SKY BLUE P : PINK Y : YELLOW V : VIOLET

INVECS-II 4A/T <3.8L ENGINE>

M1901016201305

1

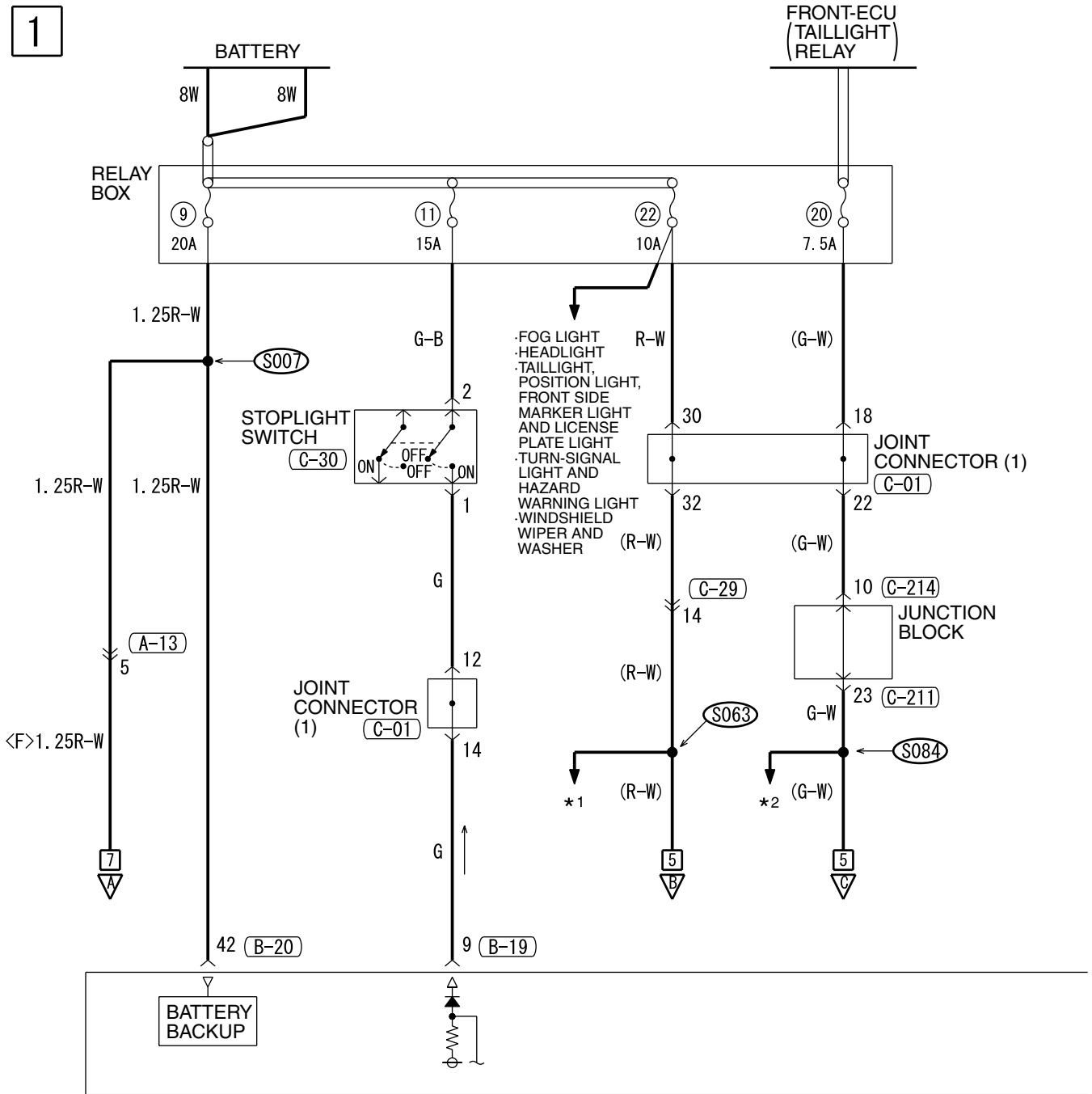

(A-13)

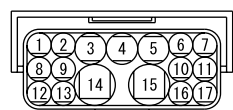

(B-19)



(B-20)

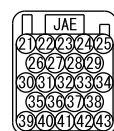

(B-22)



(B-107)



(B-109)



(C-01)

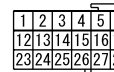

(C-03)

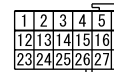

H5P07M01AA

NOTE

- \*1 : AUDIO SYSTEM  
 .AUTOMATIC AIR CONDITIONING SYSTEM  
 .CONTROLLER AREA NETWORK (CAN)  
 .FOG LIGHT  
 .FRONT DOME LIGHT, REAR DOME LIGHT, TRUNK LIGHT AND IGNITION KEY HOLE ILLUMINATION LIGHT  
 .HEADLIGHT  
 .MANUAL AIR CONDITIONING SYSTEM  
 .MULTI-CENTER DISPLAY  
 .TAILLIGHT, POSITION LIGHT, FRONT SIDE MARKER LIGHT AND LICENSE PLATE LIGHT  
 .TURN-SIGNAL LIGHT AND HAZARD WARNING LIGHT  
 .VANITY MIRROR LIGHT  
 .WINDSHIELD WIPER AND WASHER

- \*2 : AUDIO SYSTEM  
 .AUTOMATIC AIR CONDITIONING SYSTEM  
 .ELECTRONIC BRAKE-FORCE DISTRIBUTION (EBD) AND ANTI-LOCK BRAKING SYSTEM (ABS) <VEHICLES WITH TRACTION CONTROL (TCL)>  
 .FOG LIGHT  
 .GLOVE BOX LIGHT  
 .HEATED SEAT  
 .MANUAL AIR CONDITIONING SYSTEM  
 .MULTI-CENTER DISPLAY  
 .REAR WINDOW DEFOGGER AND DOOR MIRROR HEATER  
 .RHEOSTAT  
 .SUPPLEMENTAL RESISTANT SYSTEM (SRS)  
 .TURN-SIGNAL LIGHT AND HAZARD WARNING LIGHT

2

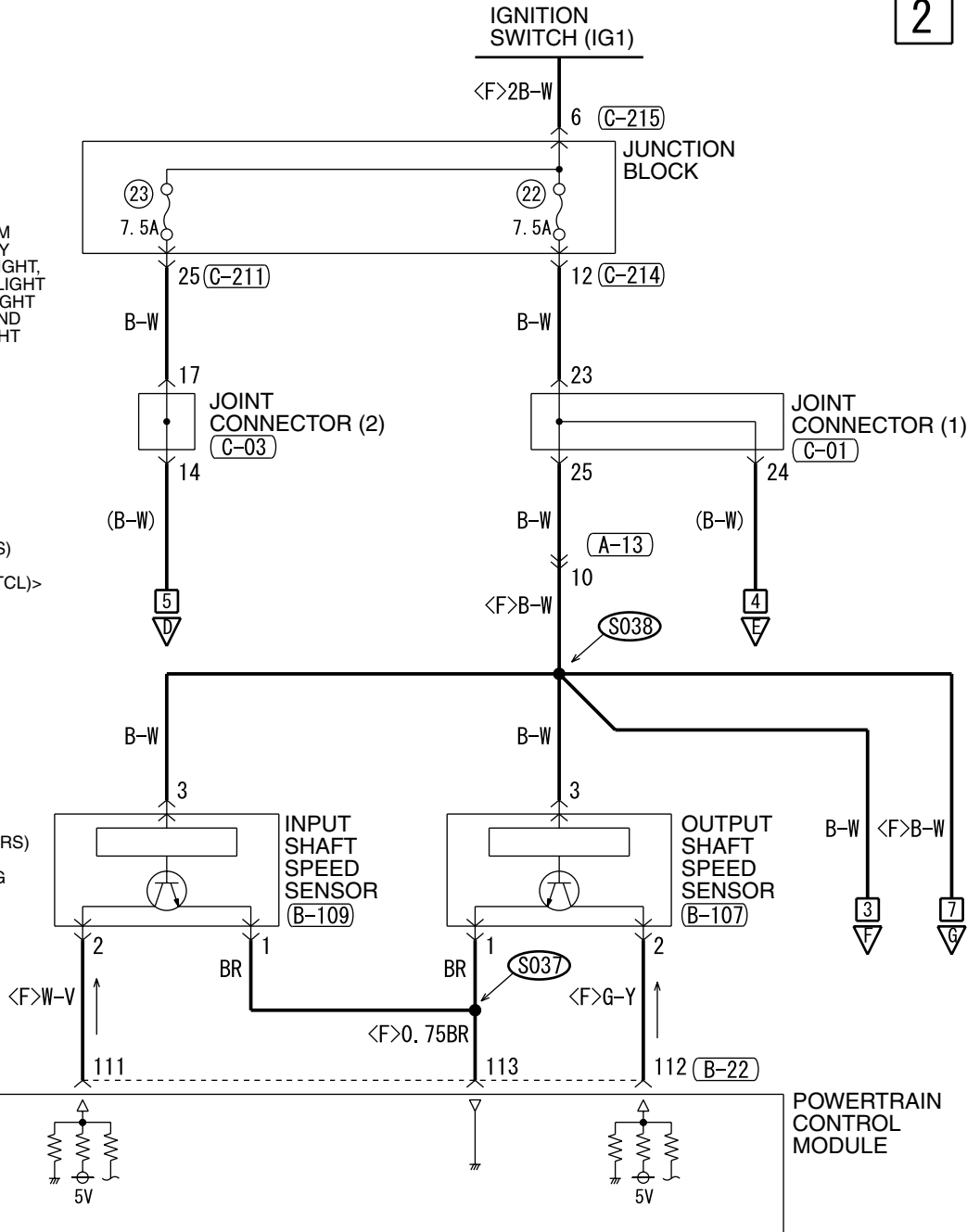

(C-29)

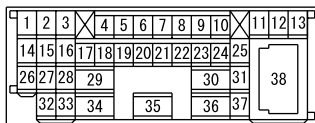

(C-30)



(C-211)

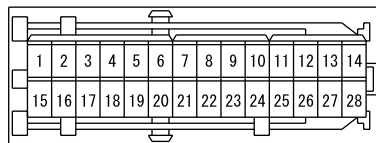

(C-214)

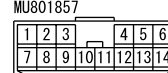

(C-215)



INVECS-II 4A/T <3.8L ENGINE> (CONTINUED)

3

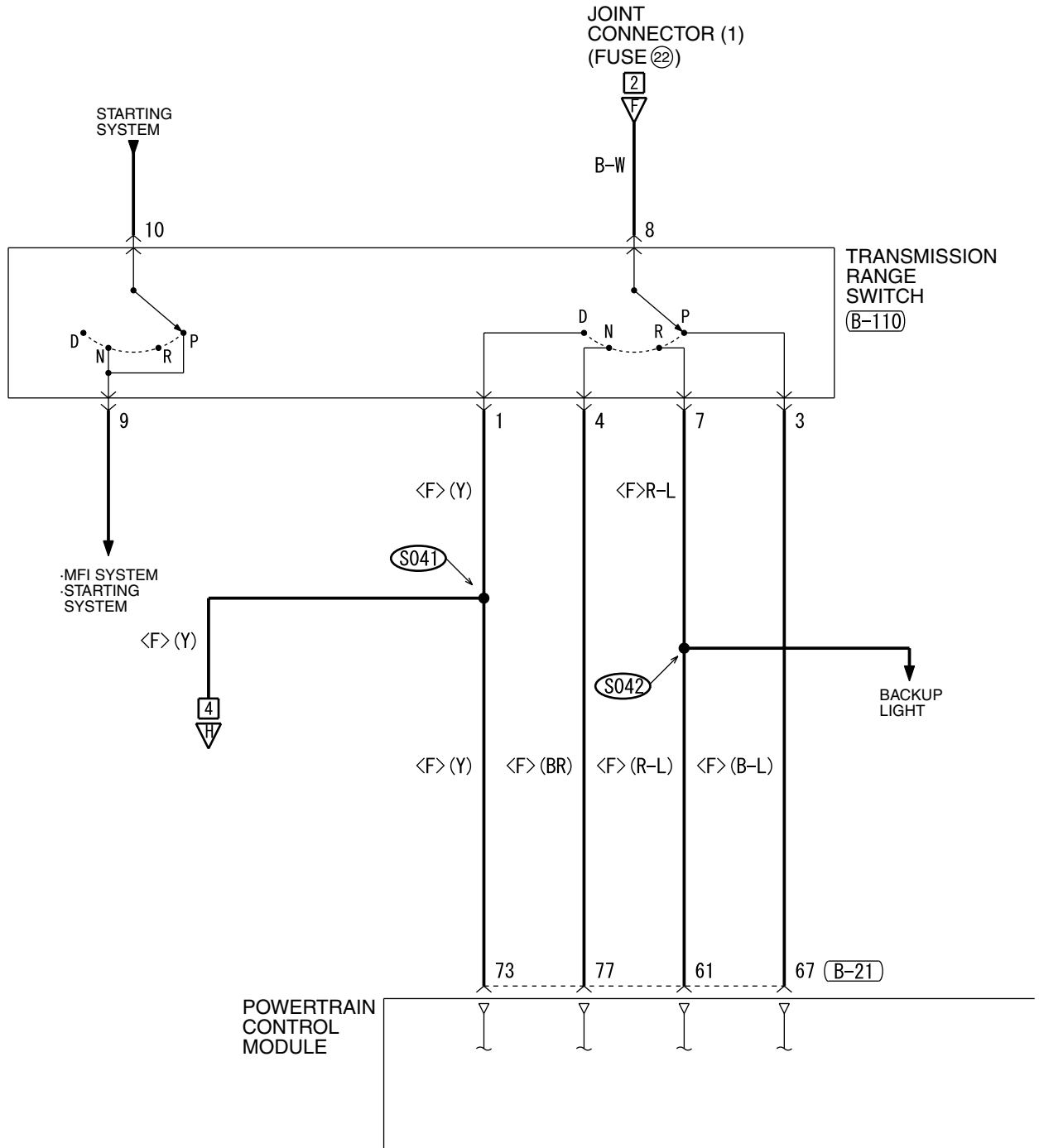

(A-13)

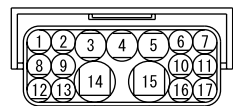

(B-20)

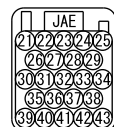

(B-21)

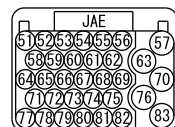

(B-110)

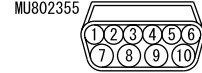

(C-20)



4

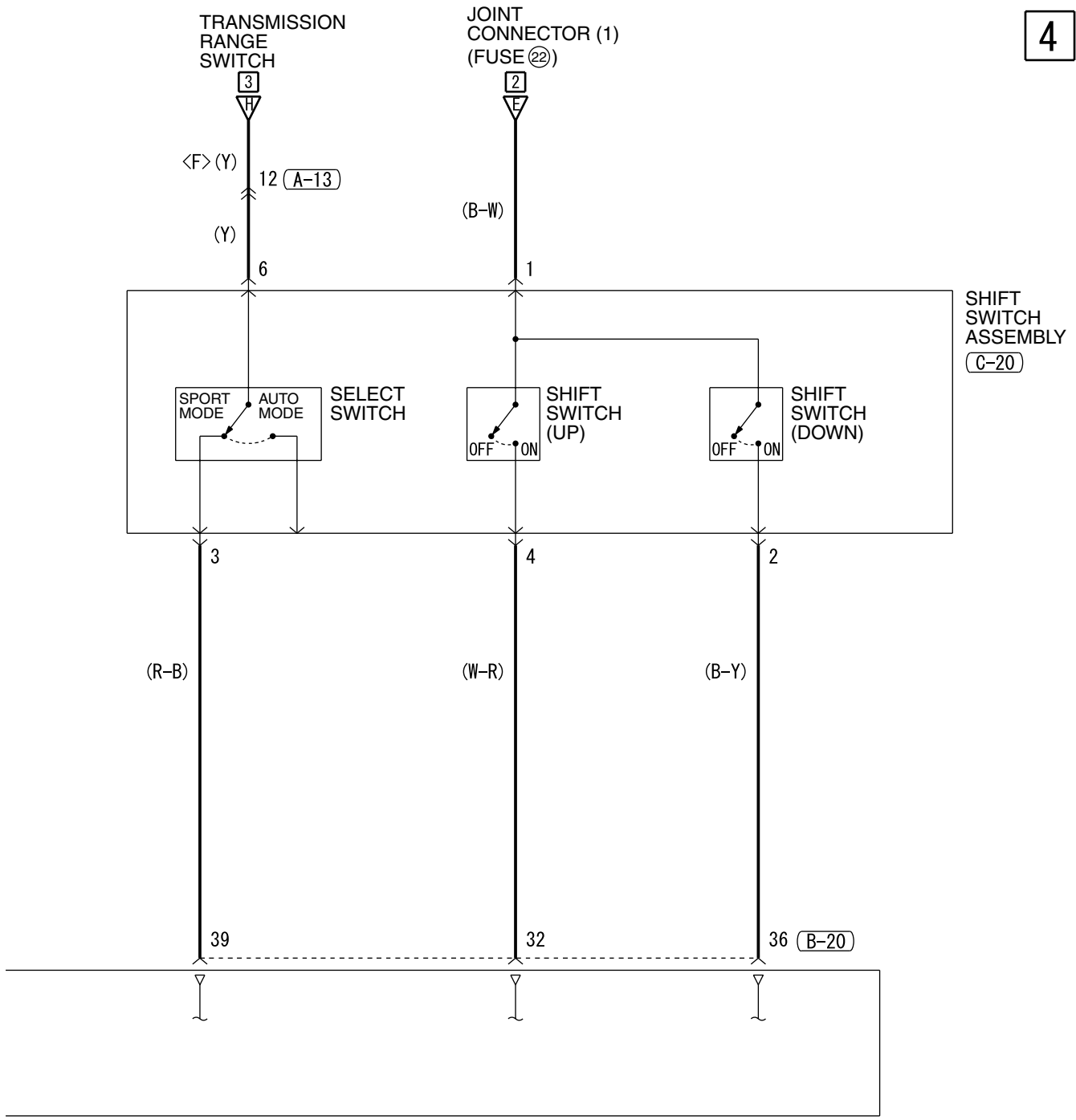

WIRE COLOR CODE  
 B : BLACK LG : LIGHT GREEN G : GREEN L : BLUE W : WHITE Y : YELLOW  
 SB : SKY BLUE BR : BROWN O : ORANGE GR : GRAY R : RED P : PINK V : VIOLET

H5P07M01BB

TSB Revision

INVECS-II 4A/T <3.8L ENGINE> (CONTINUED)

5

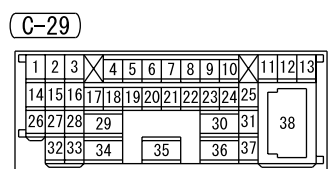
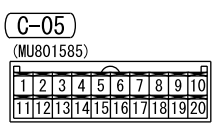
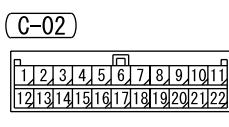
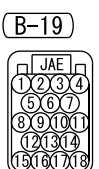
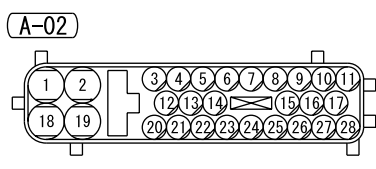
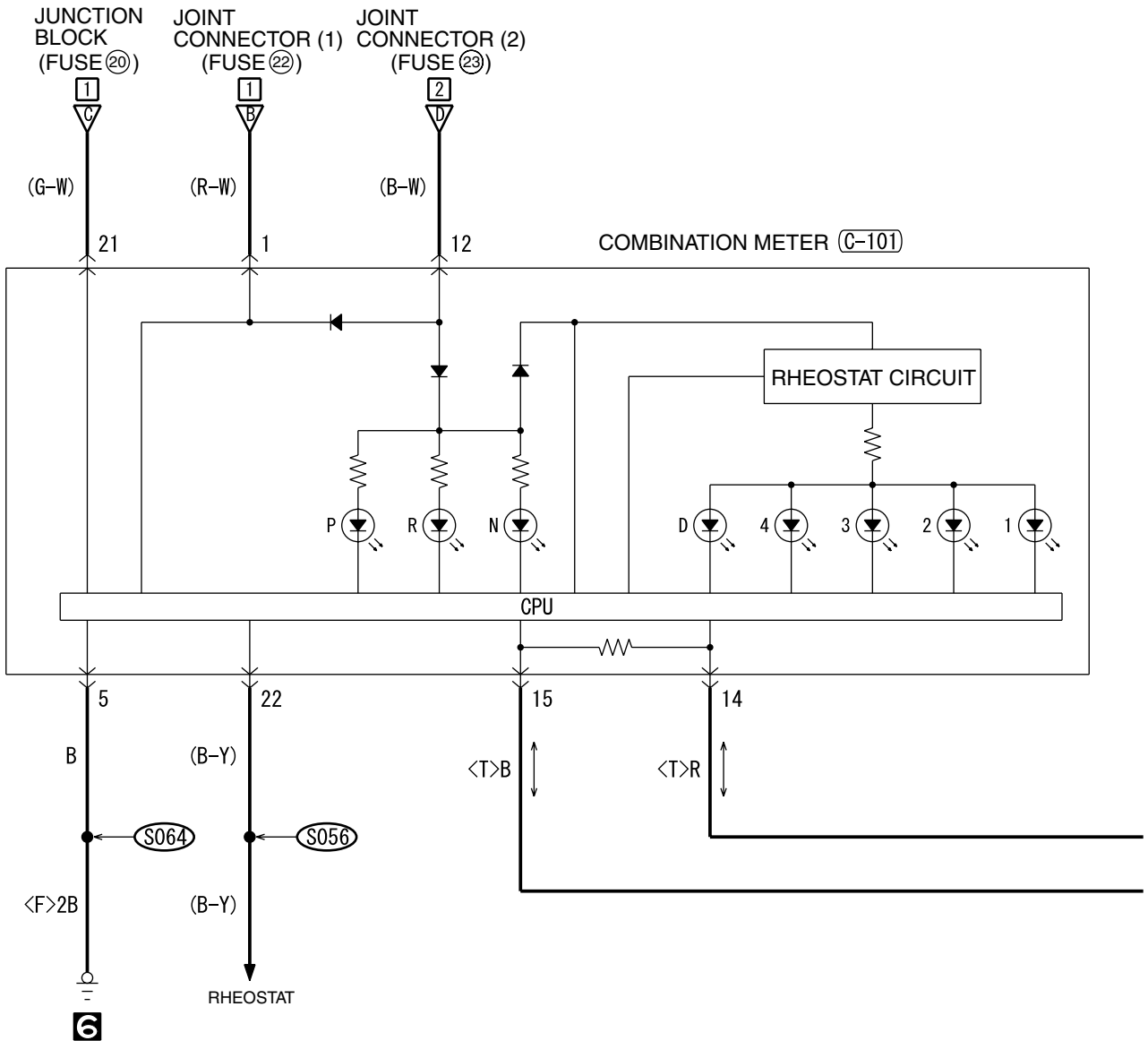



6

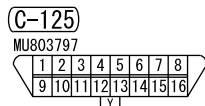
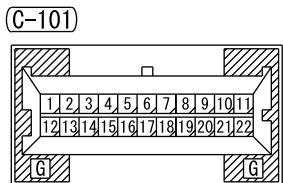
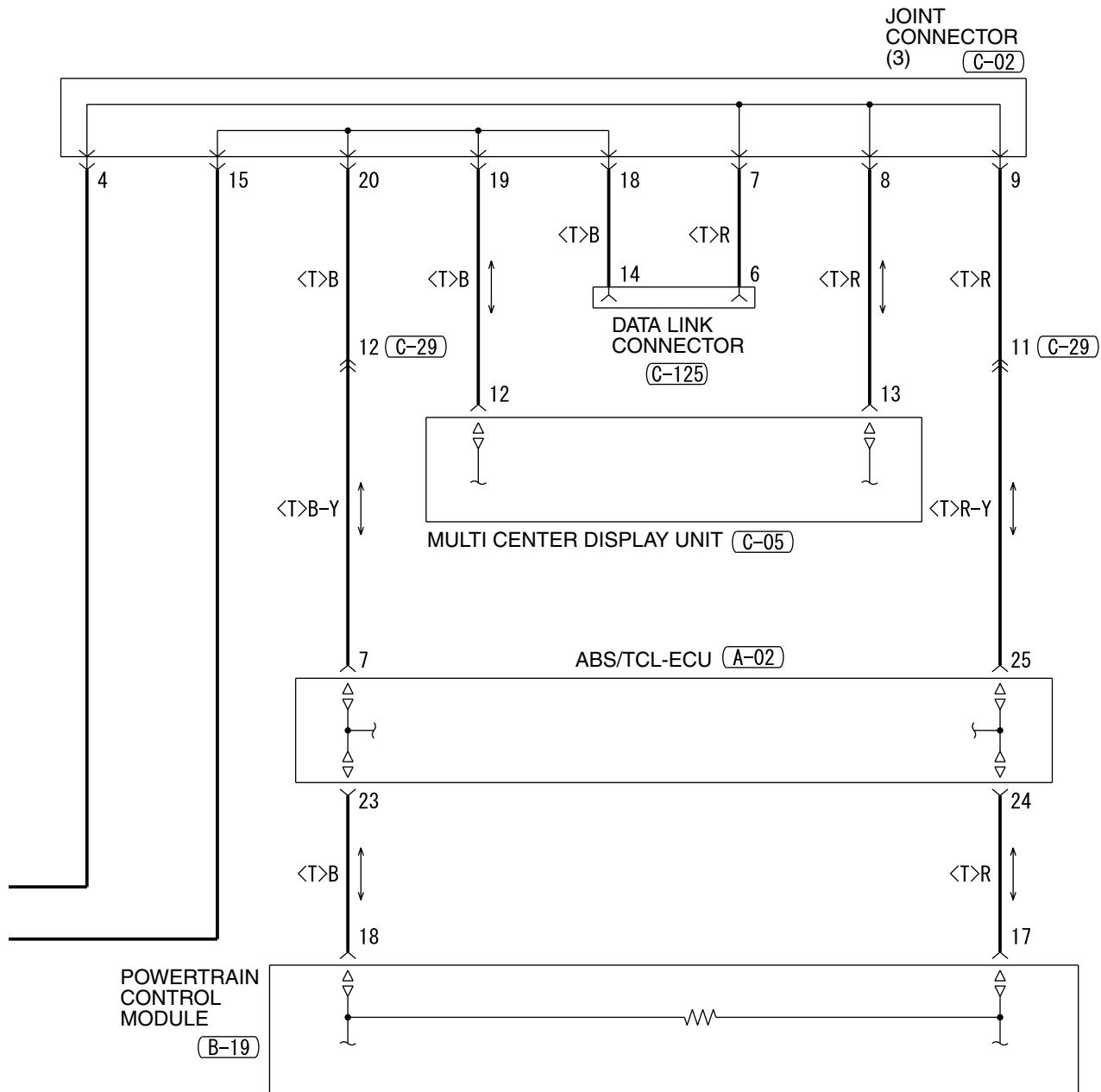

WIRE COLOR CODE  
 B: BLACK LG: LIGHT GREEN G: GREEN L: BLUE  
 BR: BROWN O: ORANGE GR: GRAY R: RED W: WHITE  
 SB: SKY BLUE P: PINK Y: YELLOW V: VIOLET

H5P07M01CB

TSB Revision

INVECS-II 4A/T <3.8L ENGINE> (CONTINUED)

7

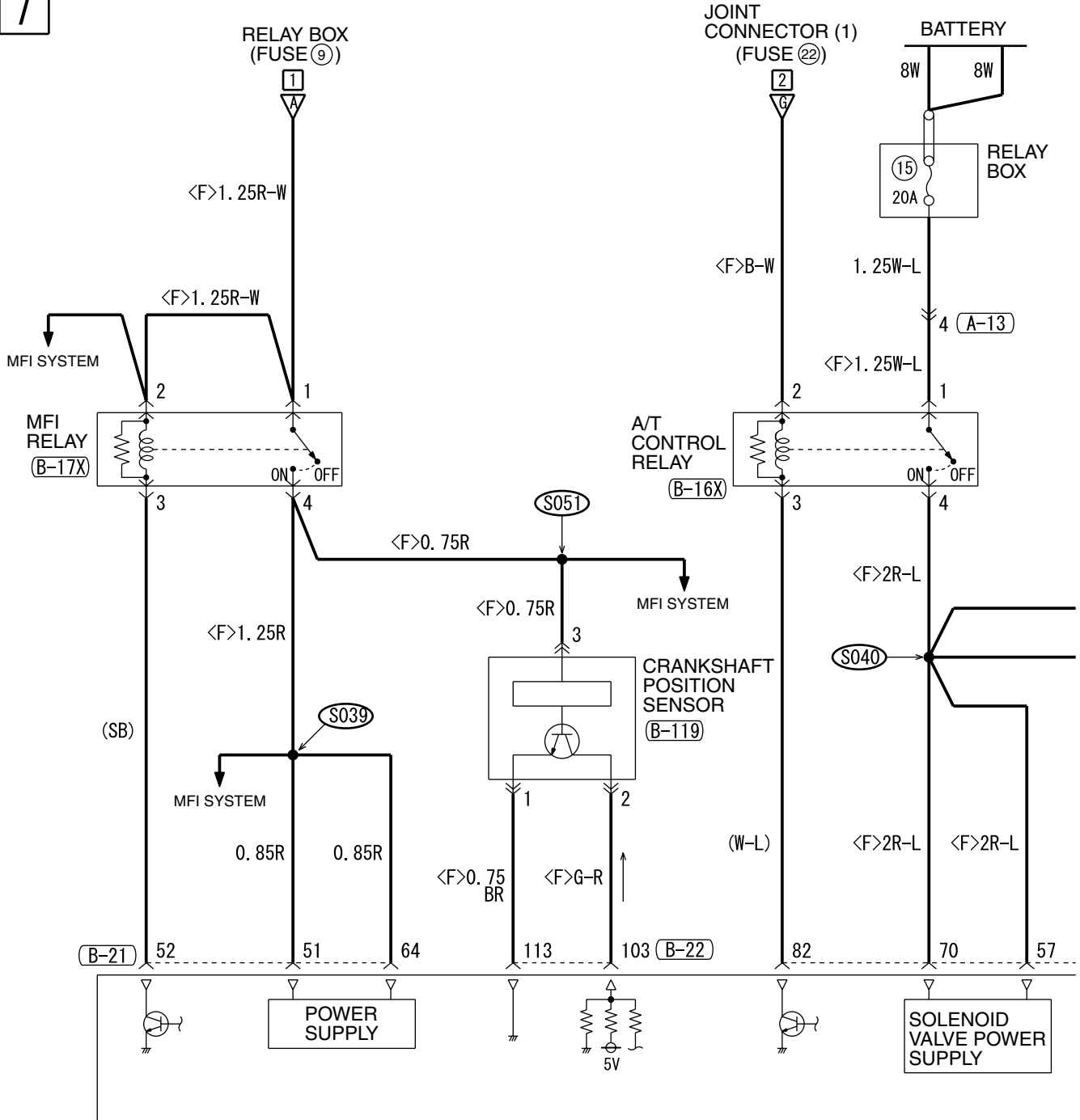

(A-13)

(B-16X)

(B-17X)

(B-21)

(B-22)

(B-119)

(B-108)

(C-108-1)

(C-108-2)

(C-108-3)

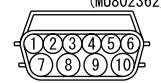
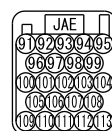
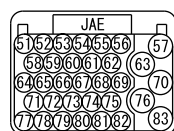
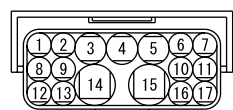

8

- NOTE
- \*1: UNDERDRIVE SOLENOID VALVE
  - \*2: SECOND SOLENOID VALVE
  - \*3: OVERDRIVE SOLENOID VALVE
  - \*4: TORQUE CONVERTER CLUTCH CONTROL SOLENOID VALVE
  - \*5: LOW AND REVERSE SOLENOID VALVE

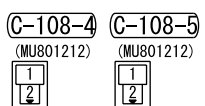
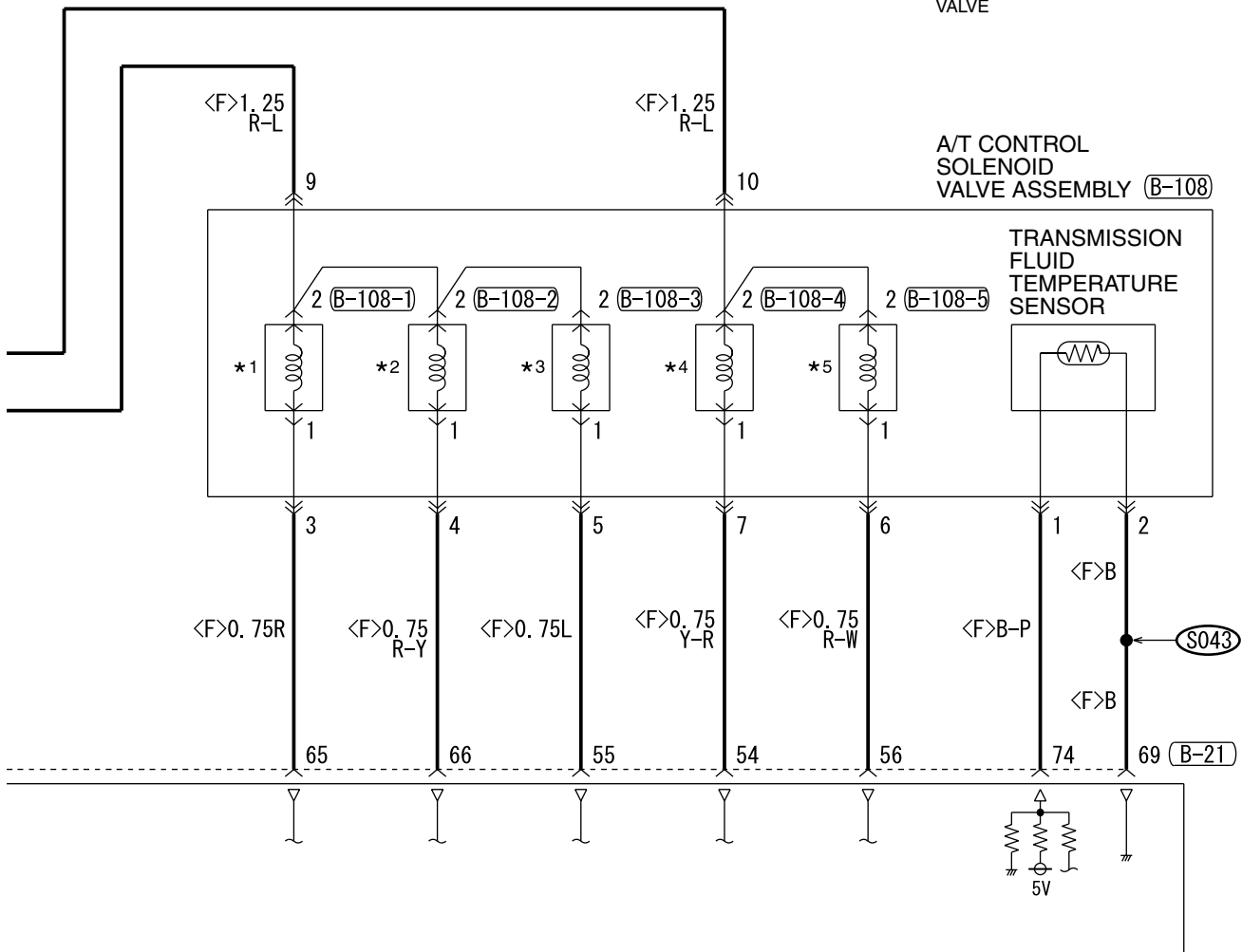

WIRE COLOR CODE  
 B : BLACK   LG : LIGHT GREEN   G : GREEN   L : BLUE   W : WHITE   Y : YELLOW  
 SB : SKY BLUE   BR : BROWN   O : ORANGE   GR : GRAY   R : RED   P : PINK   V : VIOLET

POWERTRAIN CONTROL MODULE

TSB Revision

INVECS-II 4A/T <3.8L ENGINE> (CONTINUED)

9

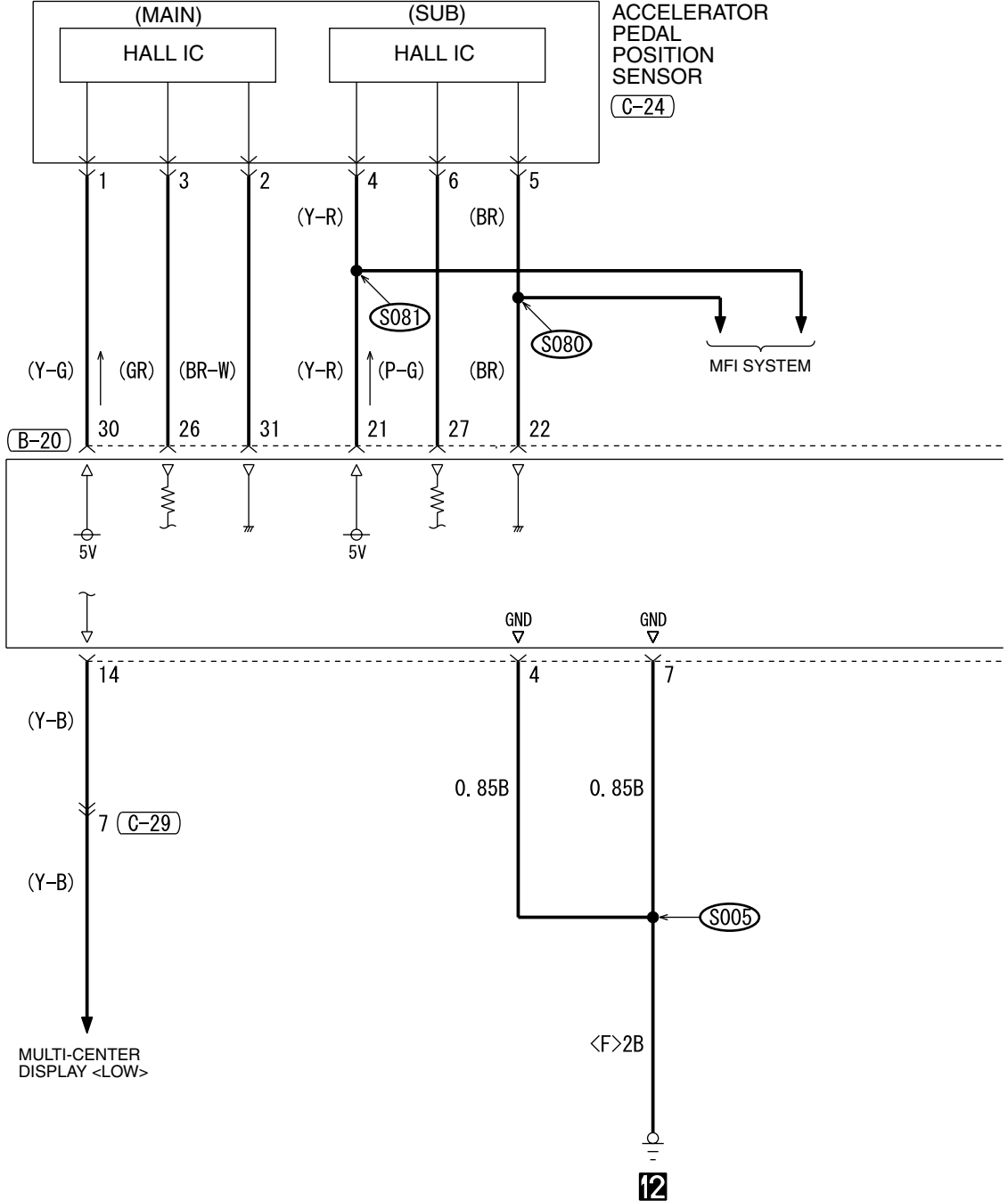

B-19

B-20

C-24

C-29

C-125

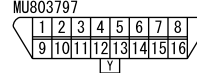
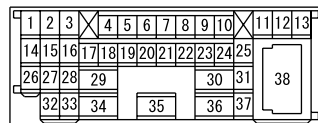
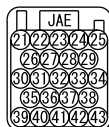
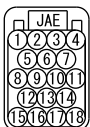

10

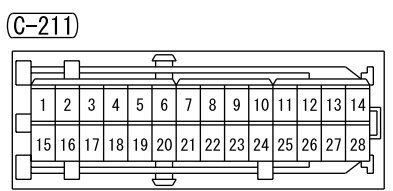
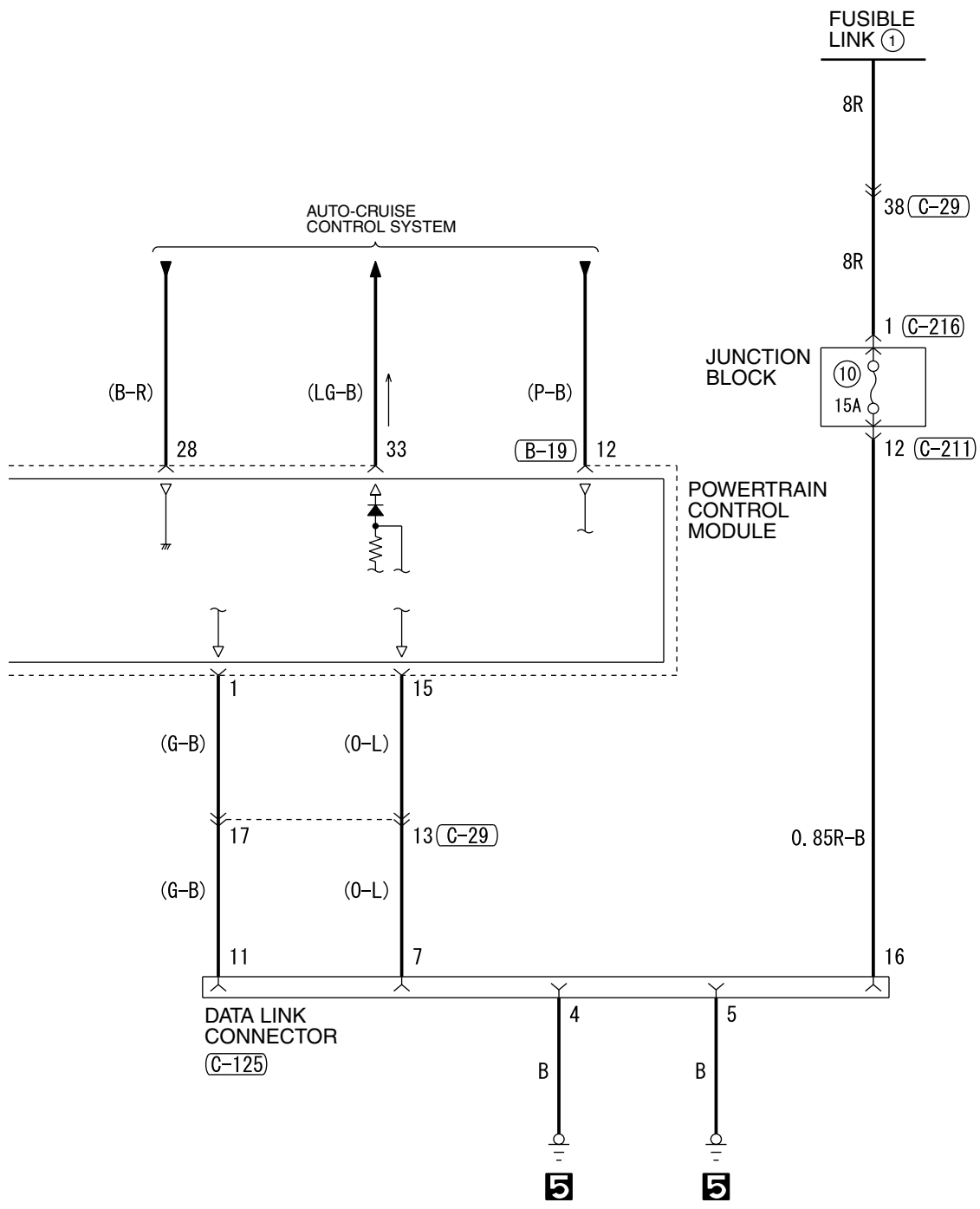

**WIRE COLOR CODE**  
 B : BLACK    LG : LIGHT GREEN    G : GREEN    L : BLUE  
 BR : BROWN    O : ORANGE    GR : GRAY    R : RED    W : WHITE  
 SB : SKY BLUE    P : PINK    Y : YELLOW    V : VIOLET

HEADLIGHT <2-BULB TYPE>

M1901001501355

1

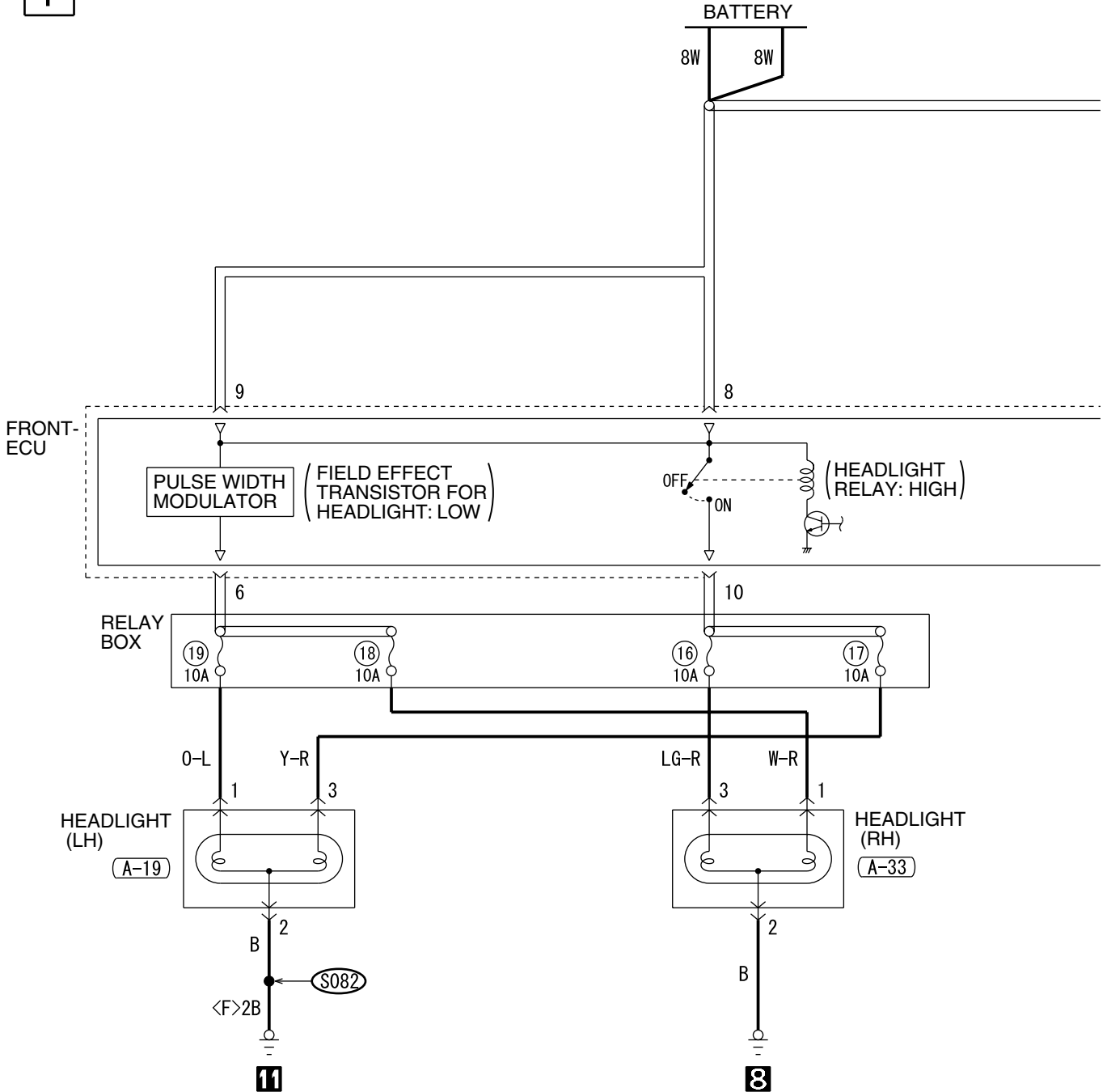

(A-11X)

1	2	3	4	5	6	7	8	9	10	11
---	---	---	---	---	---	---	---	---	----	----

(A-12X)

21	22	23	24	25	26	27	28	29	30	31
----	----	----	----	----	----	----	----	----	----	----

(A-19)

1	2	3
---	---	---

(A-33)

1	2	3
---	---	---

(C-01)

1	2	3	4	5	6	7	8	9	10	11
12	13	14	15	16	17	18	19	20	21	22
23	24	25	26	27	28	29	30	31	32	33

(C-29)

1	2	3	4	5	6	7	8	9	10	11	12	13
14	15	16	17	18	19	20	21	22	23	24	25	
26	27	28	29			30	31				38	
32	33	34		35		36	37					

H5P08M00AA

TSB Revision

2

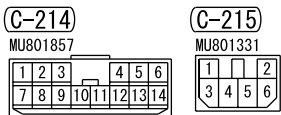
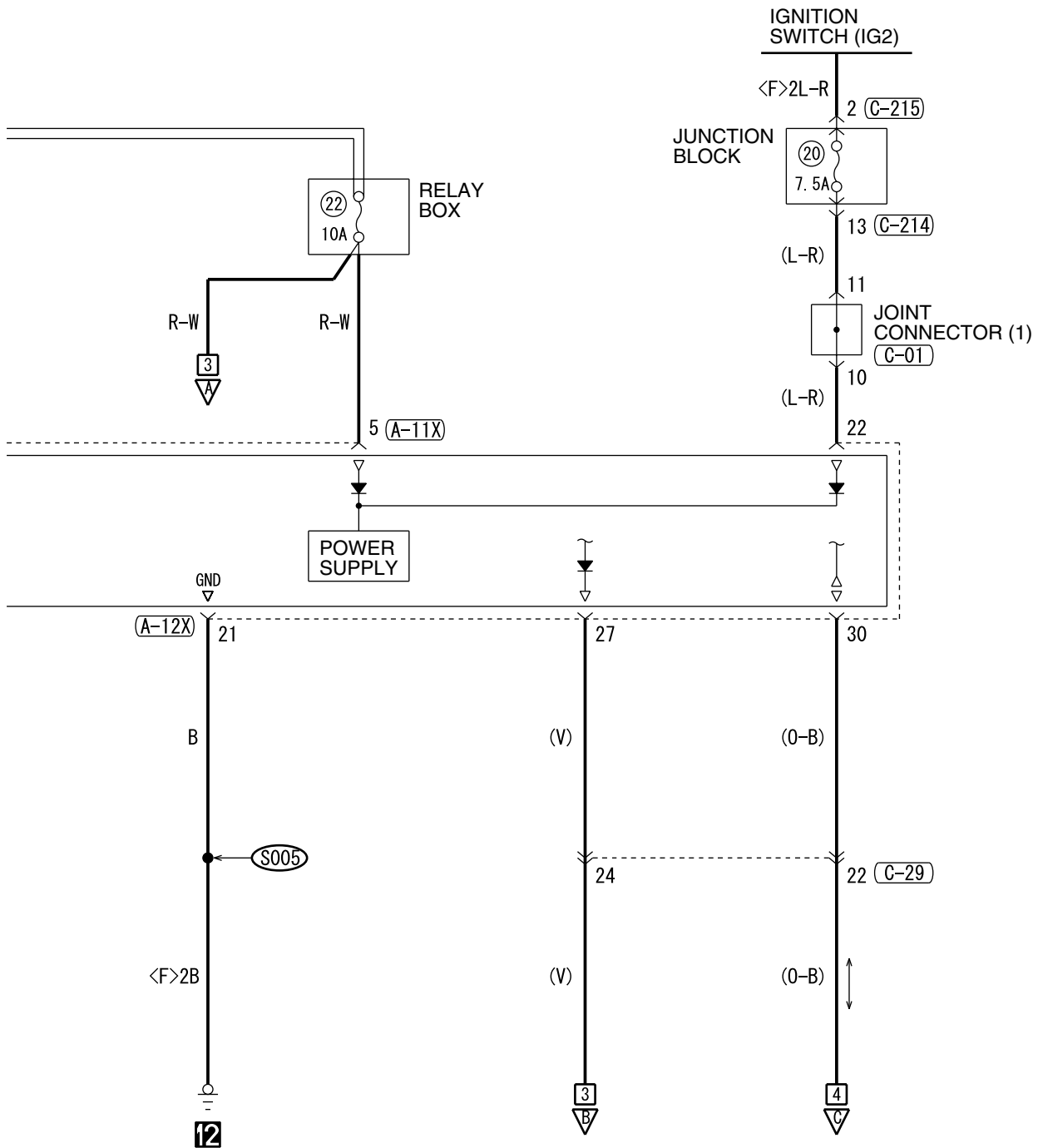

WIRE COLOR CODE  
 B : BLACK LG : LIGHT GREEN G : GREEN L : BLUE W : WHITE Y : YELLOW  
 SB : SKY BLUE BR : BROWN O : ORANGE GR : GRAY R : RED P : PINK V : VIOLET

H5P08M00AB

TSB Revision

HEADLIGHT <2-BULB TYPE> (CONTINUED)

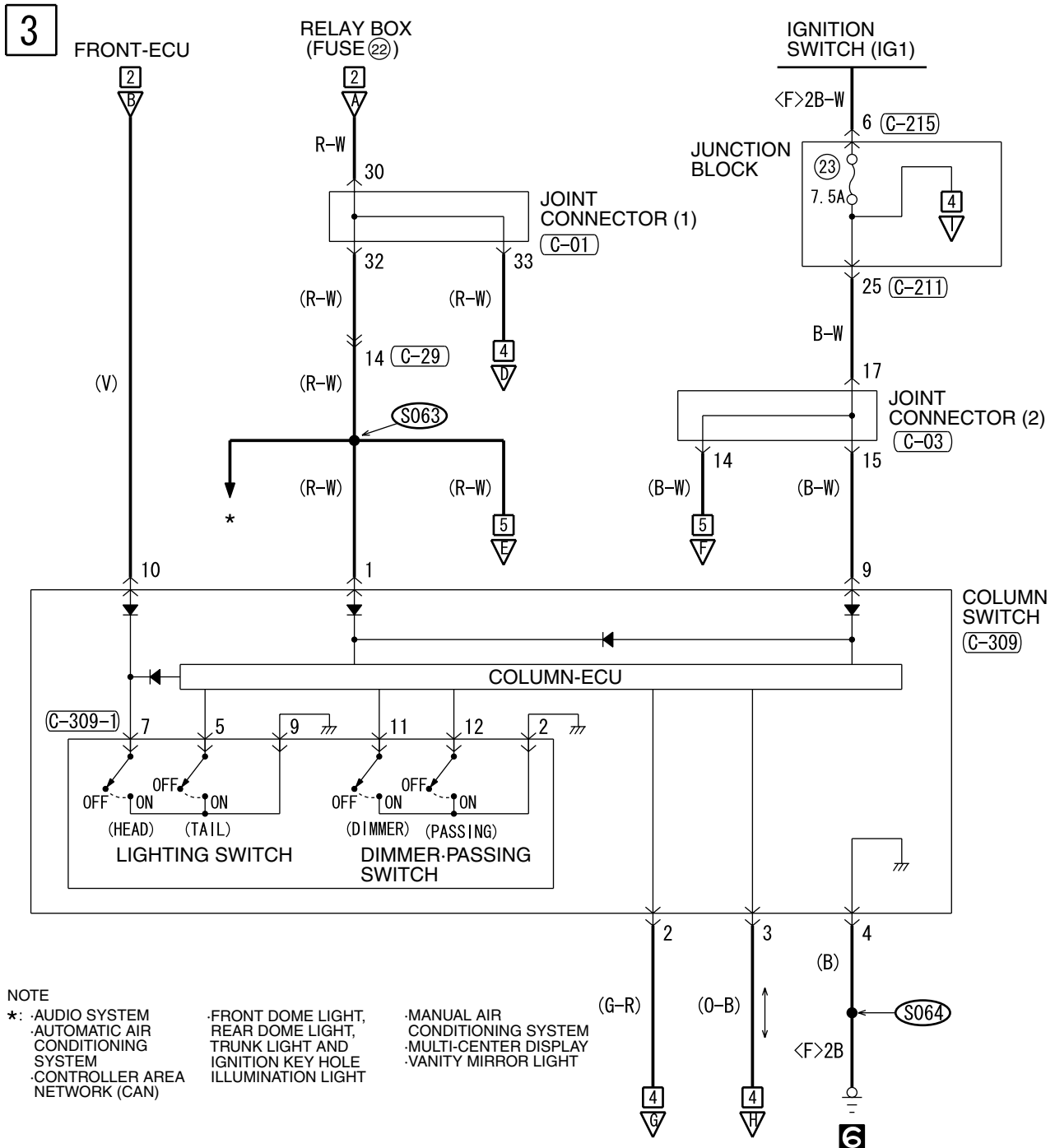

NOTE  
 \*: AUDIO SYSTEM  
 -AUTOMATIC AIR CONDITIONING SYSTEM  
 -CONTROLLER AREA NETWORK (CAN)  
 -FRONT DOME LIGHT, REAR DOME LIGHT, TRUNK LIGHT AND IGNITION KEY HOLE ILLUMINATION LIGHT  
 -MANUAL AIR CONDITIONING SYSTEM  
 -MULTI-CENTER DISPLAY  
 -VANITY MIRROR LIGHT

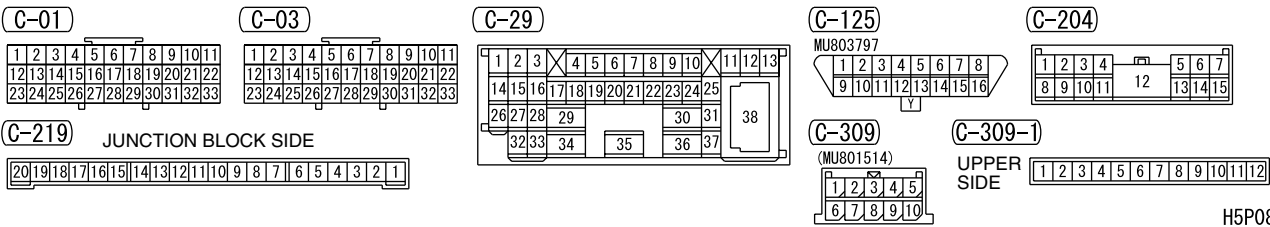



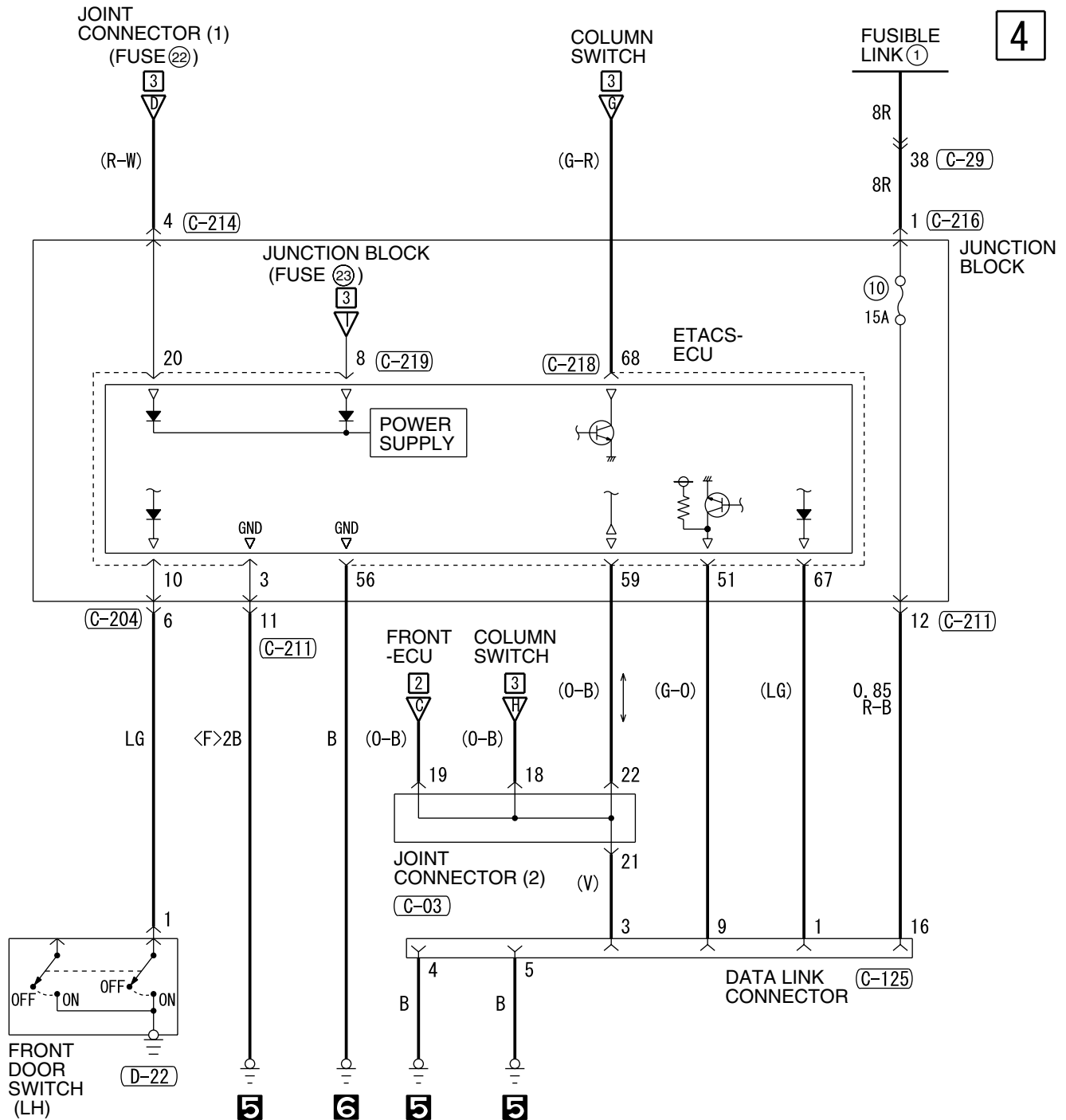

4

(C-211)

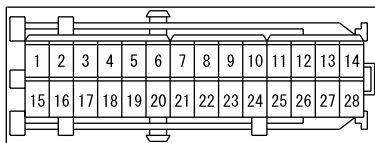

(C-214)

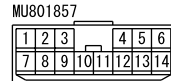

(C-215)



(C-216)



(C-218)

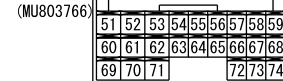

(D-22)



HEADLIGHT <2-BULB TYPE> (CONTINUED)

5

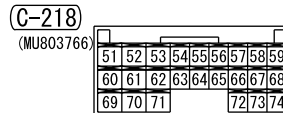
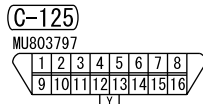
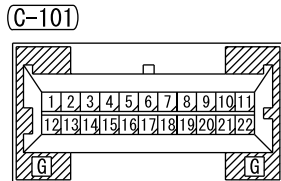
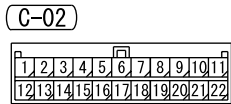
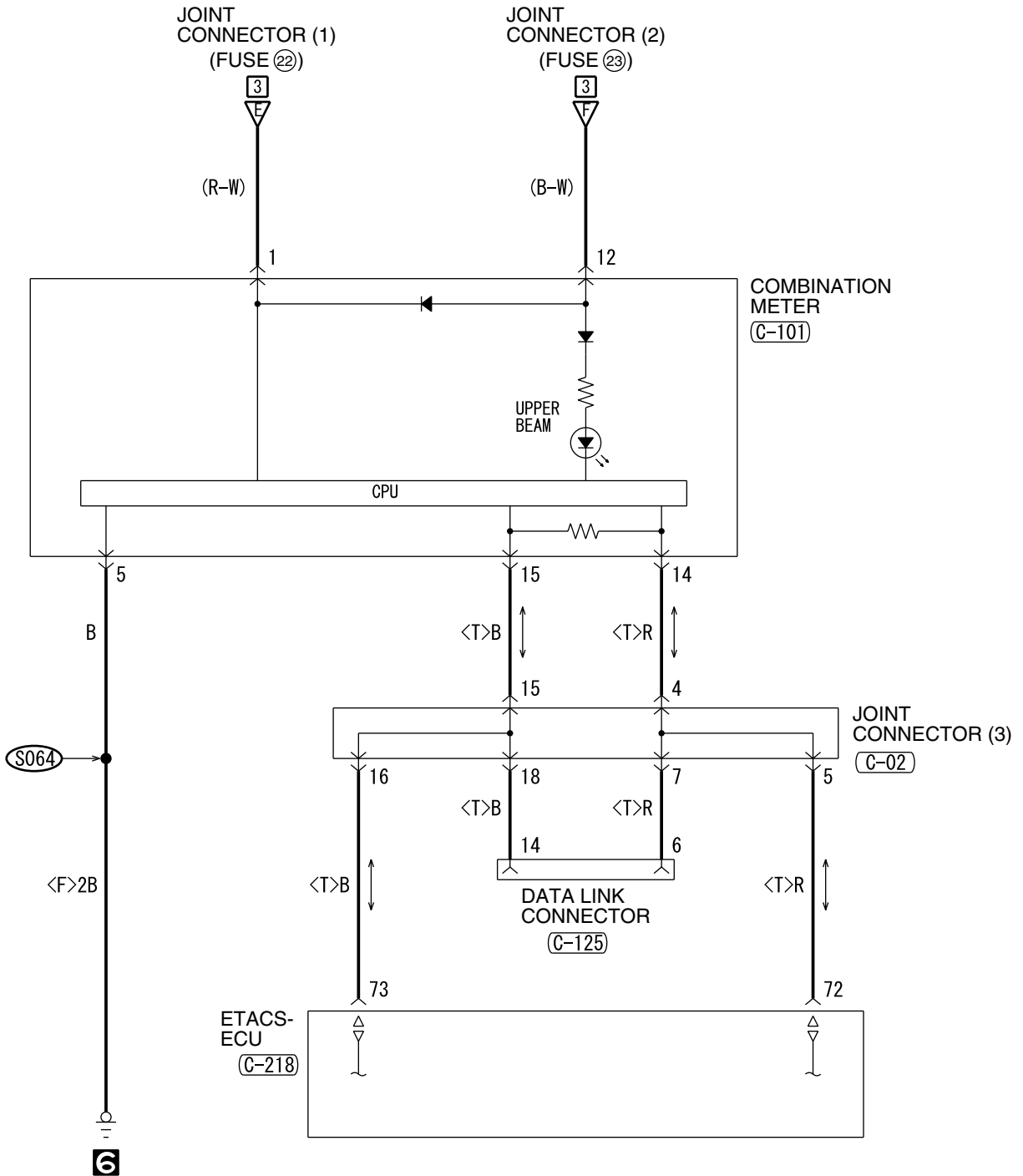

WIRE COLOR CODE

B : BLACK LG : LIGHT GREEN G : GREEN L : BLUE  
BR : BROWN O : ORANGE GR : GRAY R : RED W : WHITE  
SB : SKY BLUE P : PINK Y : YELLOW V : VIOLET H5P08M00CA

NOTES

HEADLIGHT <4-BULB TYPE>

M1901001501366

1

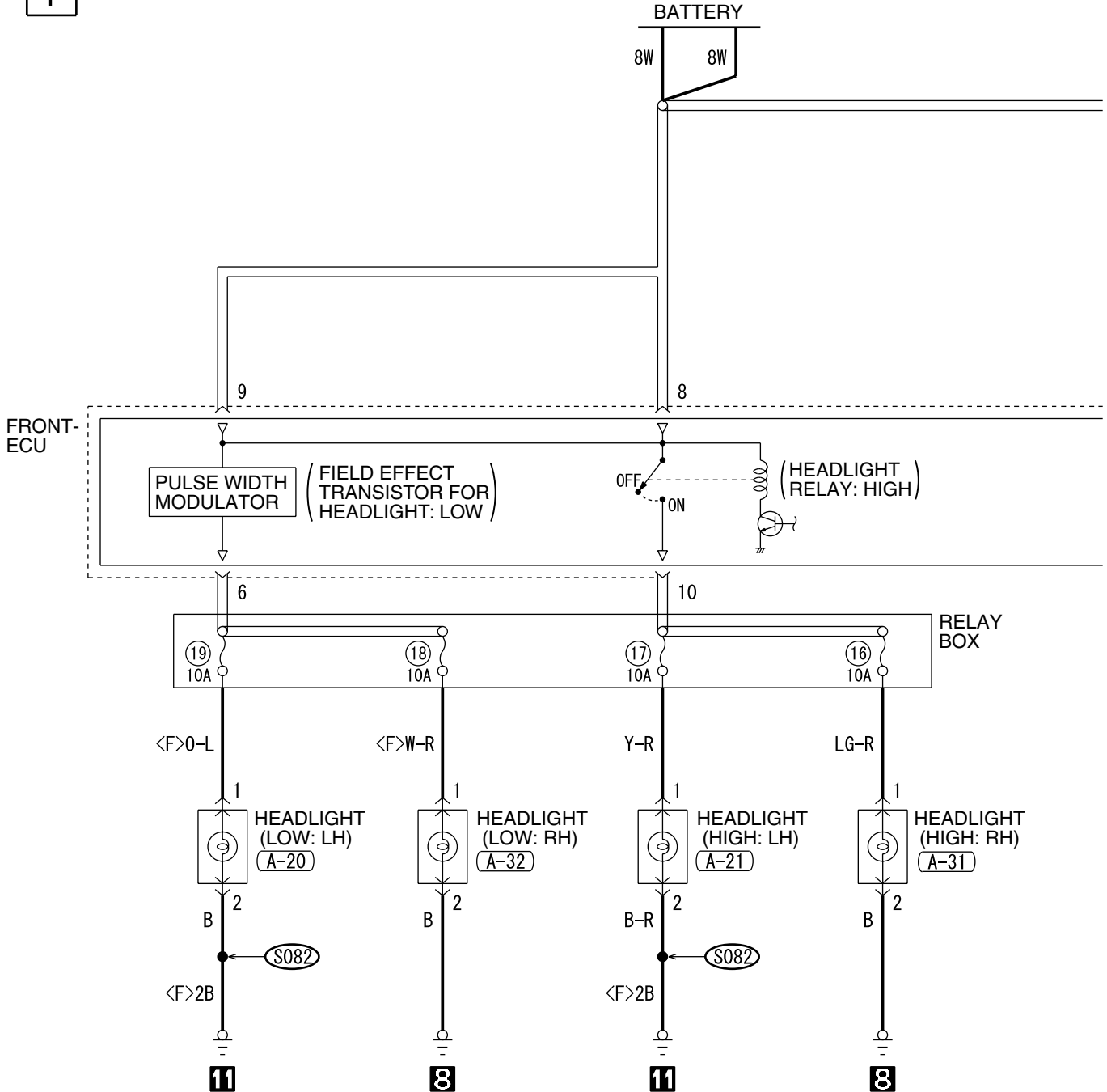

(A-11X)

(A-12X)

(A-20)

(A-21)

(A-31)

(A-32)

(C-01)

1	2	3	4	5	6	7	8	9	10	11
---	---	---	---	---	---	---	---	---	----	----

21	22	23	24	25	26	27	28	29	30	31
----	----	----	----	----	----	----	----	----	----	----



1	2	3	4	5	6	7	8	9	10	11
12	13	14	15	16	17	18	19	20	21	22
23	24	25	26	27	28	29	30	31	32	33

H5P08M01AA

TSB Revision

2

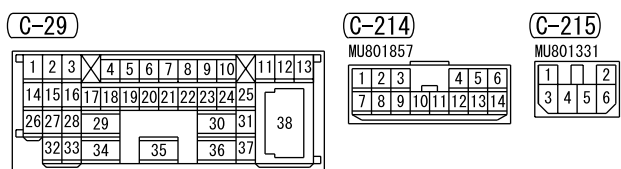
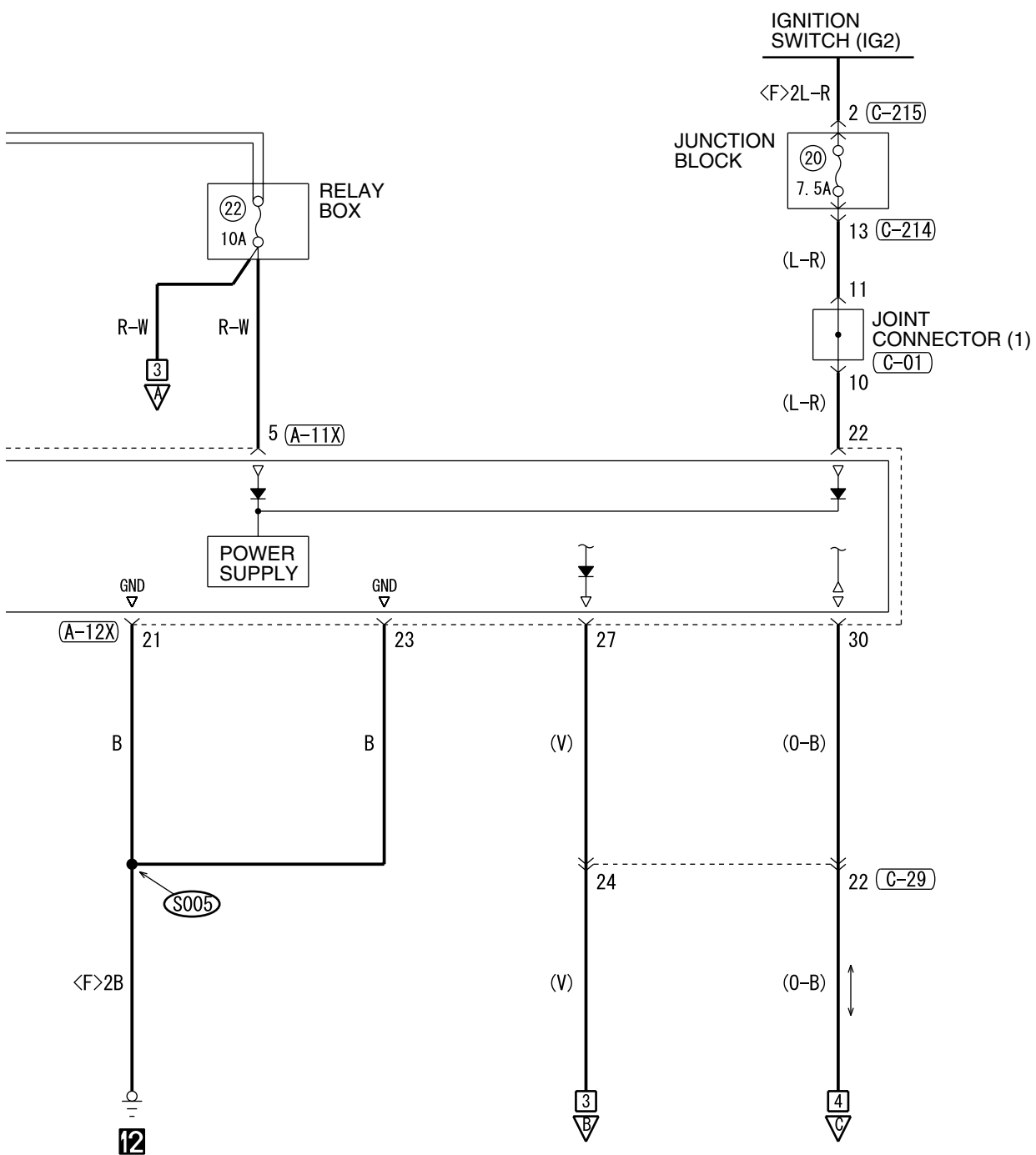

WIRE COLOR CODE  
 B : BLACK SB : SKY BLUE  
 BR : BROWN LG : LIGHT GREEN  
 G : GREEN P : PINK GR : GRAY  
 R : RED L : BLUE Y : YELLOW  
 V : VIOLET W : WHITE O : ORANGE

HEADLIGHT <4-BULB TYPE> (CONTINUED)

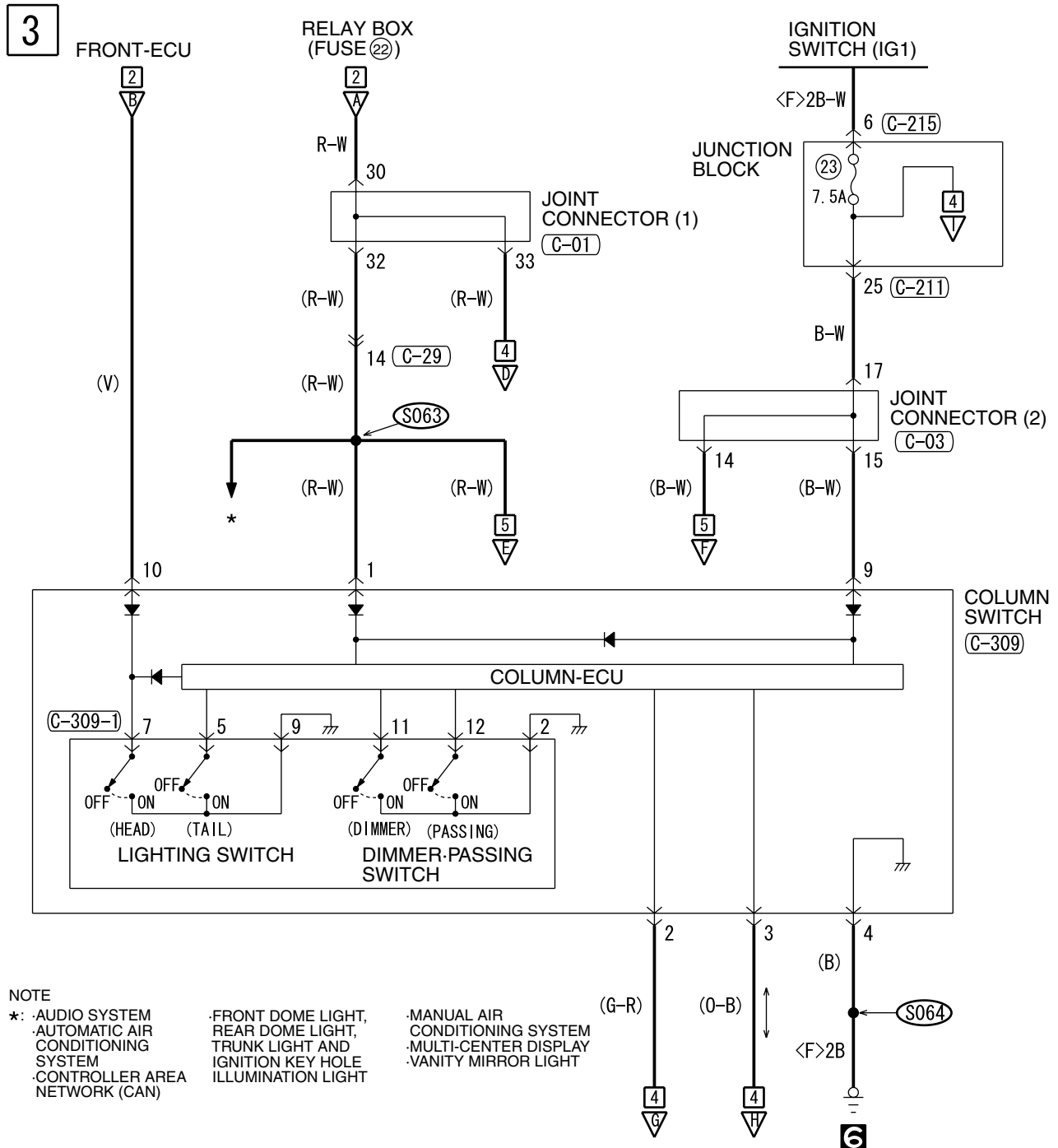

(C-01)

1	2	3	4	5	6	7	8	9	10	11
12	13	14	15	16	17	18	19	20	21	22
23	24	25	26	27	28	29	30	31	32	33

(C-03)

1	2	3	4	5	6	7	8	9	10	11
12	13	14	15	16	17	18	19	20	21	22
23	24	25	26	27	28	29	30	31	32	33

(C-29)

1	2	3	4	5	6	7	8	9	10	11	12	13
14	15	16	17	18	19	20	21	22	23	24	25	26
27	28	29	30	31	32	33	34	35	36	37	38	

(C-125)

MU803797

1	2	3	4	5	6	7	8
9	10	11	12	13	14	15	16

(C-204)

1	2	3	4	5	6	7	
8	9	10	11	12	13	14	15

(C-219) JUNCTION BLOCK SIDE

20	19	18	17	16	15	14	13	12	11	10	9	8	7	6	5	4	3	2	1
----	----	----	----	----	----	----	----	----	----	----	---	---	---	---	---	---	---	---	---

(C-309)

(MU801514)

1	2	3	4	5
6	7	8	9	10

(C-309-1)

UPPER SIDE

1	2	3	4	5	6	7	8	9	10	11	12
---	---	---	---	---	---	---	---	---	----	----	----

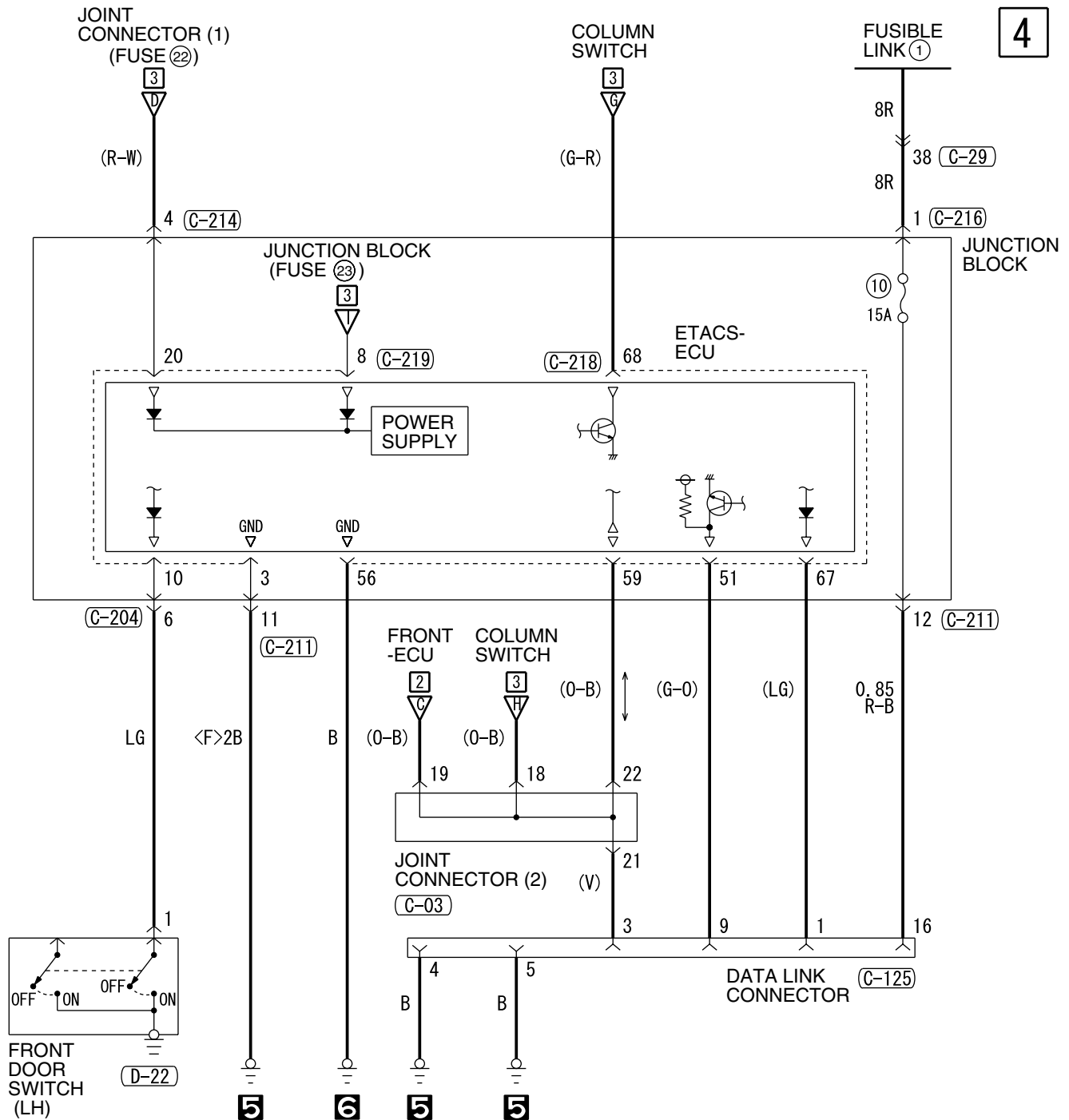

4

(C-211)

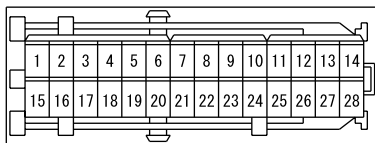

(C-214)

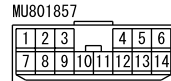

(C-215)



(C-216)



(C-218)

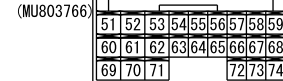

(D-22)



HEADLIGHT <4-BULB TYPE> (CONTINUED)

5

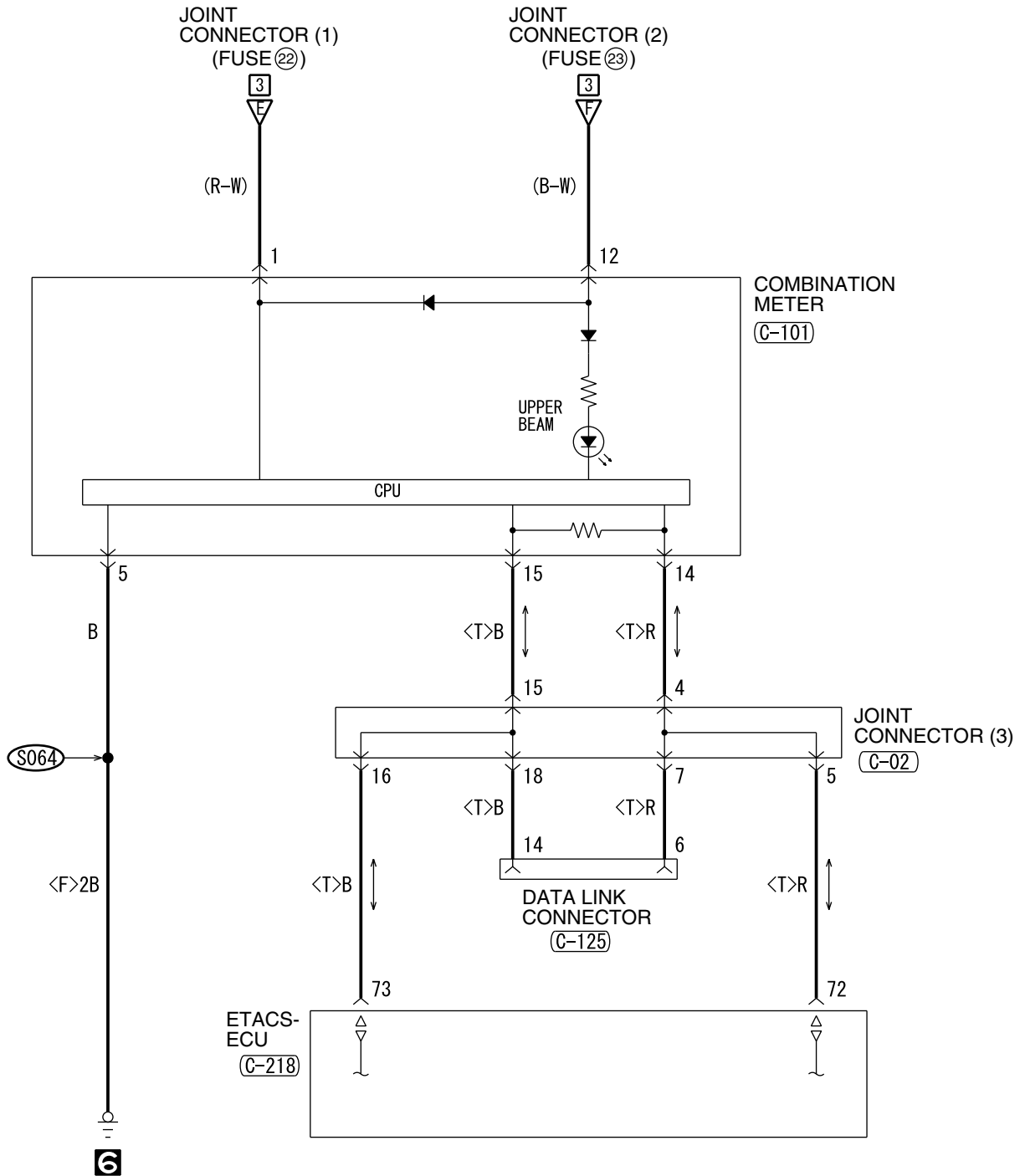

(C-02)

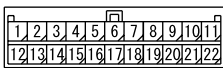

(C-101)

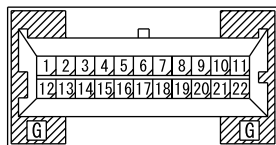

(C-125)

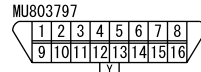

(C-218)



WIRE COLOR CODE

B : BLACK LG : LIGHT GREEN G : GREEN L : BLUE  
 BR : BROWN O : ORANGE GR : GRAY R : RED W : WHITE  
 SB : SKY BLUE P : PINK Y : YELLOW V : VIOLET

H5P08M01CA



NOTES

# TAILLIGHT, POSITION LIGHT, FRONT SIDE MARKER LIGHT AND LICENSE PLATE LIGHT

M1901017600035

1

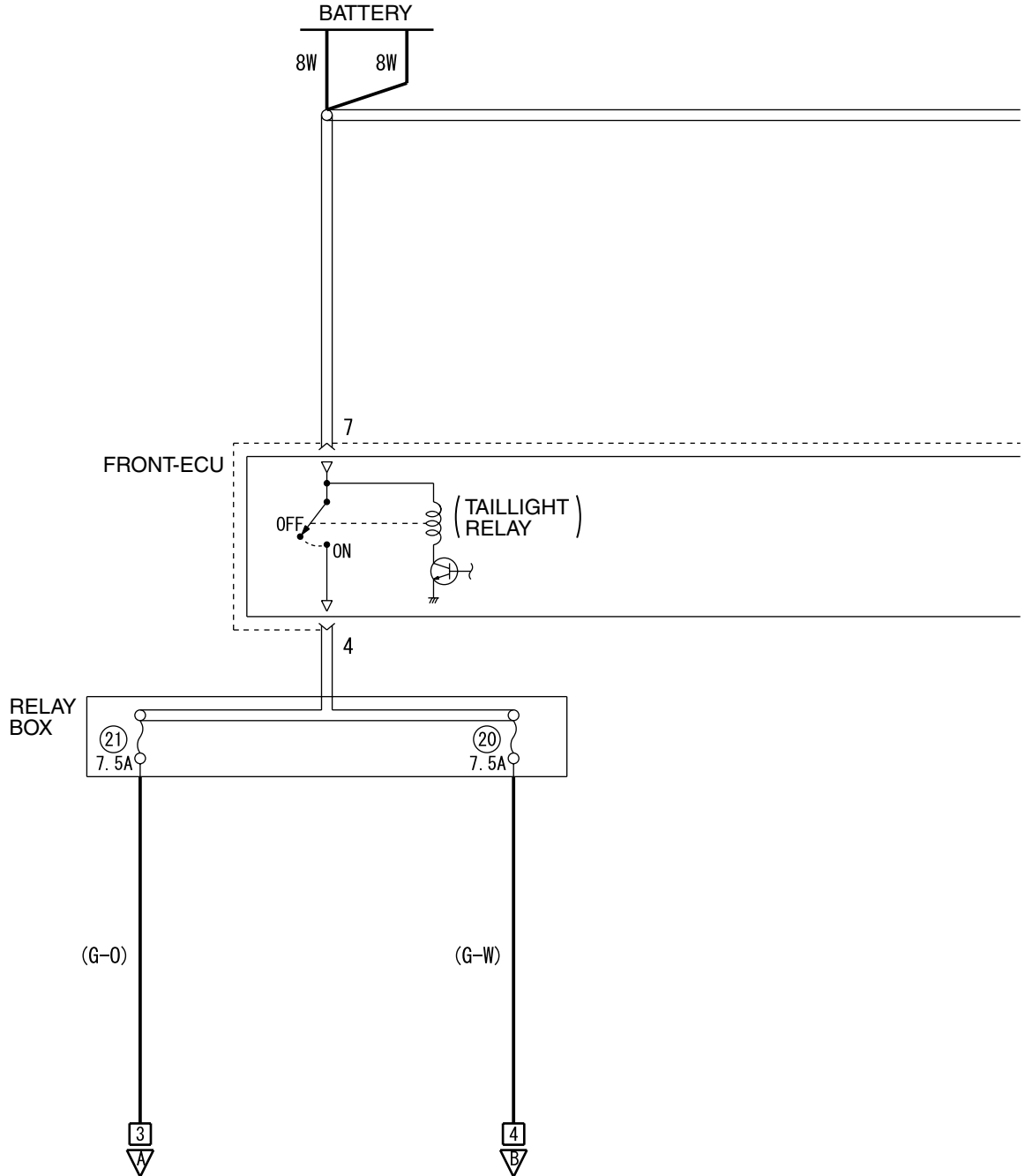

(A-11X)

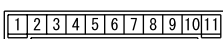

(A-12X)

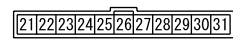

(C-01)

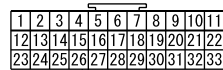

(C-29)

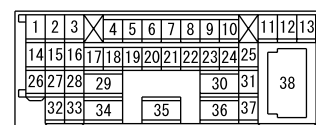

(C-214)

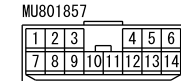



TAILLIGHT, POSITION LIGHT, FRONT SIDE MARKER LIGHT AND LICENSE PLATE LIGHT (CONTINUED)

3

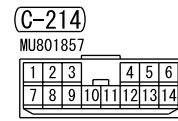
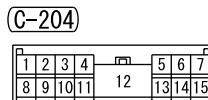
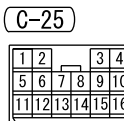
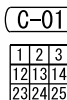
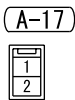
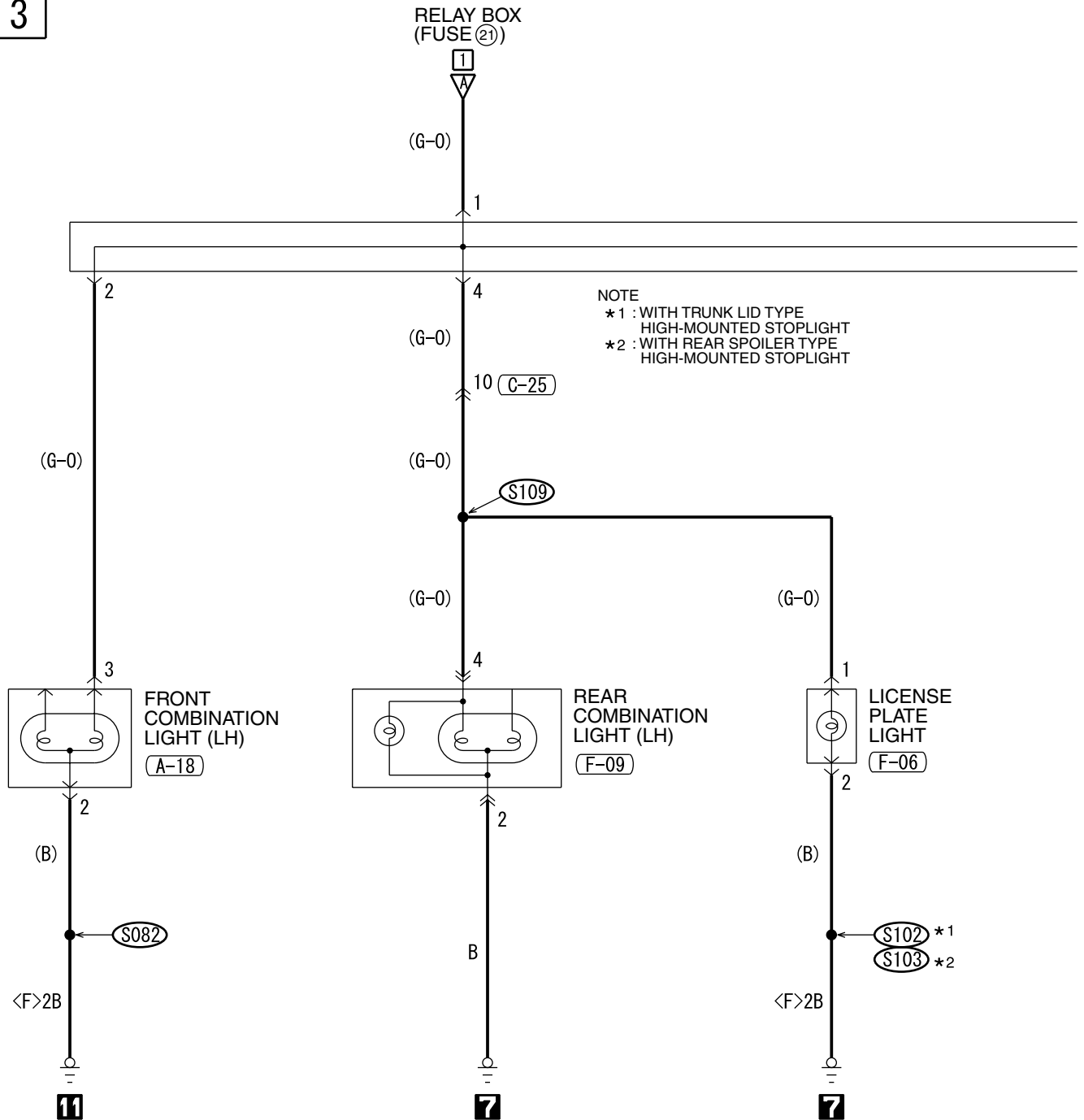

**4**

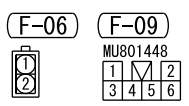
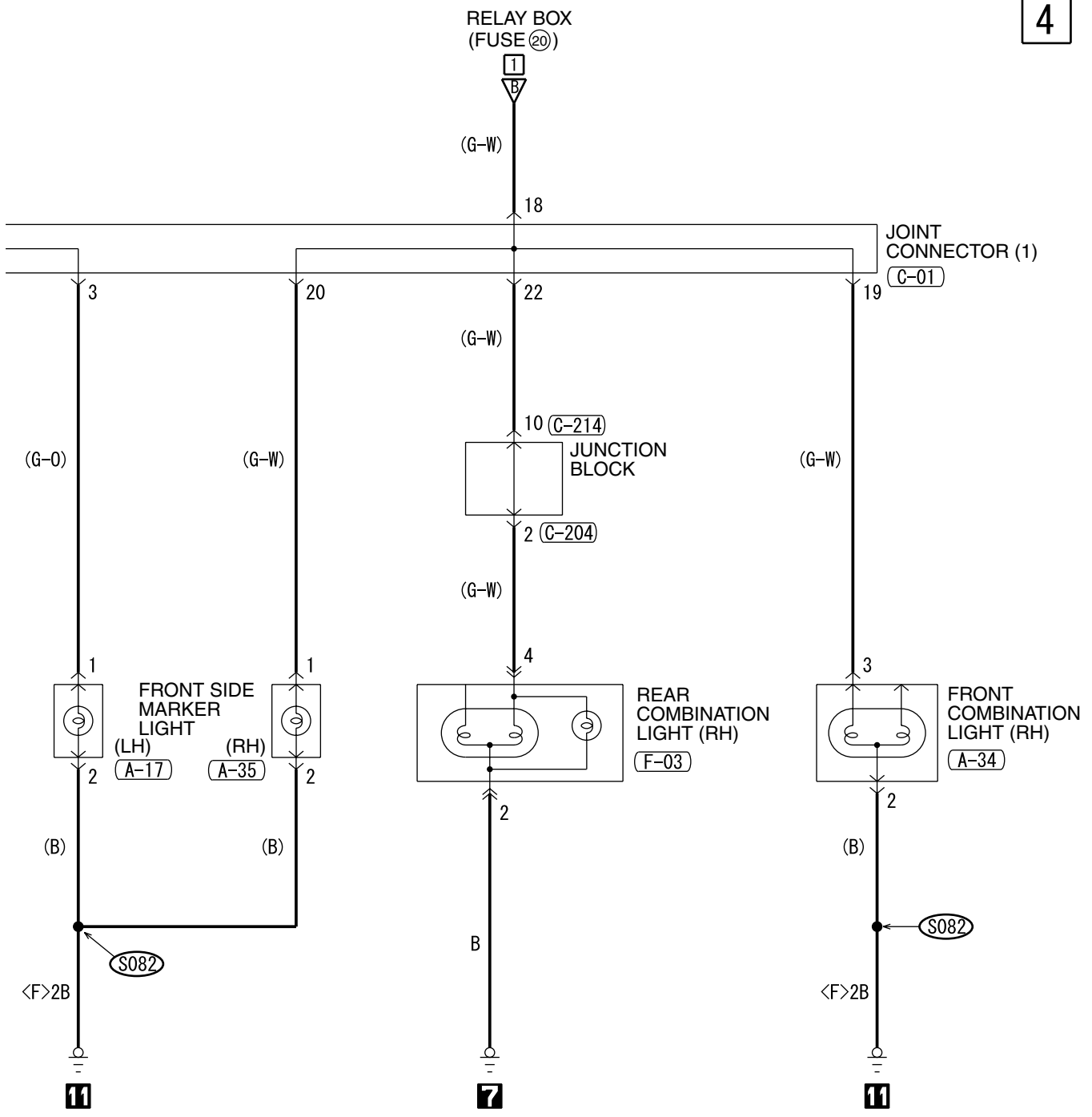

**WIRE COLOR CODE**  
 B : BLACK    LG : LIGHT GREEN    G : GREEN    L : BLUE    W : WHITE    Y : YELLOW  
 SB : SKY BLUE    BR : BROWN    O : ORANGE    GR : GRAY    R : RED    P : PINK    V : VIOLET

H5P08M02BB

**TSB Revision**

TAILLIGHT, POSITION LIGHT, FRONT SIDE MARKER LIGHT AND LICENSE PLATE LIGHT (CONTINUED)

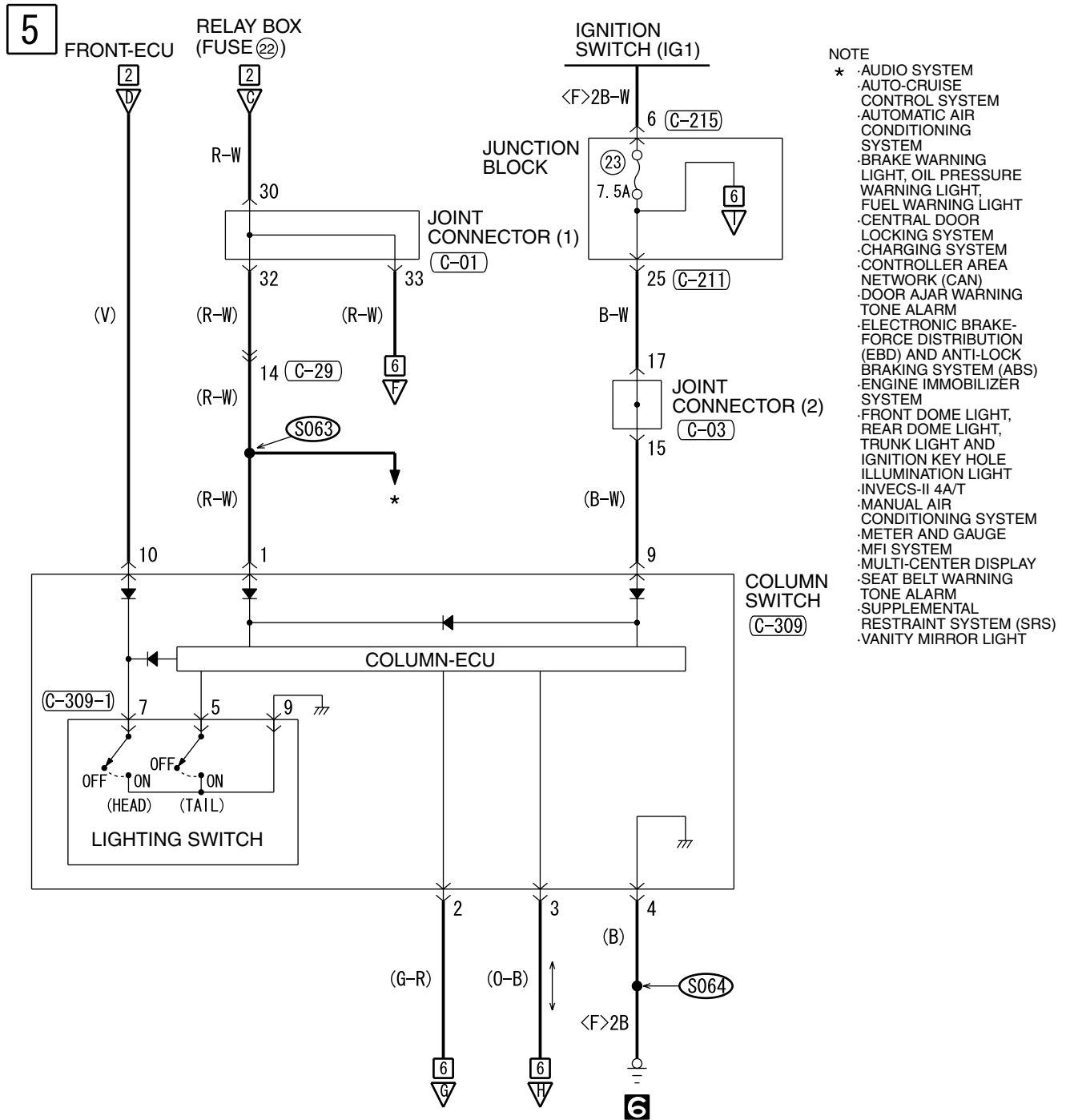

(C-01)

1	2	3	4	5	6	7	8	9	10	11
12	13	14	15	16	17	18	19	20	21	22
23	24	25	26	27	28	29	30	31	32	33

(C-03)

1	2	3	4	5	6	7	8	9	10	11
12	13	14	15	16	17	18	19	20	21	22
23	24	25	26	27	28	29	30	31	32	33

(C-29)

1	2	3	4	5	6	7	8	9	10	11	12	13
14	15	16	17	18	19	20	21	22	23	24	25	
26	27	28	29					30	31			38
32	33	34						35	36	37		

(C-125)

MU803797

1	2	3	4	5	6	7	8
9	10	11	12	13	14	15	16

(C-204)

1	2	3	4		5	6	7
8	9	10	11	12	13	14	15

(C-219) JUNCTION BLOCK SIDE

20	19	18	17	16	15	14	13	12	11	10	9	8	7	6	5	4	3	2	1
----	----	----	----	----	----	----	----	----	----	----	---	---	---	---	---	---	---	---	---

(C-309)

(MU801514)

1	2	3	4	5
6	7	8	9	10

(C-309-1)

UPPER SIDE

1	2	3	4	5	6	7	8	9	10	11	12
---	---	---	---	---	---	---	---	---	----	----	----

**6**

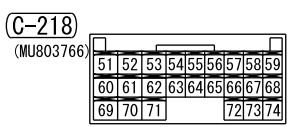
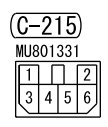
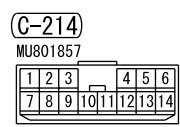
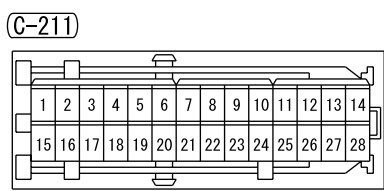
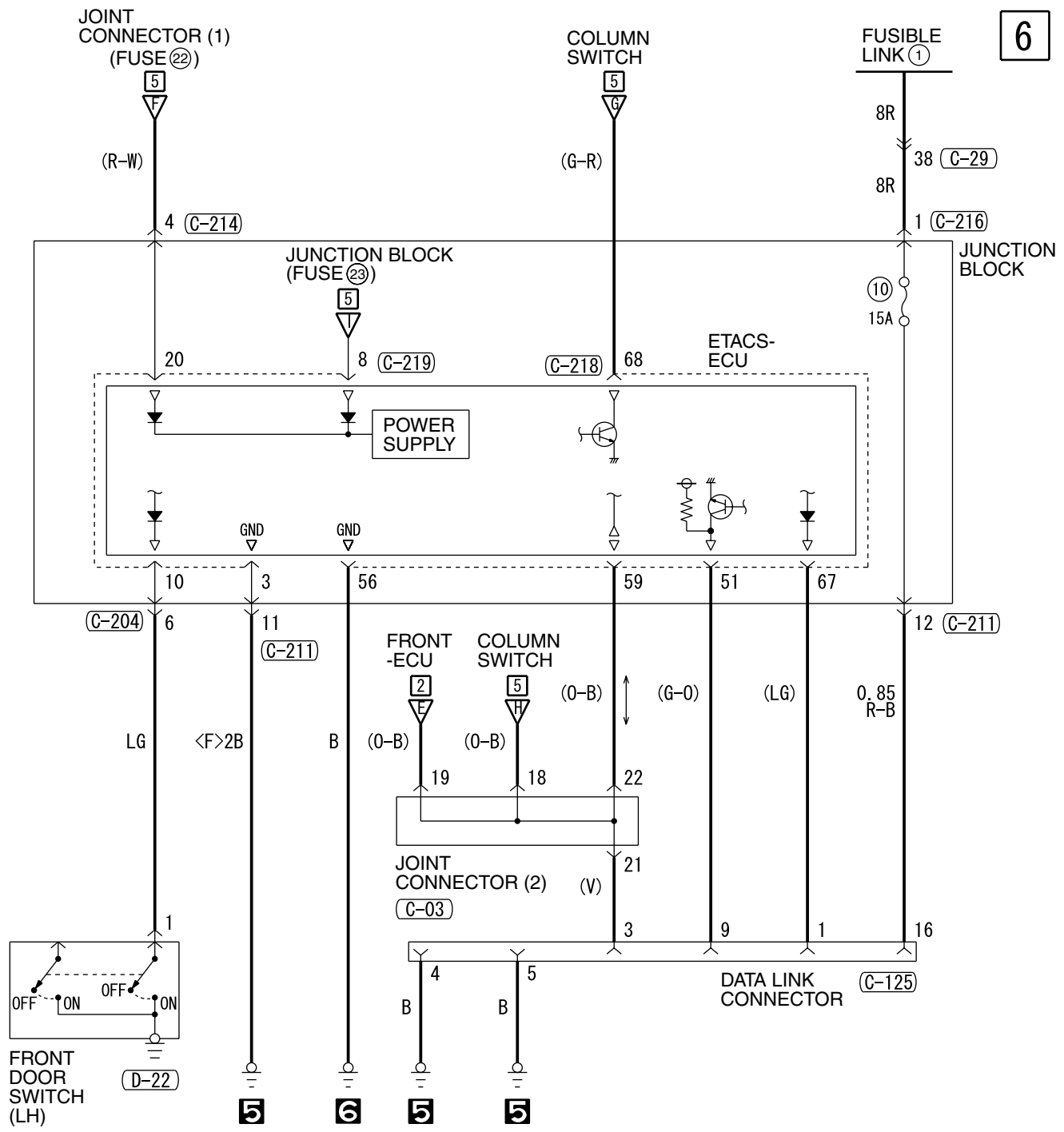

**WIRE COLOR CODE**  
 B : BLACK    LG : LIGHT GREEN    G : GREEN    L : BLUE  
 BR : BROWN    O : ORANGE    GR : GRAY    R : RED    W : WHITE  
 SB : SKY BLUE    P : PINK    Y : YELLOW    V : VIOLET    H5P08M02CB

FOG LIGHT

M1901001800698

1

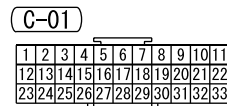
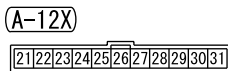
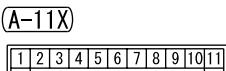
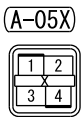
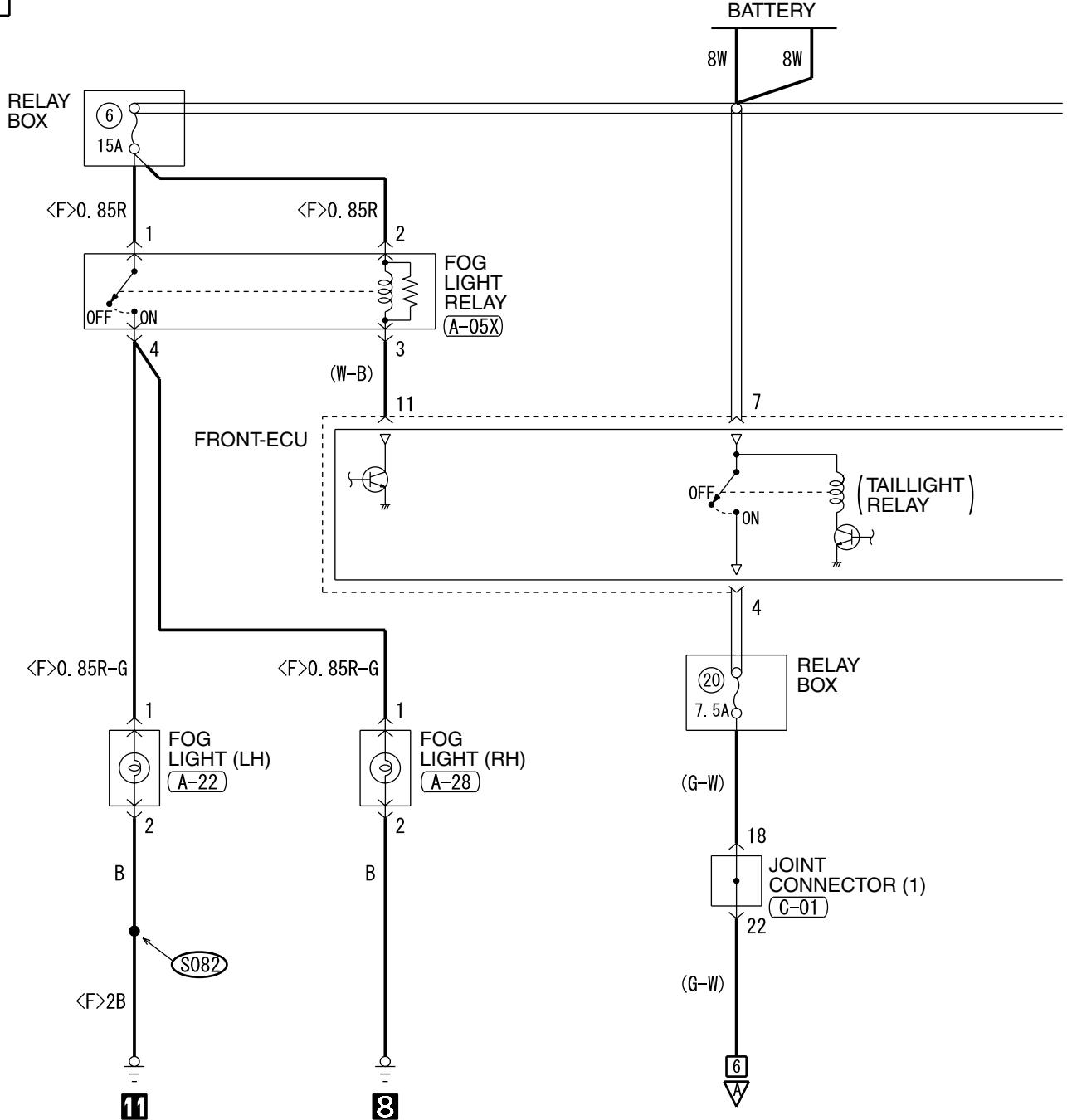



2

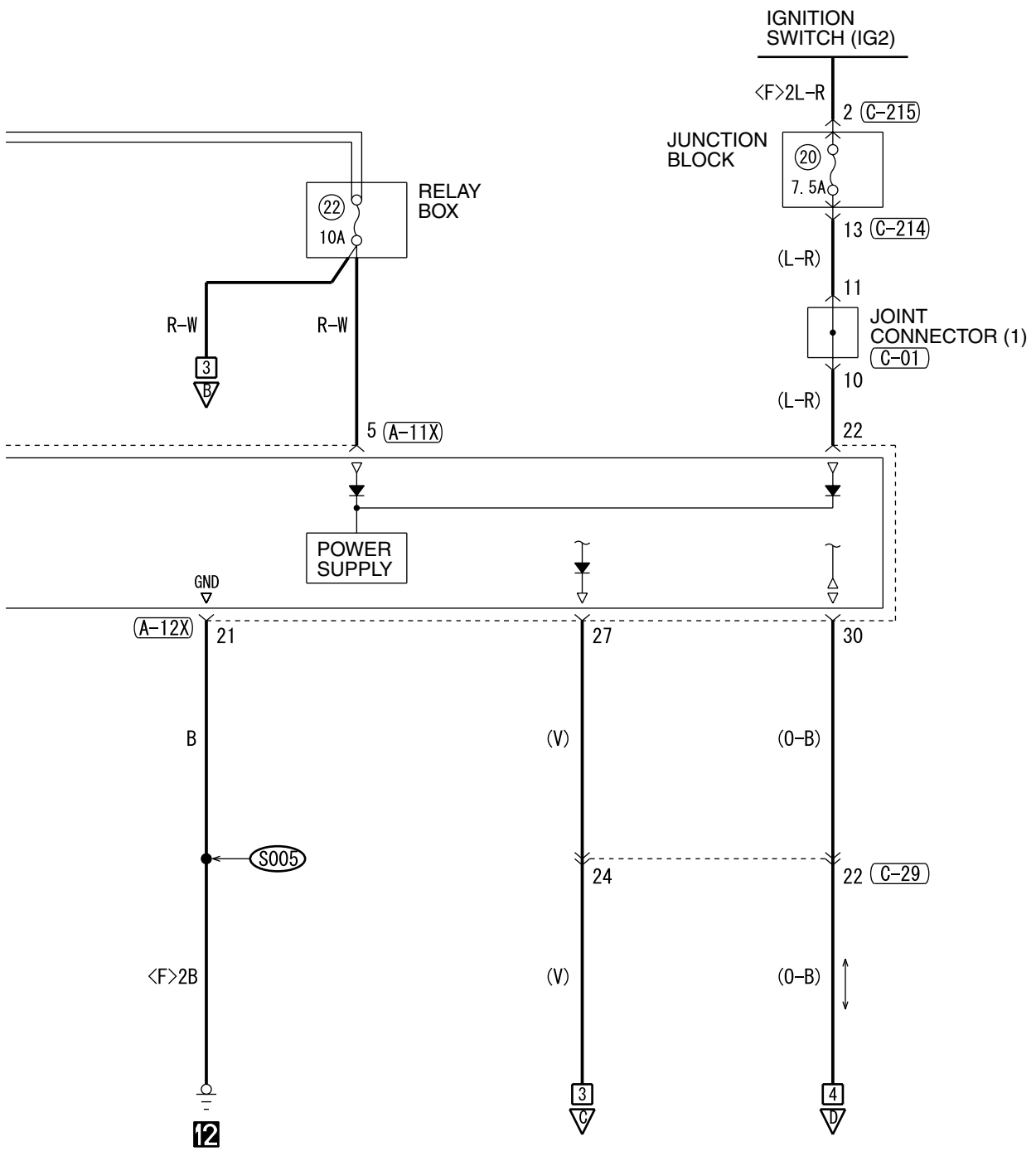

(C-29)

1	2	3	4	5	6	7	8	9	10	11	12	13
14	15	16	17	18	19	20	21	22	23	24	25	
26	27	28	29	30	31							
32	33	34	35	36	37							

(C-214)

MU801857

1	2	3	4	5	6
7	8	9	10	11	12
13	14				

(C-215)

MU801331

1	2	
3	4	5
6		

WIRE COLOR CODE  
 B: BLACK LG: LIGHT GREEN G: GREEN L: BLUE  
 BR: BROWN O: ORANGE GR: GRAY R: RED W: WHITE  
 SB: SKY BLUE P: PINK Y: YELLOW V: VIOLET

TSB Revision

FOG LIGHT (CONTINUED)

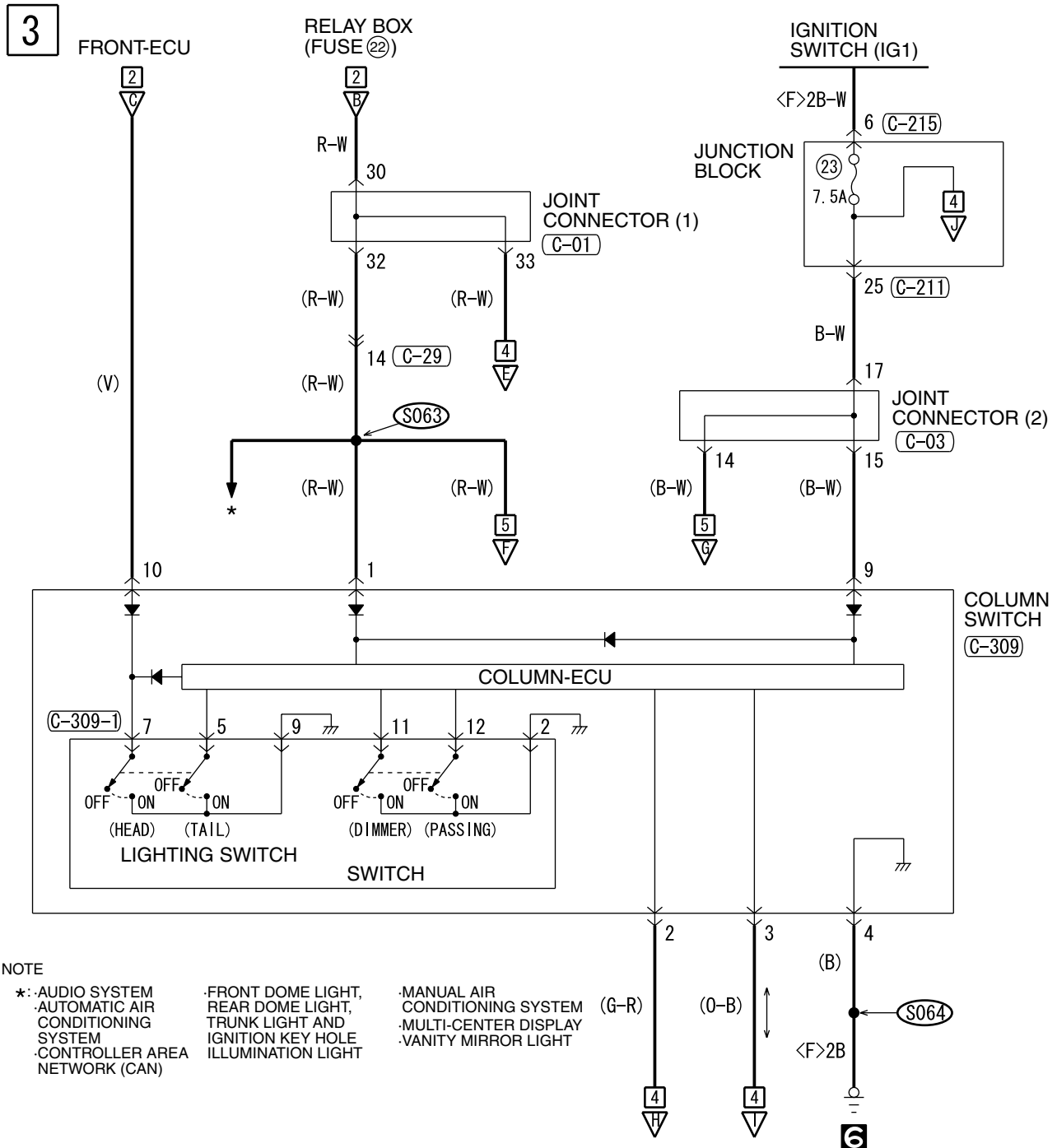

NOTE

- \*: AUDIO SYSTEM
- AUTOMATIC AIR CONDITIONING SYSTEM
- CONTROLLER AREA NETWORK (CAN)
- FRONT DOME LIGHT, REAR DOME LIGHT, TRUNK LIGHT AND IGNITION KEY HOLE ILLUMINATION LIGHT
- MANUAL AIR CONDITIONING SYSTEM
- MULTI-CENTER DISPLAY
- VANITY MIRROR LIGHT

(C-01)

1	2	3	4	5	6	7	8	9	10	11
12	13	14	15	16	17	18	19	20	21	22
23	24	25	26	27	28	29	30	31	32	33

(C-03)

1	2	3	4	5	6	7	8	9	10	11
12	13	14	15	16	17	18	19	20	21	22
23	24	25	26	27	28	29	30	31	32	33

(C-29)

1	2	3	4	5	6	7	8	9	10	11	12	13
14	15	16	17	18	19	20	21	22	23	24	25	
26	27	28	29					30	31		38	
32	33	34						36	37			

(C-125)

1	2	3	4	5	6	7	8
9	10	11	12	13	14	15	16

(C-219) JUNCTION BLOCK SIDE

20	19	18	17	16	15	14	13	12	11	10	9	8	7	6	5	4	3	2	1
----	----	----	----	----	----	----	----	----	----	----	---	---	---	---	---	---	---	---	---

(C-309)

1	2	3	4	5
6	7	8	9	10

(C-309-1)

1	2	3	4	5	6	7	8	9	10	11	12
---	---	---	---	---	---	---	---	---	----	----	----

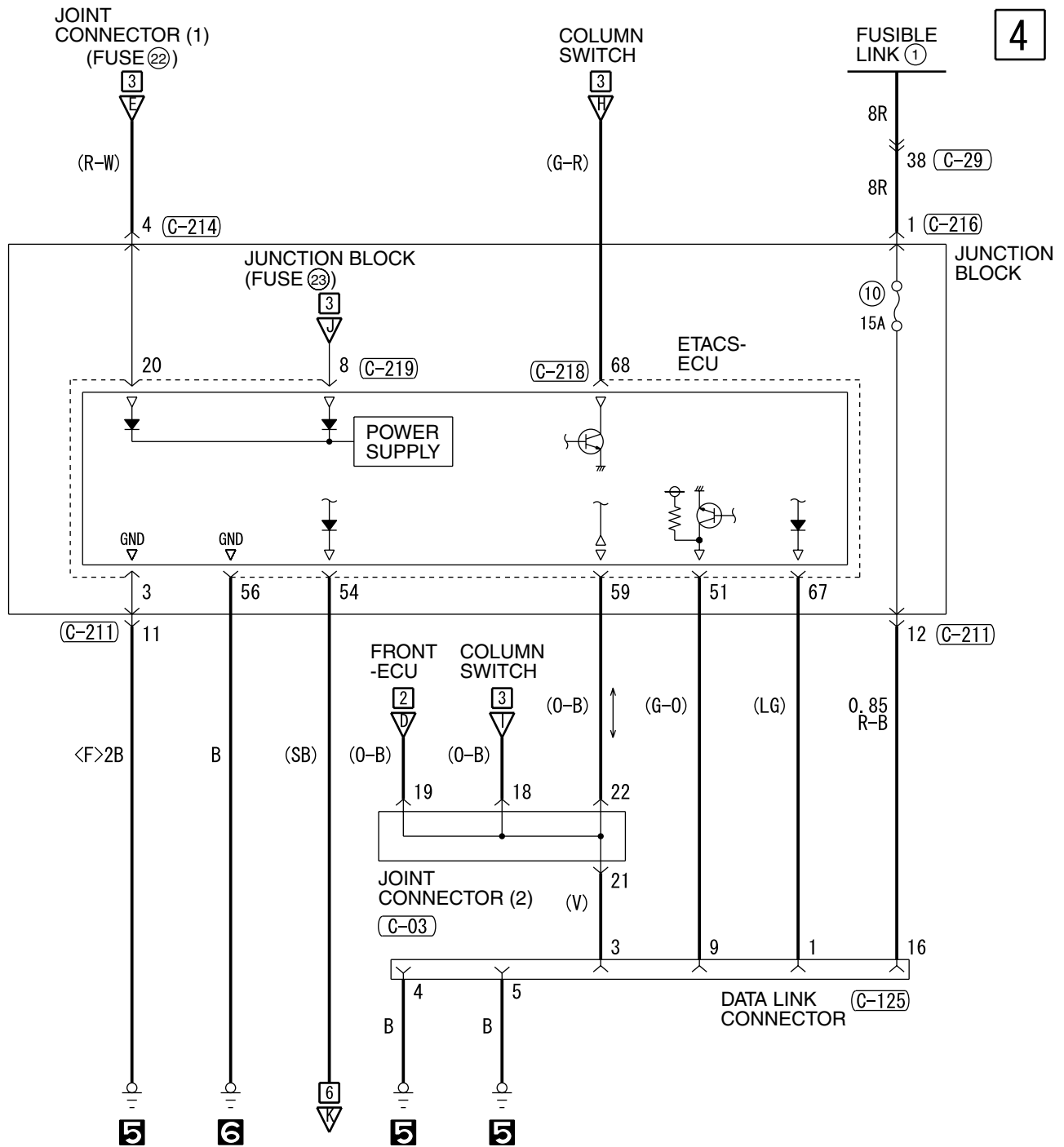

4

(C-211)

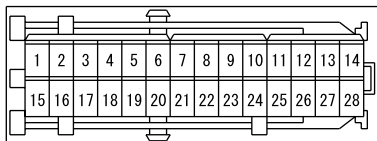

(C-214)  
MU801857

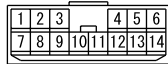

(C-215)  
MU801331



(C-216)  
MU801403



(C-218)  
(MU803766)

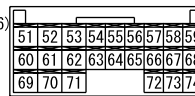

WIRE COLOR CODE

B : BLACK LG : LIGHT GREEN G : GREEN L : BLUE  
BR : BROWN O : ORANGE GR : GRAY R : RED W : WHITE  
SB : SKY BLUE P : PINK Y : YELLOW V : VIOLET

H5P08M03BB

FOG LIGHT (CONTINUED)

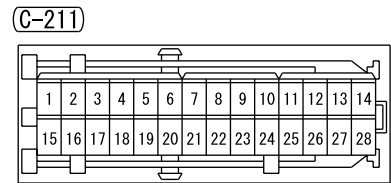
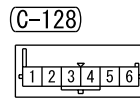
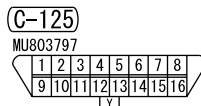
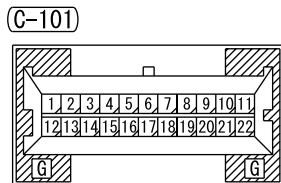
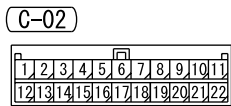
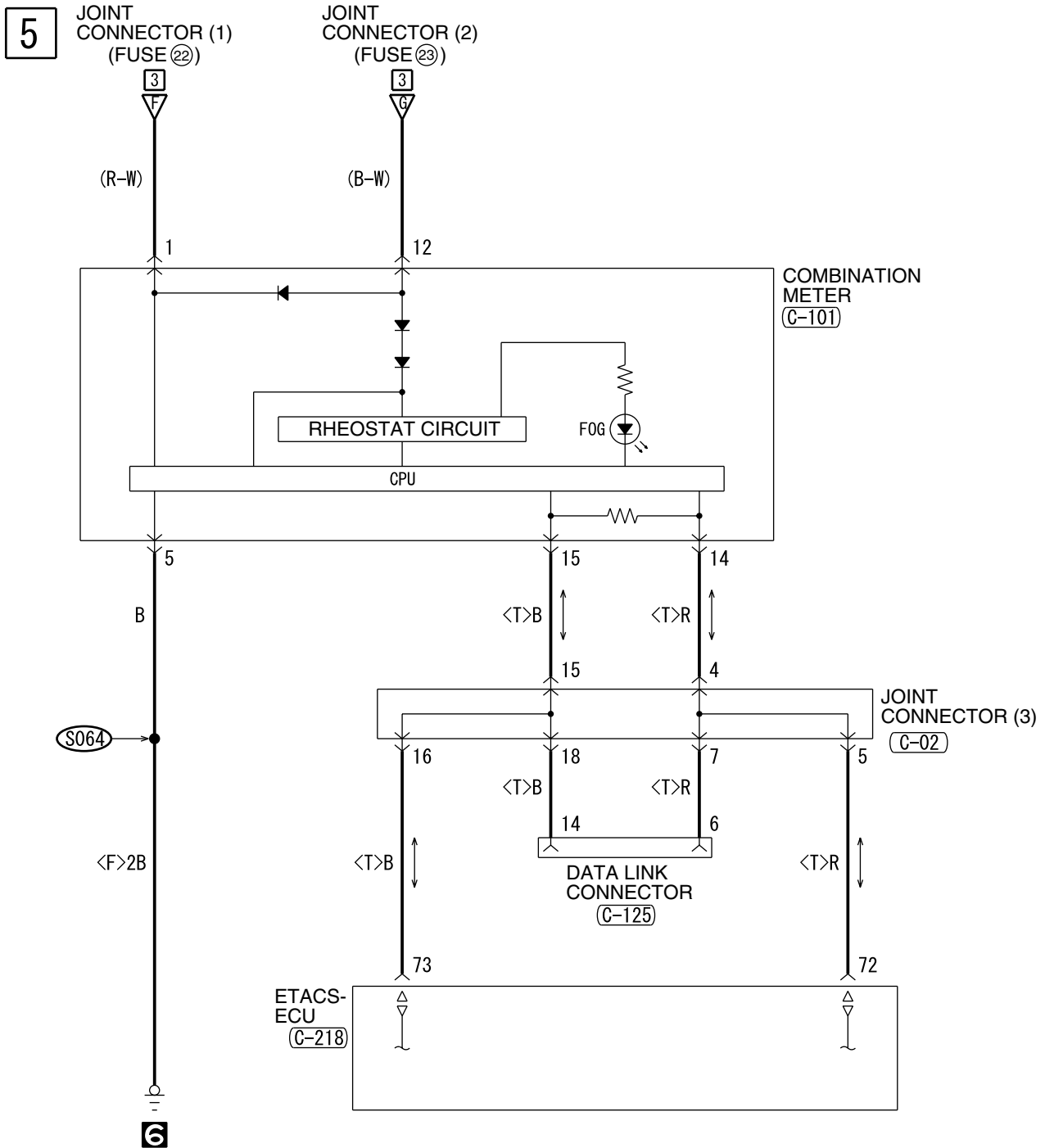

6

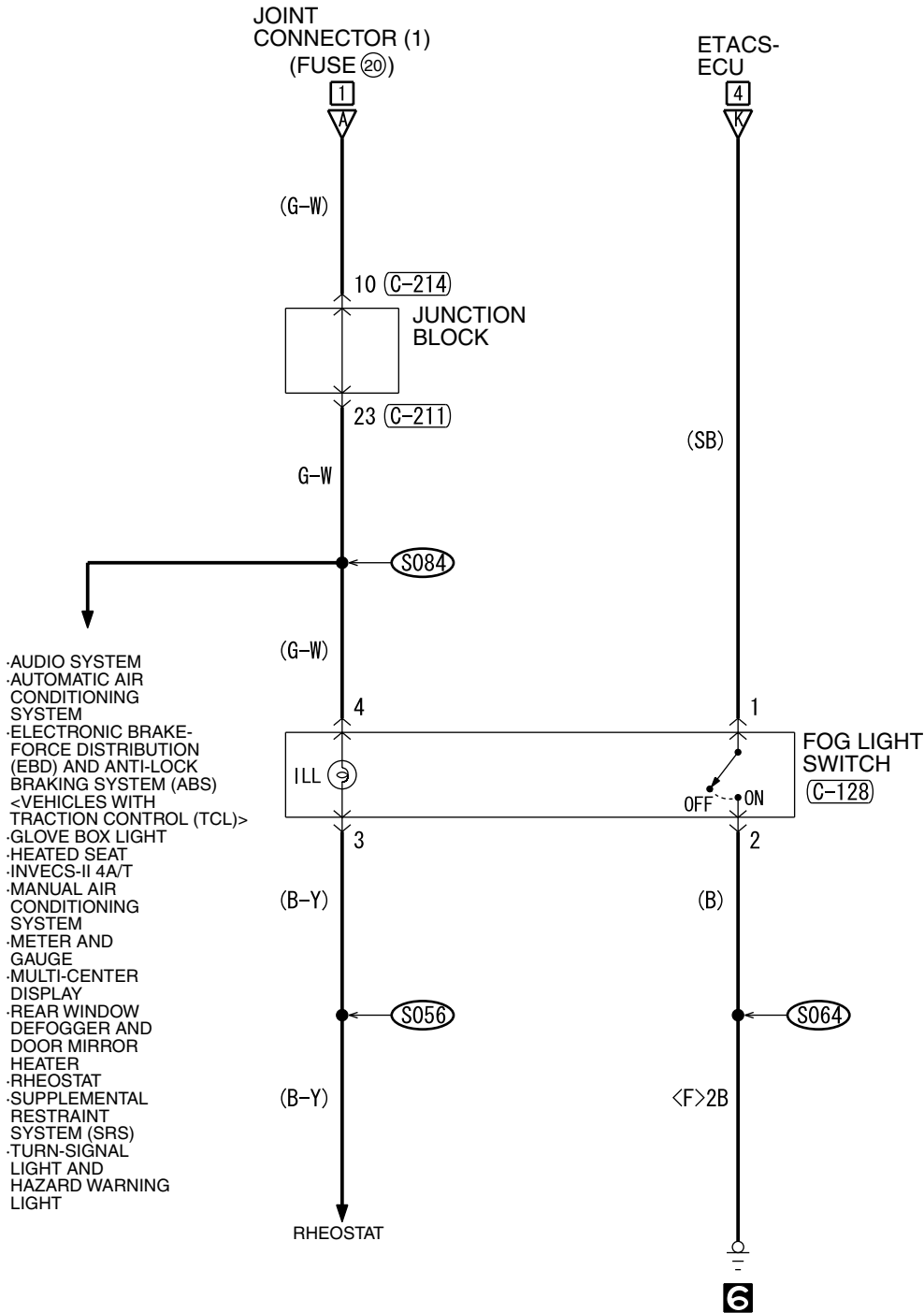

(C-214)  
MU801857

1	2	3	4	5	6
7	8	9	10	11	12
13	14				

(C-218)  
(MU803766)

51	52	53	54	55	56	57	58	59
60	61	62	63	64	65	66	67	68
69	70	71	72	73	74			

WIRE COLOR CODE  
 B : BLACK LG : LIGHT GREEN G : GREEN L : BLUE  
 BR : BROWN O : ORANGE GR : GRAY R : RED W : WHITE  
 SB : SKY BLUE P : PINK Y : YELLOW V : VIOLET

# FRONT DOME LIGHT, REAR DOME LIGHT, TRUNK LIGHT AND IGNITION KEY HOLE ILLUMINATION LIGHT

M1901002100313

1

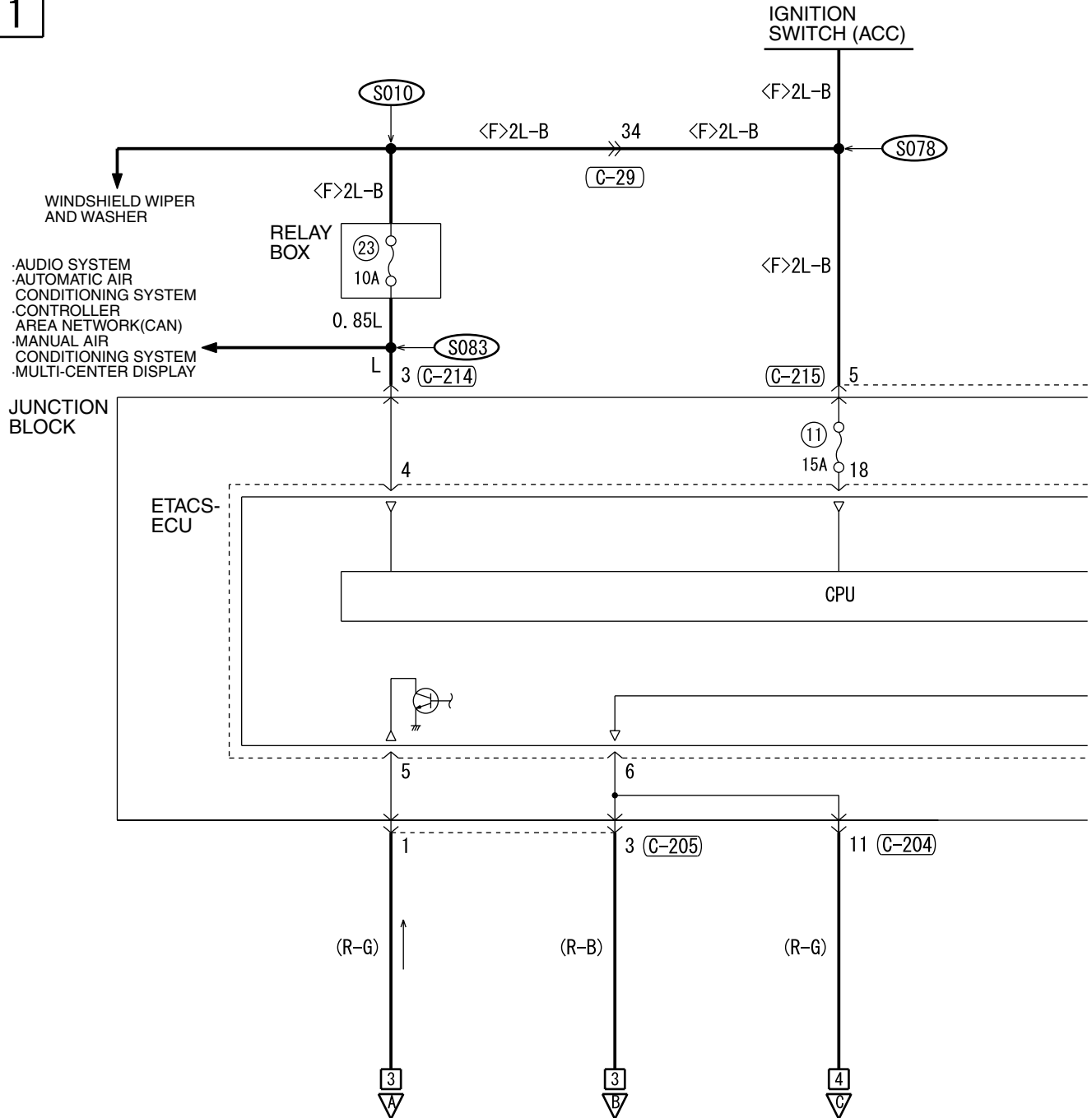

(C-29)

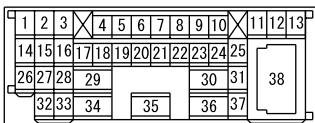

(C-125)

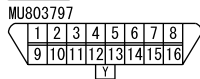

(C-204)

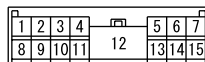

(C-205)



(C-211)

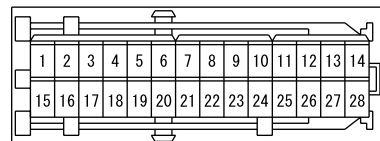

H5P08M04AA

2

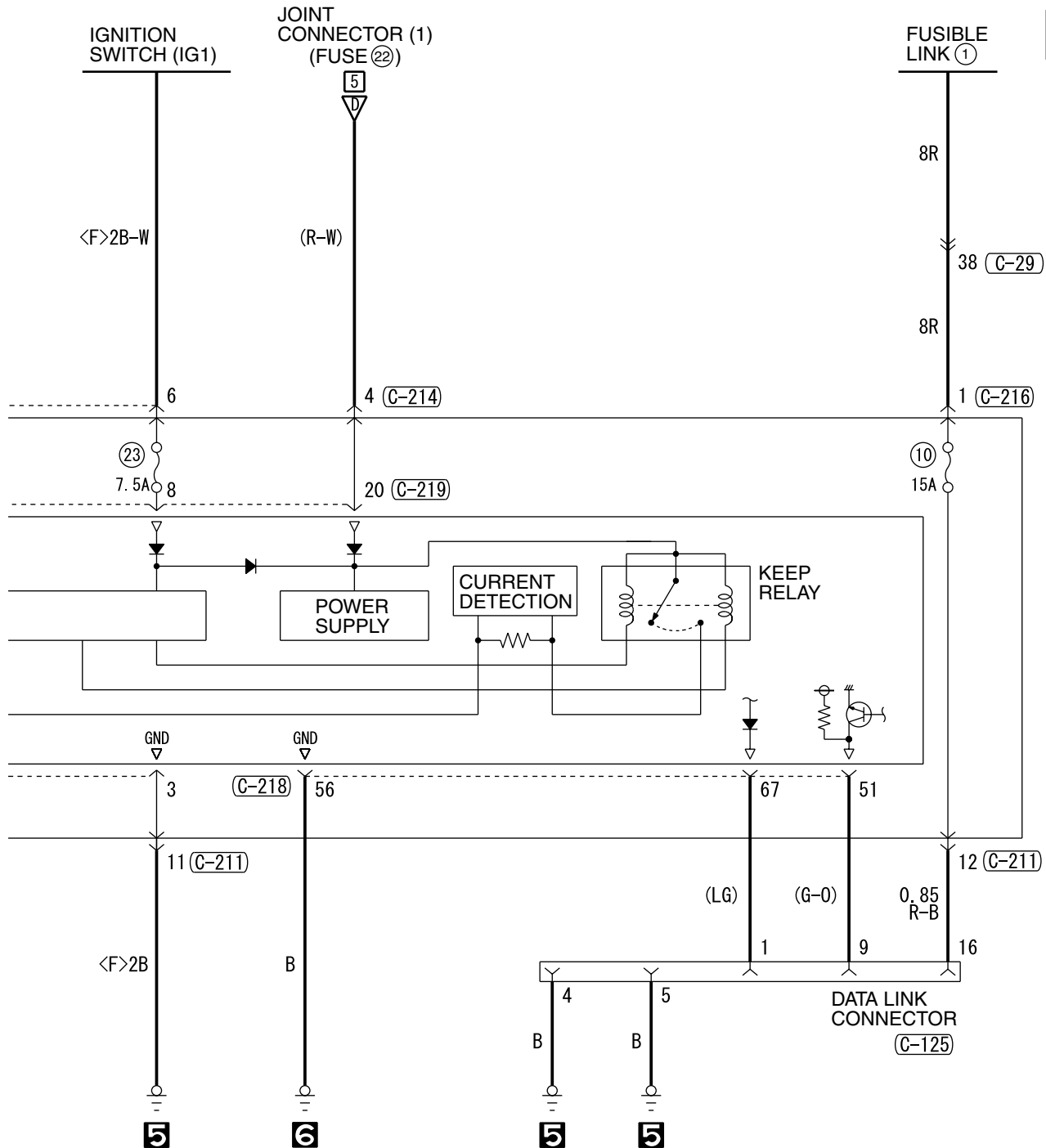

(C-214)

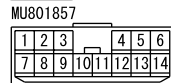

(C-215)



(C-216)



(C-218)

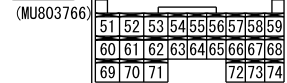

(C-219)

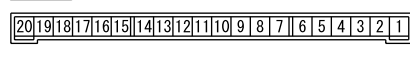

WIRE COLOR CODE

B : BLACK LG : LIGHT GREEN G : GREEN L : BLUE W : WHITE Y : YELLOW  
 SB : SKY BLUE BR : BROWN O : ORANGE GR : GRAY R : RED P : PINK V : VIOLET

FRONT DOME LIGHT, REAR DOME LIGHT, TRUNK LIGHT AND IGNITION KEY HOLE ILLUMINATION LIGHT (CONTINUED)

3

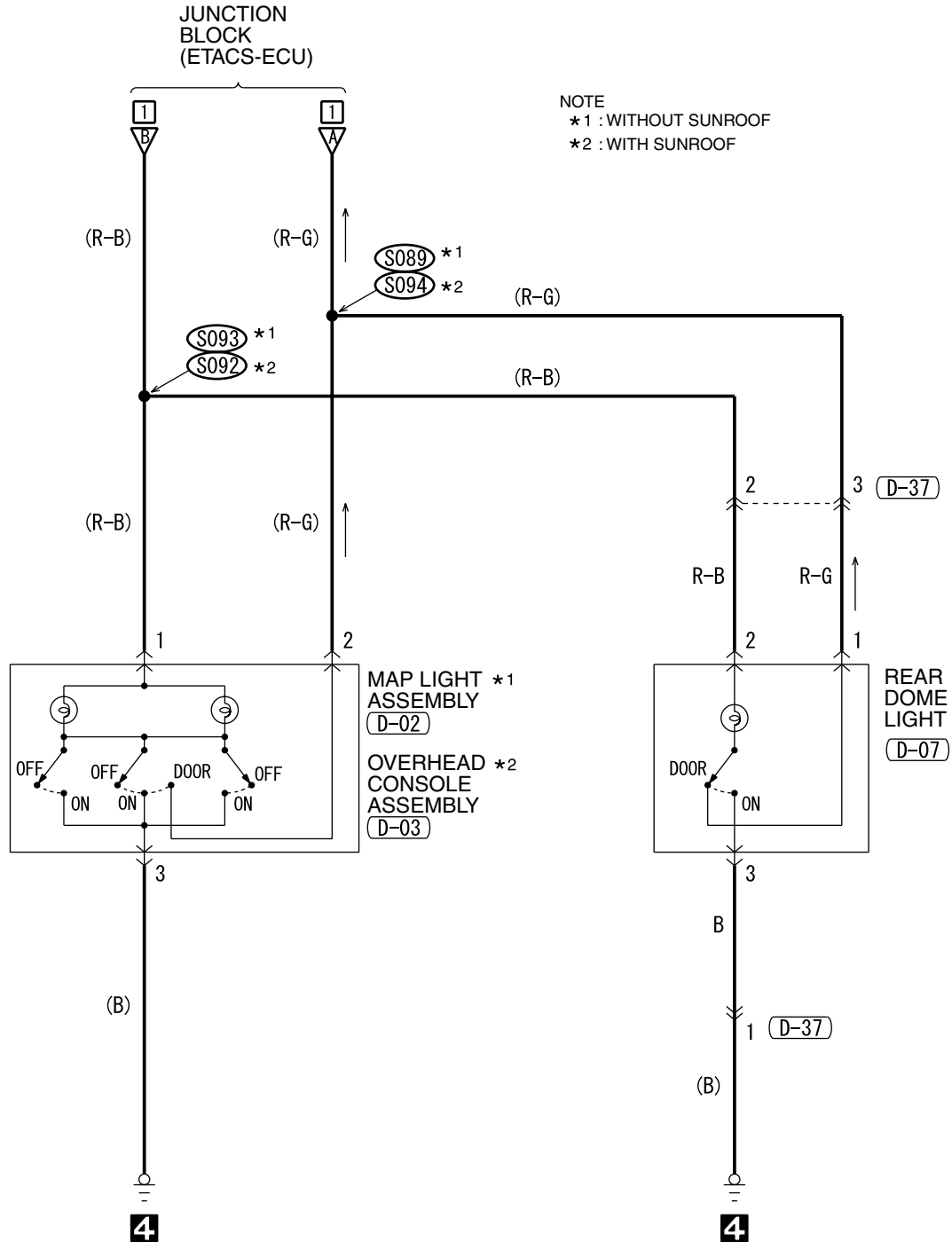

C-28

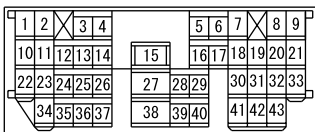

C-217

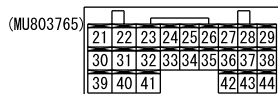

C-218

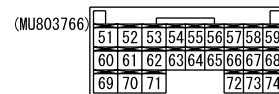

D-02



D-03

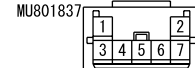



4

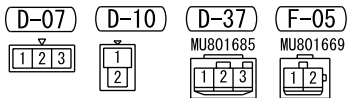
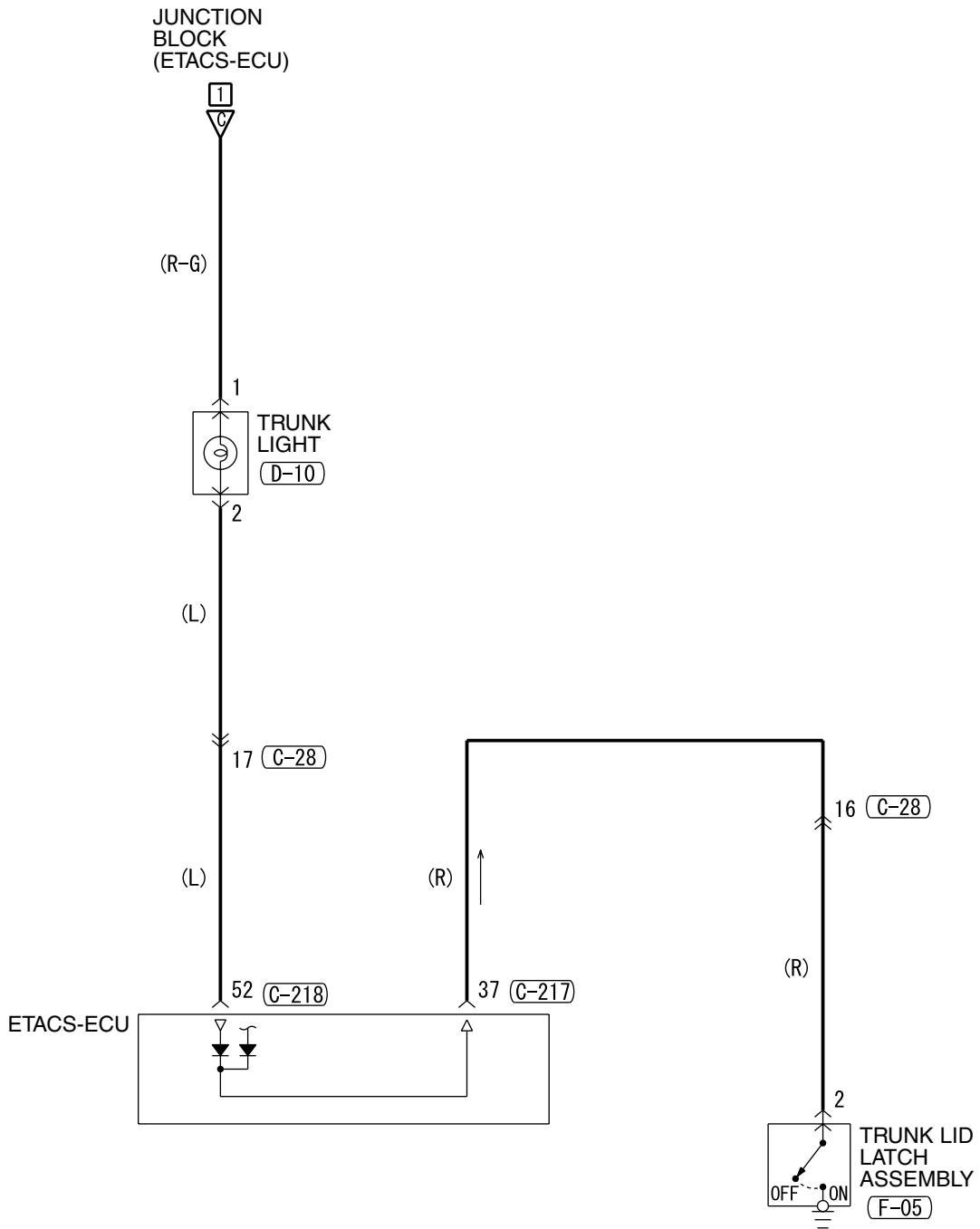

WIRE COLOR CODE  
 B: BLACK LG: LIGHT GREEN G: GREEN L: BLUE  
 BR: BROWN O: ORANGE GR: GRAY R: RED W: WHITE  
 SB: SKY BLUE P: PINK Y: YELLOW V: VIOLET

FRONT DOME LIGHT, REAR DOME LIGHT, TRUNK LIGHT AND IGNITION KEY HOLE ILLUMINATION LIGHT (CONTINUED)

5

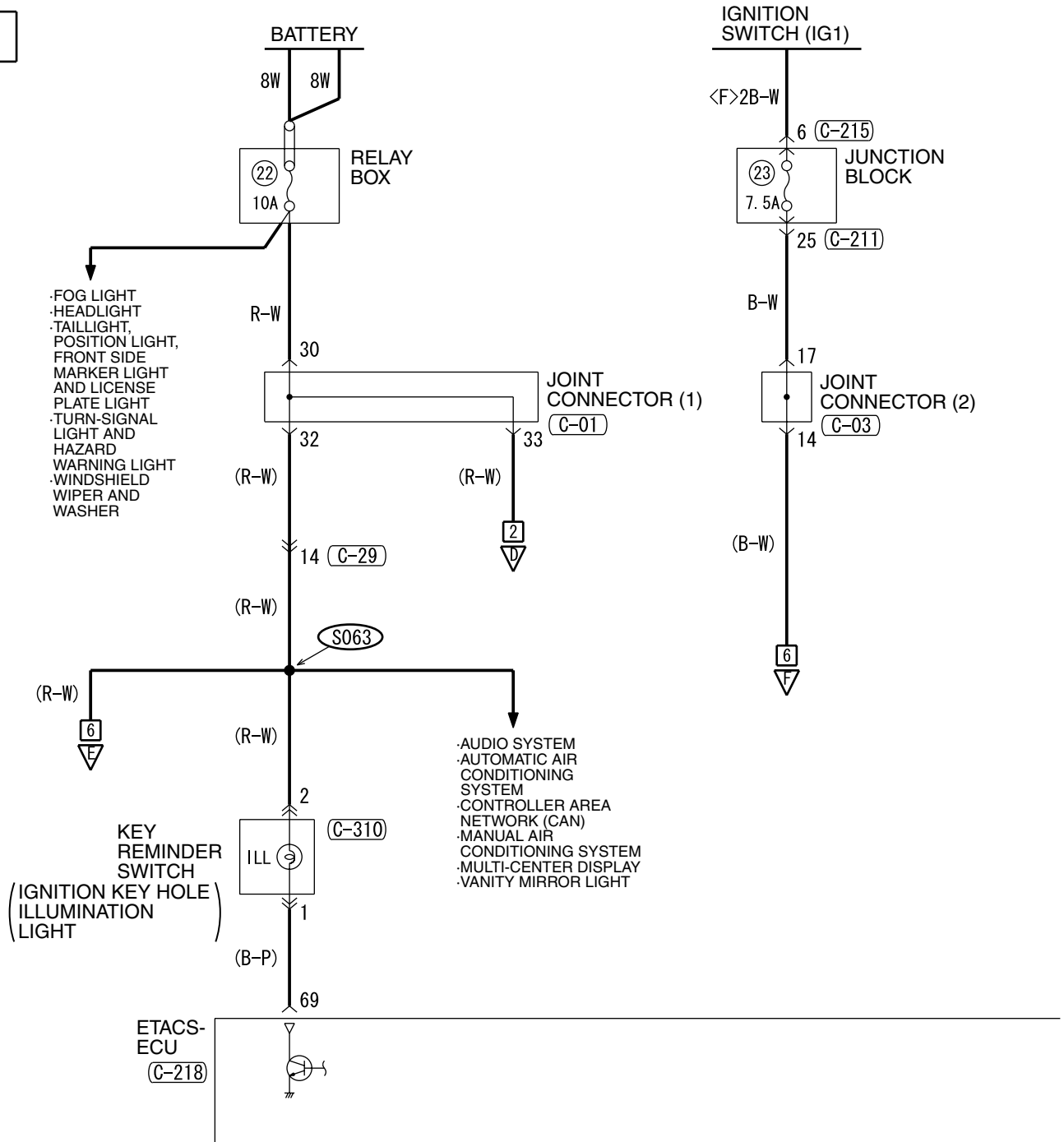

- FOG LIGHT
- HEADLIGHT
- TAILLIGHT,
- POSITION LIGHT,
- FRONT SIDE MARKER LIGHT AND LICENSE PLATE LIGHT
- TURN-SIGNAL LIGHT AND HAZARD WARNING LIGHT
- WINDSHIELD WIPER AND WASHER

- AUDIO SYSTEM
- AUTOMATIC AIR CONDITIONING SYSTEM
- CONTROLLER AREA NETWORK (CAN)
- MANUAL AIR CONDITIONING SYSTEM
- MULTI-CENTER DISPLAY
- VANITY MIRROR LIGHT

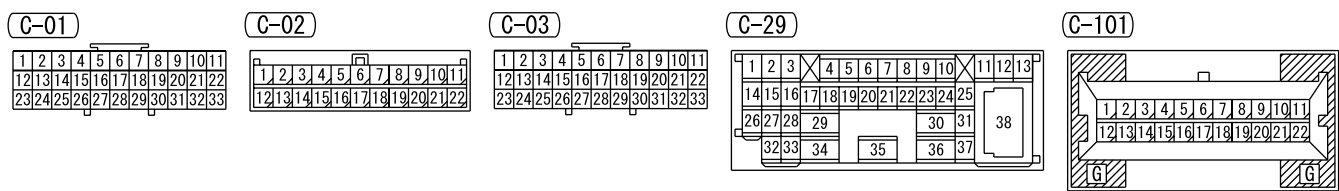

6

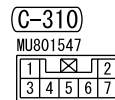
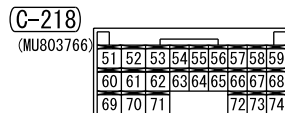
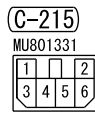
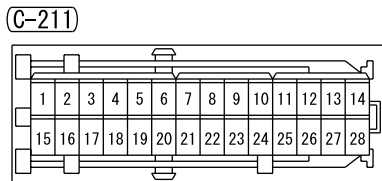
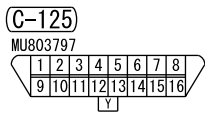
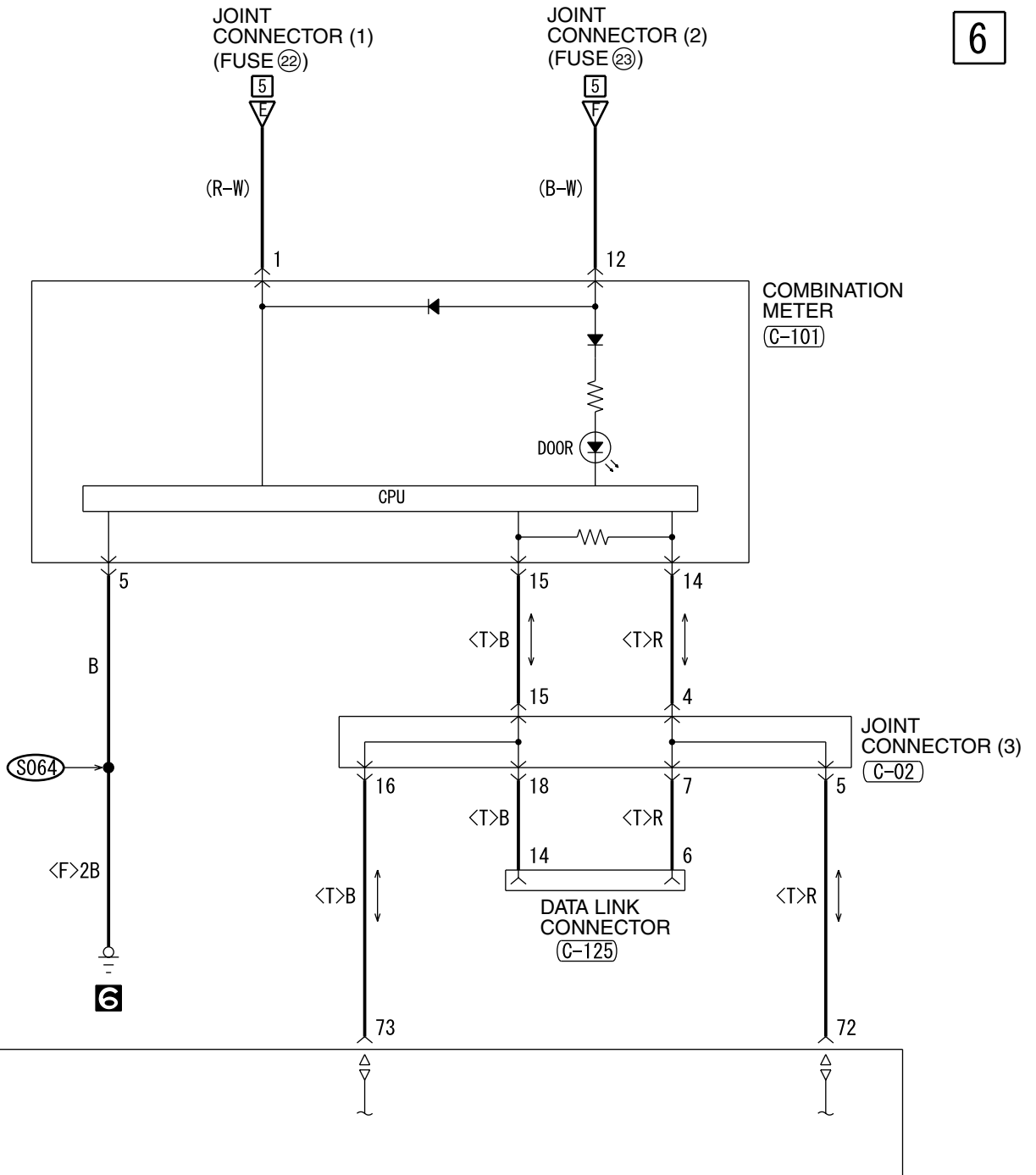

FRONT DOME LIGHT, REAR DOME LIGHT, TRUNK LIGHT AND IGNITION KEY HOLE ILLUMINATION LIGHT (CONTINUED)

7

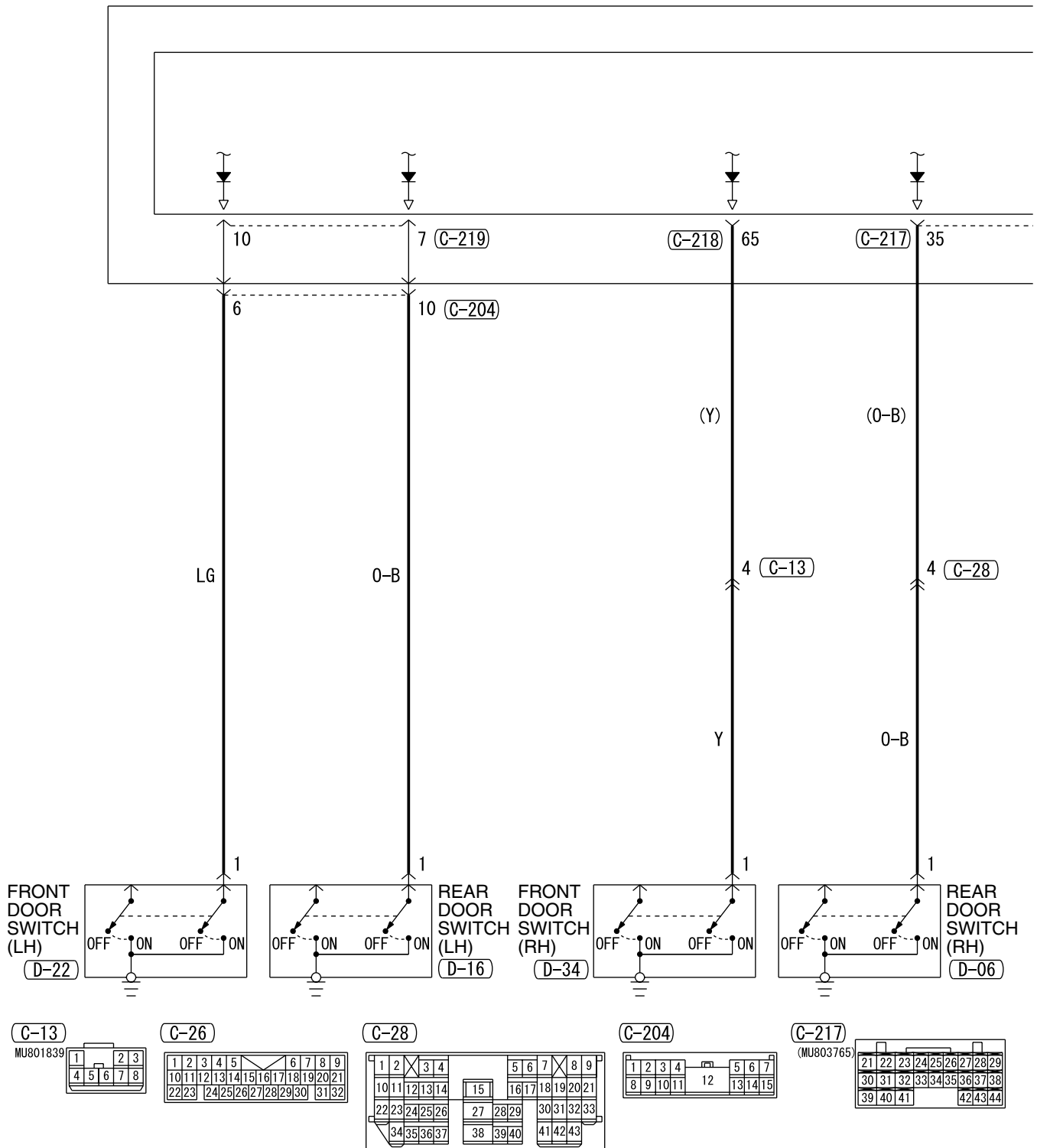

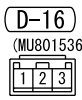
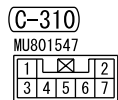
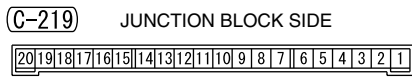
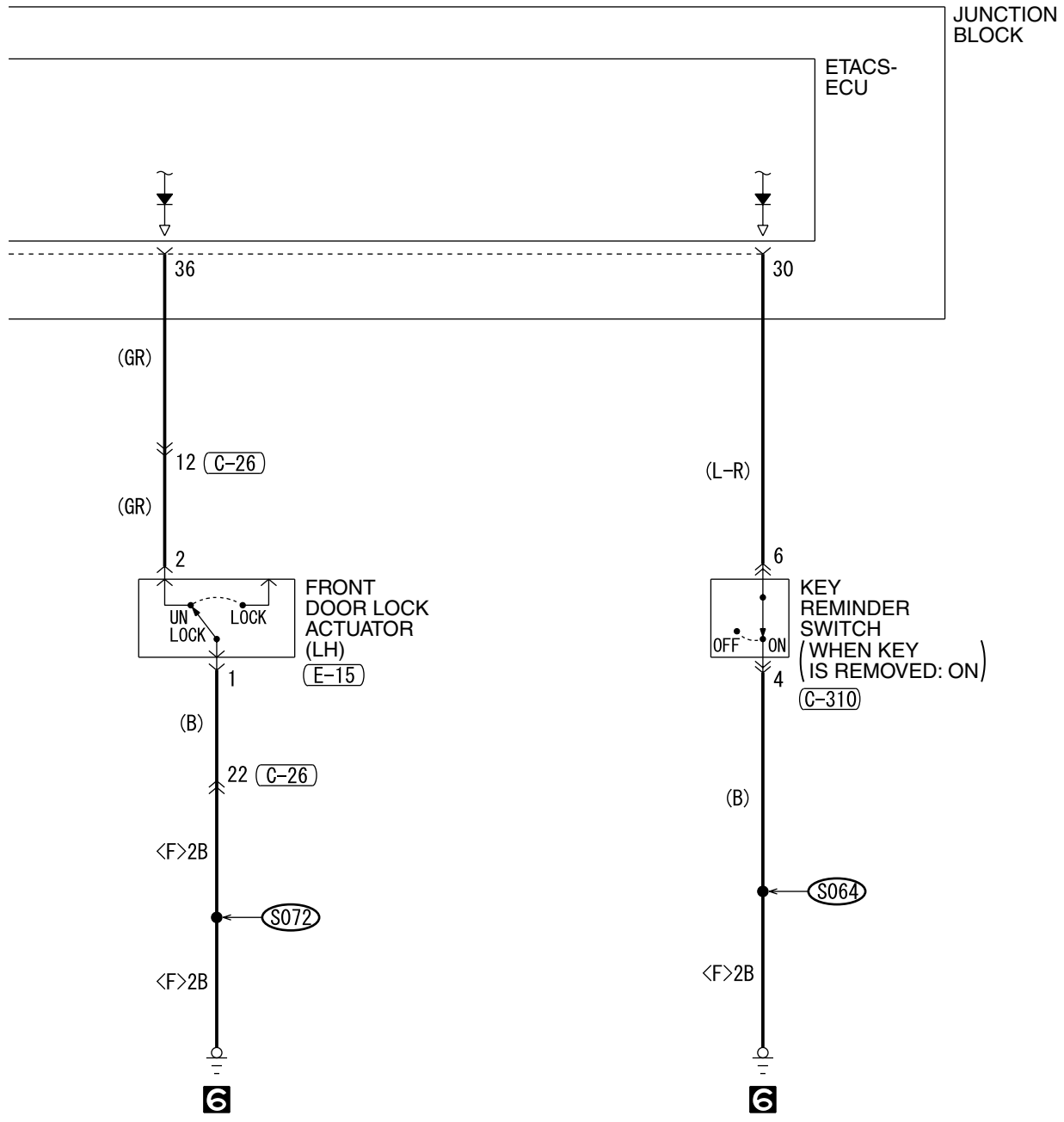

WIRE COLOR CODE  
 B: BLACK LG: LIGHT GREEN G: GREEN L: BLUE W: WHITE Y: YELLOW  
 SB: SKY BLUE BR: BROWN O: ORANGE GR: GRAY R: RED P: PINK V: VIOLET

# GLOVE BOX LIGHT

M1901002200592

1

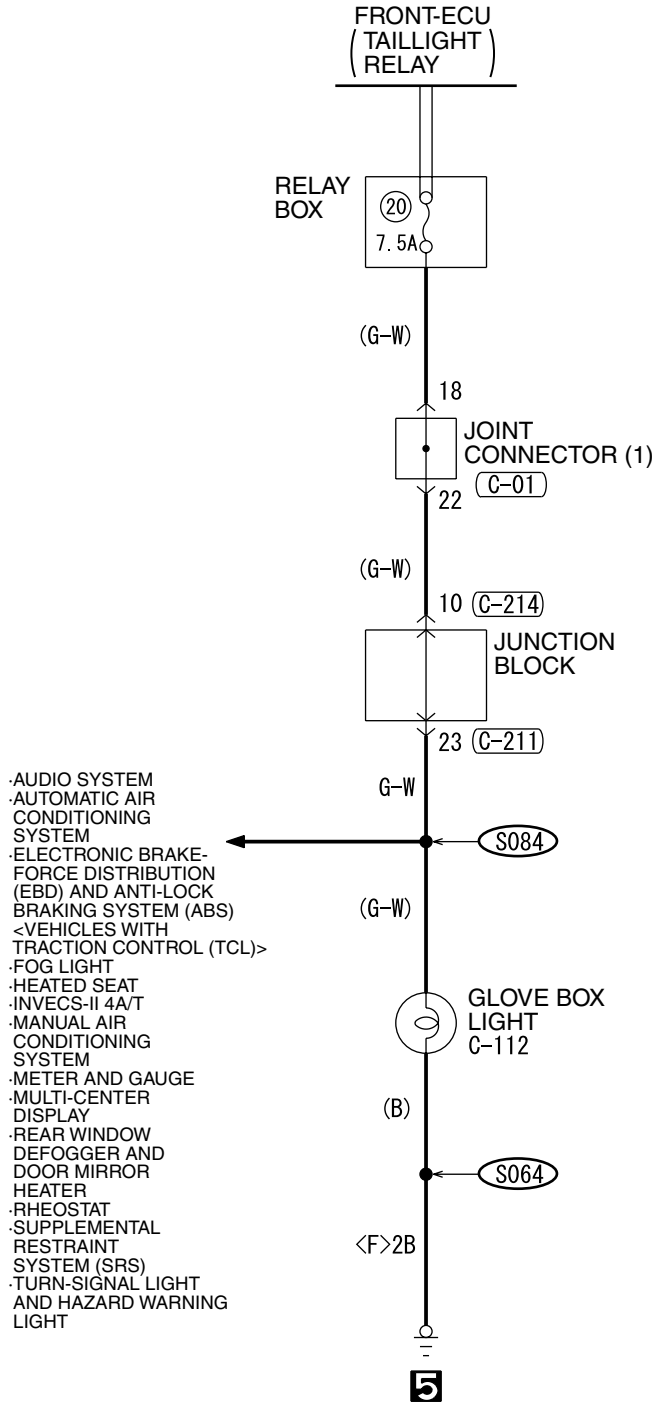

(C-01)



(C-211)

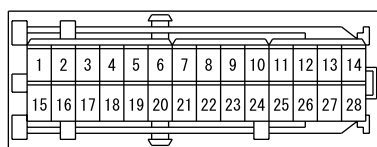

(C-214)

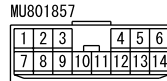

WIRE COLOR CODE  
 B : BLACK SB : SKY BLUE  
 BR : BROWN LG : LIGHT GREEN  
 G : GREEN P : PINK GR : GRAY  
 R : RED L : BLUE Y : YELLOW  
 V : VIOLET W : WHITE O : ORANGE

H5P08M08AA

# VANITY MIRROR LIGHT

1

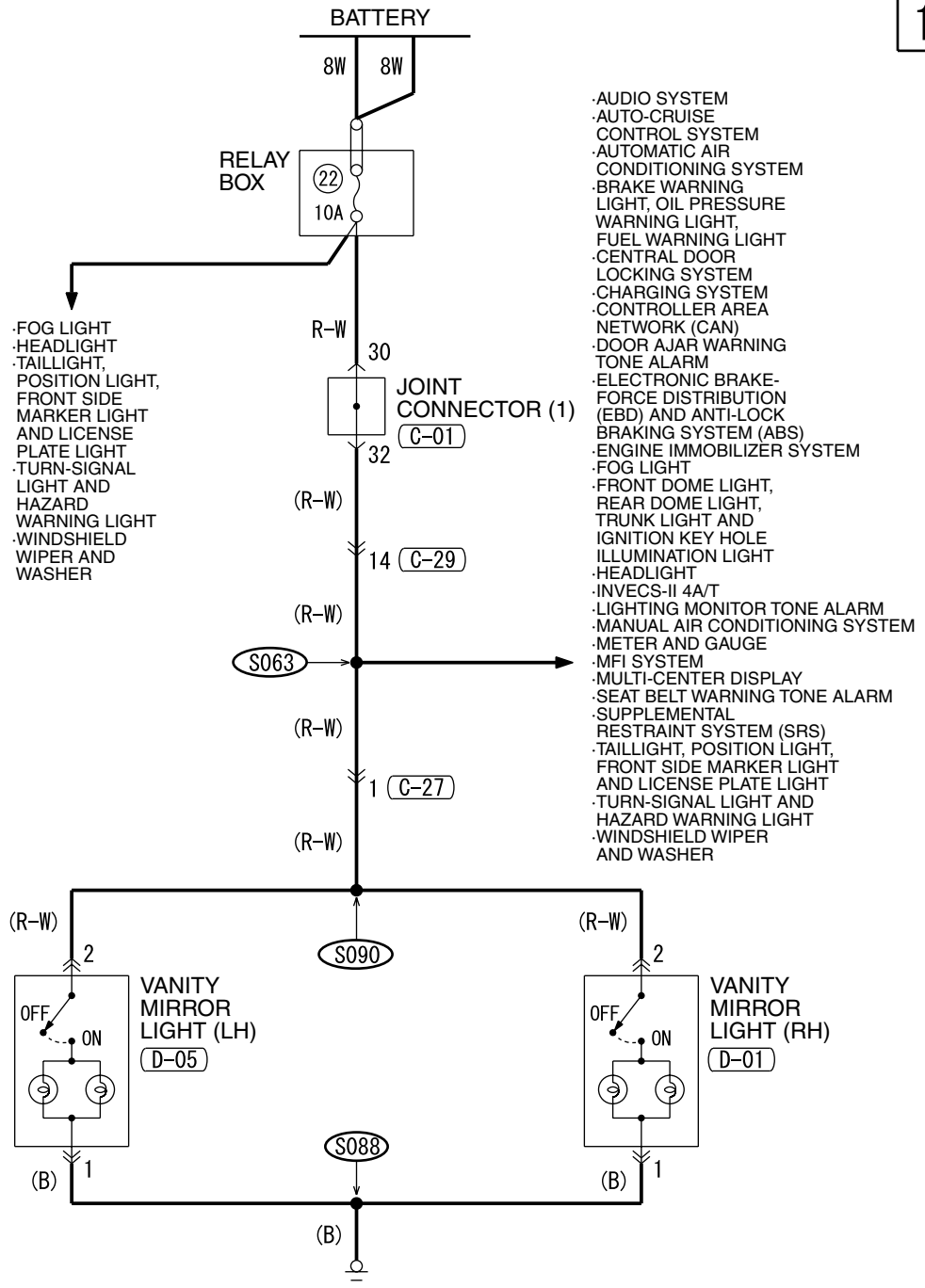

- FOG LIGHT
- HEADLIGHT
- TAILLIGHT,
- POSITION LIGHT,
- FRONT SIDE MARKER LIGHT AND LICENSE PLATE LIGHT
- TURN-SIGNAL LIGHT AND HAZARD WARNING LIGHT
- WINDSHIELD WIPER AND WASHER

- AUDIO SYSTEM
- AUTO-CRUISE CONTROL SYSTEM
- AUTOMATIC AIR CONDITIONING SYSTEM
- BRAKE WARNING LIGHT, OIL PRESSURE WARNING LIGHT, FUEL WARNING LIGHT
- CENTRAL DOOR LOCKING SYSTEM
- CHARGING SYSTEM
- CONTROLLER AREA NETWORK (CAN)
- DOOR AJAR WARNING TONE ALARM
- ELECTRONIC BRAKE-FORCE DISTRIBUTION (EBD) AND ANTI-LOCK BRAKING SYSTEM (ABS)
- ENGINE IMMOBILIZER SYSTEM
- FOG LIGHT
- FRONT DOME LIGHT, REAR DOME LIGHT, TRUNK LIGHT AND IGNITION KEY HOLE ILLUMINATION LIGHT
- HEADLIGHT
- INVECS-II 4A/T
- LIGHTING MONITOR TONE ALARM
- MANUAL AIR CONDITIONING SYSTEM
- METER AND GAUGE
- MFI SYSTEM
- MULTI-CENTER DISPLAY
- SEAT BELT WARNING TONE ALARM
- SUPPLEMENTAL RESTRAINT SYSTEM (SRS)
- TAILLIGHT, POSITION LIGHT, FRONT SIDE MARKER LIGHT AND LICENSE PLATE LIGHT
- TURN-SIGNAL LIGHT AND HAZARD WARNING LIGHT
- WINDSHIELD WIPER AND WASHER

4

(C-01)

1	2	3	4	5	6	7	8	9	10	11
12	13	14	15	16	17	18	19	20	21	22
23	24	25	26	27	28	29	30	31	32	33

(C-27)

1	2
3	4

(C-29)

1	2	3	4	5	6	7	8	9	10	11	12	13
14	15	16	17	18	19	20	21	22	23	24	25	
26	27	28	29			30	31			38		
32	33	34			35		36	37				

(D-01)

1	2
---	---

(D-05)

1	2
---	---

**WIRE COLOR CODE**  
 B : BLACK SB : SKY BLUE  
 BR : BROWN LG : LIGHT GREEN  
 G : GREEN P : PINK GR : GRAY  
 R : RED L : BLUE Y : YELLOW  
 V : VIOLET W : WHITE O : ORANGE

# TURN-SIGNAL LIGHT AND HAZARD WARNING LIGHT

M1901002901163

1

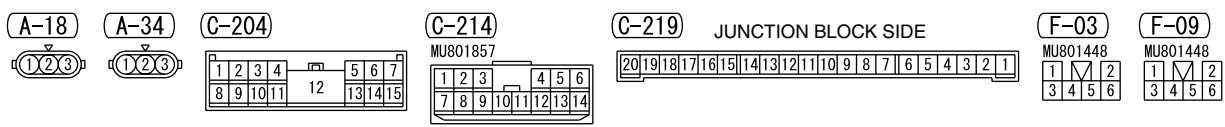
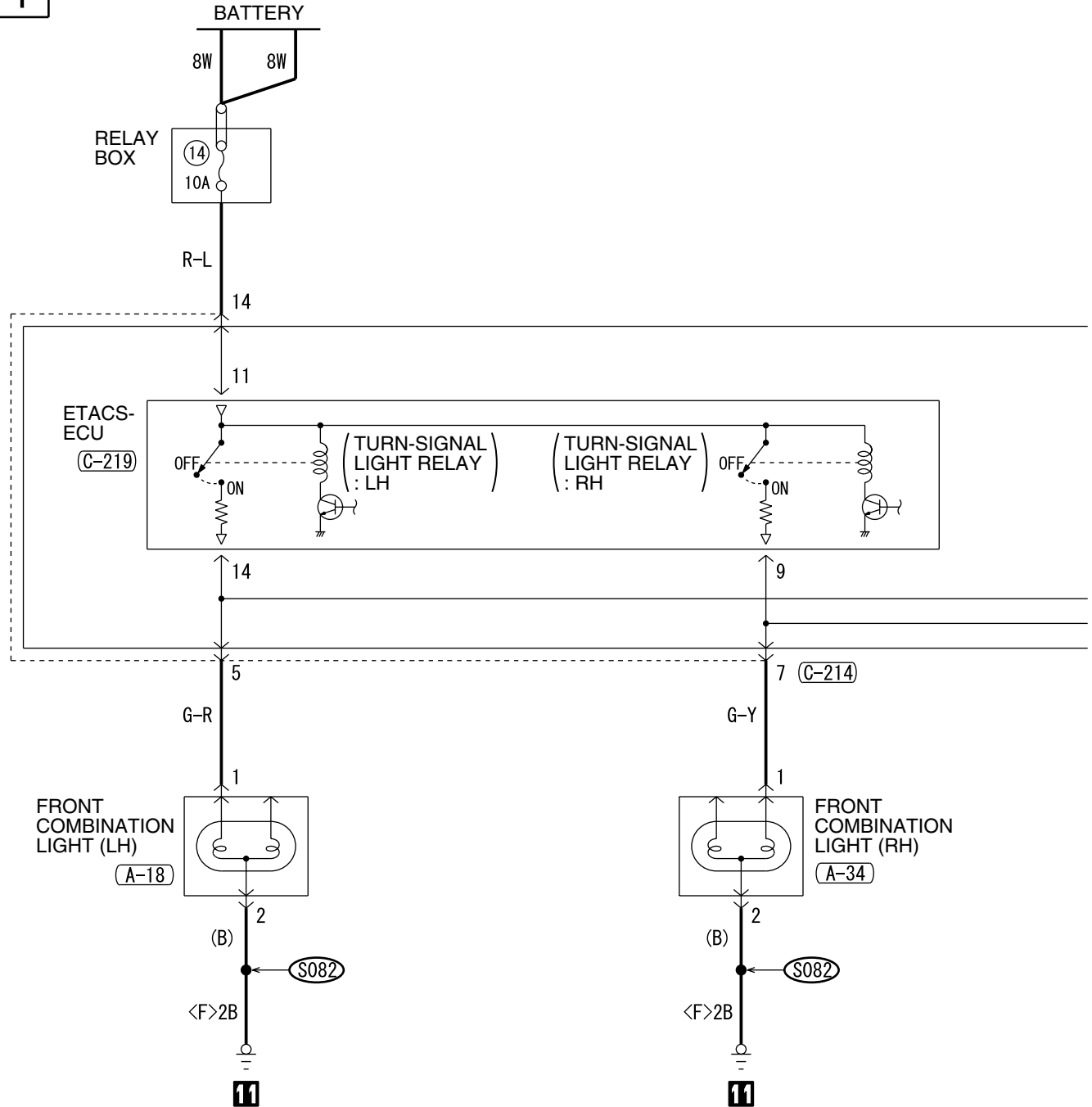



2

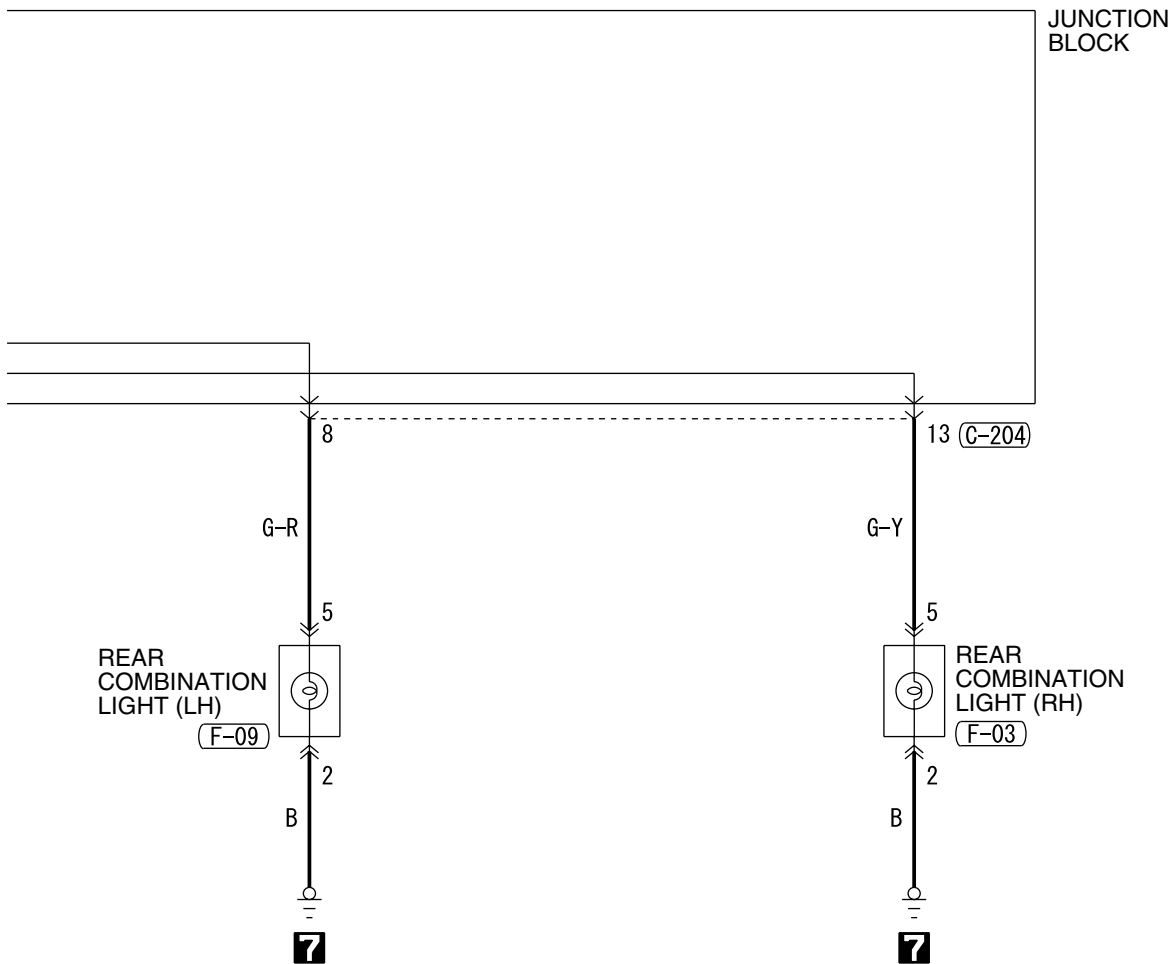

WIRE COLOR CODE  
B : BLACK LG : LIGHT GREEN G : GREEN L : BLUE W : WHITE Y : YELLOW  
SB : SKY BLUE BR : BROWN O : ORANGE GR : GRAY R : RED P : PINK V : VIOLET

H5P09M00AB

TSB Revision

TURN-SIGNAL LIGHT AND HAZARD WARNING LIGHT (CONTINUED)

3

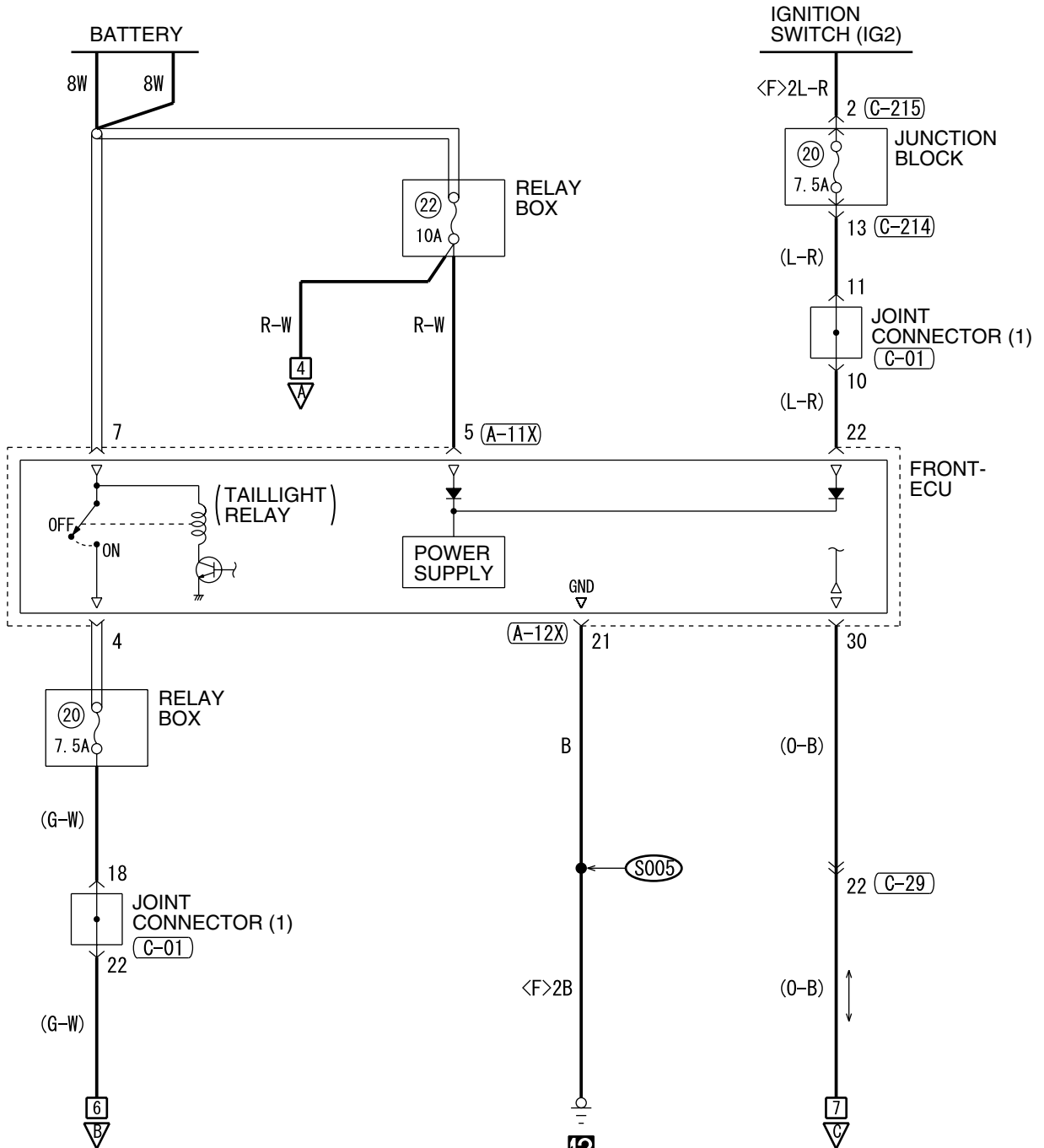

(A-11X)

1	2	3	4	5	6	7	8	9	10	11
---	---	---	---	---	---	---	---	---	----	----

(A-12X)

21	22	23	24	25	26	27	28	29	30	31
----	----	----	----	----	----	----	----	----	----	----

(C-01)

1	2	3	4	5	6	7	8	9	10	11
12	13	14	15	16	17	18	19	20	21	22
23	24	25	26	27	28	29	30	31	32	33

(C-03)

1	2	3	4	5	6	7	8	9	10	11
12	13	14	15	16	17	18	19	20	21	22
23	24	25	26	27	28	29	30	31	32	33

(C-29)

1	2	3	4	5	6	7	8	9	10	11	12	13
14	15	16	17	18	19	20	21	22	23	24	25	
26	27	28	29					30	31		38	
32	33	34		35				36	37			

4

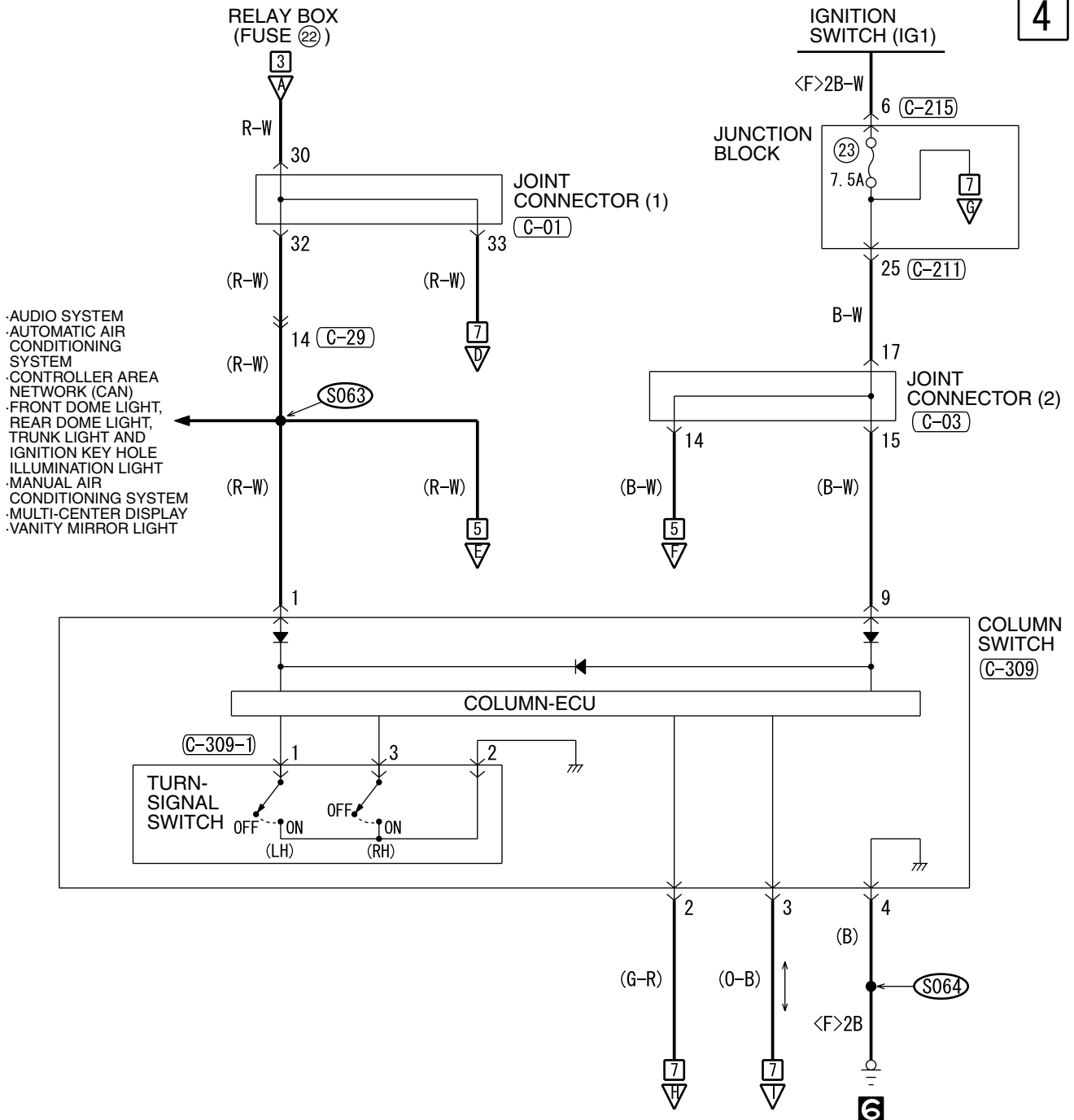

(C-211)

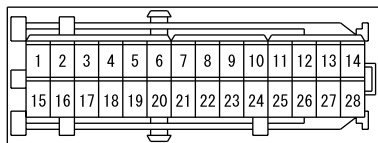

(C-214)

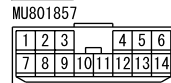

(C-215)



(C-309)

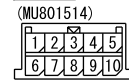

(C-309-1)

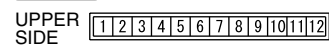

TURN-SIGNAL LIGHT AND HAZARD WARNING LIGHT (CONTINUED)

5

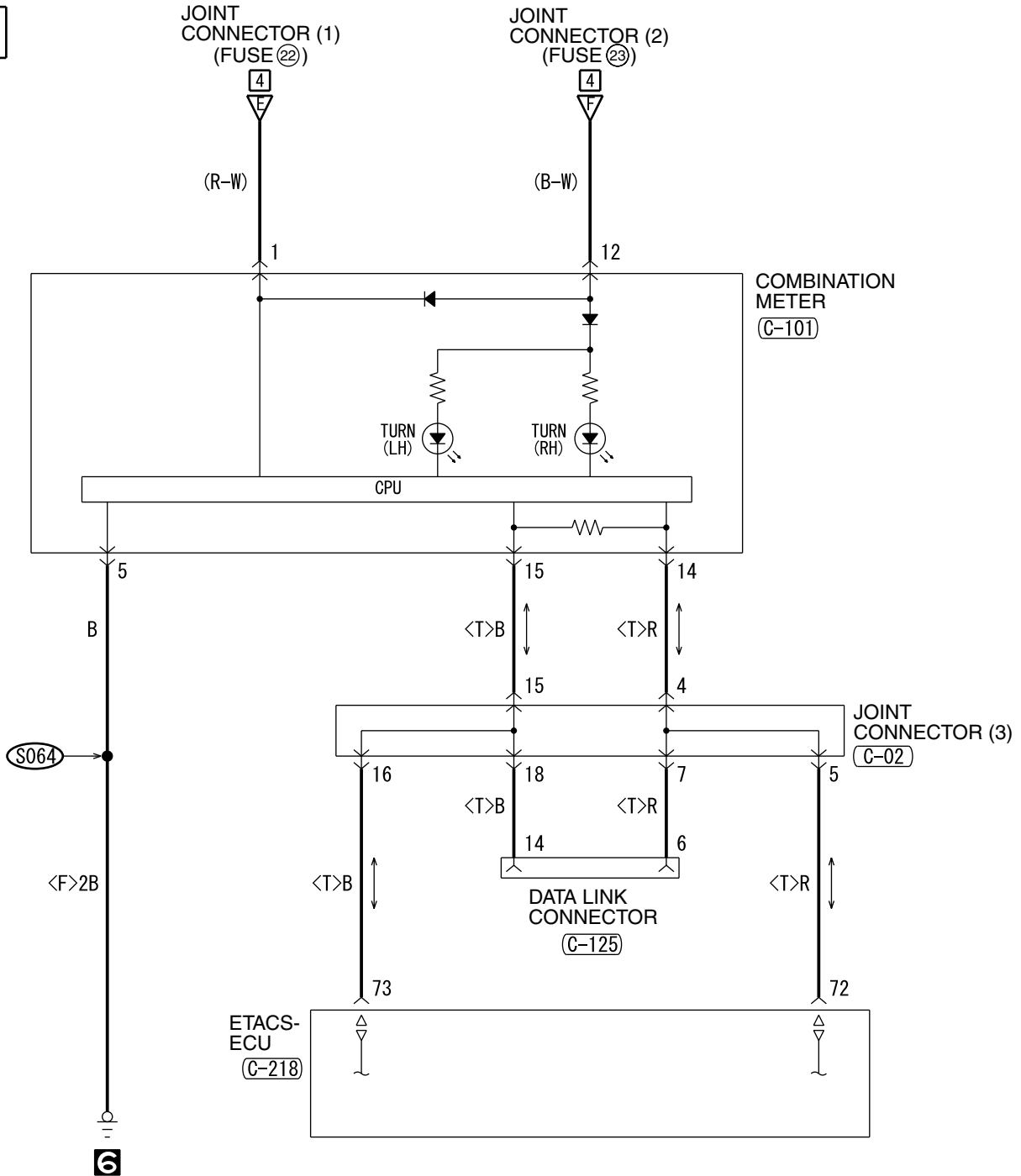

(C-02)

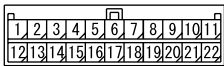

(C-08)

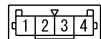

(C-101)

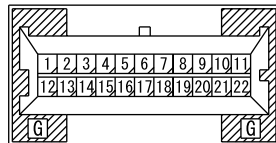

(C-125)

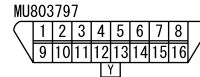

(C-211)

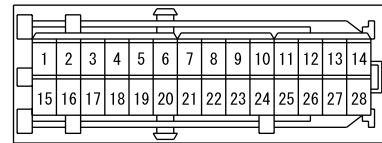

6

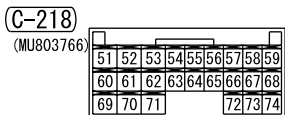
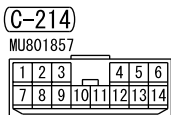
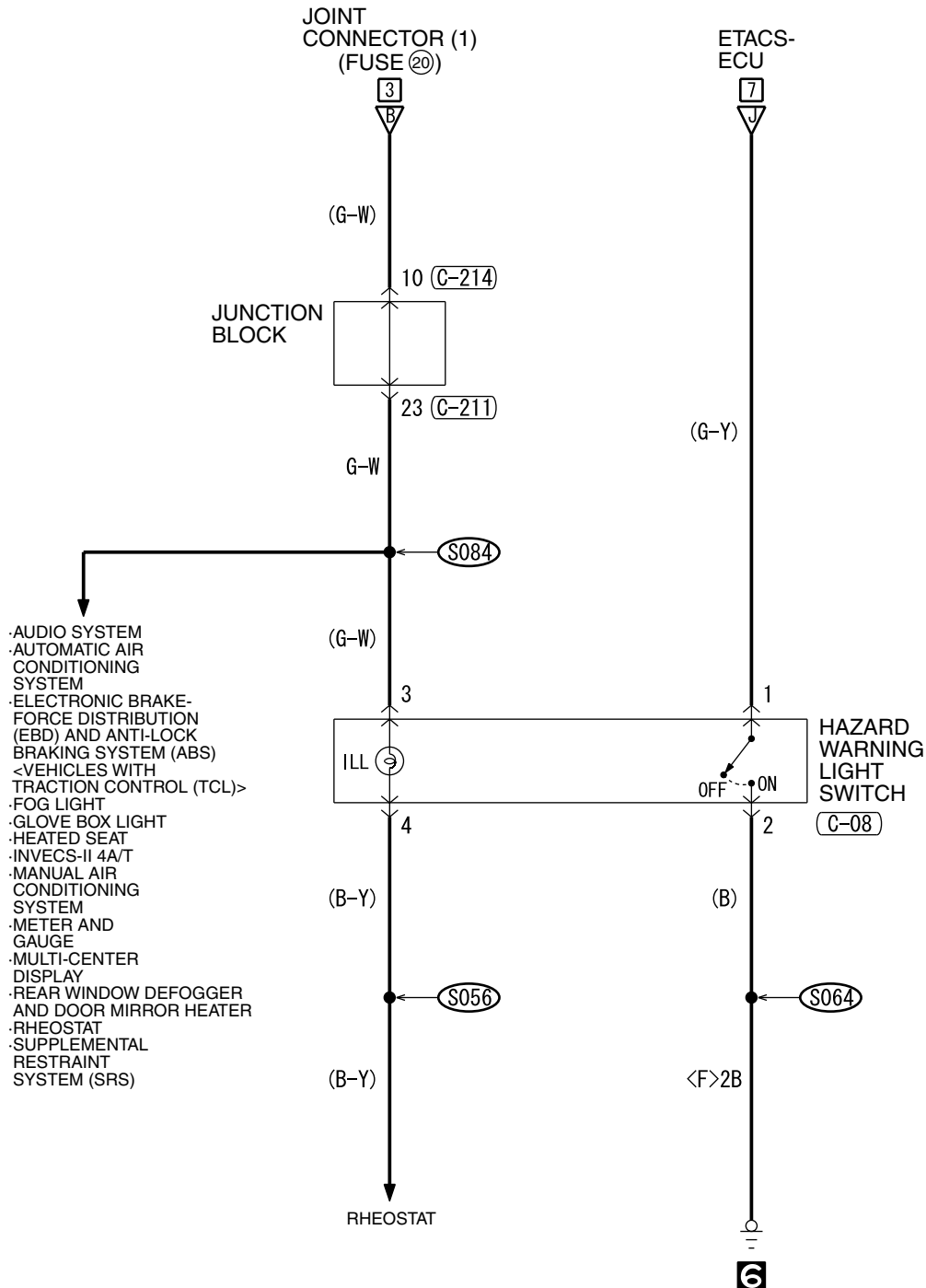

WIRE COLOR CODE  
 B : BLACK LG : LIGHT GREEN G : GREEN L : BLUE W : WHITE Y : YELLOW  
 SB : SKY BLUE BR : BROWN O : ORANGE GR : GRAY R : RED P : PINK V : VIOLET

H5P09M00CB

TURN-SIGNAL LIGHT AND HAZARD WARNING LIGHT (CONTINUED)

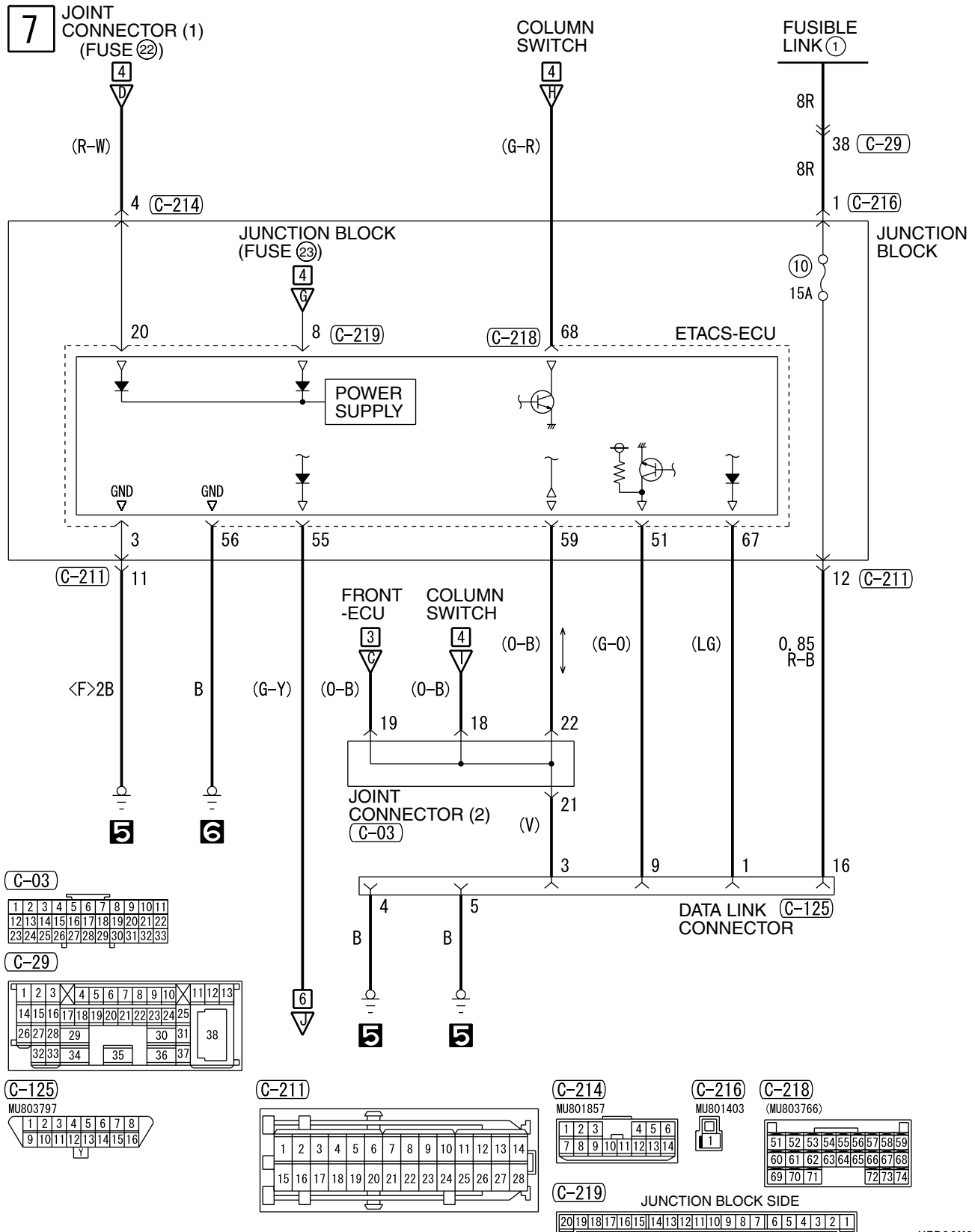

NOTES

# BACKUP LIGHT

M1901003101267

1

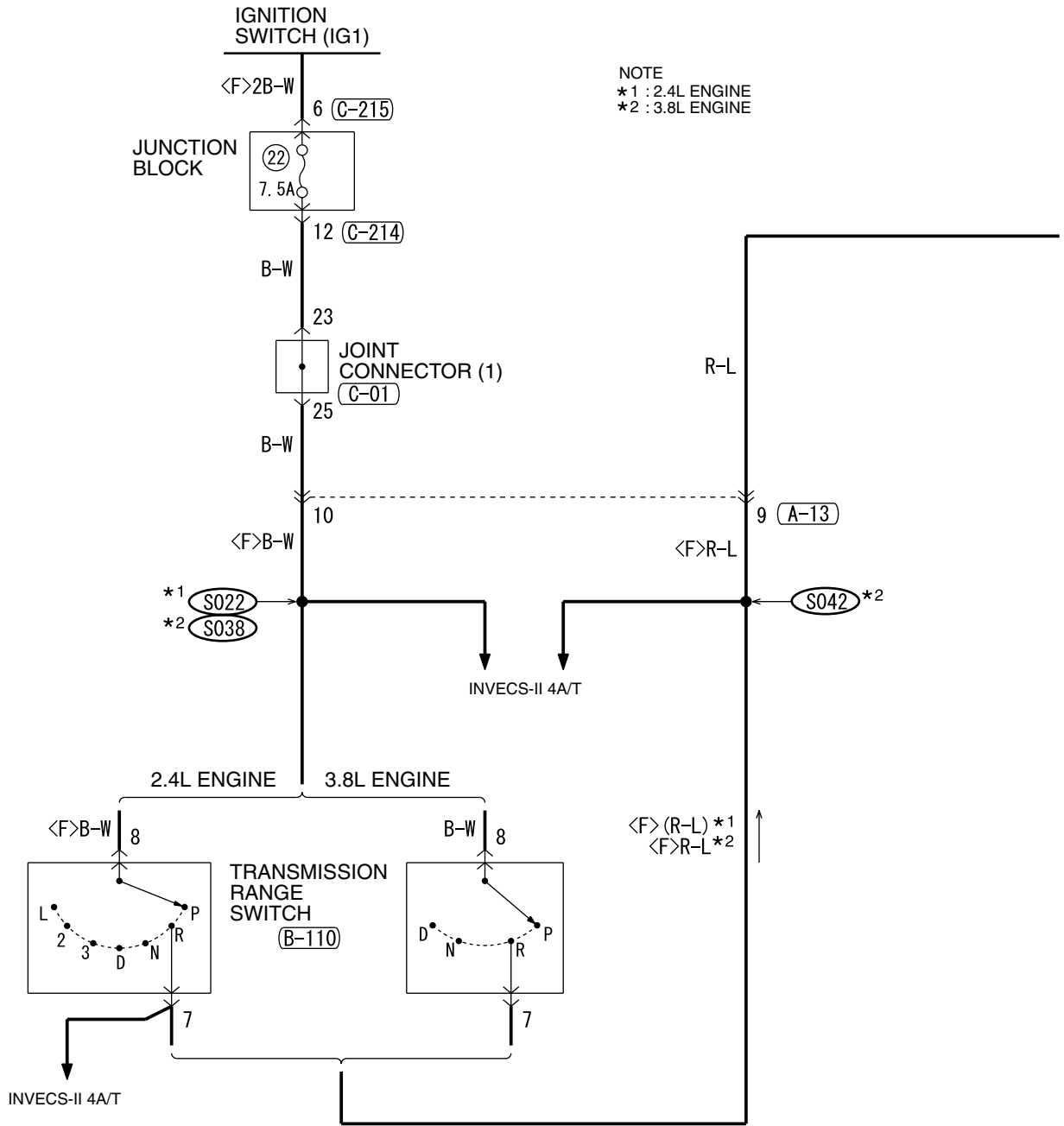

(A-13)

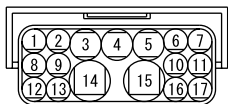

(B-110)

MU802355

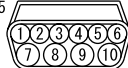

(C-01)



(C-25)

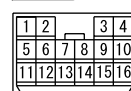

(C-214)

MU801857

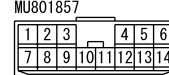

(C-215)

MU801331



(F-03)

MU801448



(F-09)

MU801448



H5P09M01AA



2

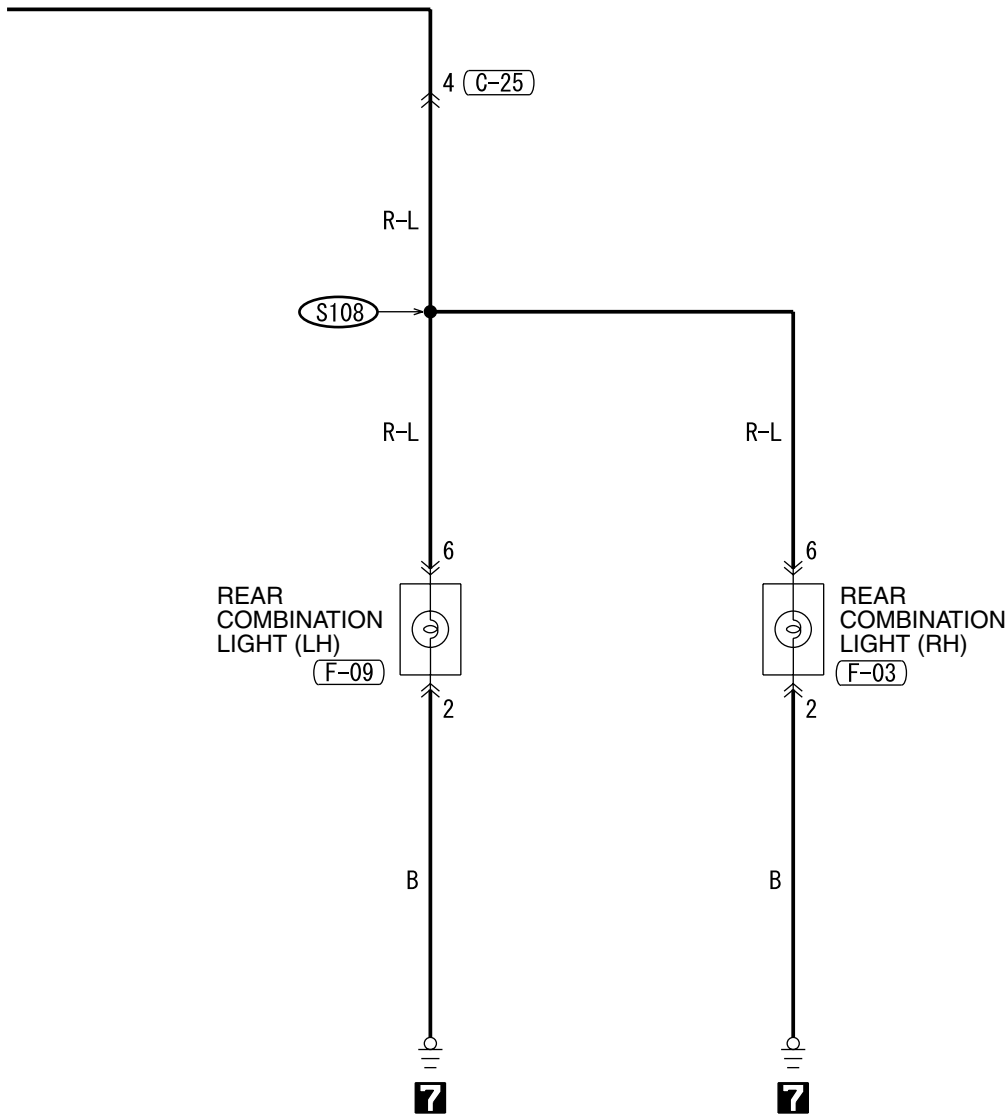

WIRE COLOR CODE  
B : BLACK LG : LIGHT GREEN G : GREEN L : BLUE W : WHITE Y : YELLOW  
SB : SKY BLUE BR : BROWN O : ORANGE GR : GRAY R : RED P : PINK V : VIOLET

H5P09M01AB

TSB Revision

STOPLIGHT

M1901003001196

1

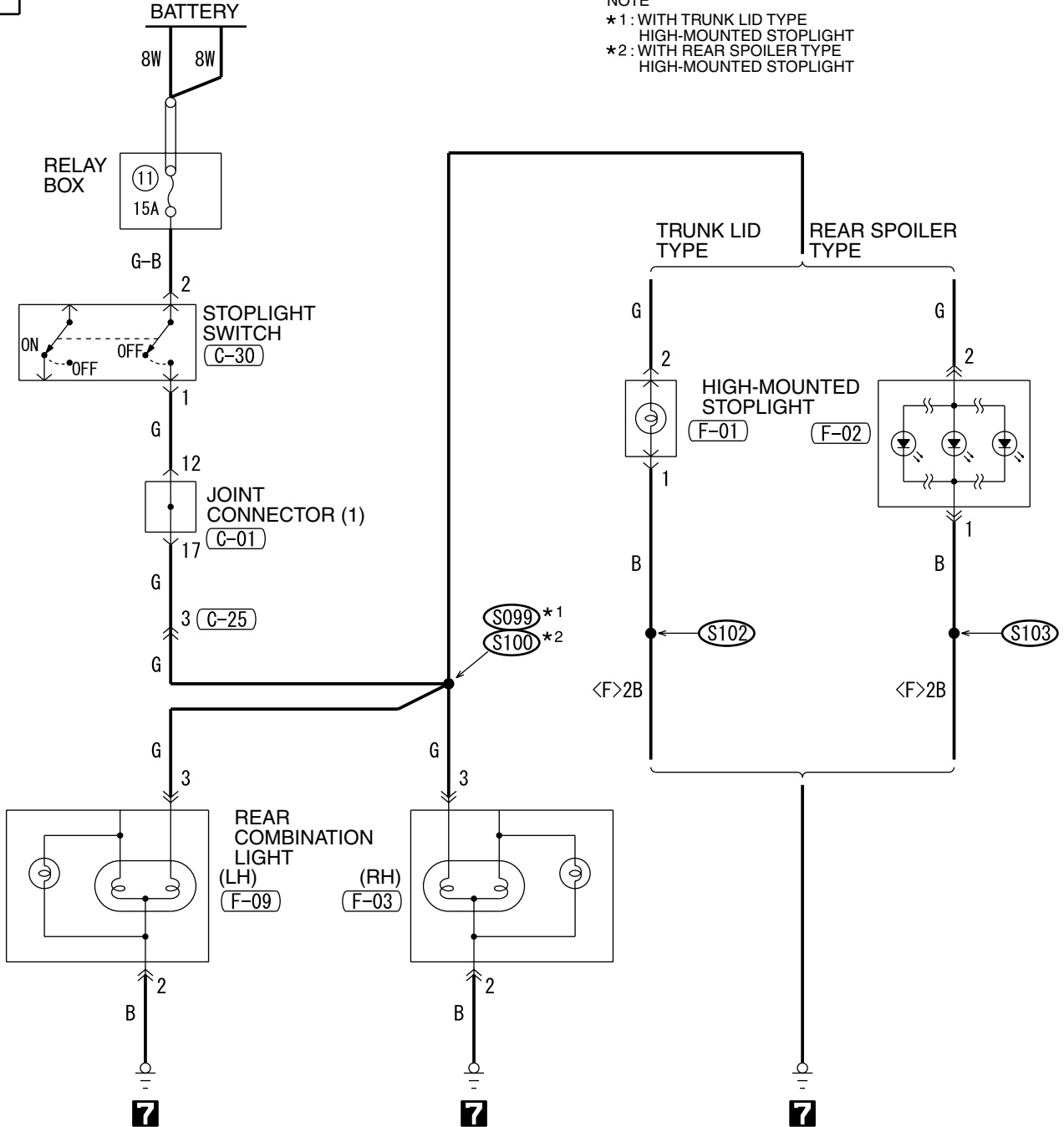

NOTE  
 \*1: WITH TRUNK LID TYPE  
 HIGH-MOUNTED STOPLIGHT  
 \*2: WITH REAR SPOILER TYPE  
 HIGH-MOUNTED STOPLIGHT

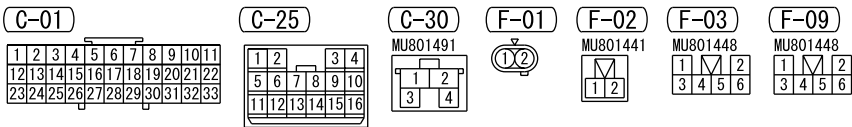

WIRE COLOR CODE  
 B: BLACK LG: LIGHT GREEN G: GREEN L: BLUE W: WHITE Y: YELLOW  
 SB: SKY BLUE BR: BROWN O: ORANGE GR: GRAY R: RED P: PINK V: VIOLET

H5P09M05AA

HORN

M1901003300934

1

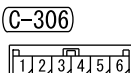
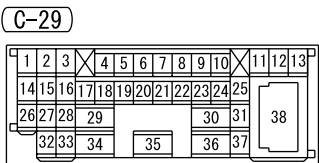
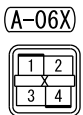
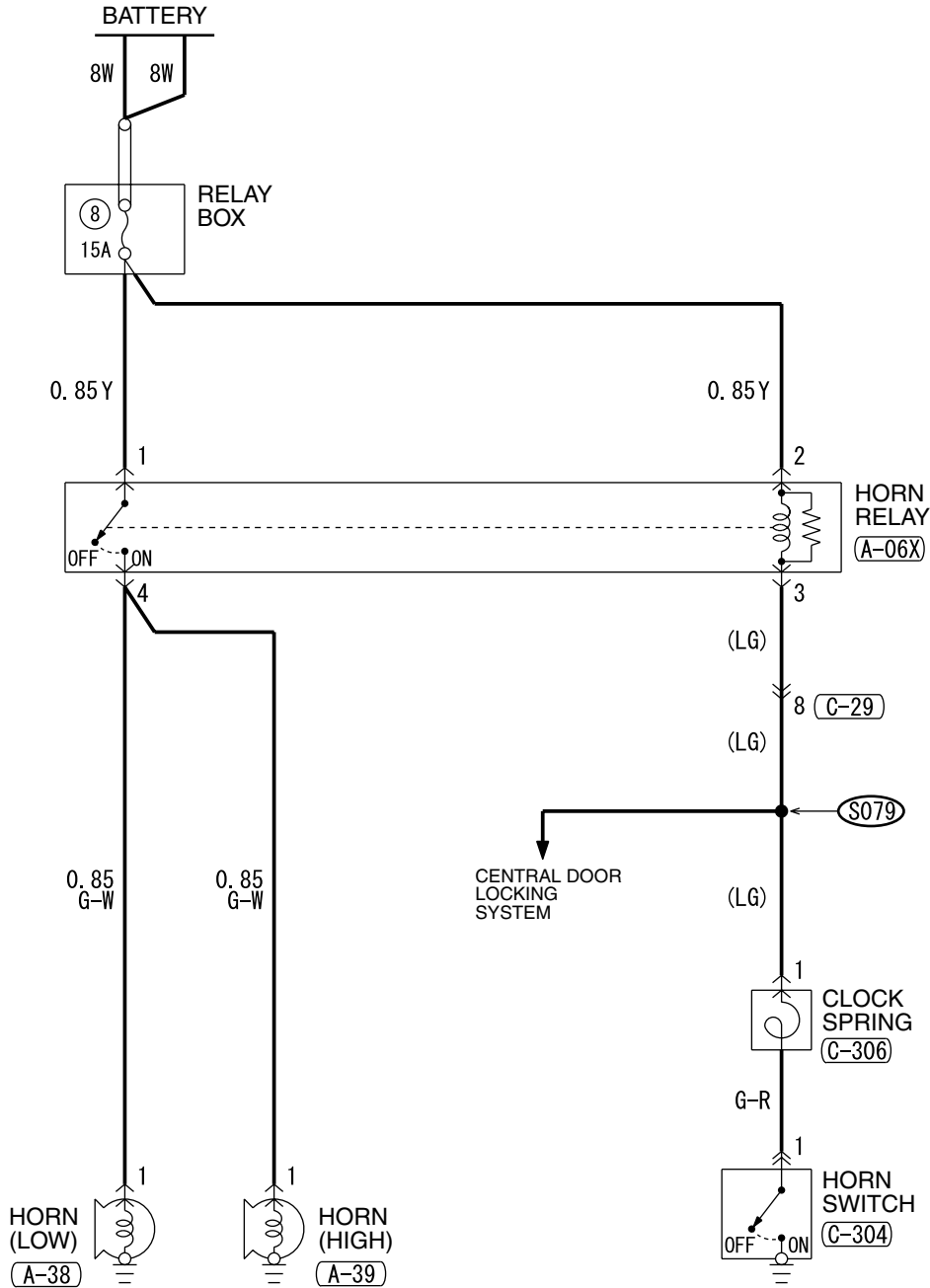

WIRE COLOR CODE  
 B : BLACK SB : SKY BLUE  
 BR : BROWN LG : LIGHT GREEN  
 G : GREEN P : PINK GR : GRAY  
 R : RED L : BLUE Y : YELLOW  
 V : VIOLET W : WHITE O : ORANGE

H5P09M06AA

METER AND GAUGE

M1901003501113

1

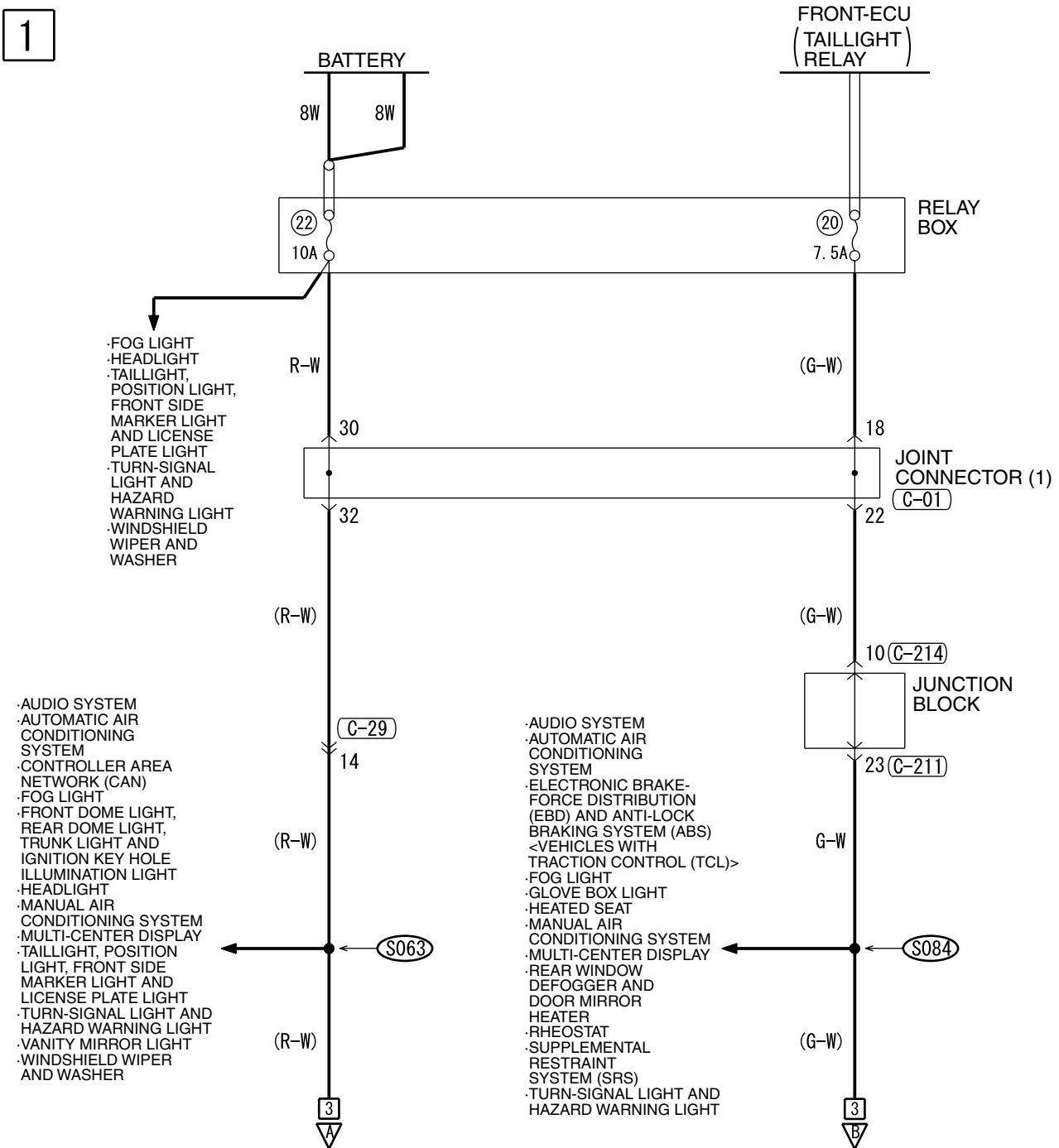

(B-20)



(B-21)

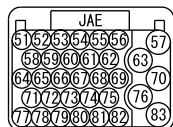

(B-22)

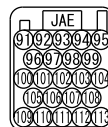

(B-23)



(B-104)



(C-01)

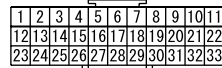

(C-25)

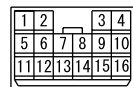

2

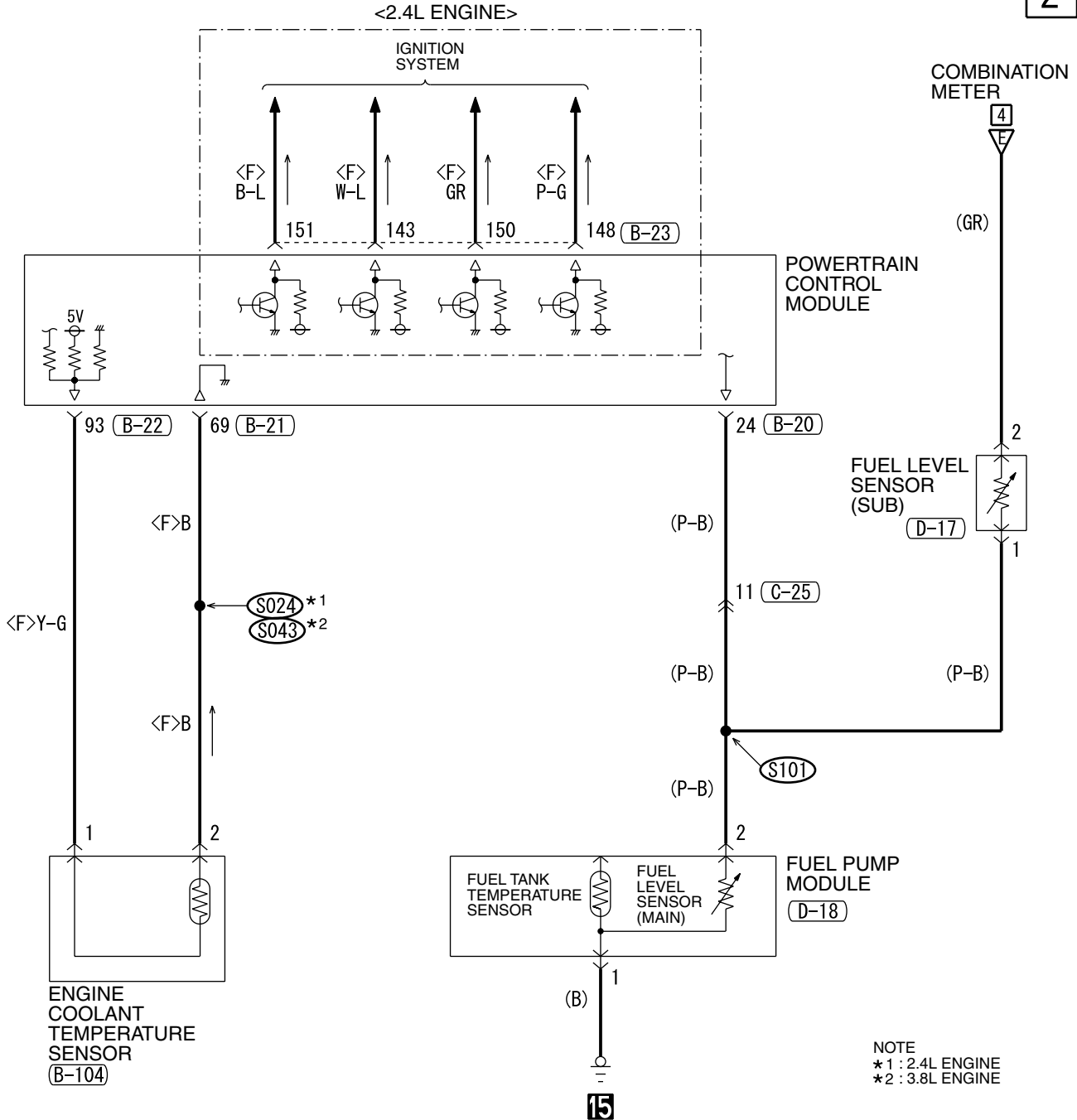

(C-29)

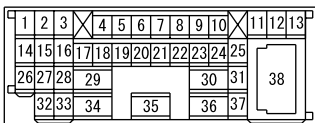

(C-211)

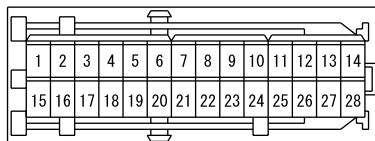

(C-214)

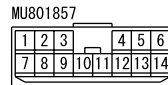

(D-17)



(D-18)



METER AND GAUGE (CONTINUED)

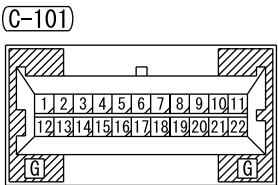
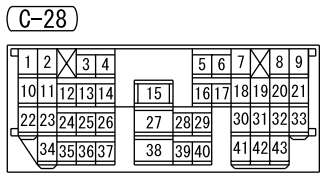
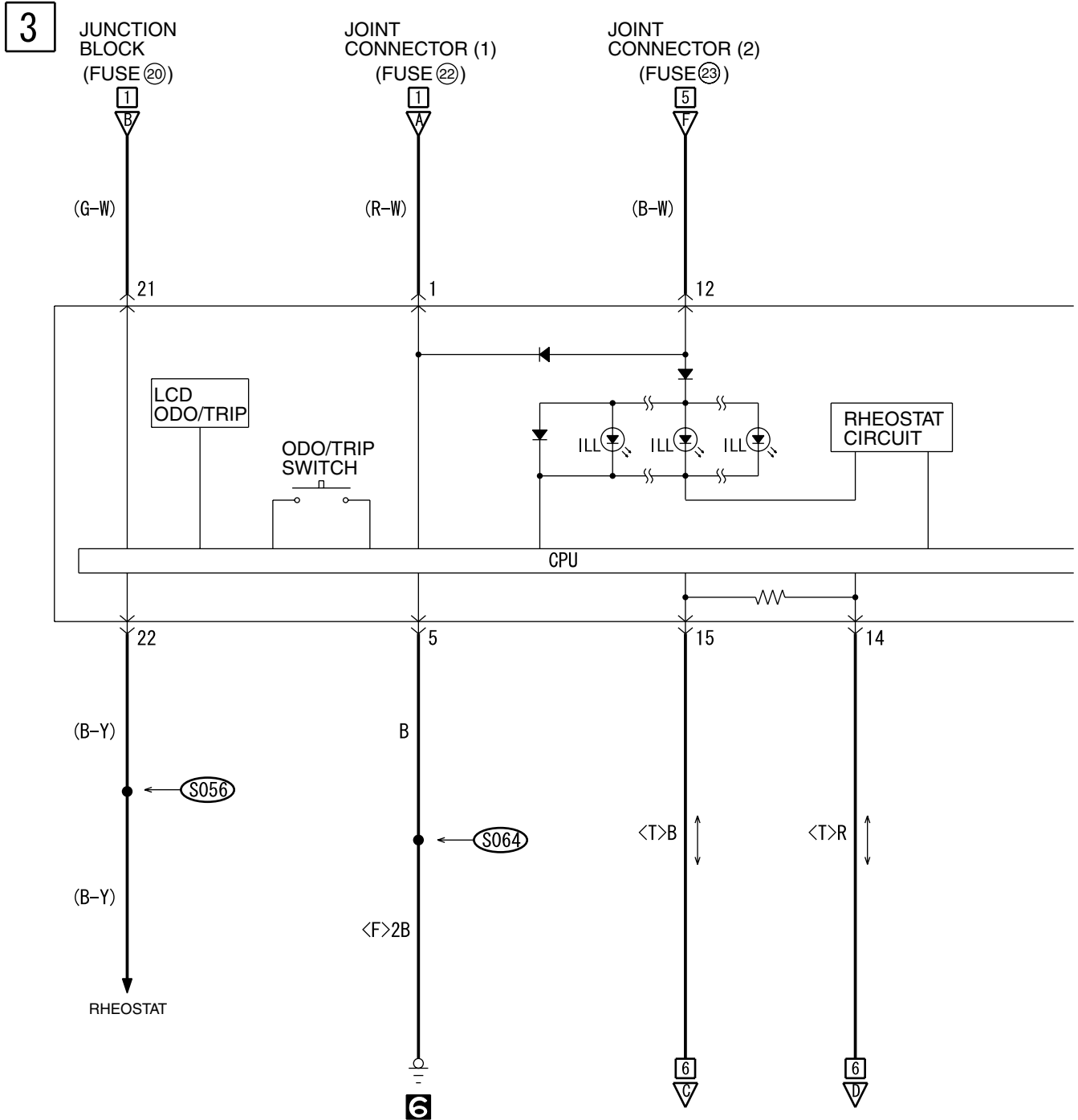

4

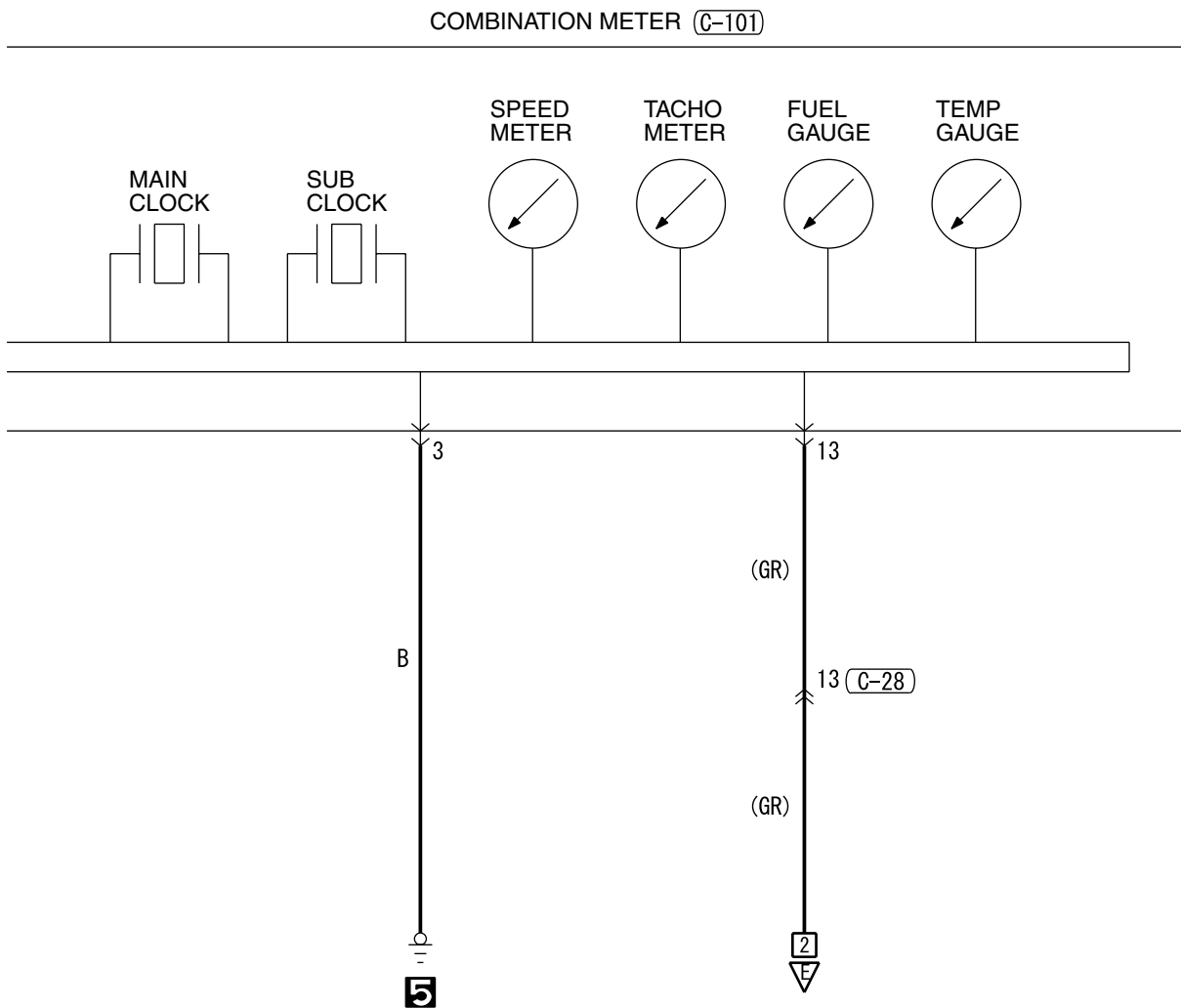

WIRE COLOR CODE  
 B : BLACK   LG : LIGHT GREEN   G : GREEN   L : BLUE   W : WHITE   Y : YELLOW  
 SB : SKY BLUE   BR : BROWN   O : ORANGE   GR : GRAY   R : RED   P : PINK   V : VIOLET

H5P10M00BB

TSB Revision

METER AND GAUGE (CONTINUED)

5

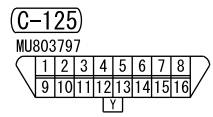
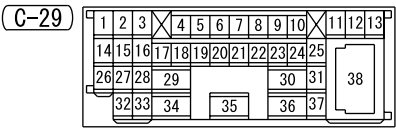
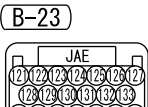
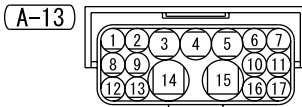
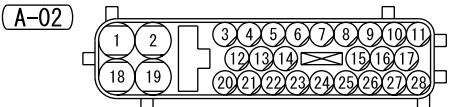
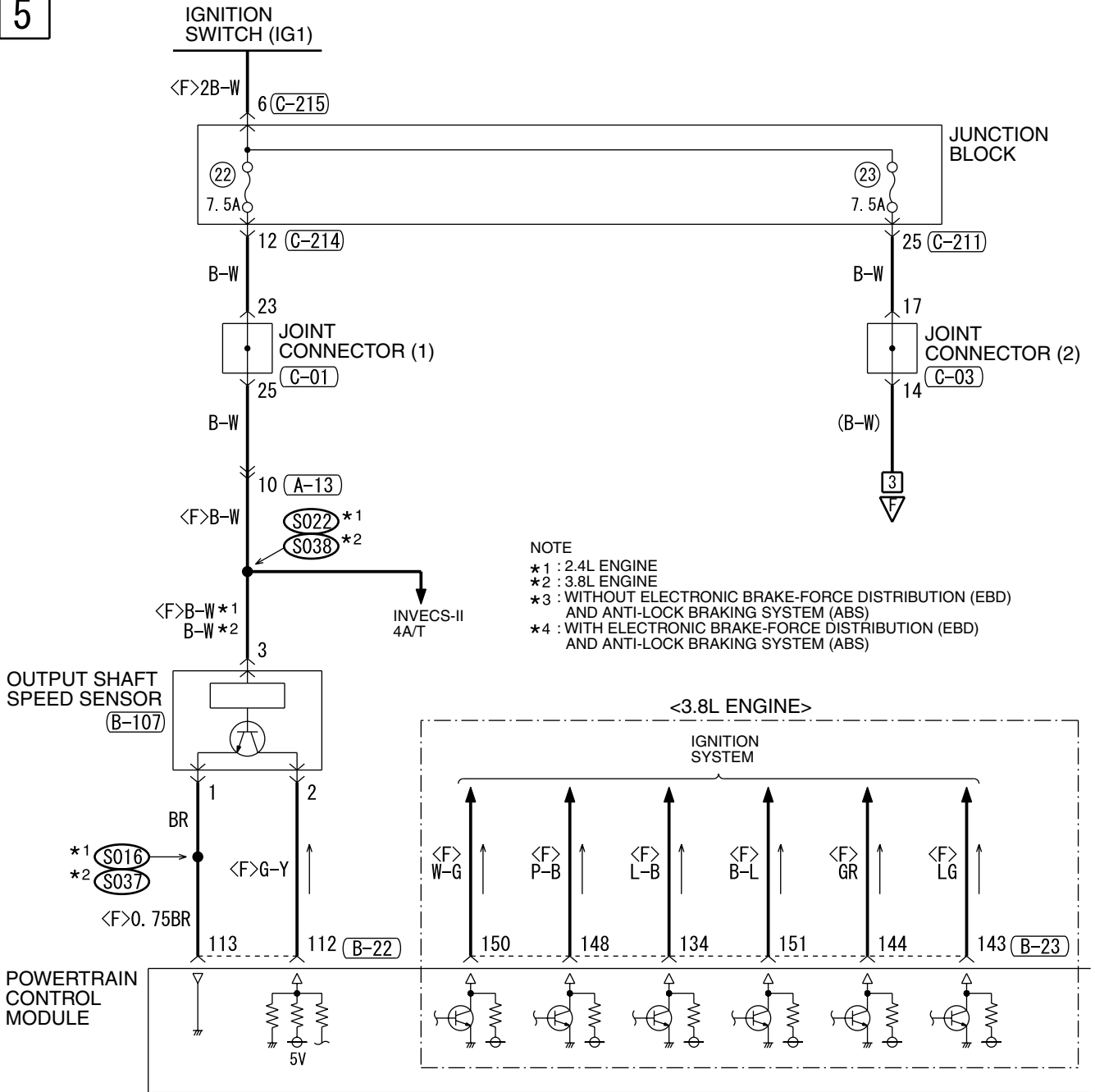



6

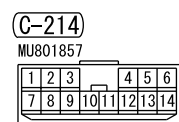
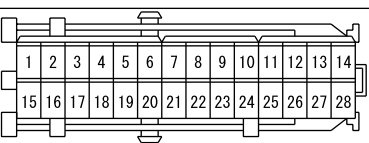
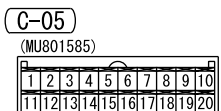
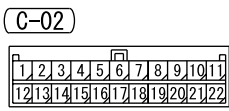
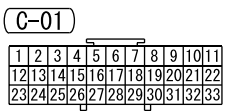
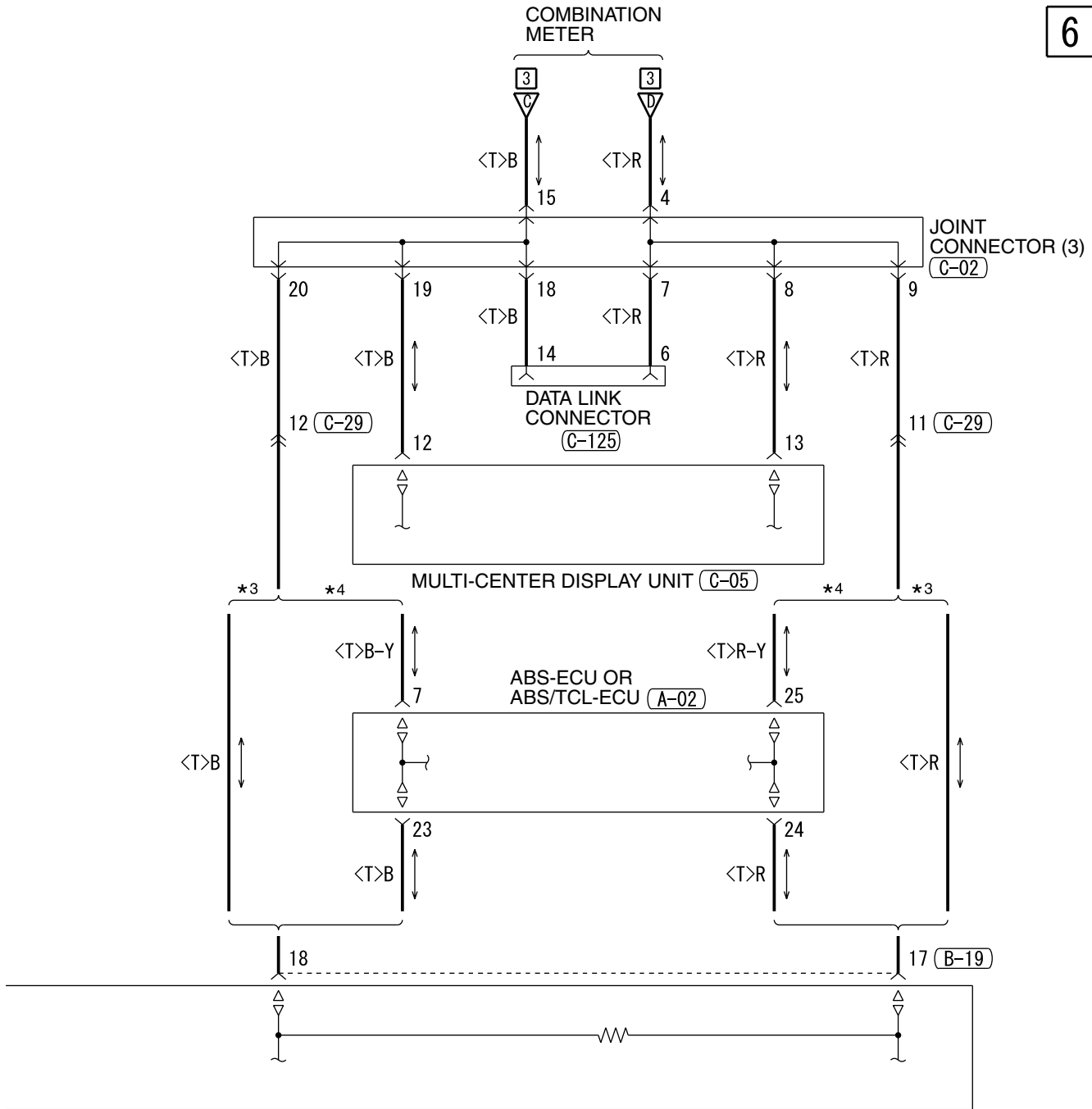

WIRE COLOR CODE  
 B : BLACK SB : SKY BLUE  
 BR : BROWN LG : LIGHT GREEN  
 G : GREEN P : PINK GR : GRAY  
 R : RED L : BLUE Y : YELLOW  
 V : VIOLET W : WHITE O : ORANGE H5P10M00CB

# BRAKE WARNING LIGHT, OIL PRESSURE WARNING LIGHT, FUEL WARNING LIGHT

M1901011800848

1

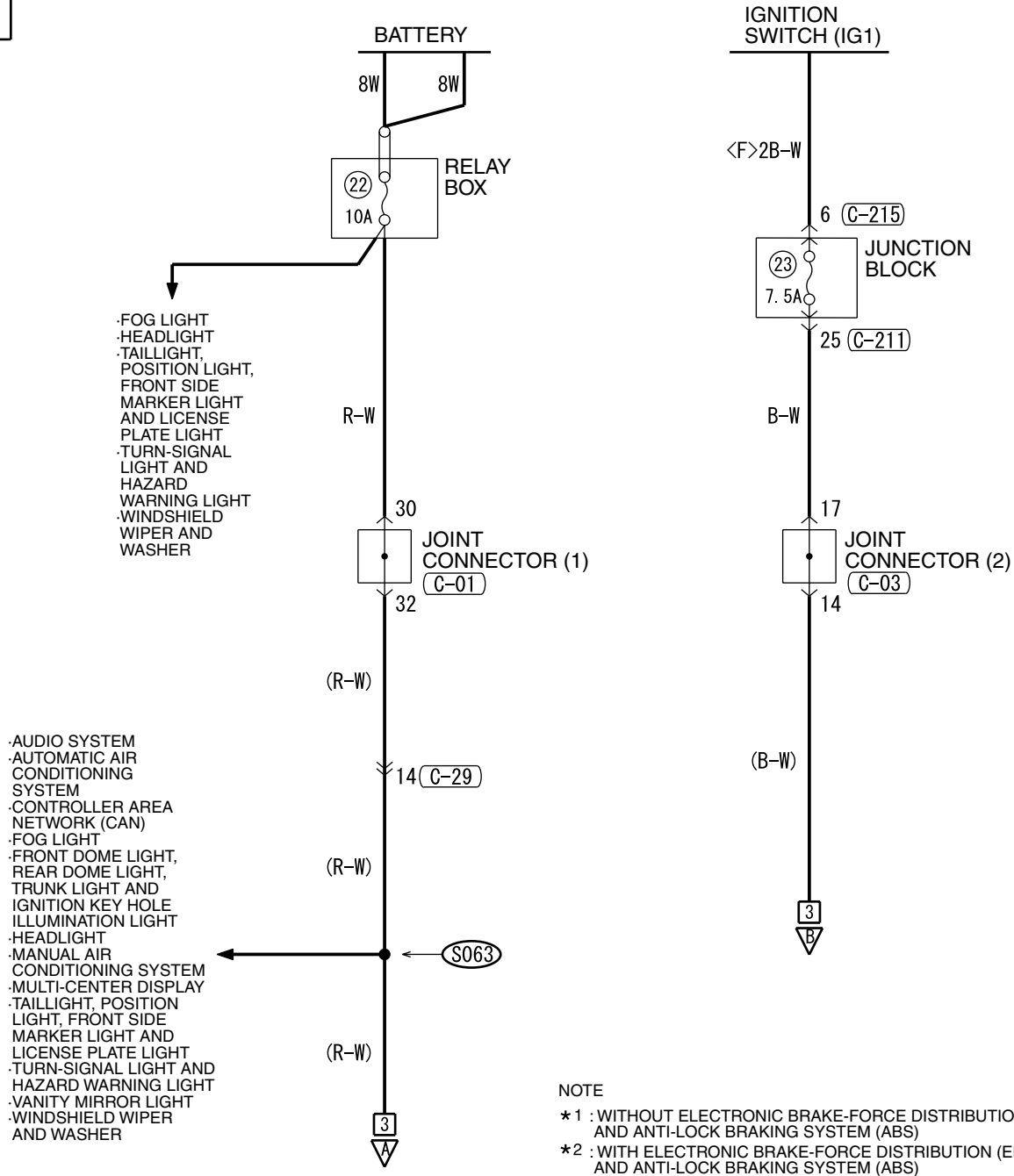

A-02

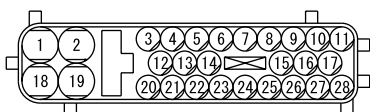

B-19

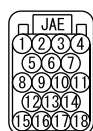

C-01



C-02

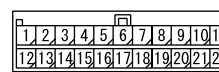

C-03



2

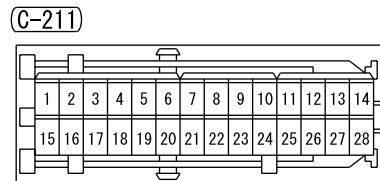
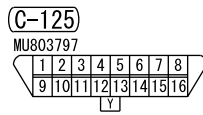
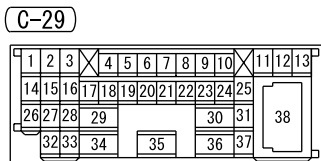
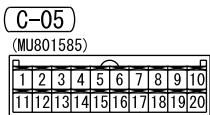
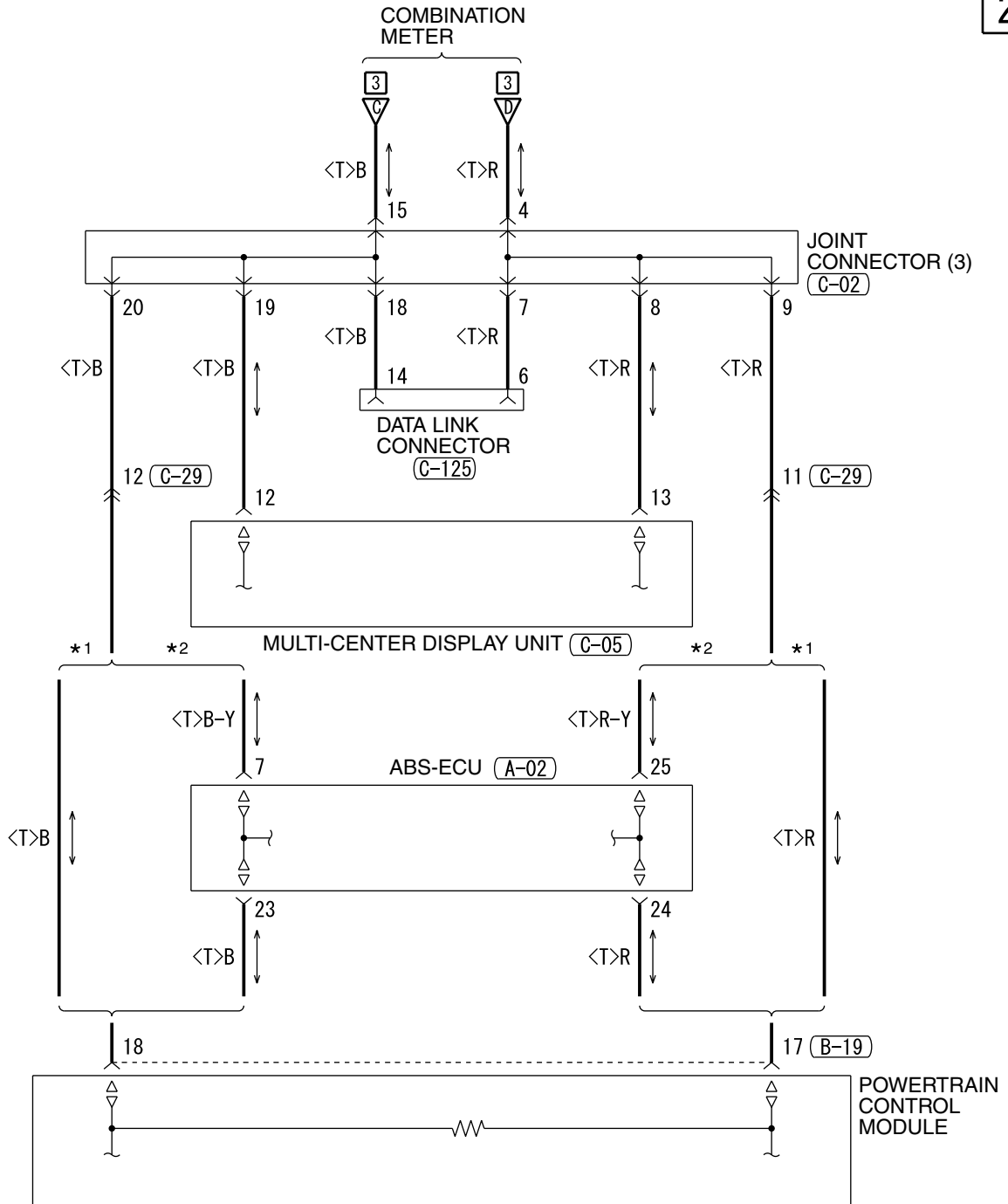

BRAKE WARNING LIGHT, OIL PRESSURE WARNING LIGHT, FUEL WARNING LIGHT (CONTINUED)

3

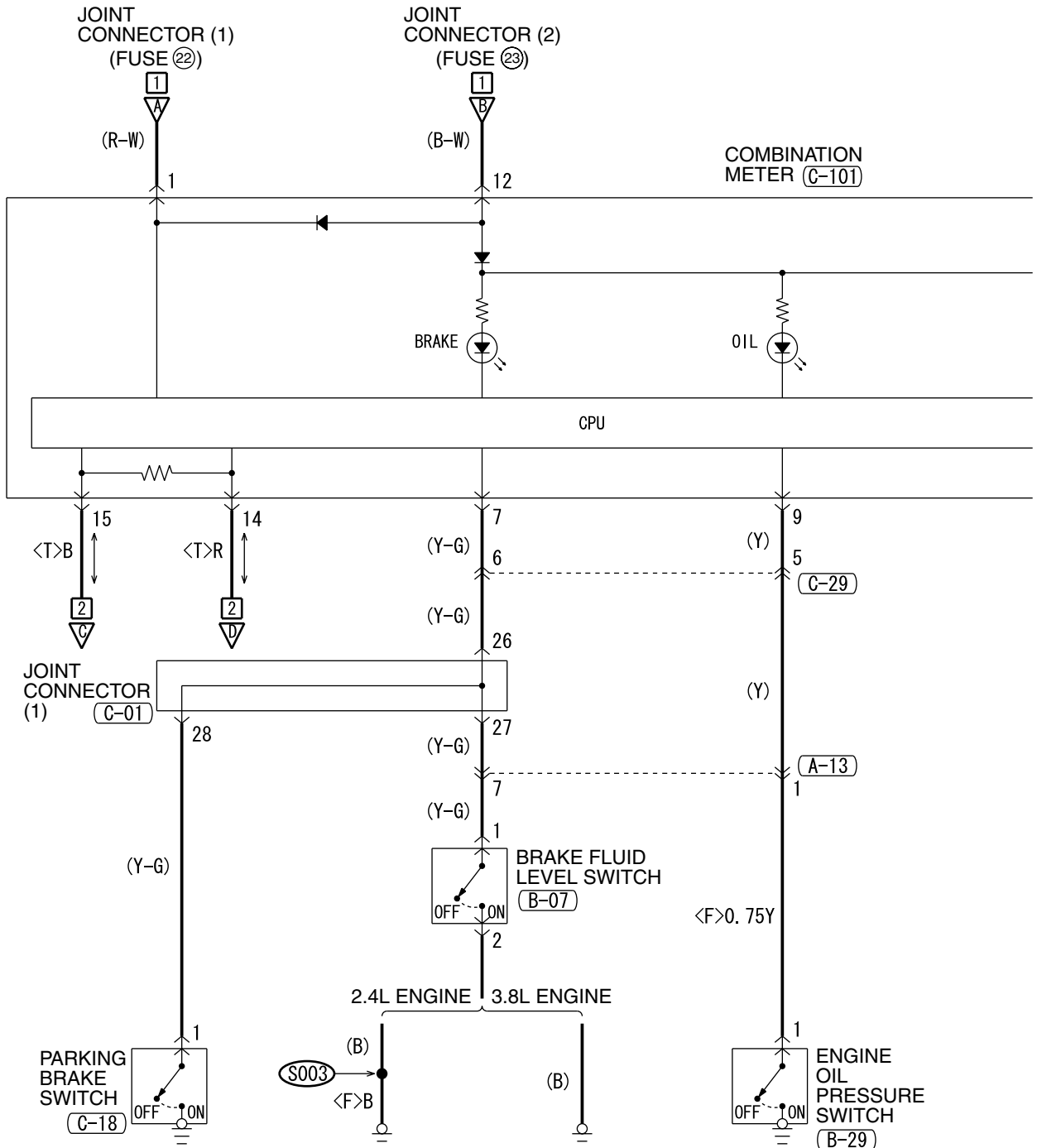

(A-13)

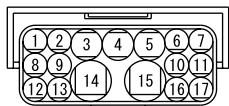

(B-07)



(B-20)

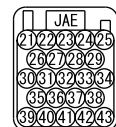

(B-29)



(C-01)

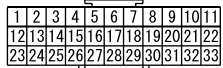

(C-18)



(C-25)

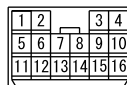

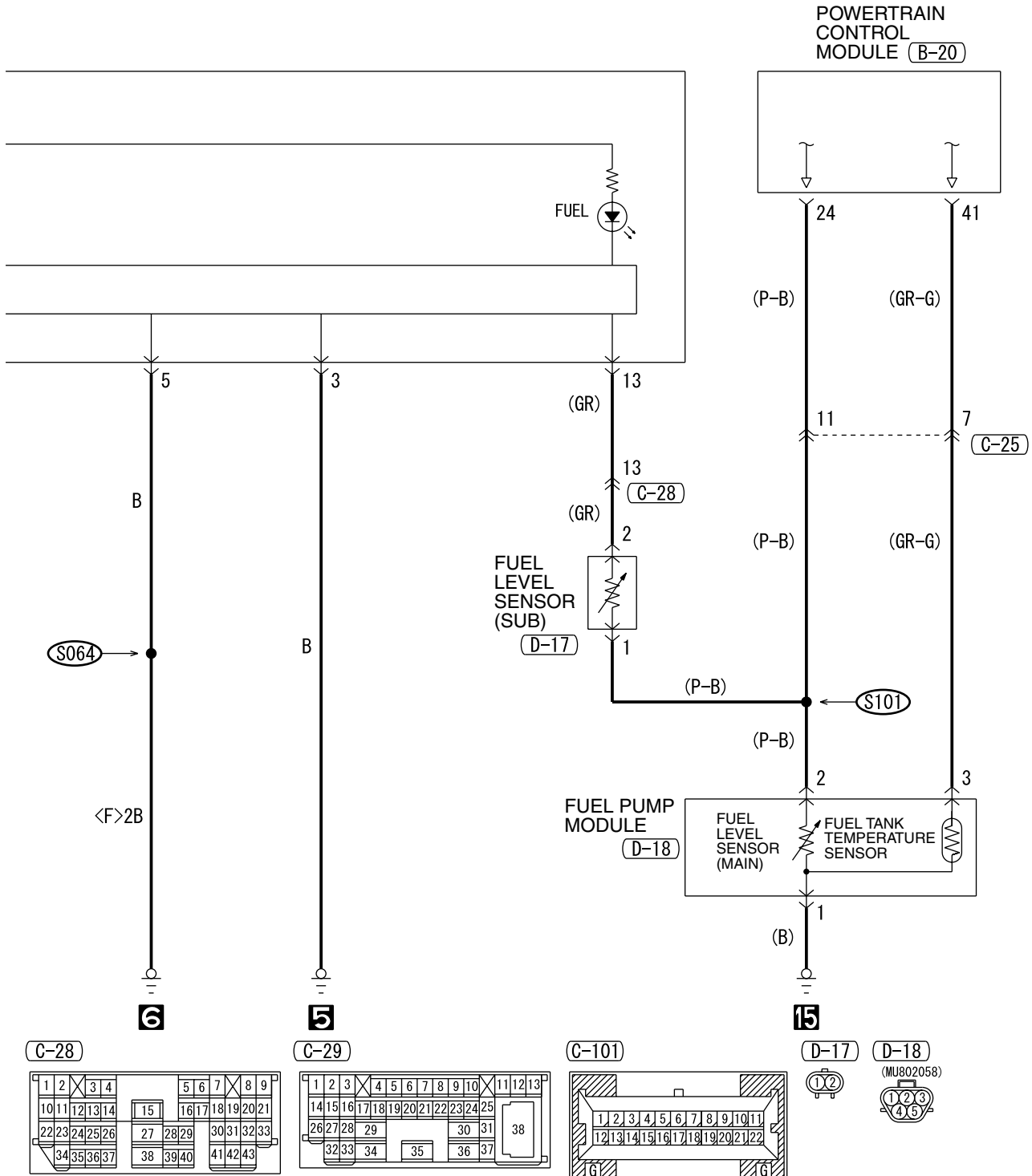

POWER WINDOWS

M1901004601254

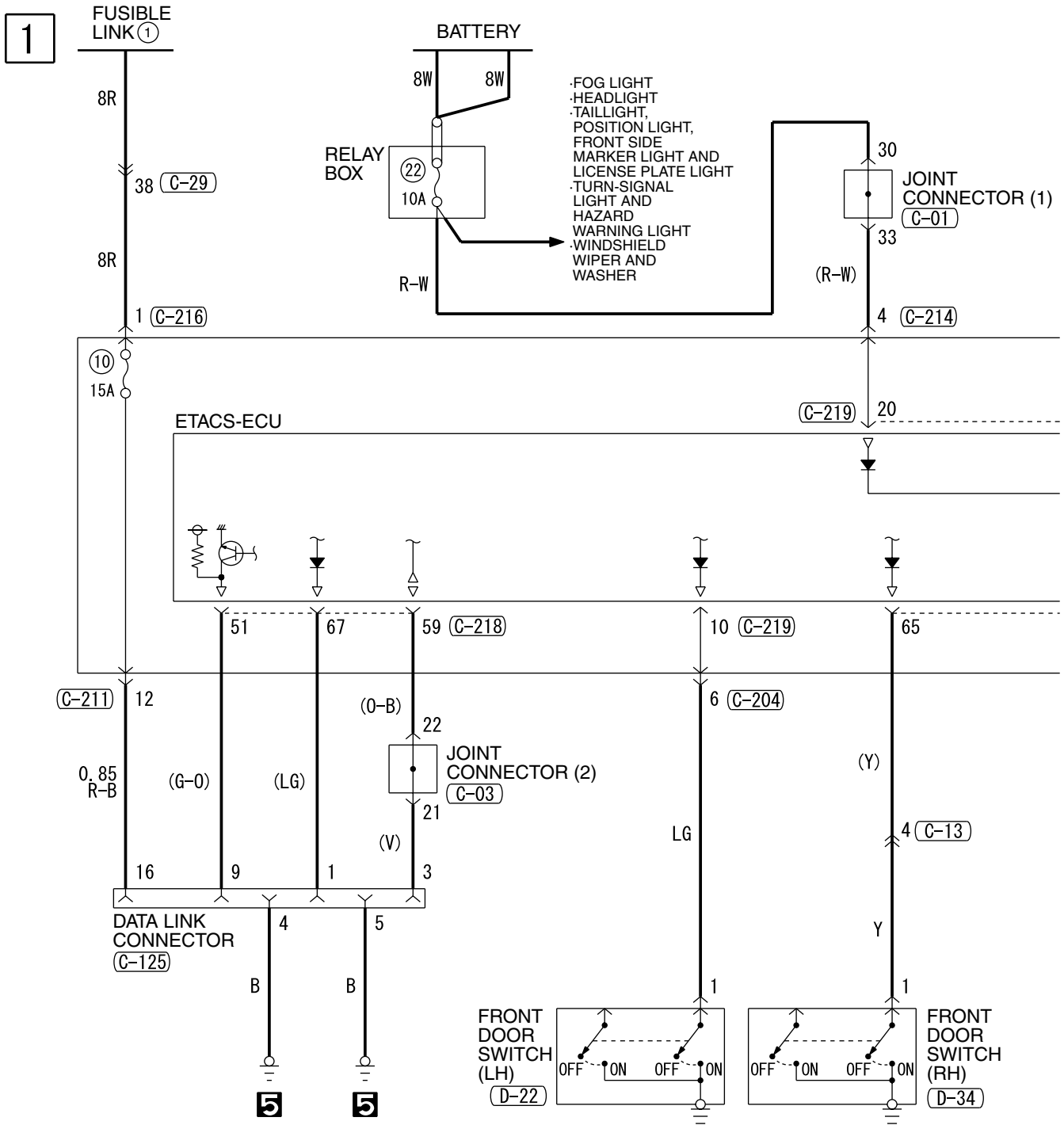

(C-01)



(C-03)



(C-13)

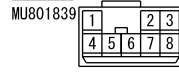

(C-28)



(C-212)



(C-214)

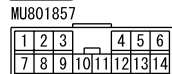

(C-215)



(C-216)



(C-218)



(C-219) JUNCTION BLOCK SIDE

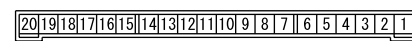

H5P11M00AA

2

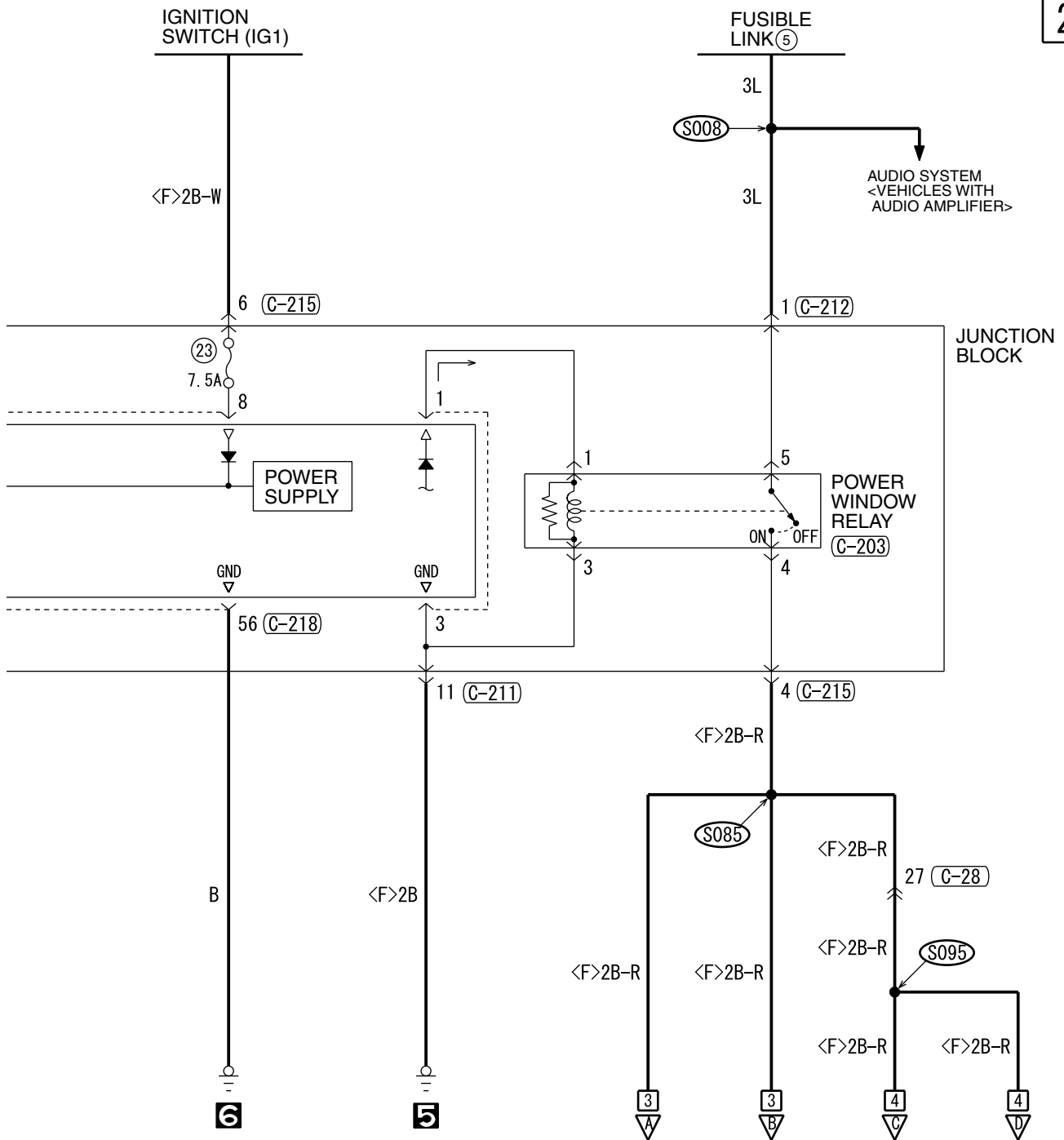

(C-29)

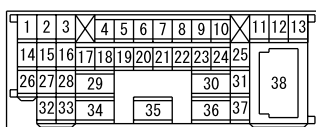

(C-125)

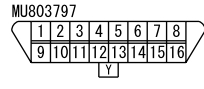

(D-22)



(D-34)



(C-203)



(C-204)

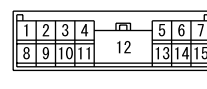

(C-211)

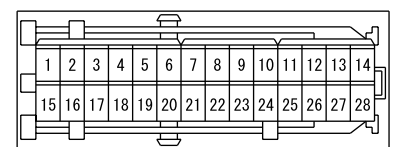

POWER WINDOWS (CONTINUED)

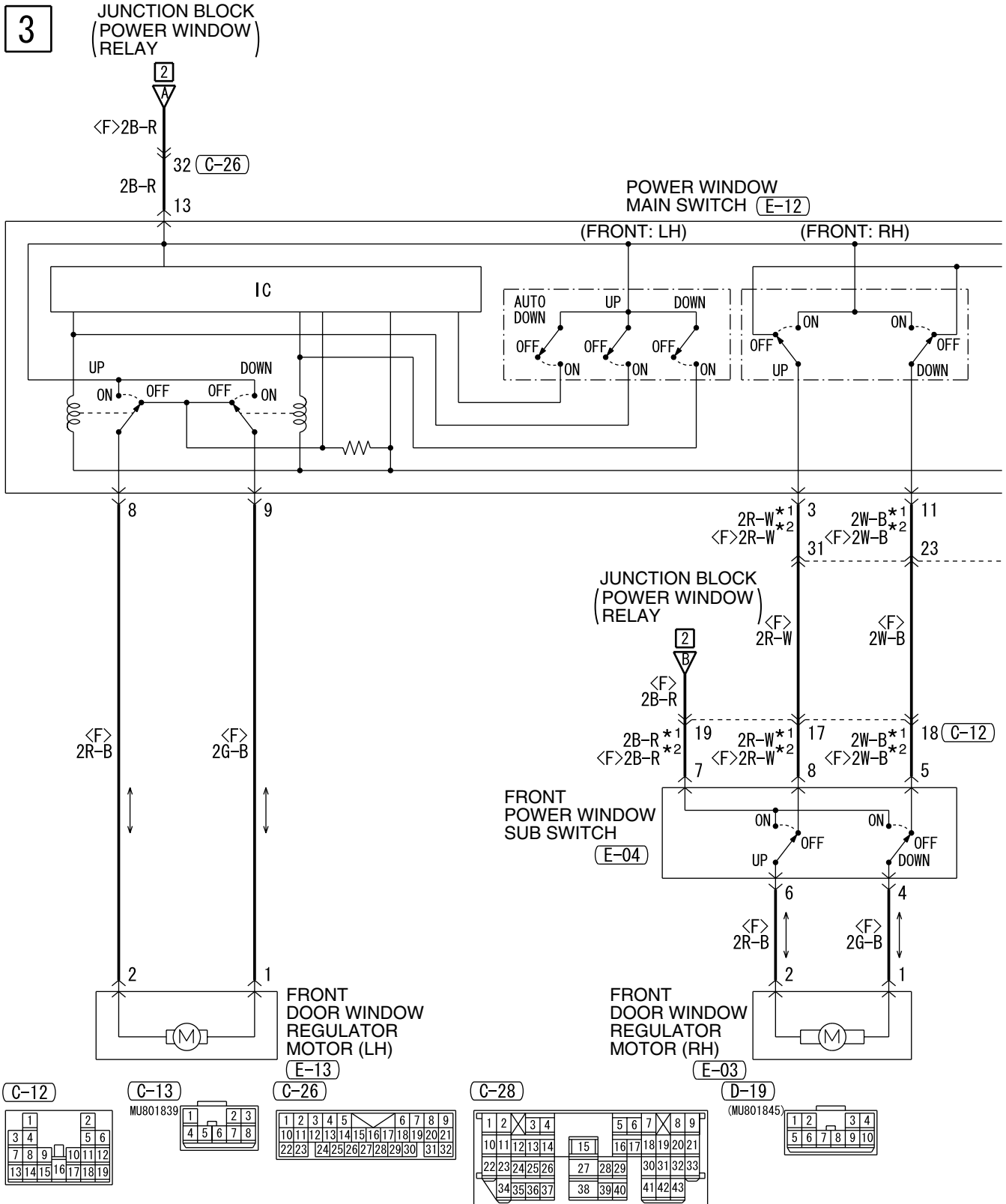



NOTE  
\*1: VEHICLES FOR CANADA  
\*2: EXCEPT VEHICLES FOR CANADA

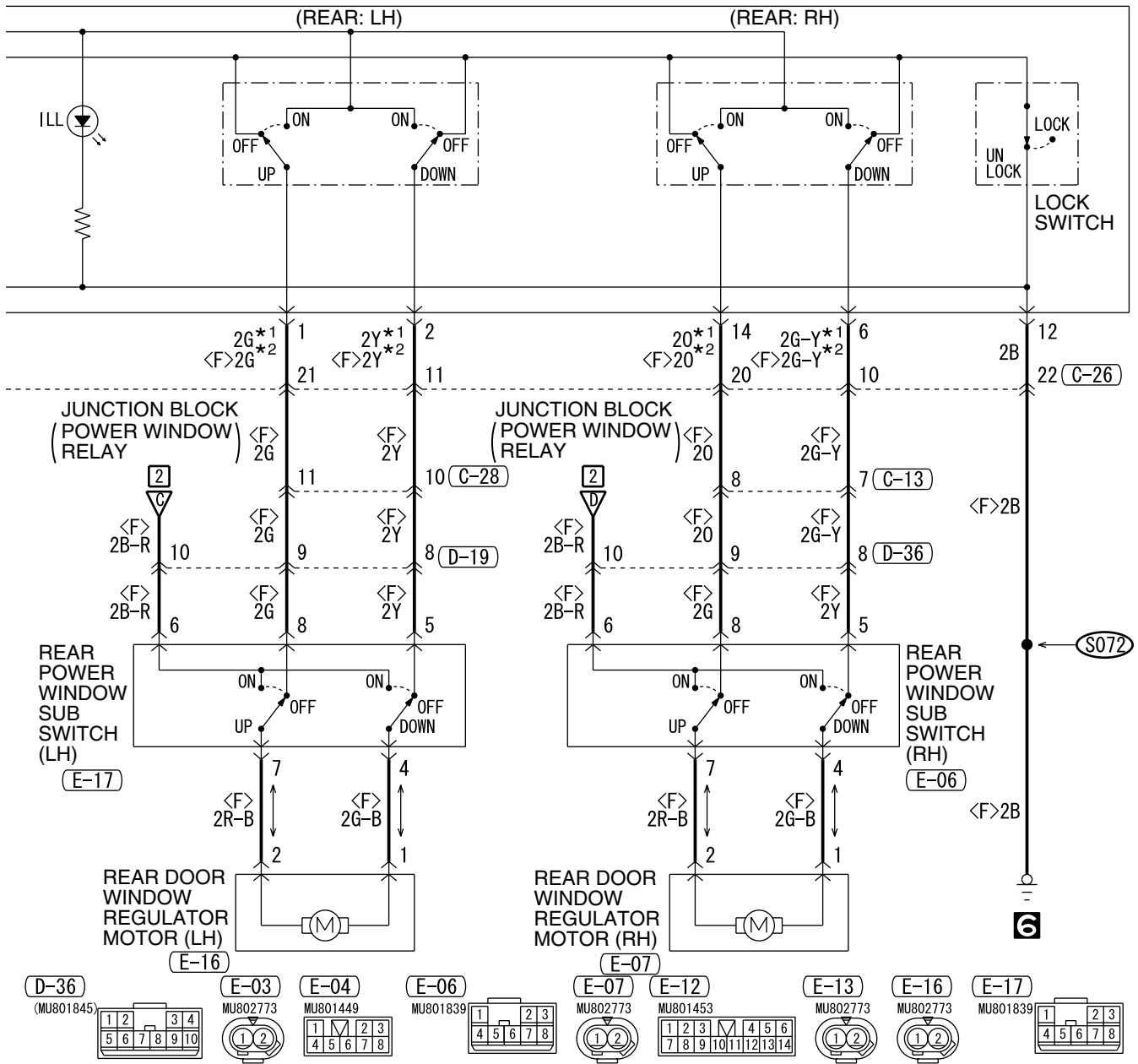

WIRE COLOR CODE  
B : BLACK LG : LIGHT GREEN G : GREEN L : BLUE W : WHITE Y : YELLOW  
SB : SKY BLUE BR : BROWN O : ORANGE GR : GRAY R : RED P : PINK V : VIOLET

# CENTRAL DOOR LOCKING SYSTEM

M1901004701938

1

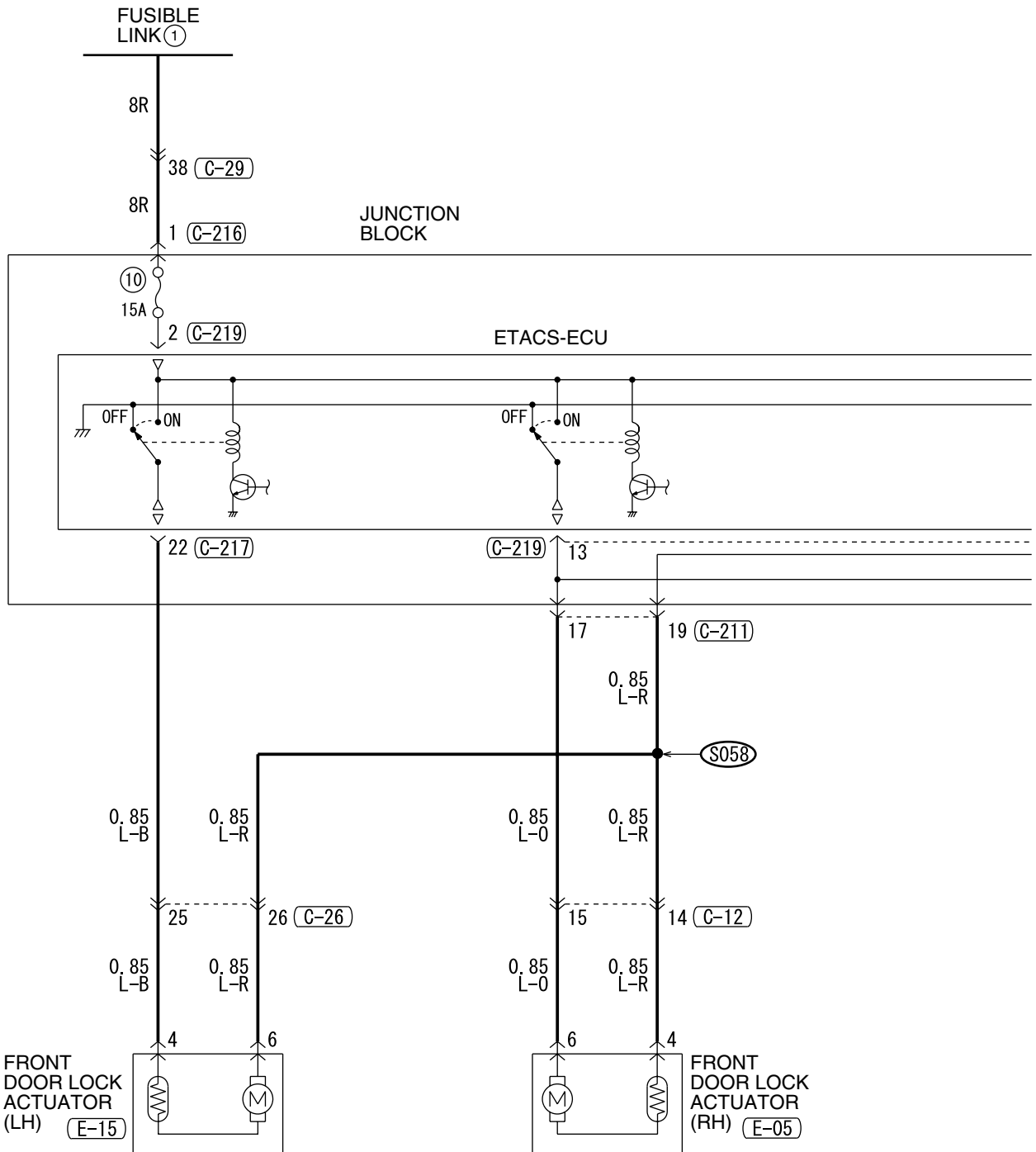

(C-12)

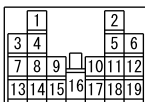

(C-26)

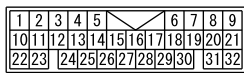

(C-28)

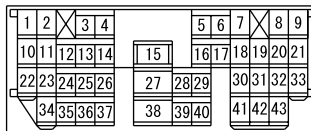

(C-29)

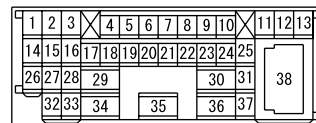

(D-19)

(MU801845)

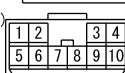

(C-219) JUNCTION BLOCK SIDE

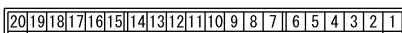

H5P11M01AA

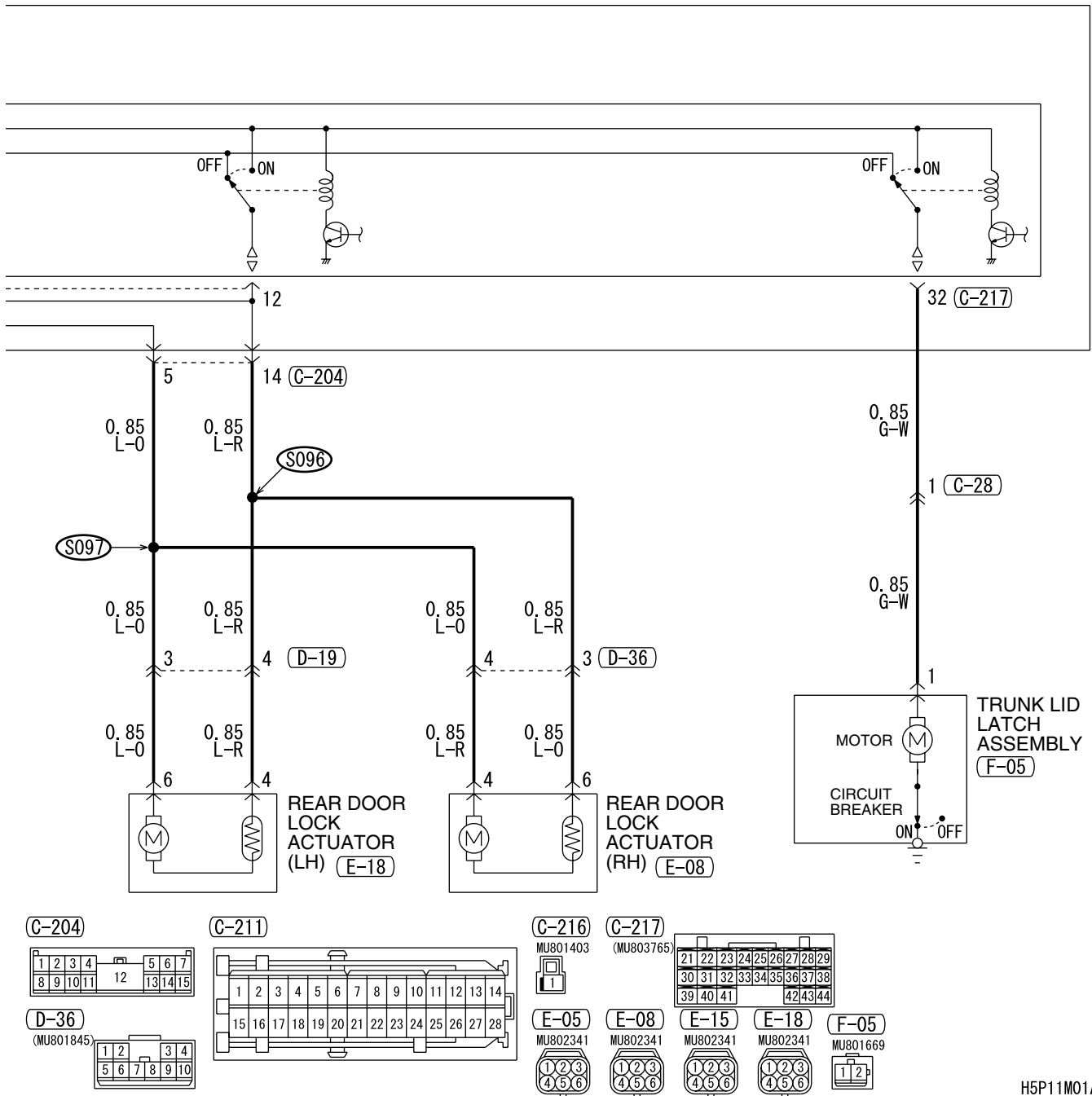

CENTRAL DOOR LOCKING SYSTEM (CONTINUED)

3

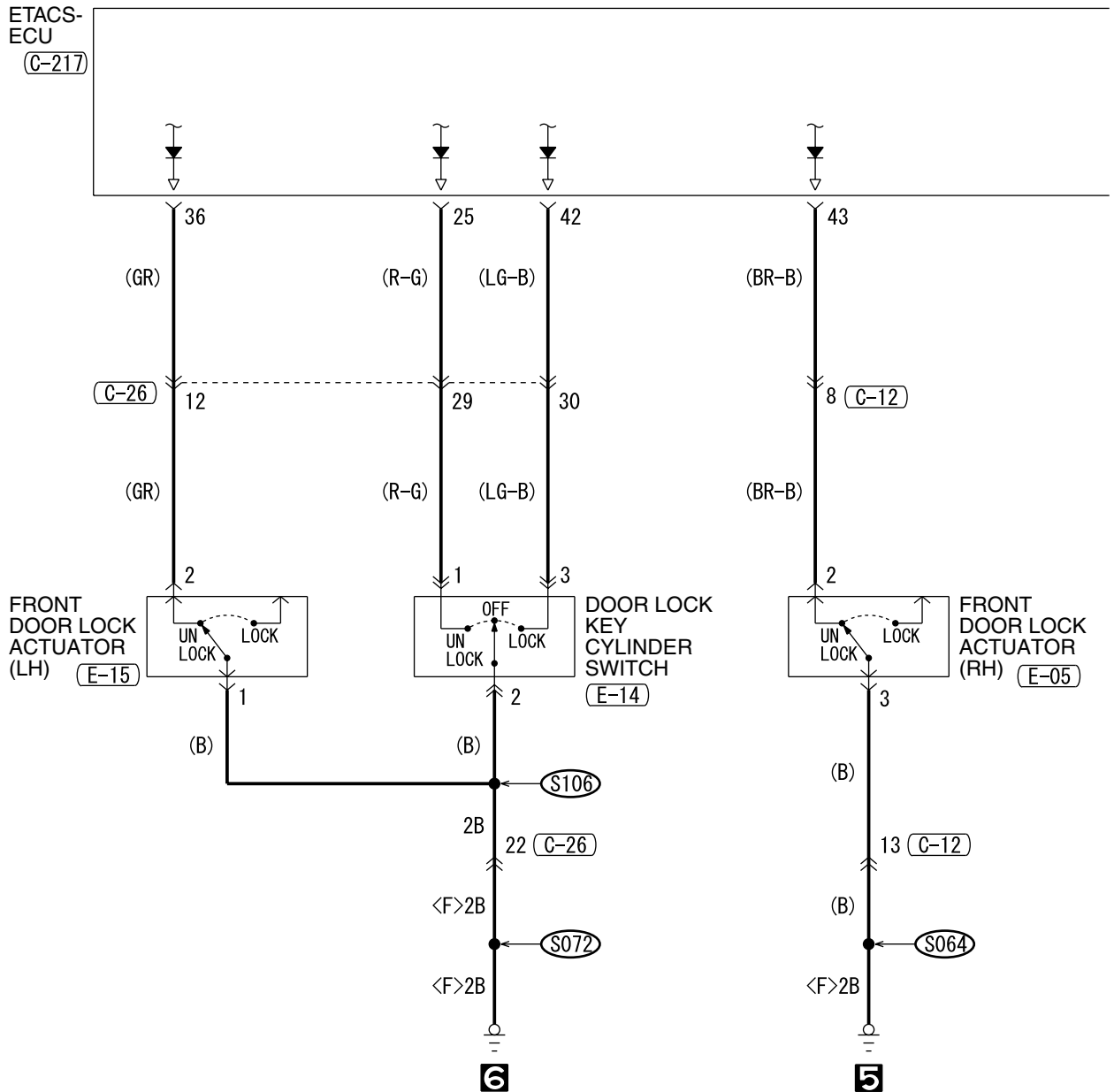

(C-12)

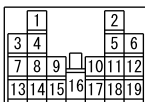

(C-26)



(C-217)

(MU803765)



(C-310)

MU801547

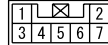

(E-04)

MU801449



(E-05)

MU802341



(E-12)

MU801453

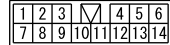

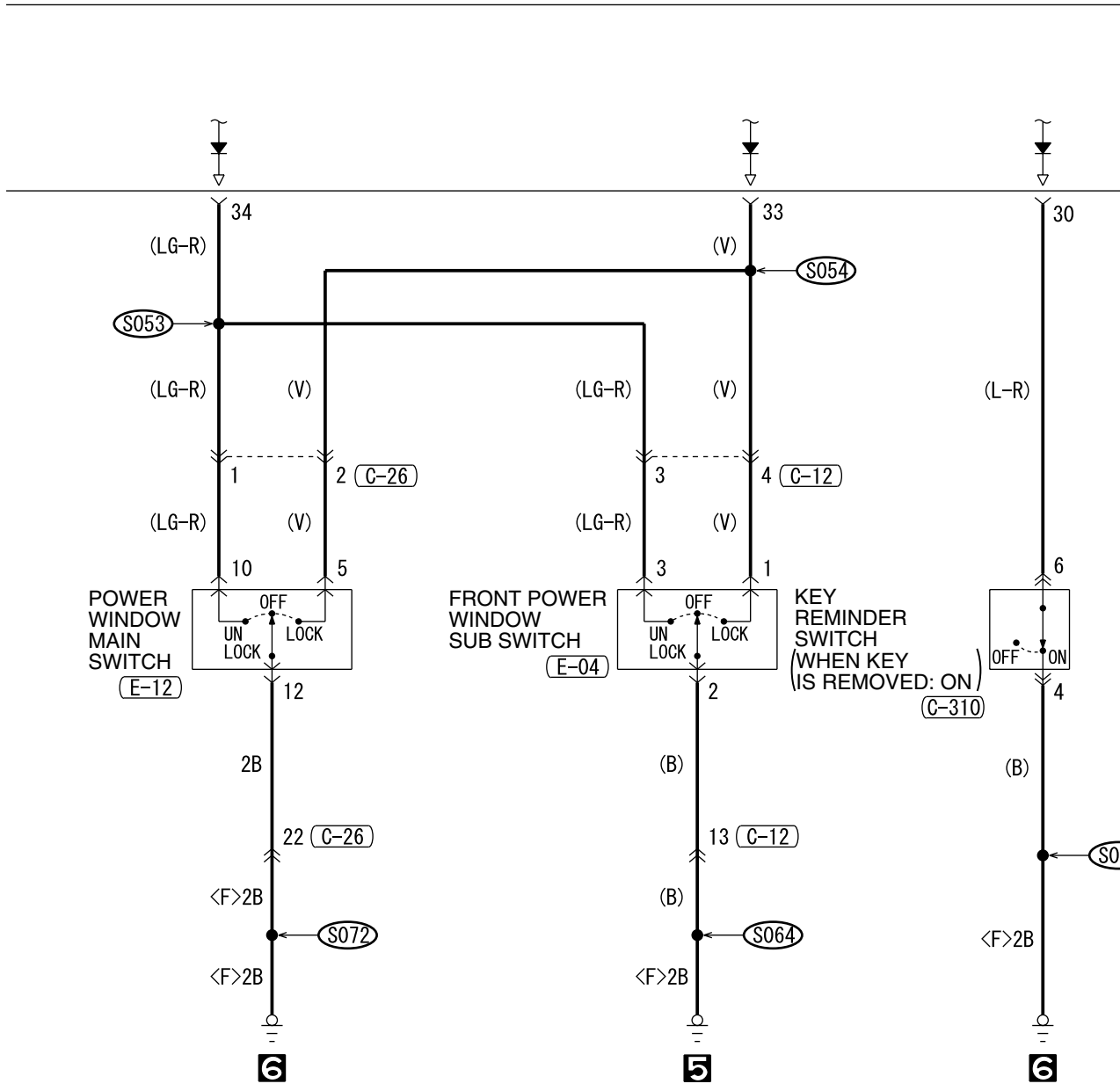

WIRE COLOR CODE  
 B : BLACK LG : LIGHT GREEN G : GREEN L : BLUE W : WHITE Y : YELLOW  
 SB : SKY BLUE BR : BROWN O : ORANGE GR : GRAY R : RED P : PINK V : VIOLET

CENTRAL DOOR LOCKING SYSTEM (CONTINUED)

5

JUNCTION  
BLOCK

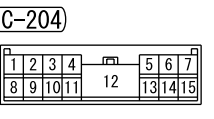
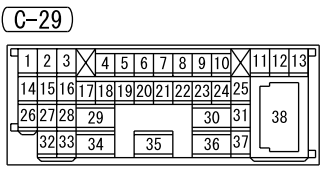
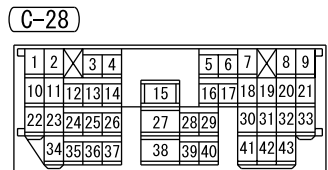
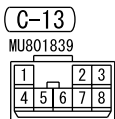
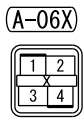
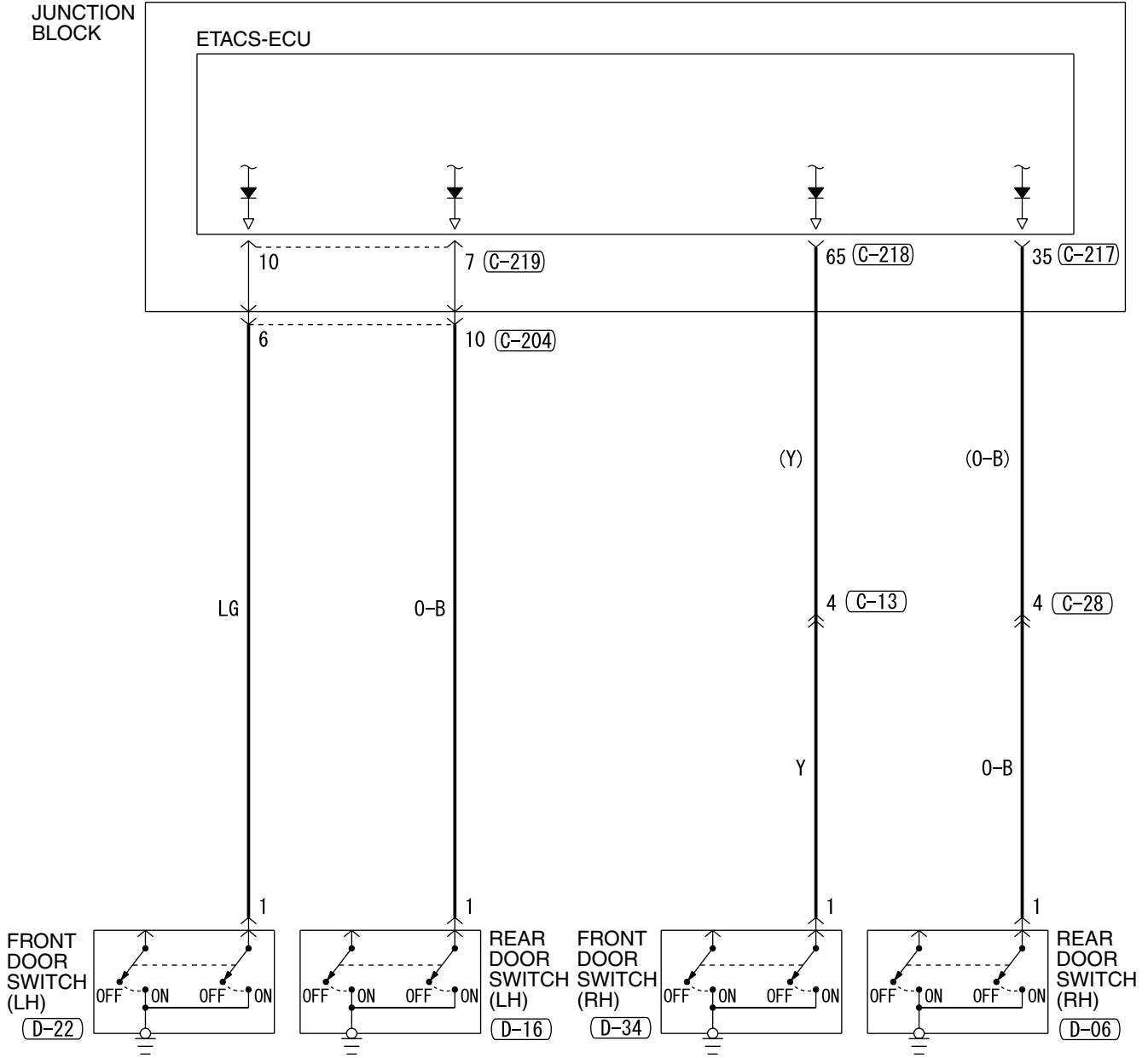

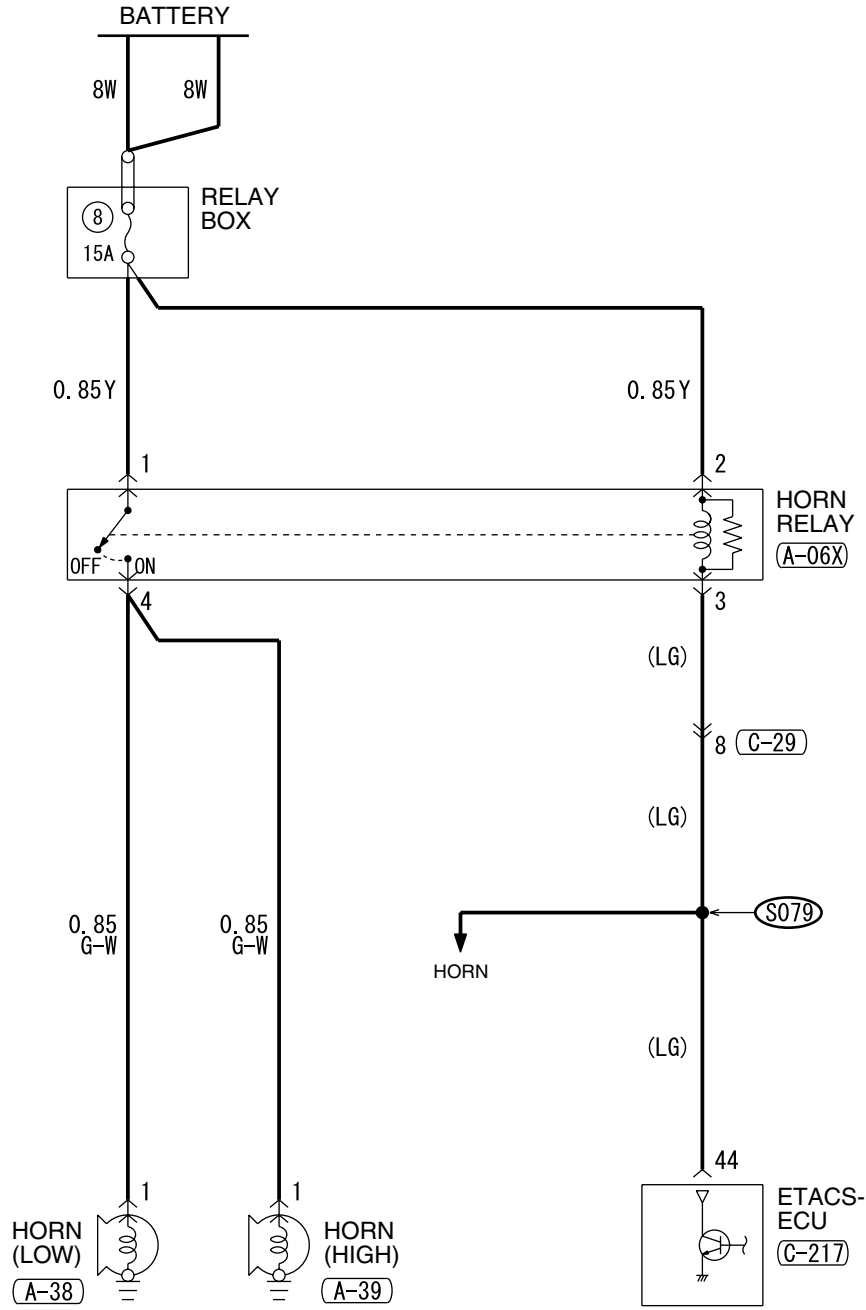

**(C-217)**  
(MU803765)

21	22	23	24	25	26	27	28	29
30	31	32	33	34	35	36	37	38
39	40	41	42	43	44			

**(C-218)**  
(MU803766)

51	52	53	54	55	56	57	58	59
60	61	62	63	64	65	66	67	68
69	70	71	72	73	74			

**(C-219)** JUNCTION BLOCK SIDE

20	19	18	17	16	15	14	13	12	11	10	9	8	7	6	5	4	3	2	1
----	----	----	----	----	----	----	----	----	----	----	---	---	---	---	---	---	---	---	---

**(D-06)**  
(MU801536)

1	2	3
---	---	---

**(D-16)**  
(MU801536)

1	2	3
---	---	---

**(D-22)**  
(MU801536)

1	2	3
---	---	---

**(D-34)**  
(MU801536)

1	2	3
---	---	---

WIRE COLOR CODE  
 B : BLACK LG : LIGHT GREEN G : GREEN L : BLUE  
 BR : BROWN O : ORANGE GR : GRAY R : RED W : WHITE  
 SB : SKY BLUE P : PINK Y : YELLOW V : VIOLET

CENTRAL DOOR LOCKING SYSTEM (CONTINUED)

7

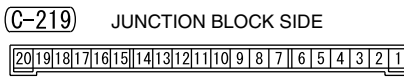
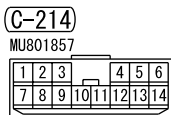
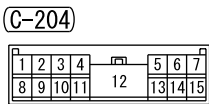
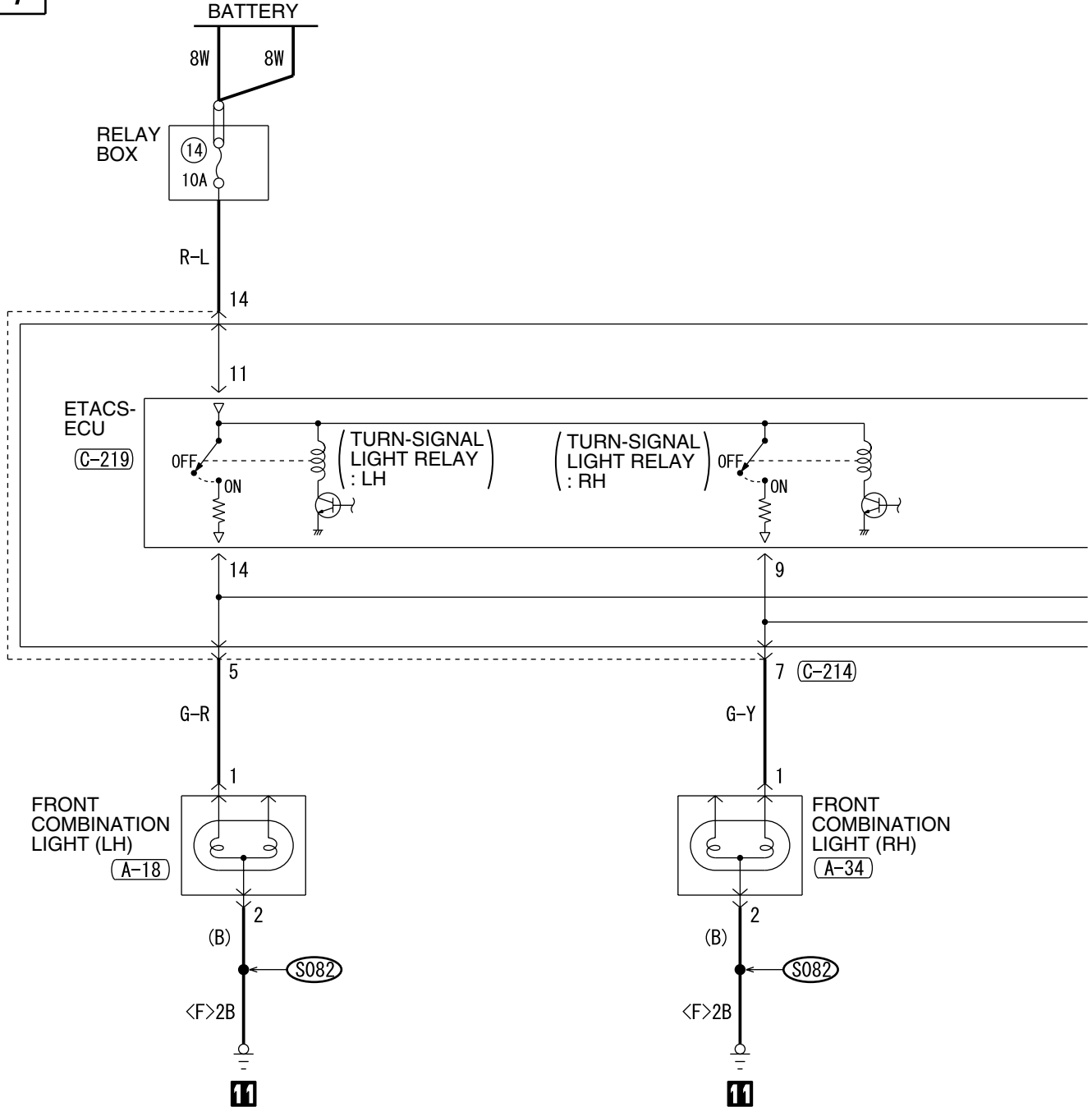



8

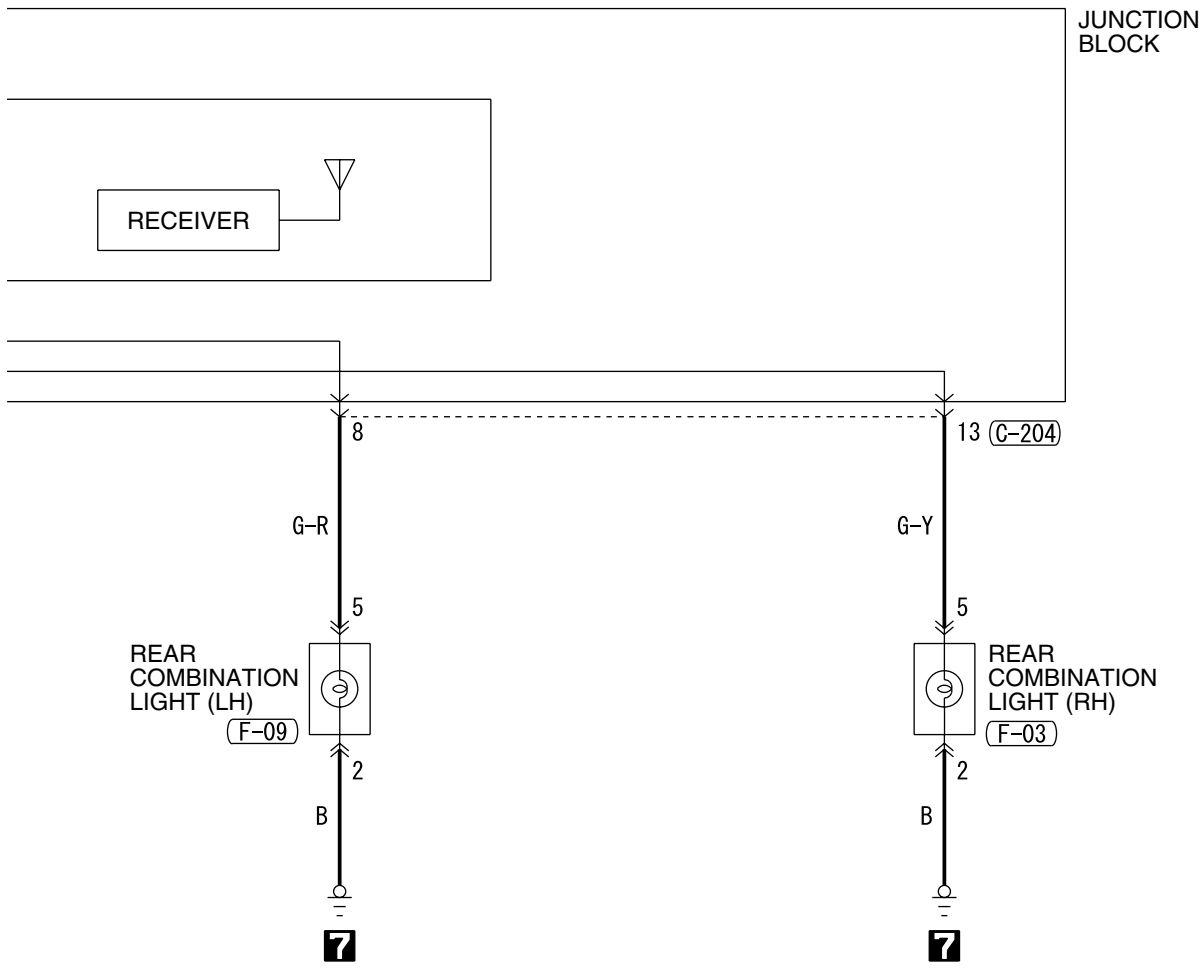
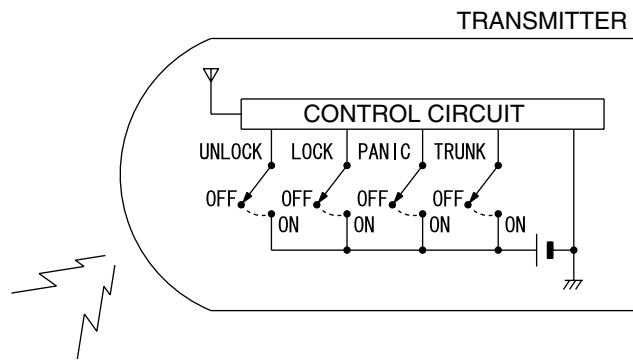

WIRE COLOR CODE  
 B: BLACK LG: LIGHT GREEN G: GREEN L: BLUE W: WHITE Y: YELLOW  
 SB: SKY BLUE BR: BROWN O: ORANGE GR: GRAY R: RED P: PINK V: VIOLET

TSB Revision

CENTRAL DOOR LOCKING SYSTEM (CONTINUED)

9

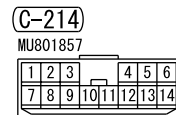
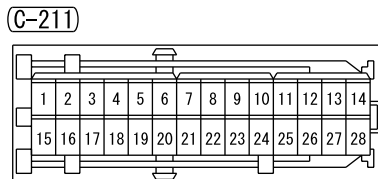
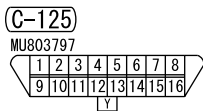
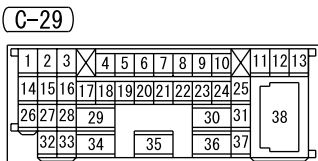
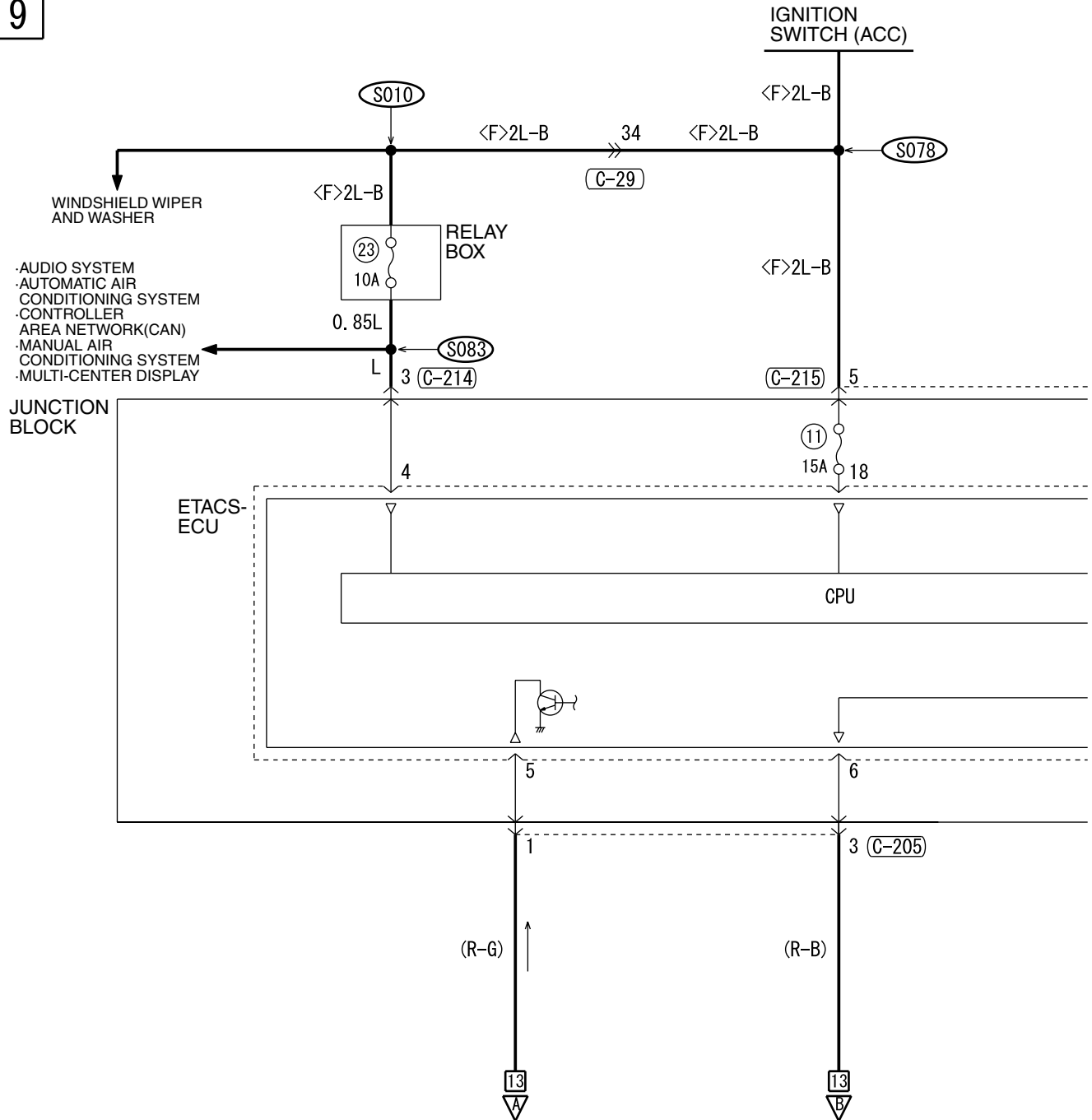

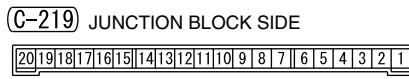
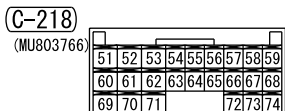
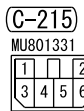
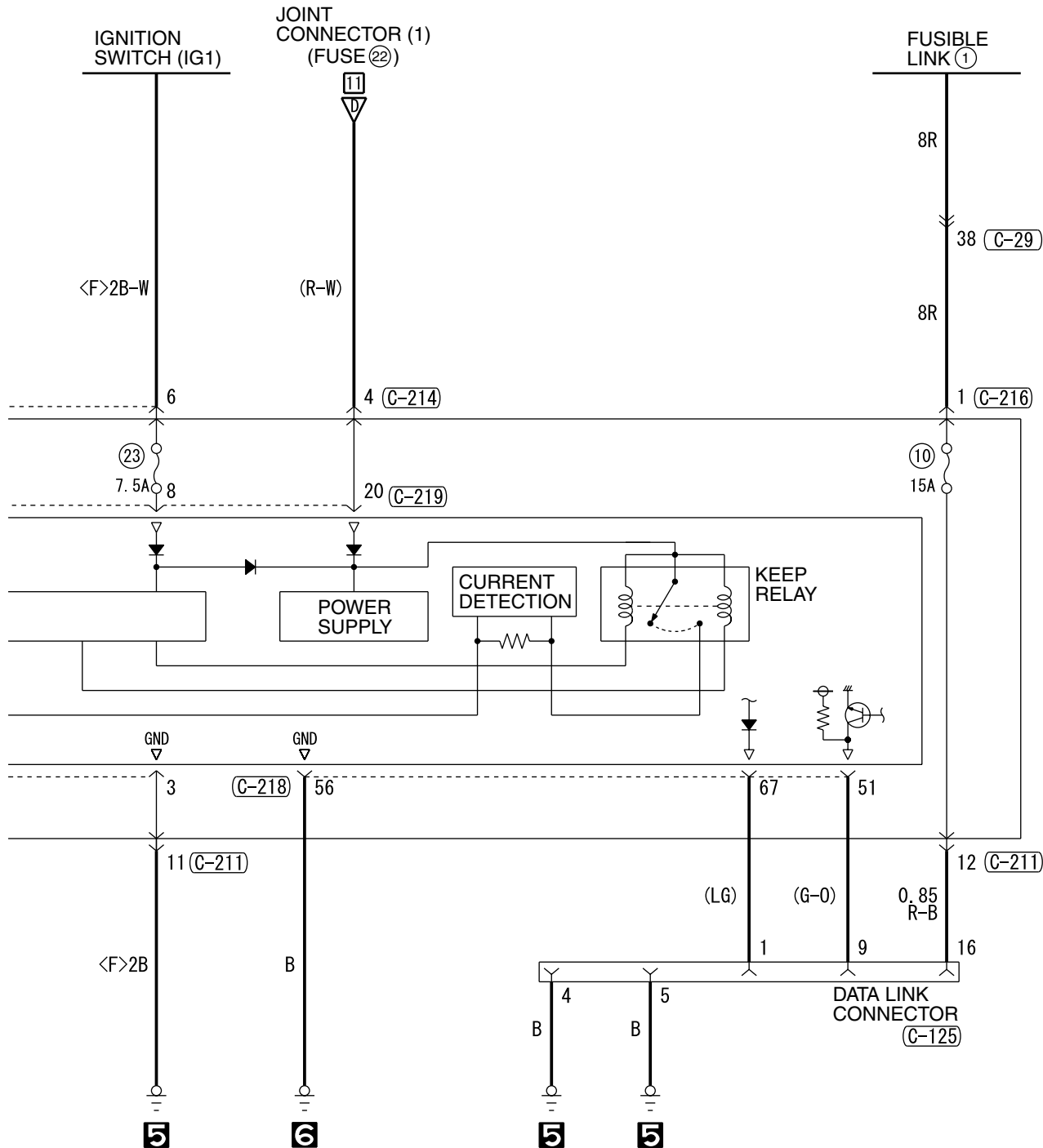

WIRE COLOR CODE  
 B : BLACK    LG : LIGHT GREEN    G : GREEN    L : BLUE    W : WHITE    Y : YELLOW  
 SB : SKY BLUE    BR : BROWN    O : ORANGE    GR : GRAY    R : RED    P : PINK    V : VIOLET

CENTRAL DOOR LOCKING SYSTEM (CONTINUED)

11

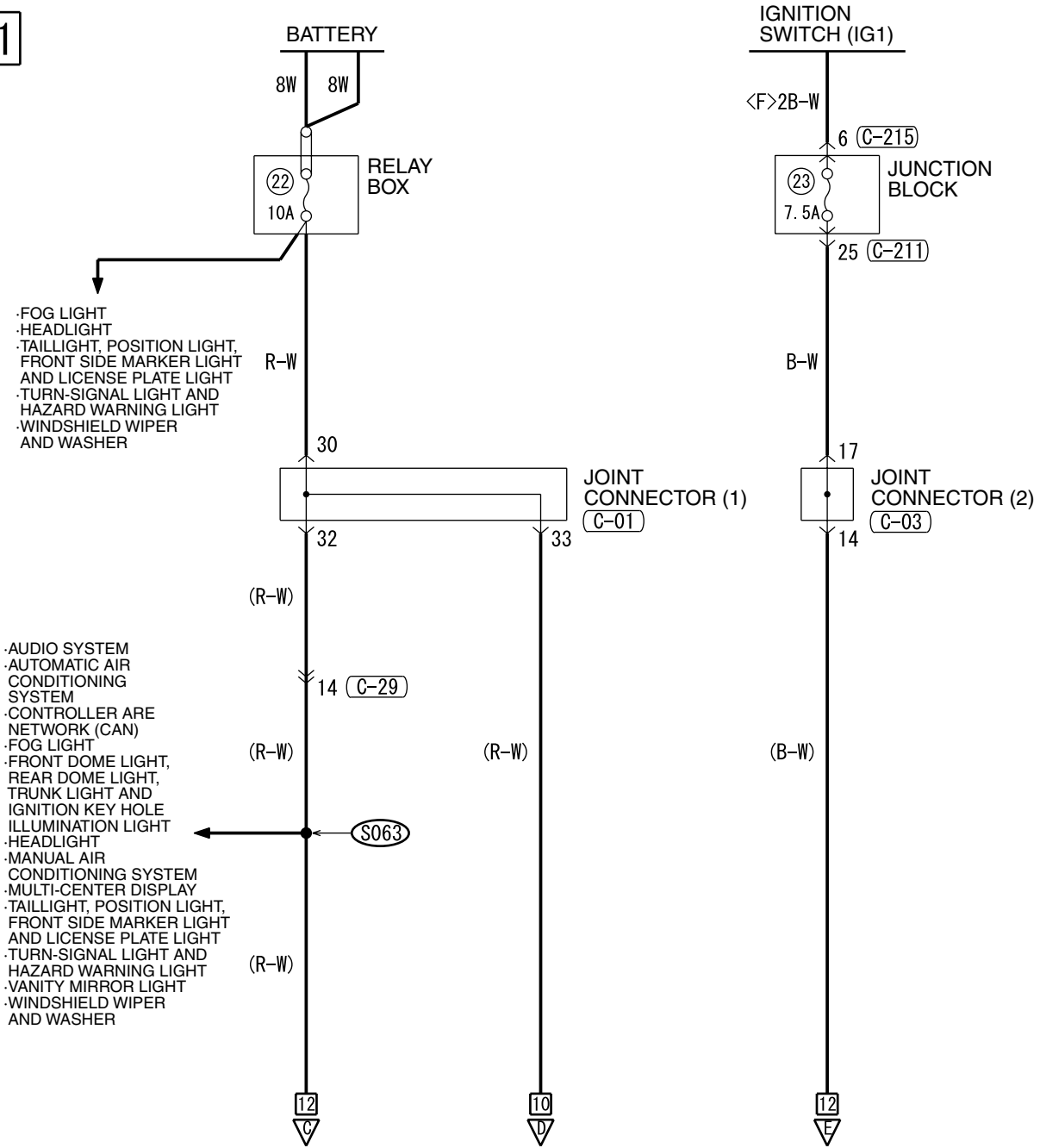

C-01

1	2	3	4	5	6	7	8	9	10	11
12	13	14	15	16	17	18	19	20	21	22
23	24	25	26	27	28	29	30	31	32	33

C-02

1	2	3	4	5	6	7	8	9	10	11
12	13	14	15	16	17	18	19	20	21	22
23	24	25	26	27	28	29	30	31	32	33

C-03

1	2	3	4	5	6	7	8	9	10	11
12	13	14	15	16	17	18	19	20	21	22
23	24	25	26	27	28	29	30	31	32	33

C-29

1	2	3	4	5	6	7	8	9	10	11	12	13
14	15	16	17	18	19	20	21	22	23	24	25	
26	27	28	29		30	31						
32	33	34		35		36	37			38		

12

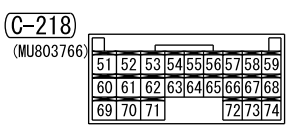
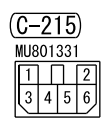
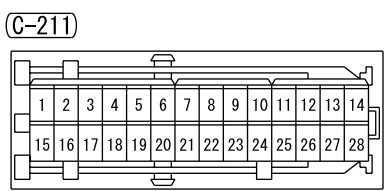
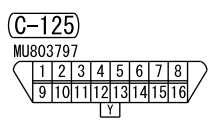
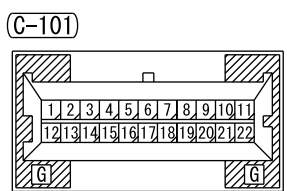
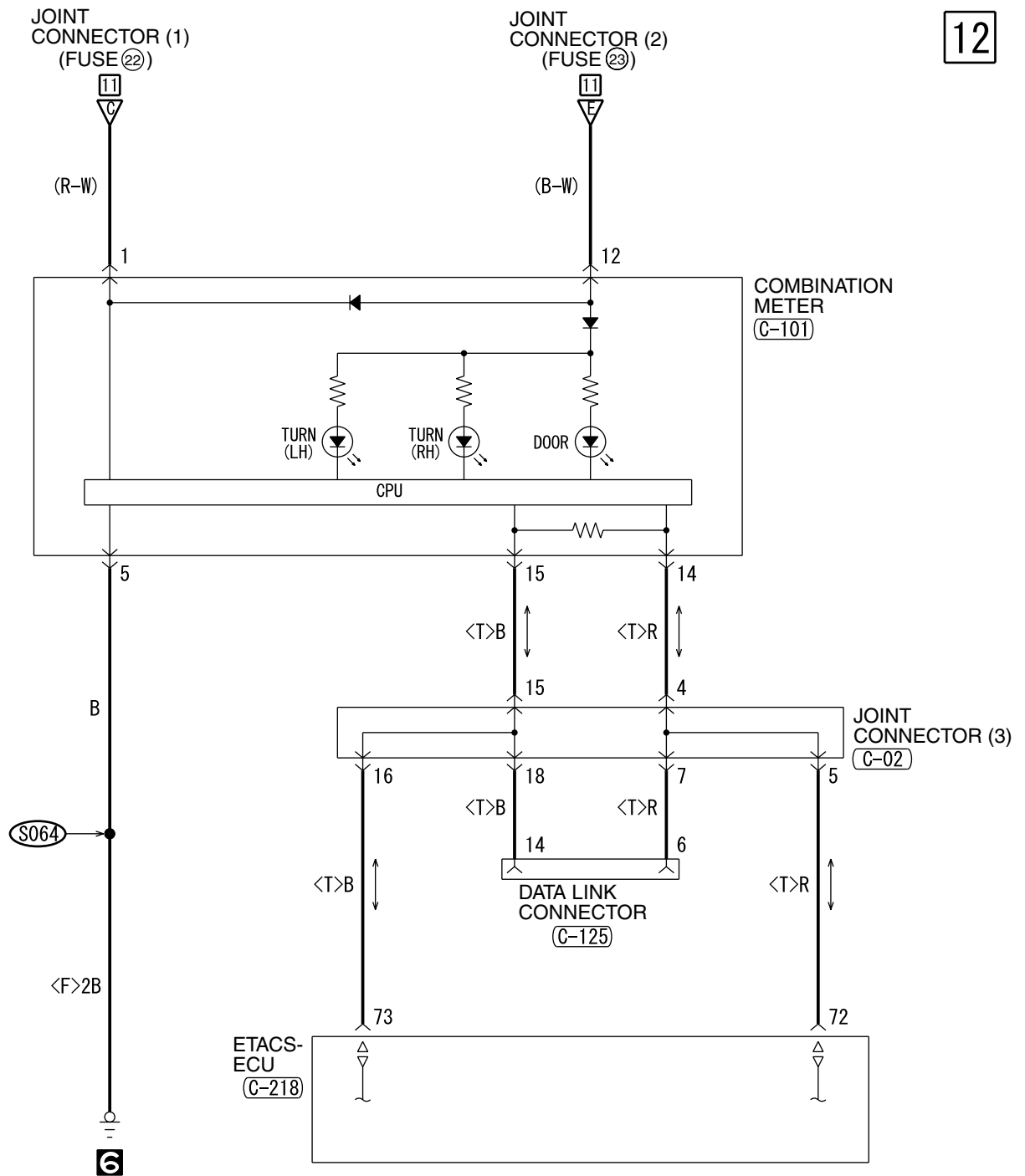

CENTRAL DOOR LOCKING SYSTEM (CONTINUED)

13

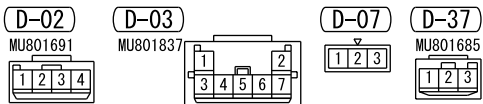
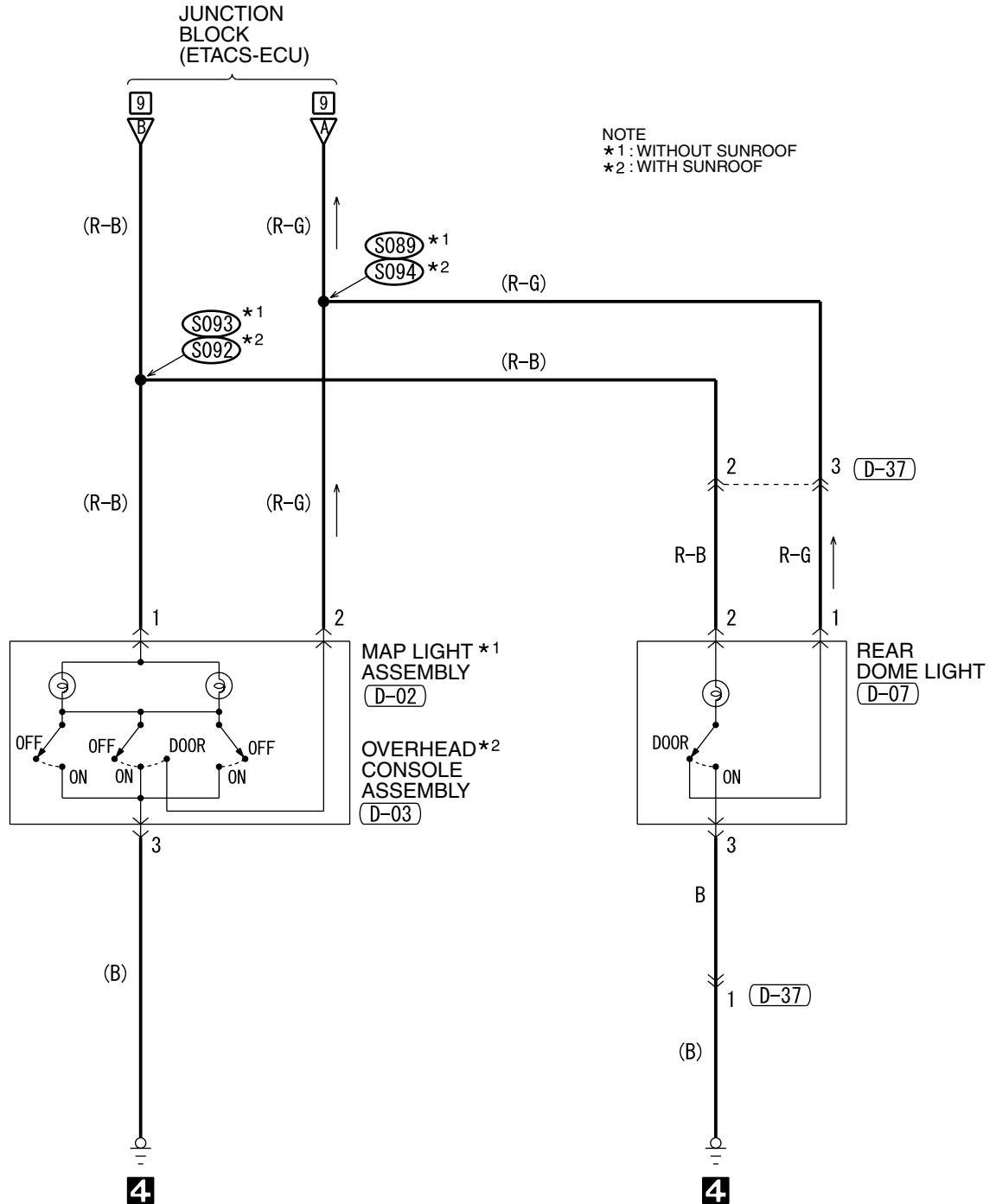

WIRE COLOR CODE  
 B : BLACK SB : SKY BLUE  
 BR : BROWN LG : LIGHT GREEN  
 G : GREEN P : PINK GR : GRAY  
 R : RED L : BLUE Y : YELLOW  
 V : VIOLET W : WHITE O : ORANGE

NOTES

MANUAL AIR CONDITIONING SYSTEM <LOW>

M1901005501443

1

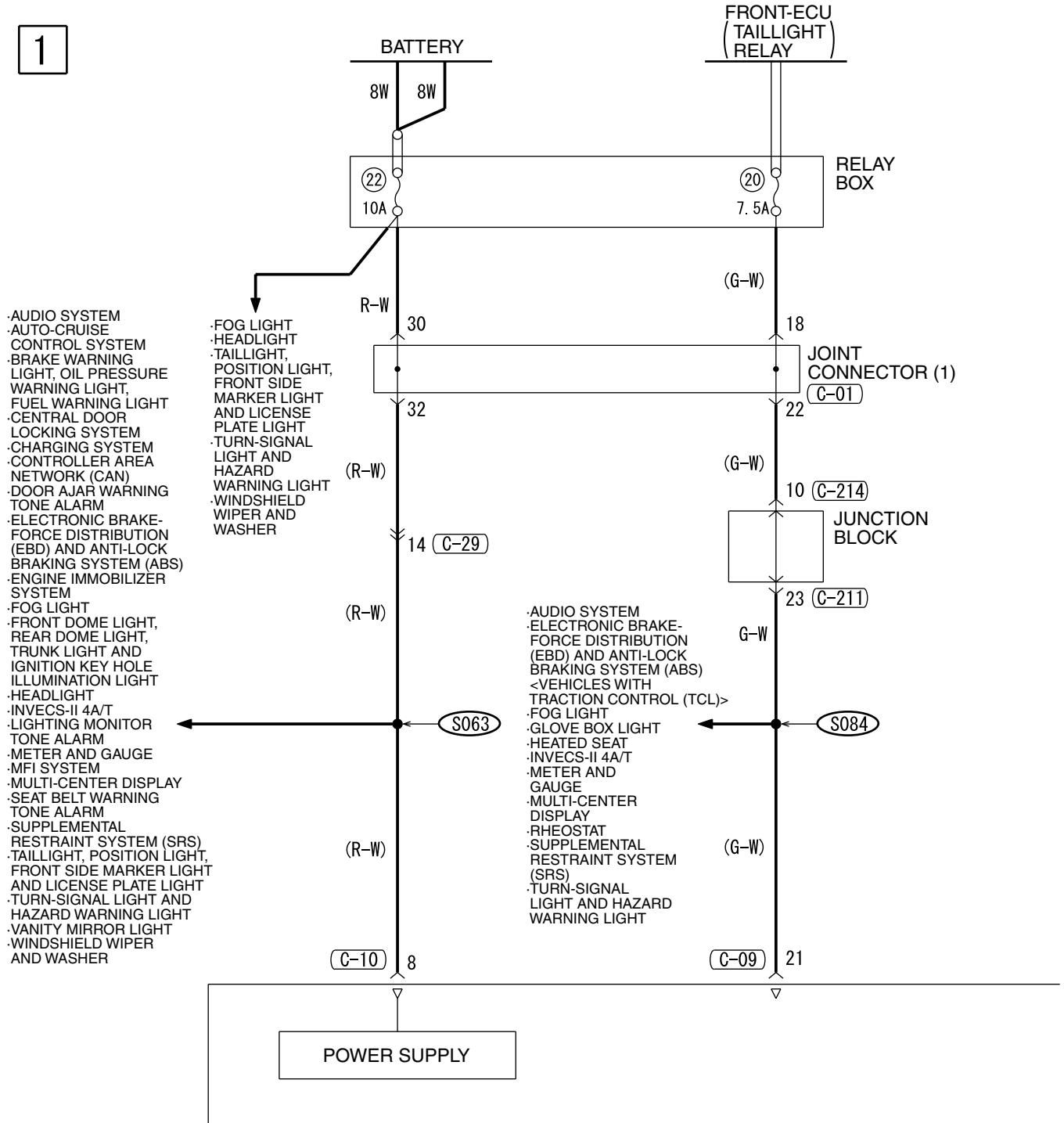

(C-01)

1	2	3	4	5	6	7	8	9	10	11
12	13	14	15	16	17	18	19	20	21	22
23	24	25	26	27	28	29	30	31	32	33

(C-03)

1	2	3	4	5	6	7	8	9	10	11
12	13	14	15	16	17	18	19	20	21	22
23	24	25	26	27	28	29	30	31	32	33

(C-09)

(MU801583)

21	22	23	24	25	26
27	28	29	30	31	32

(C-10)

(MU801584)

1	2	3	4	5	6	7	8
9	10	11	12	13	14	15	16

(C-29)

1	2	3	4	5	6	7	8	9	10	11	12	13
14	15	16	17	18	19	20	21	22	23	24	25	
26	27	28	29					30	31			
32	33	34		35				36	37			
											38	



2

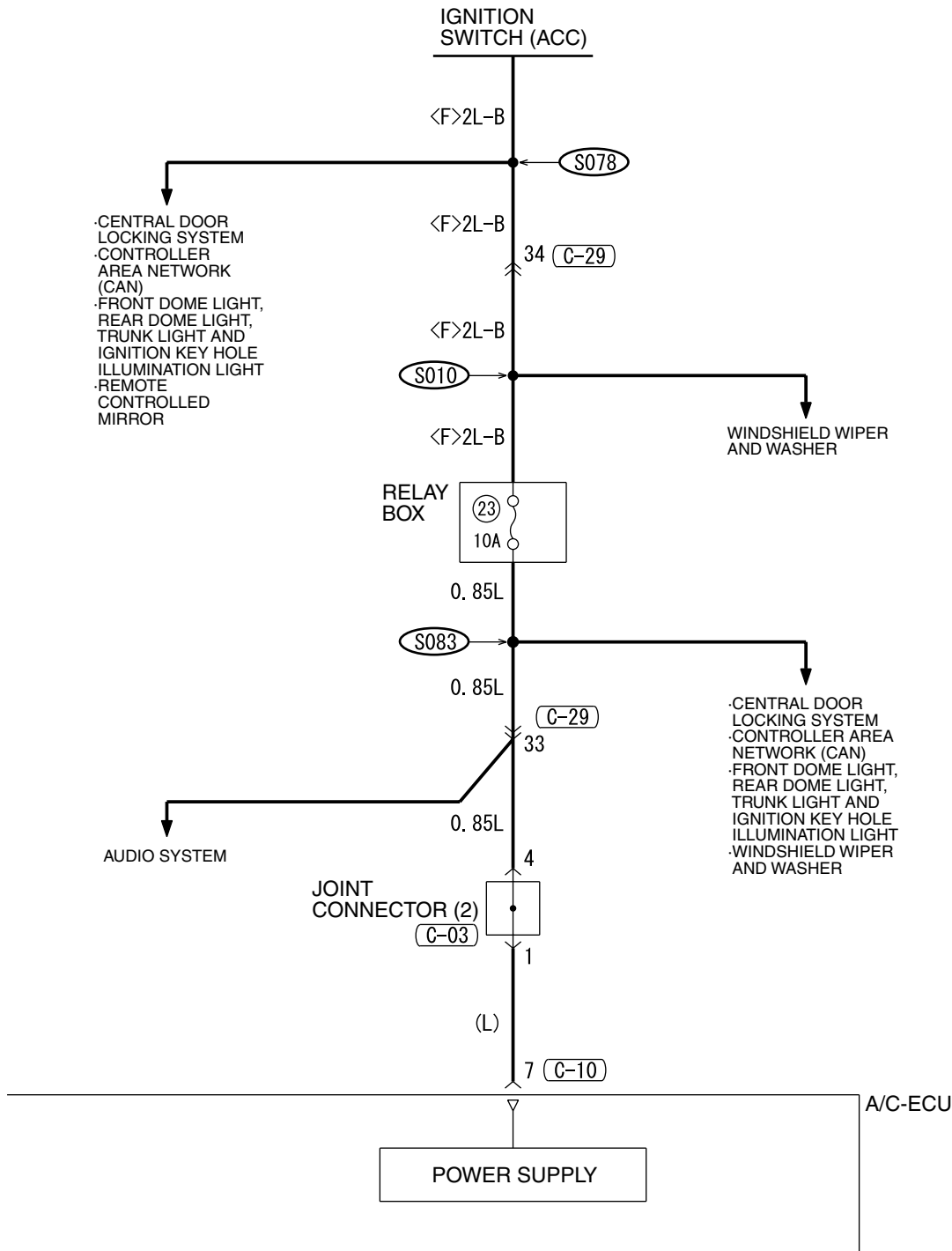

(C-211)

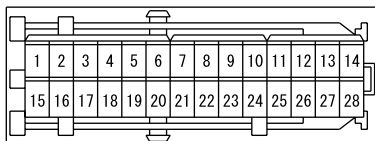

(C-214)

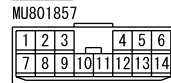

WIRE COLOR CODE  
 B : BLACK LG : LIGHT GREEN G : GREEN L : BLUE  
 BR : BROWN O : ORANGE GR : GRAY R : RED W : WHITE  
 SB : SKY BLUE P : PINK Y : YELLOW V : VIOLET

H5P12M00AB

TSB Revision

MANUAL AIR CONDITIONING SYSTEM <LOW> (CONTINUED)

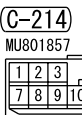
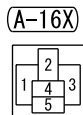
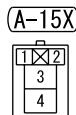
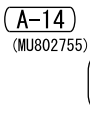
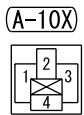
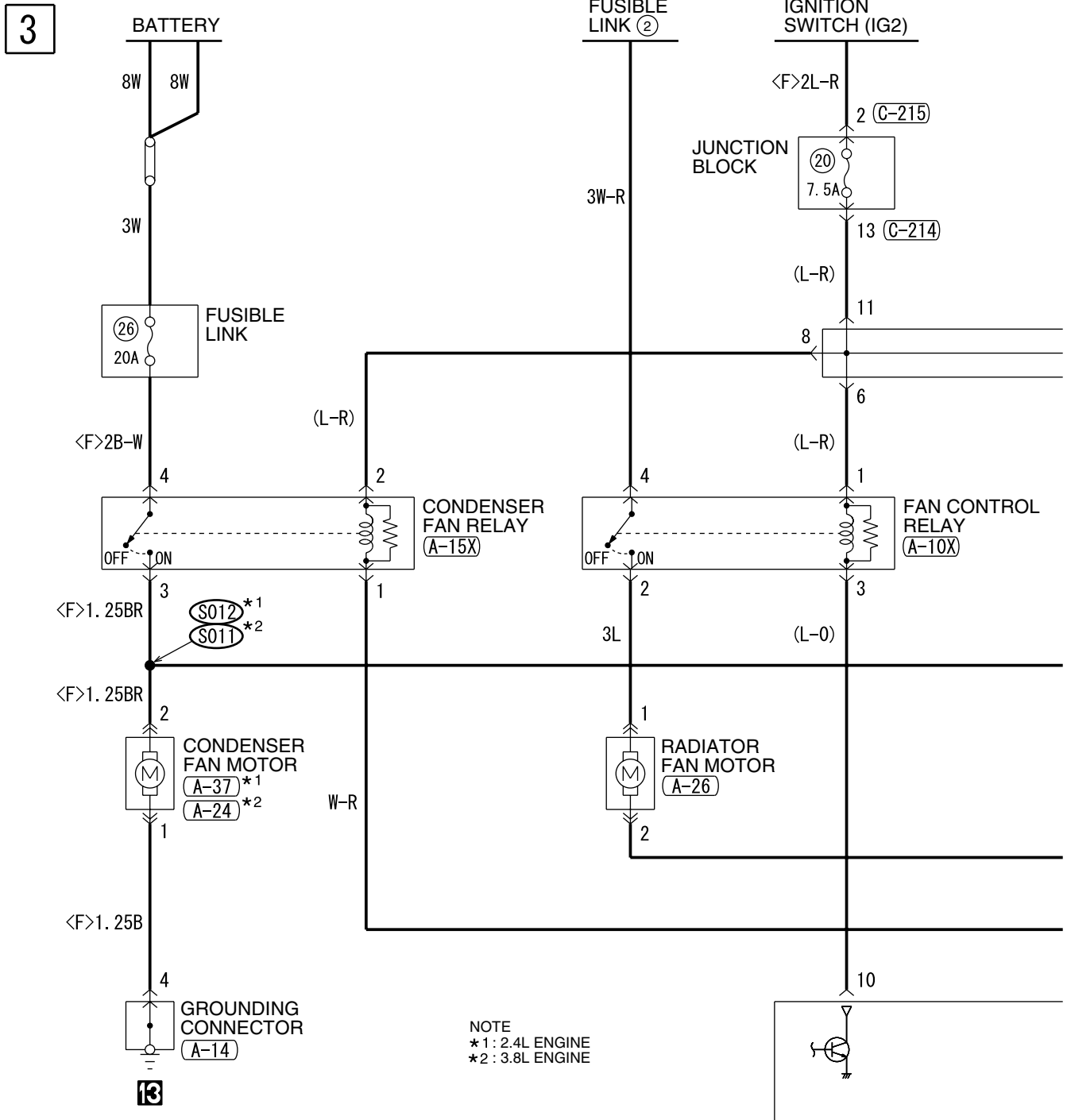

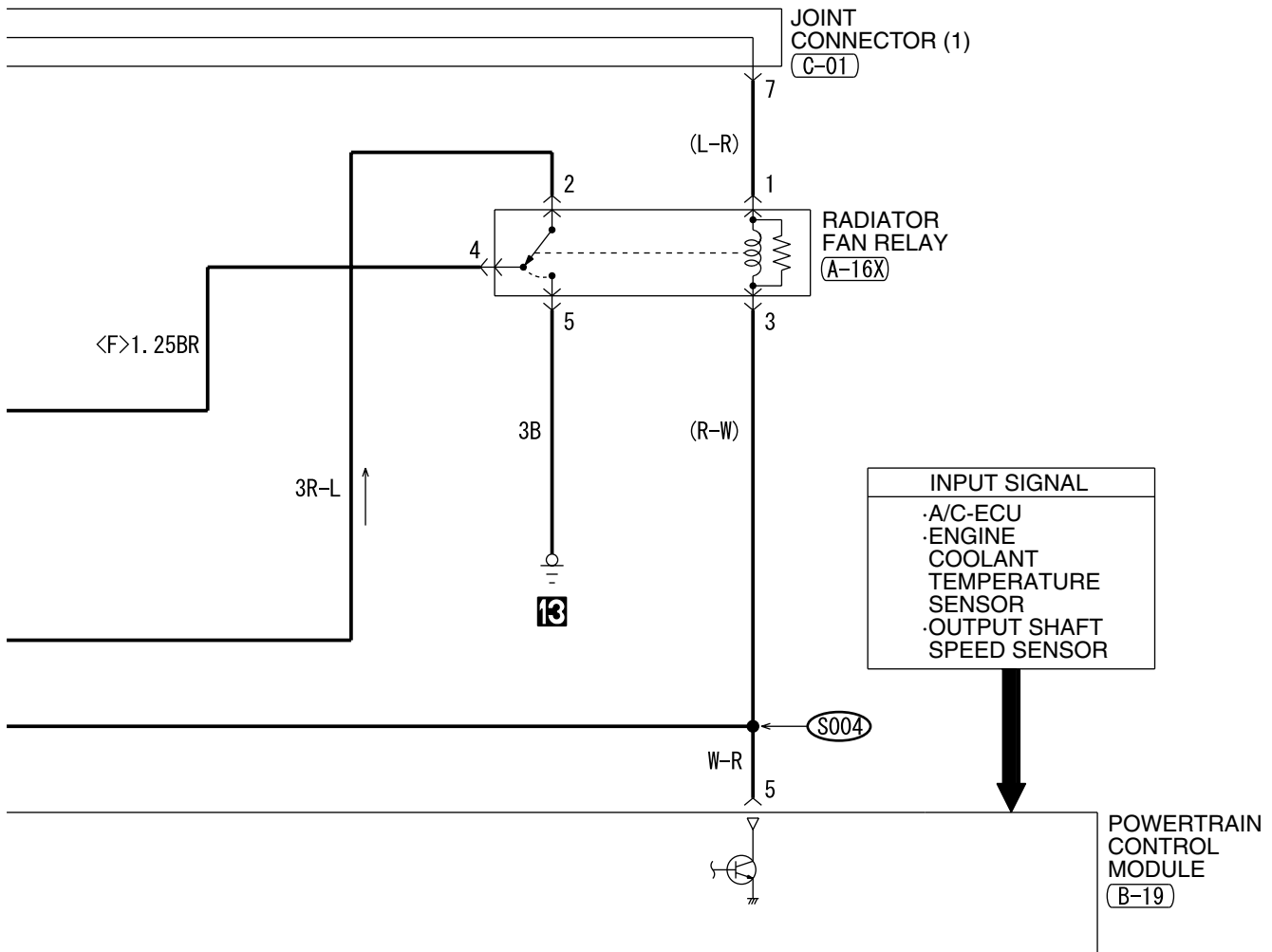

WIRE COLOR CODE  
 B : BLACK LG : LIGHT GREEN G : GREEN L : BLUE  
 BR : BROWN O : ORANGE GR : GRAY R : RED W : WHITE  
 SB : SKY BLUE P : PINK Y : YELLOW V : VIOLET

MANUAL AIR CONDITIONING SYSTEM <LOW> (CONTINUED)

5

MODE SELECTION  
DAMPER CONTROL  
MOTOR AND POTENTIOMETER (C-102)

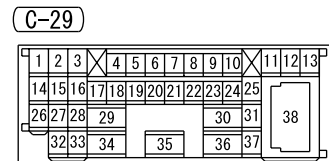
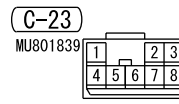
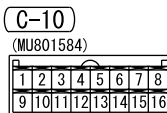
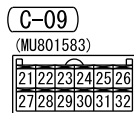
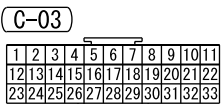
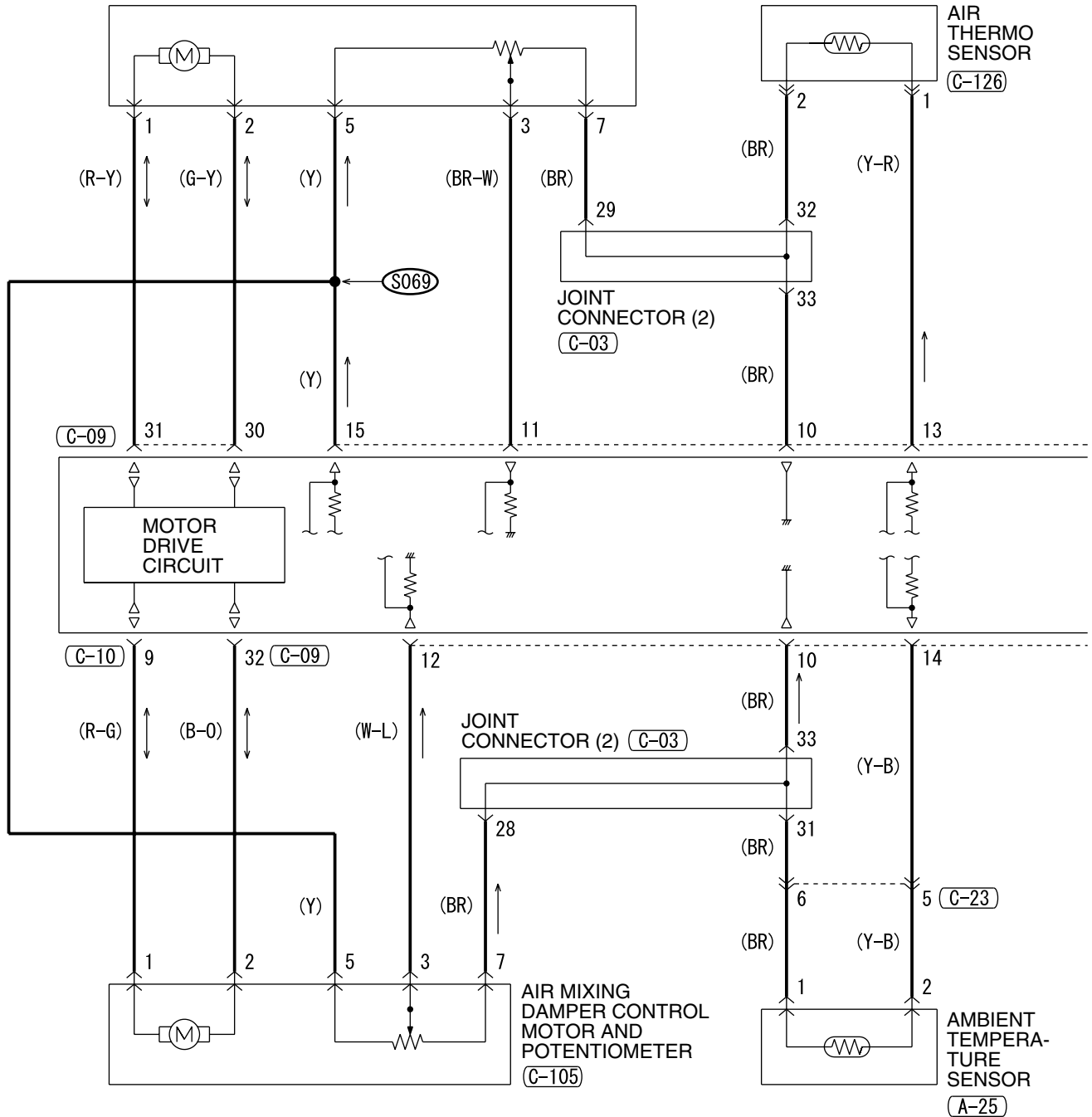

6

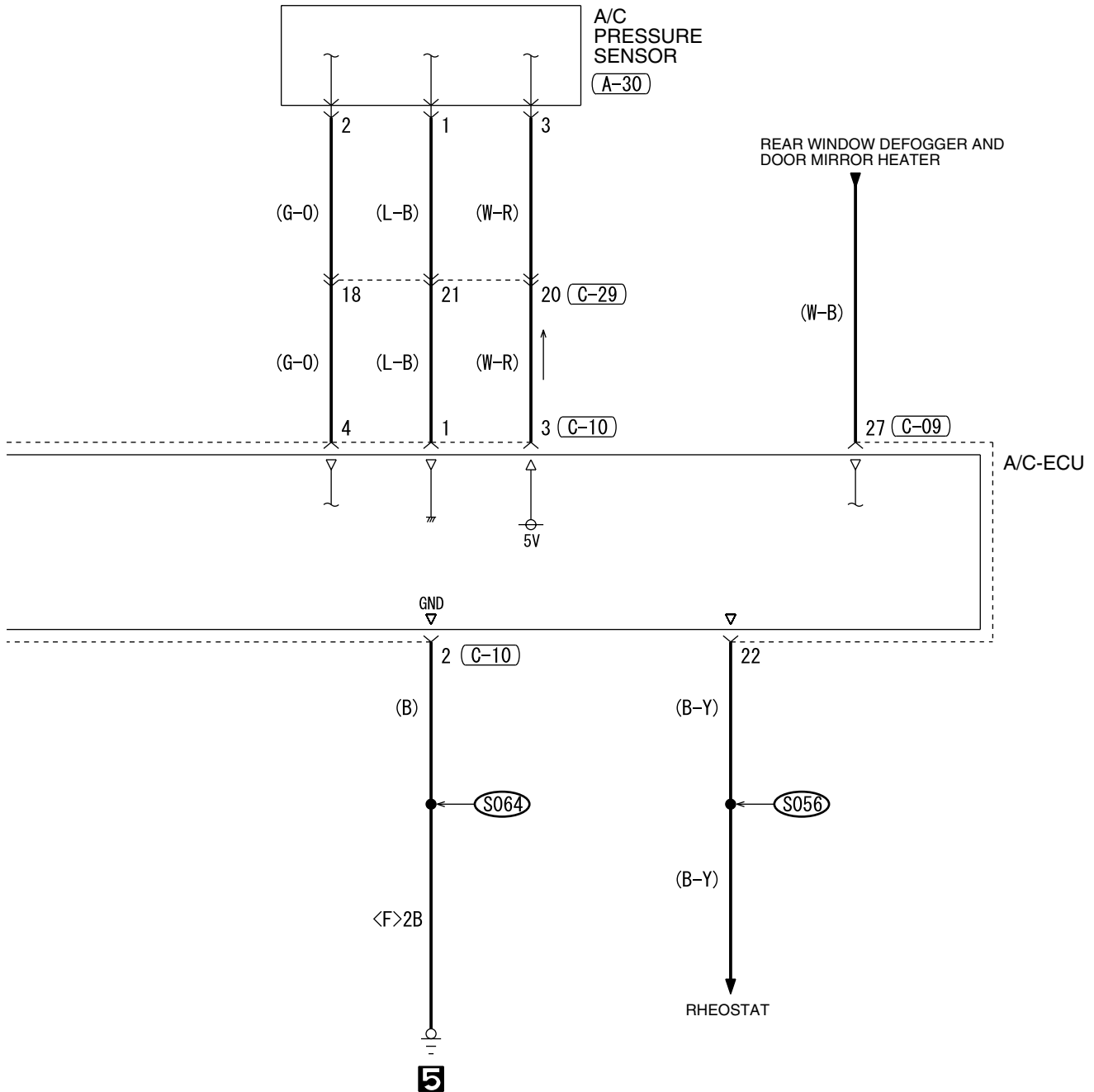

(C-102)

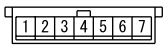

(C-105)

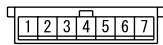

(C-126)



WIRE COLOR CODE

B : BLACK LG : LIGHT GREEN G : GREEN L : BLUE W : WHITE Y : YELLOW  
SB : SKY BLUE BR : BROWN O : ORANGE GR : GRAY R : RED P : PINK V : VIOLET

MANUAL AIR CONDITIONING SYSTEM <LOW> (CONTINUED)

7

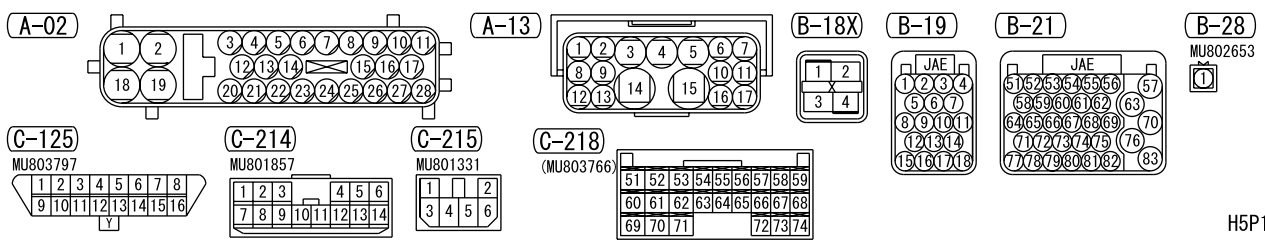
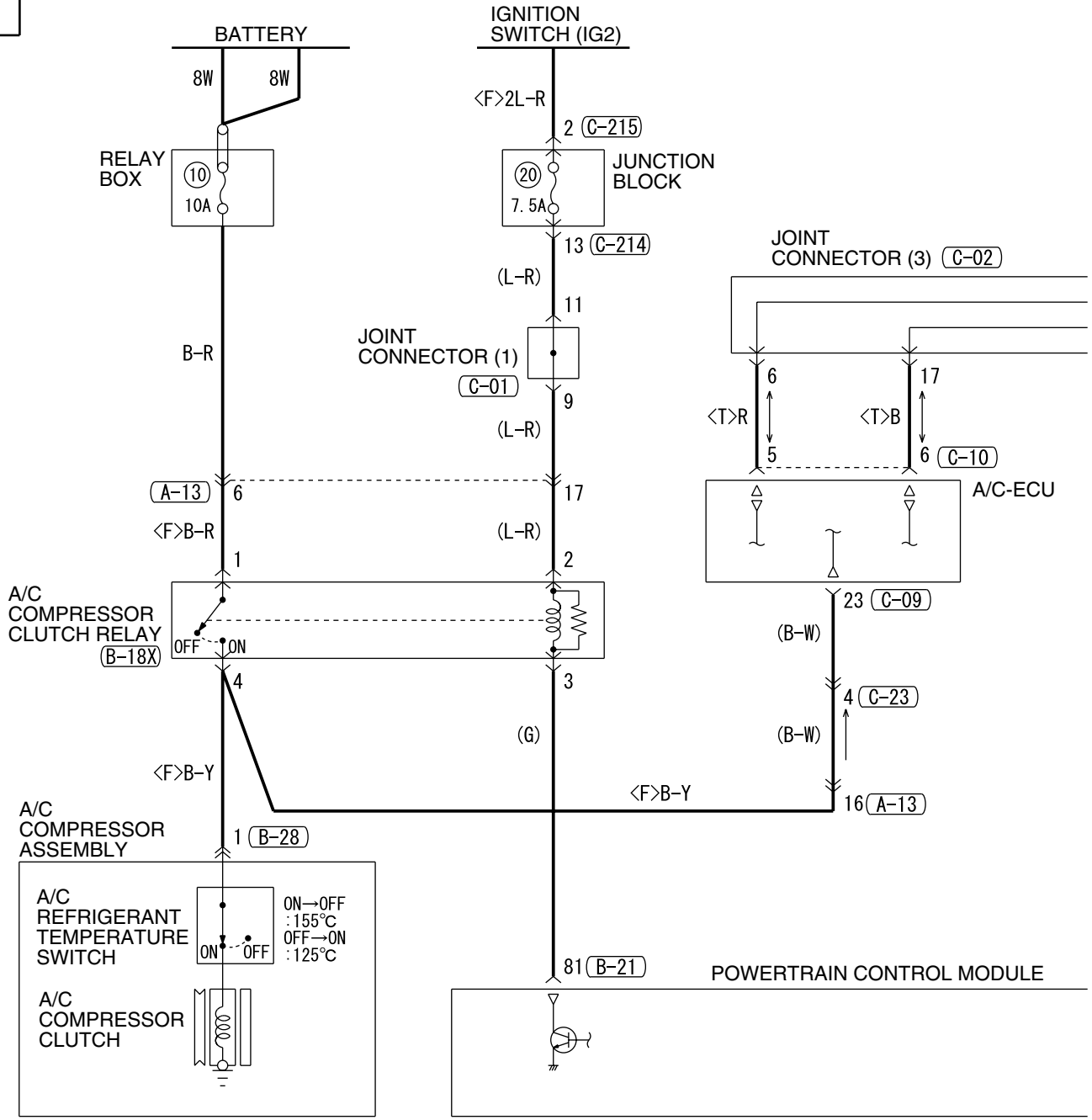

H5P12M00DA

**NOTE**

- \*1 : WITHOUT ELECTRONIC BRAKE-FORCE DISTRIBUTION (EBD) AND ANTI-LOCK BRAKING SYSTEM (ABS)
- \*2 : WITH ELECTRONIC BRAKE-FORCE DISTRIBUTION (EBD) AND ANTI-LOCK BRAKING SYSTEM (ABS)

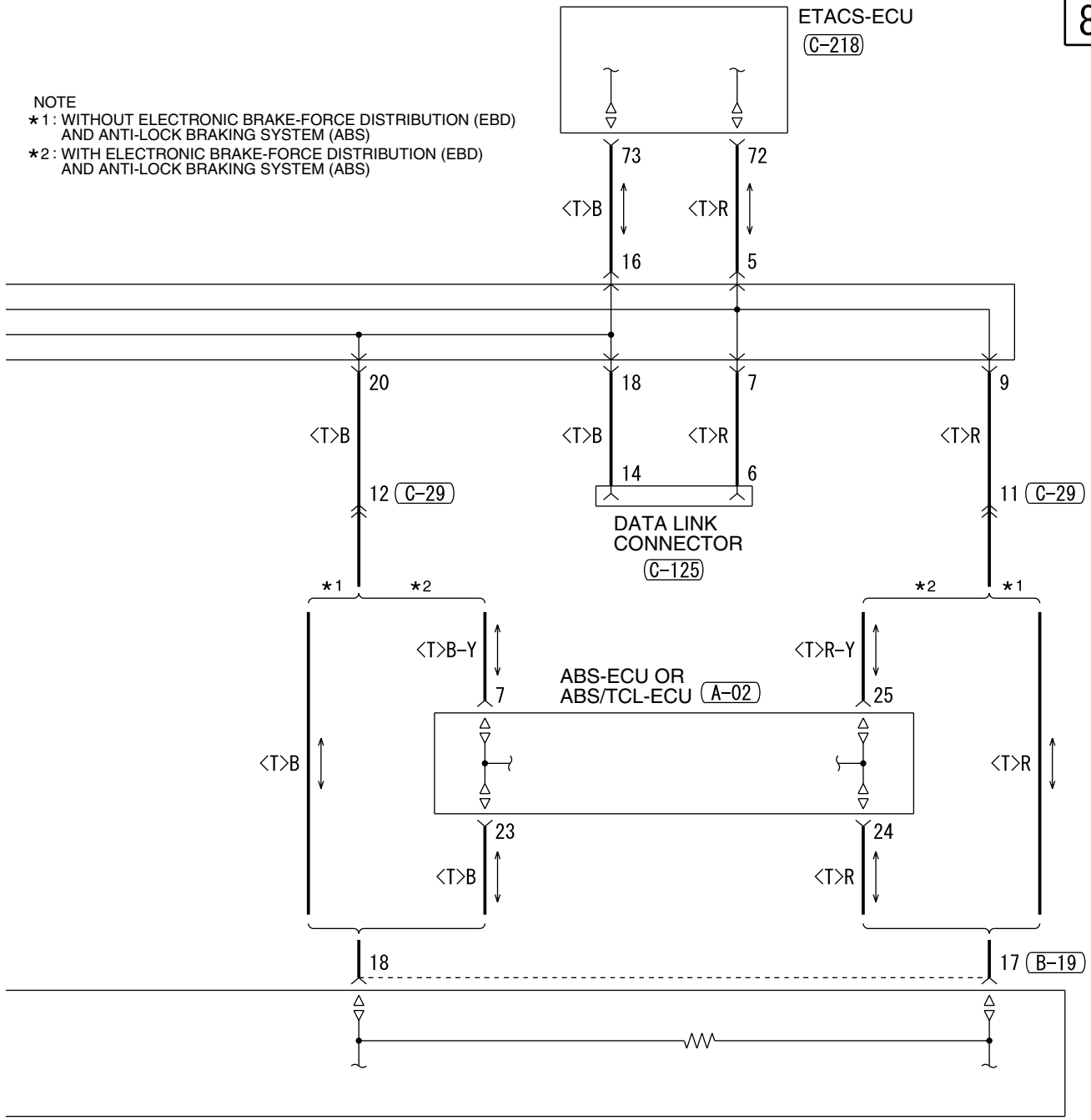

**(C-01)**

1	2	3	4	5	6	7	8	9	10	11
12	13	14	15	16	17	18	19	20	21	22
23	24	25	26	27	28	29	30	31	32	33

**(C-02)**

1	2	3	4	5	6	7	8	9	10	11
12	13	14	15	16	17	18	19	20	21	22

**(C-09)**

(MU801583)

21	22	23	24	25	26
27	28	29	30	31	32

**(C-10)**

(MU801584)

1	2	3	4	5	6	7	8
9	10	11	12	13	14	15	16

**(C-23)**

MU801839

1	2	3		
4	5	6	7	8

**(C-29)**

1	2	3	4	5	6	7	8	9	10	11	12	13
14	15	16	17	18	19	20	21	22	23	24	25	
26	27	28	29						30	31		
32	33	34						35	36	37		38

**WIRE COLOR CODE**

B : BLACK    LG : LIGHT GREEN    G : GREEN    L : BLUE    W : WHITE    Y : YELLOW  
 SB : SKY BLUE    BR : BROWN    O : ORANGE    GR : GRAY    R : RED    P : PINK    V : VIOLET

MANUAL AIR CONDITIONING SYSTEM <LOW> (CONTINUED)

9

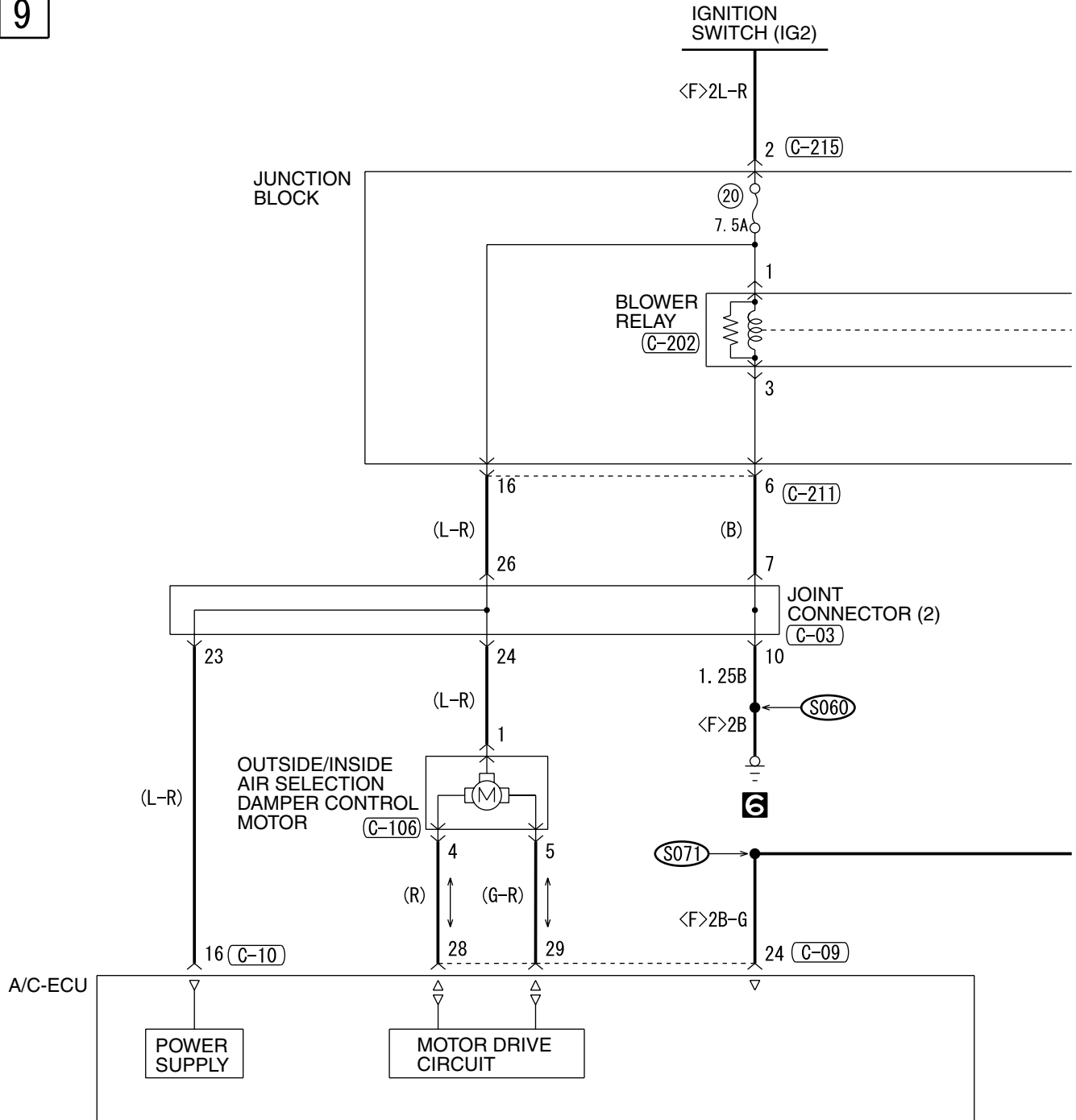

C-03



C-09



C-10

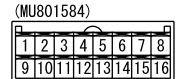

C-14



C-29

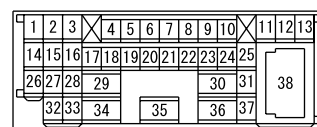

C-103

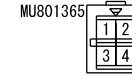

C-106

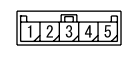



10

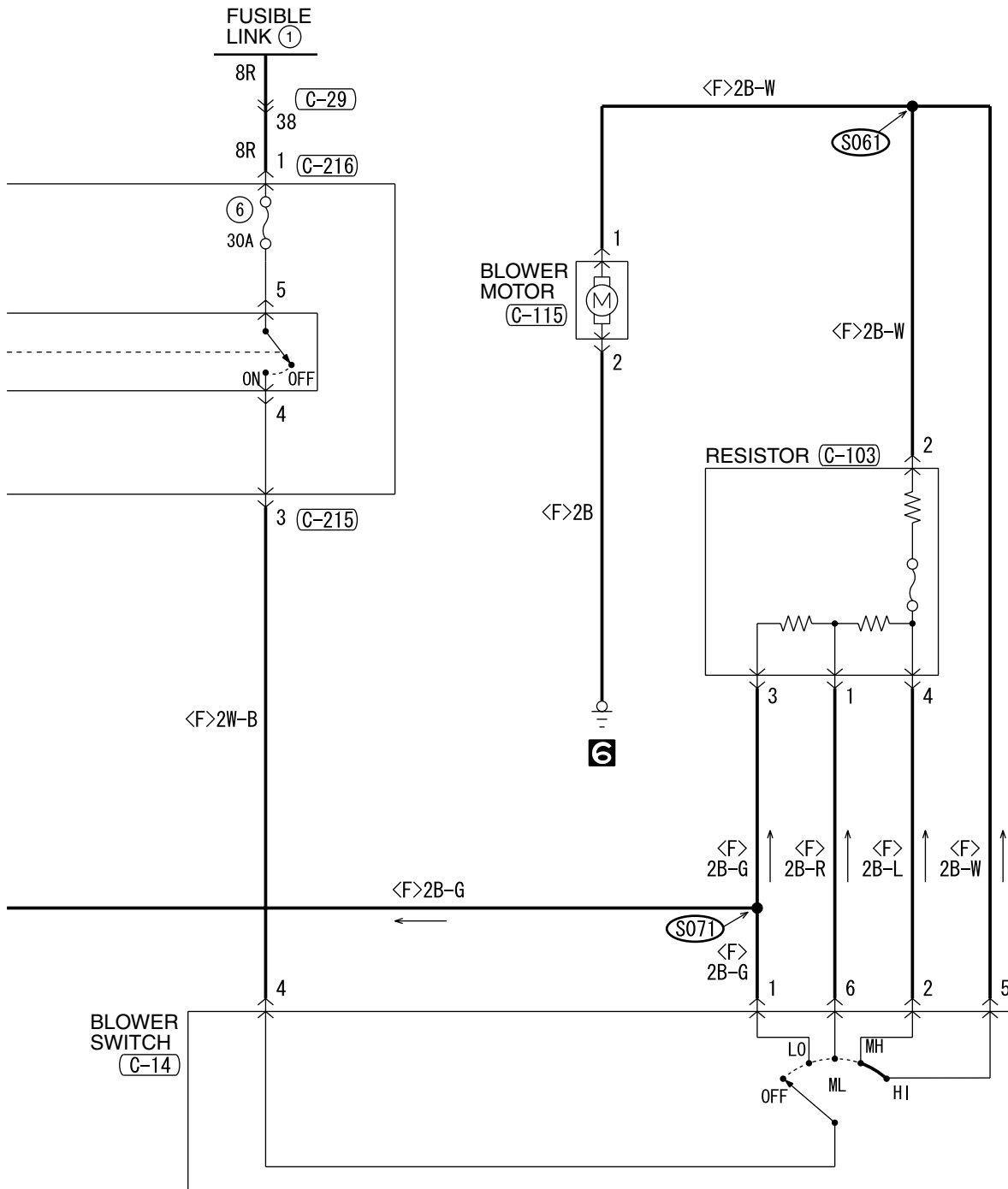

(C-115)

(C-202)

(C-211)

(C-215)

(C-216)

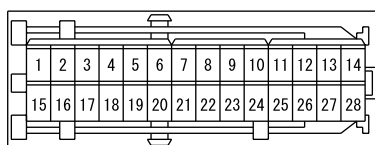

WIRE COLOR CODE  
 B : BLACK SB : SKY BLUE  
 BR : BROWN LG : LIGHT GREEN  
 G : GREEN P : PINK GR : GRAY  
 R : RED L : BLUE Y : YELLOW  
 V : VIOLET W : WHITE O : ORANGE

H5P12M00EB

# MANUAL AIR CONDITIONING SYSTEM <MIDDLE>

M1901005501454

1

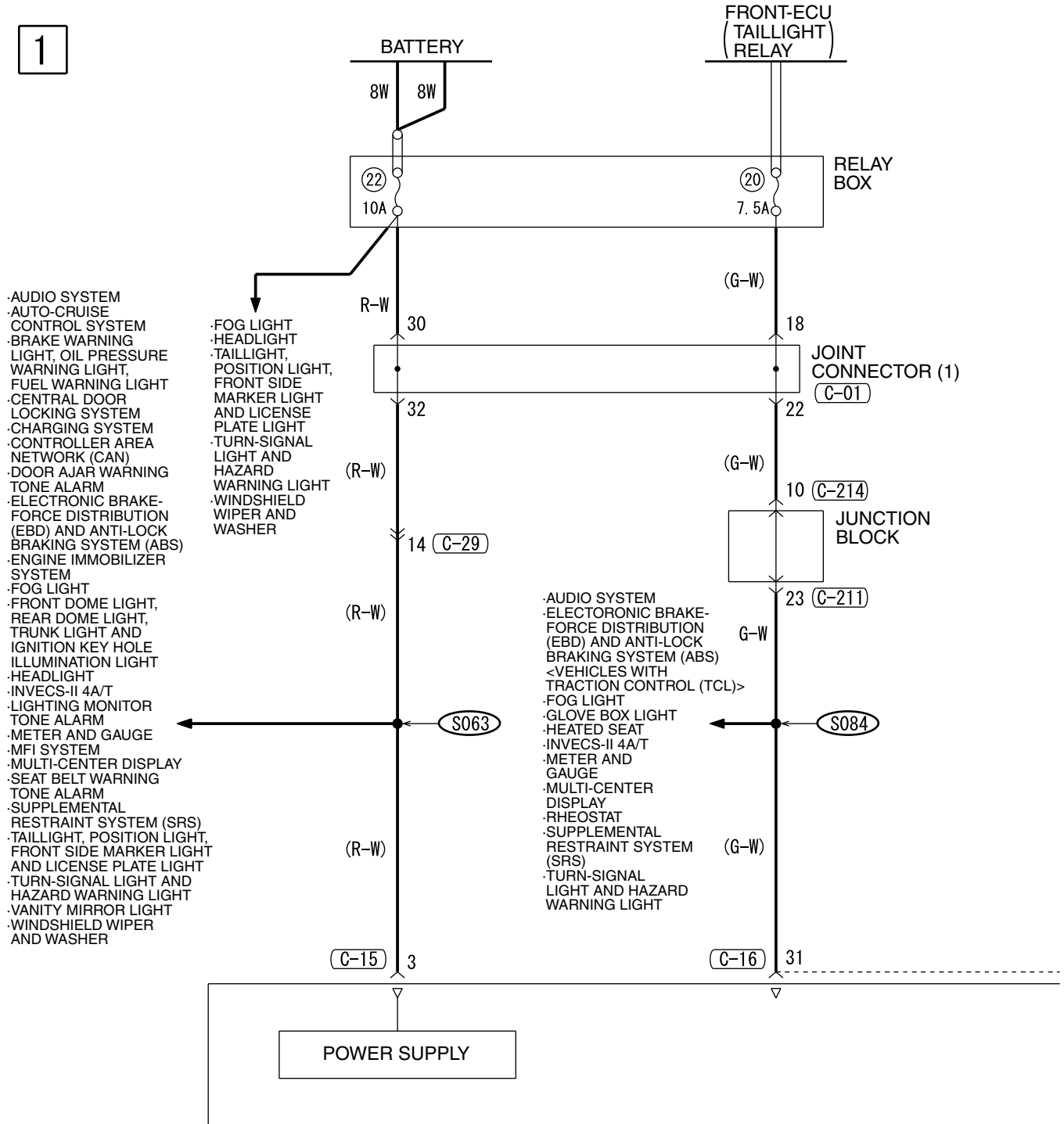

- .AUDIO SYSTEM
- .AUTO-CRUISE CONTROL SYSTEM
- .BRAKE WARNING LIGHT, OIL PRESSURE WARNING LIGHT, FUEL WARNING LIGHT
- .CENTRAL DOOR LOCKING SYSTEM
- .CHARGING SYSTEM
- .CONTROLLER AREA NETWORK (CAN)
- .DOOR AJAR WARNING TONE ALARM
- .ELECTRONIC BRAKE-FORCE DISTRIBUTION (EBD) AND ANTI-LOCK BRAKING SYSTEM (ABS)
- .ENGINE IMMOBILIZER SYSTEM
- .FOG LIGHT
- .FRONT DOME LIGHT, REAR DOME LIGHT, TRUNK LIGHT AND IGNITION KEY HOLE ILLUMINATION LIGHT
- .HEADLIGHT
- .INVECS-II 4A/T
- .LIGHTING MONITOR TONE ALARM
- .METER AND GAUGE
- .MFI SYSTEM
- .MULTI-CENTER DISPLAY
- .SEAT BELT WARNING TONE ALARM
- .SUPPLEMENTAL RESTRAINT SYSTEM (SRS)
- .TAILLIGHT, POSITION LIGHT, FRONT SIDE MARKER LIGHT AND LICENSE PLATE LIGHT
- .TURN-SIGNAL LIGHT AND HAZARD WARNING LIGHT
- .VANITY MIRROR LIGHT
- .WINDSHIELD WIPER AND WASHER

- .FOG LIGHT
- .HEADLIGHT
- .TAILLIGHT, POSITION LIGHT, FRONT SIDE MARKER LIGHT AND LICENSE PLATE LIGHT
- .TURN-SIGNAL LIGHT AND HAZARD WARNING LIGHT
- .WINDSHIELD WIPER AND WASHER

- .AUDIO SYSTEM
- .ELECTRONIC BRAKE-FORCE DISTRIBUTION (EBD) AND ANTI-LOCK BRAKING SYSTEM (ABS) <VEHICLES WITH TRACTION CONTROL (TCL)>
- .FOG LIGHT
- .GLOVE BOX LIGHT
- .HEATED SEAT
- .INVECS-II 4A/T
- .METER AND GAUGE
- .MULTI-CENTER DISPLAY
- .RHEOSTAT
- .SUPPLEMENTAL RESTRAINT SYSTEM (SRS)
- .TURN-SIGNAL LIGHT AND HAZARD WARNING LIGHT

(C-01)

1	2	3	4	5	6	7	8	9	10	11
12	13	14	15	16	17	18	19	20	21	22
23	24	25	26	27	28	29	30	31	32	33

(C-03)

1	2	3	4	5	6	7	8	9	10	11
12	13	14	15	16	17	18	19	20	21	22
23	24	25	26	27	28	29	30	31	32	33

(C-15)

(MU801585)

1	2	3	4	5	6	7	8	9	10
11	12	13	14	15	16	17	18	19	20

(C-16)

(MU801584)

21	22	23	24	25	26	27	28
29	30	31	32	33	34	35	36

(C-29)

1	2	3	4	5	6	7	8	9	10	11	12	13
14	15	16	17	18	19	20	21	22	23	24	25	
26	27	28	29			30	31					
	32	33	34		35		36	37				
										38		

2

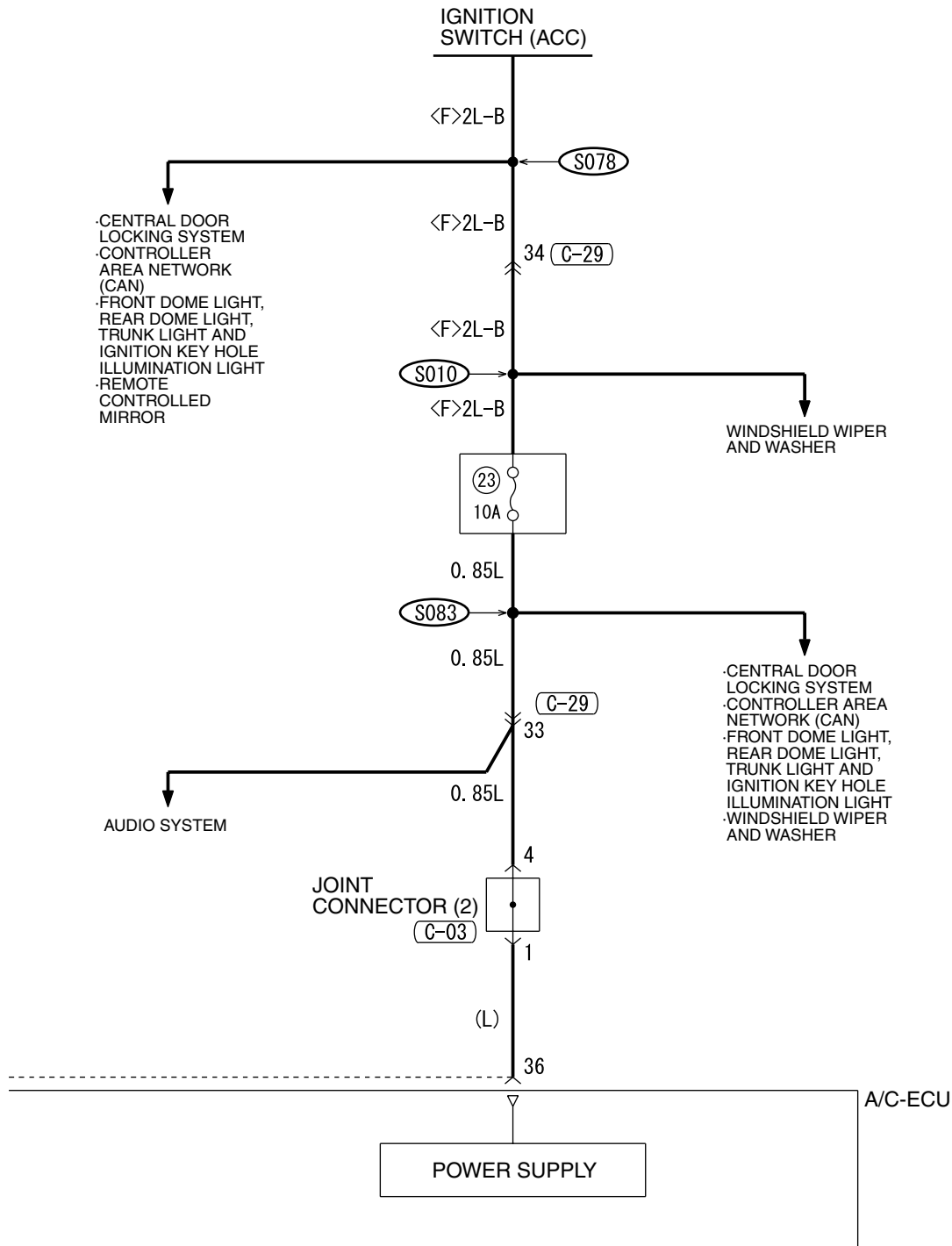

(C-211)

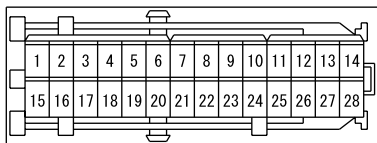

(C-214)

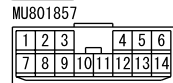

WIRE COLOR CODE  
 B : BLACK LG : LIGHT GREEN G : GREEN L : BLUE  
 BR : BROWN O : ORANGE GR : GRAY R : RED W : WHITE  
 SB : SKY BLUE P : PINK Y : YELLOW V : VIOLET

H5P12M01AB

MANUAL AIR CONDITIONING SYSTEM <MIDDLE> (CONTINUED)

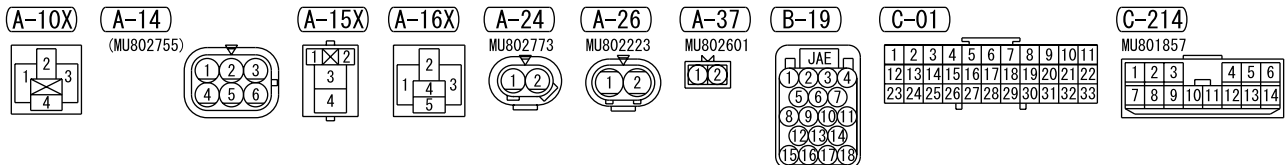
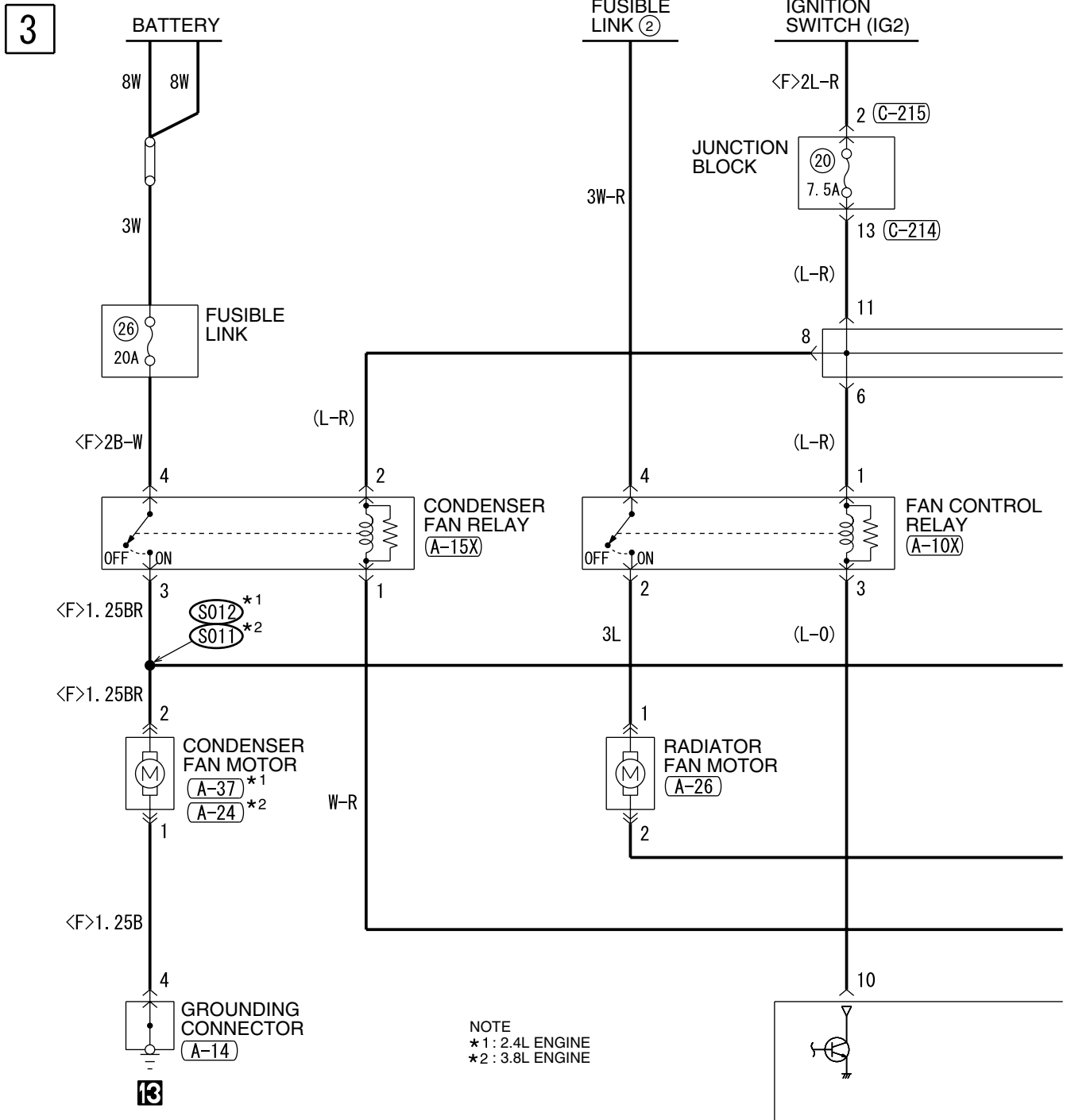

4

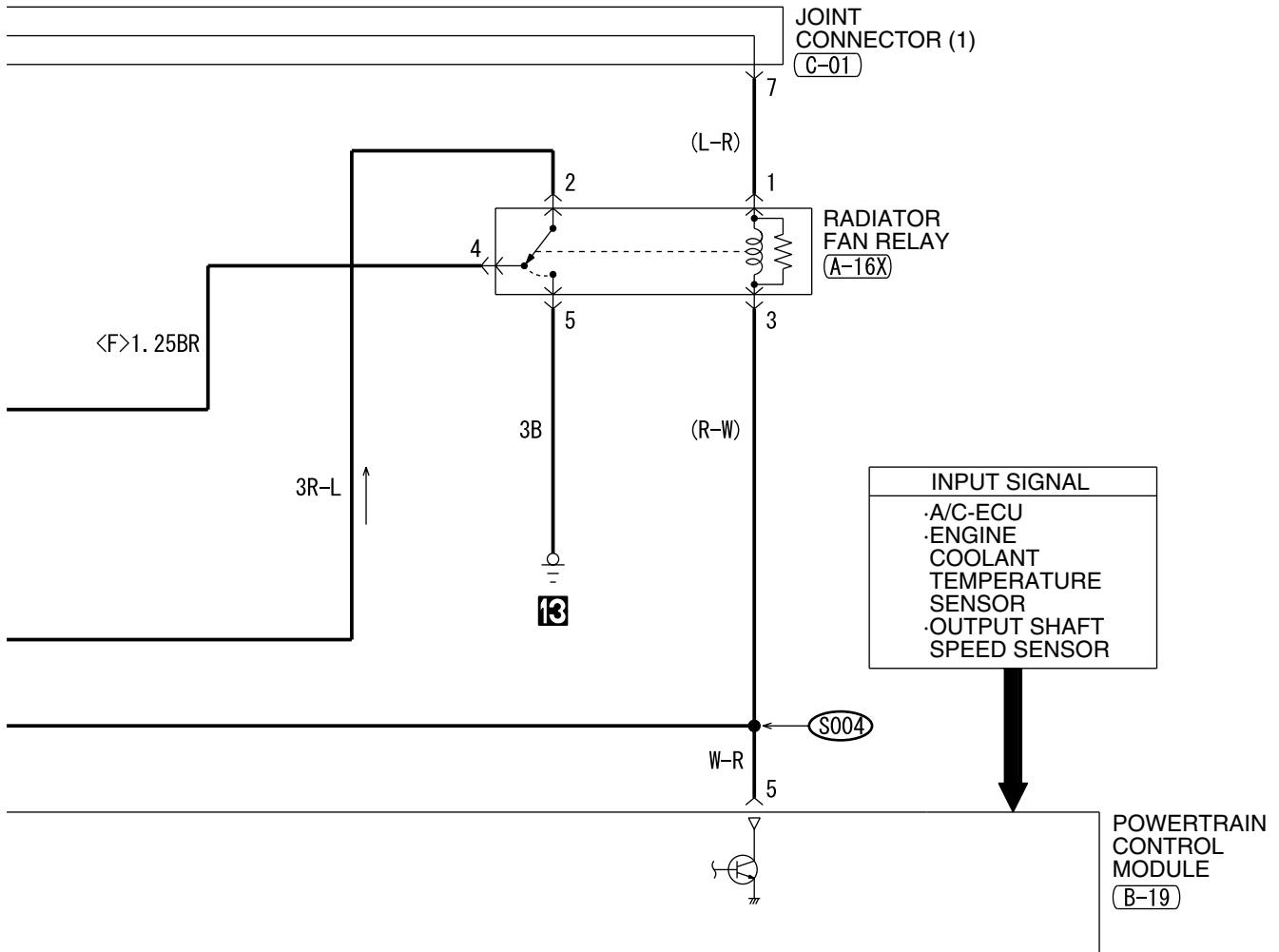

(C-215)

MU801331

1	2
3	4
5	6

WIRE COLOR CODE  
 B : BLACK LG : LIGHT GREEN G : GREEN L : BLUE  
 BR : BROWN O : ORANGE GR : GRAY R : RED W : WHITE  
 SB : SKY BLUE P : PINK Y : YELLOW V : VIOLET

MANUAL AIR CONDITIONING SYSTEM <MIDDLE> (CONTINUED)

5

MODE SELECTION  
DAMPER CONTROL  
MOTOR AND POTENTIOMETER (C-102)

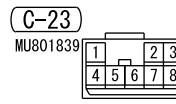
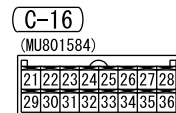
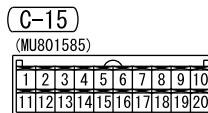
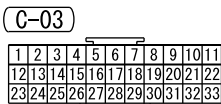
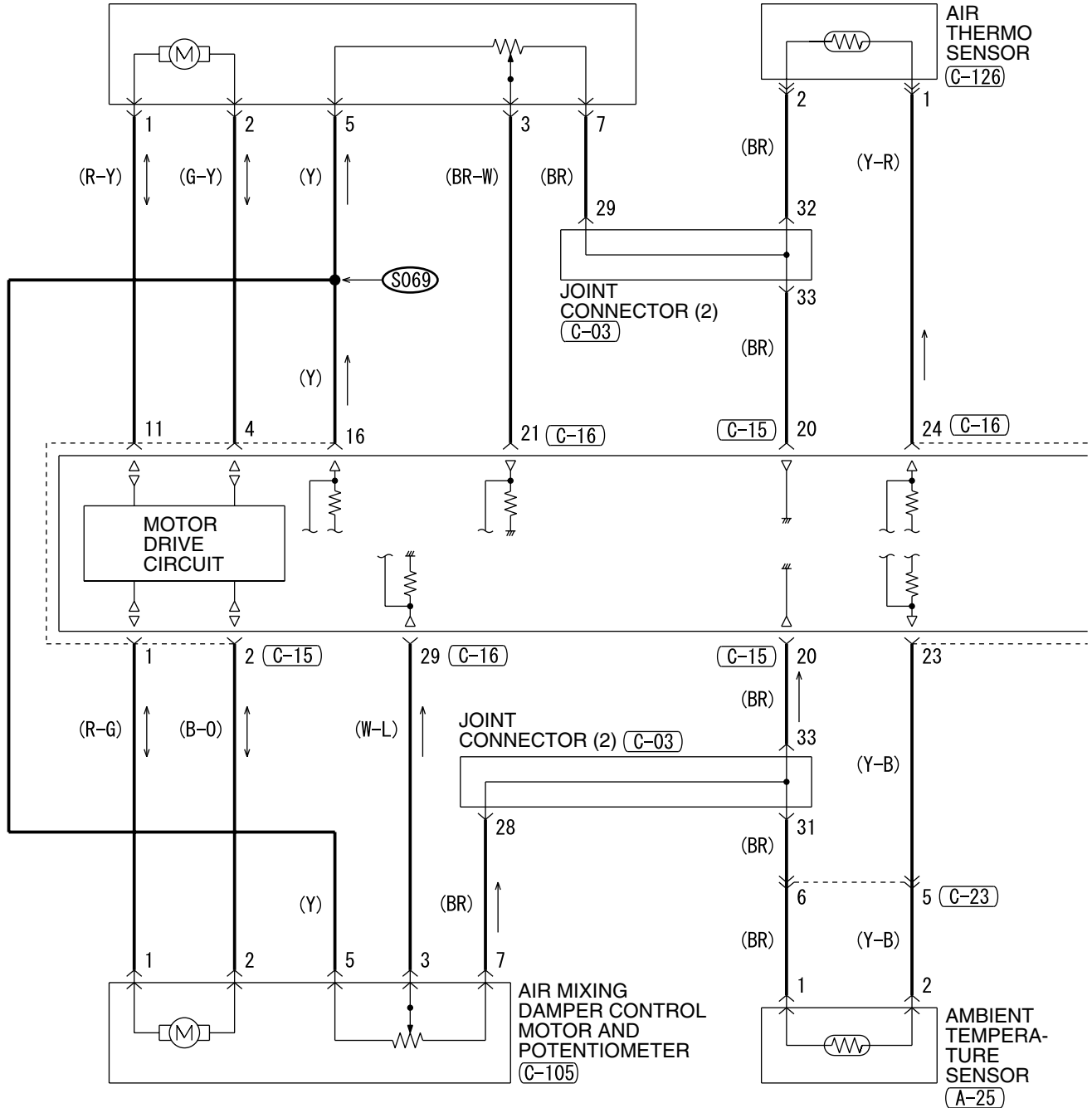

6

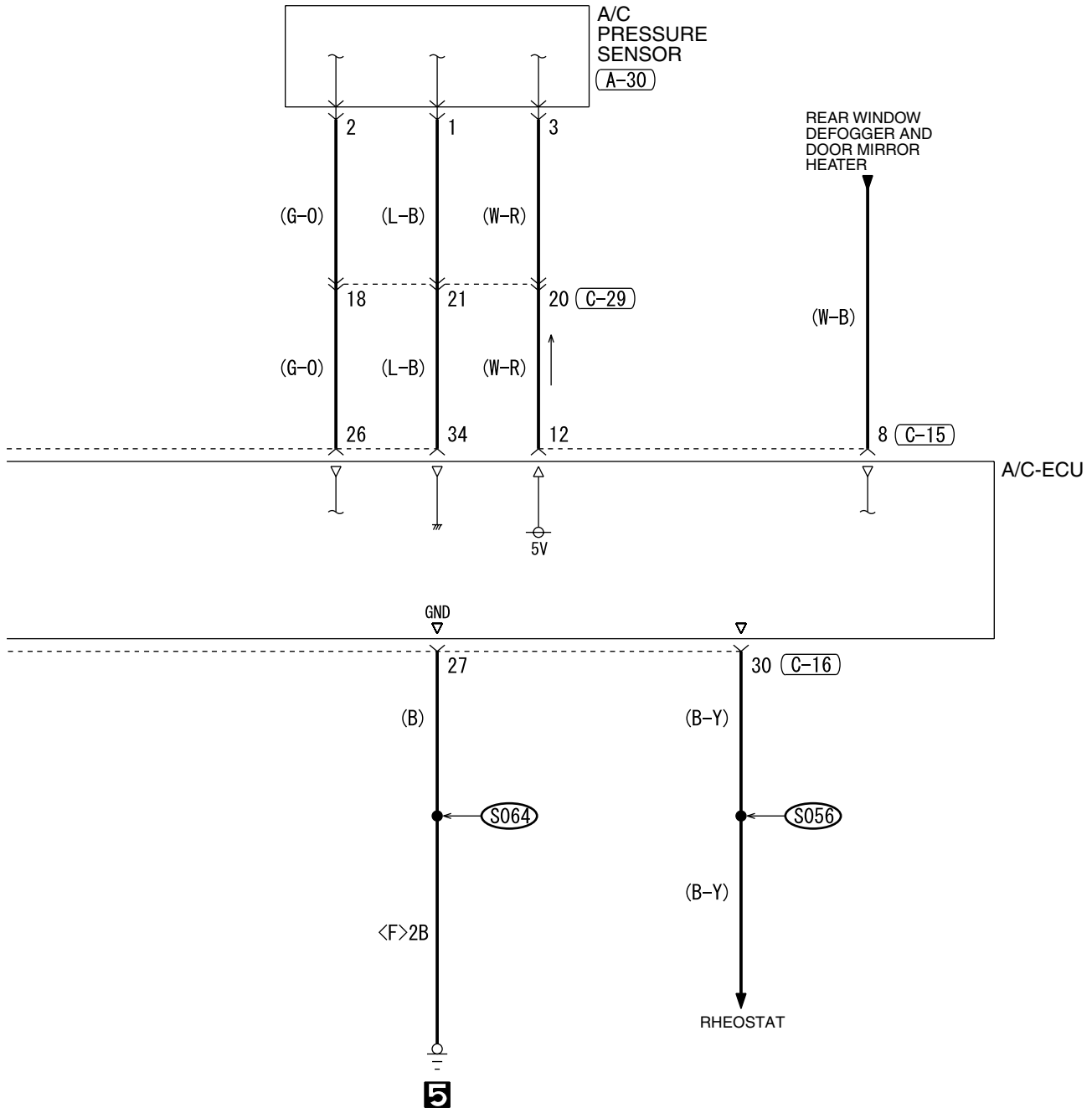

(C-29)

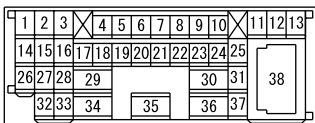

(C-102)

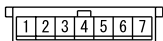

(C-105)

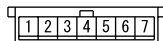

(C-126)



WIRE COLOR CODE  
 B : BLACK LG : LIGHT GREEN G : GREEN L : BLUE  
 BR : BROWN O : ORANGE GR : GRAY R : RED W : WHITE  
 SB : SKY BLUE P : PINK Y : YELLOW V : VIOLET

MANUAL AIR CONDITIONING SYSTEM <MIDDLE> (CONTINUED)

7

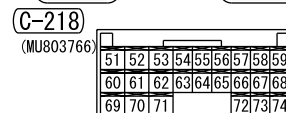
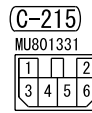
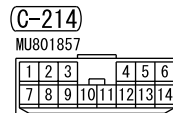
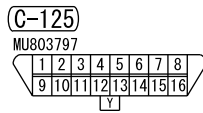
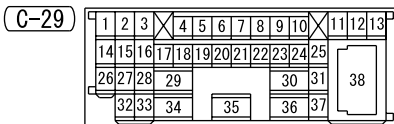
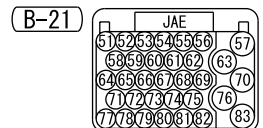
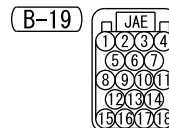
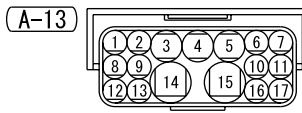
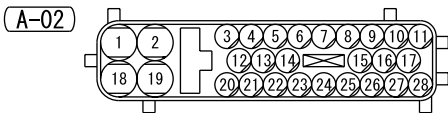
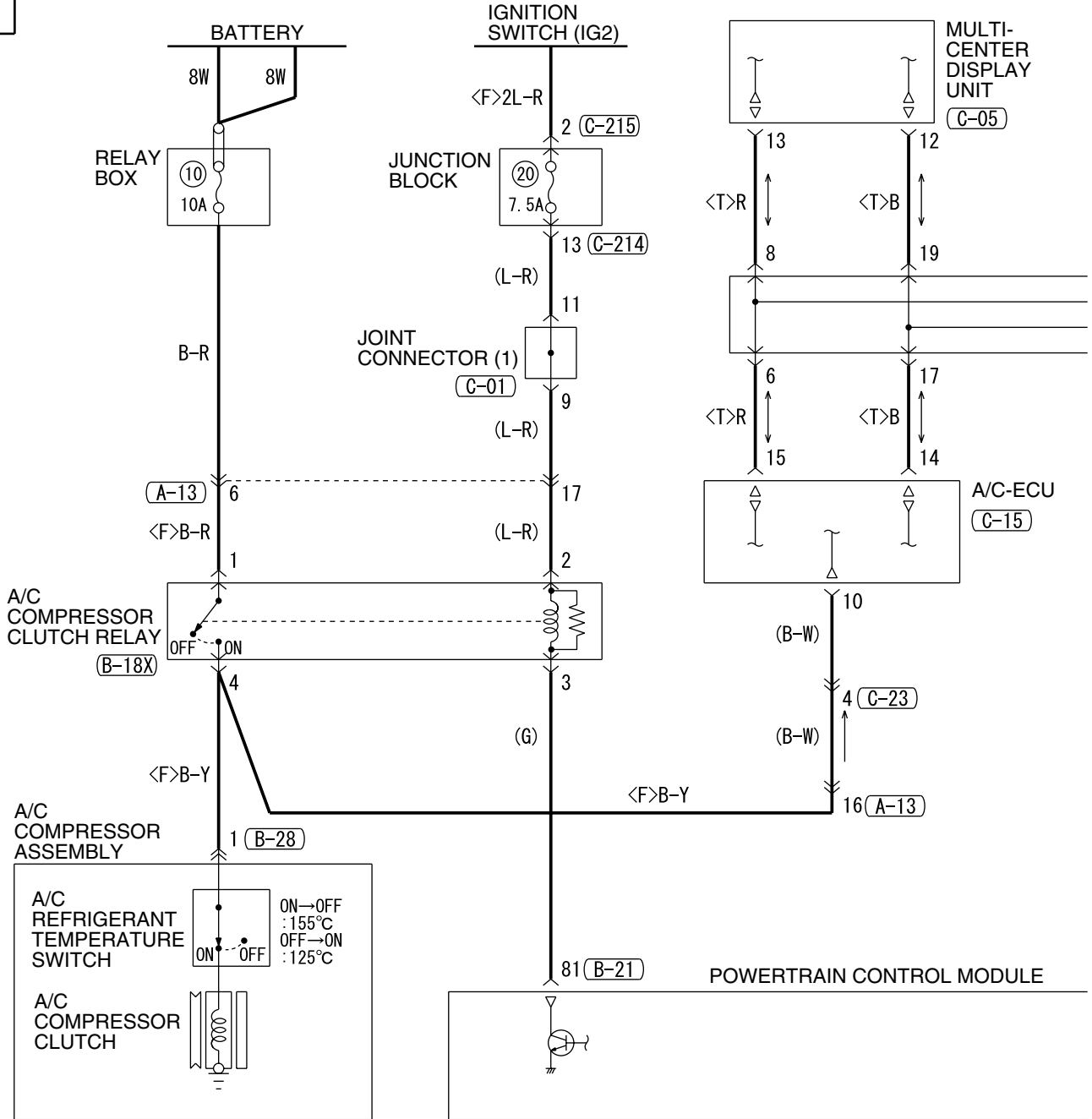

H5P12M01DA



- NOTE  
 \*1: WITHOUT ELECTRONIC BRAKE-FORCE DISTRIBUTION (EBD)  
 AND ANTI-LOCK BRAKING SYSTEM (ABS)  
 \*2: WITH ELECTRONIC BRAKE-FORCE DISTRIBUTION (EBD)  
 AND ANTI-LOCK BRAKING SYSTEM (ABS)

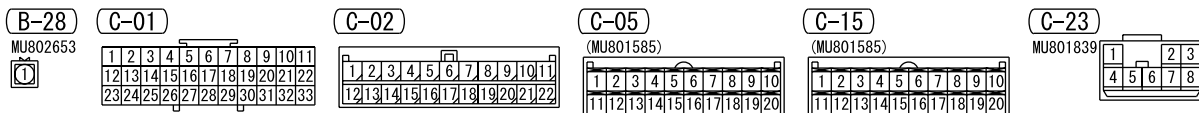
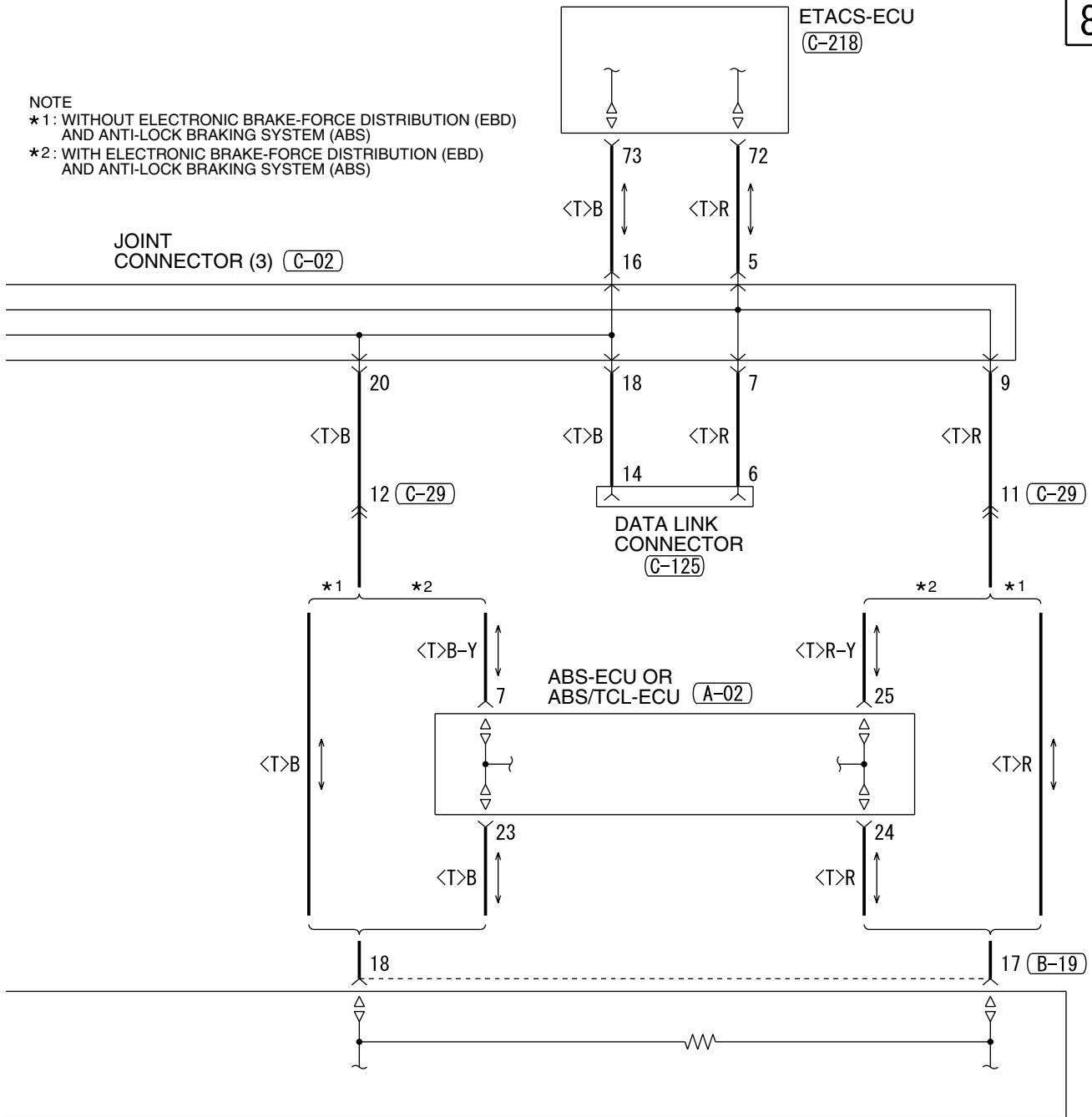

WIRE COLOR CODE  
 B : BLACK LG : LIGHT GREEN G : GREEN L : BLUE W : WHITE Y : YELLOW  
 SB : SKY BLUE BR : BROWN O : ORANGE GR : GRAY R : RED P : PINK V : VIOLET

MANUAL AIR CONDITIONING SYSTEM <MIDDLE> (CONTINUED)

9

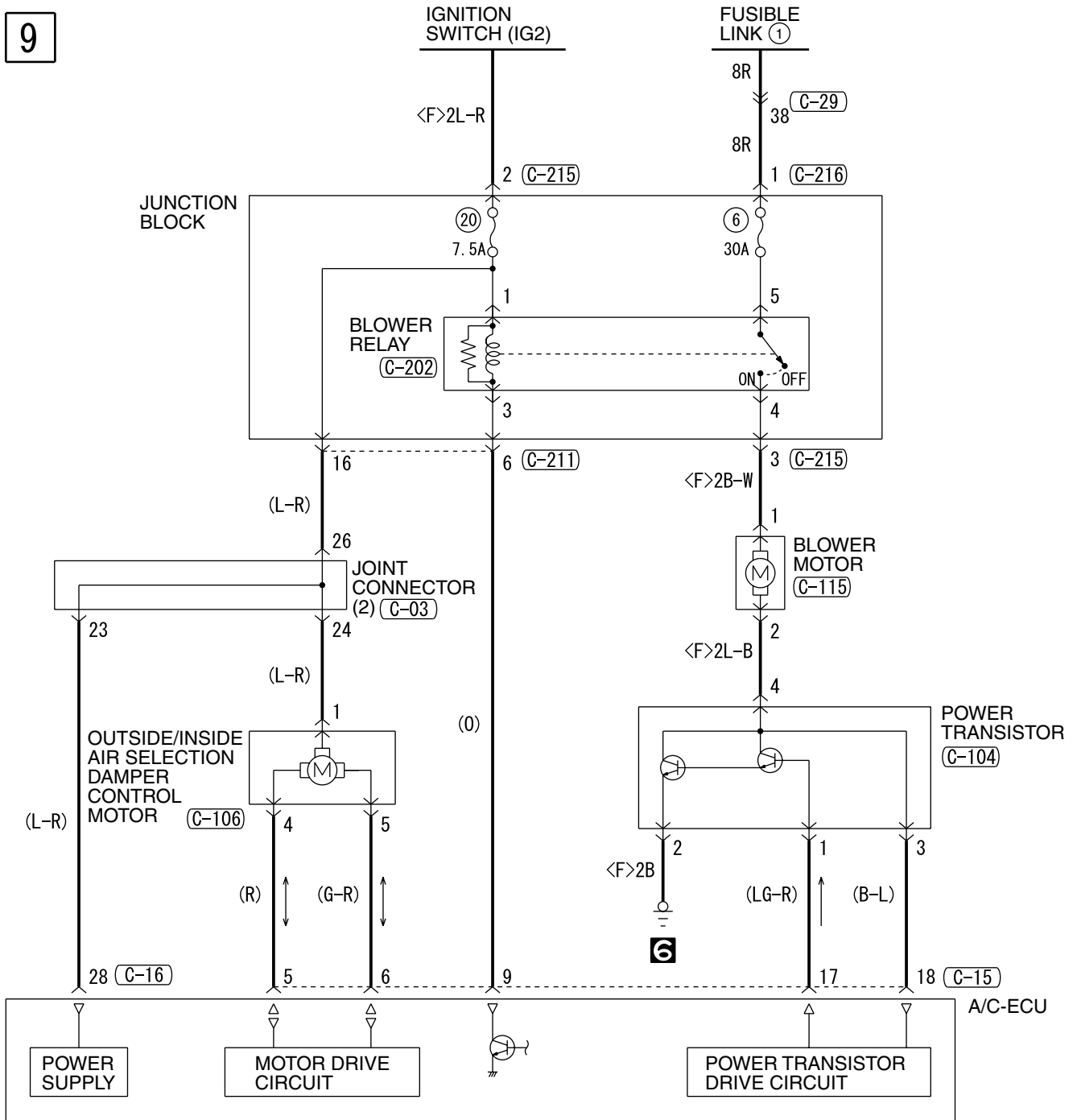

C-03

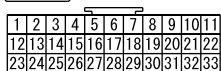

C-15



C-16



C-29

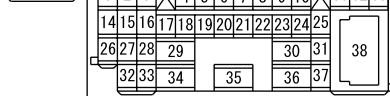

C-104



C-106



C-115



C-202



C-211



C-215



C-216



NOTES

# AUTOMATIC AIR CONDITIONING SYSTEM

M1901005600470

1

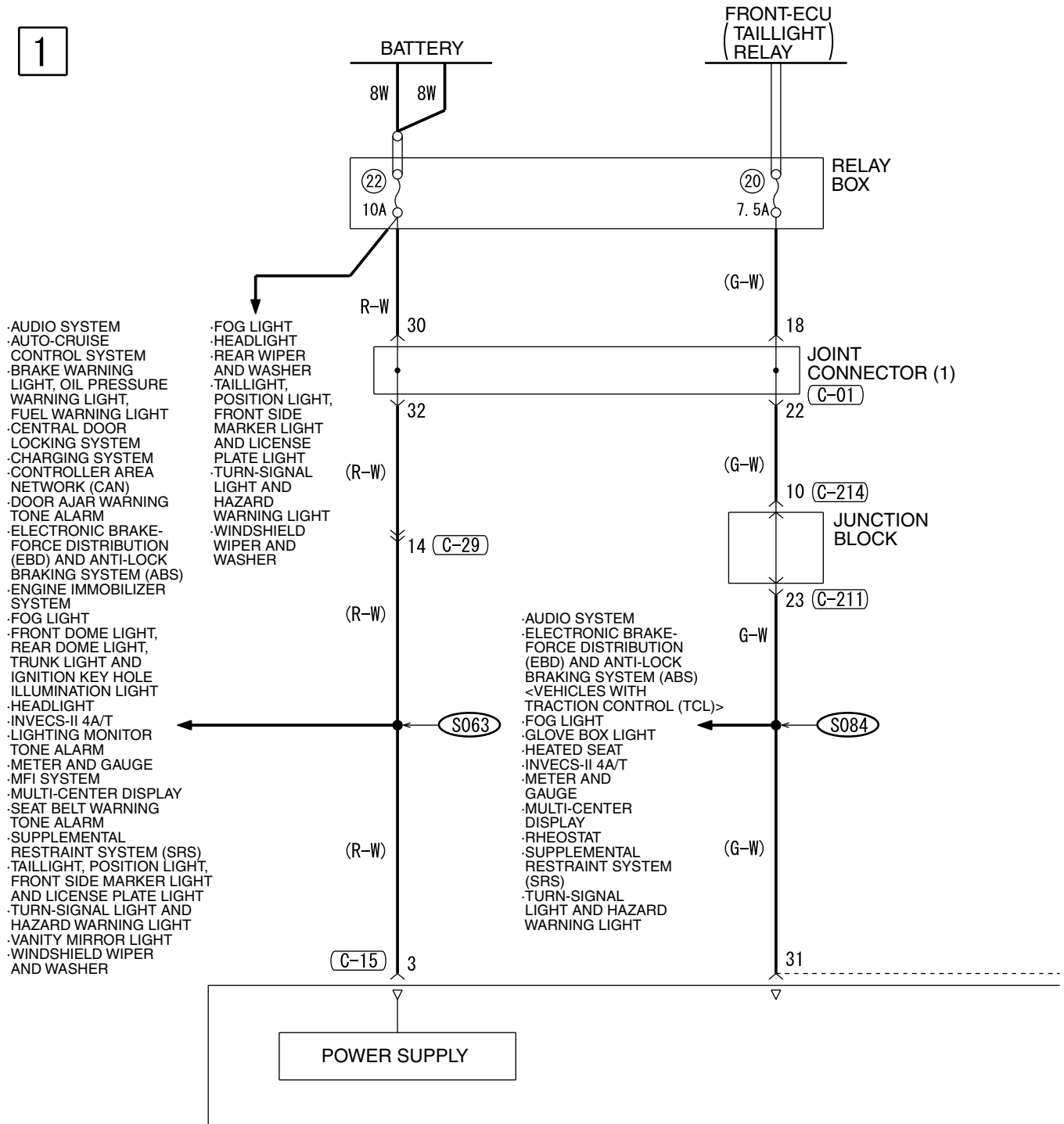

(C-01)

1	2	3	4	5	6	7	8	9	10	11
12	13	14	15	16	17	18	19	20	21	22
23	24	25	26	27	28	29	30	31	32	33

(C-03)

1	2	3	4	5	6	7	8	9	10	11
12	13	14	15	16	17	18	19	20	21	22
23	24	25	26	27	28	29	30	31	32	33

(C-15)

(MU801585)

1	2	3	4	5	6	7	8	9	10
11	12	13	14	15	16	17	18	19	20

(C-16)

(MU801584)

21	22	23	24	25	26	27	28
29	30	31	32	33	34	35	36

(C-29)

1	2	3	4	5	6	7	8	9	10	11	12	13
14	15	16	17	18	19	20	21	22	23	24	25	
26	27	28	29					30	31			
		32	33	34		35			36	37		38

2

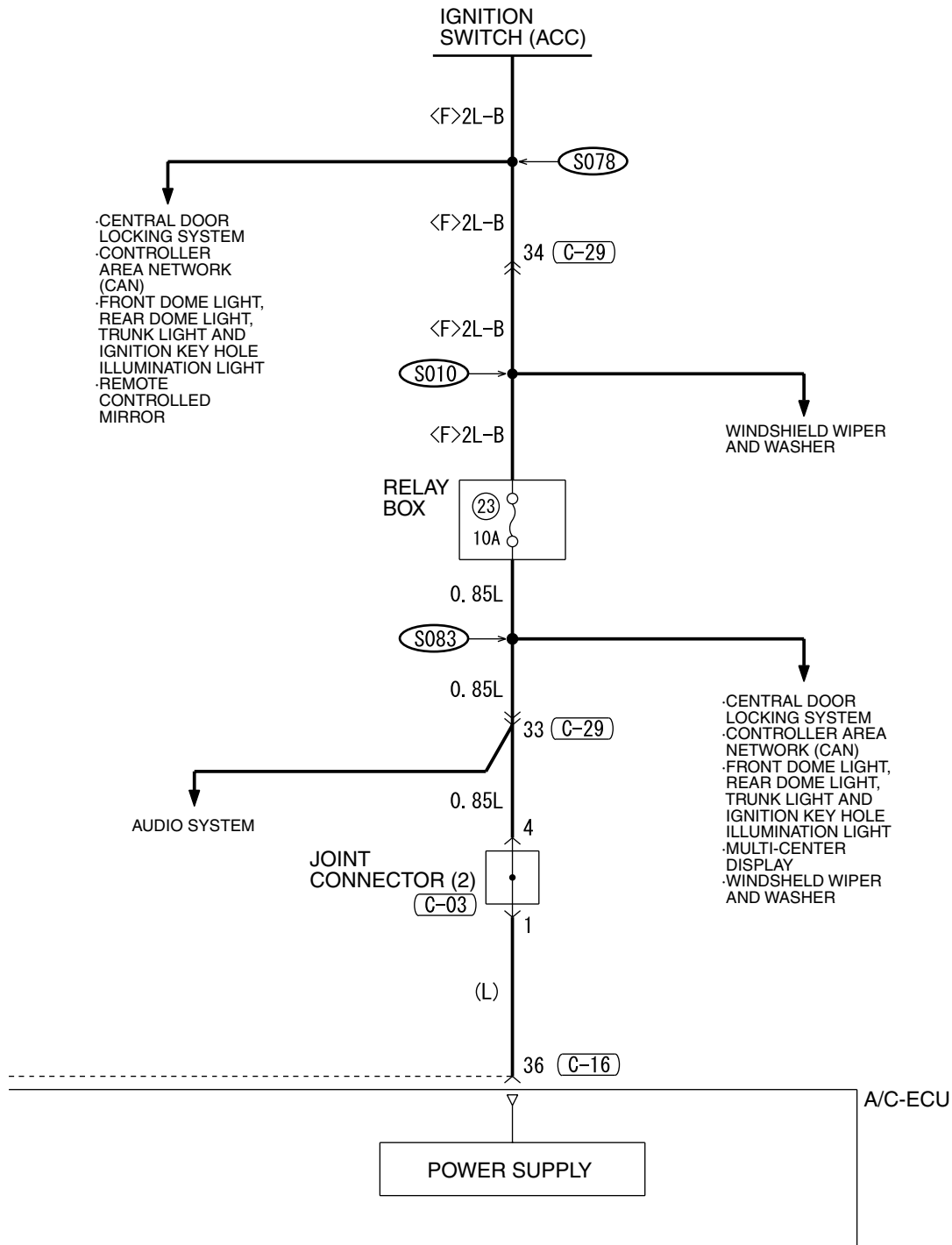

(C-211)

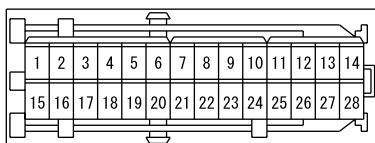

(C-214)

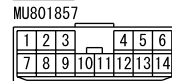

**WIRE COLOR CODE**  
 B : BLACK    LG : LIGHT GREEN    G : GREEN    L : BLUE  
 BR : BROWN    O : ORANGE    GR : GRAY    R : RED    W : WHITE  
 SB : SKY BLUE    P : PINK    Y : YELLOW    V : VIOLET

H5P12M02AB

AUTOMATIC AIR CONDITIONING SYSTEM (CONTINUED)

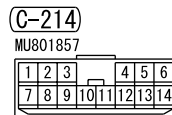
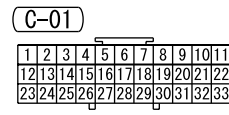
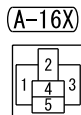
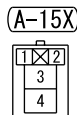
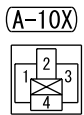
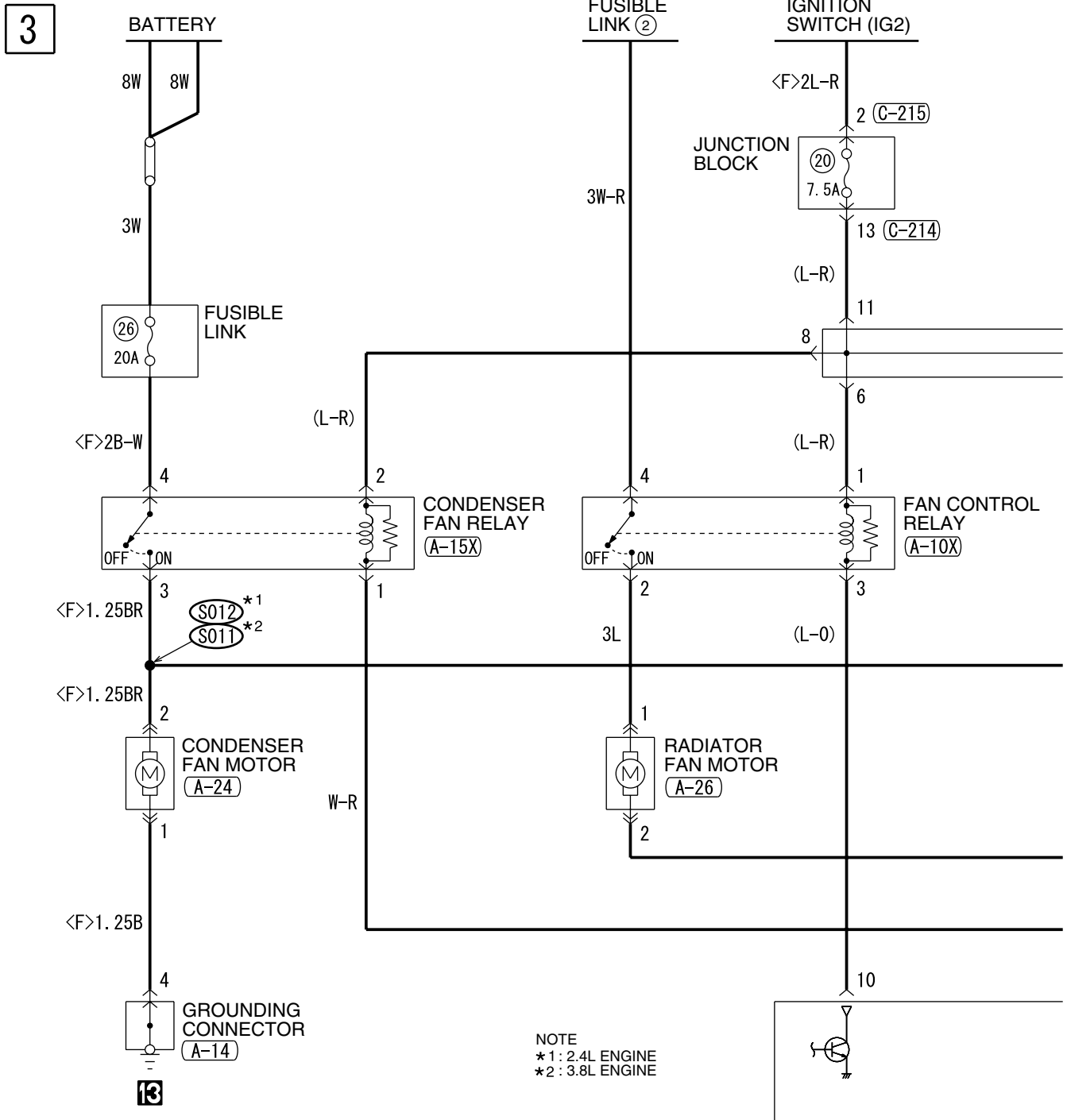

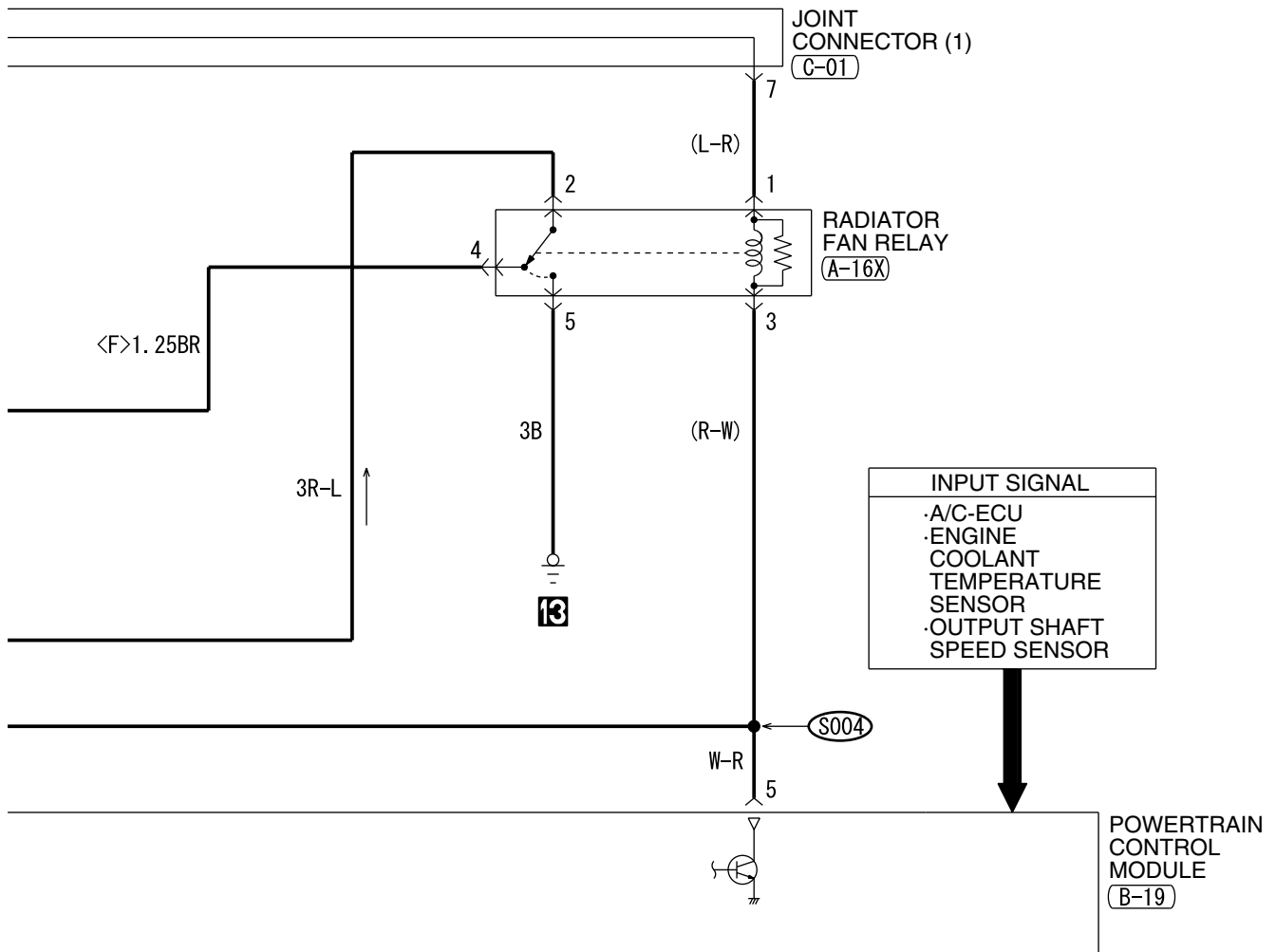

WIRE COLOR CODE  
 B : BLACK LG : LIGHT GREEN G : GREEN L : BLUE  
 BR : BROWN O : ORANGE GR : GRAY R : RED W : WHITE  
 SB : SKY BLUE P : PINK Y : YELLOW V : VIOLET

AUTOMATIC AIR CONDITIONING SYSTEM (CONTINUED)

5

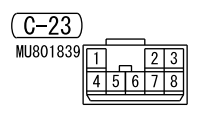
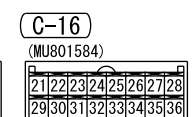
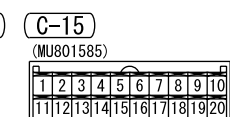
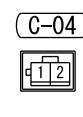
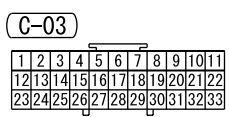
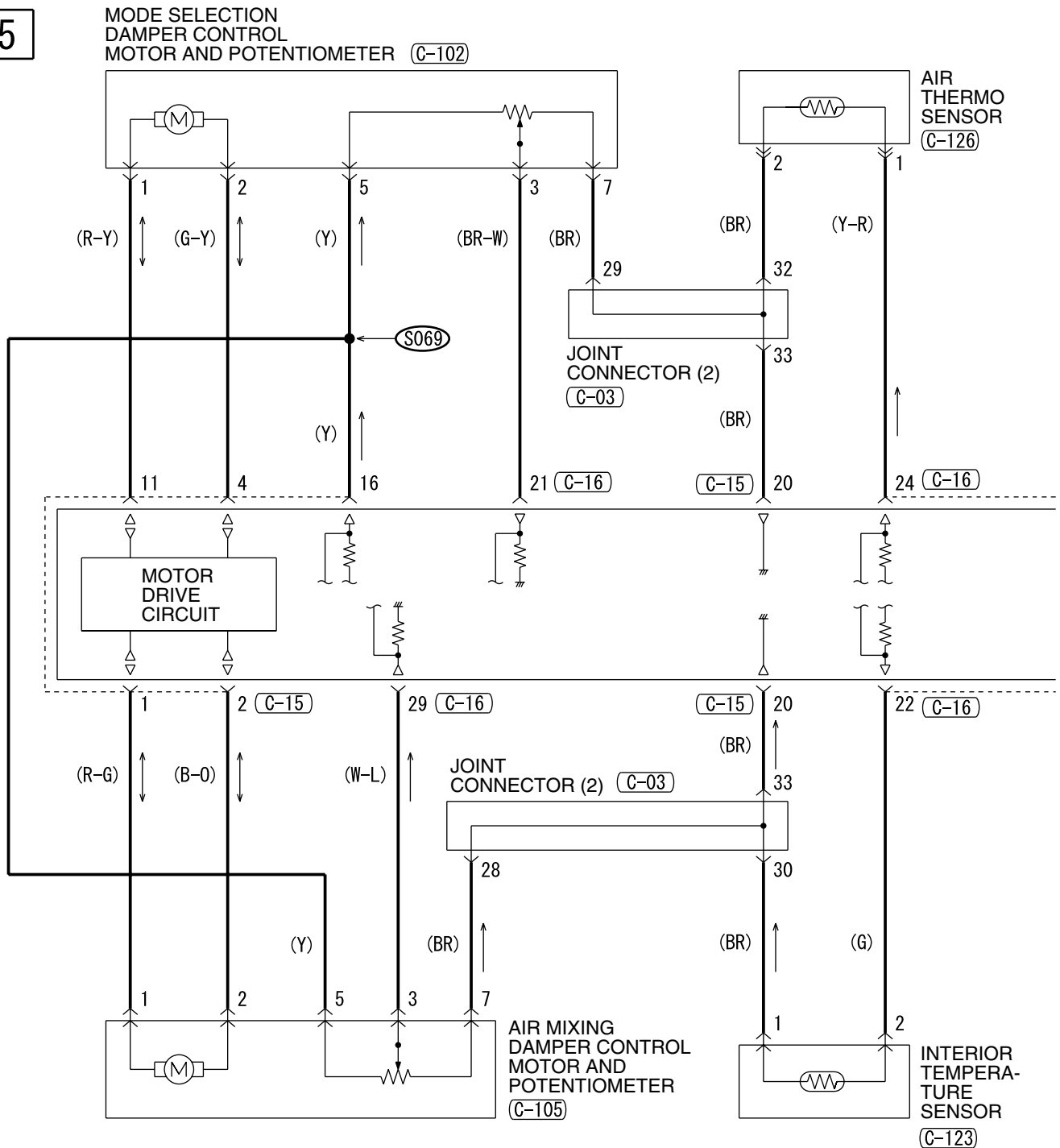



6

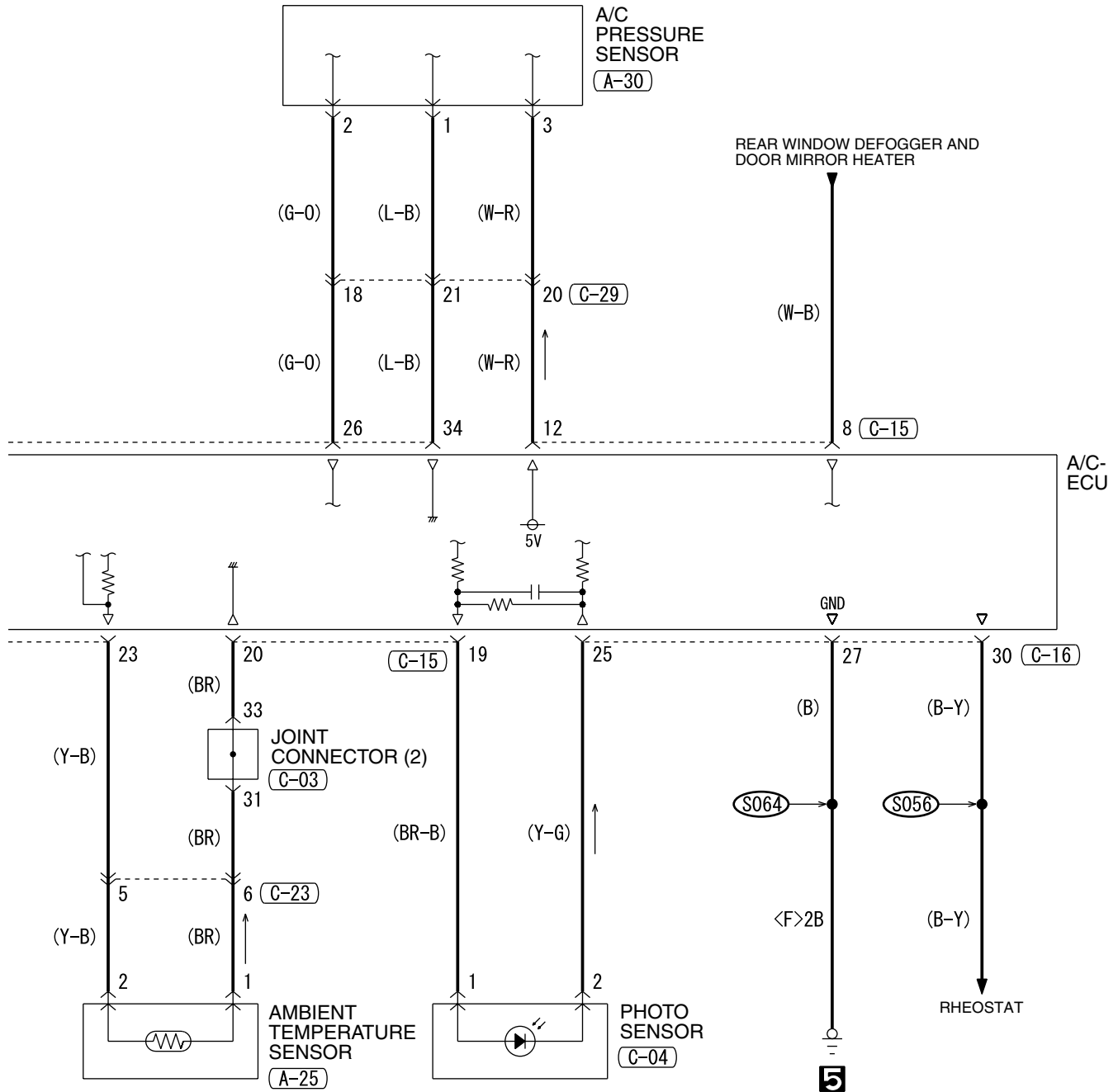

(C-29)

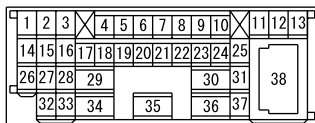

(C-102)

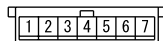

(C-105)

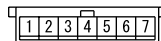

(C-123)



(C-126)



WIRE COLOR CODE  
 B : BLACK LG : LIGHT GREEN G : GREEN L : BLUE  
 BR : BROWN O : ORANGE GR : GRAY R : RED W : WHITE  
 SB : SKY BLUE P : PINK Y : YELLOW V : VIOLET

AUTOMATIC AIR CONDITIONING SYSTEM (CONTINUED)

7

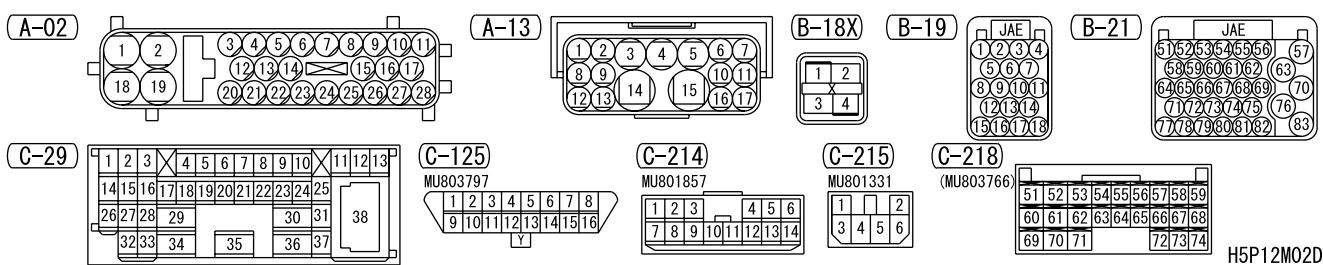
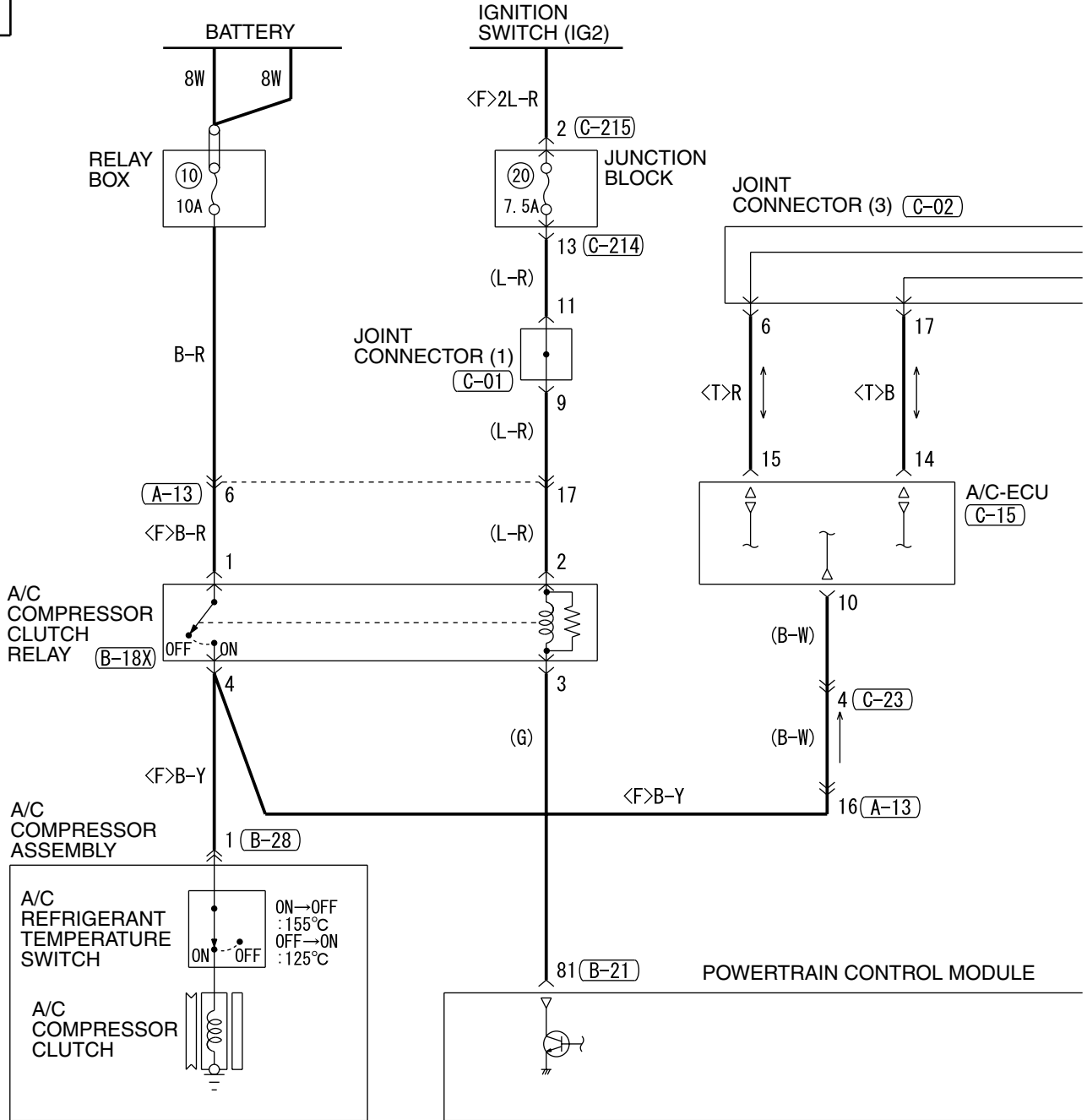

H5P12M02DA

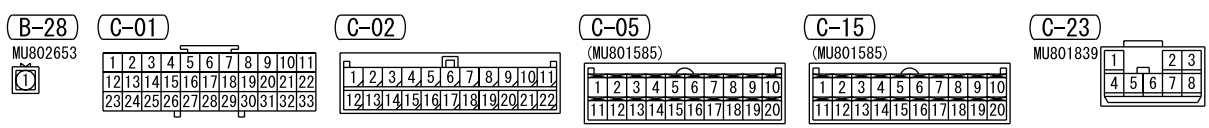
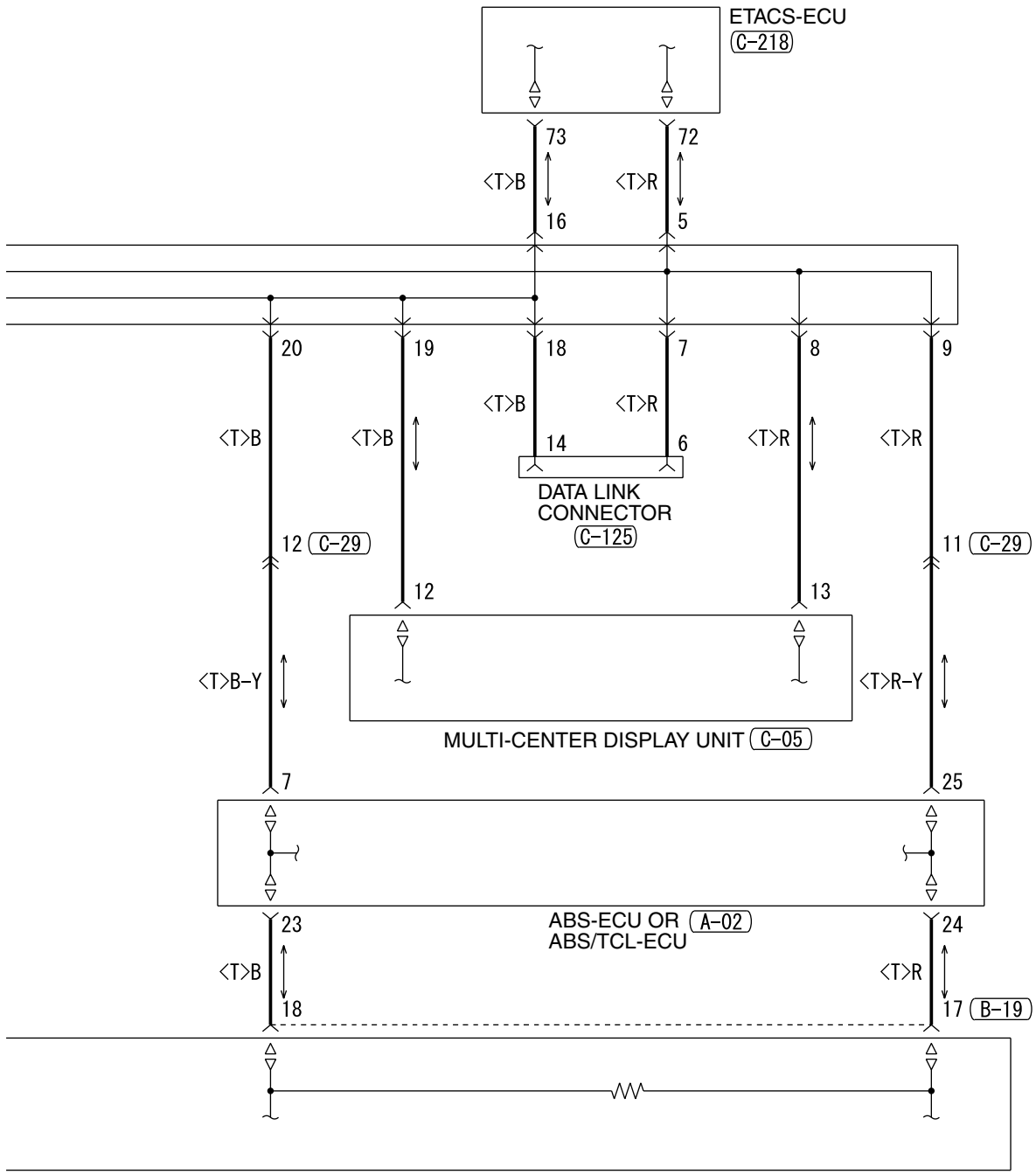

WIRE COLOR CODE  
 B : BLACK LG : LIGHT GREEN G : GREEN L : BLUE W : WHITE Y : YELLOW  
 SB : SKY BLUE BR : BROWN O : ORANGE GR : GRAY R : RED P : PINK V : VIOLET

AUTOMATIC AIR CONDITIONING SYSTEM (CONTINUED)

9

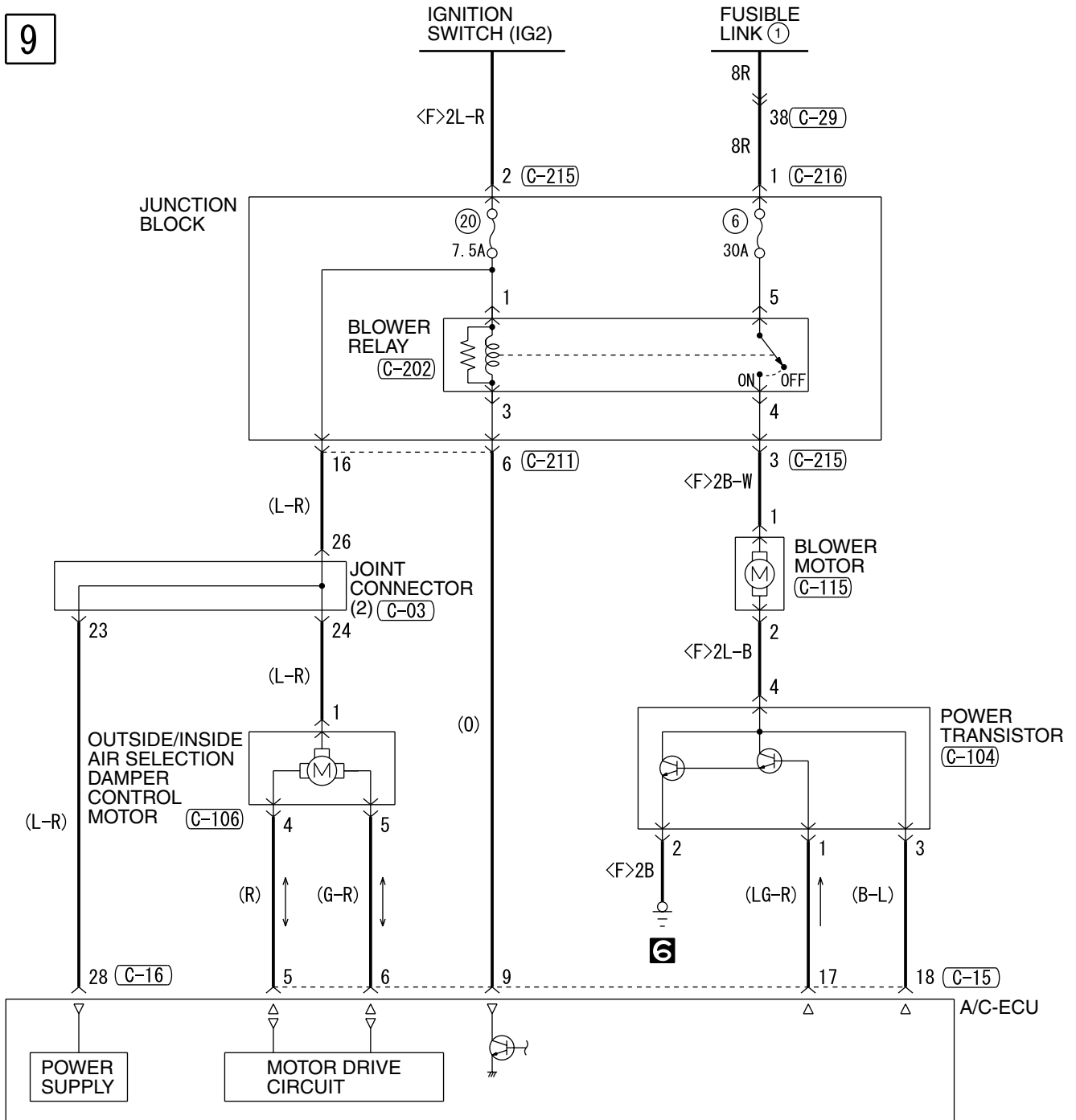

C-03

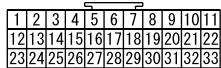

C-15



C-16



C-29

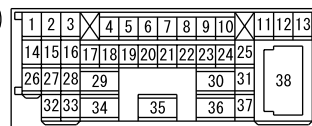

C-104



C-106



C-115



C-202



C-211

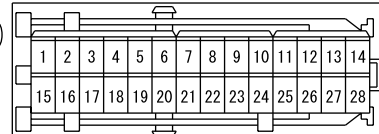

C-215



C-216



NOTES

# WINDSHIELD WIPER AND WASHER

M1901006101051

1

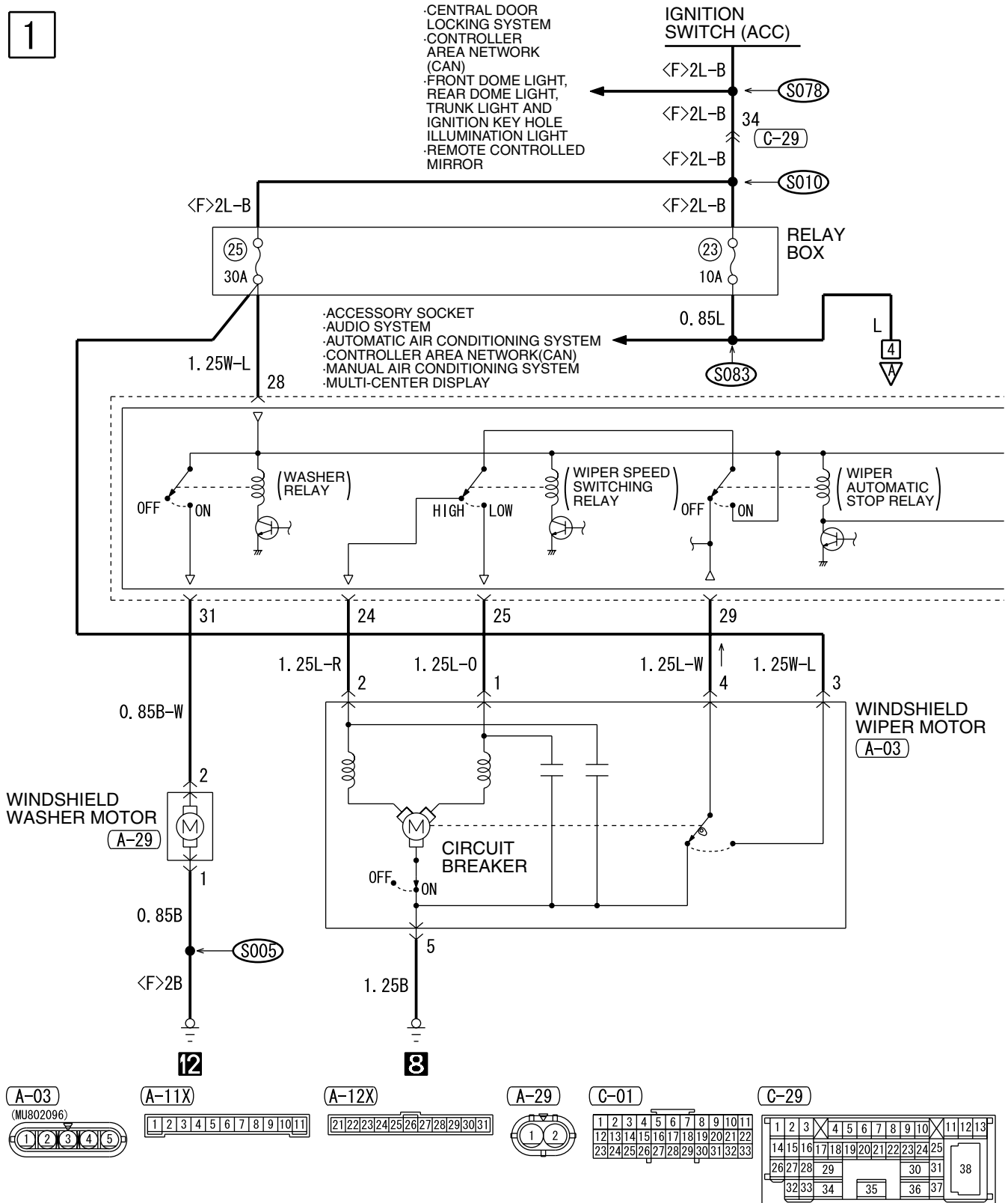

H5P13M00AA

TSB Revision

2

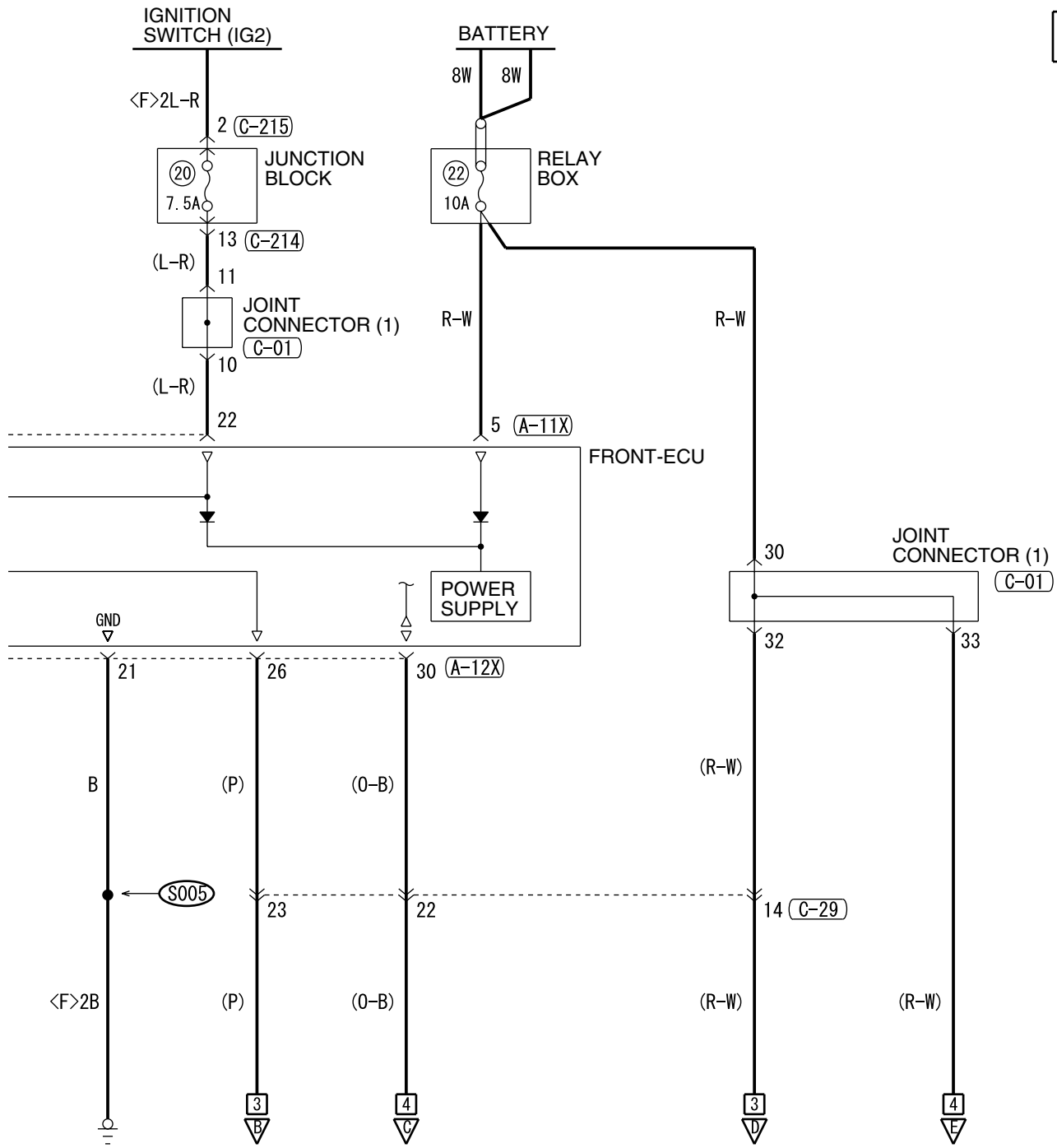

12

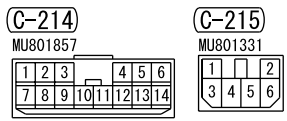

WIRE COLOR CODE  
 B : BLACK LG : LIGHT GREEN G : GREEN L : BLUE  
 BR : BROWN O : ORANGE GR : GRAY R : RED W : WHITE  
 SB : SKY BLUE P : PINK Y : YELLOW V : VIOLET

WINDSHIELD WIPER AND WASHER (CONTINUED)

3

- AUDIO SYSTEM
- AUTO-CRUISE CONTROL SYSTEM
- AUTOMATIC AIR CONDITIONING SYSTEM
- BRAKE WARNING LIGHT, OIL PRESSURE WARNING LIGHT, FUEL WARNING LIGHT
- CENTRAL DOOR LOCKING SYSTEM
- CHARGING SYSTEM
- CONTROLLER AREA NETWORK (CAN)
- DOOR AJAR WARNING TONE ALARM
- ELECTRONIC BRAKE-FORCE DISTRIBUTION (EBD) AND ANTI-LOCK BRAKING SYSTEM (ABS)
- ENGINE IMMOBILIZER SYSTEM
- FRONT DOME LIGHT, REAR DOME LIGHT, TRUNK LIGHT AND IGNITION KEY HOLE ILLUMINATION LIGHT
- INVECS-II 4A/T
- MANUAL AIR CONDITIONING SYSTEM
- METER AND GAUGE
- MFI SYSTEM
- MULTI-CENTER DISPLAY
- SEAT BELT WARNING TONE ALARM
- SUPPLEMENTAL RESTRAINT SYSTEM (SRS)
- VANITY MIRROR LIGHT

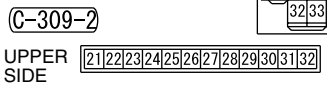
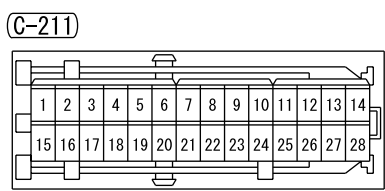
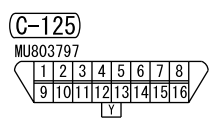
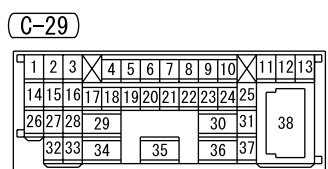
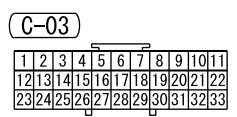
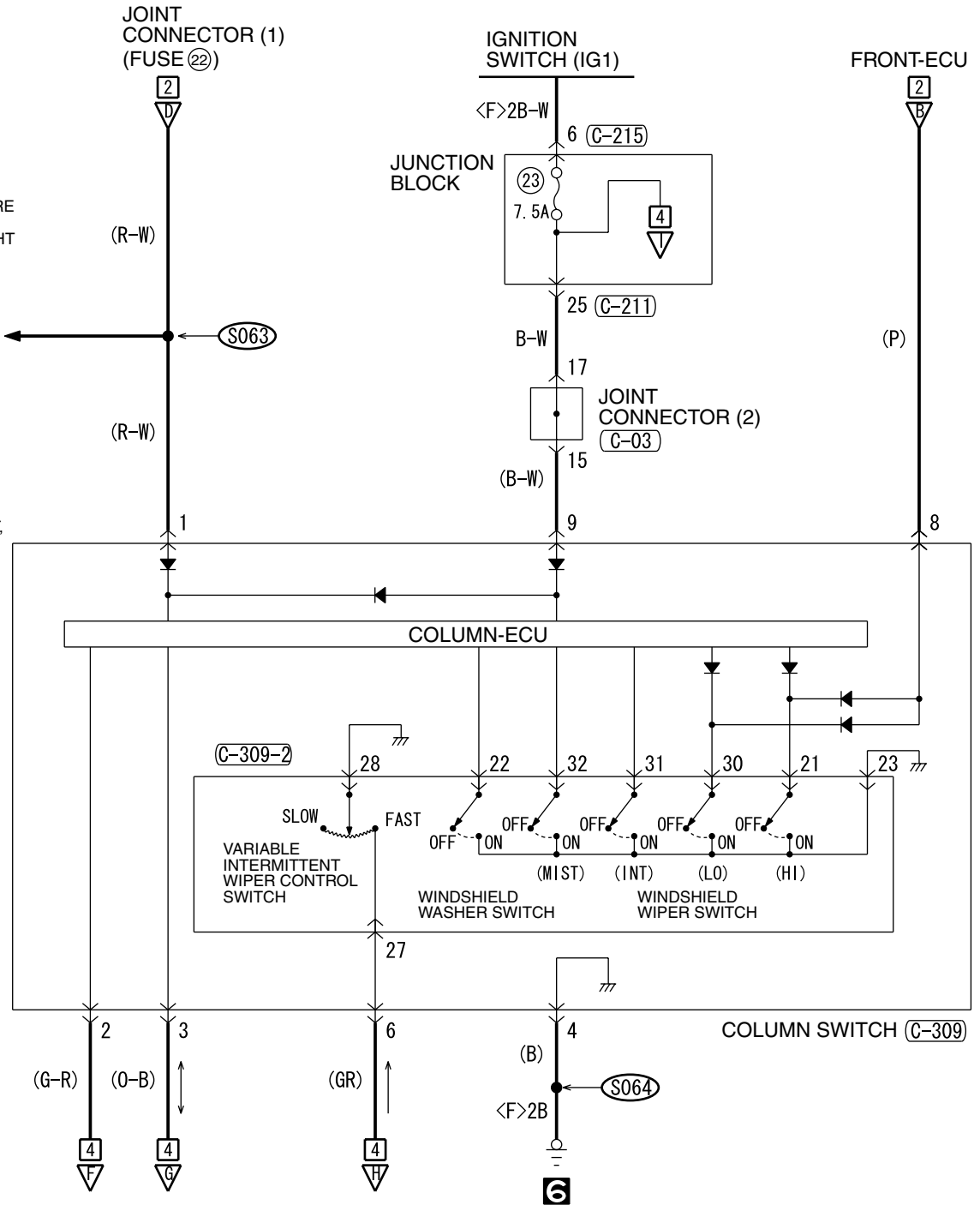



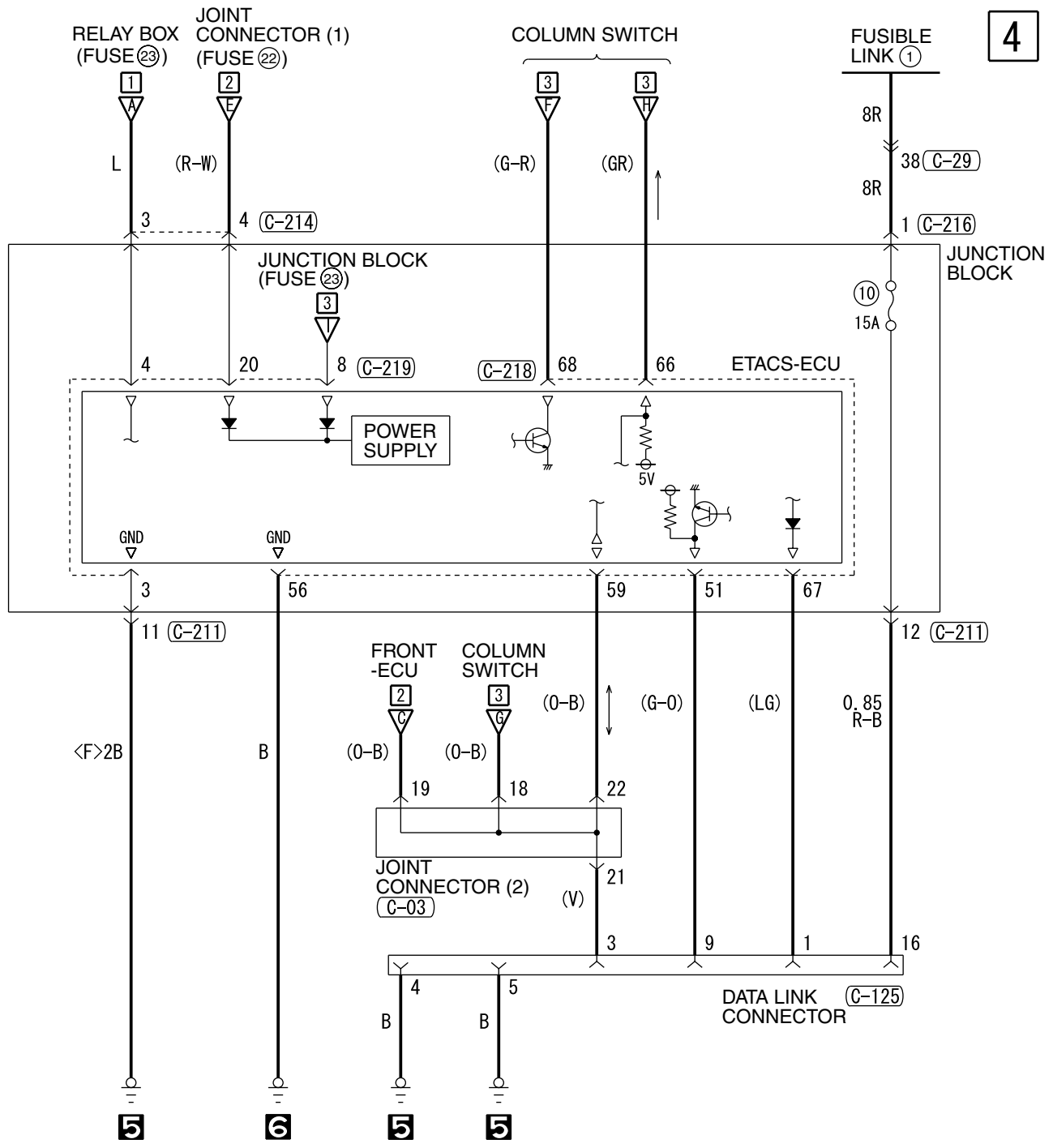

(C-214) MU801857

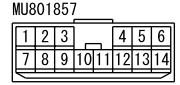

(C-215) MU801331



(C-216) MU801403



(C-218) (MU803766)

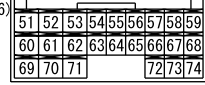

(C-219)

JUNCTION BLOCK SIDE

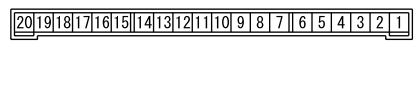

(C-309) (MU801514)

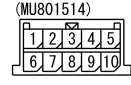

WIRE COLOR CODE

B: BLACK LG: LIGHT GREEN G: GREEN L: BLUE W: WHITE Y: YELLOW  
SB: SKY BLUE BR: BROWN O: ORANGE GR: GRAY R: RED P: PINK V: VIOLET

WINDSHIELD WIPER AND WASHER (CONTINUED)

5

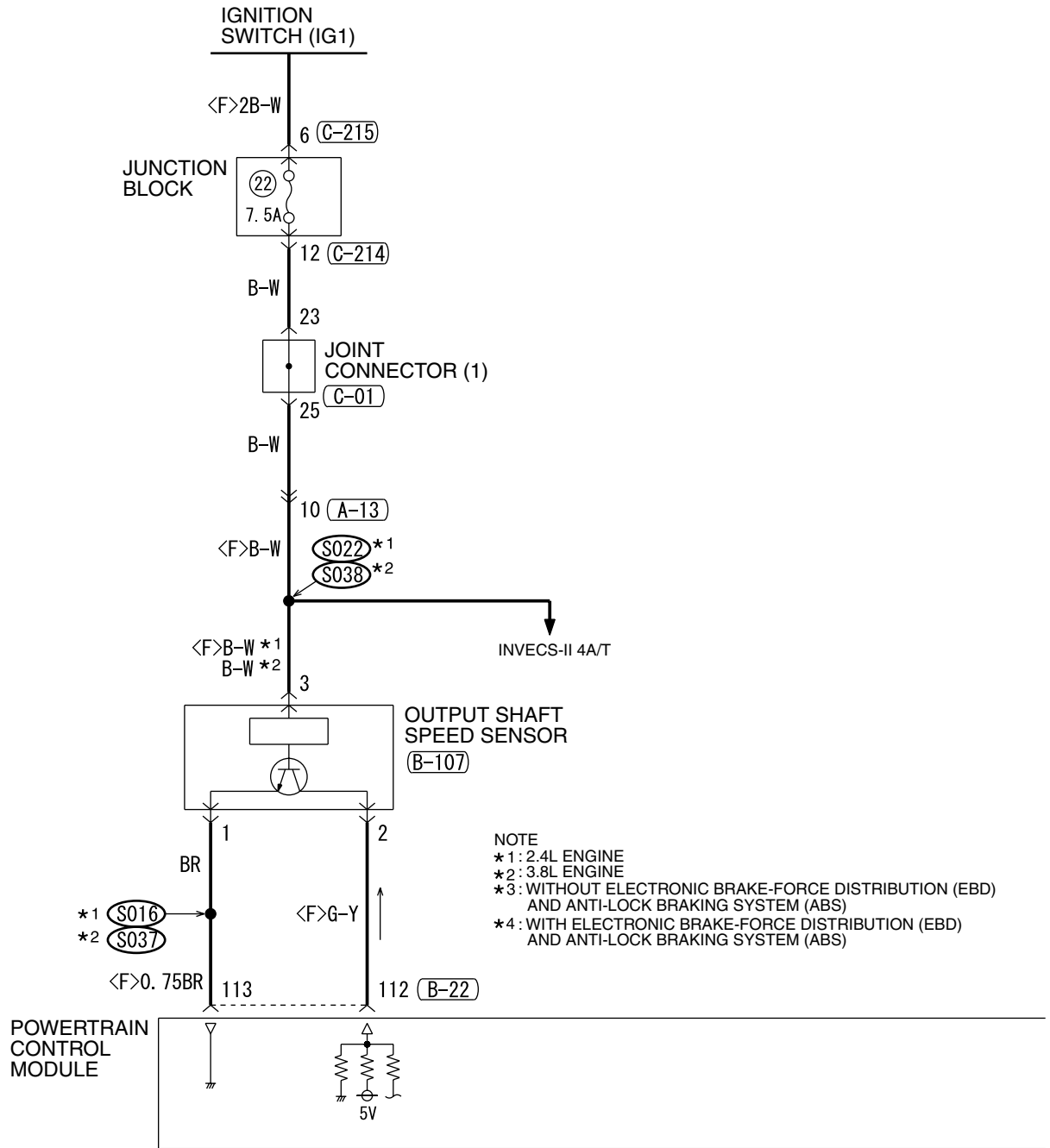

(A-02)

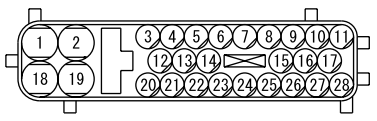

(A-13)

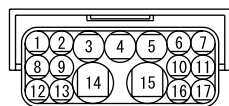

(B-19)

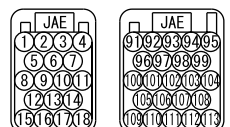

(B-22)

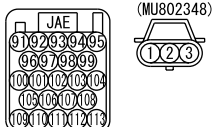

(B-107)



(C-01)

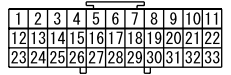

(C-218)

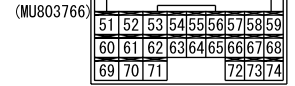

6

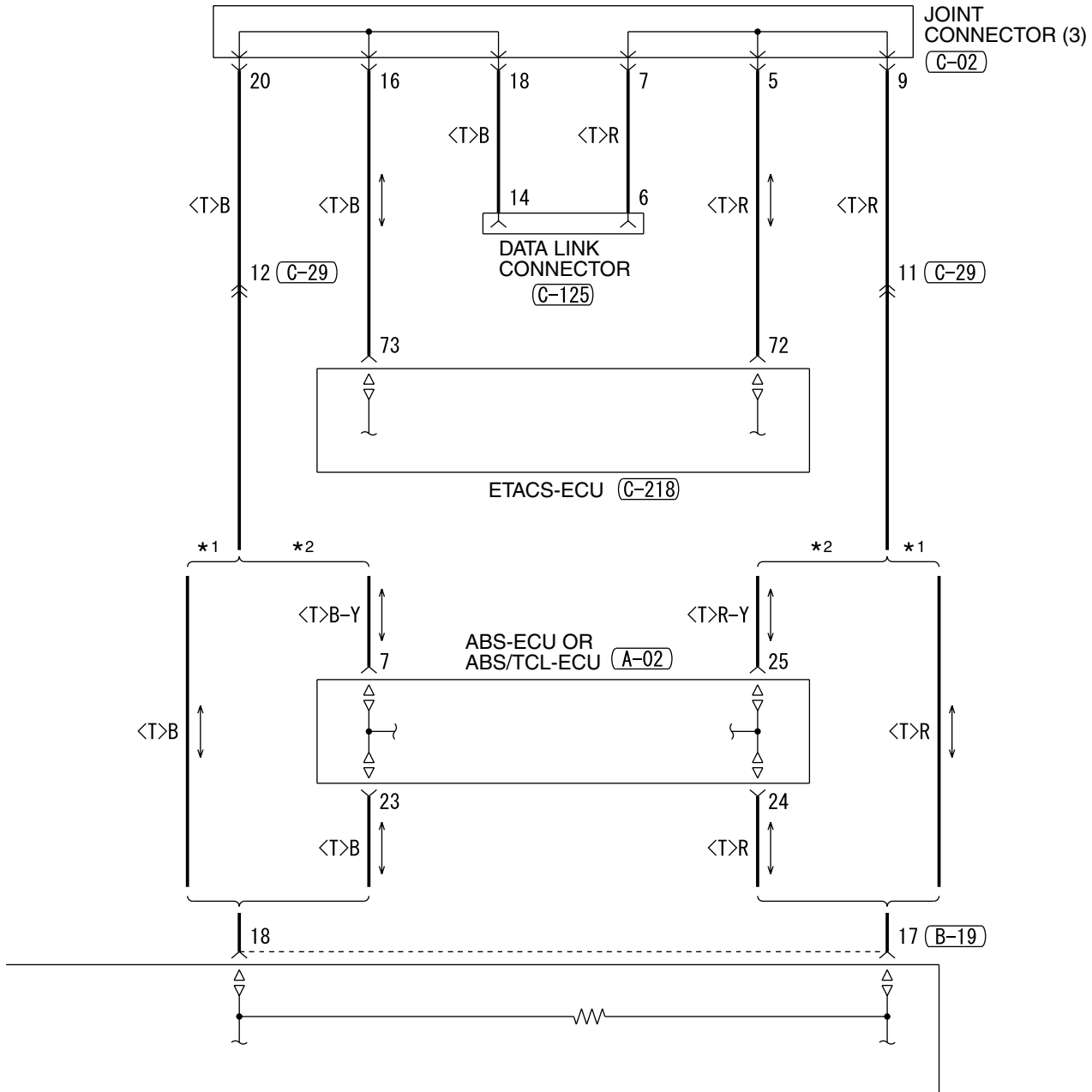

(C-02)

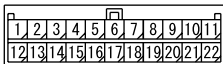

(C-29)

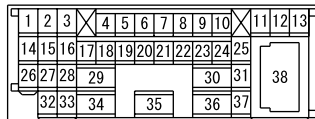

(C-125)

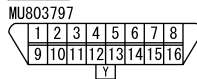

(C-214)

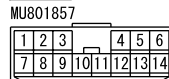

(C-215)



WIRE COLOR CODE

B: BLACK LG: LIGHT GREEN G: GREEN L: BLUE W: WHITE Y: YELLOW  
SB: SKY BLUE BR: BROWN O: ORANGE GR: GRAY R: RED P: PINK V: VIOLET

H5P13M00CB

TSB Revision

# REAR WINDOW DEFOGGER AND DOOR MIRROR HEATER

M1901019400082

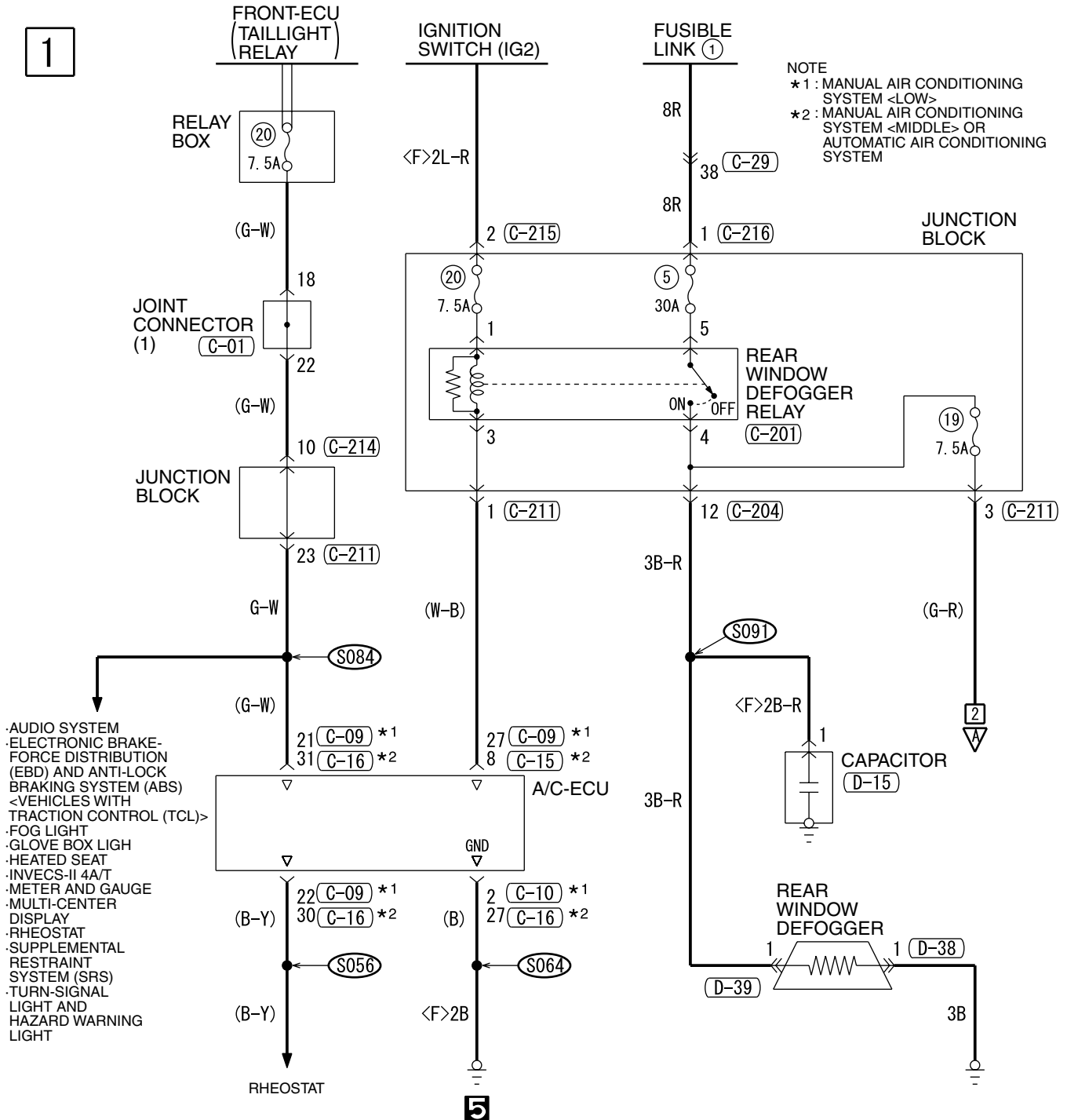

(C-01)



(C-09)

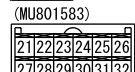

(C-10)

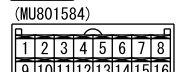

(C-12)

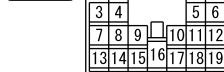

(C-15)

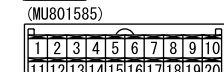

(C-16)

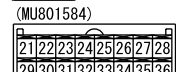

(C-214)

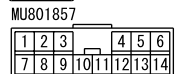

(C-215)



(C-216)



(D-15)



(D-38)



(D-39)



(E-01)



(E-09)



2

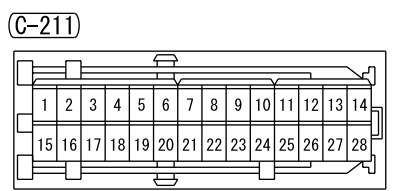
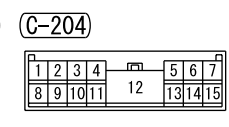
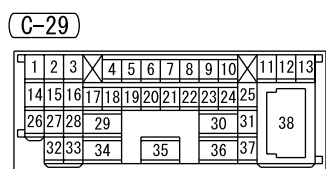
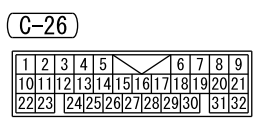
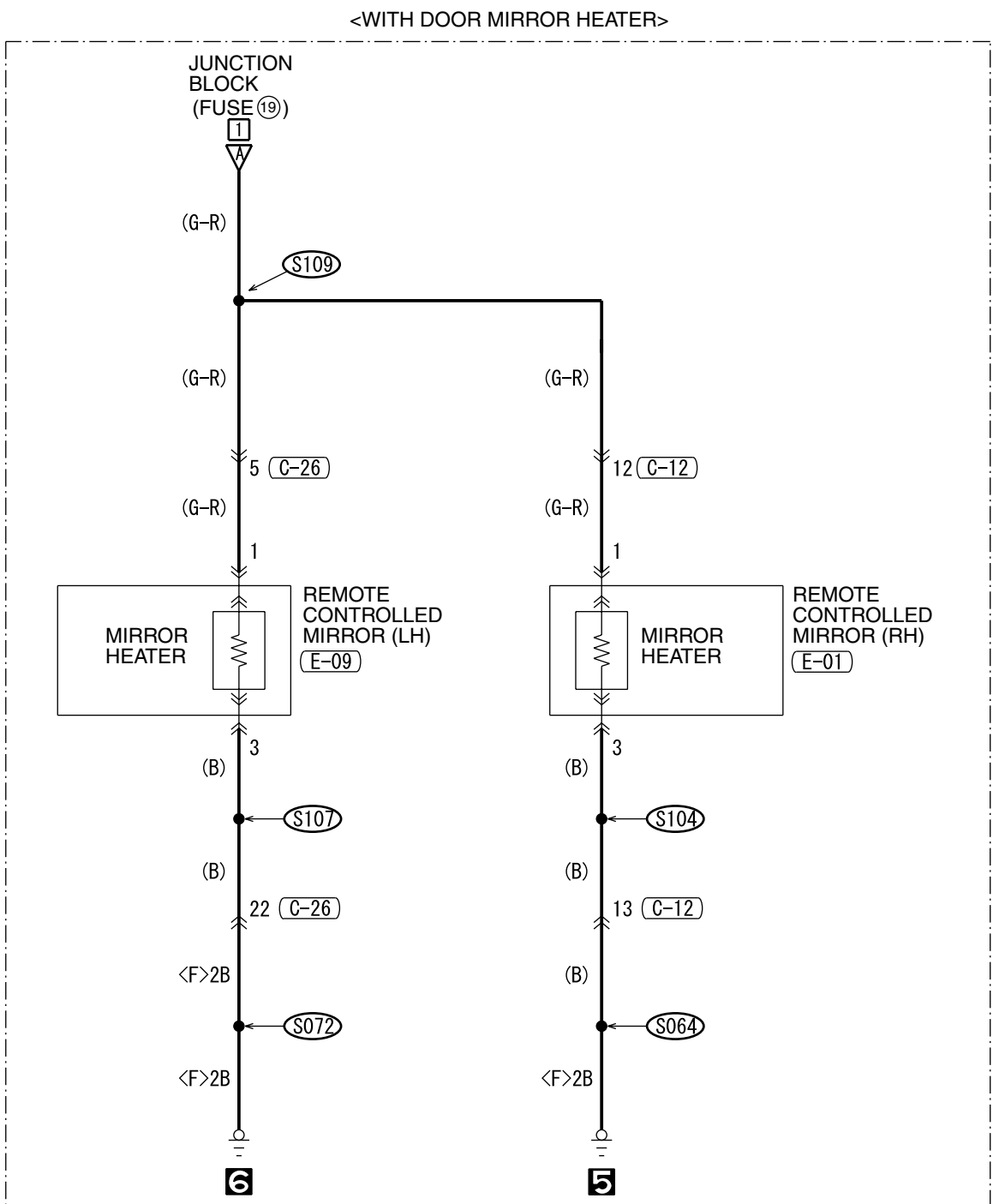

WINDSHIELD WIPER AND WASHER (CONTINUED)

3

<WITH MULTI-CENTER DISPLAY (MIDDLE) >

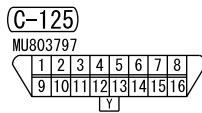
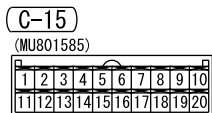
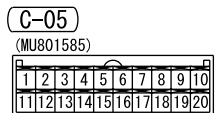
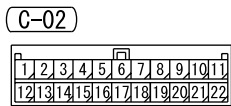
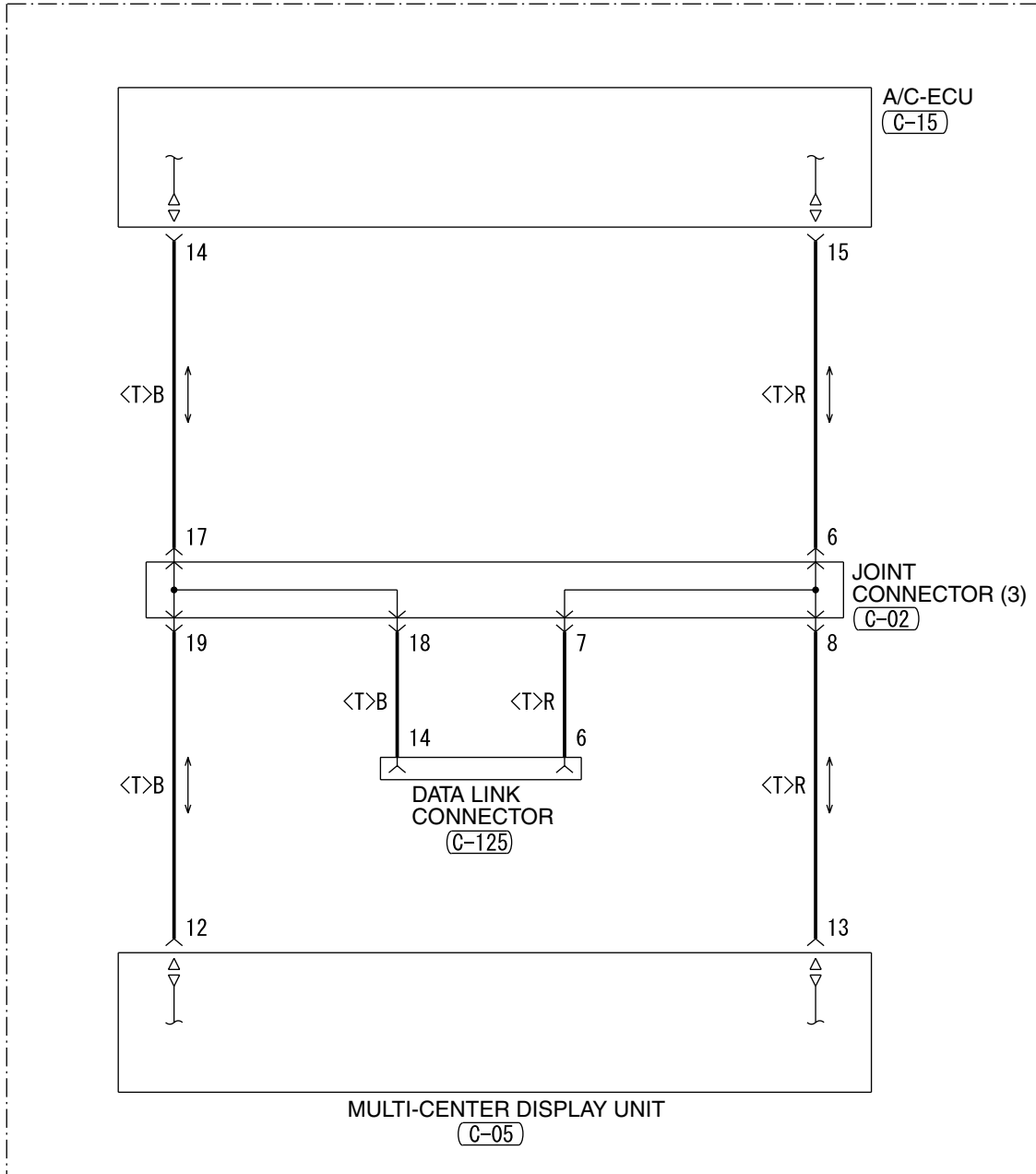

WIRE COLOR CODE  
 B : BLACK LG : LIGHT GREEN G : GREEN L : BLUE W : WHITE Y : YELLOW  
 SB : SKY BLUE BR : BROWN O : ORANGE GR : GRAY R : RED P : PINK V : VIOLET

H5P13M01BA

# REMOTE CONTROLLED MIRROR

1

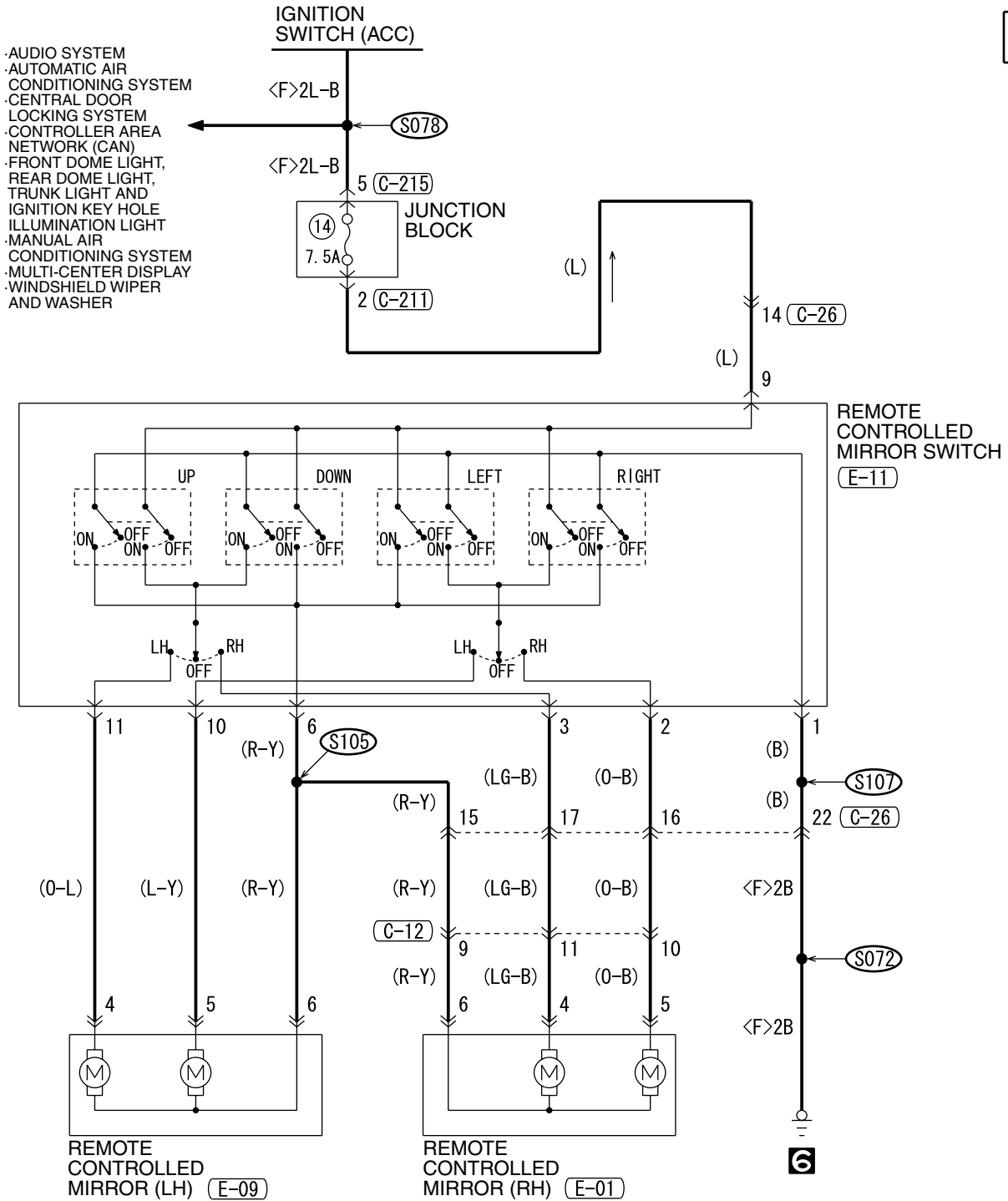

(C-12)

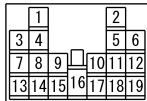

(C-26)

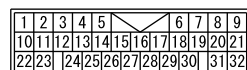

(C-211)

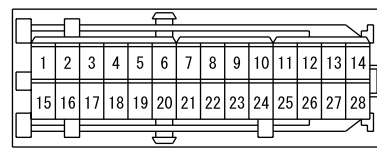

(C-215)



(E-01)

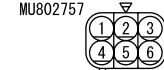

(E-09)



(E-11)



MU801847

MU801331

MU802757

MU802757

# AUDIO SYSTEM <VEHICLES WITHOUT AUDIO AMPLIFIER>

M1901015601388

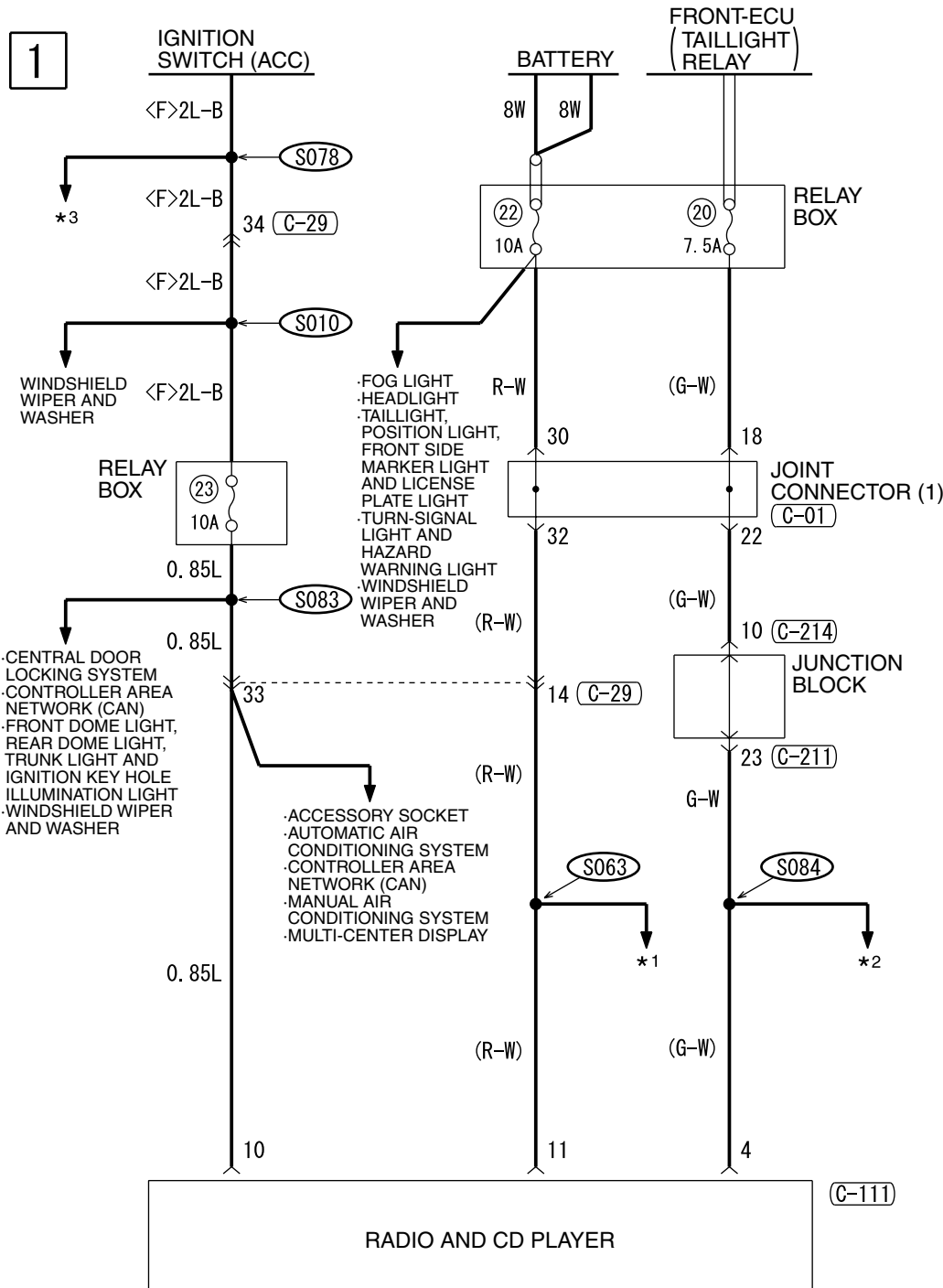

**NOTE**

- \*1: -AUTO-CRUISE CONTROL SYSTEM
- AUTOMATIC AIR CONDITIONING SYSTEM
- BRAKE WARNING LIGHT, OIL PRESSURE WARNING LIGHT, FUEL WARNING LIGHT
- CENTRAL DOOR LOCKING SYSTEM
- CHARGING SYSTEM
- CONTROLLER AREA NETWORK (CAN)
- DOOR AJAR WARNING TONE ALARM
- ELECTRONIC BRAKE-FORCE DISTRIBUTION (EBD) AND ANTI-LOCK BRAKING SYSTEM (ABS)
- ENGINE IMMOBILIZER SYSTEM
- FOG LIGHT
- FRONT DOME LIGHT, REAR DOME LIGHT, TRUNK LIGHT AND IGNITION KEY HOLE ILLUMINATION LIGHT
- HEADLIGHT
- INVECS-II 4A/T
- LIGHTING MONITOR
- TONE ALARM
- MANUAL AIR CONDITIONING SYSTEM
- METER AND GAUGE
- MFI SYSTEM
- MULTI-CENTER DISPLAY
- SEAT BELT WARNING TONE ALARM
- SUPPLEMENTAL RESTRAINT SYSTEM (SRS)
- TAILLIGHT, POSITION LIGHT, FRONT SIDE MARKER LIGHT AND LICENSE PLATE LIGHT
- TURN-SIGNAL LIGHT AND HAZARD WARNING LIGHT
- VANITY MIRROR LIGHT
- WINDSHIELD WIPER AND WASHER

C-01

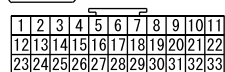

C-12

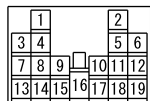

C-13

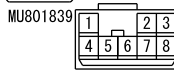

C-26

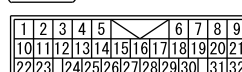

C-28

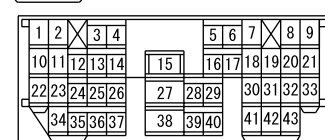

C-214

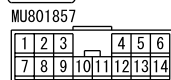

D-09



D-12



E-02



E-10





**2**

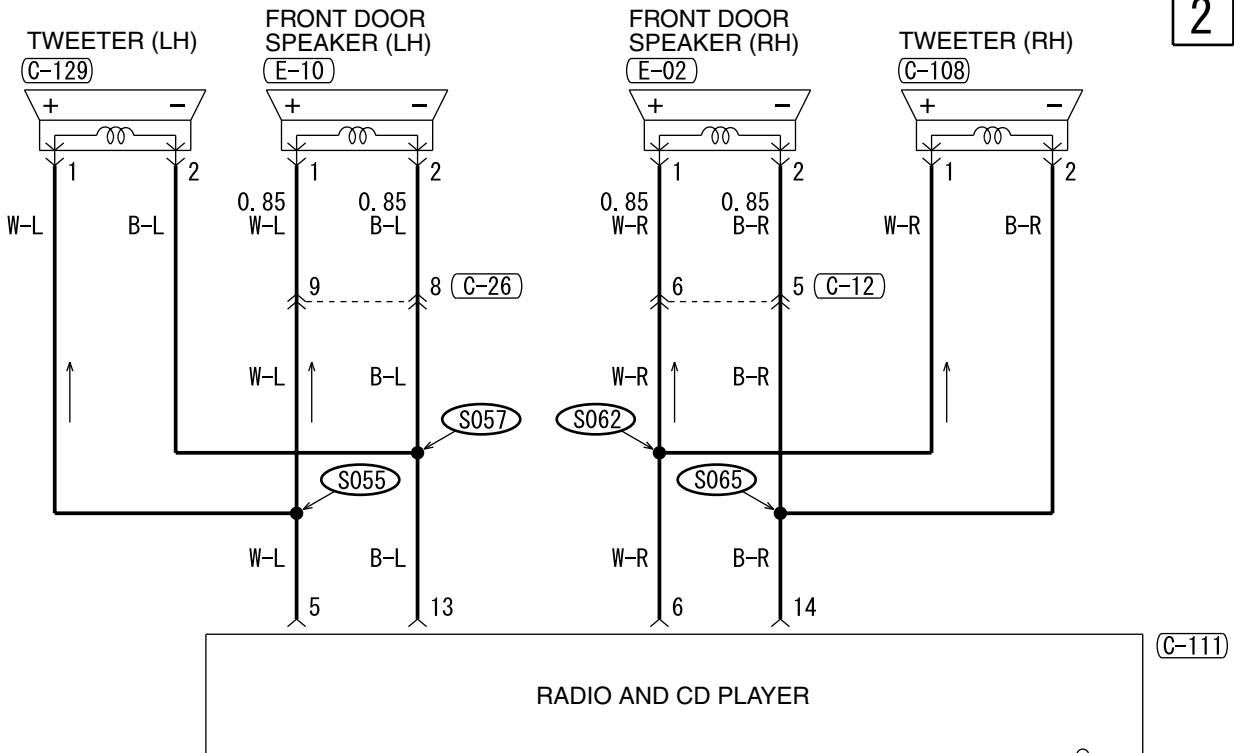

- NOTE**  
 \*2: .AUTOMATIC AIR CONDITIONING SYSTEM  
 .ELECTRONIC BRAKE-FORCE DISTRIBUTION (EBD) AND ANTI-LOCK BRAKING SYSTEM (ABS)  
 <VEHICLES WITH TRACTION CONTROL (TCL)>  
 .FOG LIGHT  
 .GLOVE BOX LIGHT  
 .HEATED SEAT  
 .INVECS-II 4A/T  
 .MANUAL AIR CONDITIONING SYSTEM  
 .METER AND GAUGE  
 .MULTI-CENTER DISPLAY  
 .REAR WINDOW DEFOGGER AND DOOR MIRROR HEATER  
 .RHEOSTAT  
 .SUPPLEMENTAL RESTRAINT SYSTEM (SRS)  
 .TURN-SIGNAL LIGHT AND HAZARD WARNING LIGHT

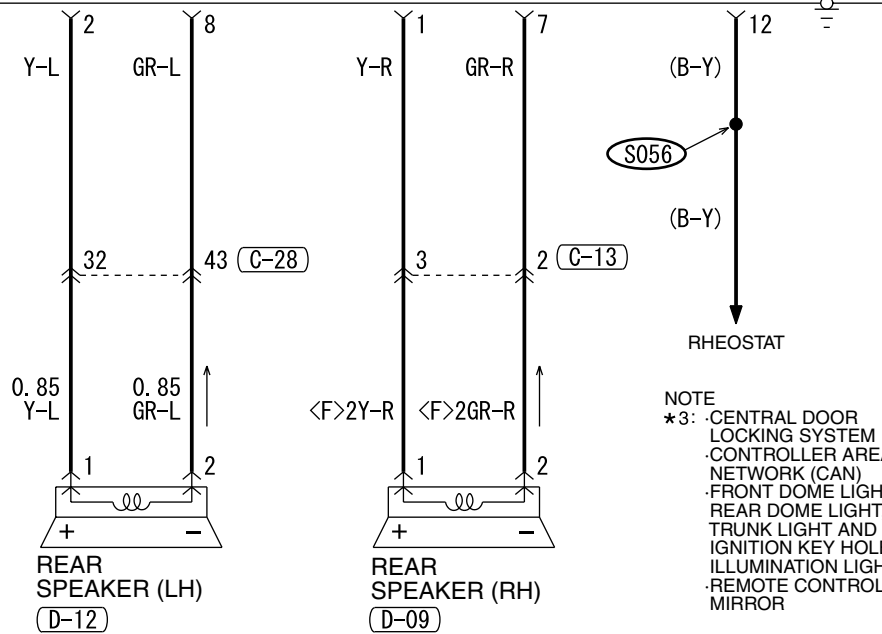

- NOTE**  
 \*3: .CENTRAL DOOR LOCKING SYSTEM  
 .CONTROLLER AREA NETWORK (CAN)  
 .FRONT DOME LIGHT, REAR DOME LIGHT, TRUNK LIGHT AND IGNITION KEY HOLE ILLUMINATION LIGHT  
 .REMOTE CONTROLLED MIRROR

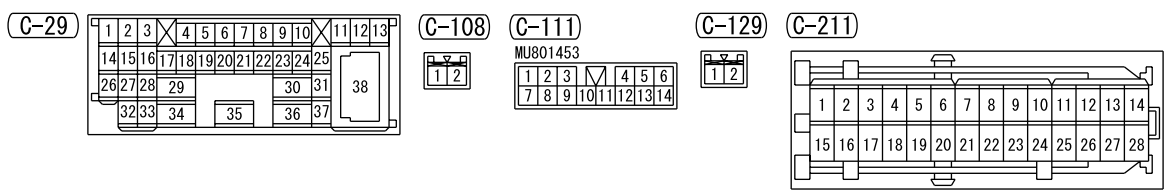

AUDIO SYSTEM <VEHICLES WITHOUT AUDIO AMPLIFIER> (CONTINUED)

3

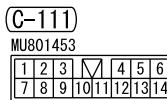
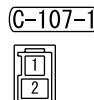
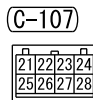
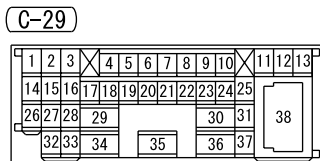
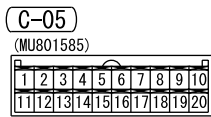
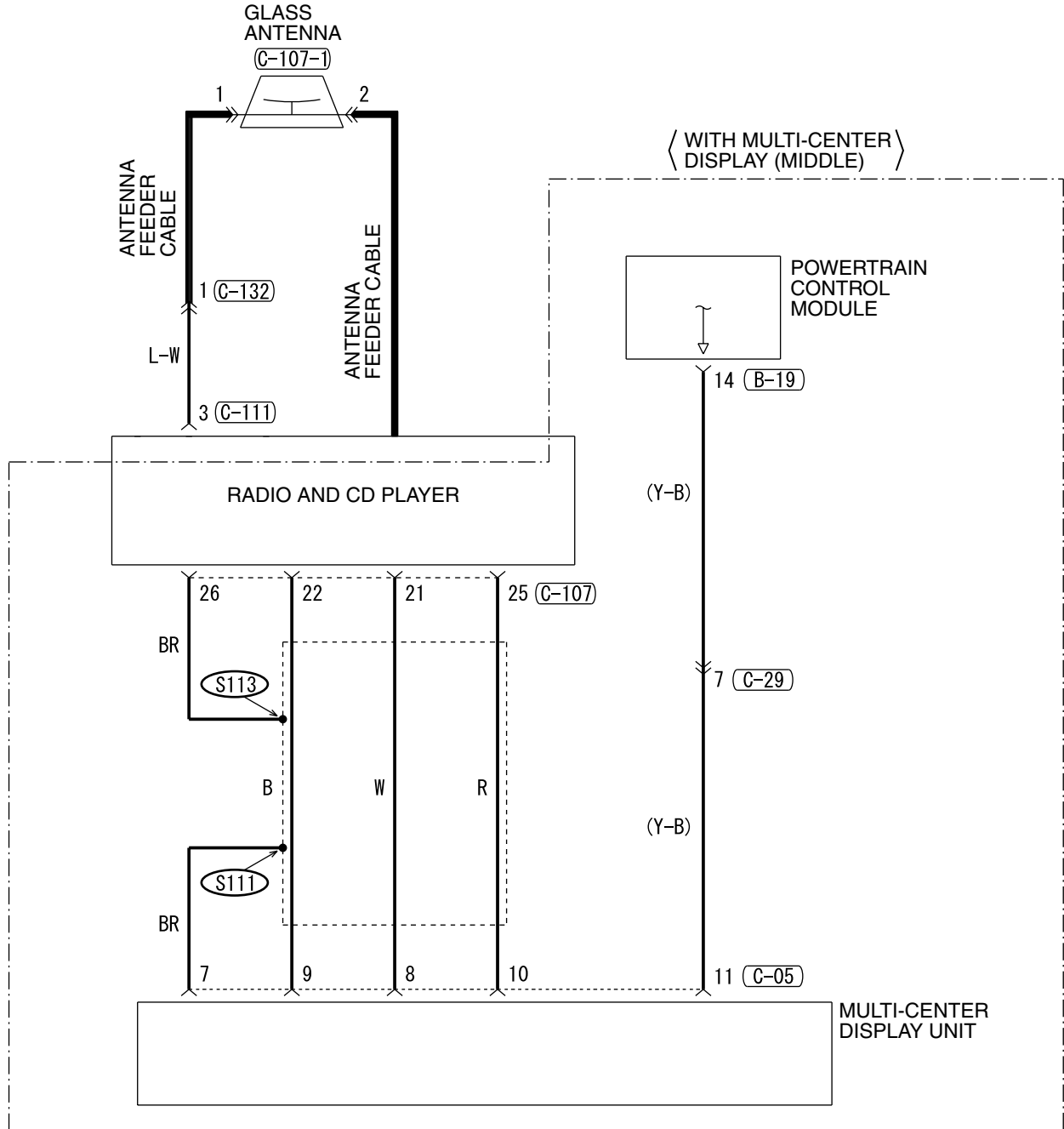

WIRE COLOR CODE

B : BLACK    LG : LIGHT GREEN    G : GREEN    L : BLUE    W : WHITE    Y : YELLOW  
SB : SKY BLUE    BR : BROWN    O : ORANGE    GR : GRAY    R : RED    P : PINK    V : VIOLET    H5P14M00BA

NOTES

**AUDIO SYSTEM <VEHICLES WITH AUDIO AMPLIFIER>**

M1901015601399

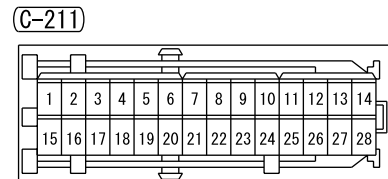
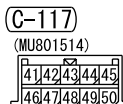
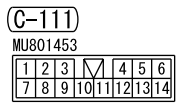
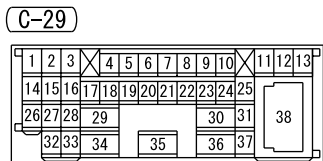
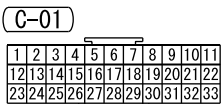
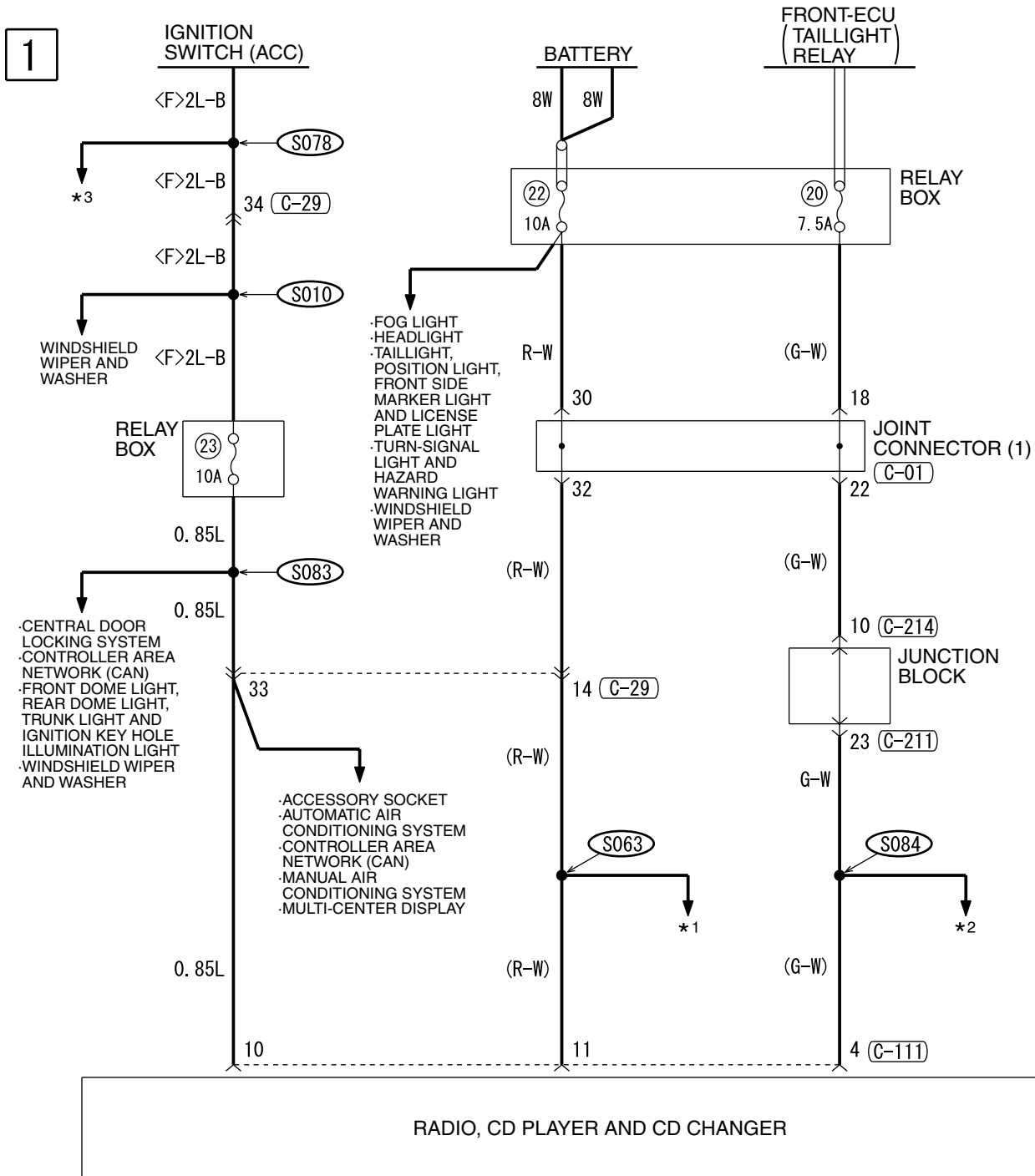

H5P14M01AA

NOTE

- \*1
- AUTO-CRUISE CONTROL SYSTEM
  - AUTOMATIC AIR CONDITIONING SYSTEM
  - BRAKE WARNING LIGHT, OIL PRESSURE WARNING LIGHT, FUEL WARNING LIGHT
  - CENTRAL DOOR LOCKING SYSTEM
  - CHARGING SYSTEM
  - CONTROLLER AREA NETWORK (CAN)
  - DOOR AJAR WARNING TONE ALARM
  - ELECTRONIC BRAKE-FORCE DISTRIBUTION (EBD) AND ANTI-LOCK BRAKING SYSTEM (ABS)
  - ENGINE IMMOBILIZER SYSTEM
  - FOG LIGHT
  - FRONT DOME LIGHT, REAR DOME LIGHT, TRUNK LIGHT AND IGNITION KEY HOLE ILLUMINATION LIGHT
  - HEADLIGHT
  - INVECS-II 4A/T
  - LIGHTING MONITOR TONE ALARM
  - MANUAL AIR CONDITIONING SYSTEM
  - METER AND GAUGE
  - MFI SYSTEM
  - MULTI-CENTER DISPLAY
  - SEAT BELT WARNING TONE ALARM
  - SUPPLEMENTAL RESTRAINT SYSTEM (SRS)
  - TAILLIGHT, POSITION LIGHT, FRONT SIDE MARKER LIGHT AND LICENSE PLATE LIGHT
  - TURN-SIGNAL LIGHT AND HAZARD WARNING LIGHT
  - VANITY MIRROR LIGHT
  - WINDSHIELD WIPER AND WASHER

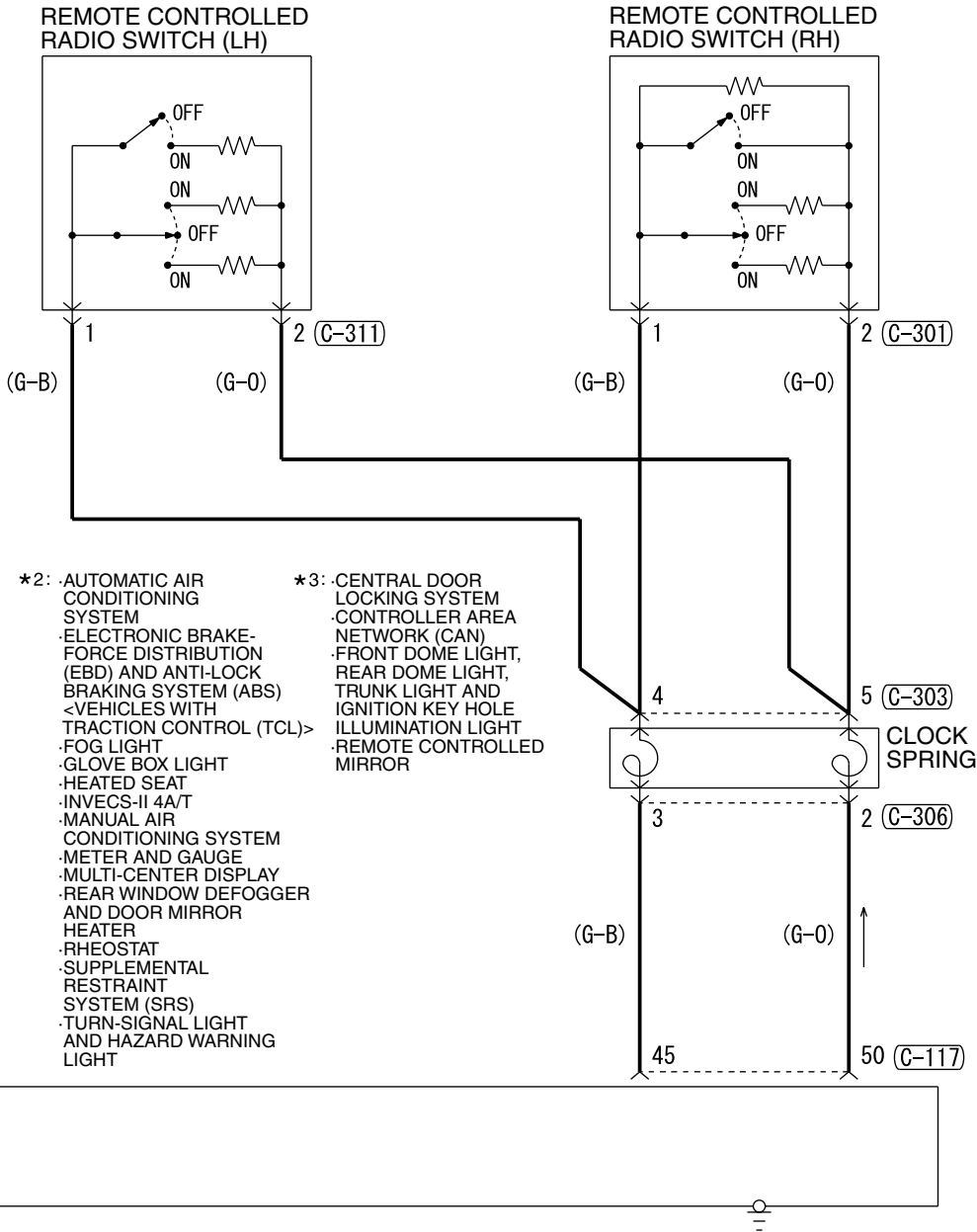

- \*2:
- AUTOMATIC AIR CONDITIONING SYSTEM
  - ELECTRONIC BRAKE-FORCE DISTRIBUTION (EBD) AND ANTI-LOCK BRAKING SYSTEM (ABS) <VEHICLES WITH TRACTION CONTROL (TCL)>
  - FOG LIGHT
  - GLOVE BOX LIGHT
  - HEATED SEAT
  - INVECS-II 4A/T
  - MANUAL AIR CONDITIONING SYSTEM
  - METER AND GAUGE
  - MULTI-CENTER DISPLAY
  - REAR WINDOW DEFOGGER AND DOOR MIRROR HEATER
  - RHEOSTAT
  - SUPPLEMENTAL RESTRAINT SYSTEM (SRS)
  - TURN-SIGNAL LIGHT AND HAZARD WARNING LIGHT

- \*3:
- CENTRAL DOOR LOCKING SYSTEM
  - CONTROLLER AREA NETWORK (CAN)
  - FRONT DOME LIGHT, REAR DOME LIGHT, TRUNK LIGHT AND IGNITION KEY HOLE ILLUMINATION LIGHT
  - REMOTE CONTROLLED MIRROR

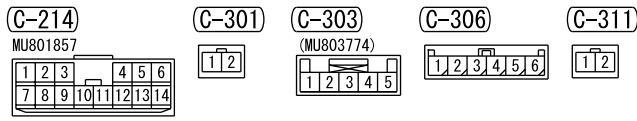

WIRE COLOR CODE  
 B : BLACK LG : LIGHT GREEN G : GREEN L : BLUE  
 BR : BROWN O : ORANGE GR : GRAY R : RED W : WHITE  
 SB : SKY BLUE P : PINK Y : YELLOW V : VIOLET

AUDIO SYSTEM <VEHICLES WITH AUDIO AMPLIFIER> (CONTINUED)

3

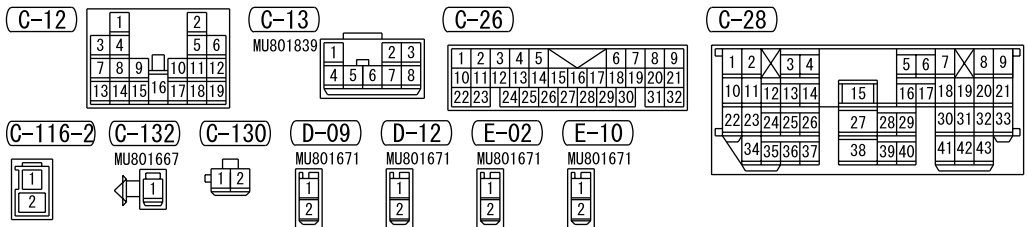
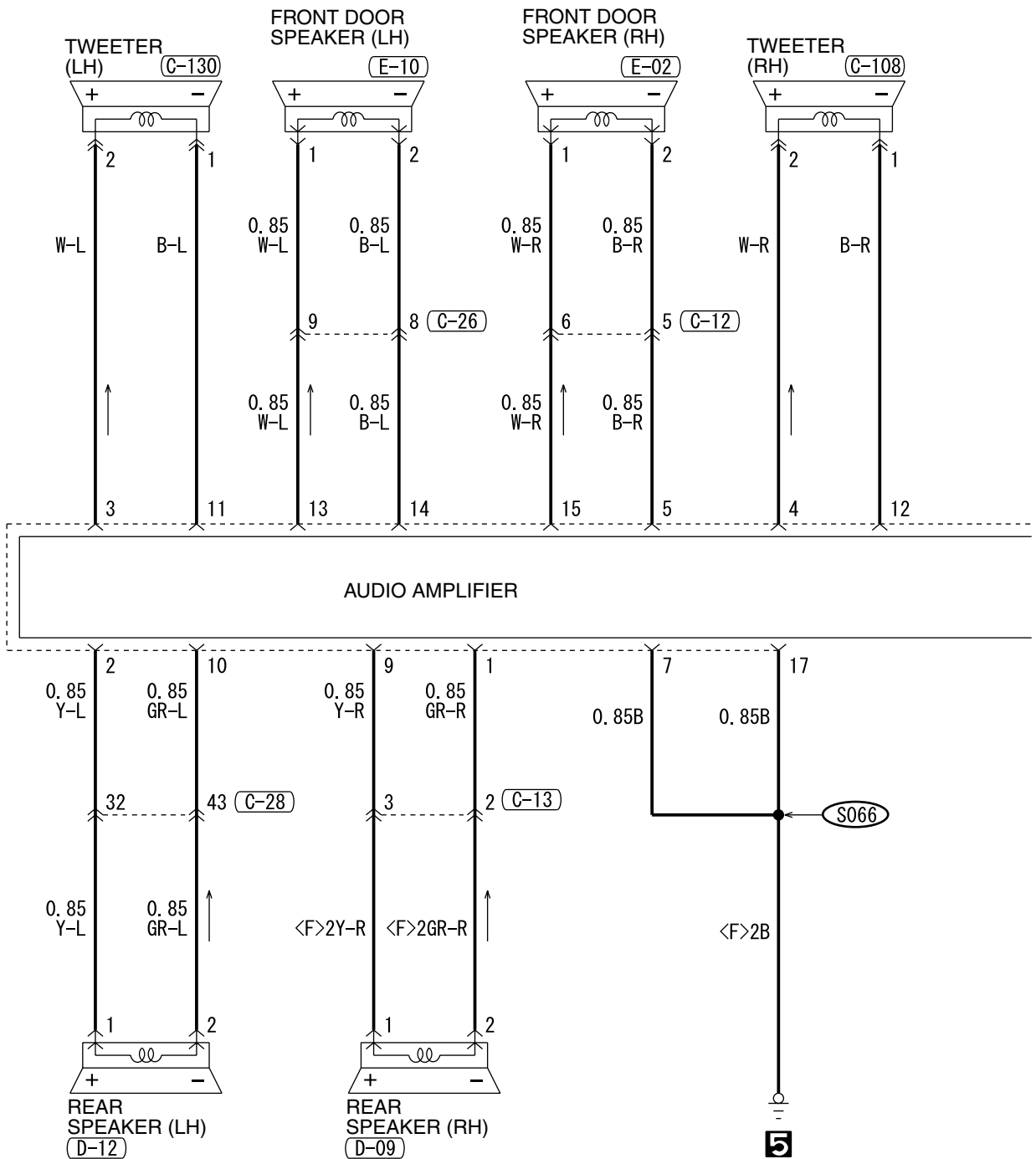

4

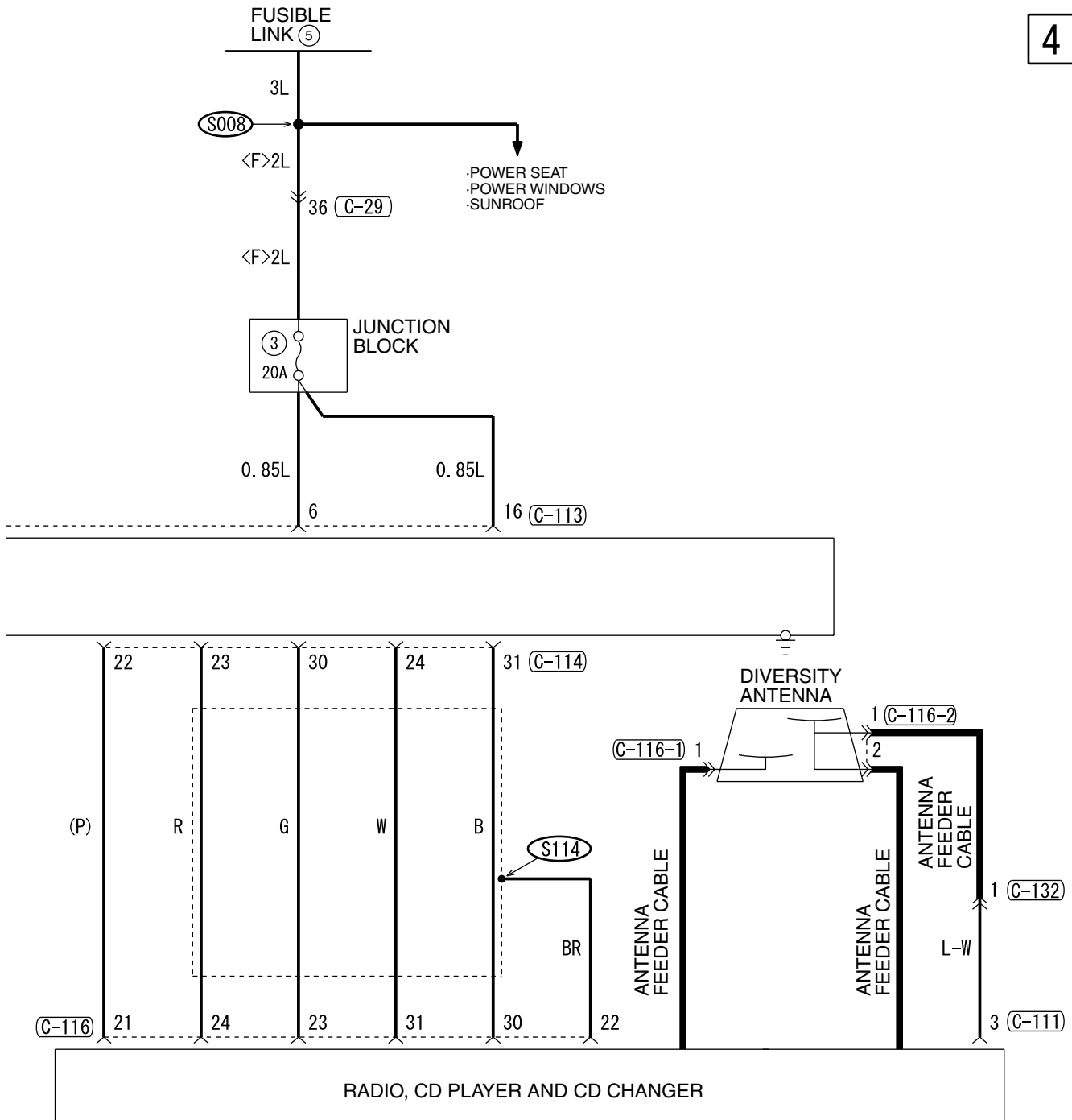

(C-29)

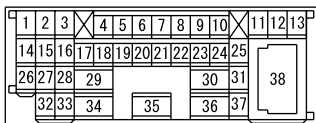

(C-108)



(C-111)

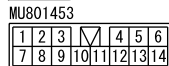

(C-113)

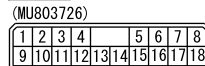

(C-114)

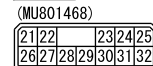

(C-116)

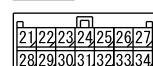

(C-116-1)



WIRE COLOR CODE

B : BLACK LG : LIGHT GREEN G : GREEN L : BLUE  
BR : BROWN O : ORANGE GR : GRAY R : RED W : WHITE  
SB : SKY BLUE P : PINK Y : YELLOW V : VIOLET

AUDIO SYSTEM <VEHICLES WITH AUDIO AMPLIFIER> (CONTINUED)

5

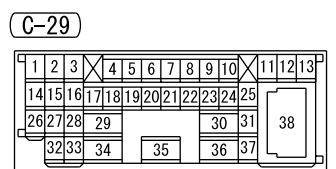
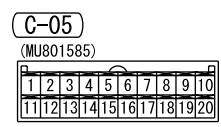
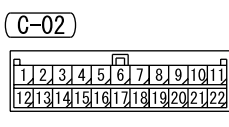
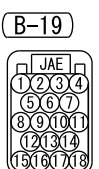
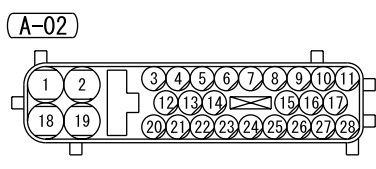
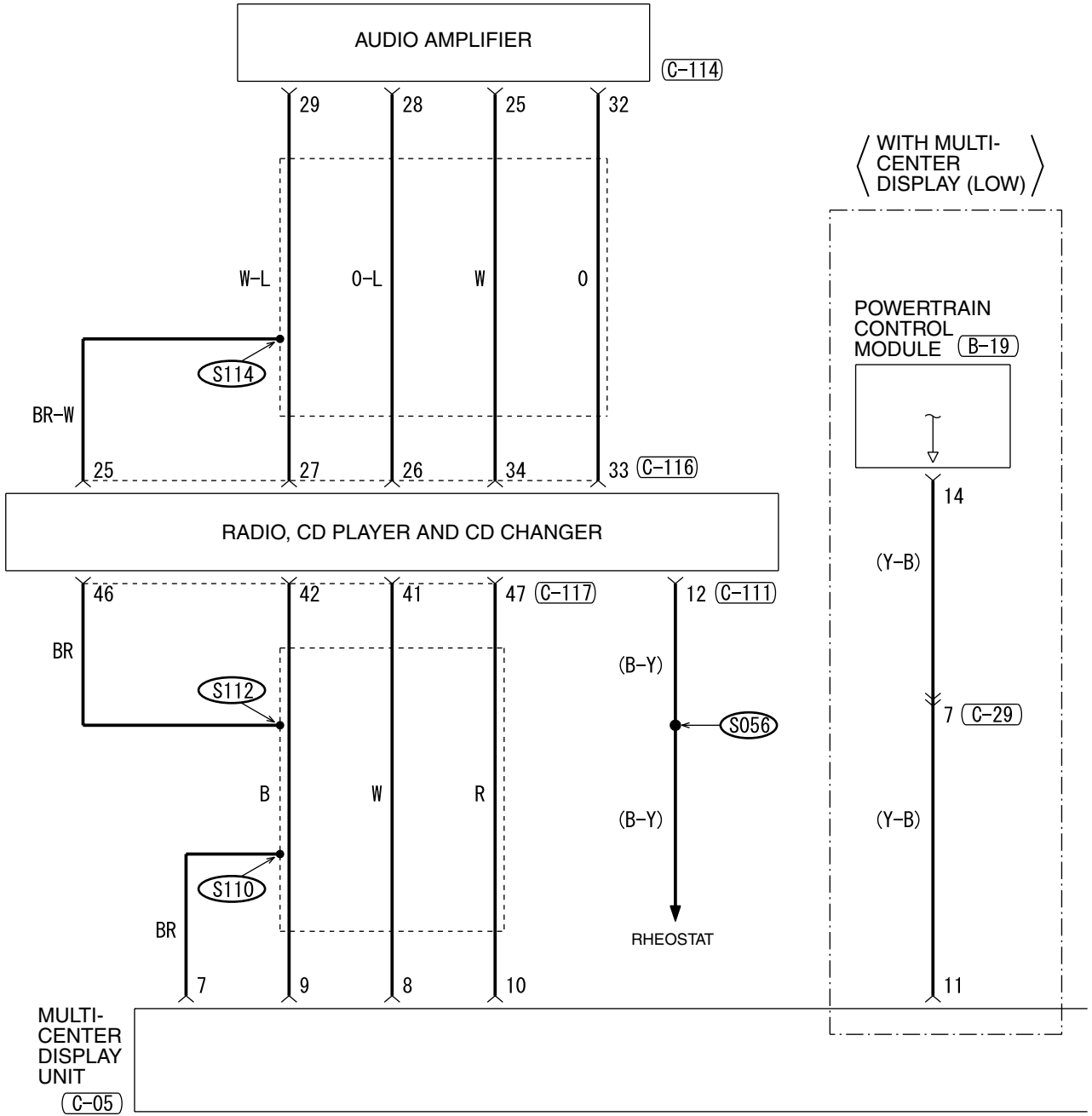



6

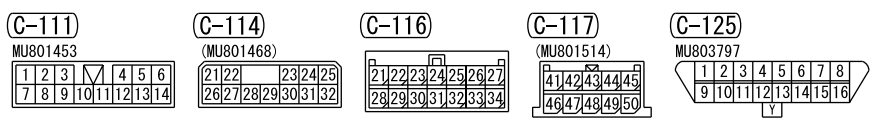
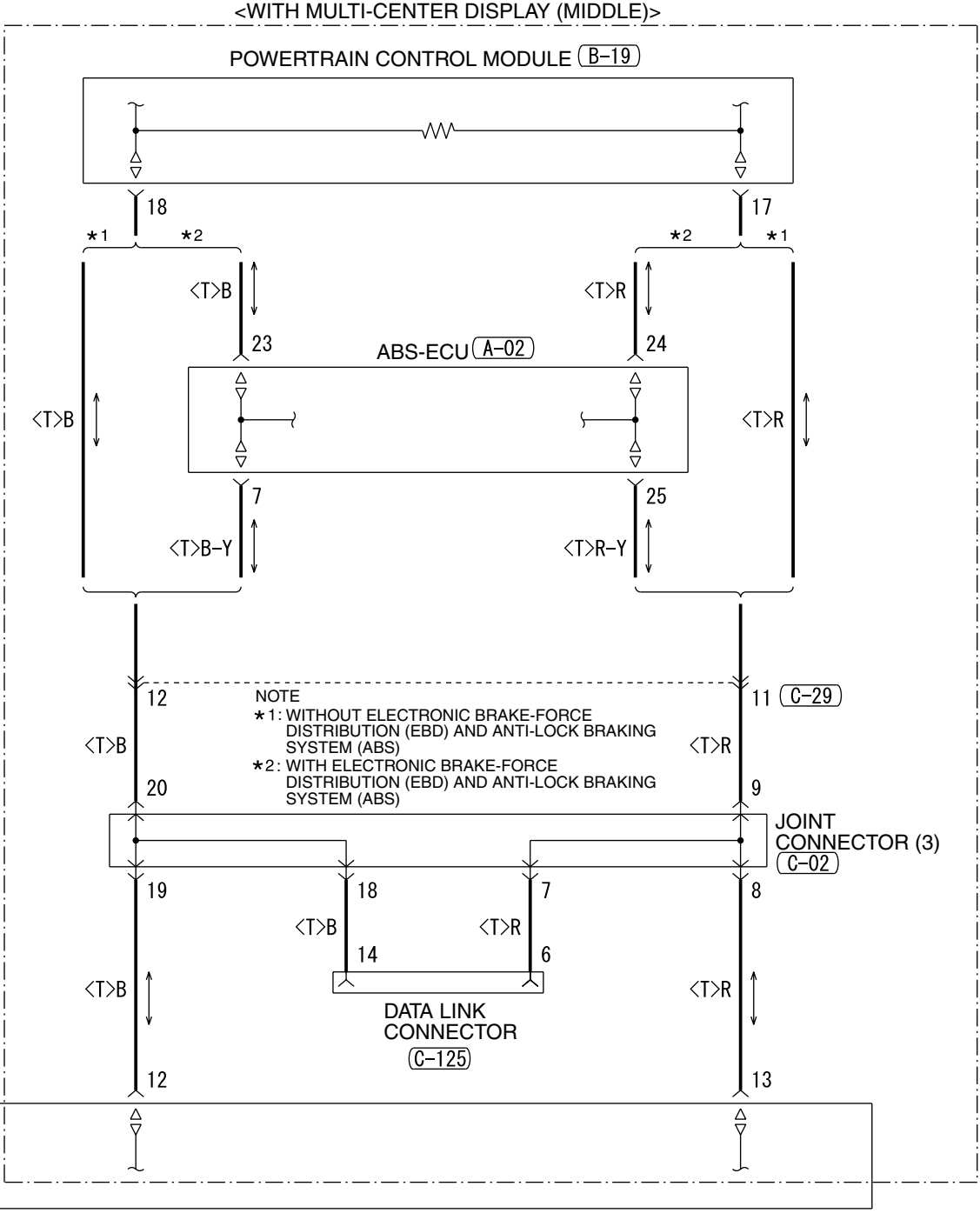

WIRE COLOR CODE  
 B : BLACK    LG : LIGHT GREEN    G : GREEN    L : BLUE    W : WHITE    Y : YELLOW  
 SB : SKY BLUE    BR : BROWN    O : ORANGE    GR : GRAY    R : RED    P : PINK    V : VIOLET

# ACCESSORY SOCKET

M1901007900604

1

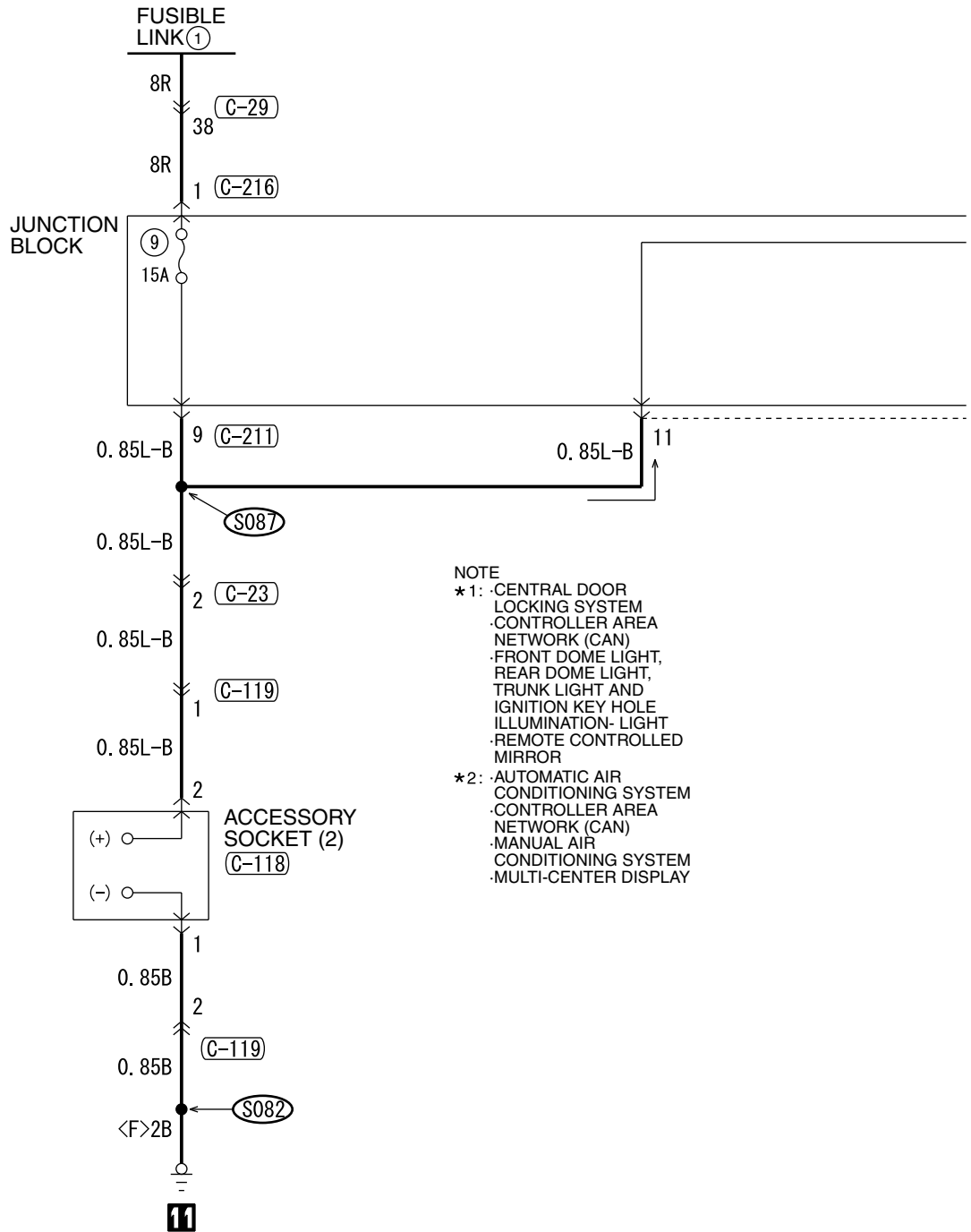

(C-03)



(C-17)



(C-23)

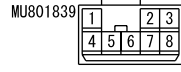

(C-29)

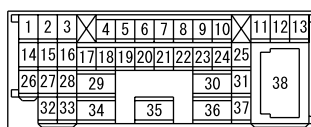

(C-118)



(C-119)



(C-209)



TSB Revision

2

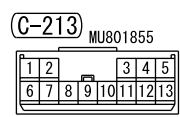
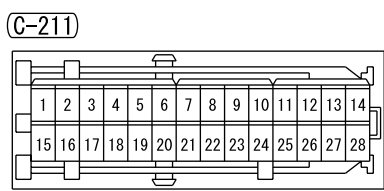
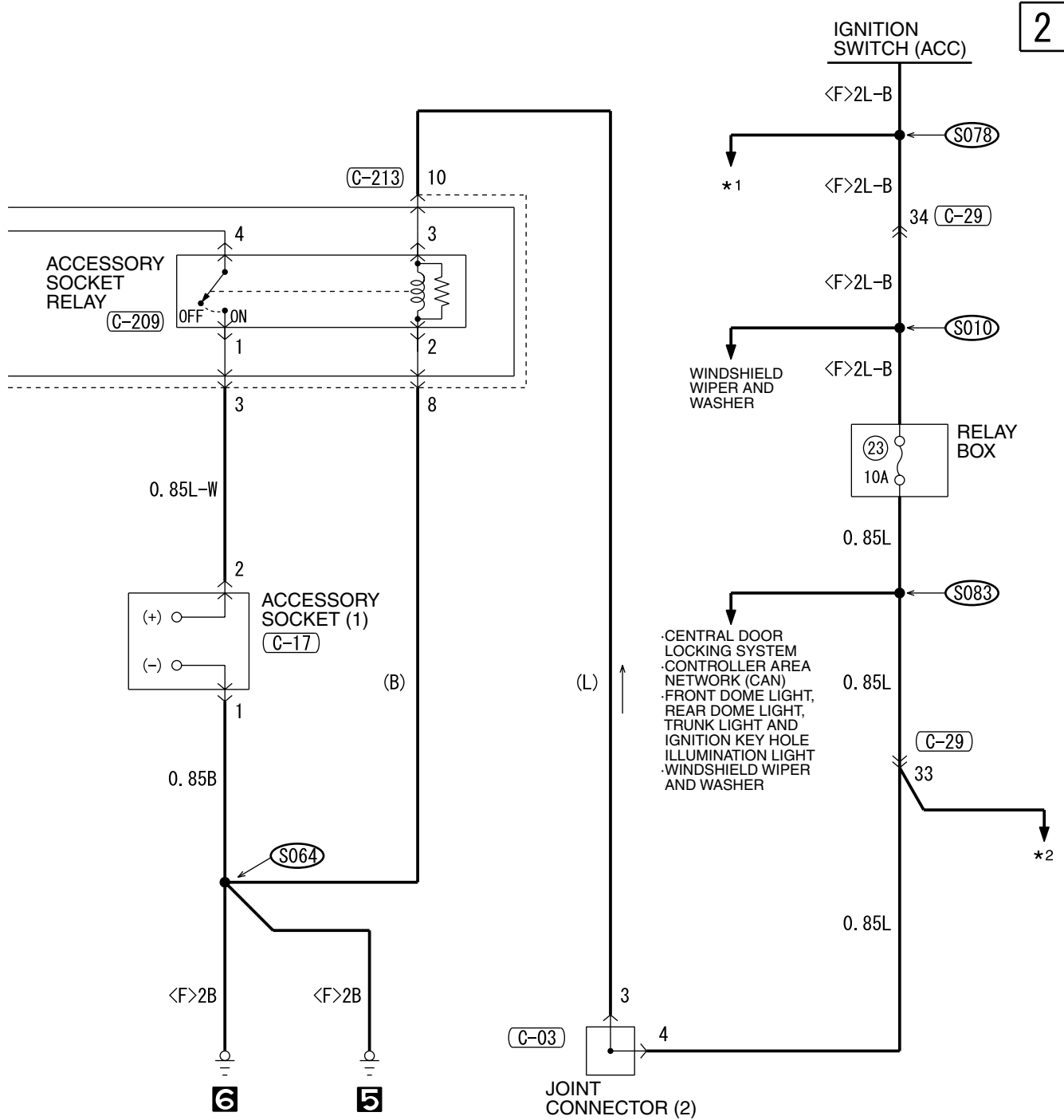

WIRE COLOR CODE  
 B : BLACK SB : SKY BLUE  
 BR : BROWN LG : LIGHT GREEN  
 G : GREEN P : PINK GR : GRAY  
 R : RED L : BLUE Y : YELLOW  
 V : VIOLET W : WHITE O : ORANGE

MULTI-CENTER DISPLAY <LOW>

M1901018000263

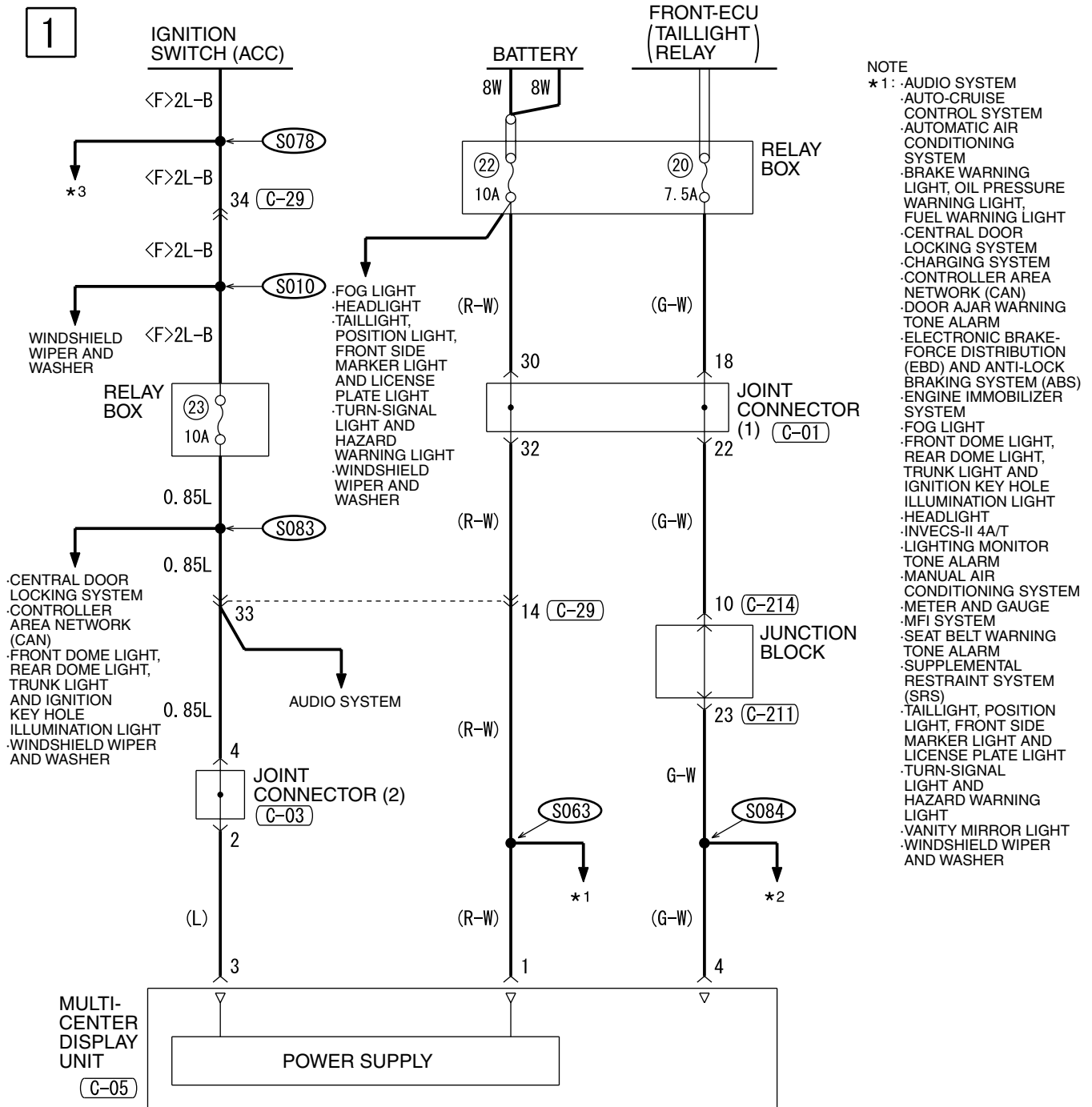

NOTE

- \*1: .AUDIO SYSTEM
- .AUTO-CRUISE CONTROL SYSTEM
- .AUTOMATIC AIR CONDITIONING SYSTEM
- .BRAKE WARNING LIGHT, OIL PRESSURE WARNING LIGHT, FUEL WARNING LIGHT
- .CENTRAL DOOR LOCKING SYSTEM
- .CHARGING SYSTEM
- .CONTROLLER AREA NETWORK (CAN)
- .DOOR AJAR WARNING TONE ALARM
- .ELECTRONIC BRAKE-FORCE DISTRIBUTION (EBD) AND ANTI-LOCK BRAKING SYSTEM (ABS)
- .ENGINE IMMOBILIZER SYSTEM
- .FOG LIGHT
- .FRONT DOME LIGHT, REAR DOME LIGHT, TRUNK LIGHT AND IGNITION KEY HOLE ILLUMINATION LIGHT
- .HEADLIGHT
- .INVECS-II 4A/T
- .LIGHTING MONITOR TONE ALARM
- .MANUAL AIR CONDITIONING SYSTEM
- .METER AND GAUGE
- .MFI SYSTEM
- .SEAT BELT WARNING TONE ALARM
- .SUPPLEMENTAL RESTRAINT SYSTEM (SRS)
- .TAILLIGHT, POSITION LIGHT, FRONT SIDE MARKER LIGHT AND LICENSE PLATE LIGHT
- .TURN-SIGNAL LIGHT AND HAZARD WARNING LIGHT
- .VANITY MIRROR LIGHT
- .WINDSHIELD WIPER AND WASHER

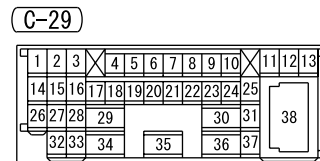
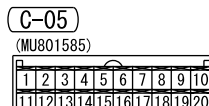
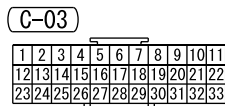
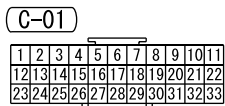

2

NOTE

- \*2: .AUDIO SYSTEM
- .AUTOMATIC AIR CONDITIONING SYSTEM
- .ELECTRONIC BRAKE-FORCE DISTRIBUTION (EBD) AND ANTI-LOCK BRAKING SYSTEM (ABS) <VEHICLES WITH TRACTION CONTROL (TCL)>
- .FOG LIGHT
- .GLOVE BOX LIGHT
- .HEATED SEAT
- .INVECS-II 4A/T
- .MANUAL AIR CONDITIONING SYSTEM
- .METER AND GAUGE
- .REAR WINDOW DEFOGGER AND DOOR MIRROR HEATER
- .RHEOSTAT
- .SUPPLEMENTAL RESTRAINT SYSTEM (SRS)
- .TURN-SIGNAL LIGHT AND HAZARD WARNING LIGHT
- \*3: .CENTRAL DOOR LOCKING SYSTEM
- .CONTROLLER AREA NETWORK (CAN)
- .FRONT DOME LIGHT, REAR DOME LIGHT, TRUNK LIGHT AND IGNITION KEY HOLE ILLUMINATION LIGHT
- .REMOTE CONTROLLED MIRROR

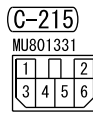
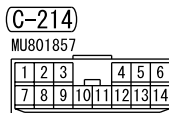
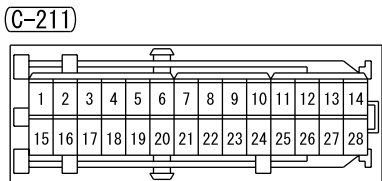
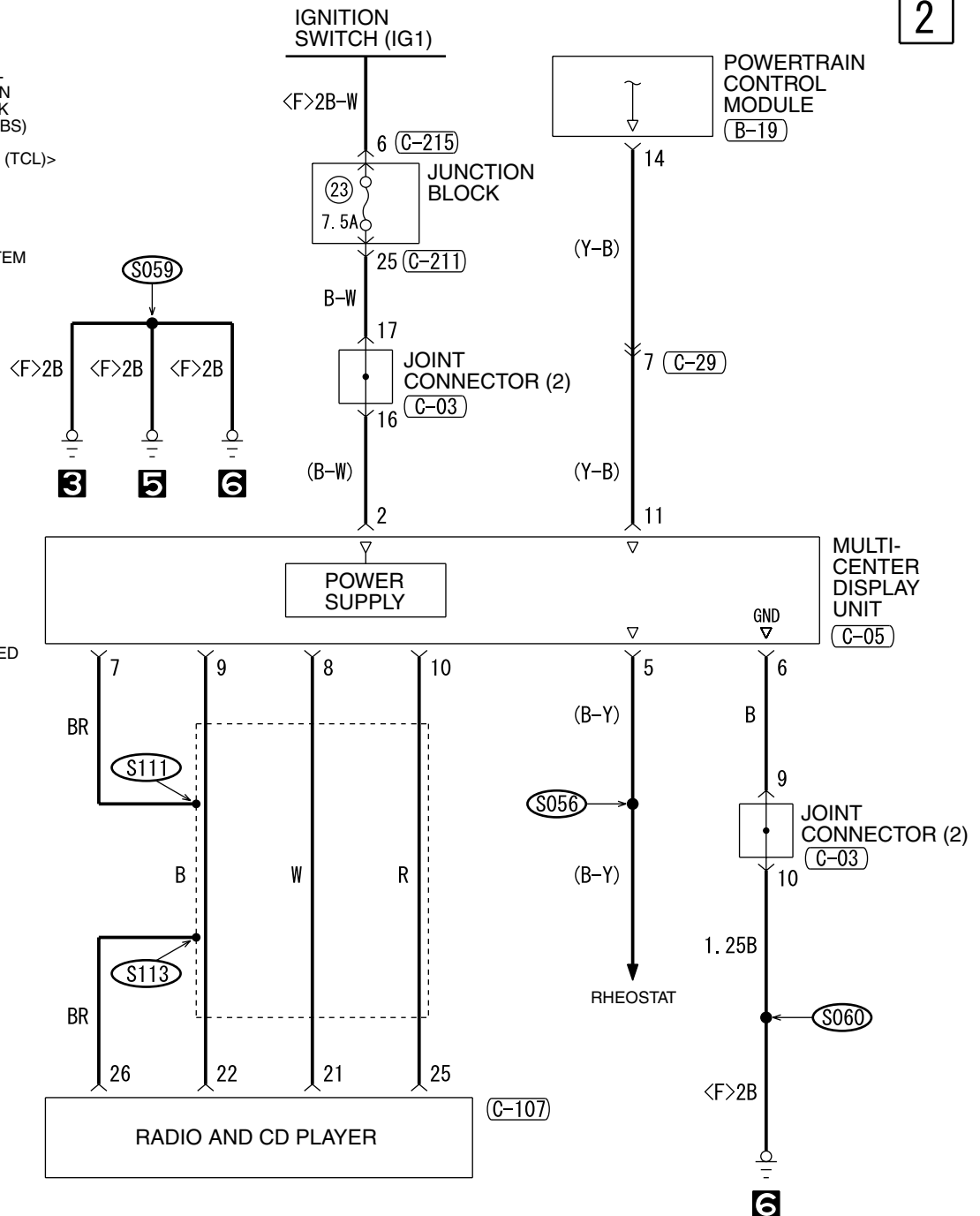

WIRE COLOR CODE

B : BLACK LG : LIGHT GREEN G : GREEN L : BLUE  
BR : BROWN O : ORANGE GR : GRAY R : RED W : WHITE  
SB : SKY BLUE P : PINK Y : YELLOW V : VIOLET

H5P14M03AB

MULTI-CENTER DISPLAY <MIDDLE>

M1901018000274

1

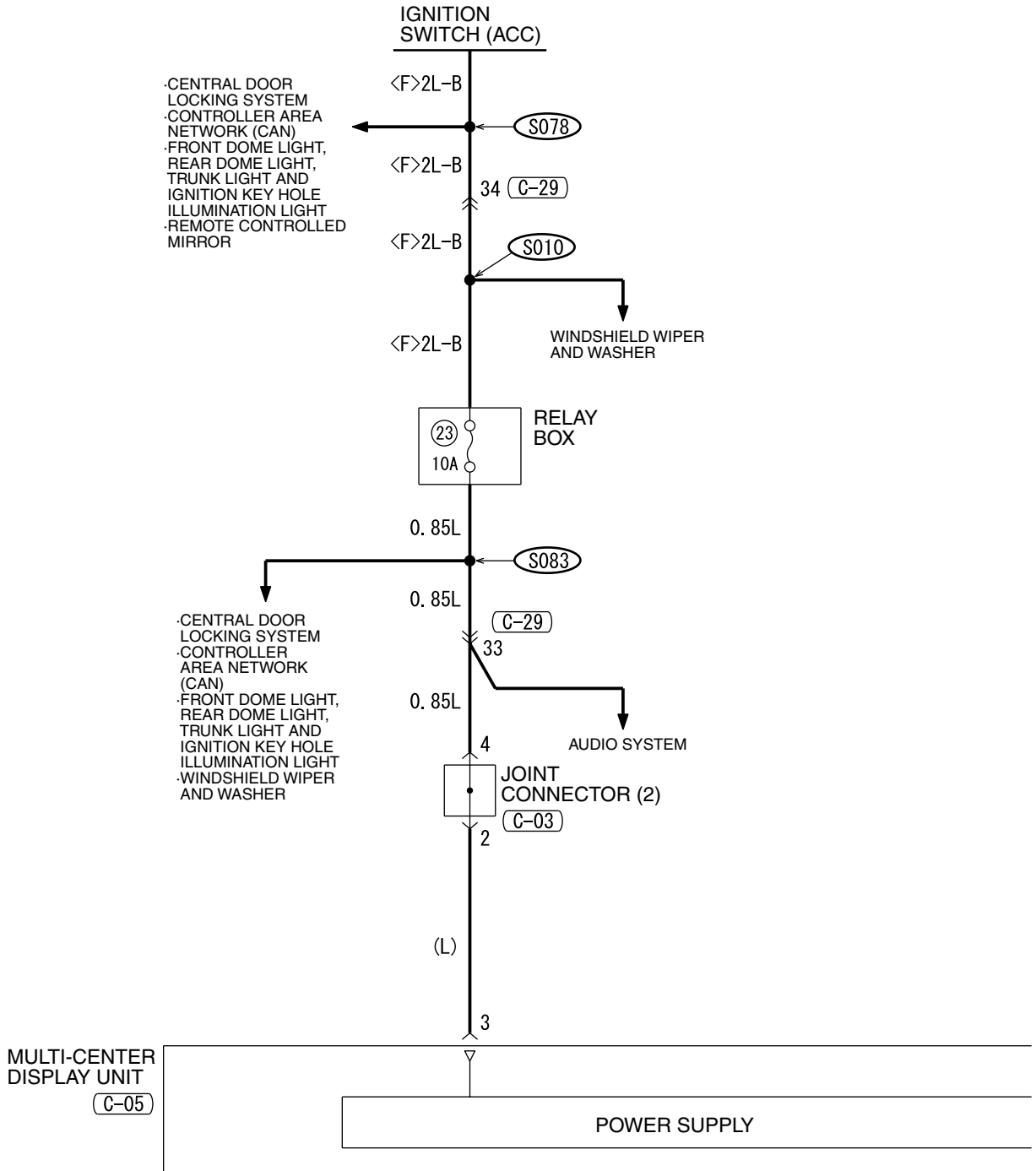

C-01

1	2	3	4	5	6	7	8	9	10	11
12	13	14	15	16	17	18	19	20	21	22
23	24	25	26	27	28	29	30	31	32	33

C-03

1	2	3	4	5	6	7	8	9	10	11
12	13	14	15	16	17	18	19	20	21	22
23	24	25	26	27	28	29	30	31	32	33

C-05

(MU801585)

1	2	3	4	5	6	7	8	9	10
11	12	13	14	15	16	17	18	19	20

C-29

1	2	3	4	5	6	7	8	9	10	11	12	13
14	15	16	17	18	19	20	21	22	23	24	25	
26	27	28	29					30	31			
32	33	34			35			36	37			38

H5P14M04AA

2

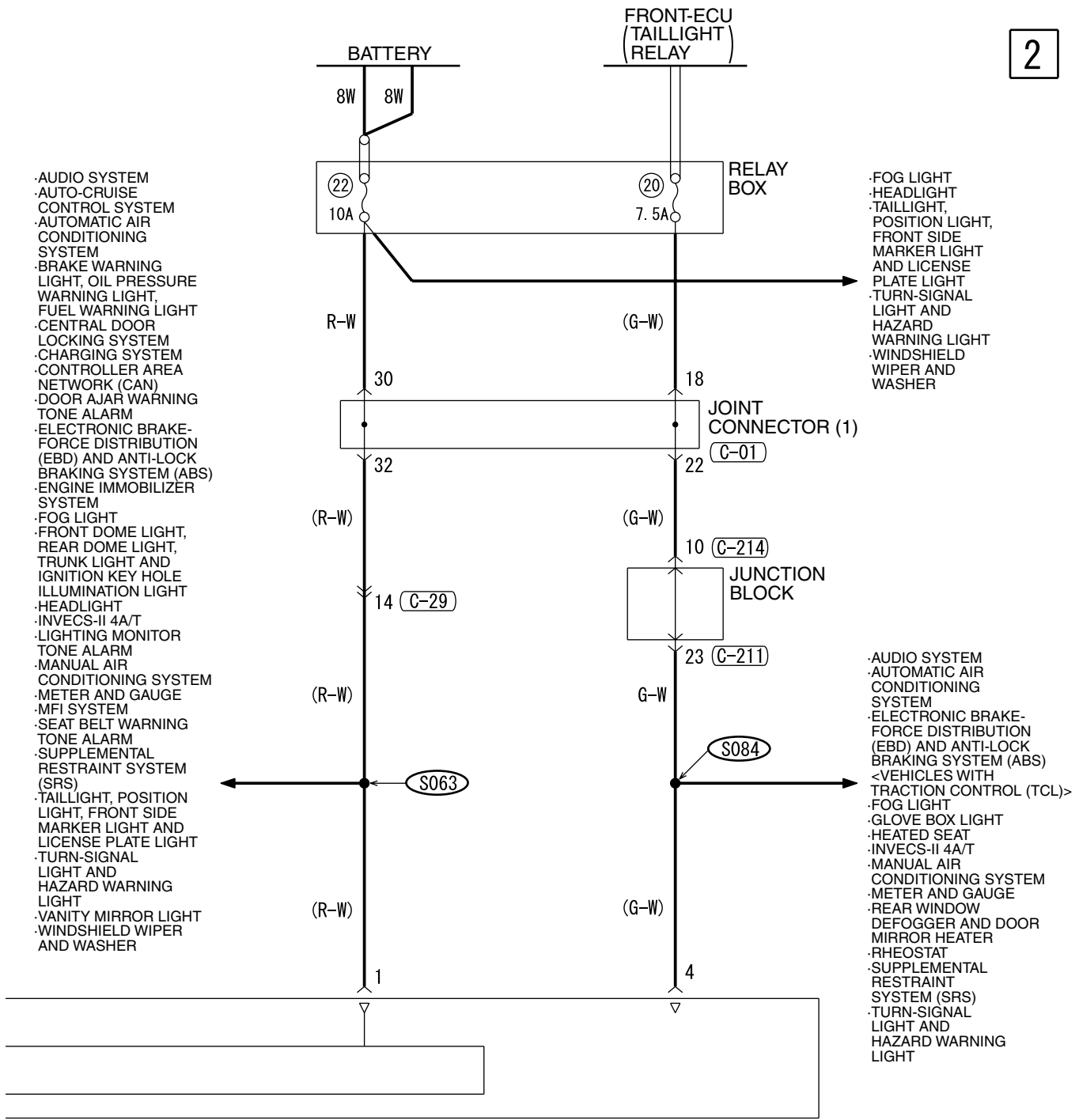

- AUDIO SYSTEM
- AUTO-CRUISE CONTROL SYSTEM
- AUTOMATIC AIR CONDITIONING SYSTEM
- BRAKE WARNING LIGHT, OIL PRESSURE WARNING LIGHT, FUEL WARNING LIGHT
- CENTRAL DOOR LOCKING SYSTEM
- CHARGING SYSTEM
- CONTROLLER AREA NETWORK (CAN)
- DOOR AJAR WARNING TONE ALARM
- ELECTRONIC BRAKE-FORCE DISTRIBUTION (EBD) AND ANTI-LOCK BRAKING SYSTEM (ABS)
- ENGINE IMMOBILIZER SYSTEM
- FOG LIGHT
- FRONT DOME LIGHT, REAR DOME LIGHT, TRUNK LIGHT AND IGNITION KEY HOLE ILLUMINATION LIGHT
- HEADLIGHT
- INVECS-II 4A/T
- LIGHTING MONITOR TONE ALARM
- MANUAL AIR CONDITIONING SYSTEM
- METER AND GAUGE
- MFI SYSTEM
- SEAT BELT WARNING TONE ALARM
- SUPPLEMENTAL RESTRAINT SYSTEM (SRS)
- TAILLIGHT, POSITION LIGHT, FRONT SIDE MARKER LIGHT AND LICENSE PLATE LIGHT
- TURN-SIGNAL LIGHT AND HAZARD WARNING LIGHT
- VANITY MIRROR LIGHT
- WINDSHIELD WIPER AND WASHER

- FOG LIGHT
- HEADLIGHT
- TAILLIGHT, POSITION LIGHT, FRONT SIDE MARKER LIGHT AND LICENSE PLATE LIGHT
- TURN-SIGNAL LIGHT AND HAZARD WARNING LIGHT
- WINDSHIELD WIPER AND WASHER

- AUDIO SYSTEM
- AUTOMATIC AIR CONDITIONING SYSTEM
- ELECTRONIC BRAKE-FORCE DISTRIBUTION (EBD) AND ANTI-LOCK BRAKING SYSTEM (ABS) <VEHICLES WITH TRACTION CONTROL (TCL)>
- FOG LIGHT
- GLOVE BOX LIGHT
- HEATED SEAT
- INVECS-II 4A/T
- MANUAL AIR CONDITIONING SYSTEM
- METER AND GAUGE
- REAR WINDOW DEFOGGER AND DOOR MIRROR HEATER
- RHEOSTAT
- SUPPLEMENTAL RESTRAINT SYSTEM (SRS)
- TURN-SIGNAL LIGHT AND HAZARD WARNING LIGHT

(C-211)

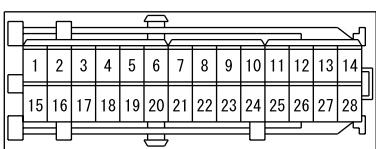

(C-214)

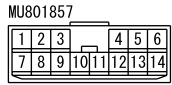

WIRE COLOR CODE  
 B : BLACK    LG : LIGHT GREEN    G : GREEN    L : BLUE  
 BR : BROWN    O : ORANGE    GR : GRAY    R : RED    W : WHITE  
 SB : SKY BLUE    P : PINK    Y : YELLOW    V : VIOLET

MULTI-CENTER DISPLAY <MIDDLE> (CONTINUED)

3

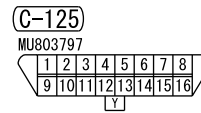
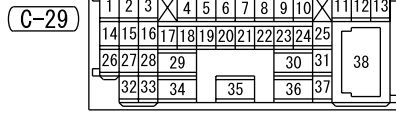
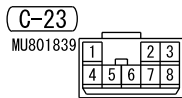
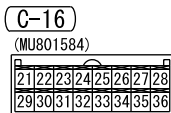
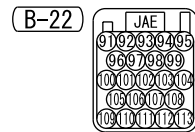
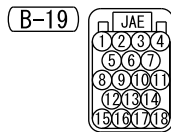
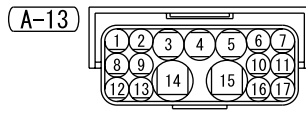
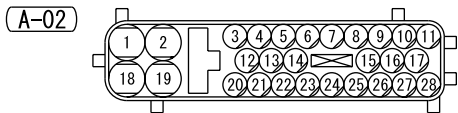
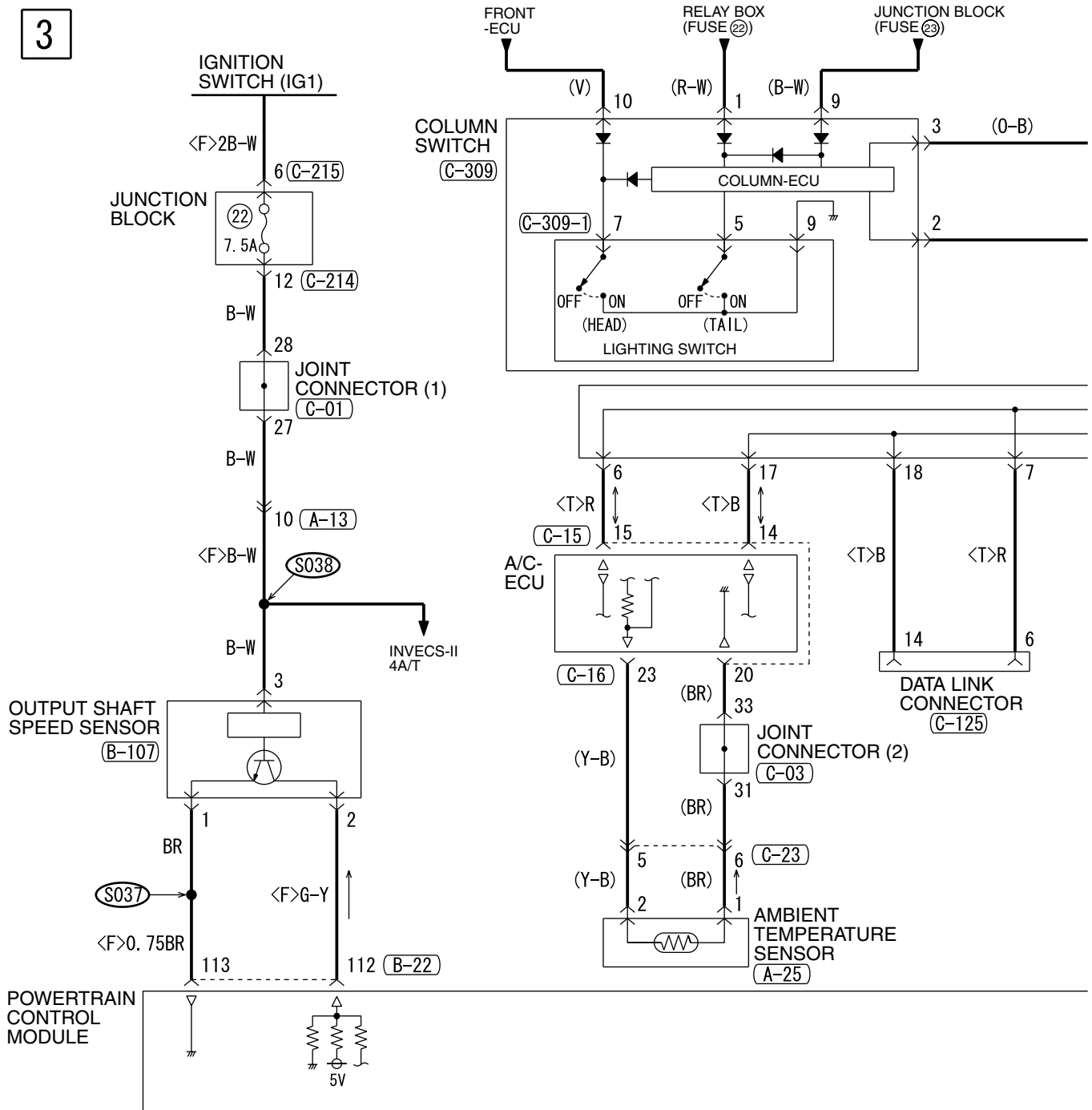



4

NOTE

- \* 1: WITHOUT ELECTRONIC BRAKE-FORCE DISTRIBUTION (EBD) AND ANTI-LOCK BRAKING SYSTEM (ABS)
- \* 2: WITH ELECTRONIC BRAKE-FORCE DISTRIBUTION (EBD) AND ANTI-LOCK BRAKING SYSTEM (ABS)

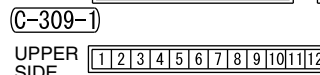
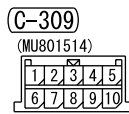
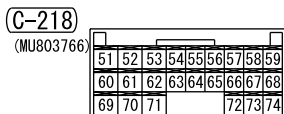
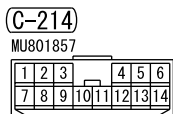
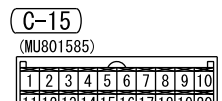
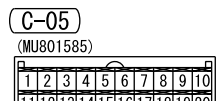
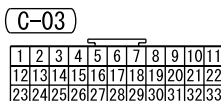
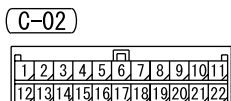
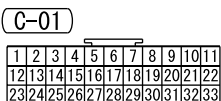
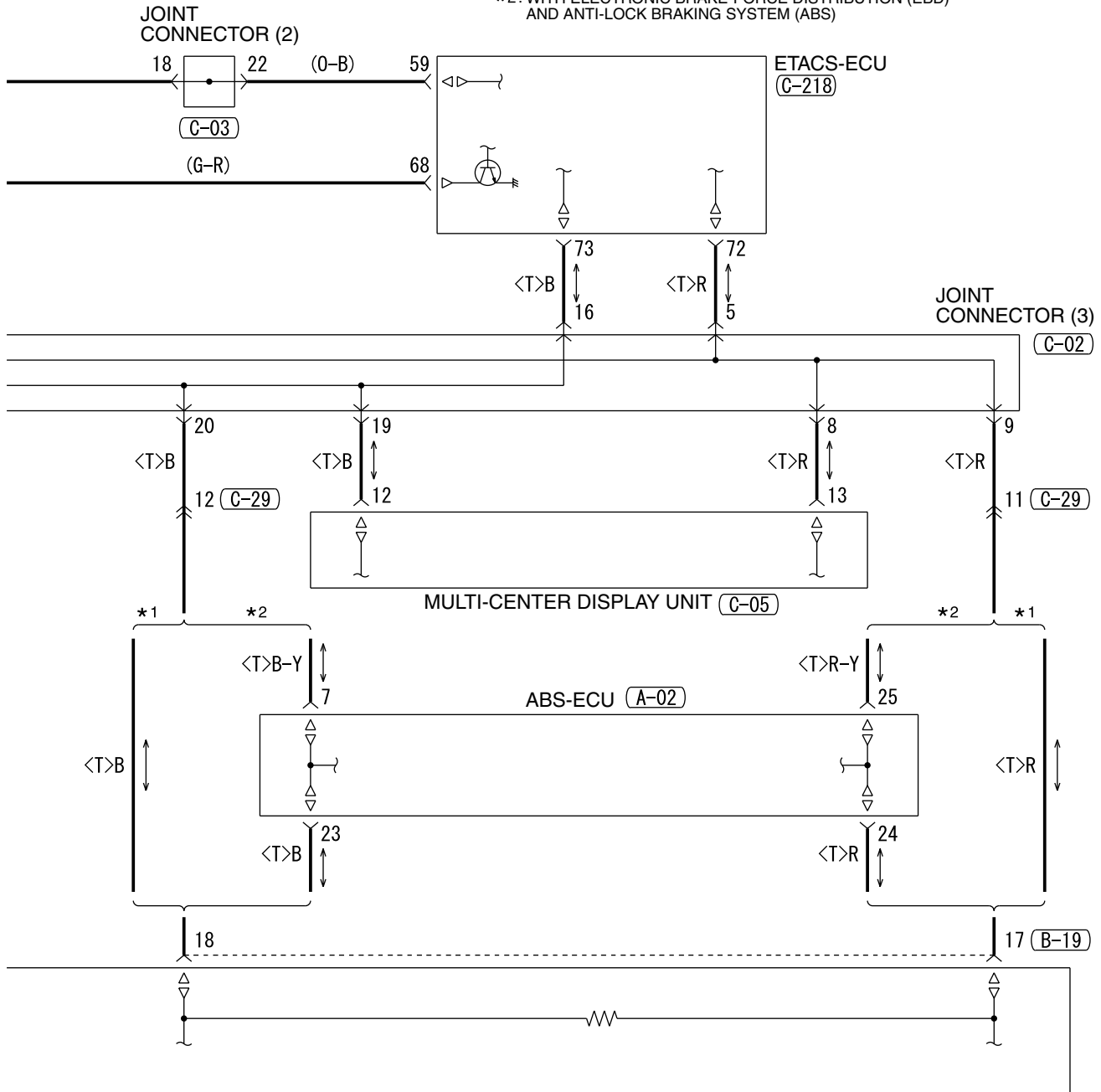

MULTI-CENTER DISPLAY <MIDDLE> (CONTINUED)

5

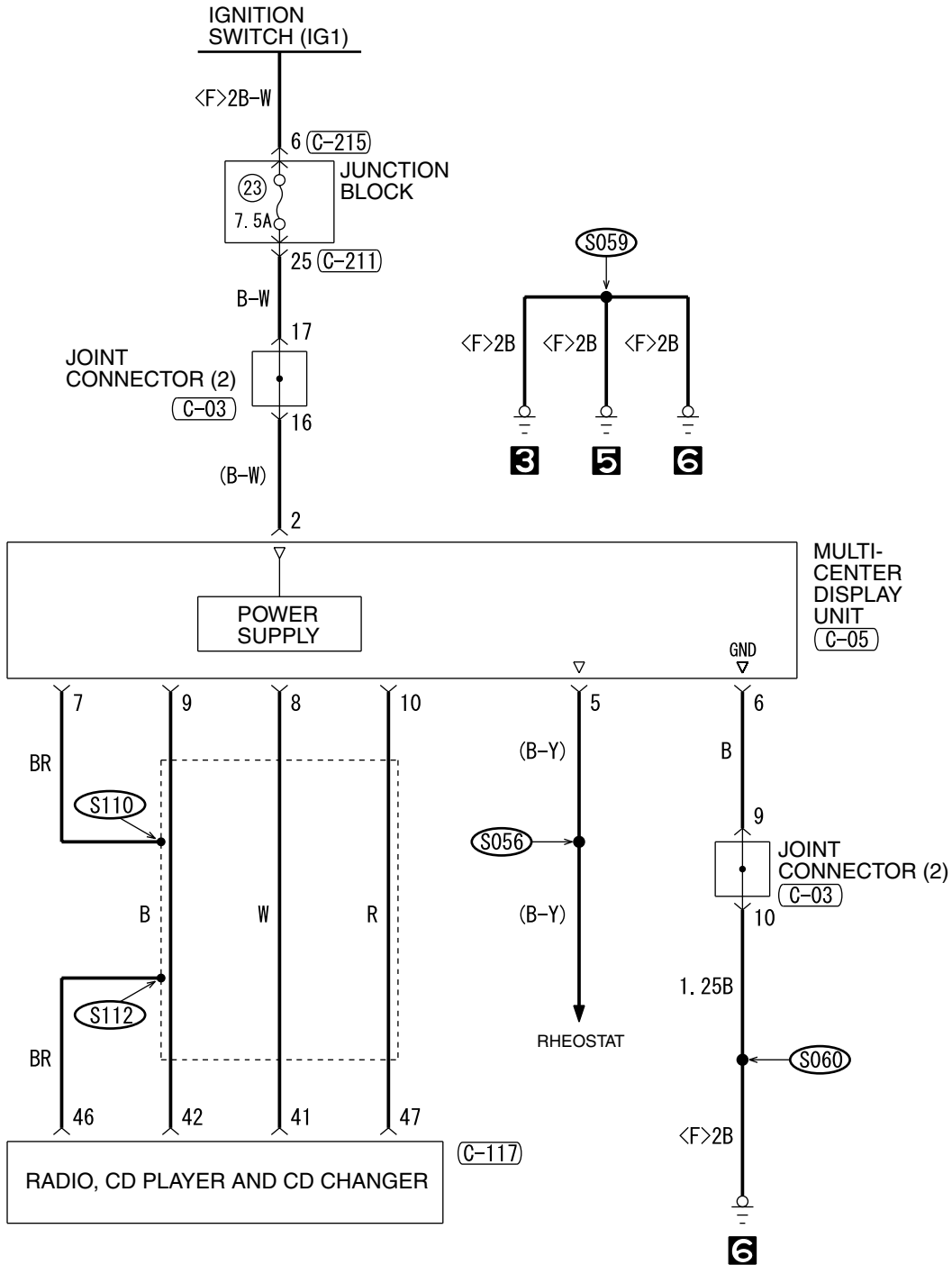

(C-03)



(C-05)

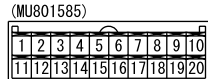

(C-117)

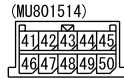

(C-211)

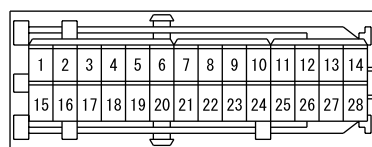

(C-215)



NOTES

# SUNROOF

1

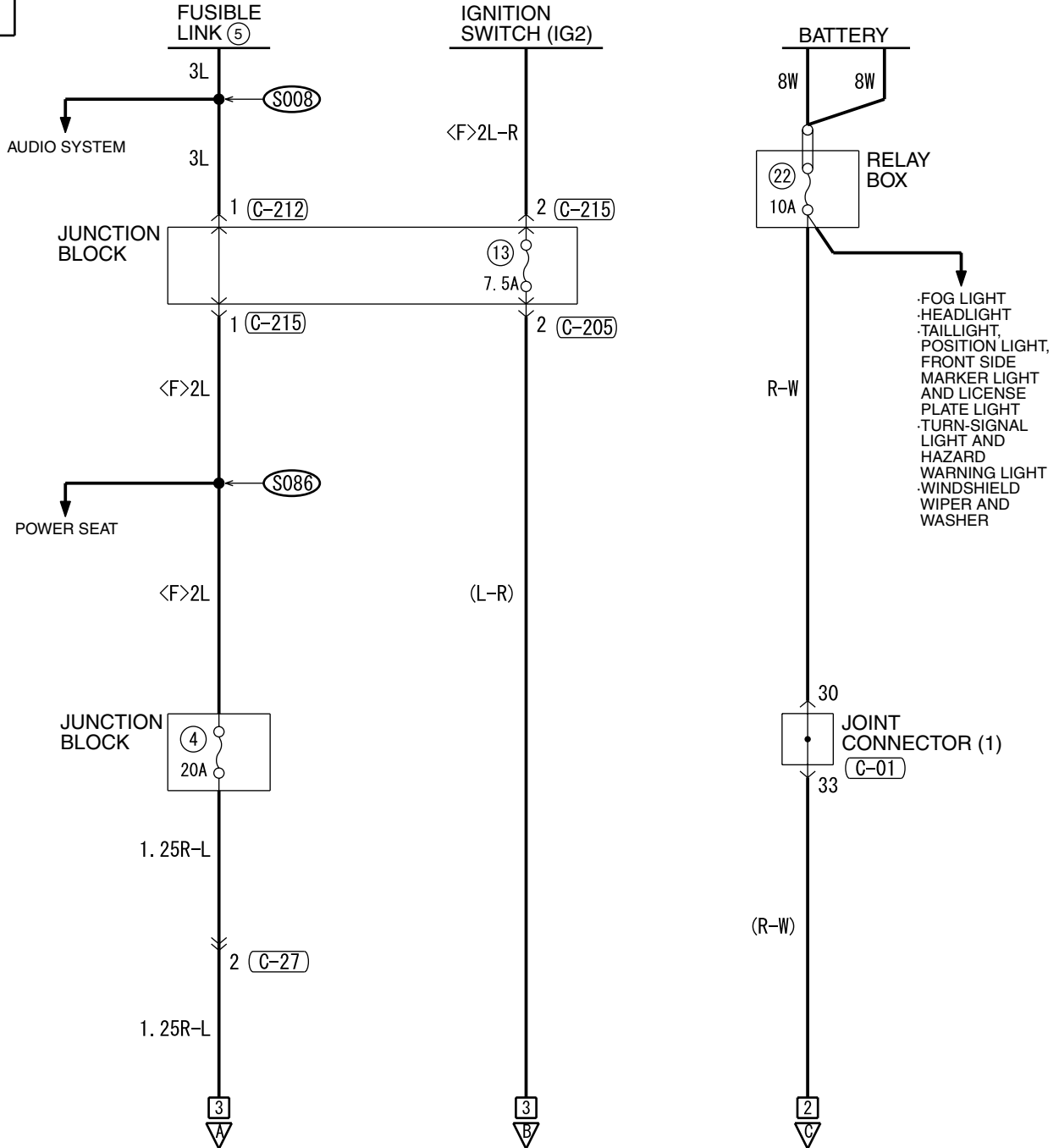

C-01

1	2	3	4	5	6	7	8	9	10	11
12	13	14	15	16	17	18	19	20	21	22
23	24	25	26	27	28	29	30	31	32	33

C-03

1	2	3	4	5	6	7	8	9	10	11
12	13	14	15	16	17	18	19	20	21	22
23	24	25	26	27	28	29	30	31	32	33

C-27

MU801687

1	2
3	4

C-29

1	2	3	4	5	6	7	8	9	10	11	12	13
14	15	16	17	18	19	20	21	22	23	24	25	
26	27	28	29					30	31			
			32	33	34					35		
										36	37	38

C-125

MU803797

1	2	3	4	5	6	7	8
9	10	11	12	13	14	15	16

C-218

(MU803766)

51	52	53	54	55	56	57	58	59
60	61	62	63	64	65	66	67	68
69	70	71			72	73	74	

C-219 JUNCTION BLOCK SIDE

20	19	18	17	16	15	14	13	12	11	10	9	8	7	6	5	4	3	2	1
----	----	----	----	----	----	----	----	----	----	----	---	---	---	---	---	---	---	---	---

D-22

(MU801536)

1	2	3
---	---	---

2

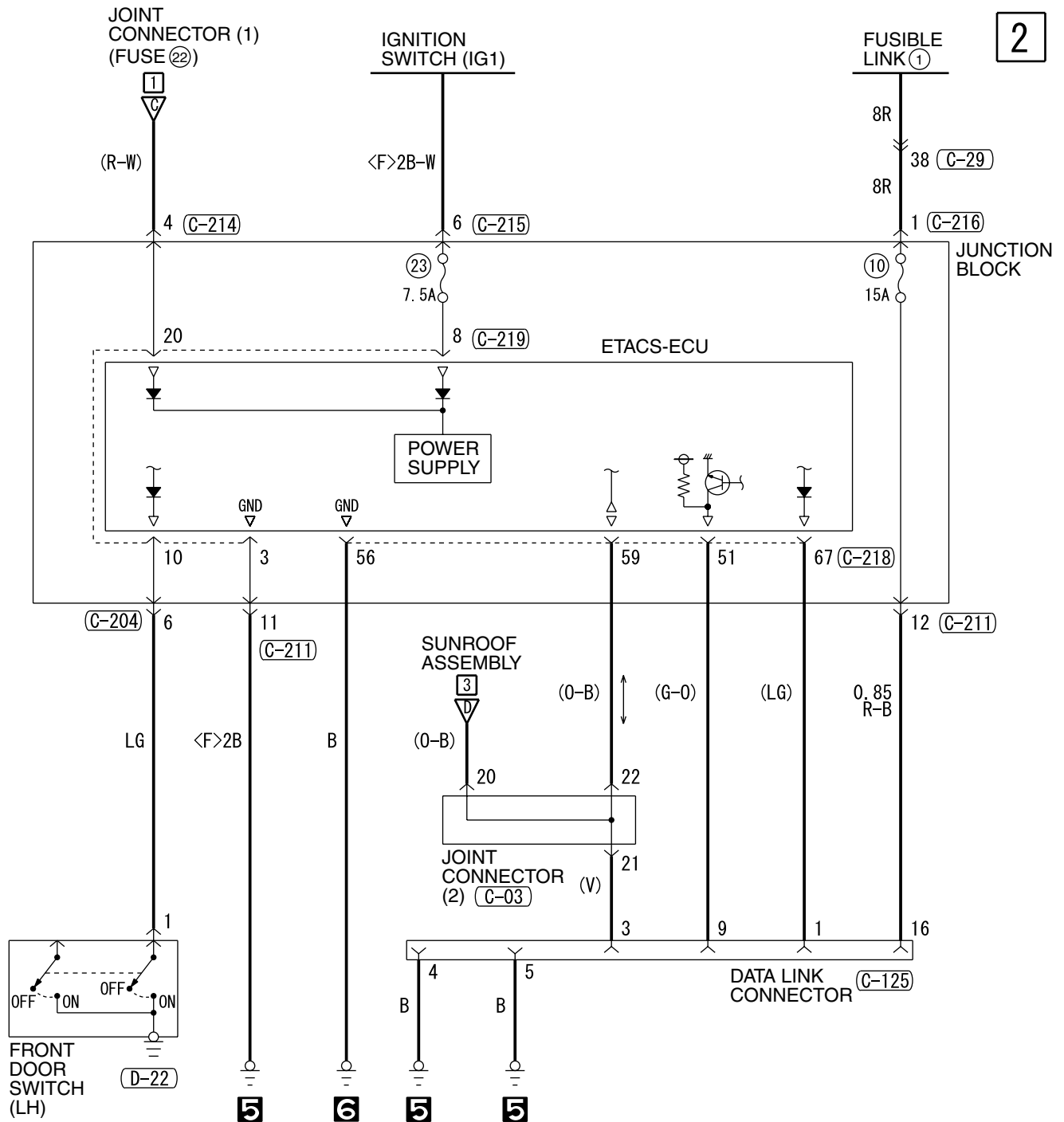

(C-204)

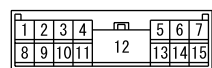

(C-205)



(C-211)

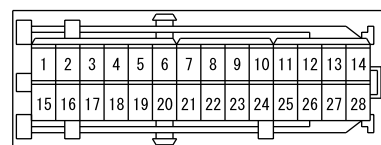

(C-212)



(C-214)

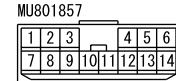

(C-215)



(C-216)



SUNROOF (CONTINUED)

3

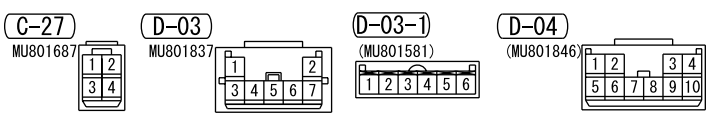
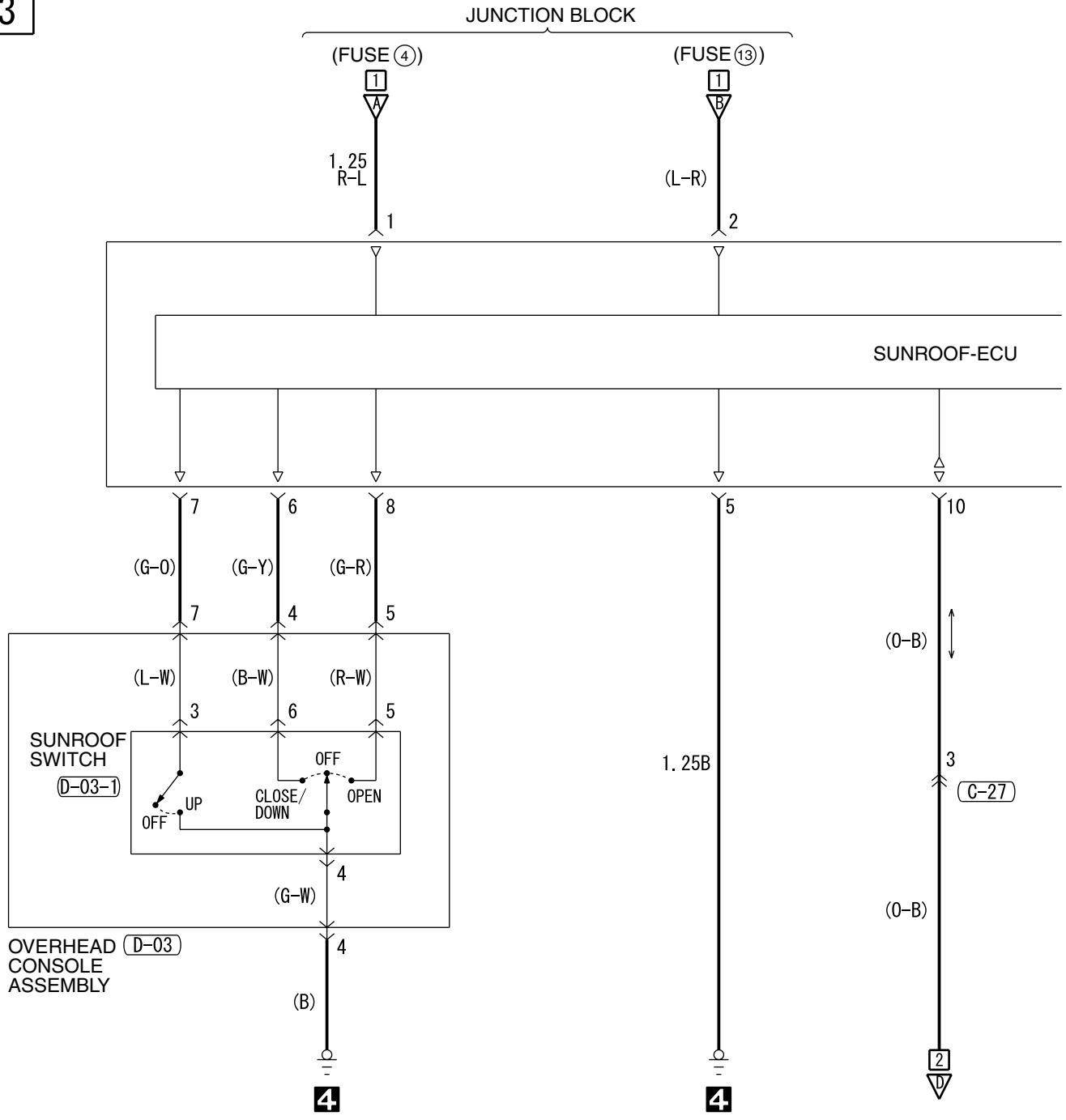

SUNROOF ASSEMBLY (D-04)

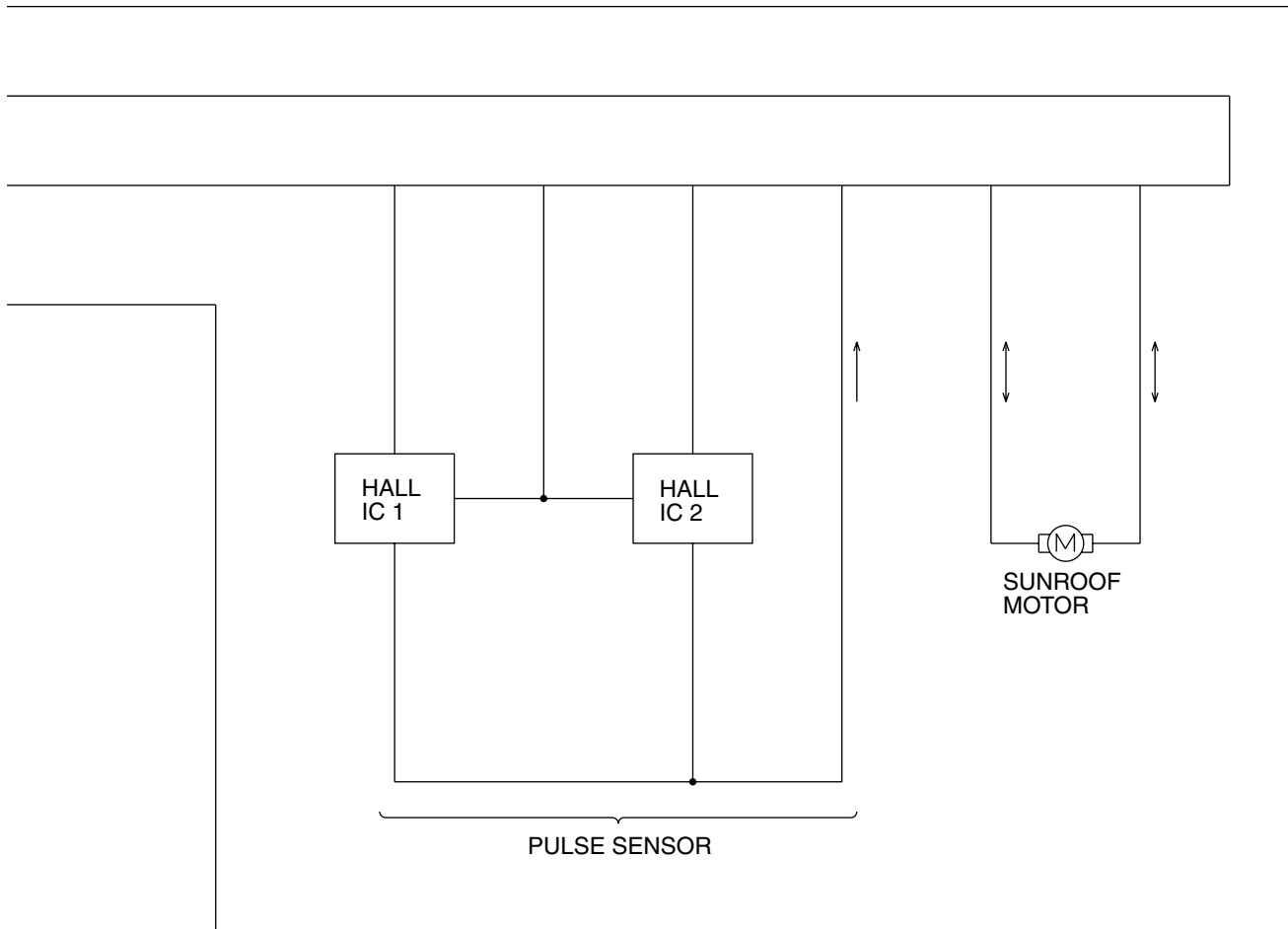

WIRE COLOR CODE

B: BLACK LG: LIGHT GREEN G: GREEN L: BLUE W: WHITE Y: YELLOW  
SB: SKY BLUE BR: BROWN O: ORANGE GR: GRAY R: RED P: PINK V: VIOLET

H5P15M00BB

# AUTO-CRUISE CONTROL SYSTEM

M1901009301515

1

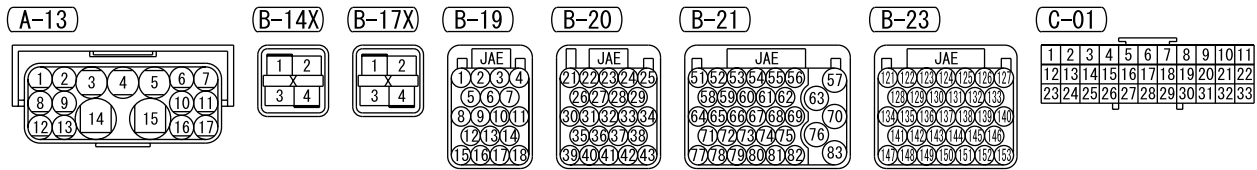
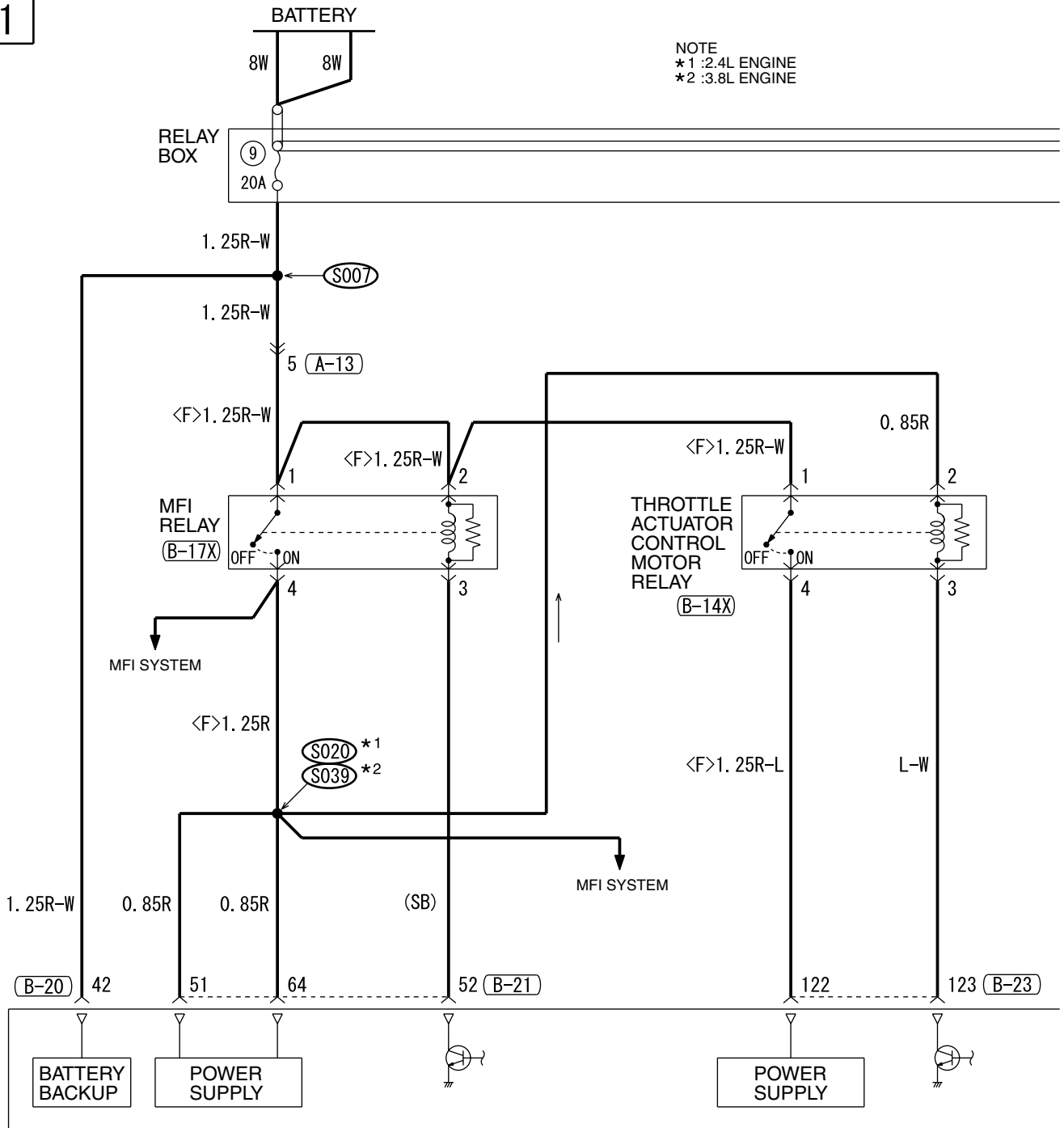

H5P15M01AA

TSB Revision



**2**

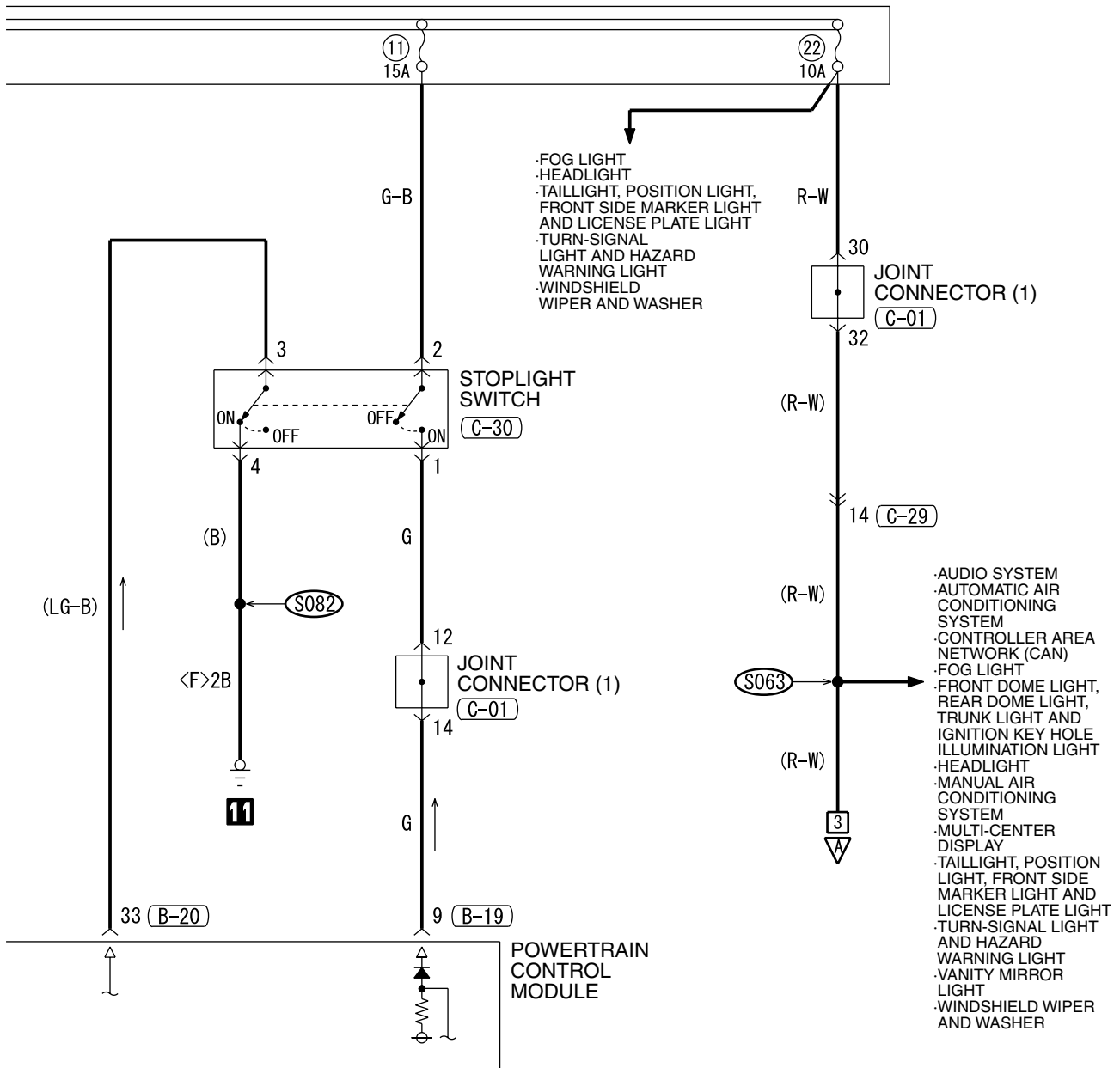

**C-29**

1	2	3	4	5	6	7	8	9	10	11	12	13
14	15	16	17	18	19	20	21	22	23	24	25	
26	27	28	29					30	31			
32	33	34	35	36	37							

**C-30**

MU801491

1	2
3	4

**WIRE COLOR CODE**

B : BLACK    LG : LIGHT GREEN    G : GREEN    L : BLUE  
 BR : BROWN    O : ORANGE    GR : GRAY    R : RED    W : WHITE  
 SB : SKY BLUE    P : PINK    Y : YELLOW    V : VIOLET

H5P15M01AB

**TSB Revision**

AUTO-CRUISE CONTROL SYSTEM (CONTINUED)

3

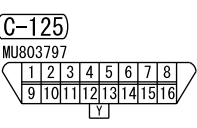
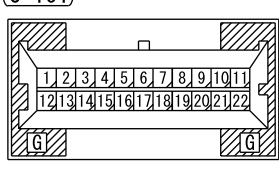
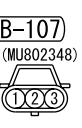
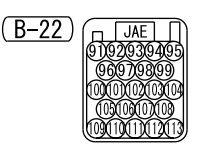
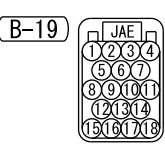
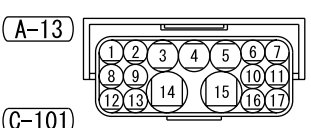
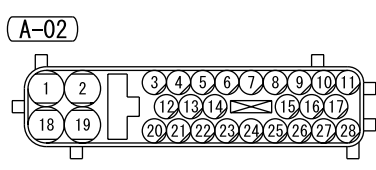
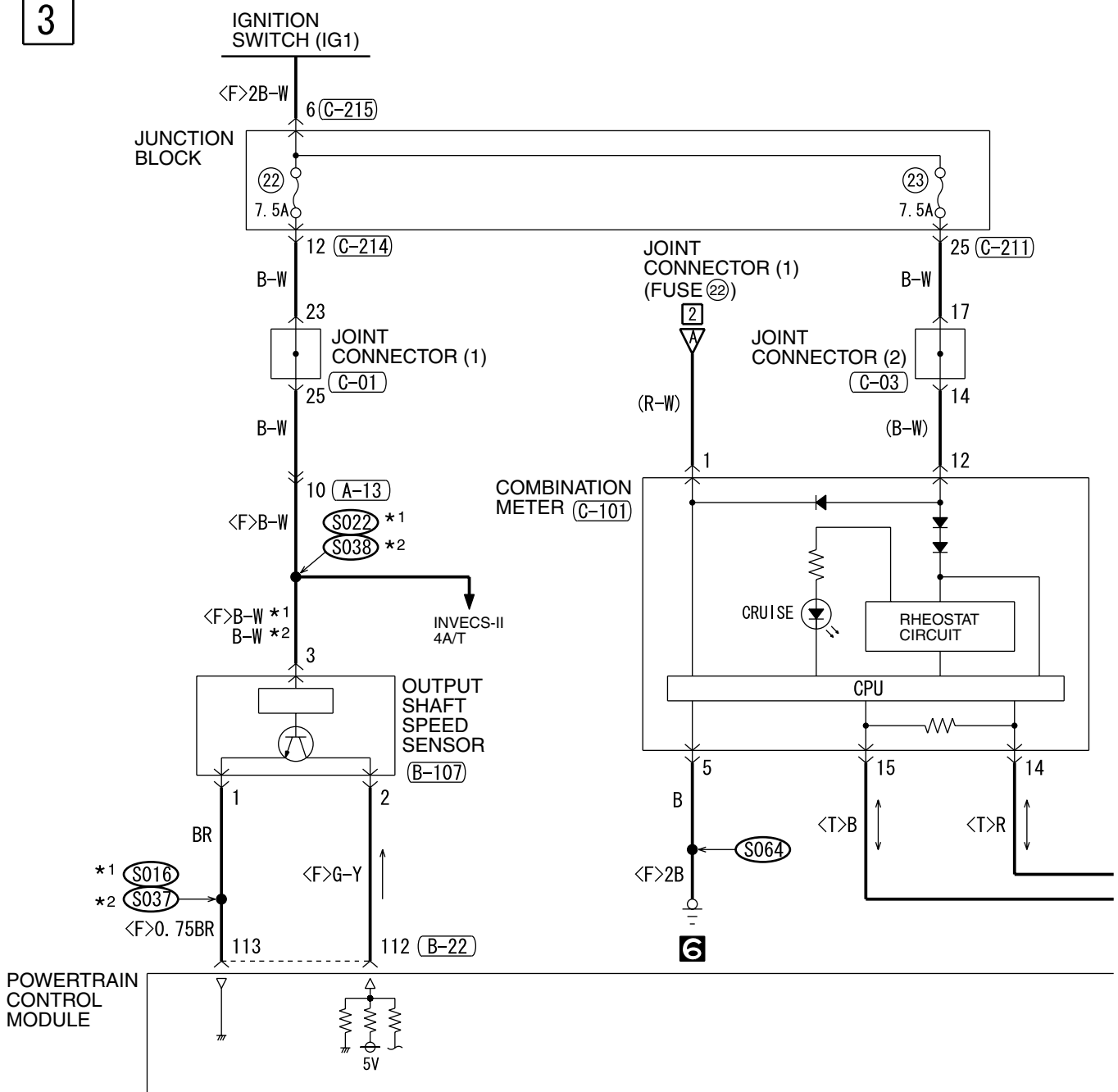

4

NOTE

- \*1: 2.4L ENGINE
- \*2: 3.8L ENGINE
- \*3: WITHOUT ELECTRONIC BRAKE-FORCE DISTRIBUTION (EBD) AND ANTI-LOCK BRAKING SYSTEM (ABS)
- \*4: WITH ELECTRONIC BRAKE-FORCE DISTRIBUTION (EBD) AND ANTI-LOCK BRAKING SYSTEM (ABS)

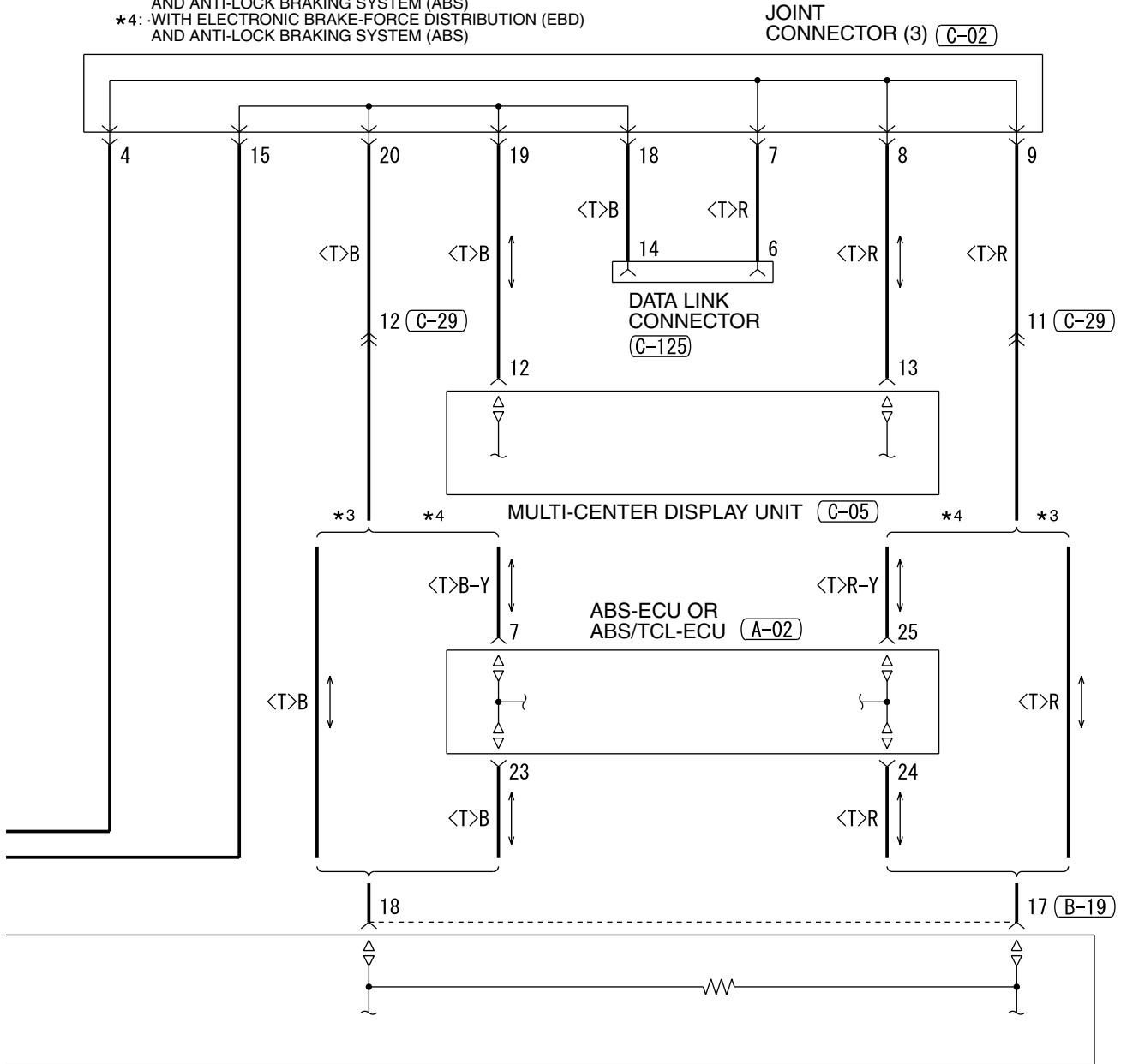

(C-01)



(C-02)

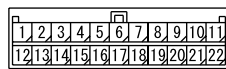

(C-03)

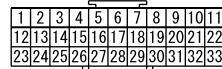

(C-05)

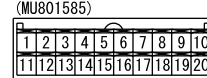

(C-29)

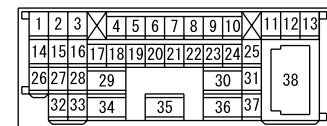

(C-211)

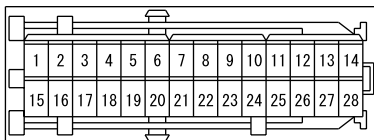

(C-214)

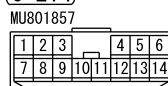

(C-215)



AUTO-CRUISE CONTROL SYSTEM (CONTINUED)

5

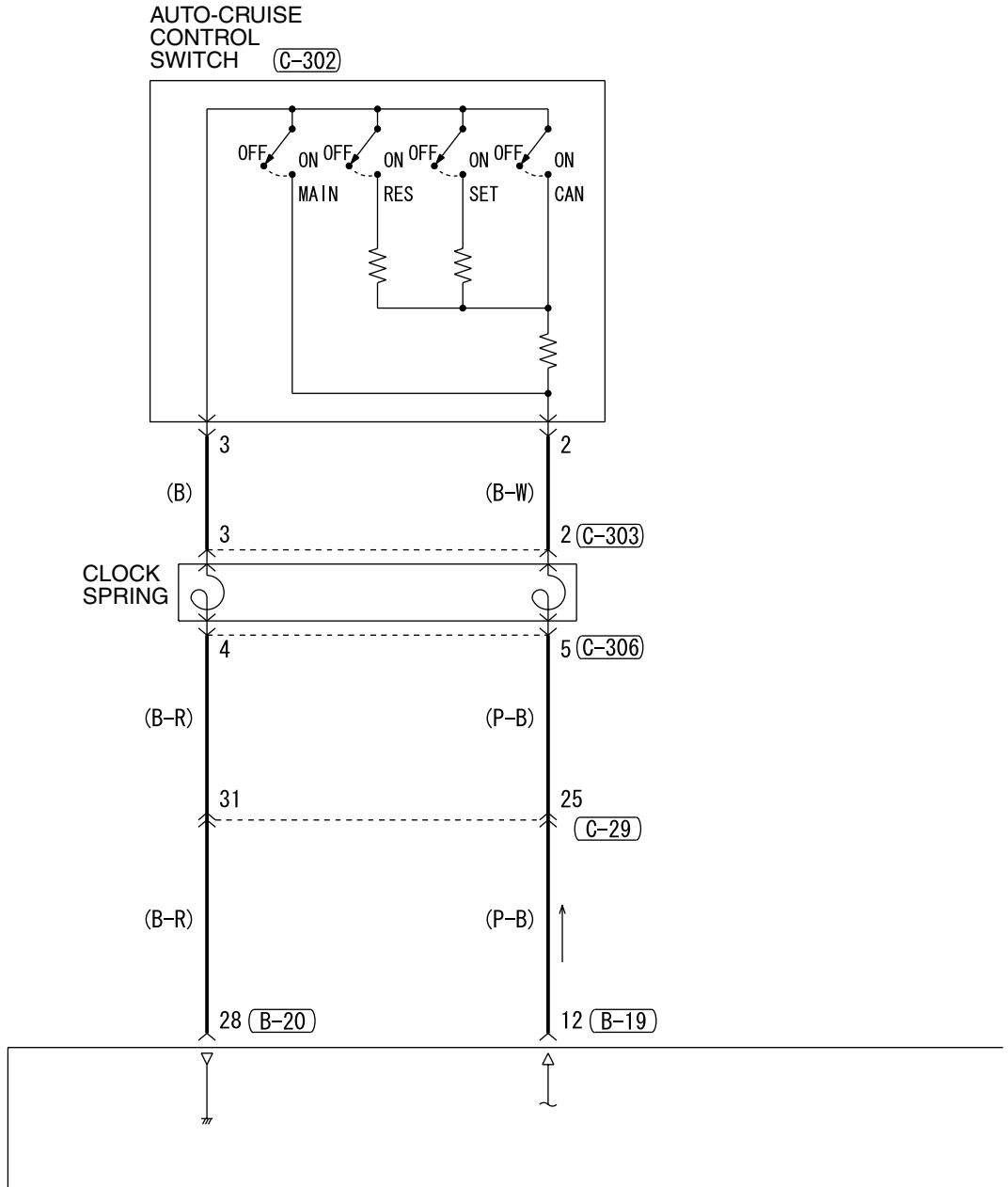

(A-13)

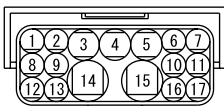

(B-19)

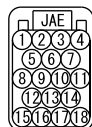

(B-20)

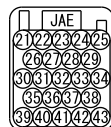

(B-21)

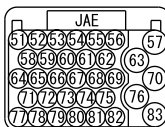

(B-110)

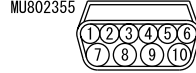

(C-29)

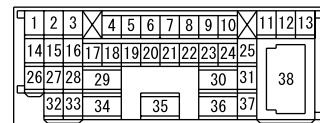

6

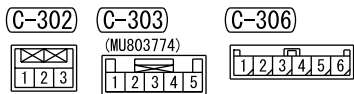
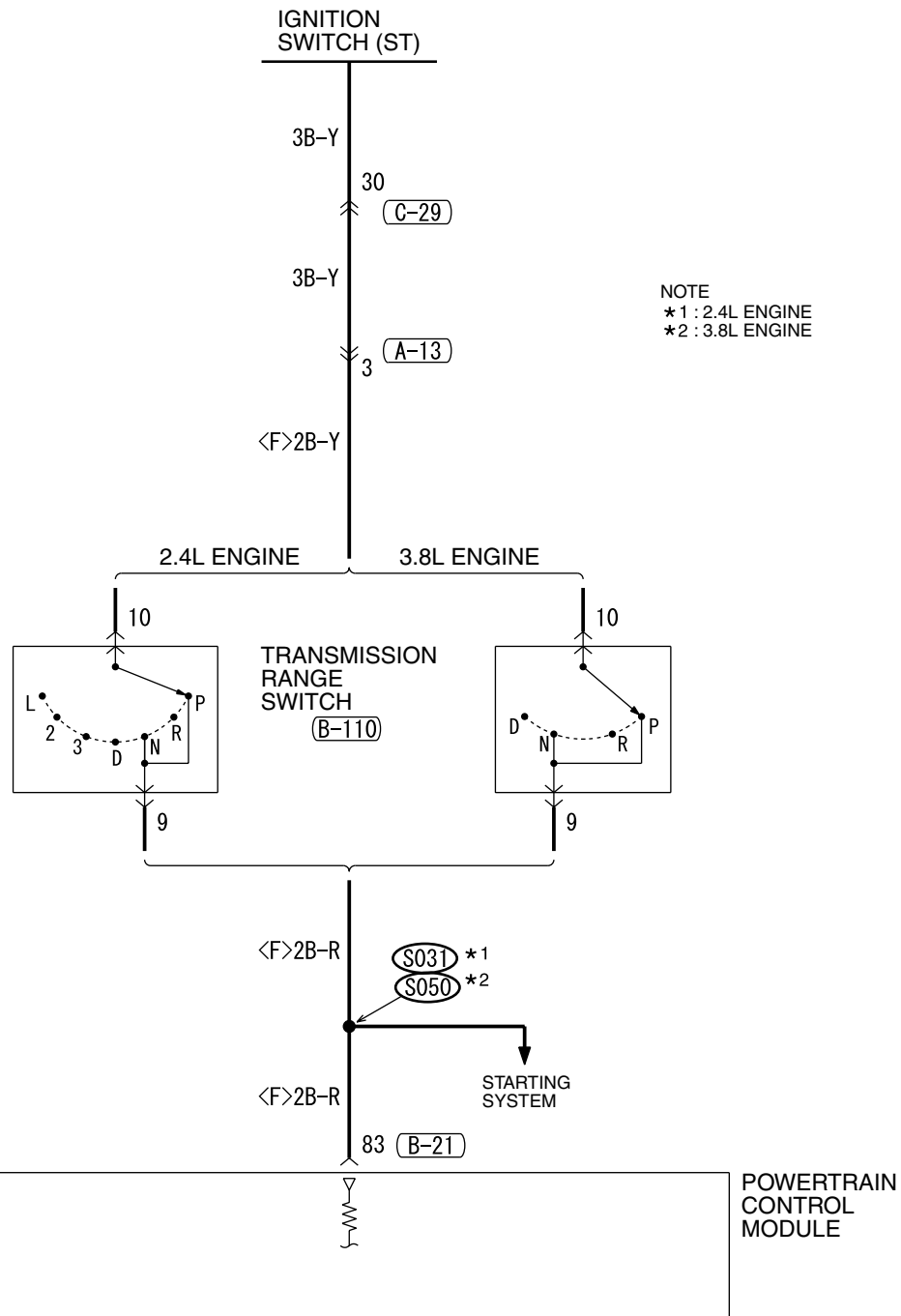

WIRE COLOR CODE  
 B : BLACK LG : LIGHT GREEN G : GREEN L : BLUE W : WHITE Y : YELLOW  
 SB : SKY BLUE BR : BROWN O : ORANGE GR : GRAY R : RED P : PINK V : VIOLET

H5P15M01CB

TSB Revision

AUTO-CRUISE CONTROL SYSTEM (CONTINUED)

7

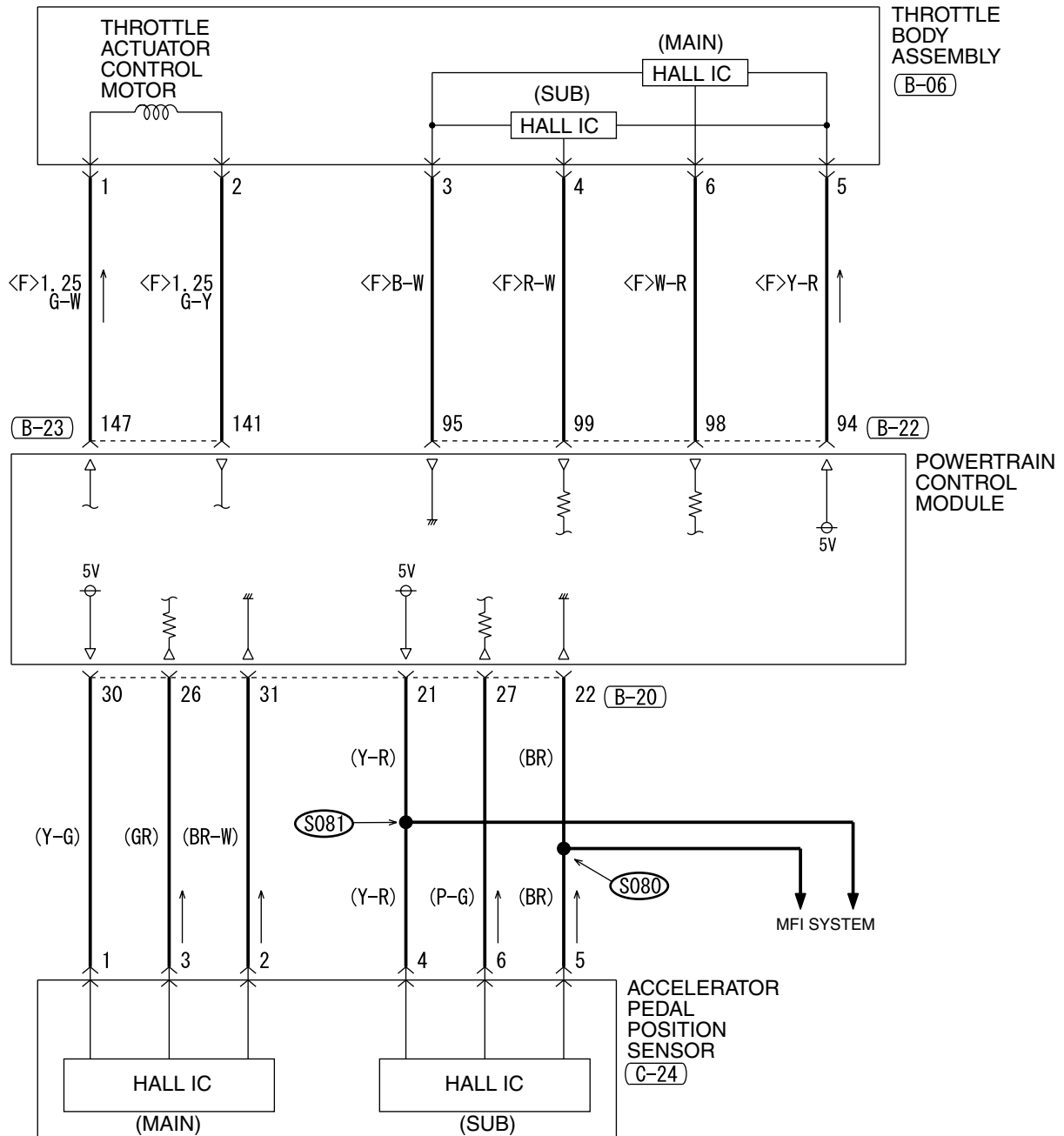

(B-06)

(B-19)

(B-20)

(B-22)

(B-23)

(C-24)

(C-29)

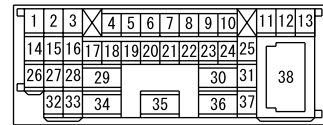
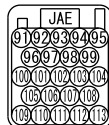
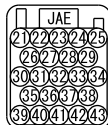
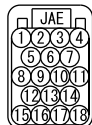

8

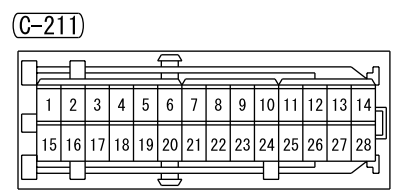
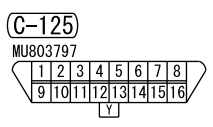
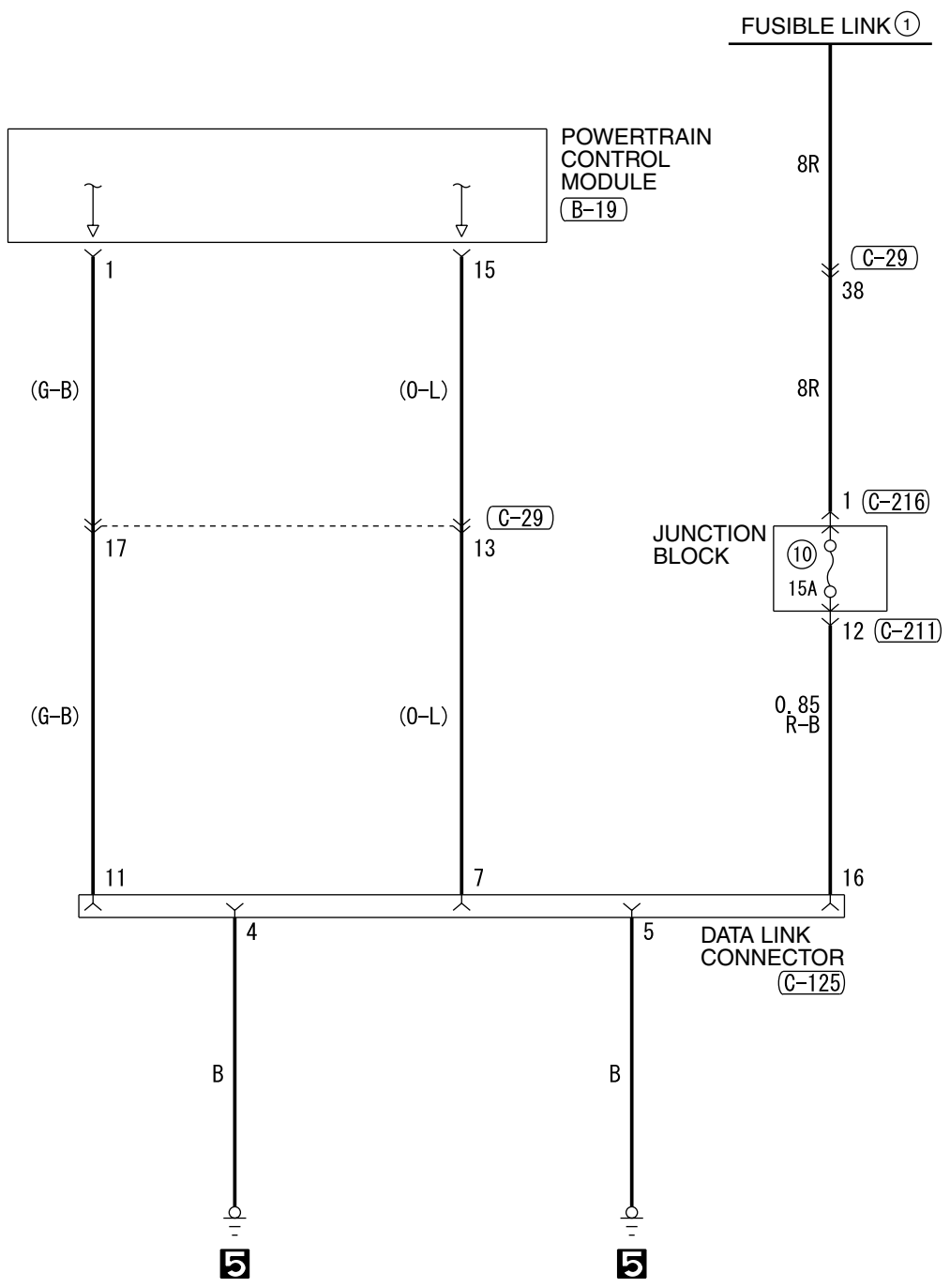

WIRE COLOR CODE  
 B : BLACK SB : SKY BLUE  
 BR : BROWN LG : LIGHT GREEN  
 G : GREEN P : PINK GR : GRAY  
 R : RED L : BLUE Y : YELLOW  
 V : VIOLET W : WHITE O : ORANGE

TSB Revision

# ELECTRONIC BRAKE-FORCE DISTRIBUTION (EBD) AND ANTI-LOCK BRAKING SYSTEM (ABS) <VEHICLES WITHOUT TRACTION CONTROL (TCL)>

M1901017100182

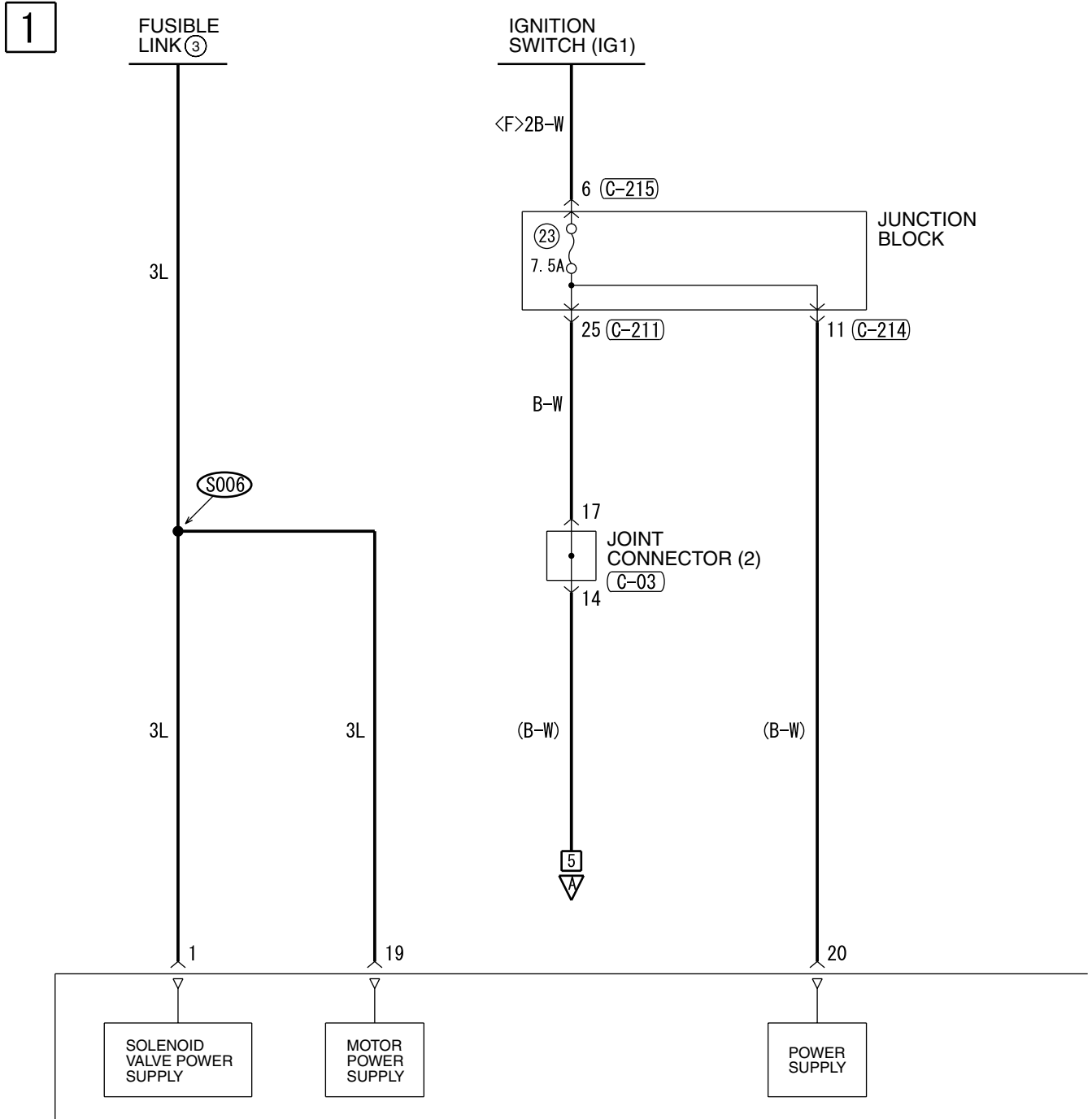

(A-02)

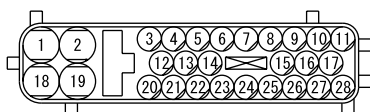

(C-01)



(C-03)

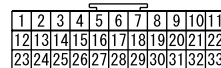

(C-29)

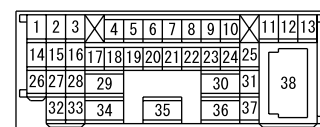

(C-30)





2

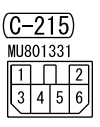
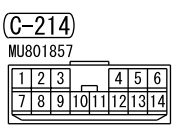
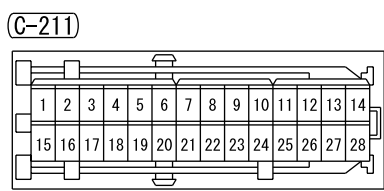
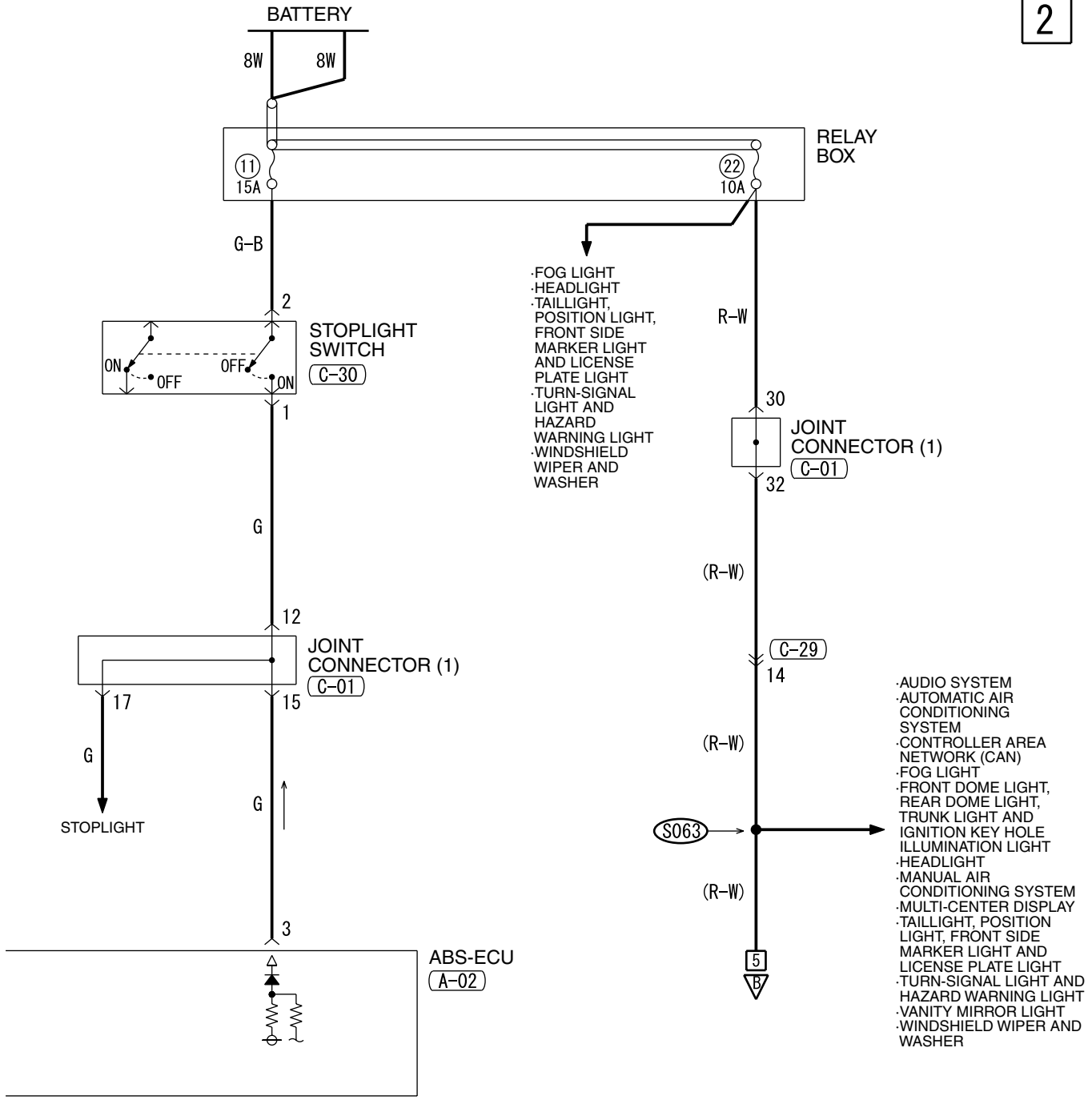

WIRE COLOR CODE  
 B : BLACK LG : LIGHT GREEN G : GREEN L : BLUE  
 BR : BROWN O : ORANGE GR : GRAY R : RED W : WHITE  
 SB : SKY BLUE P : PINK Y : YELLOW V : VIOLET

H5P15M02AB

ELECTRONIC BRAKE-FORCE DISTRIBUTION (EBD) AND ANTI-LOCK BRAKING SYSTEM (ABS) <VEHICLES WITHOUT TRACTION CONTROL (TCL)> (CONTINUED)

3

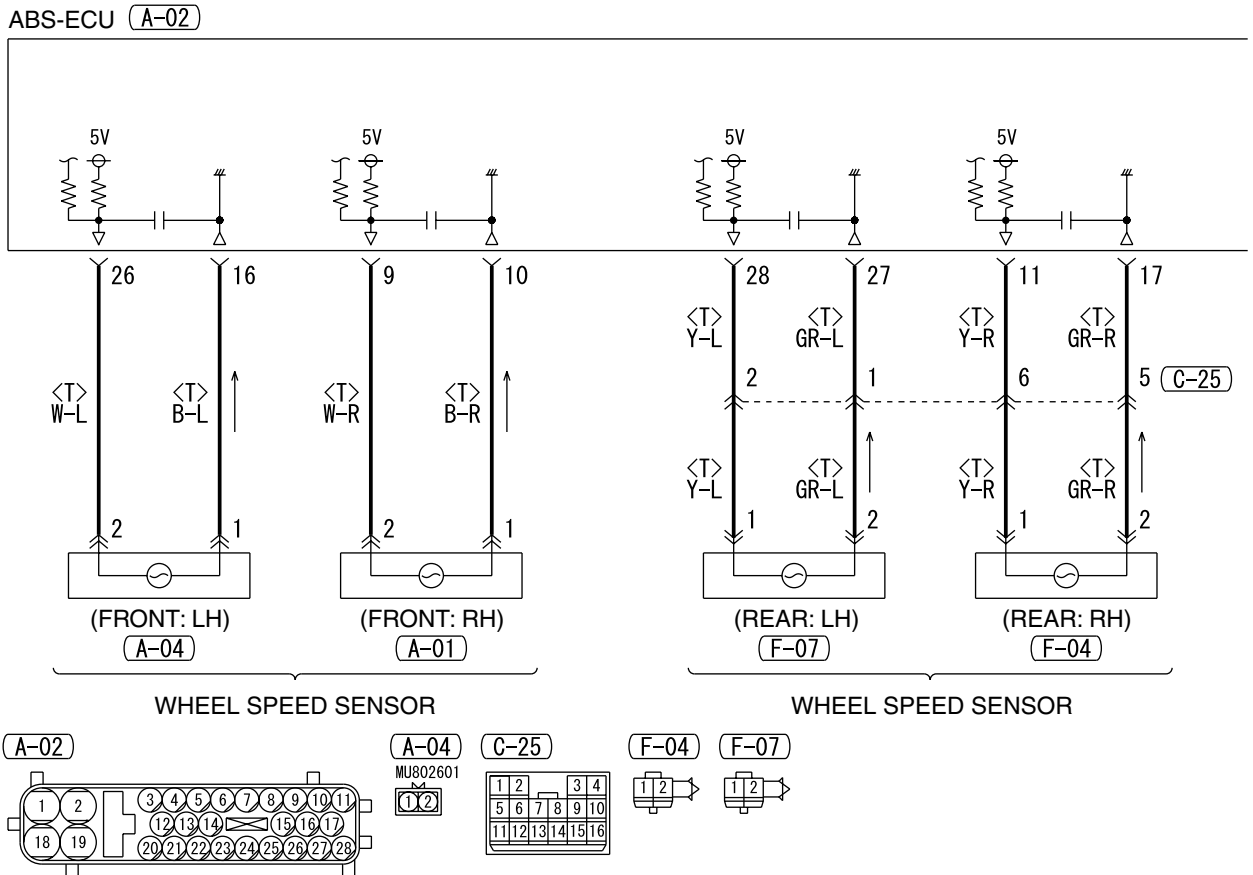

4

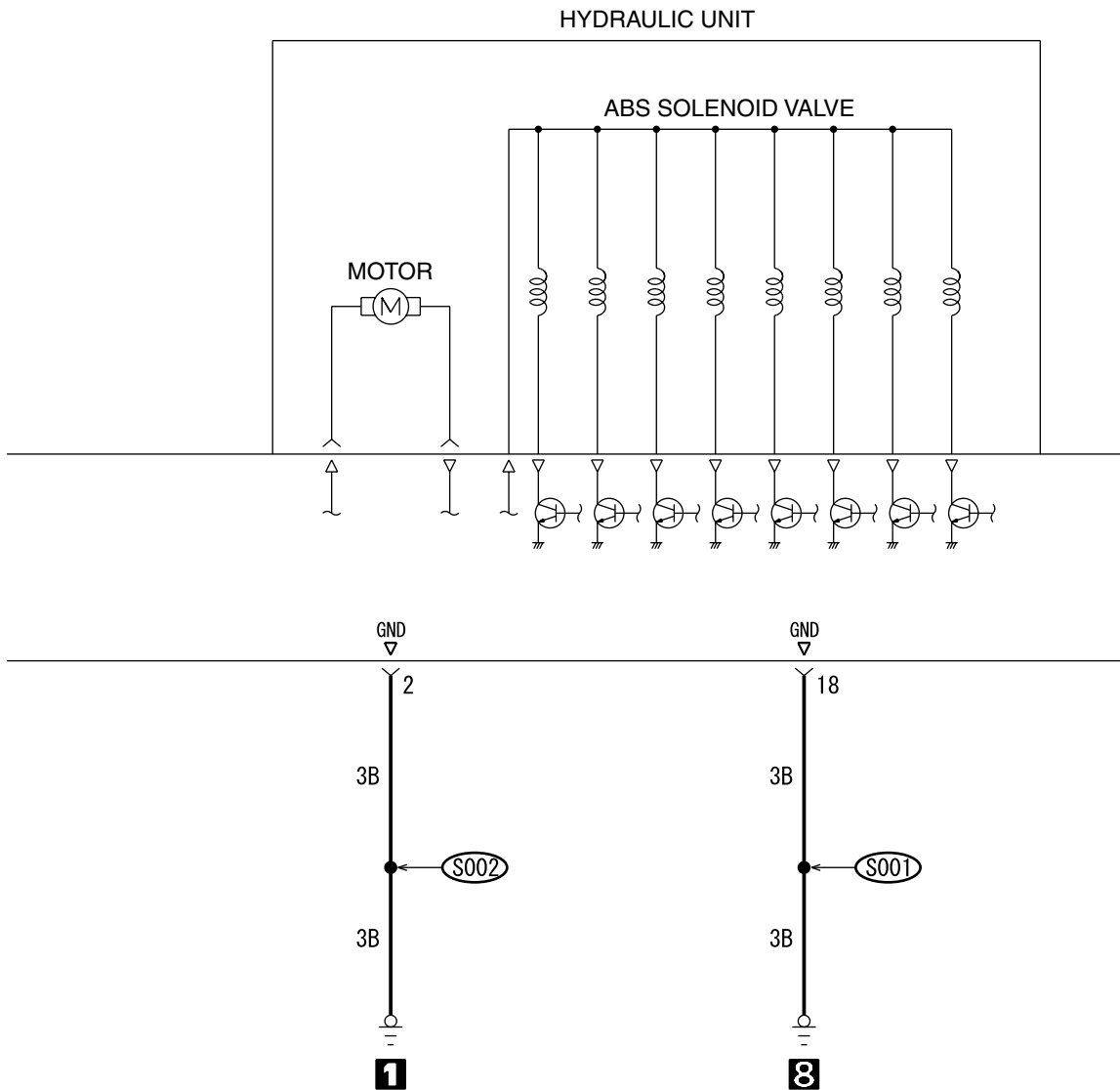

WIRE COLOR CODE  
 B : BLACK LG : LIGHT GREEN G : GREEN L : BLUE W : WHITE Y : YELLOW  
 SB : SKY BLUE BR : BROWN O : ORANGE GR : GRAY R : RED P : PINK V : VIOLET

H5P15M02BB

TSB Revision

ELECTRONIC BRAKE-FORCE DISTRIBUTION (EBD) AND ANTI-LOCK BRAKING SYSTEM (ABS) <VEHICLES WITHOUT TRACTION CONTROL (TCL)> (CONTINUED)

5

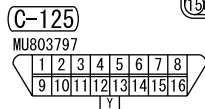
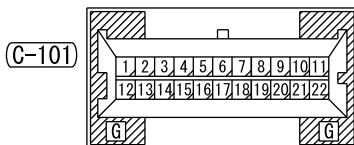
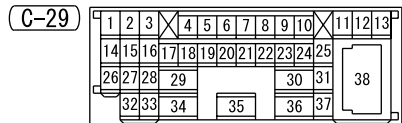
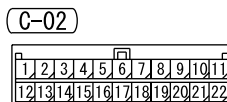
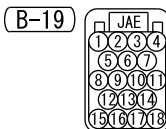
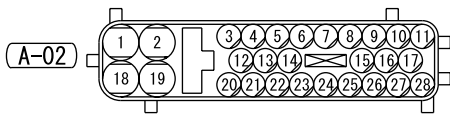
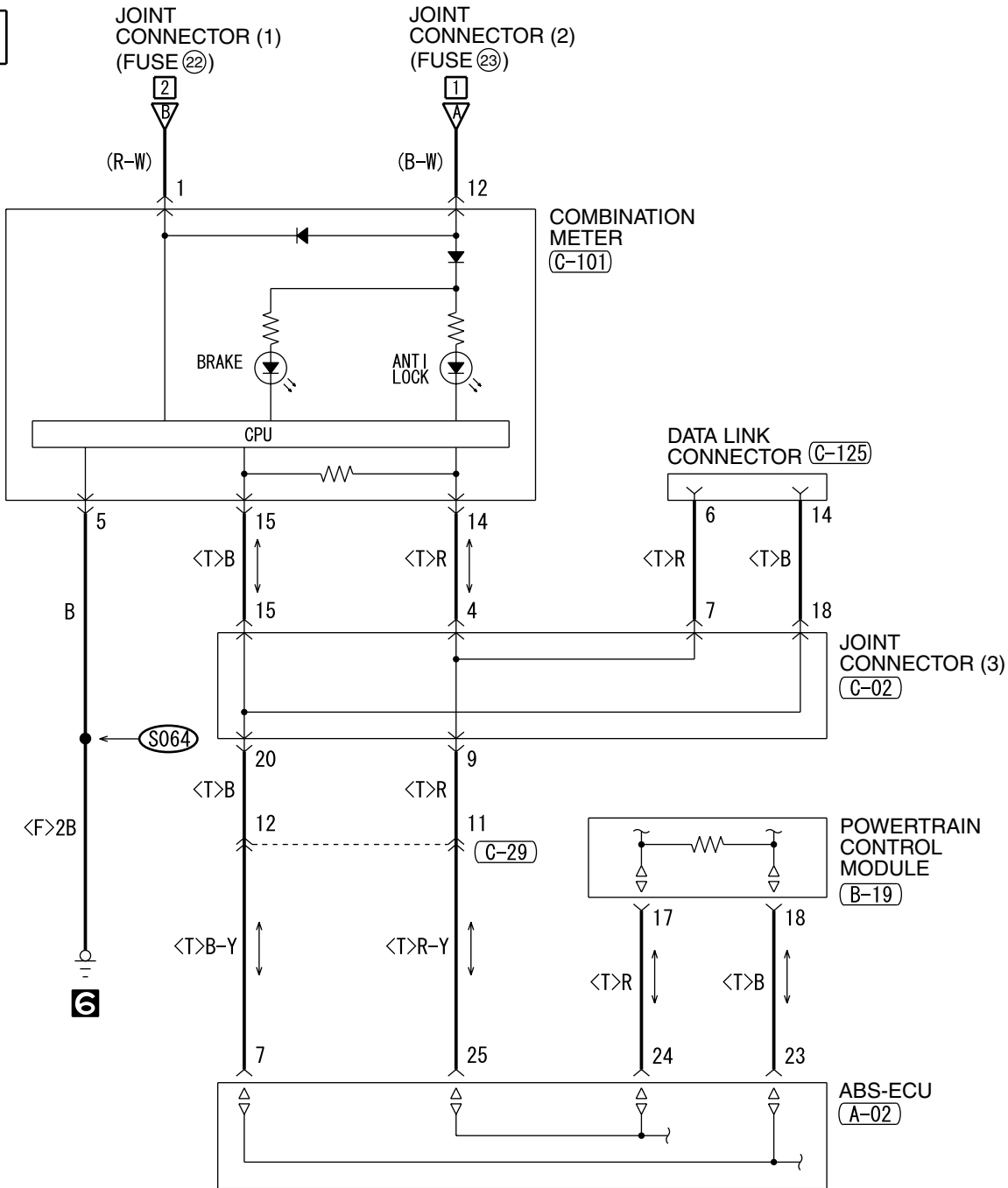

**NOTES**

# ELECTRONIC BRAKE-FORCE DISTRIBUTION (EBD) AND ANTI-LOCK BRAKING SYSTEM (ABS) <VEHICLES WITH TRACTION CONTROL (TCL)>

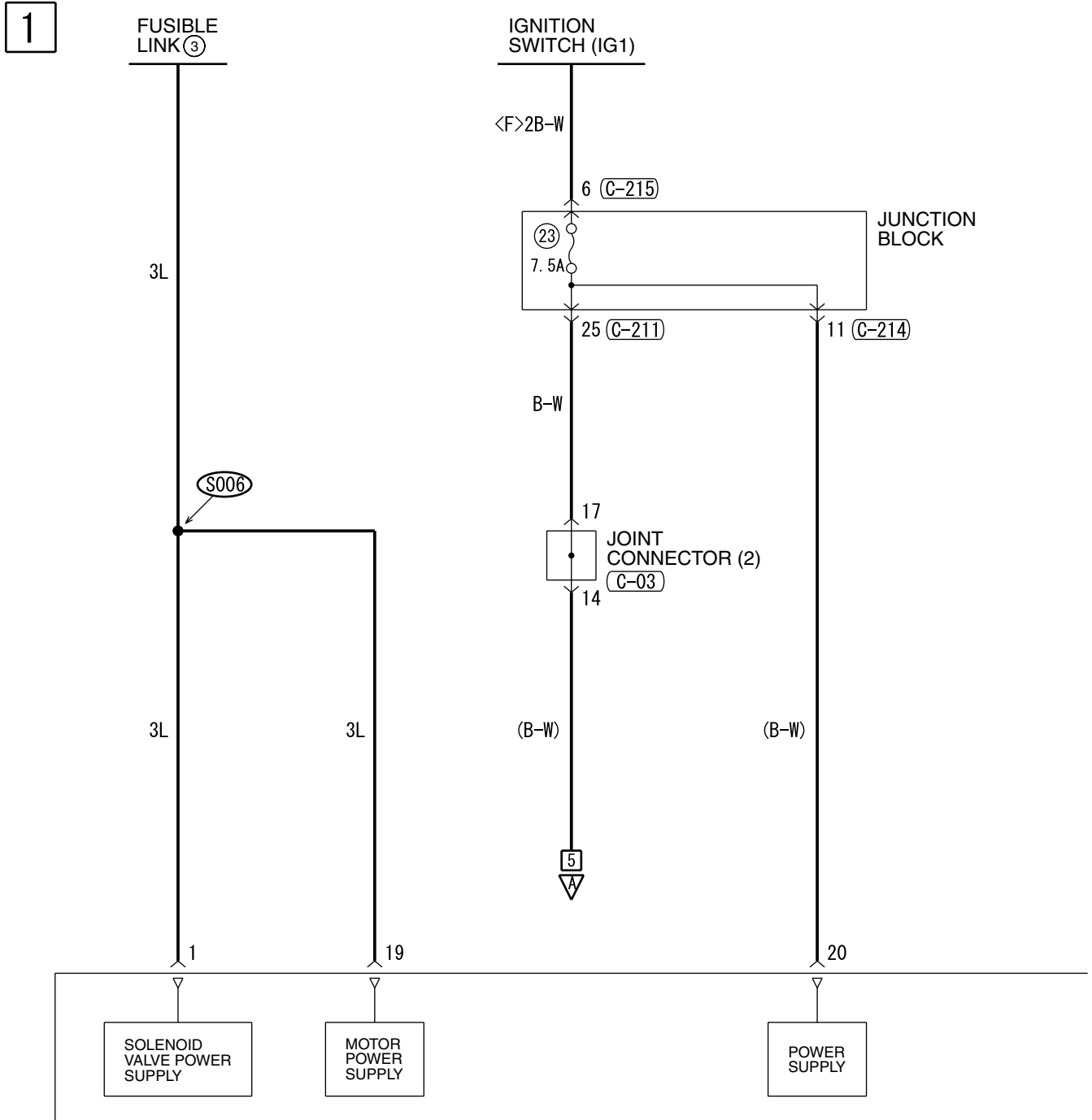

(A-02)

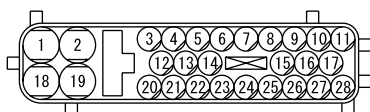

(C-01)

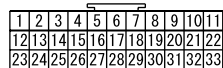

(C-03)

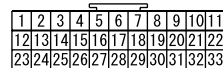

(C-29)

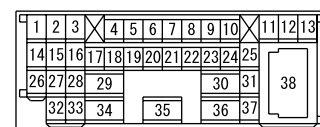

2

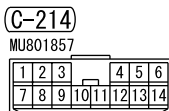
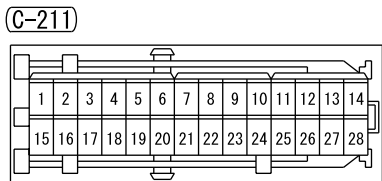
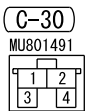
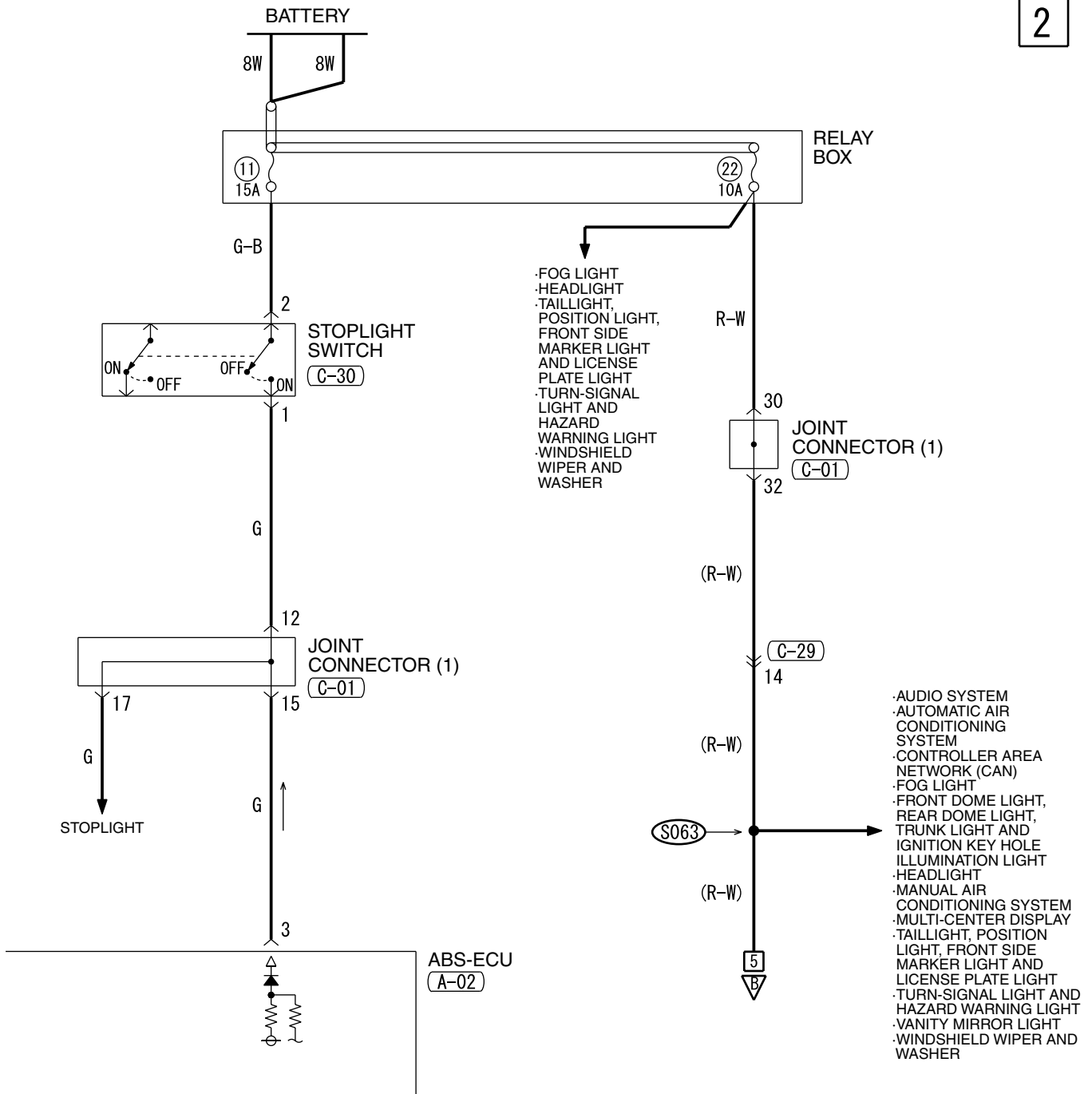

WIRE COLOR CODE  
 B : BLACK SB : SKY BLUE  
 BR : BROWN LG : LIGHT GREEN  
 G : GREEN P : PINK GR : GRAY  
 R : RED L : BLUE Y : YELLOW  
 V : VIOLET W : WHITE O : ORANGE

H5P15M03AB

ELECTRONIC BRAKE-FORCE DISTRIBUTION (EBD) AND ANTI-LOCK BRAKING SYSTEM (ABS) <VEHICLES WITH TRACTION CONTROL (TCL)> (CONTINUED)

3

ABS-ECU (A-02)

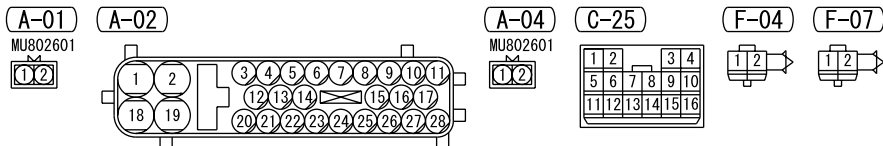
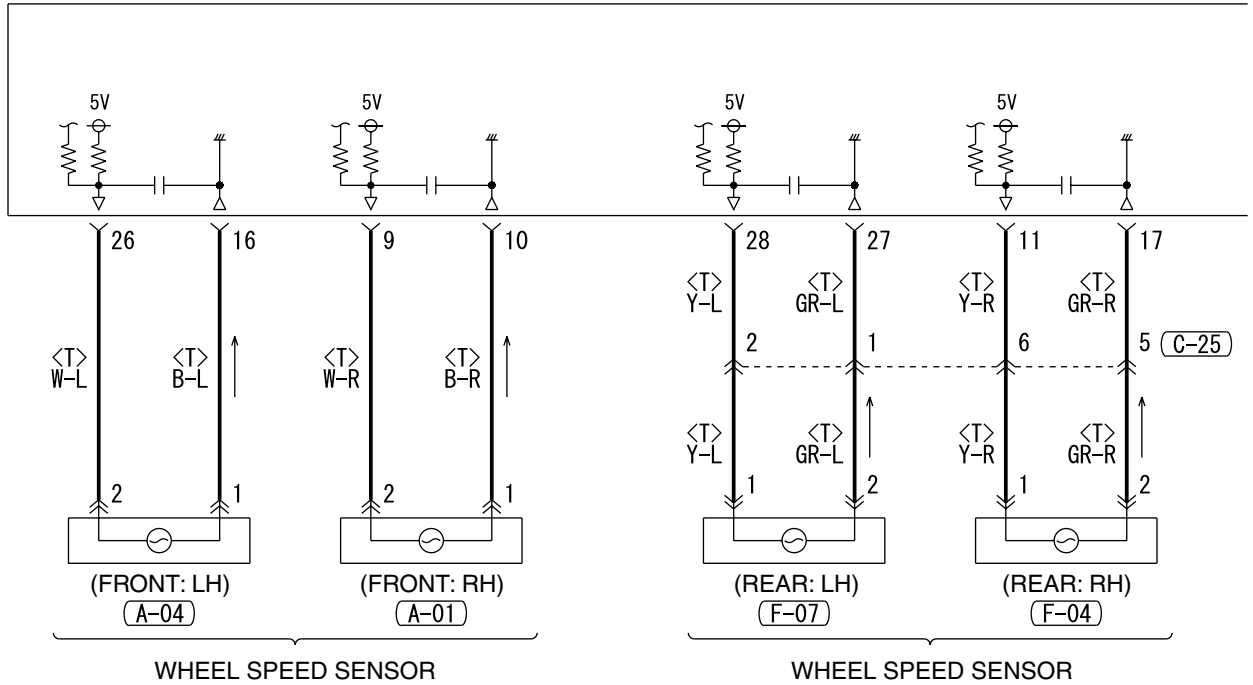



4

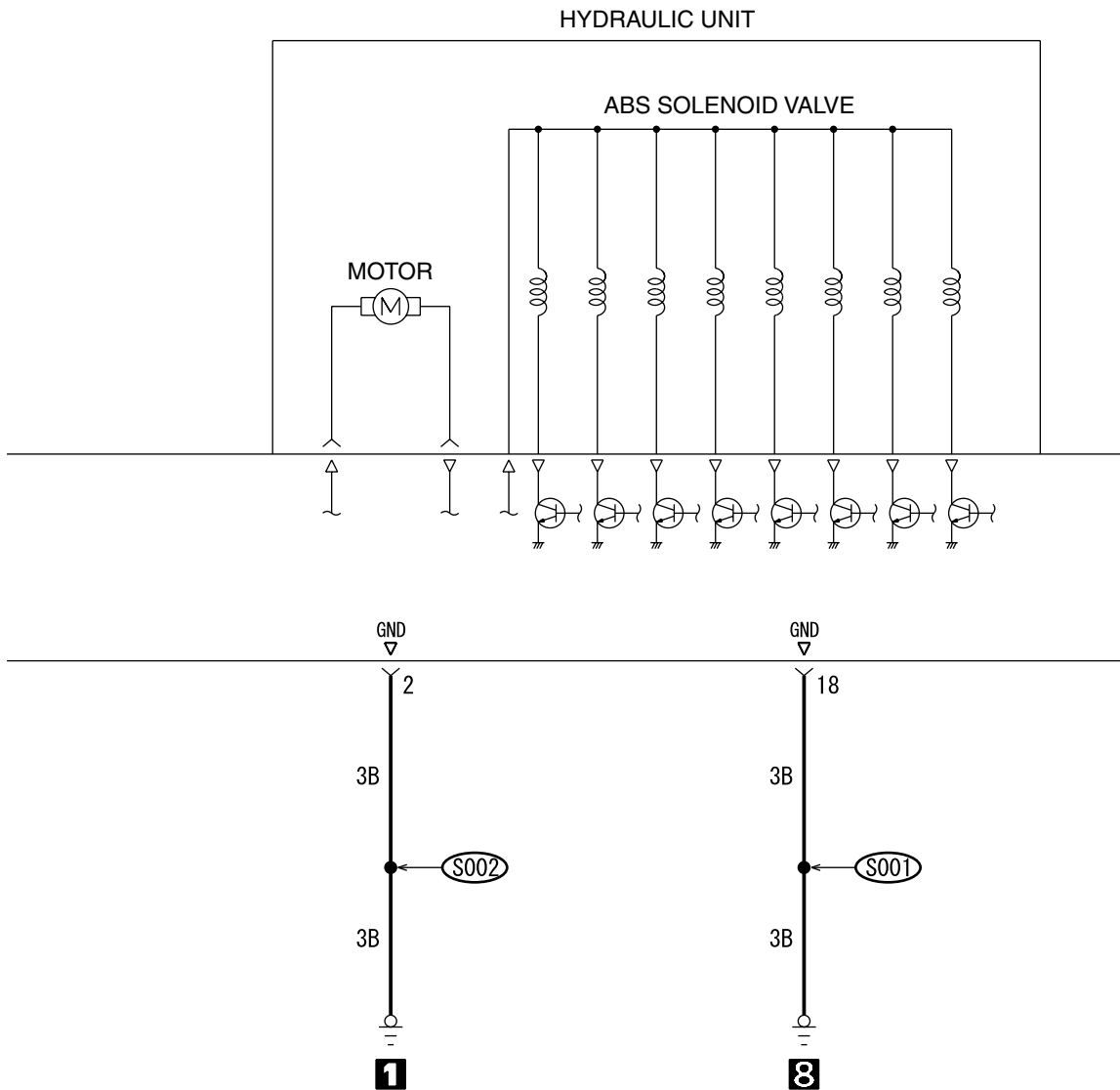

WIRE COLOR CODE  
 B : BLACK LG : LIGHT GREEN G : GREEN L : BLUE W : WHITE Y : YELLOW  
 SB : SKY BLUE BR : BROWN O : ORANGE GR : GRAY R : RED P : PINK V : VIOLET

H5P15M03BB

TSB Revision

ELECTRONIC BRAKE-FORCE DISTRIBUTION (EBD) AND ANTI-LOCK BRAKING SYSTEM (ABS) <VEHICLES WITH TRACTION CONTROL (TCL)> (CONTINUED)

5

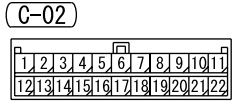
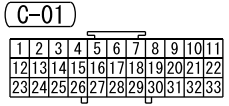
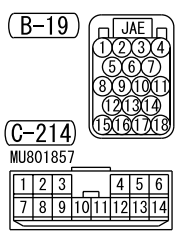
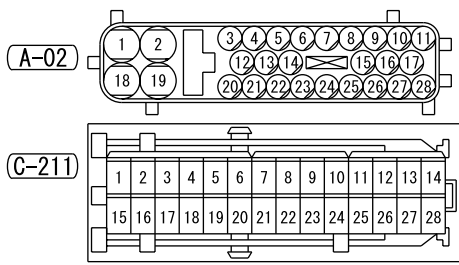
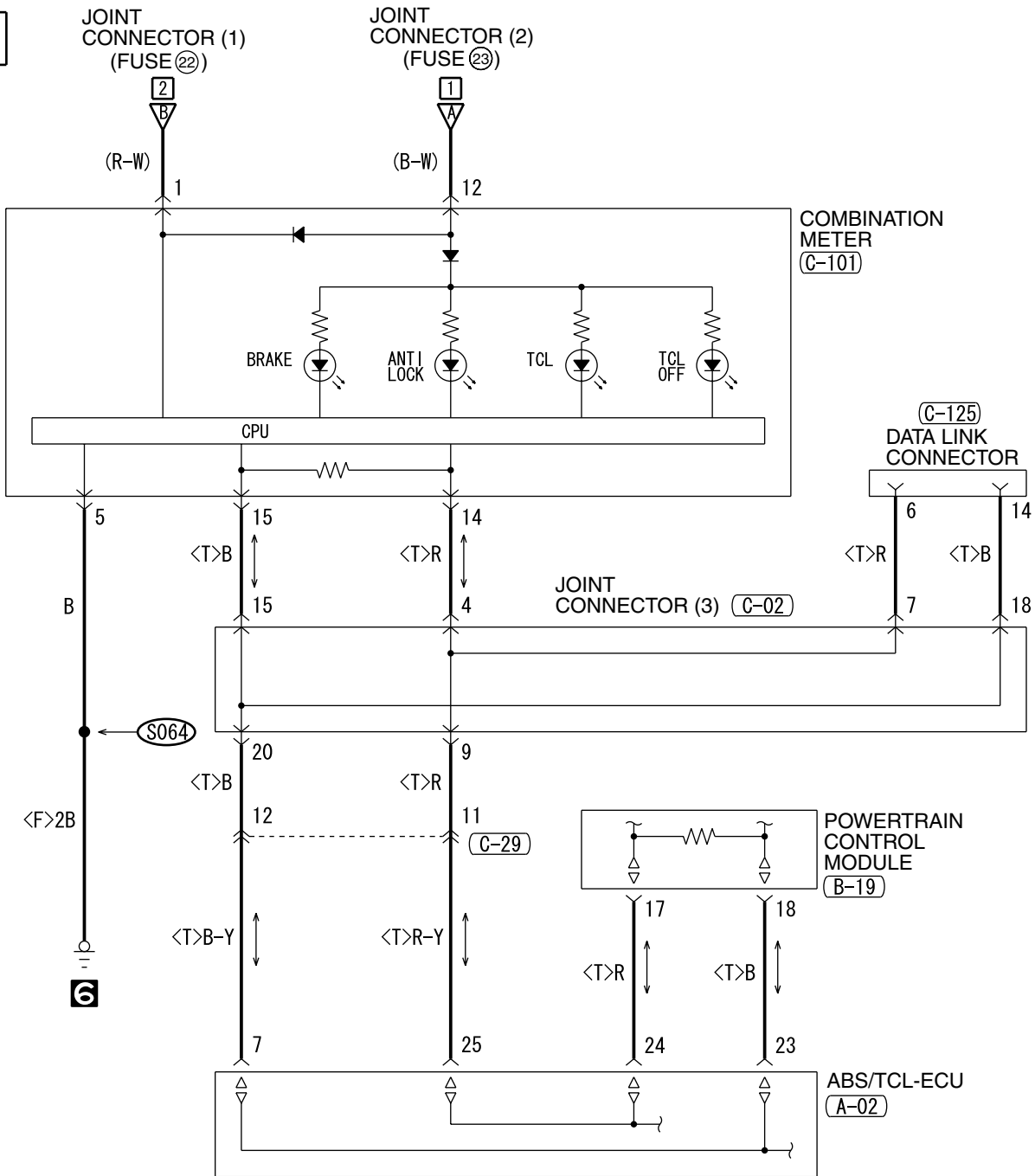

6

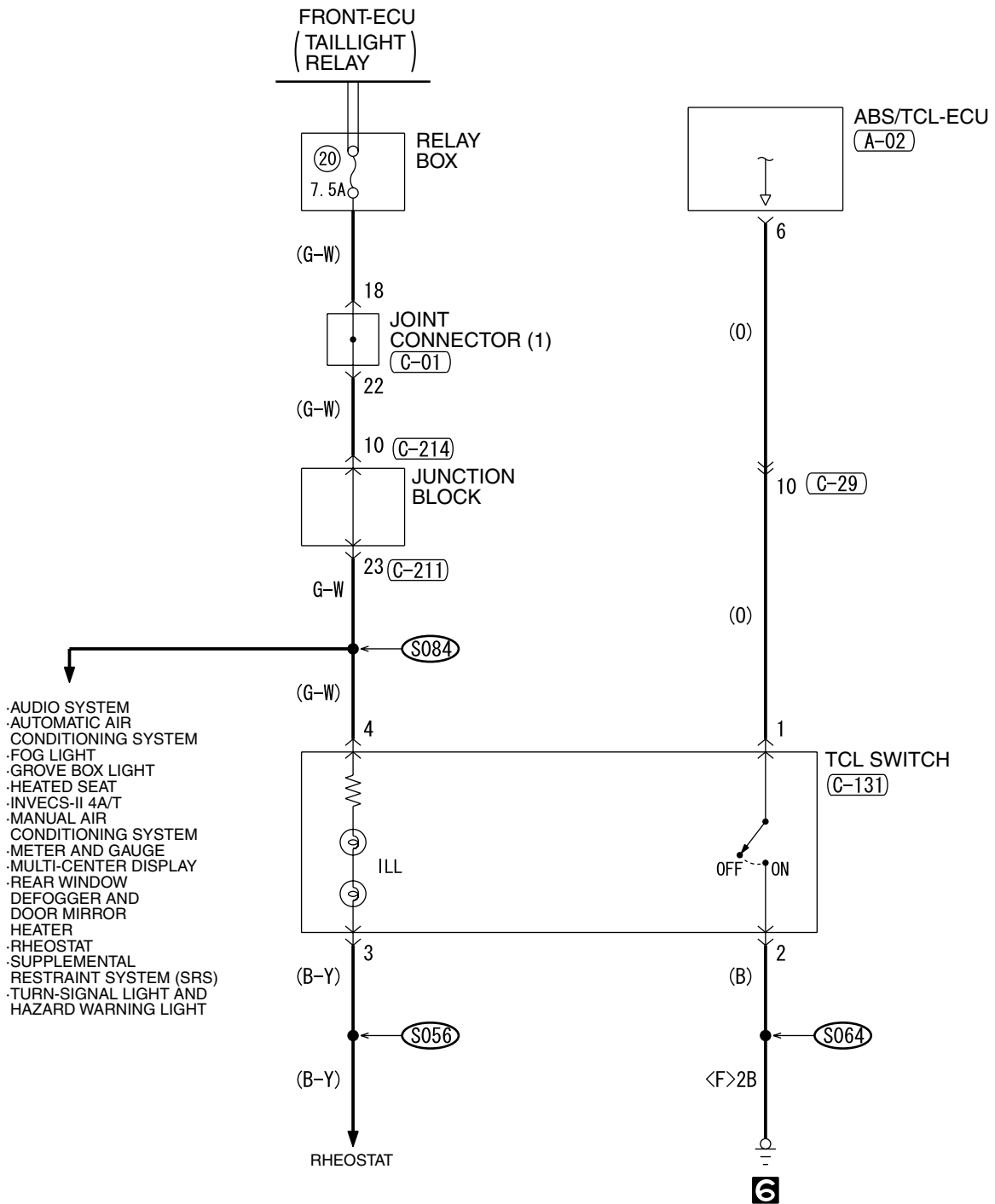

(C-29)

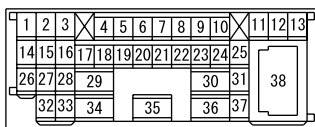

(C-101)

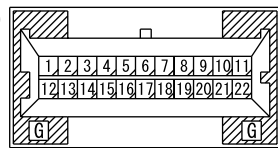

(C-125)

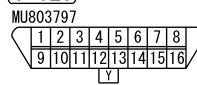

(C-131)

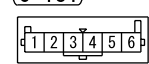

# SUPPLEMENTAL RESTRAINT SYSTEM (SRS)

M1901009701319

1

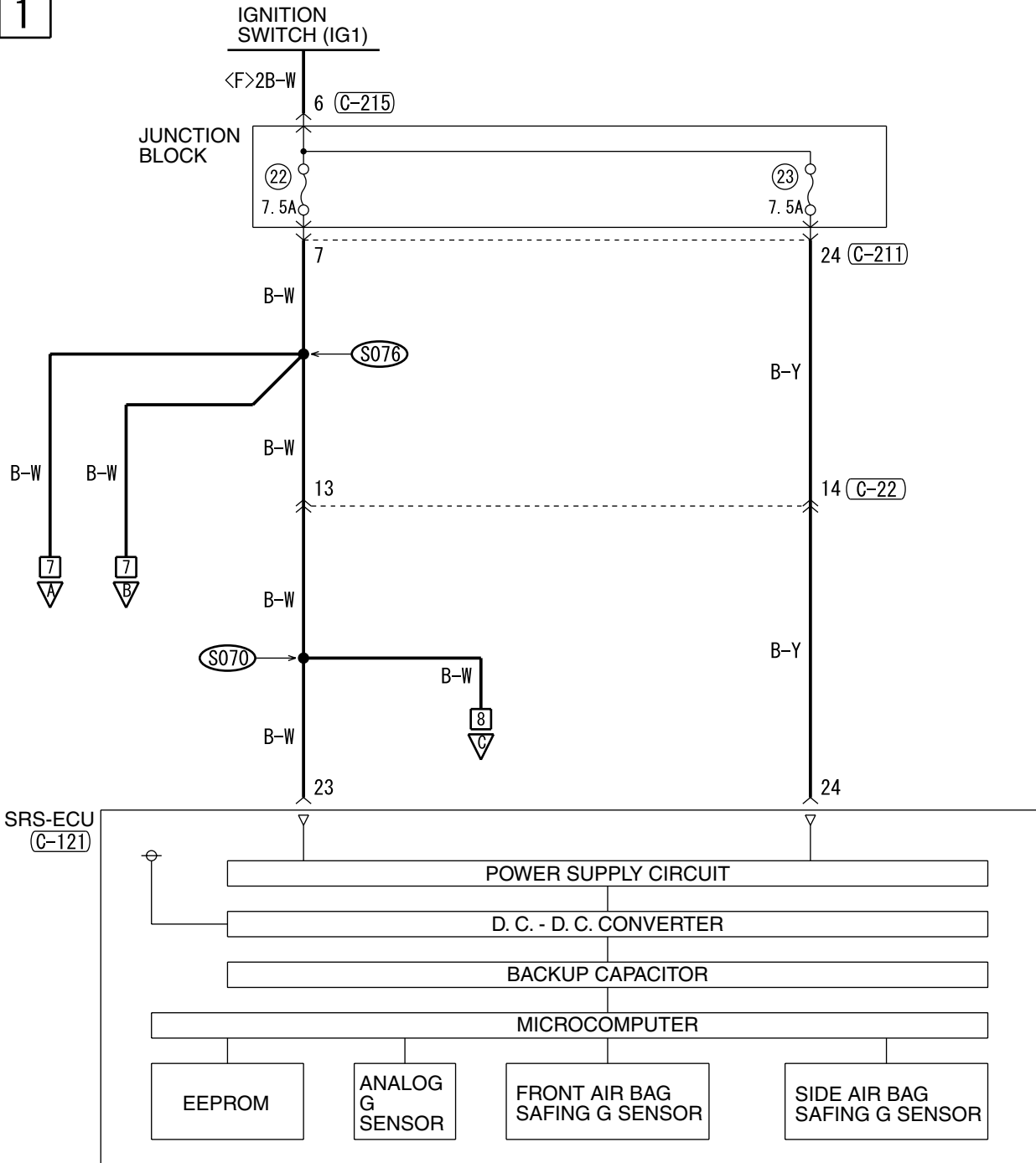

(C-22)

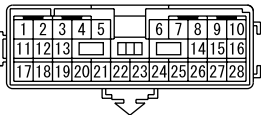

(C-120)

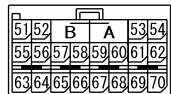

(C-121)

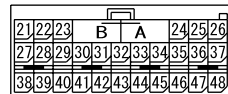

(C-122)

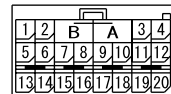

(C-211)

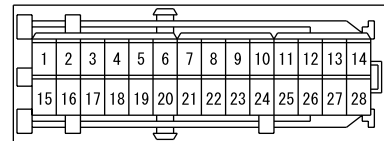

2

NOTE  
CONNECTOR LOCK SWITCH  
(CONNECTOR COUPLED: ON  
CONNECTOR UNCOUPLED: OFF)  
\*: CONNECTOR LOCK SWITCH

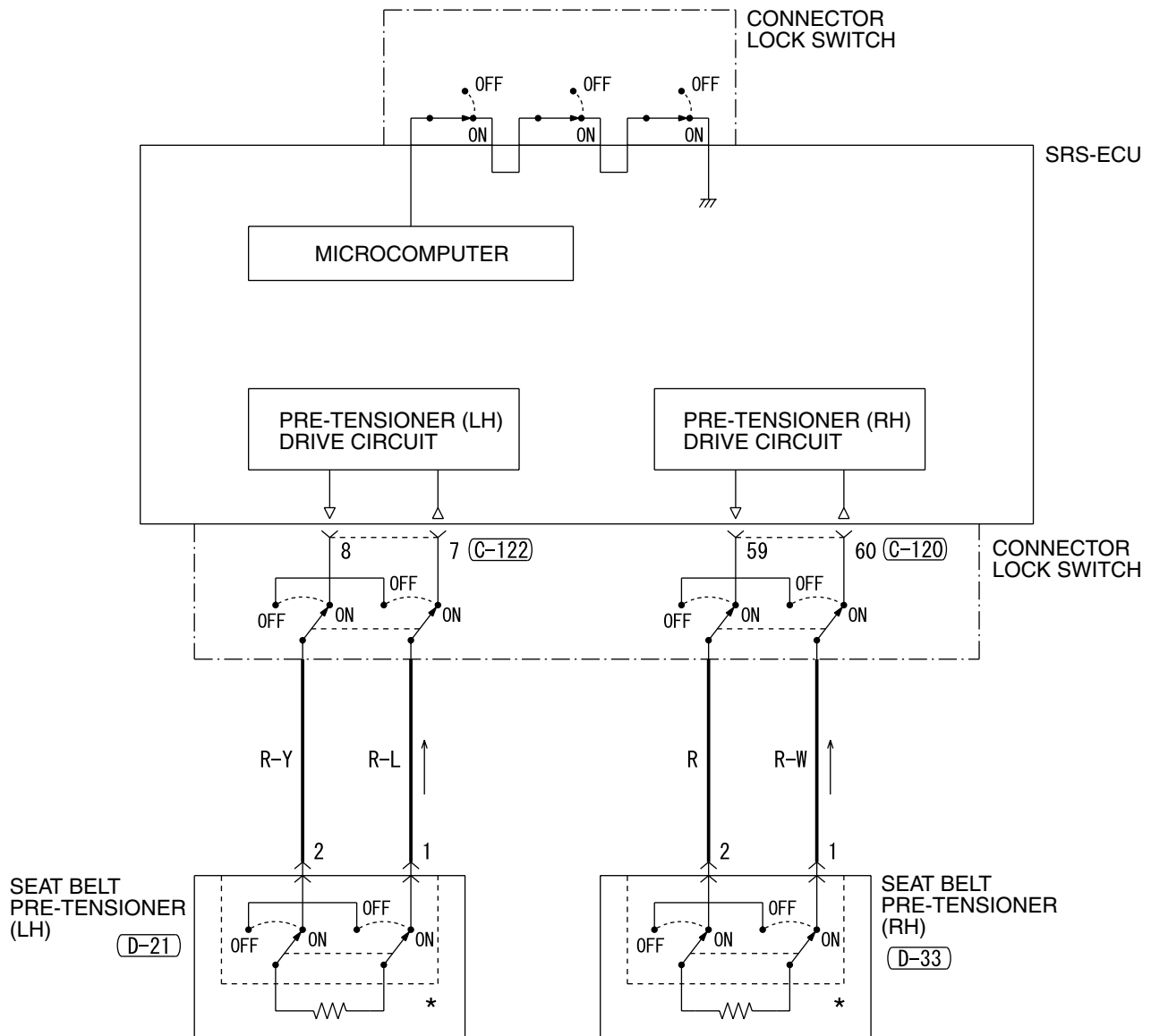

C-215 D-21 D-33



WIRE COLOR CODE  
B: BLACK LG: LIGHT GREEN G: GREEN L: BLUE W: WHITE Y: YELLOW  
SB: SKY BLUE BR: BROWN O: ORANGE GR: GRAY R: RED P: PINK V: VIOLET

H5P15M04AB

TSB Revision

SUPPLEMENTAL RESTRAINT SYSTEM (SRS) (CONTINUED)

3

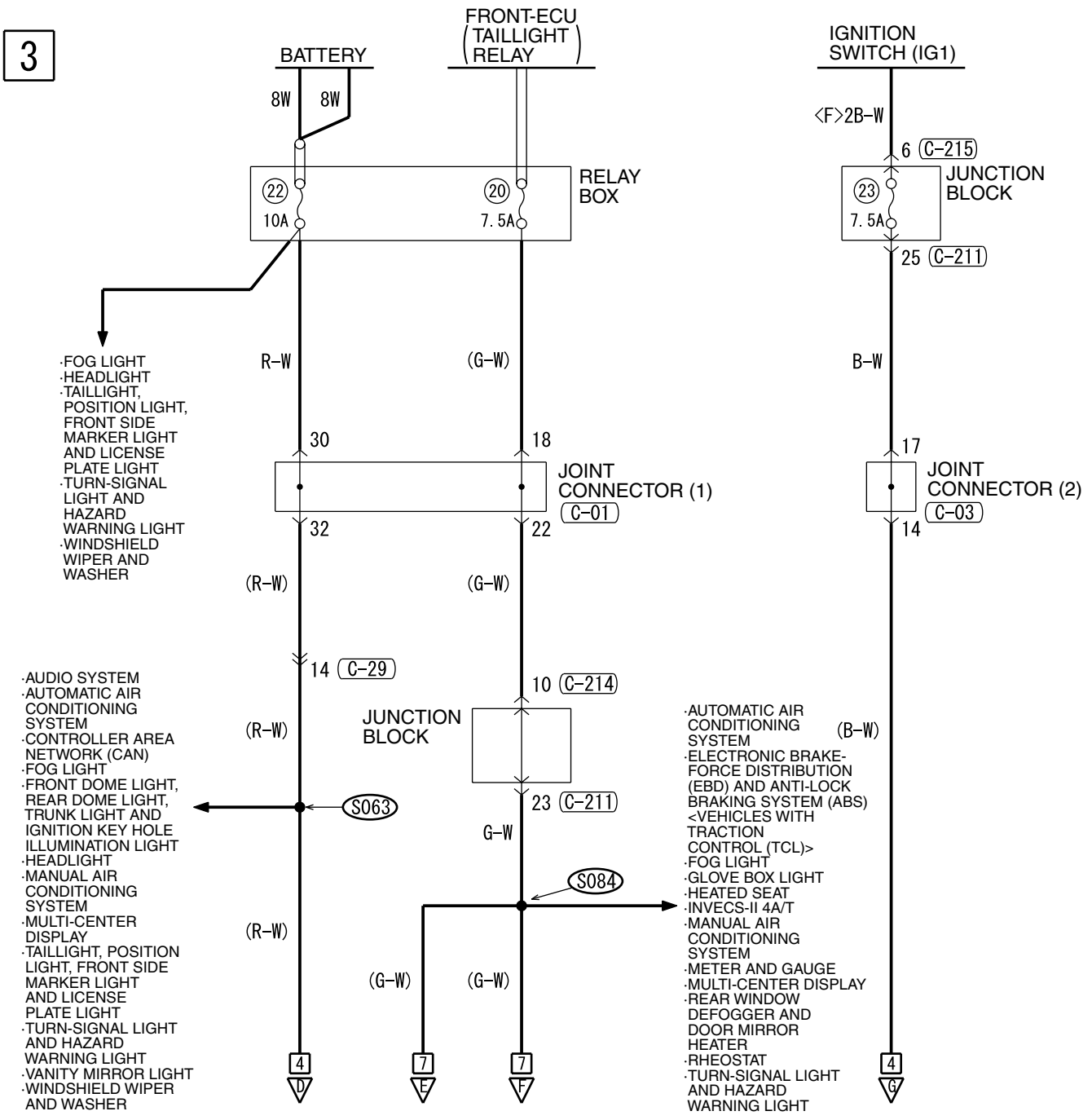

- FOG LIGHT
- HEADLIGHT
- TAILLIGHT, POSITION LIGHT, FRONT SIDE MARKER LIGHT AND LICENSE PLATE LIGHT
- TURN-SIGNAL LIGHT AND HAZARD WARNING LIGHT
- WINDSHIELD WIPER AND WASHER

- AUDIO SYSTEM
- AUTOMATIC AIR CONDITIONING SYSTEM
- CONTROLLER AREA NETWORK (CAN)
- FOG LIGHT
- FRONT DOME LIGHT, REAR DOME LIGHT, TRUNK LIGHT AND IGNITION KEY HOLE ILLUMINATION LIGHT
- HEADLIGHT
- MANUAL AIR CONDITIONING SYSTEM
- MULTI-CENTER DISPLAY
- TAILLIGHT, POSITION LIGHT, FRONT SIDE MARKER LIGHT AND LICENSE PLATE LIGHT
- TURN-SIGNAL LIGHT AND HAZARD WARNING LIGHT
- VANITY MIRROR LIGHT
- WINDSHIELD WIPER AND WASHER

- AUTOMATIC AIR CONDITIONING SYSTEM
- ELECTRONIC BRAKE-FORCE DISTRIBUTION (EBD) AND ANTI-LOCK BRAKING SYSTEM (ABS) <VEHICLES WITH TRACTION CONTROL (TCL)>
- FOG LIGHT
- GLOVE BOX LIGHT
- HEATED SEAT
- INVECS-II 4A/T
- MANUAL AIR CONDITIONING SYSTEM
- METER AND GAUGE
- MULTI-CENTER DISPLAY
- REAR WINDOW DEFOGGER AND DOOR MIRROR HEATER
- RHEOSTAT
- TURN-SIGNAL LIGHT AND HAZARD WARNING LIGHT

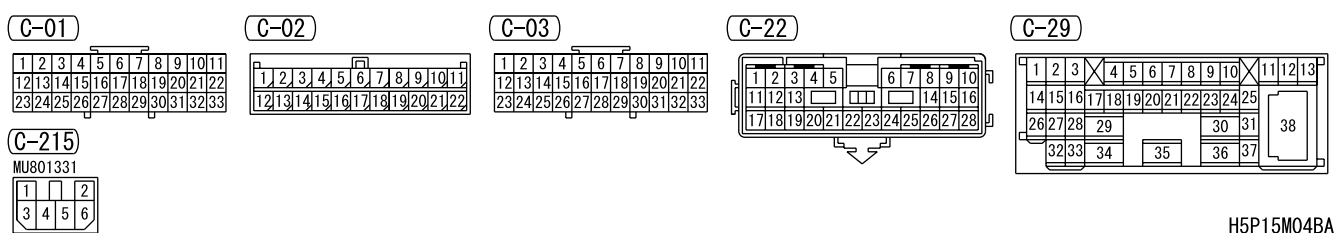

4

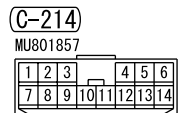
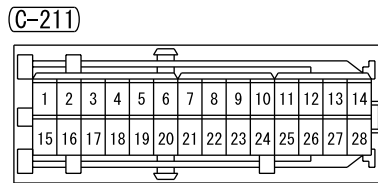
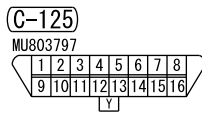
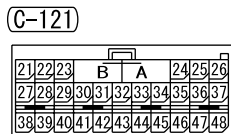
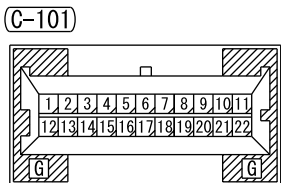
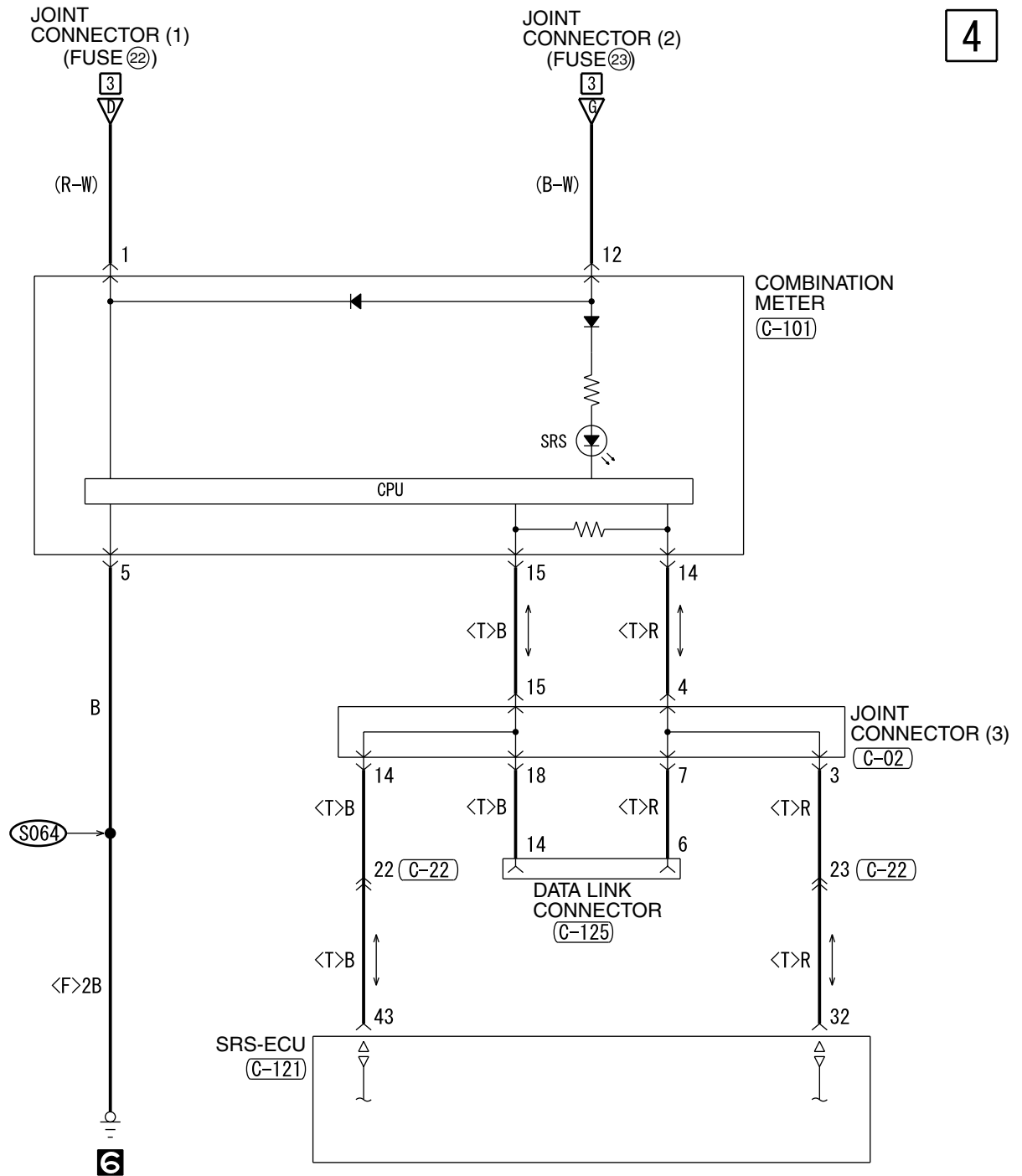

SUPPLEMENTAL RESTRAINT SYSTEM (SRS) (CONTINUED)

5

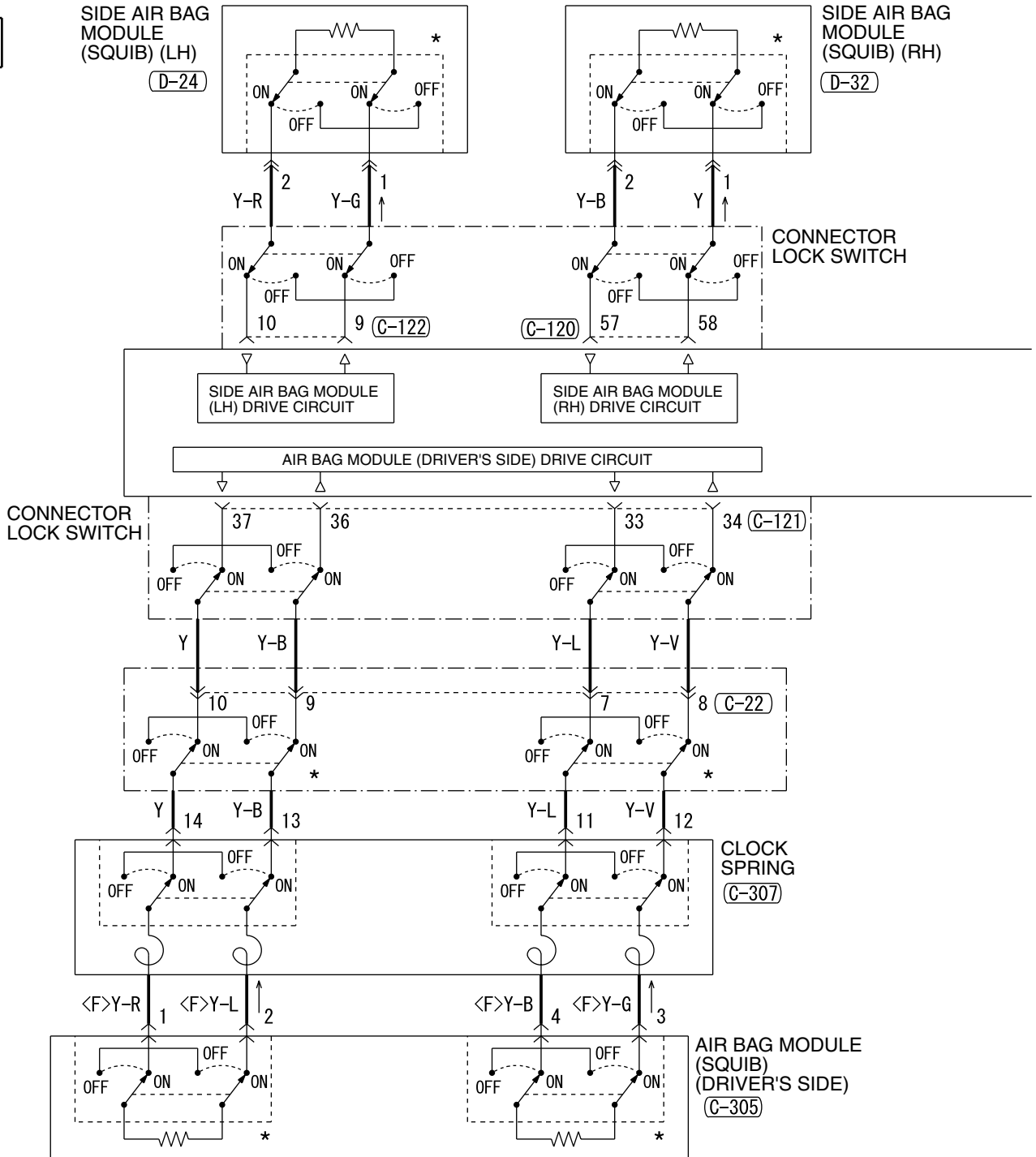

(C-22)

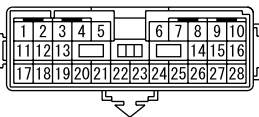

(C-110)

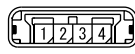

(C-120)

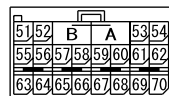

(C-121)

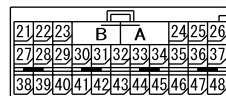

(C-122)

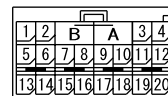

(C-305)

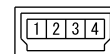

(C-307)

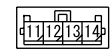



6

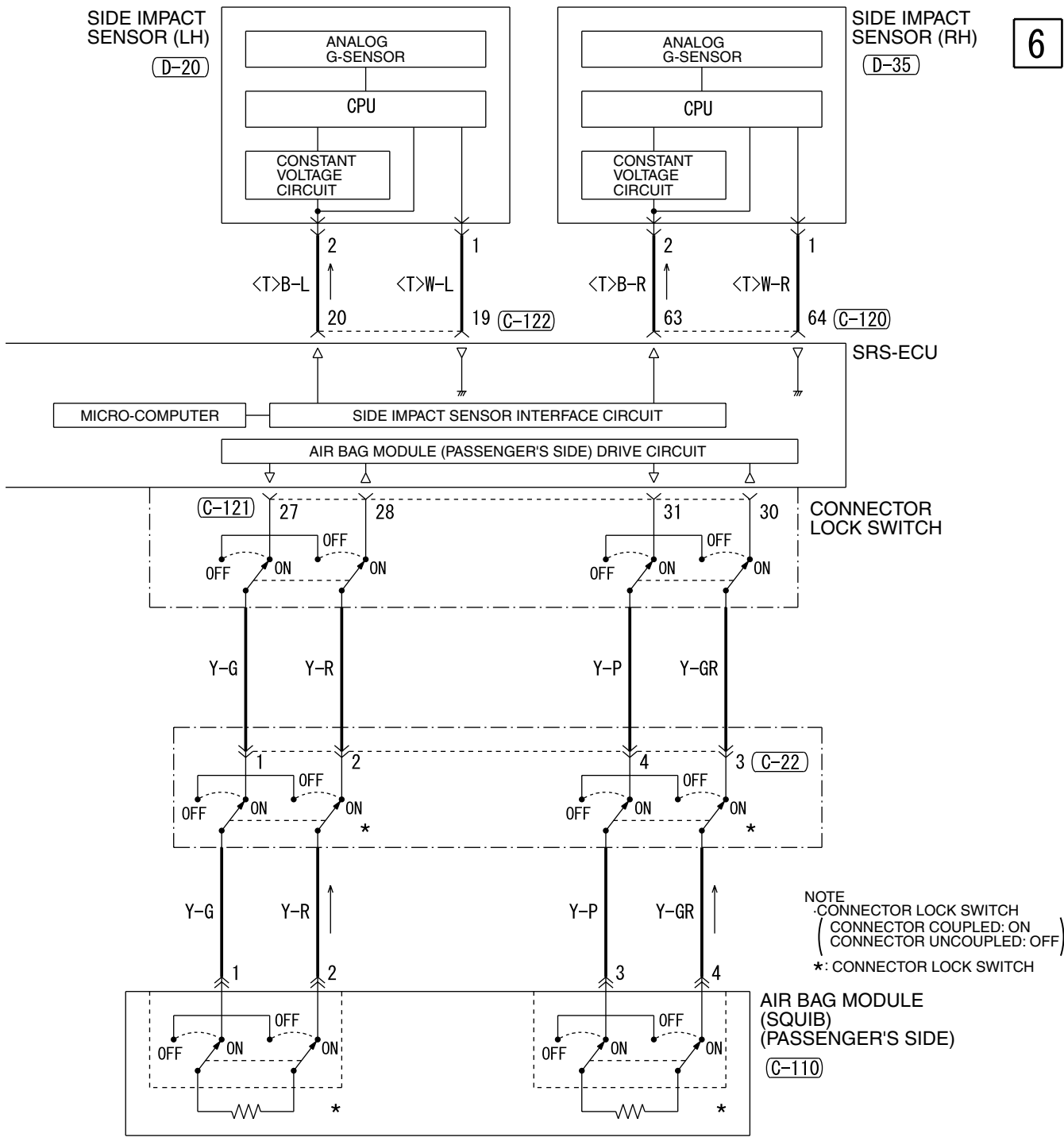

(D-20) (D-24) (D-32) (D-35)

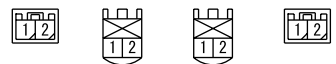

WIRE COLOR CODE  
 B: BLACK LG: LIGHT GREEN G: GREEN L: BLUE W: WHITE Y: YELLOW  
 SB: SKY BLUE BR: BROWN O: ORANGE GR: GRAY R: RED P: PINK V: VIOLET

H5P15M04CB

TSB Revision

SUPPLEMENTAL RESTRAINT SYSTEM (SRS) (CONTINUED)

7

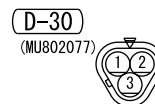
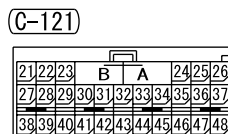
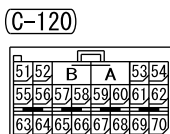
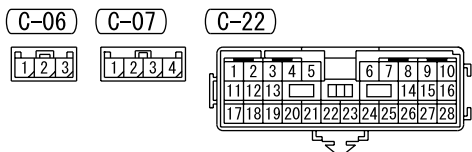
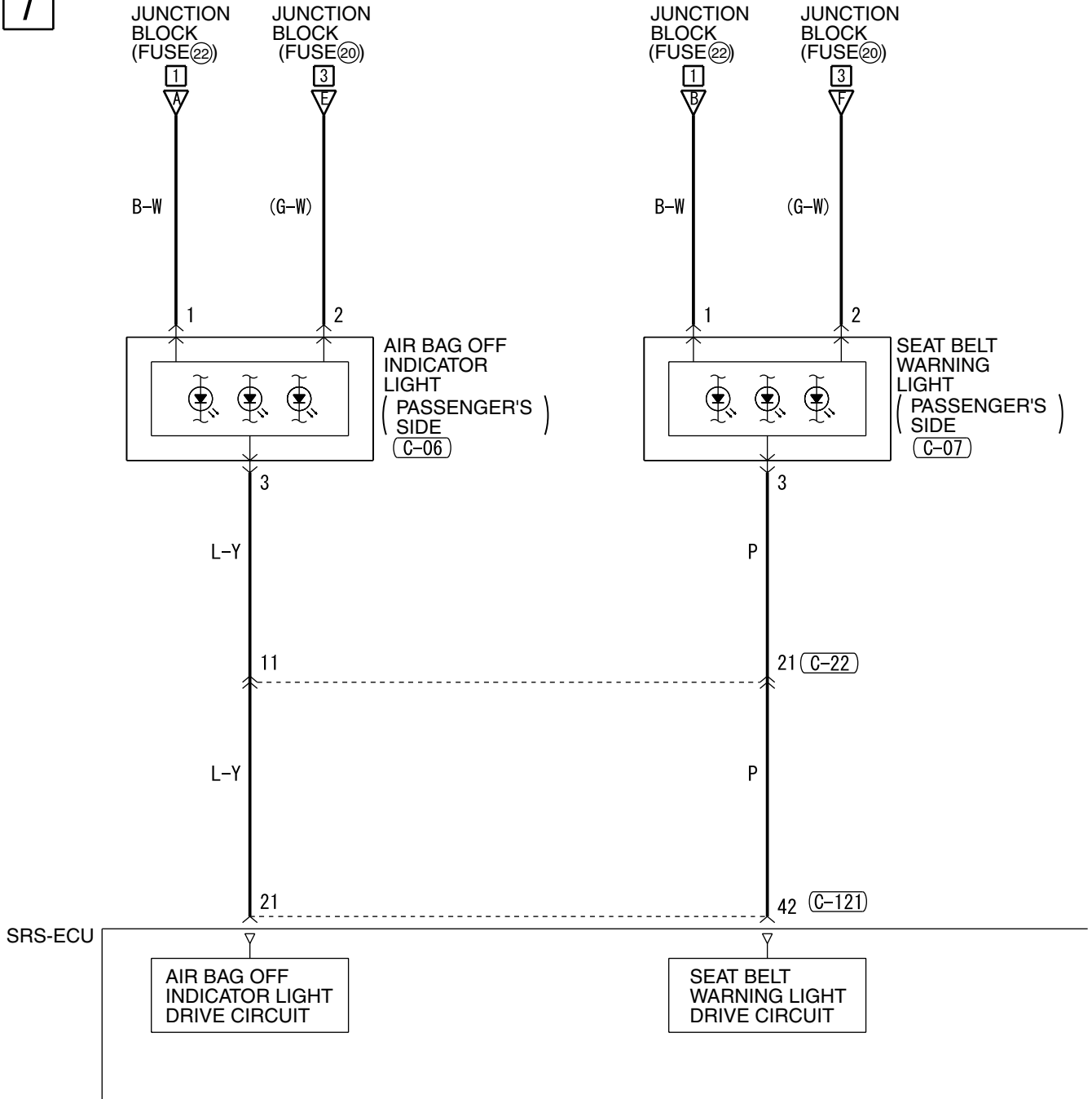

8

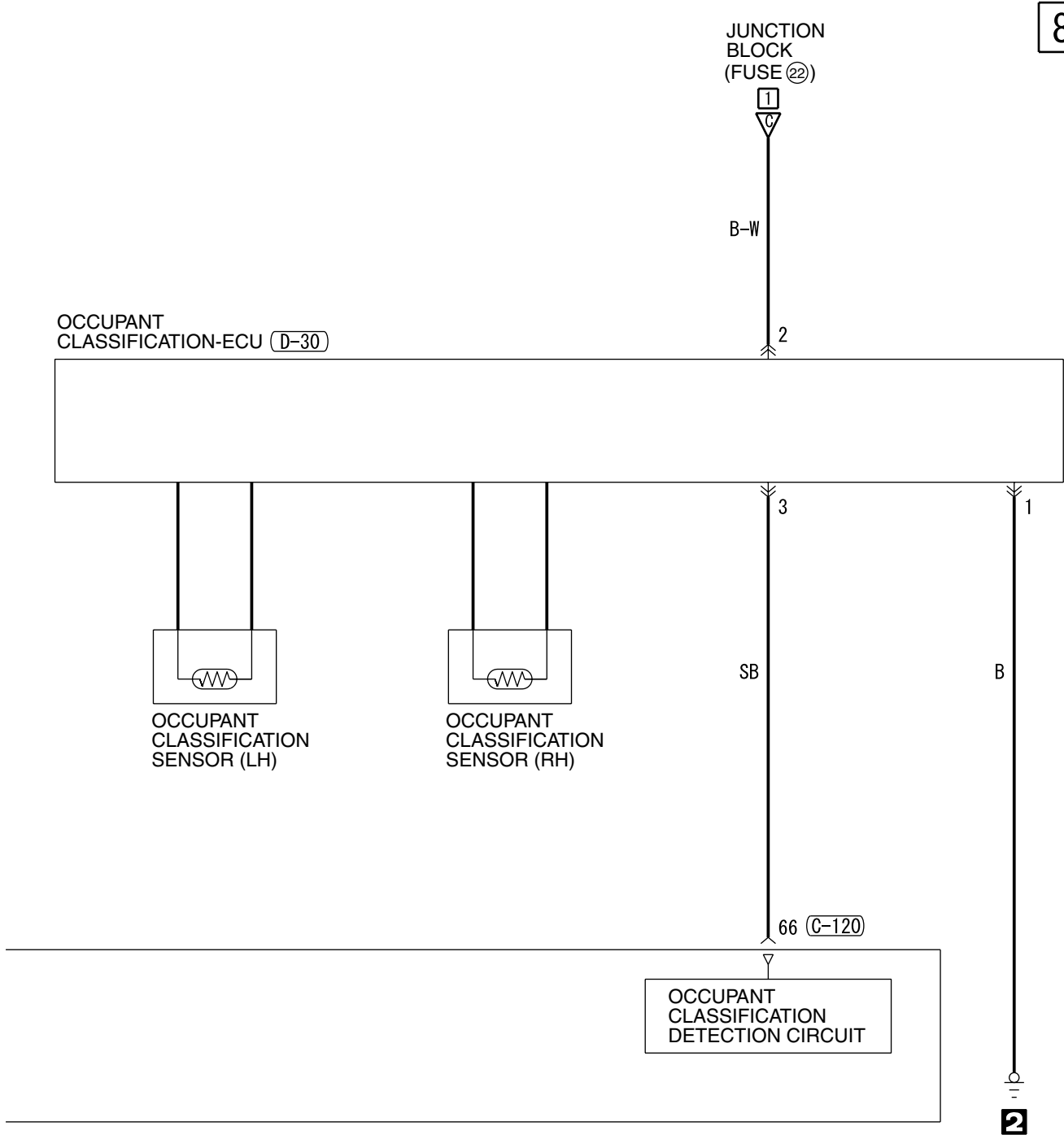

WIRE COLOR CODE

B : BLACK   LG : LIGHT GREEN   G : GREEN   L : BLUE   W : WHITE   Y : YELLOW  
 SB : SKY BLUE   BR : BROWN   O : ORANGE   GR : GRAY   R : RED   P : PINK   V : VIOLET

H5P15M04DB

TSB Revision

SUPPLEMENTAL RESTRAINT SYSTEM (SRS) (CONTINUED)

9

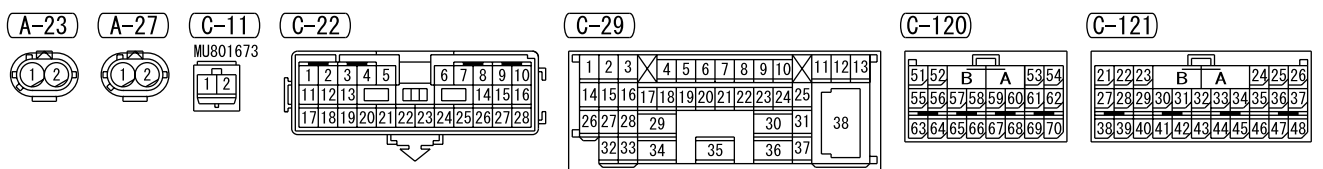
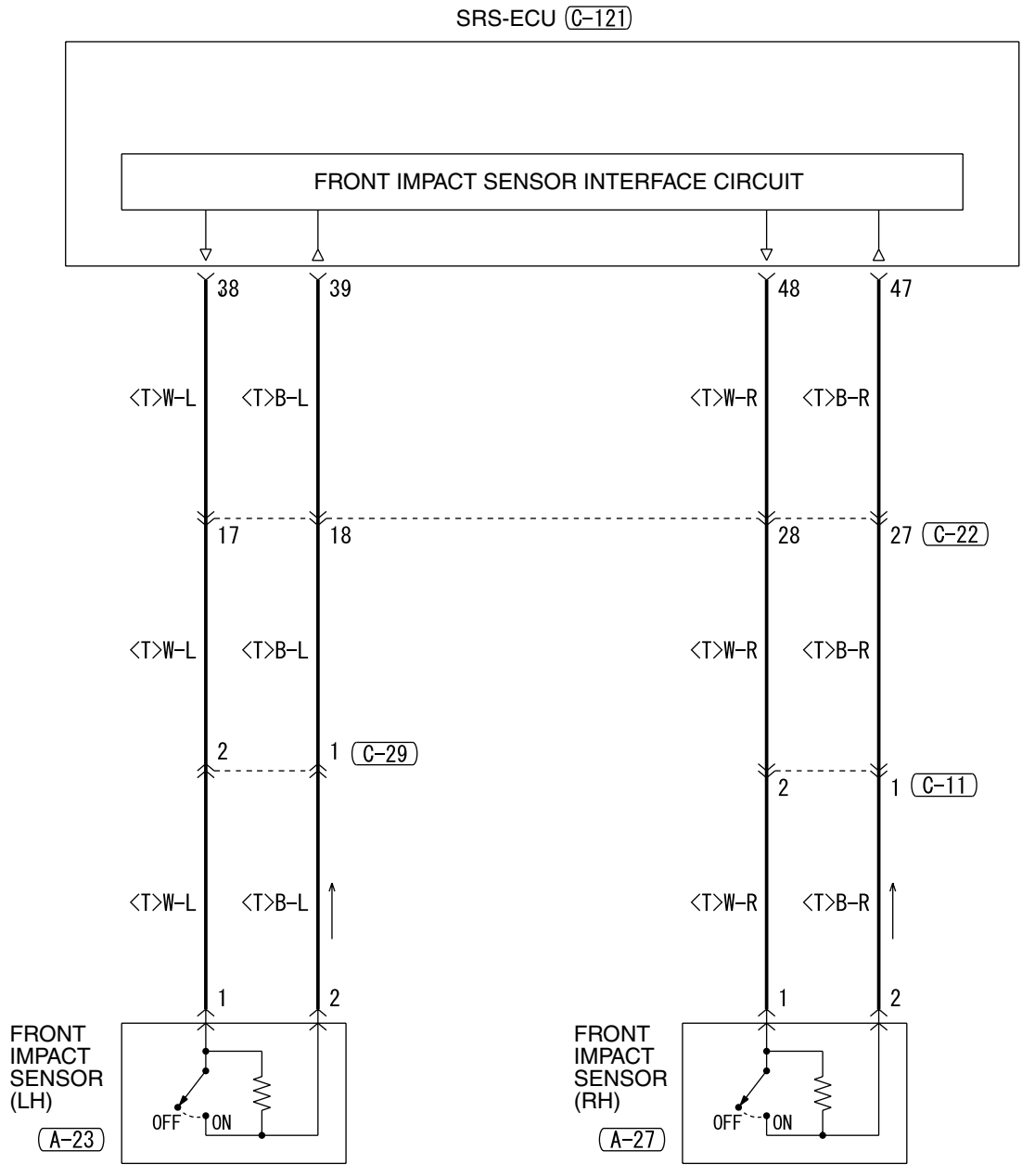

10

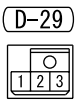
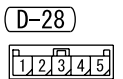
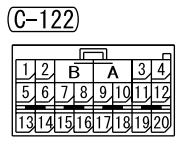
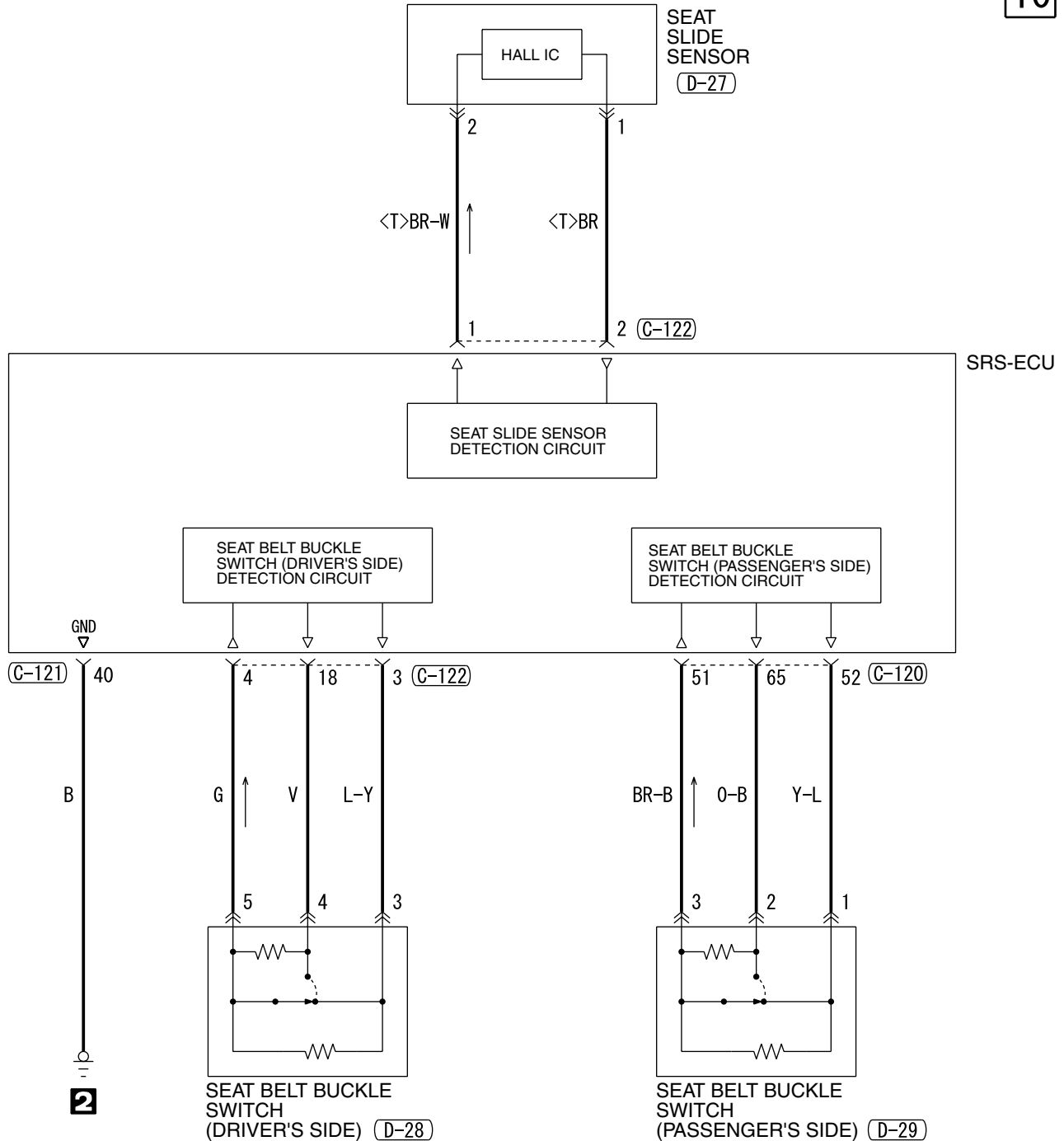

WIRE COLOR CODE  
 B : BLACK SB : SKY BLUE  
 BR : BROWN LG : LIGHT GREEN  
 G : GREEN P : PINK GR : GRAY  
 R : RED L : BLUE Y : YELLOW  
 V : VIOLET W : WHITE O : ORANGE

# ENGINE IMMOBILIZER SYSTEM

M1901013601326

1

NOTE  
\*1: 2.4L ENGINE  
\*2: 3.8L ENGINE

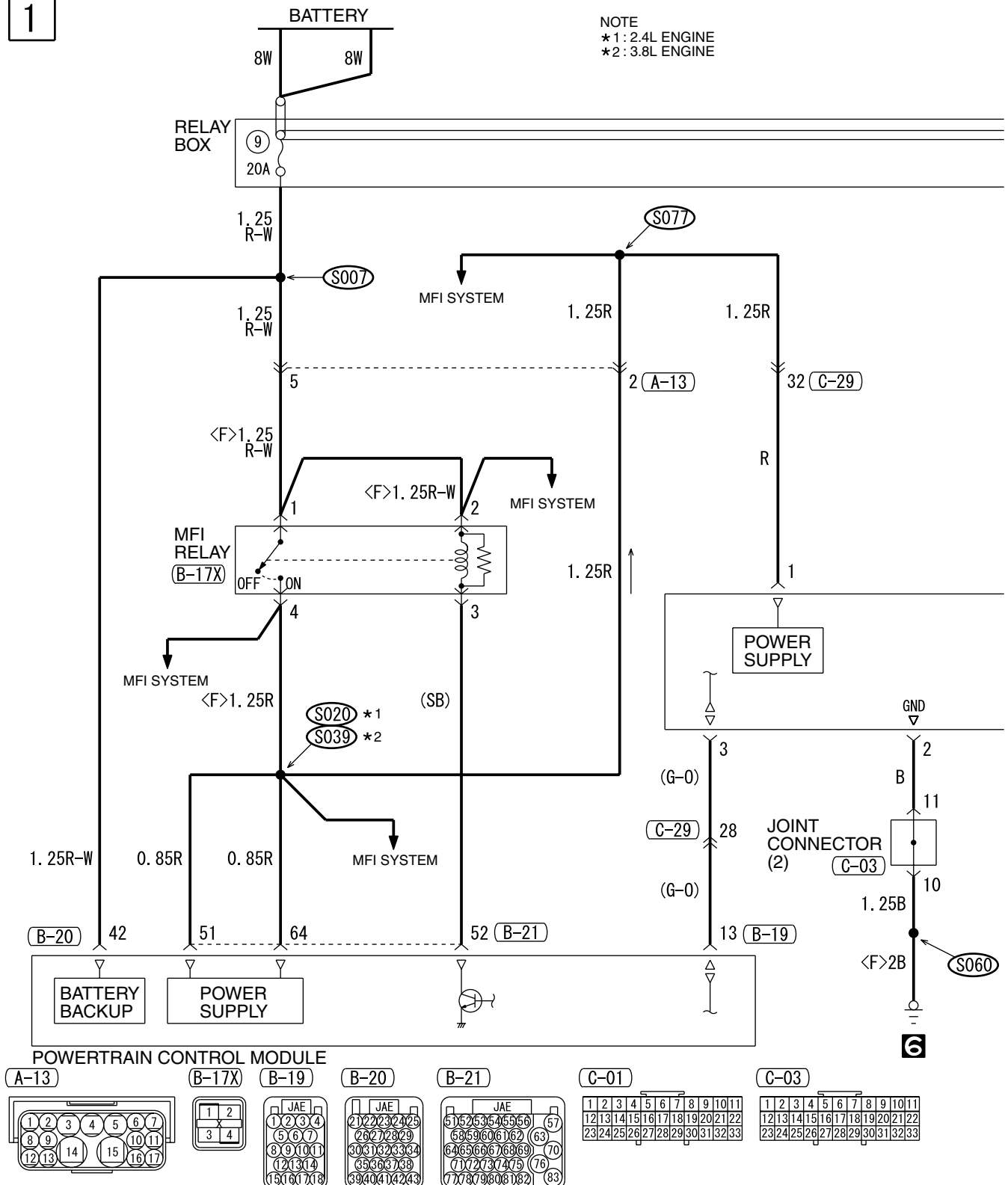

6

H5P15M05AA

TSB Revision

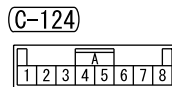
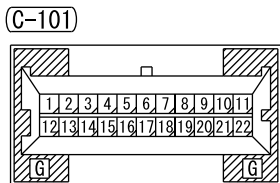
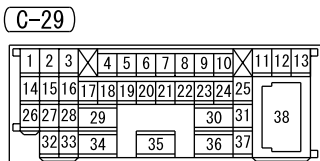
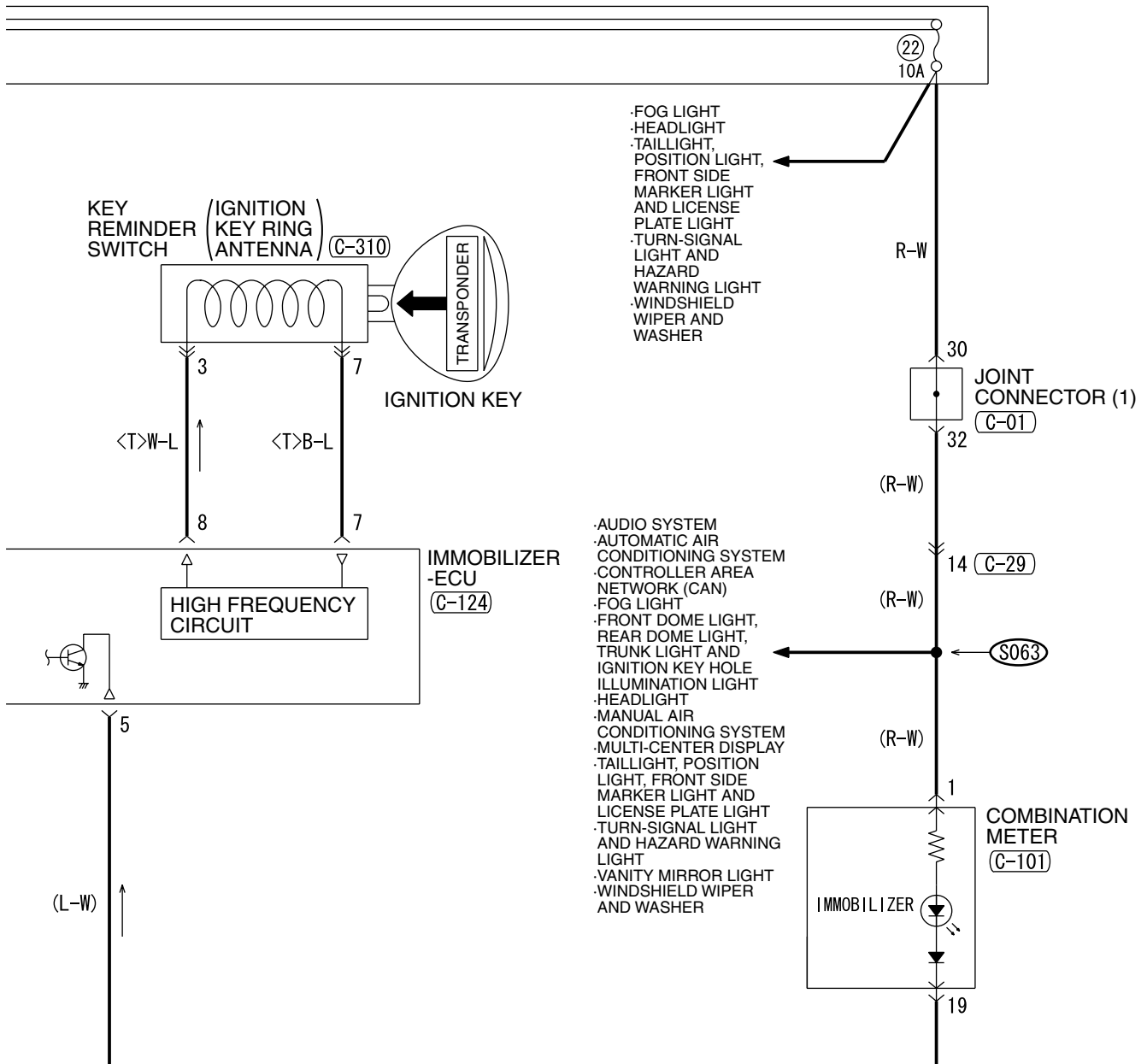

ENGINE IMMOBILIZER SYSTEM (CONTINUED)

3

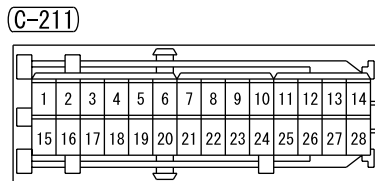
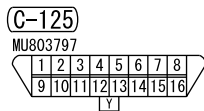
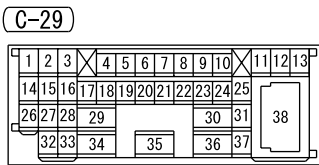
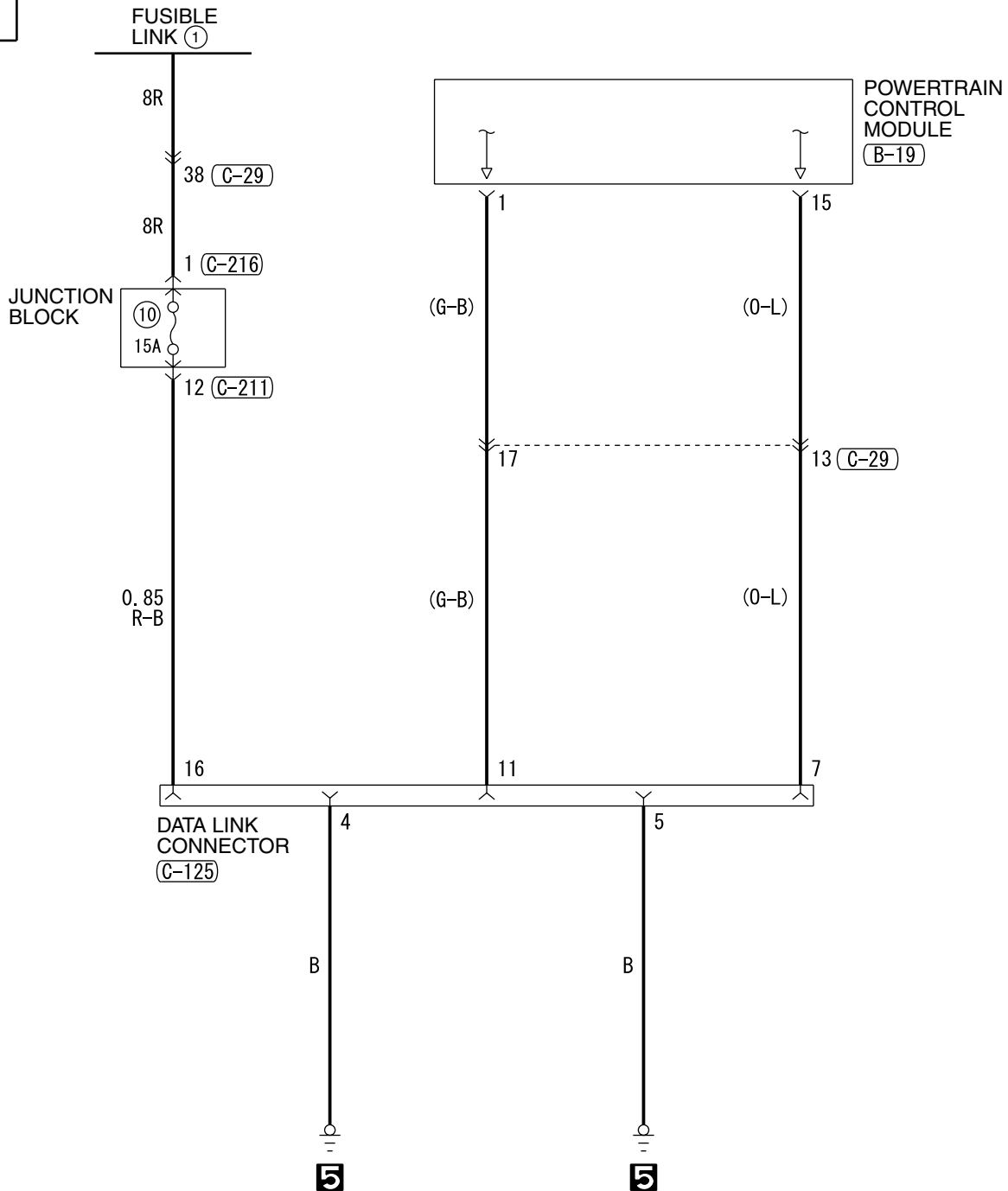



NOTES

# POWER SEAT

1

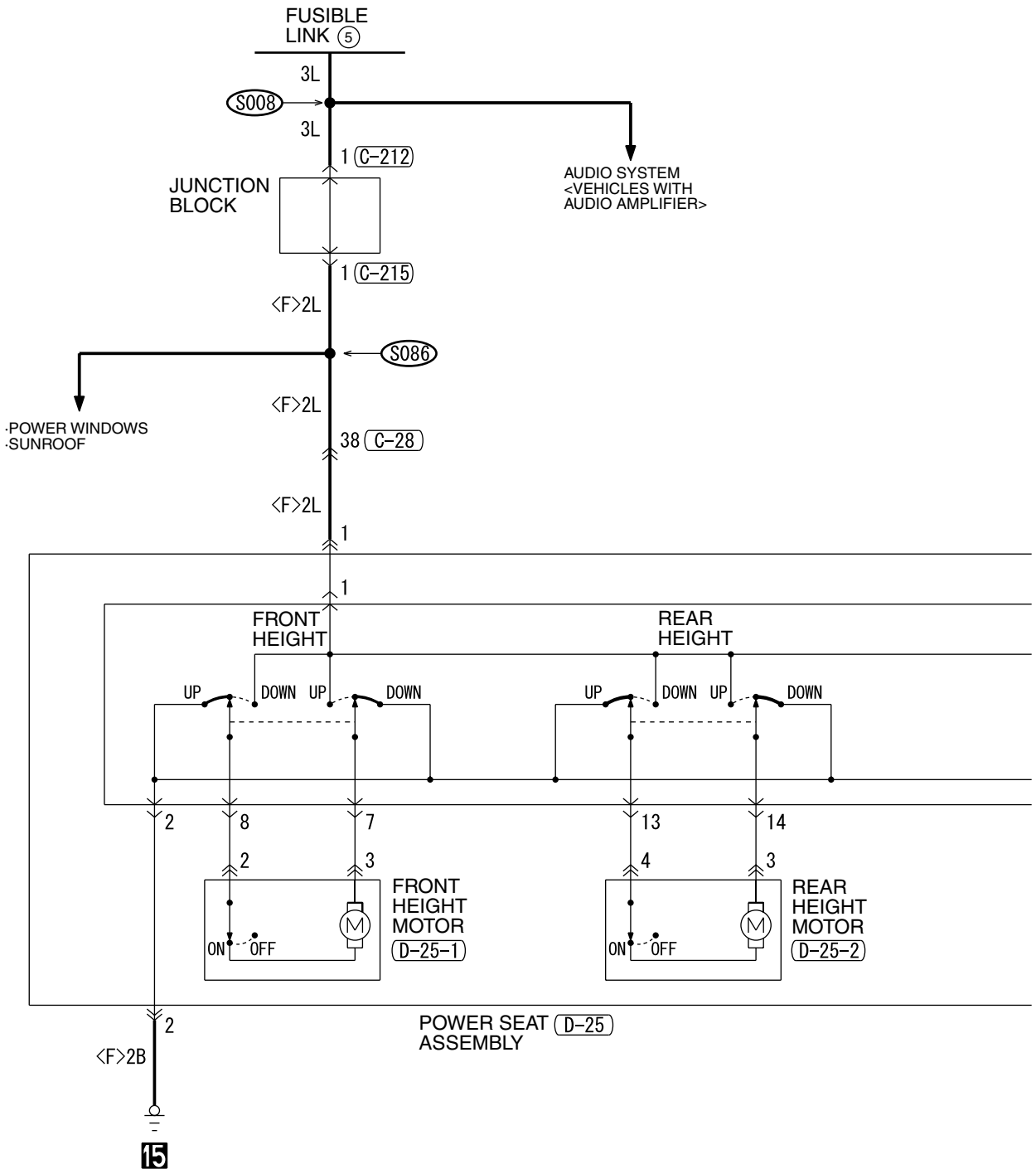

(C-28)

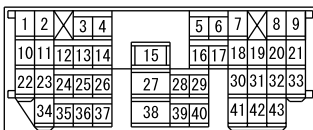

(C-212)



(C-215)



(D-25)



(D-25-1)

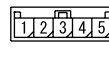

(D-25-2)

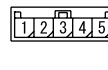

(D-25-3)



(D-25-4)



(D-25-5)

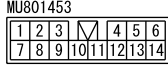

2

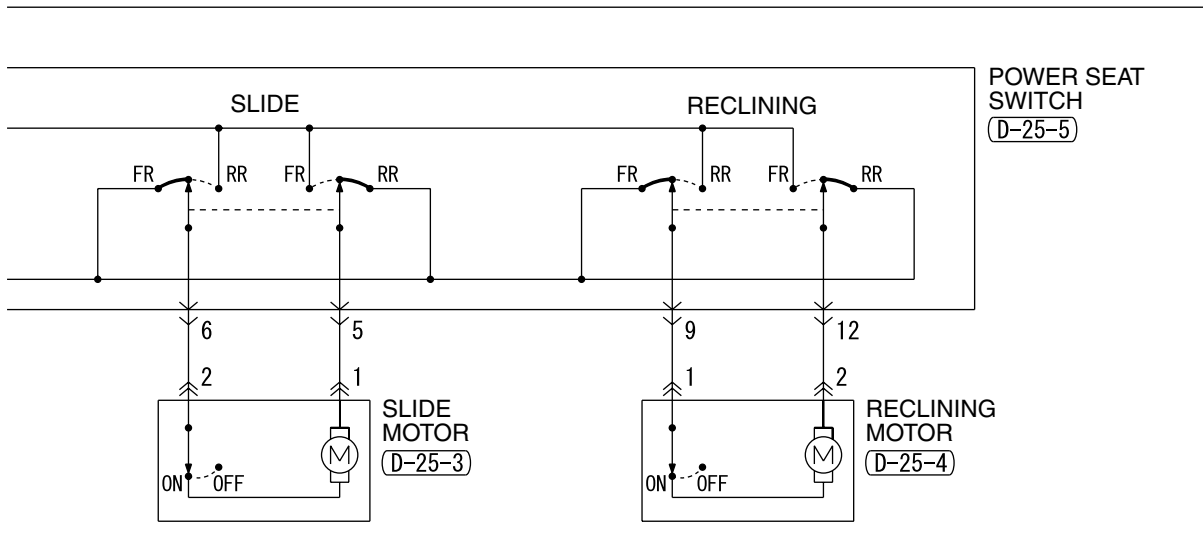

WIRE COLOR CODE

B : BLACK   LG : LIGHT GREEN   G : GREEN   L : BLUE   W : WHITE   Y : YELLOW  
 SB : SKY BLUE   BR : BROWN   O : ORANGE   GR : GRAY   R : RED   P : PINK   V : VIOLET

H5P15M06AB

TSB Revision

# HEATED SEAT

1

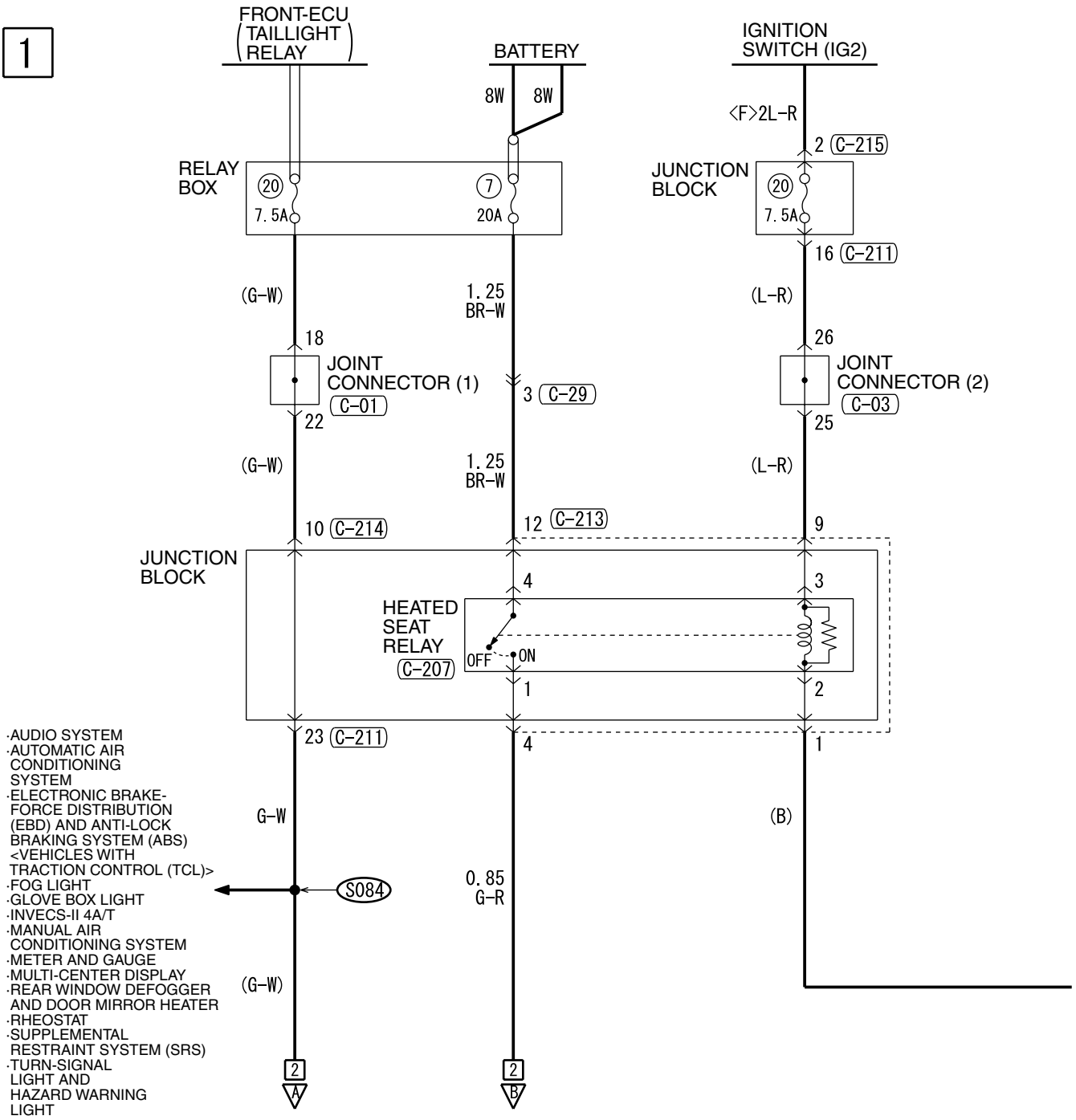

- AUDIO SYSTEM
- AUTOMATIC AIR CONDITIONING SYSTEM
- ELECTRONIC BRAKE-FORCE DISTRIBUTION (EBD) AND ANTI-LOCK BRAKING SYSTEM (ABS)
- <VEHICLES WITH TRACTION CONTROL (TCL)>
- FOG LIGHT
- GLOVE BOX LIGHT
- INVECS-II 4A/T
- MANUAL AIR CONDITIONING SYSTEM
- METER AND GAUGE
- MULTI-CENTER DISPLAY
- REAR WINDOW DEFOGGER AND DOOR MIRROR HEATER
- RHEOSTAT
- SUPPLEMENTAL RESTRAINT SYSTEM (SRS)
- TURN-SIGNAL LIGHT AND HAZARD WARNING LIGHT

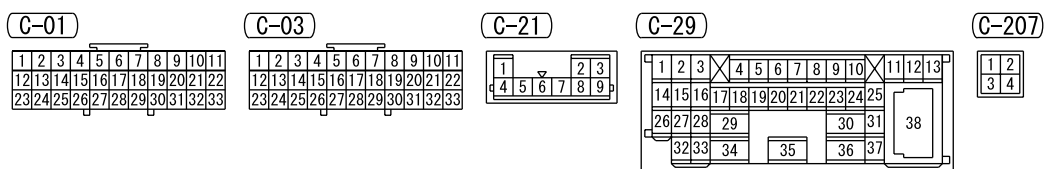

2

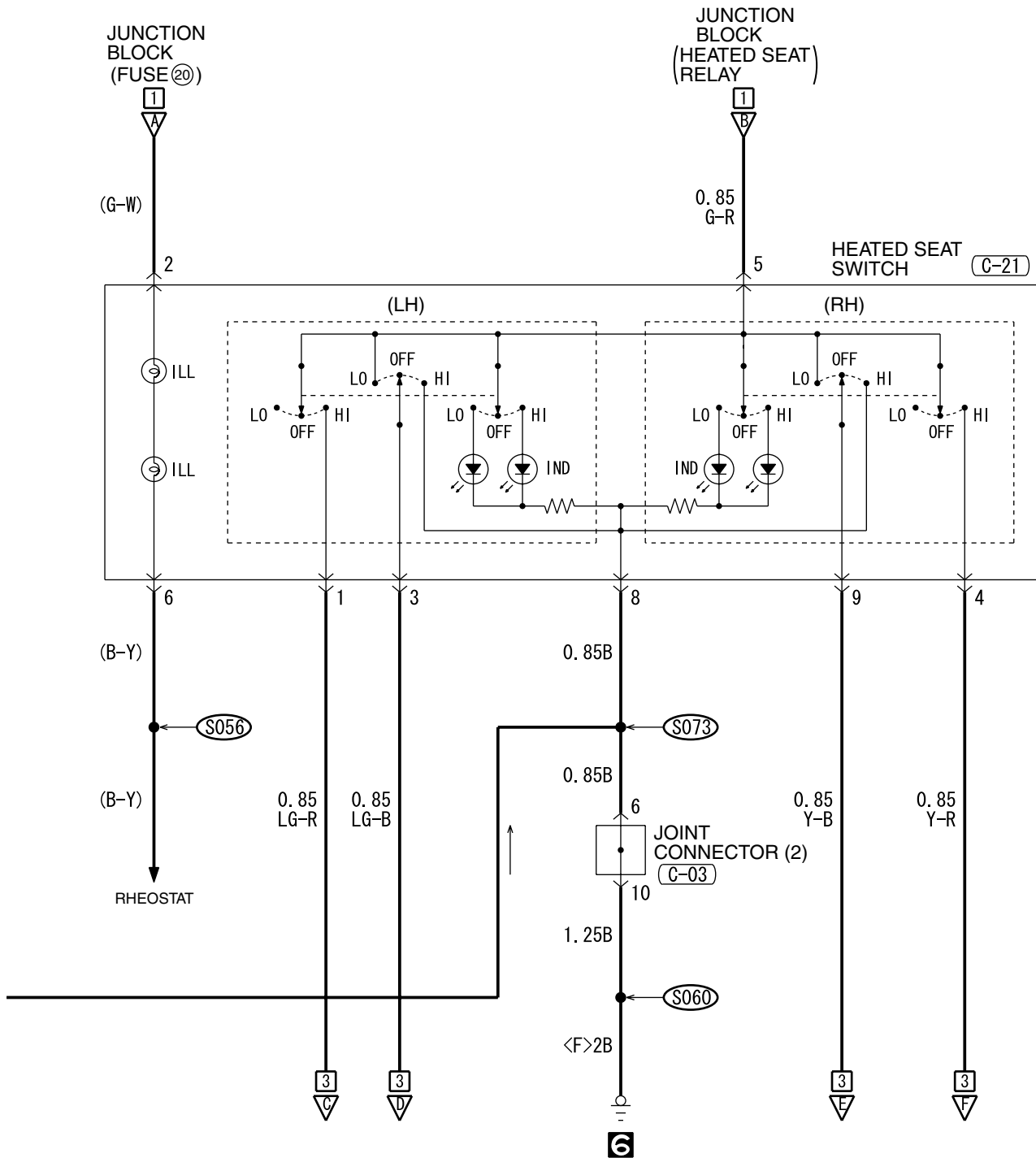

(C-211)

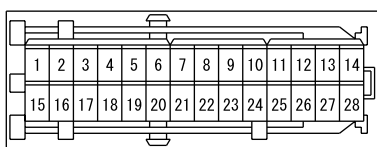

(C-213) MU801855

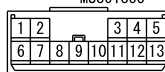

(C-214) MU801857

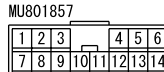

(C-215) MU801331



WIRE COLOR CODE

B : BLACK LG : LIGHT GREEN G : GREEN L : BLUE  
 BR : BROWN O : ORANGE GR : GRAY R : RED W : WHITE  
 SB : SKY BLUE P : PINK Y : YELLOW V : VIOLET

H5P15M07AB

TSB Revision

HEATED SEAT (CONTINUED)

3

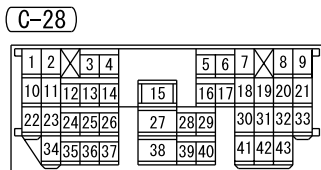
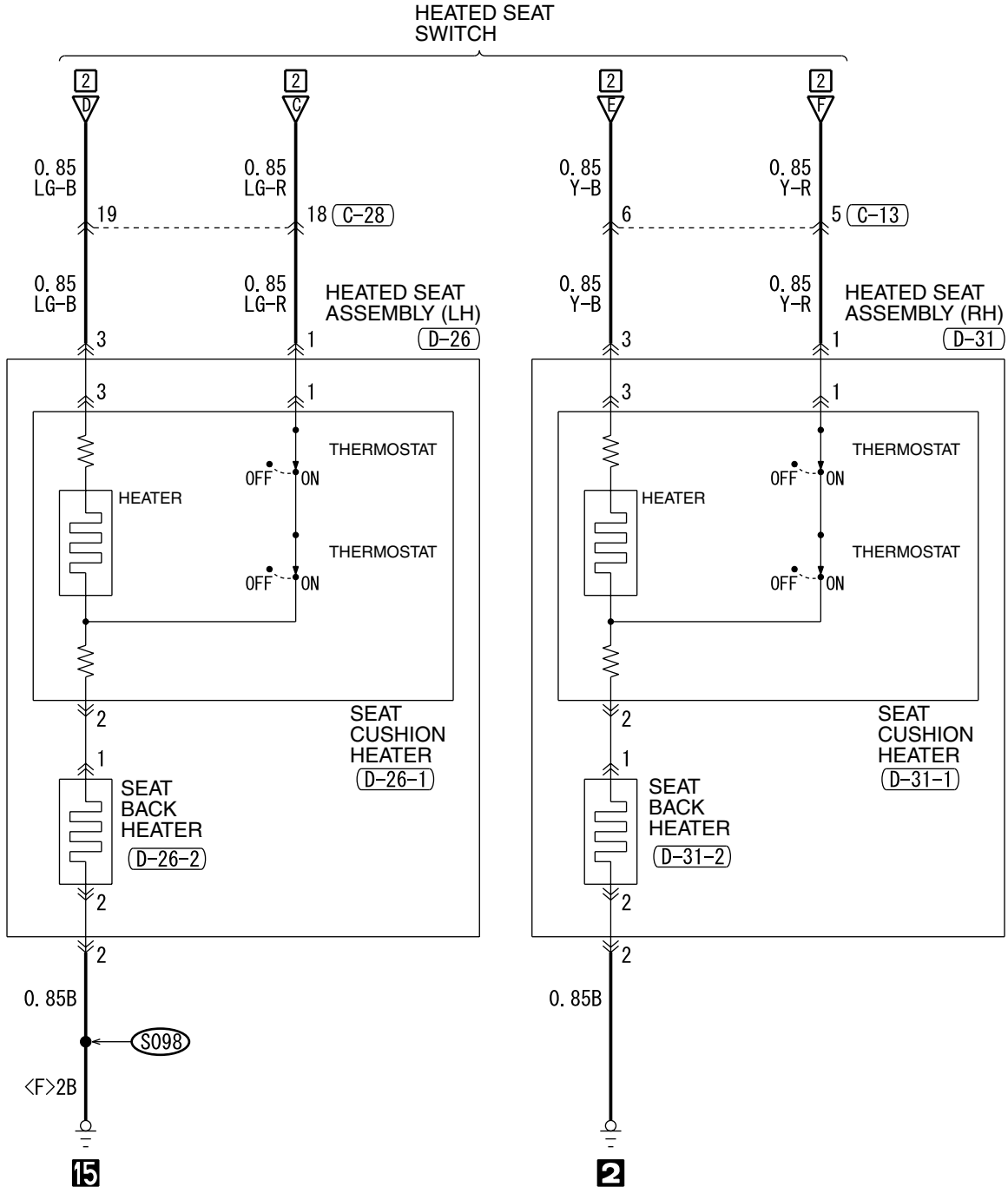

WIRE COLOR CODE  
 B : BLACK LG : LIGHT GREEN G : GREEN L : BLUE  
 BR : BROWN O : ORANGE GR : GRAY R : RED W : WHITE  
 SB : SKY BLUE P : PINK Y : YELLOW V : VIOLET

H5P15M07BA

NOTES

# FORGOTTEN KEY PREVENTION FUNCTION

M1901016100361

1

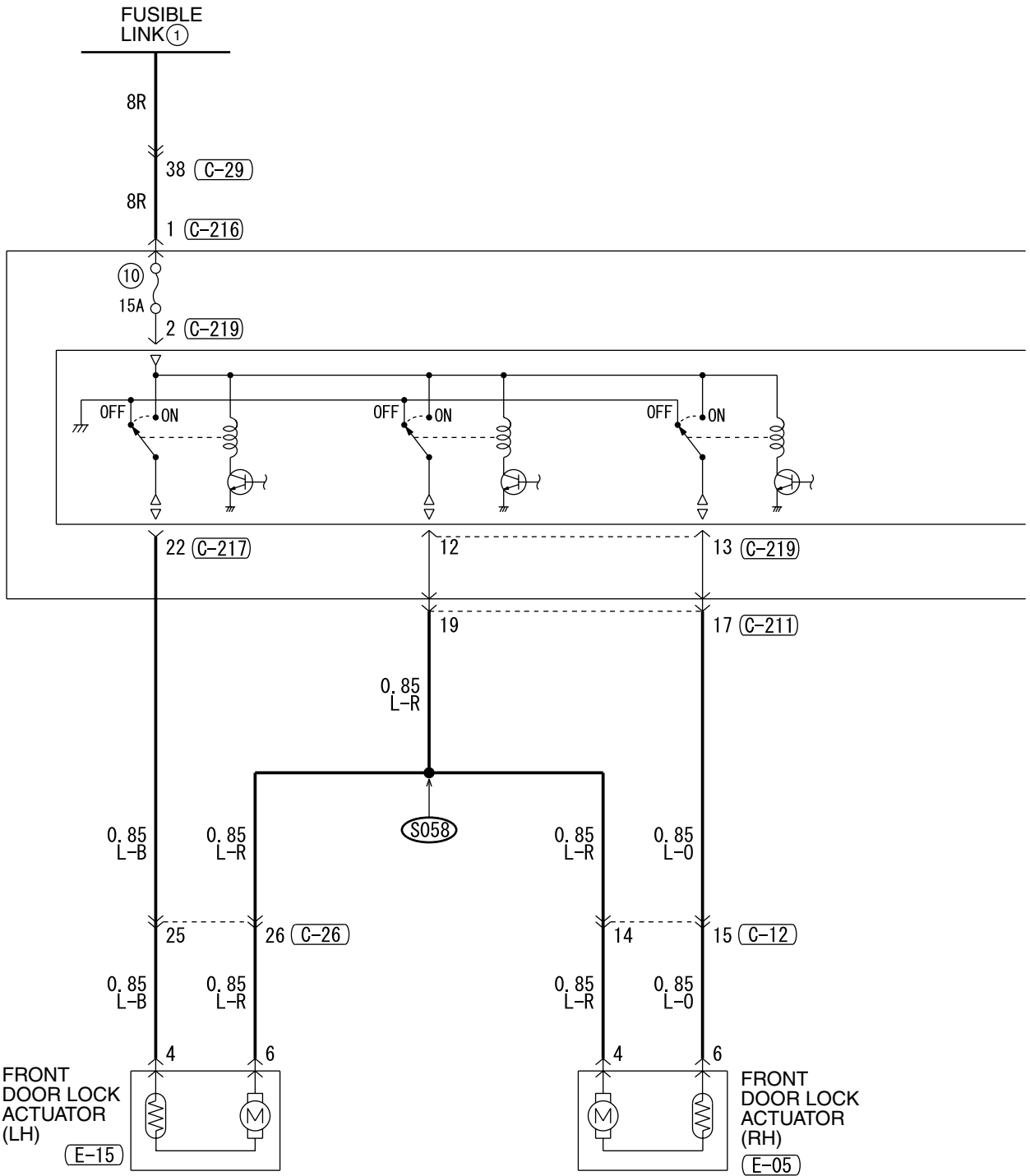

(C-12)

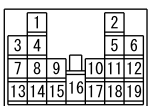

(C-26)

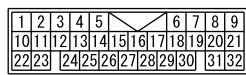

(C-29)

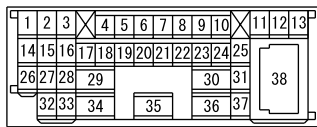

(C-211)

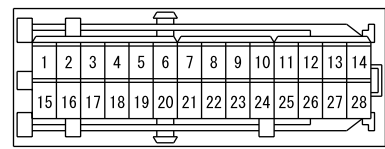



2

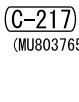
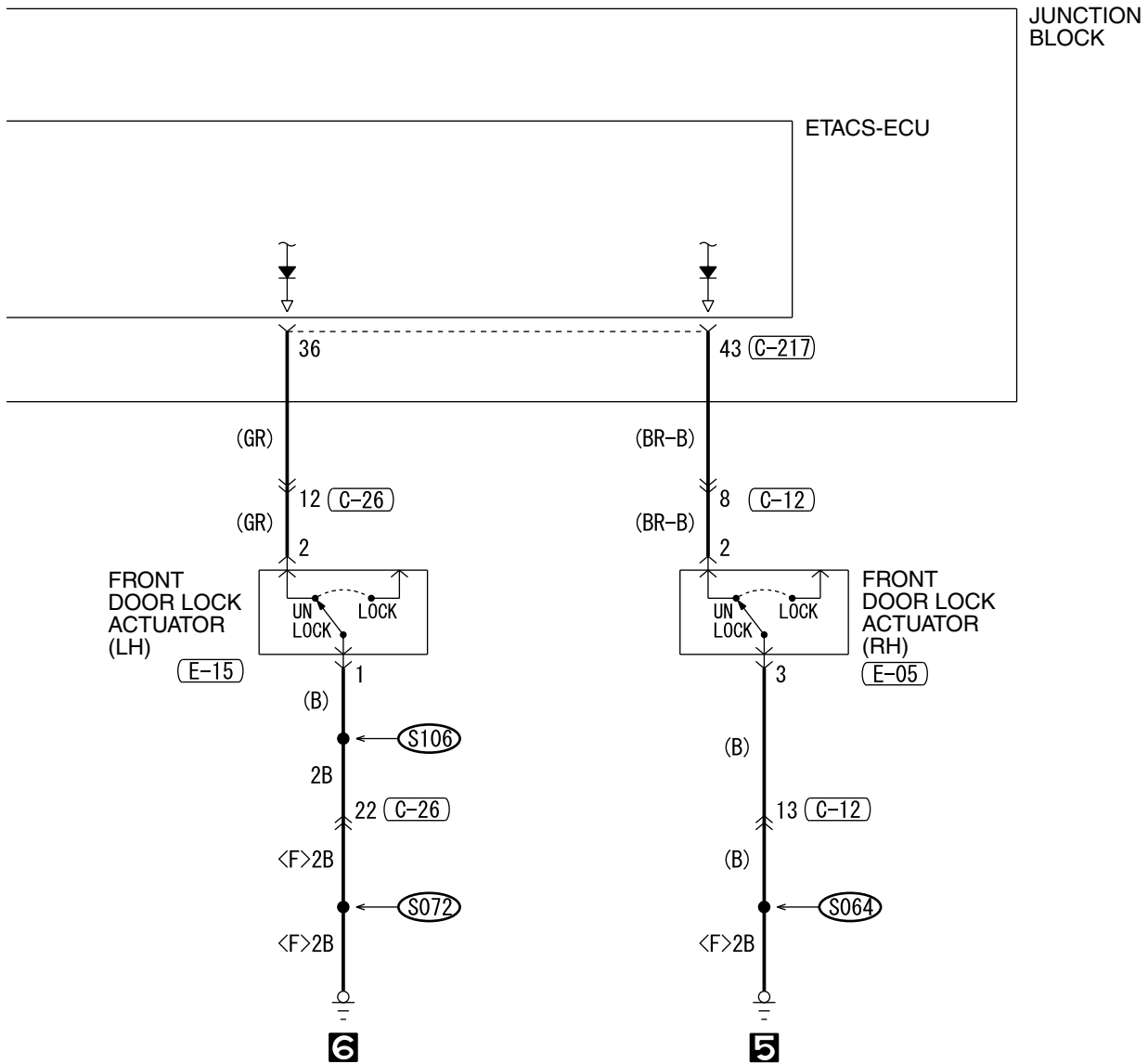

21	22	23	24	25	26	27	28	29
30	31	32	33	34	35	36	37	38
39	40	41			42	43	44	

C-219 JUNCTION BLOCK SIDE

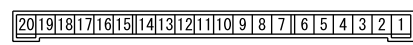

WIRE COLOR CODE

B : BLACK LG : LIGHT GREEN G : GREEN L : BLUE W : WHITE Y : YELLOW  
SB : SKY BLUE BR : BROWN O : ORANGE GR : GRAY R : RED P : PINK V : VIOLET

FORGOTTEN KEY PREVENTION FUNCTION (CONTINUED)

3

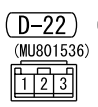
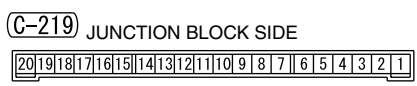
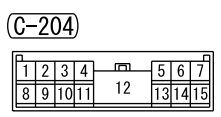
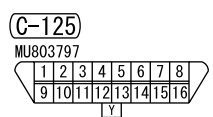
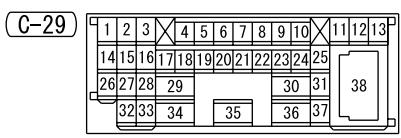
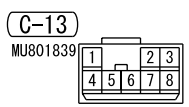
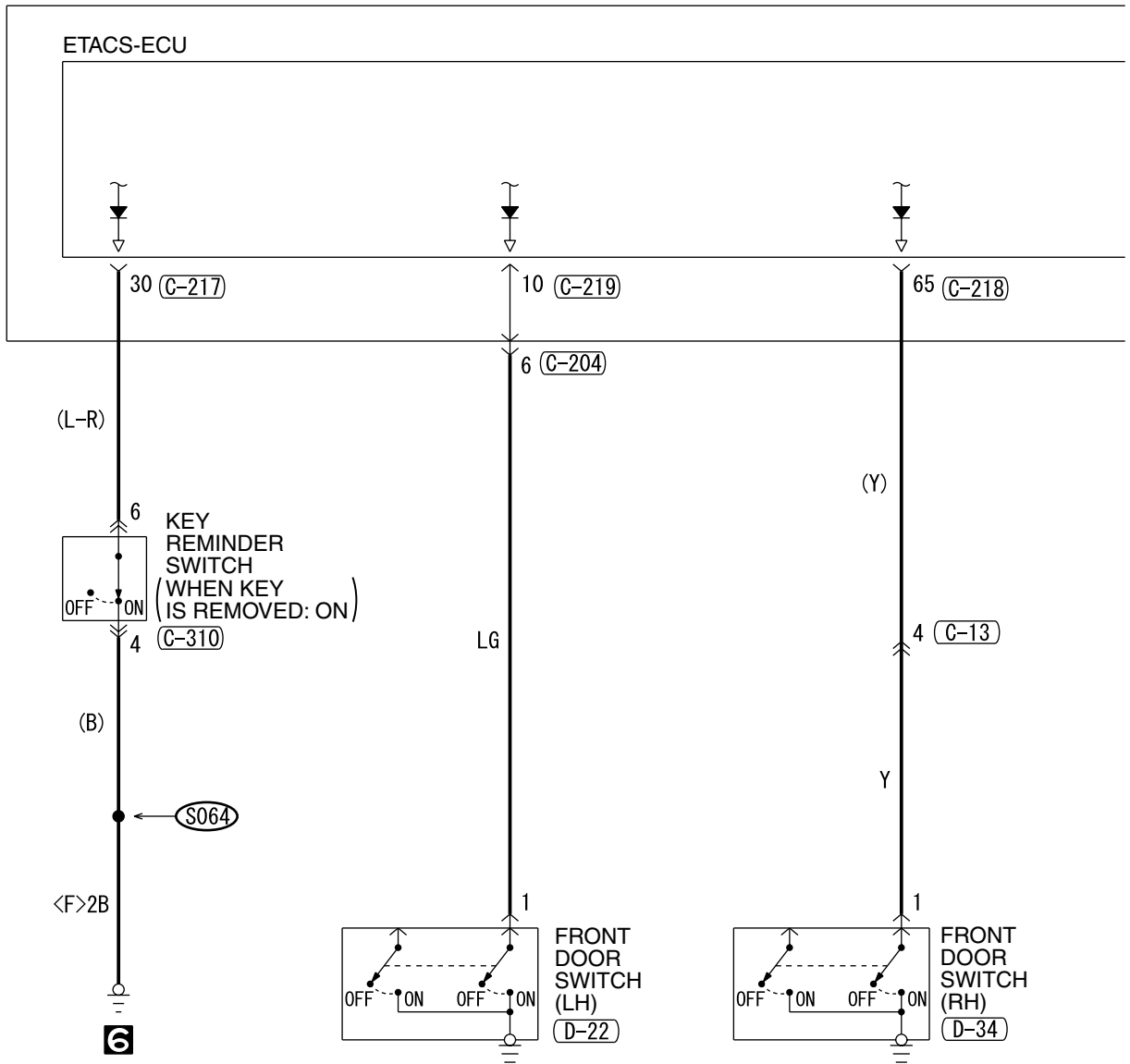

4

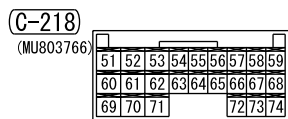
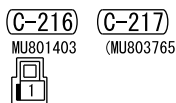
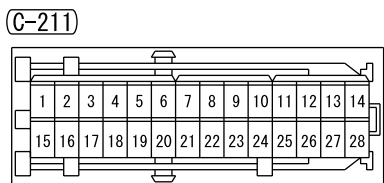
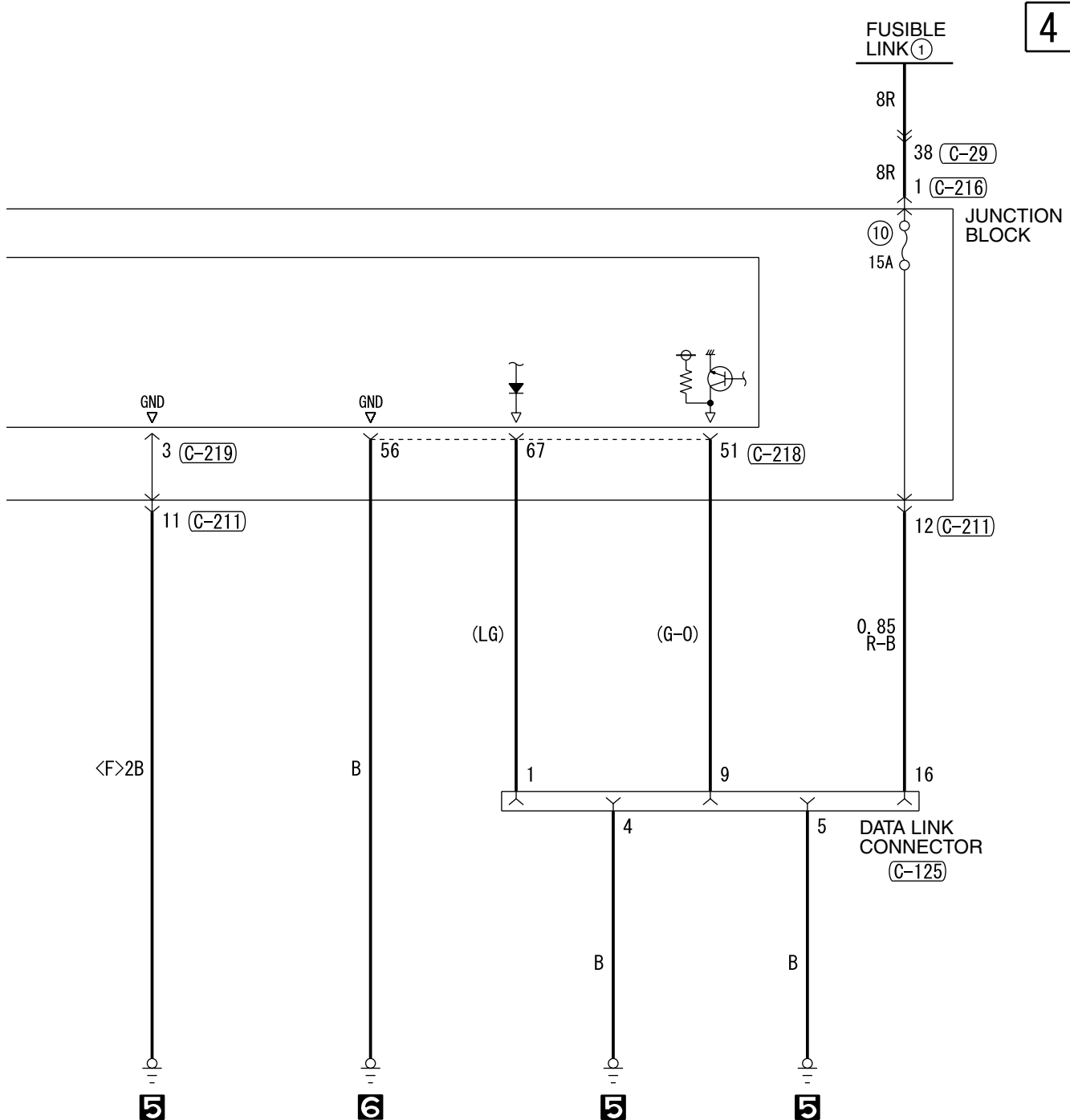

WIRE COLOR CODE  
 B : BLACK LG : LIGHT GREEN G : GREEN L : BLUE  
 BR : BROWN O : ORANGE GR : GRAY R : RED W : WHITE  
 SB : SKY BLUE P : PINK Y : YELLOW V : VIOLET

# LIGHTING MONITOR TONE ALARM

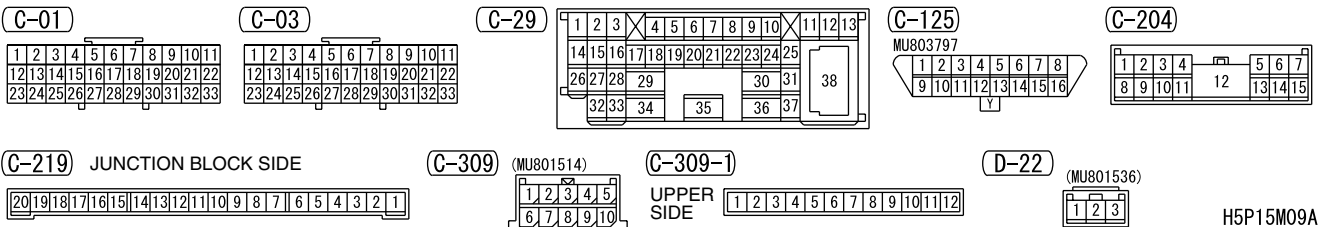
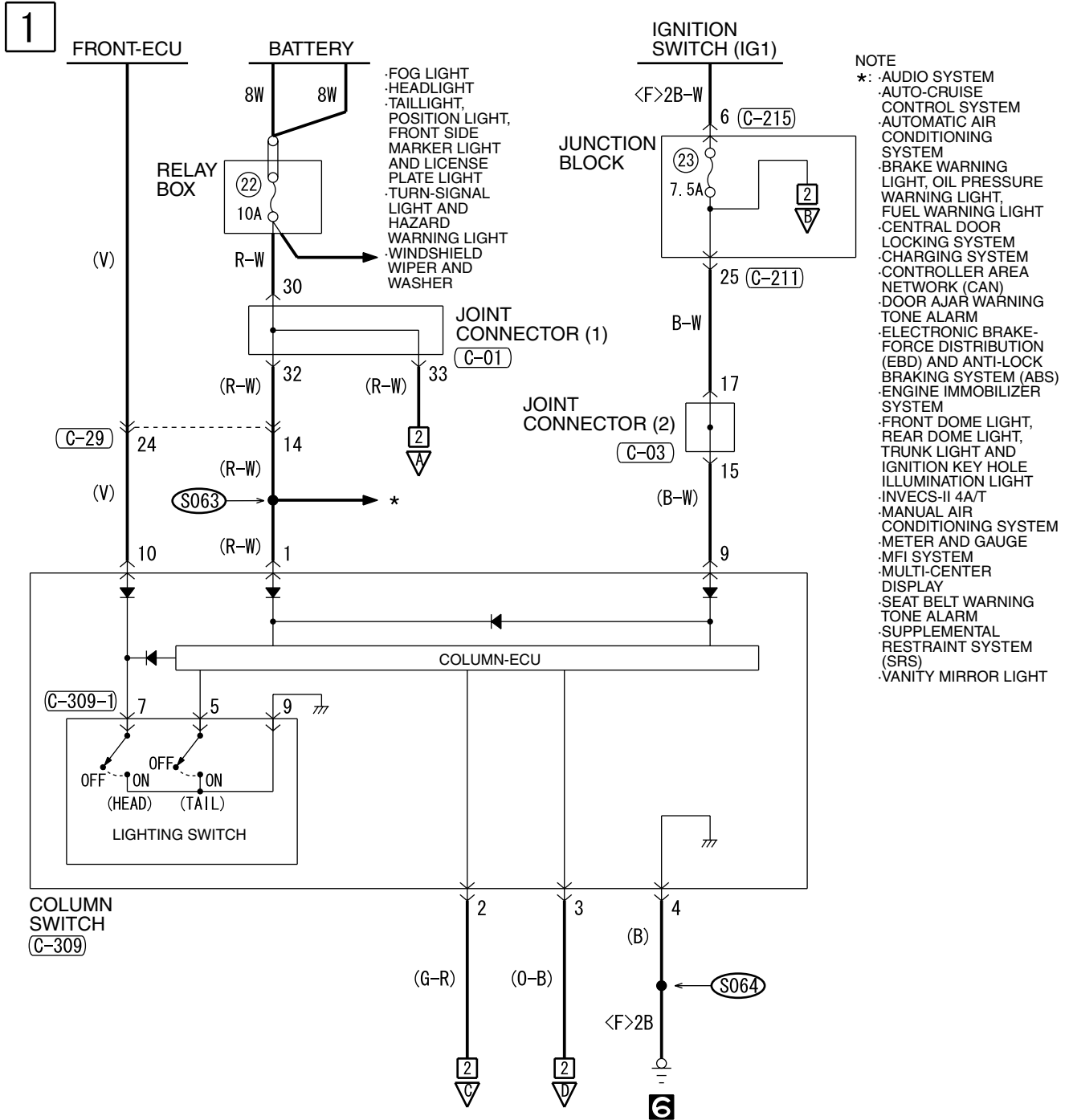

2

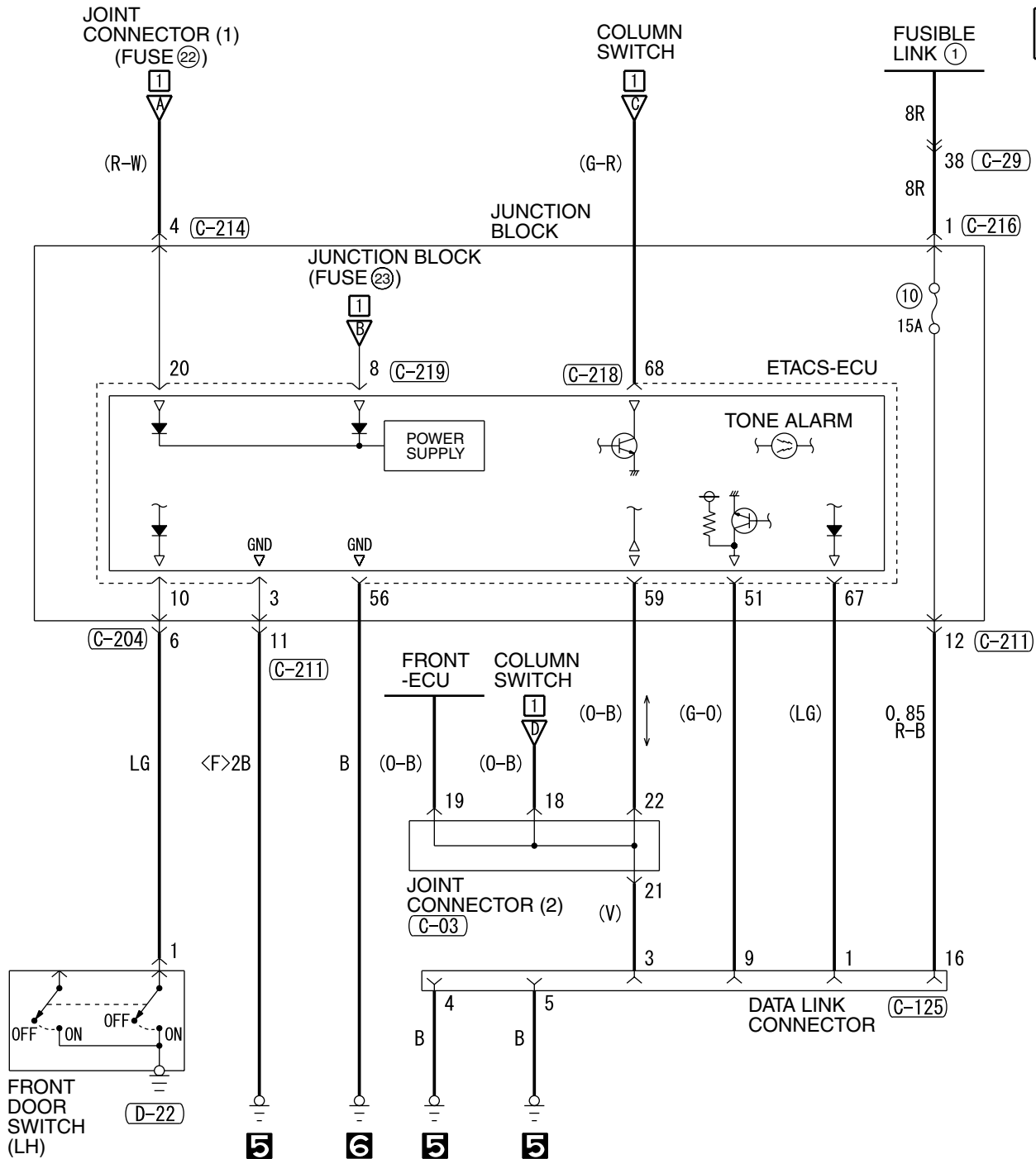

(C-211)

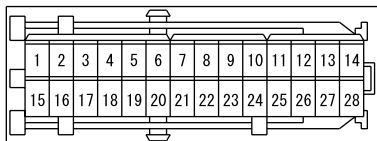

(C-214)

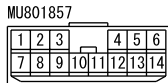

(C-215)



(C-216)



(C-218)

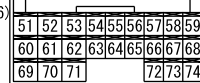

WIRE COLOR CODE

B : BLACK LG : LIGHT GREEN G : GREEN L : BLUE  
BR : BROWN O : ORANGE GR : GRAY R : RED W : WHITE  
SB : SKY BLUE P : PINK Y : YELLOW V : VIOLET

H5P15M09AB

# IGNITION KEY REMINDER TONE ALARM

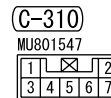
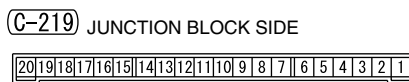
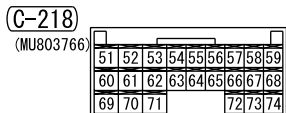
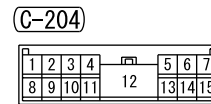
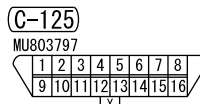
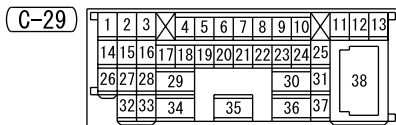
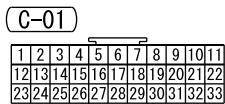
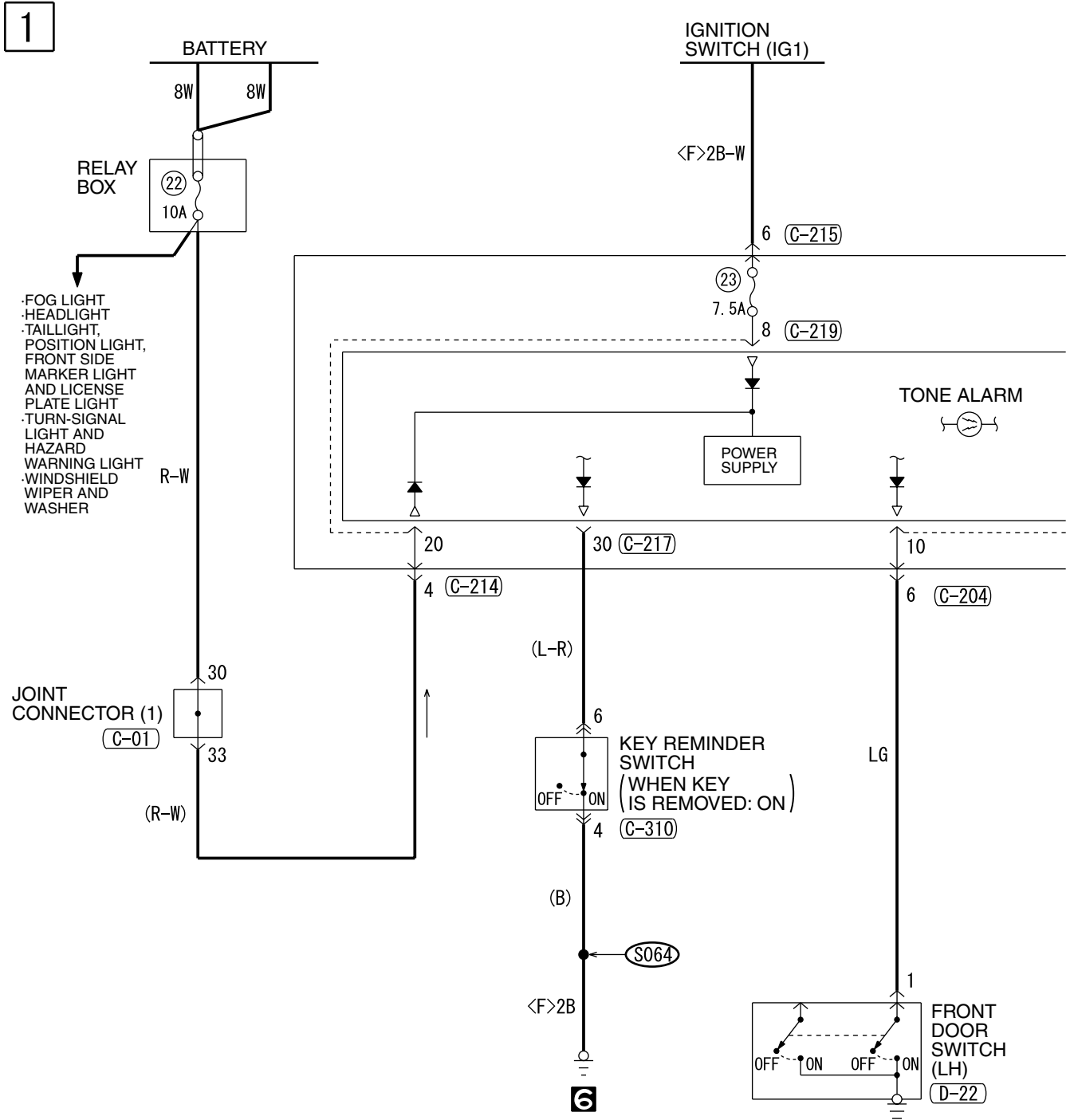

2

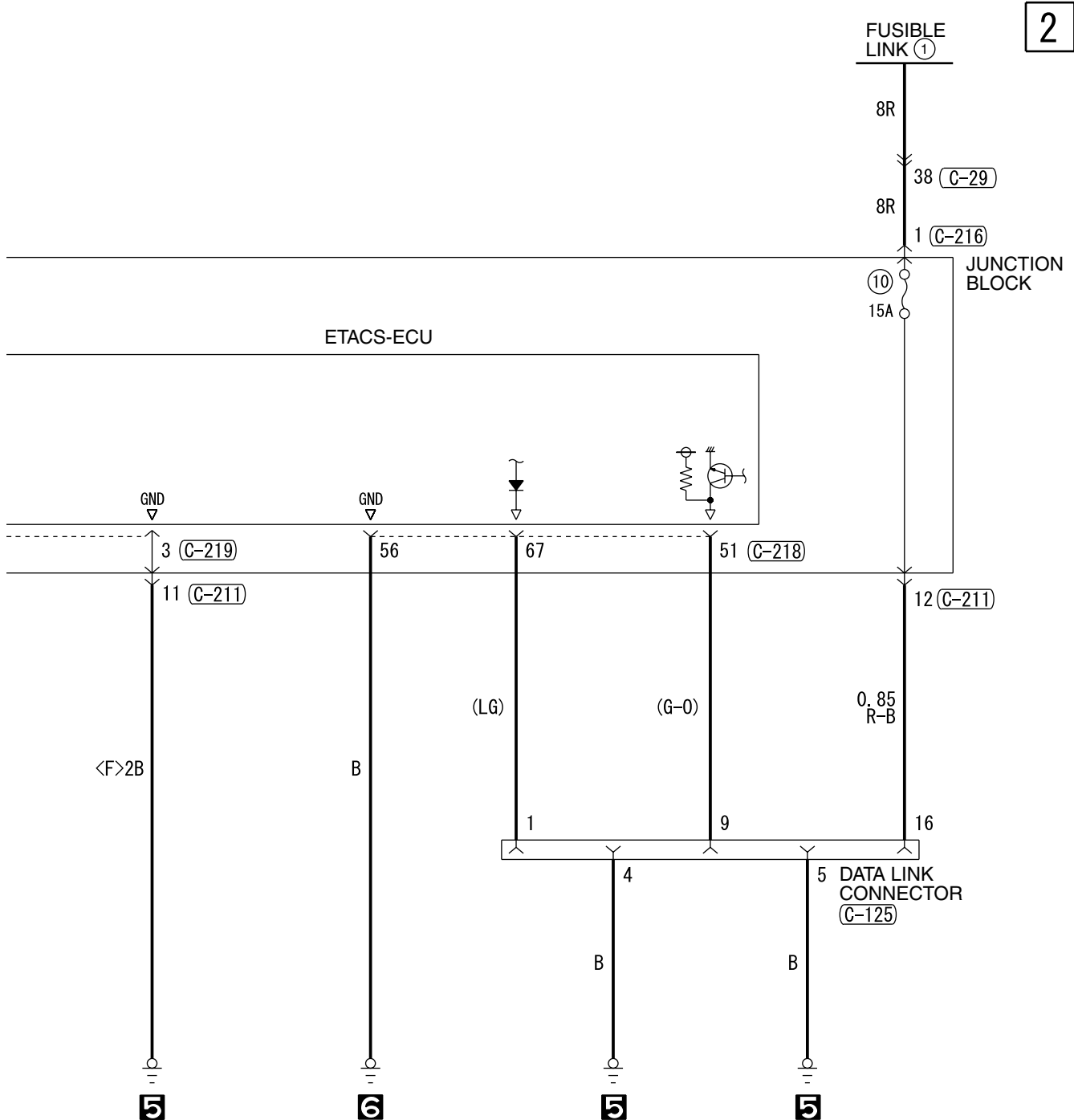

(C-211)

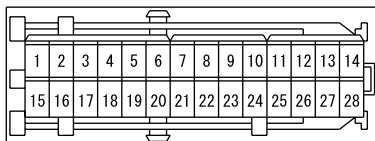

(C-214)

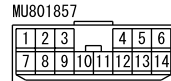

(C-215)



(C-216)



(C-217)



WIRE COLOR CODE  
 B : BLACK LG : LIGHT GREEN G : GREEN L : BLUE  
 BR : BROWN O : ORANGE GR : GRAY R : RED W : WHITE  
 SB : SKY BLUE P : PINK Y : YELLOW V : VIOLET

H5P15M10AB

TSB Revision

# SEAT BELT WARNING TONE ALARM

M1901011200749

1

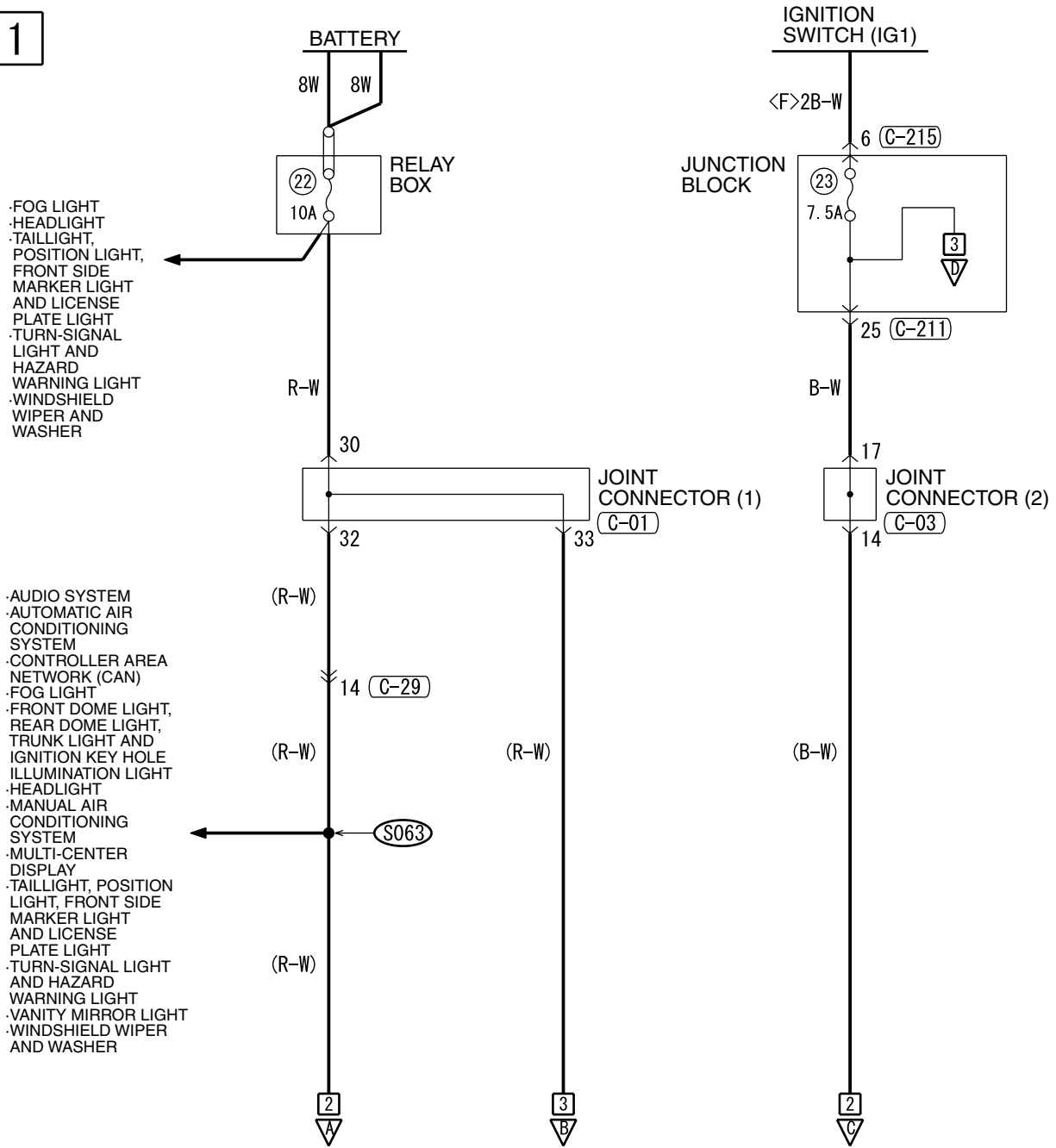

(C-01)

1	2	3	4	5	6	7	8	9	10	11
12	13	14	15	16	17	18	19	20	21	22
23	24	25	26	27	28	29	30	31	32	33

(C-03)

1	2	3	4	5	6	7	8	9	10	11
12	13	14	15	16	17	18	19	20	21	22
23	24	25	26	27	28	29	30	31	32	33

(C-28)

1	2	3	4	5	6	7	8	9			
10	11	12	13	14	15	16	17	18	19	20	21
22	23	24	25	26	27	28	29	30	31	32	33
34	35	36	37	38	39	40	41	42	43		

(C-29)

1	2	3	4	5	6	7	8	9	10	11	12	13
14	15	16	17	18	19	20	21	22	23	24	25	38
26	27	28	29	30	31	32	33	34	35	36	37	

H5P15M11AA



2

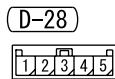
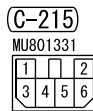
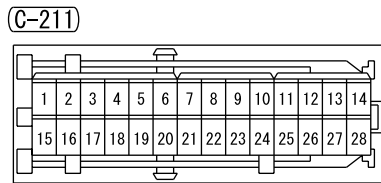
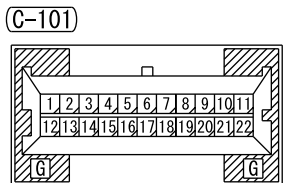
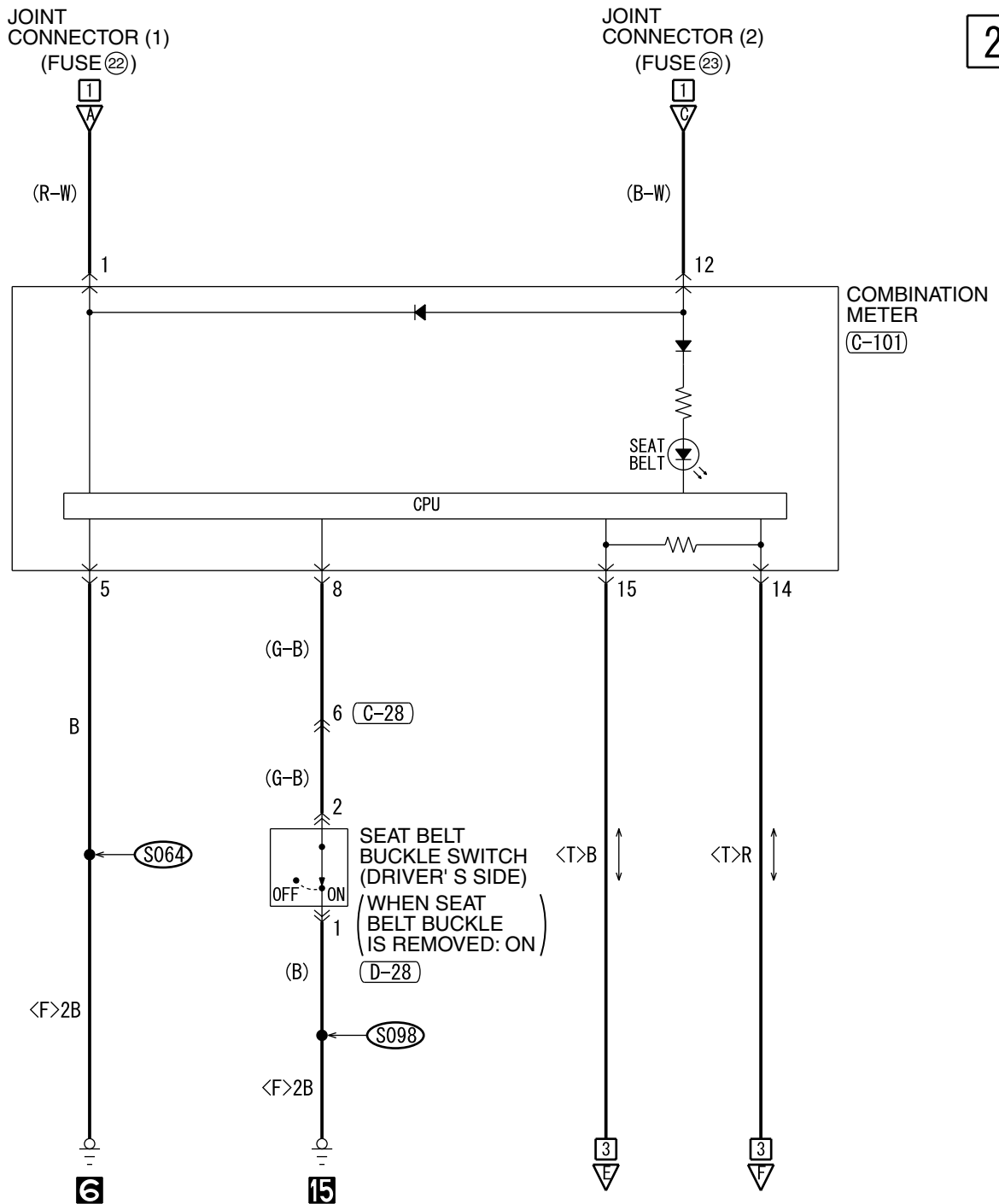

SEAT BELT WARNING TONE ALARM (CONTINUED)

3

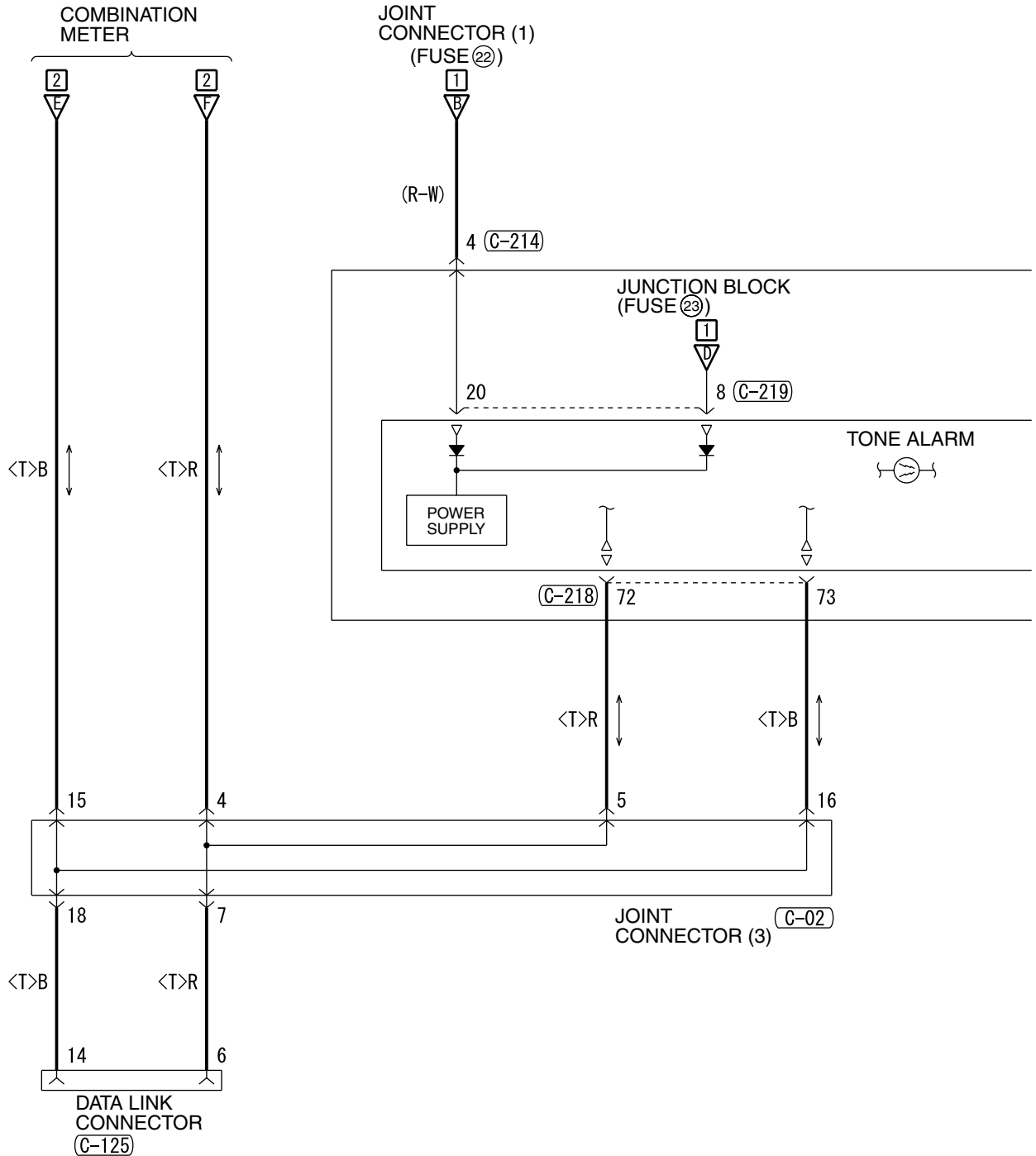

(C-02)

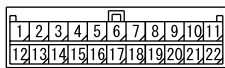

(C-29)

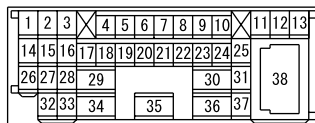

(C-125)

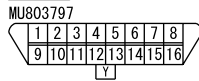

(C-211)

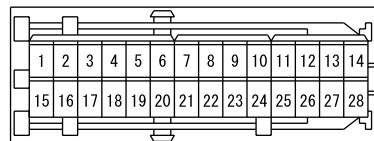

4

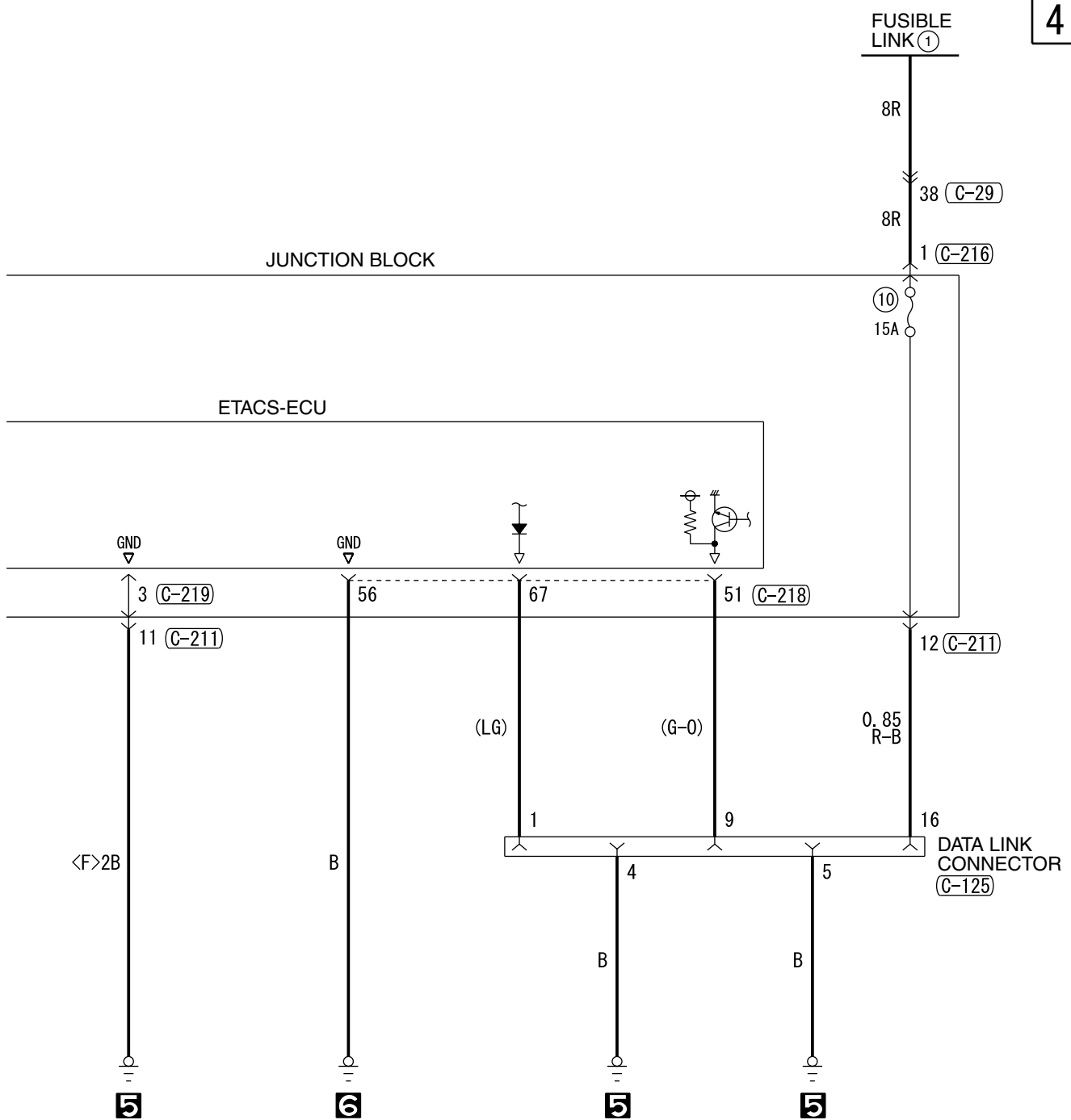

(C-214)

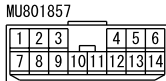

(C-216)



(C-218)

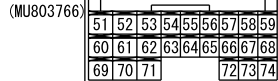

(C-219)

JUNCTION BLOCK SIDE

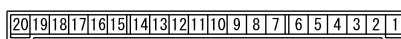

WIRE COLOR CODE

B : BLACK LG : LIGHT GREEN G : GREEN L : BLUE W : WHITE Y : YELLOW  
SB : SKY BLUE BR : BROWN O : ORANGE GR : GRAY R : RED P : PINK V : VIOLET

H5P15M11BB

TSB Revision

# DOOR AJAR WARNING TONE ALARM

M1901016600311

1

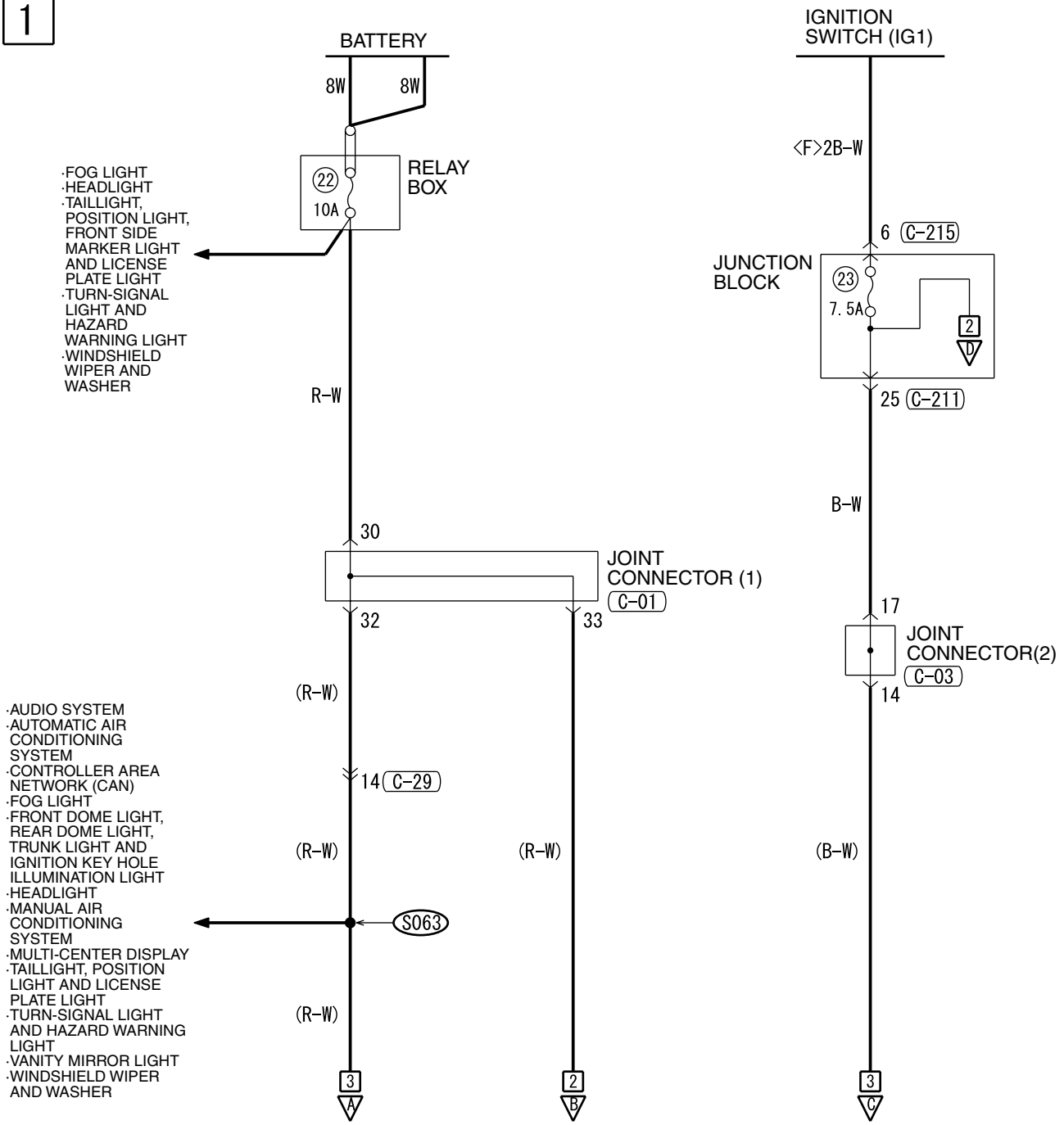

- FOG LIGHT
- HEADLIGHT
- TAILLIGHT, POSITION LIGHT, FRONT SIDE MARKER LIGHT AND LICENSE PLATE LIGHT
- TURN-SIGNAL LIGHT AND HAZARD WARNING LIGHT
- WINDSHIELD WIPER AND WASHER

- AUDIO SYSTEM
- AUTOMATIC AIR CONDITIONING SYSTEM
- CONTROLLER AREA NETWORK (CAN)
- FOG LIGHT
- FRONT DOME LIGHT, REAR DOME LIGHT, TRUNK LIGHT AND IGNITION KEY HOLE ILLUMINATION LIGHT
- HEADLIGHT
- MANUAL AIR CONDITIONING SYSTEM
- MULTI-CENTER DISPLAY
- TAILLIGHT, POSITION LIGHT AND LICENSE PLATE LIGHT
- TURN-SIGNAL LIGHT AND HAZARD WARNING LIGHT
- VANITY MIRROR LIGHT
- WINDSHIELD WIPER AND WASHER

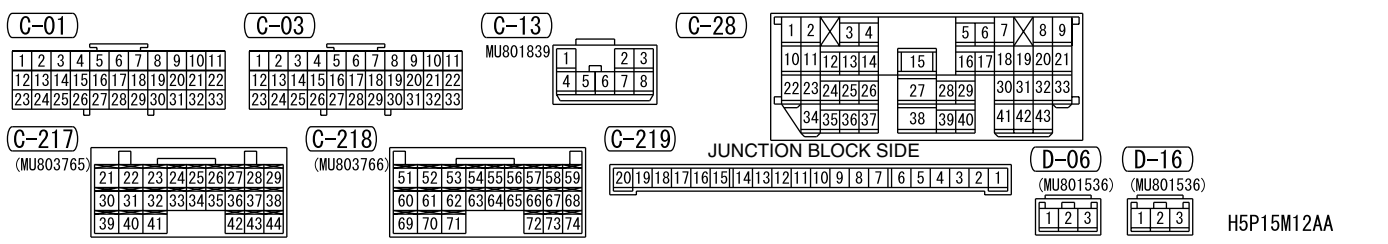

H5P15M12AA

2

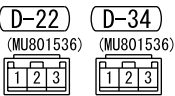
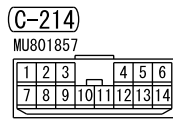
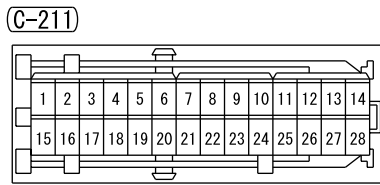
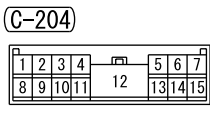
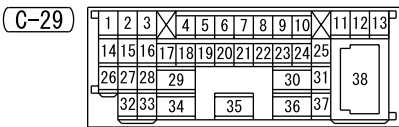
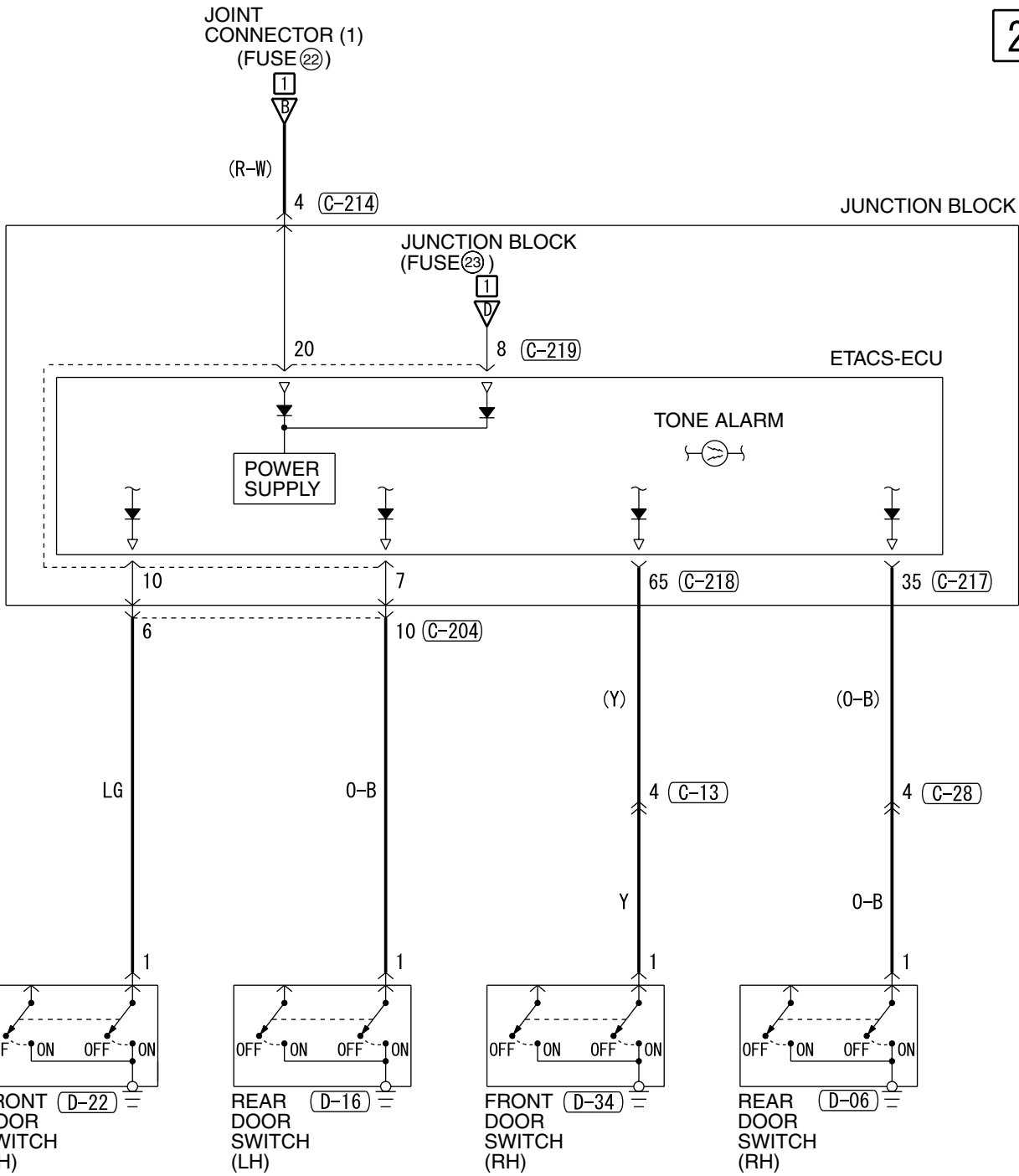

DOOR AJAR WARNING TONE ALARM (CONTINUED)

3

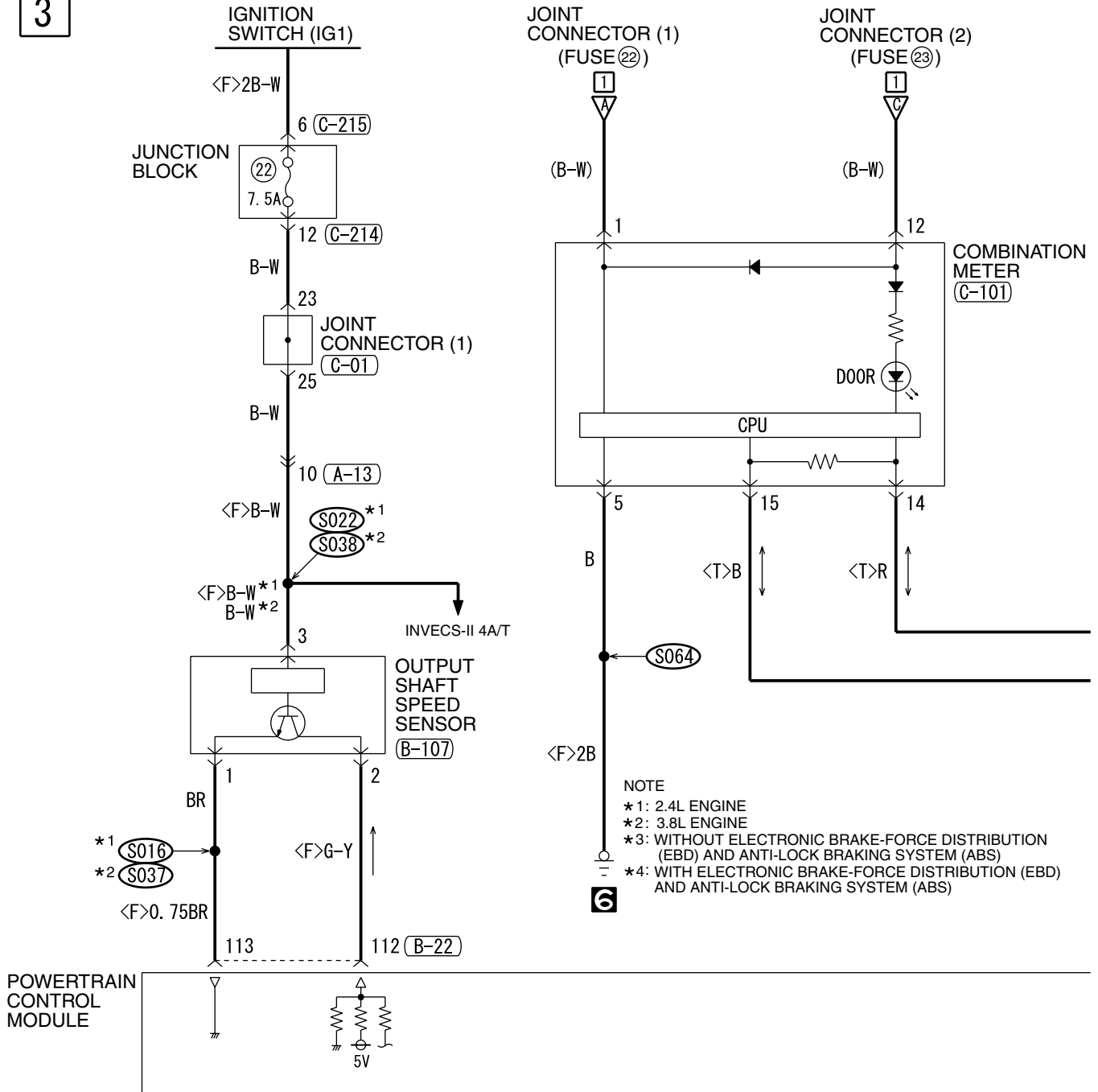

A-02

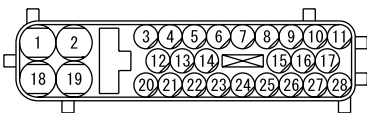

A-13

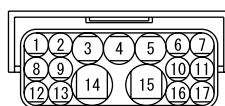

B-19



B-22

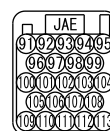

B-107



C-01



C-215



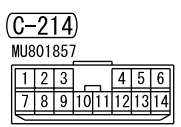
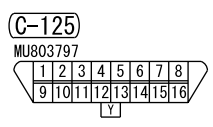
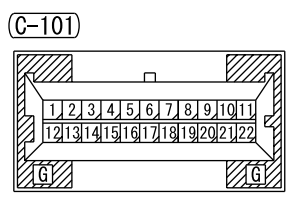
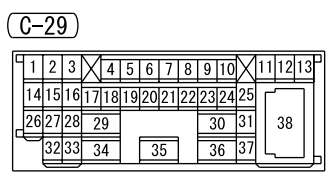
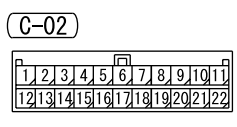
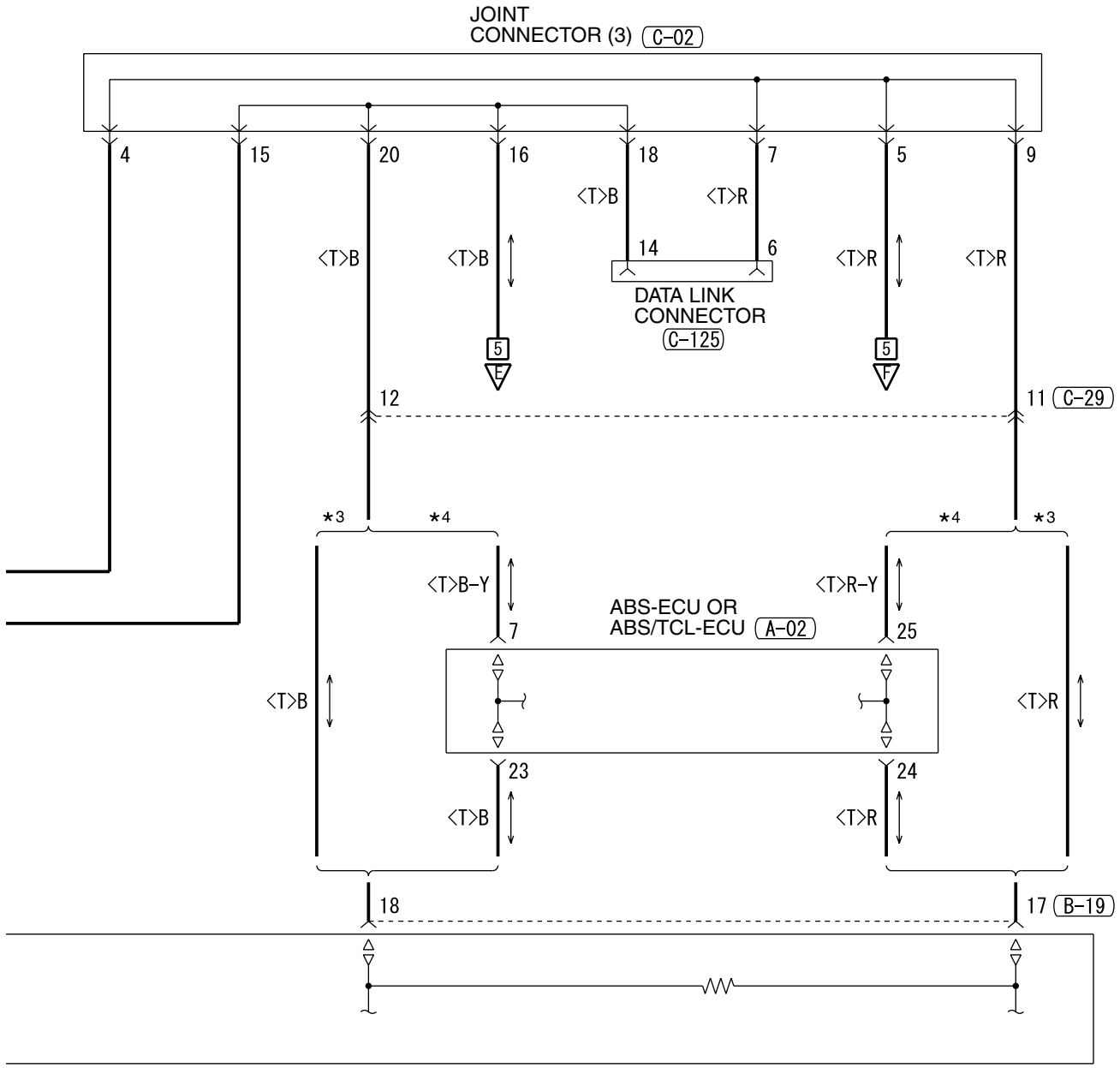







# CONTROLLER AREA NETWORK (CAN)

M1901004000118

1

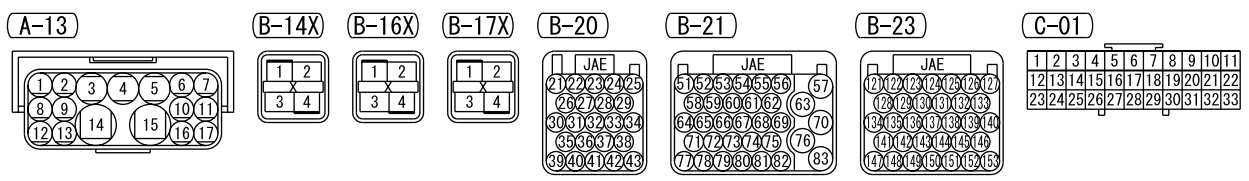
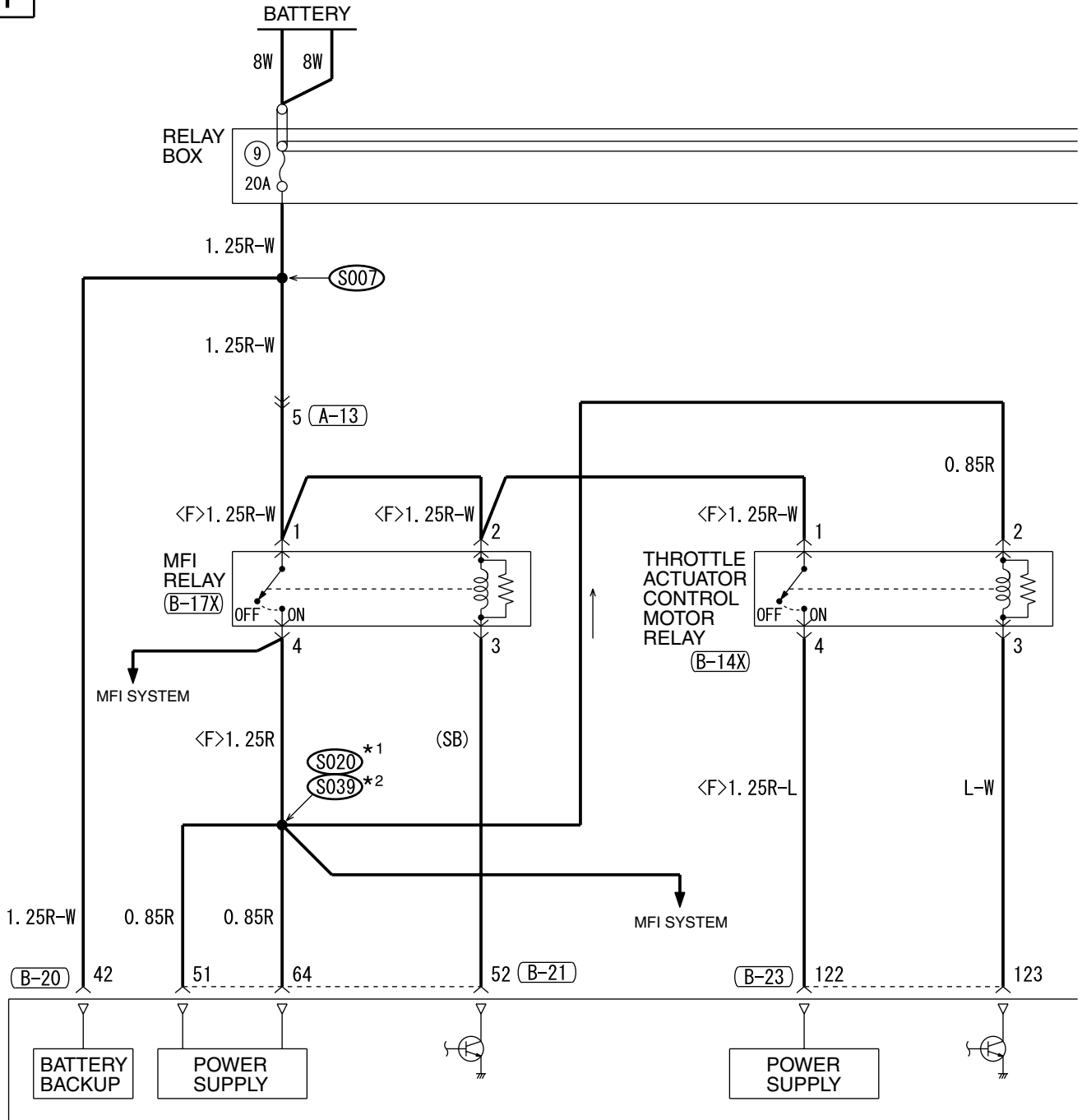

H5P15M14AA

TSB Revision

2

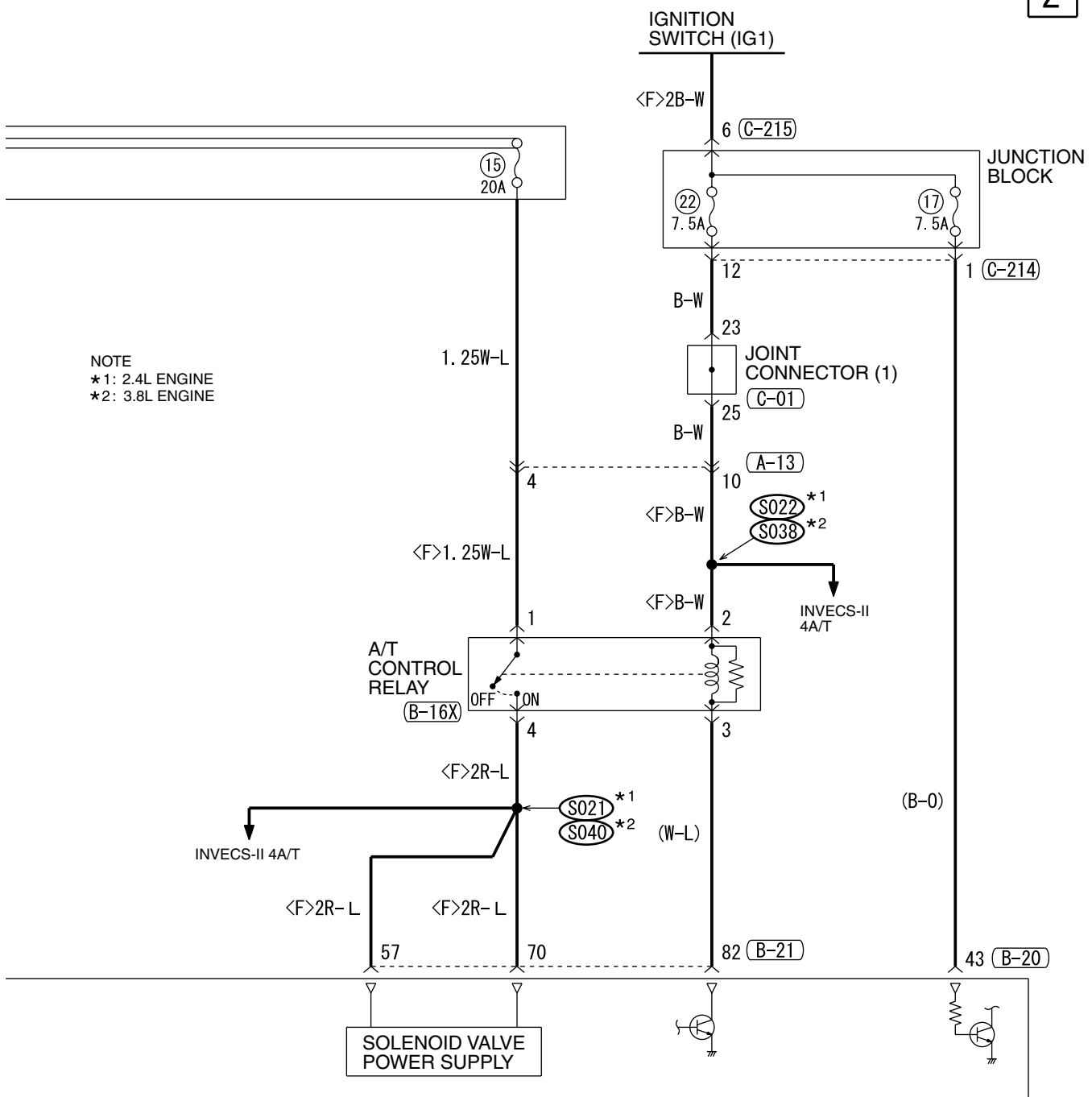

NOTE  
\*1: 2.4L ENGINE  
\*2: 3.8L ENGINE

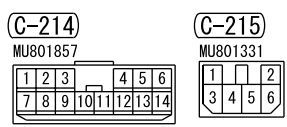

WIRE COLOR CODE  
 B: BLACK LG: LIGHT GREEN G: GREEN L: BLUE W: WHITE Y: YELLOW  
 SB: SKY BLUE BR: BROWN O: ORANGE GR: GRAY R: RED P: PINK V: VIOLET

H5P15M14AB

TSB Revision

CONTROLLER AREA NETWORK (CAN) (CONTINUED)

3

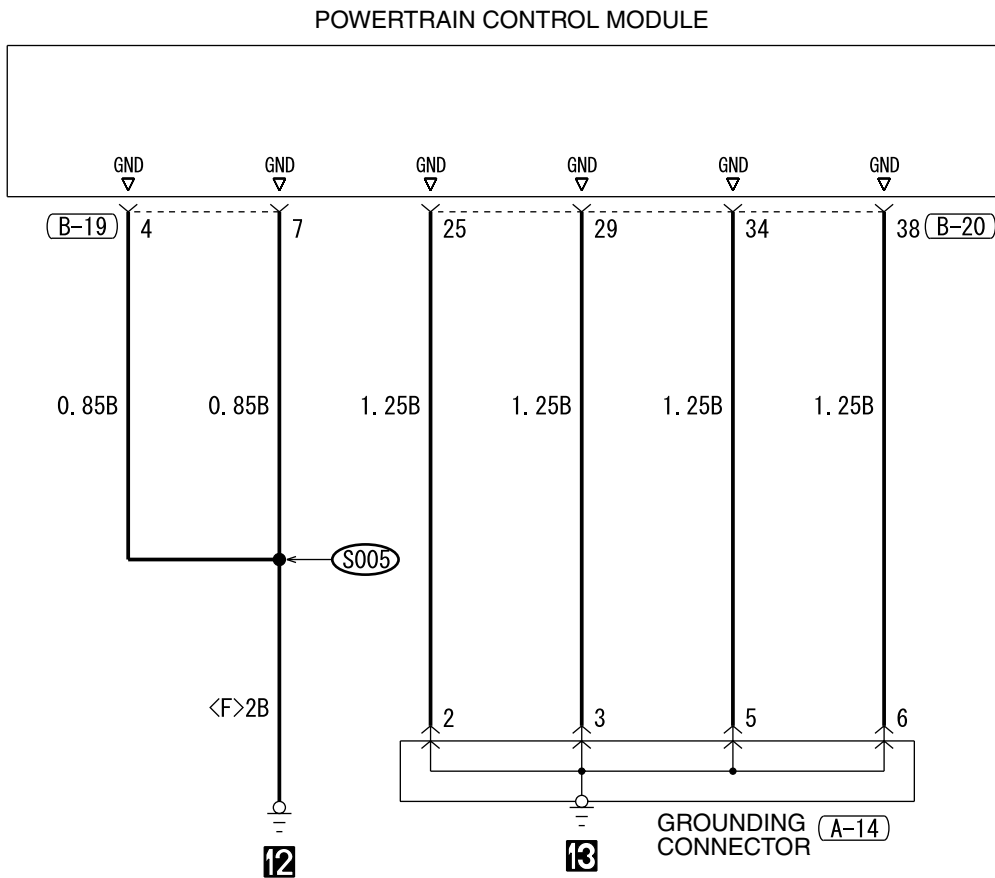

(A-14)  
(MU802755)



(B-19)

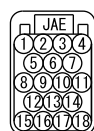

(B-20)

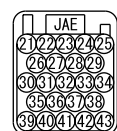

(C-03)

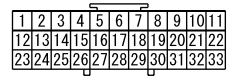

(C-05)

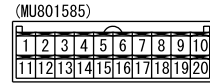

(C-29)

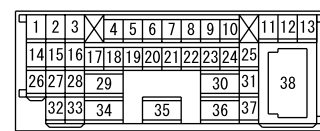

4

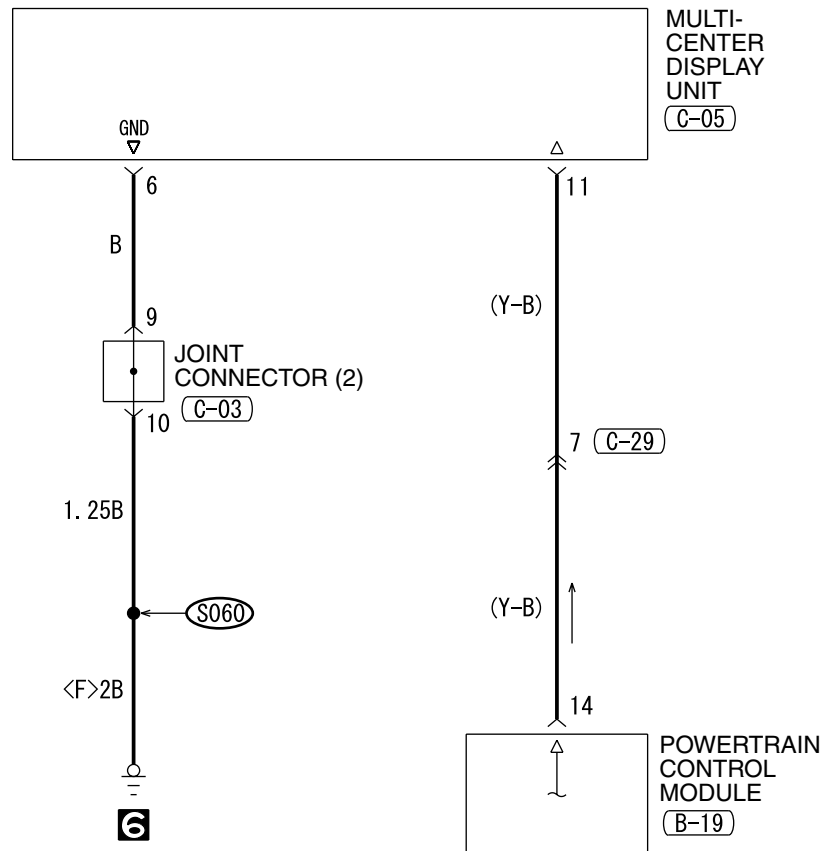

WIRE COLOR CODE  
 B : BLACK    LG : LIGHT GREEN    G : GREEN    L : BLUE    W : WHITE    Y : YELLOW  
 SB : SKY BLUE    BR : BROWN    O : ORANGE    GR : GRAY    R : RED    P : PINK    V : VIOLET

CONTROLLER AREA NETWORK (CAN) (CONTINUED)

5

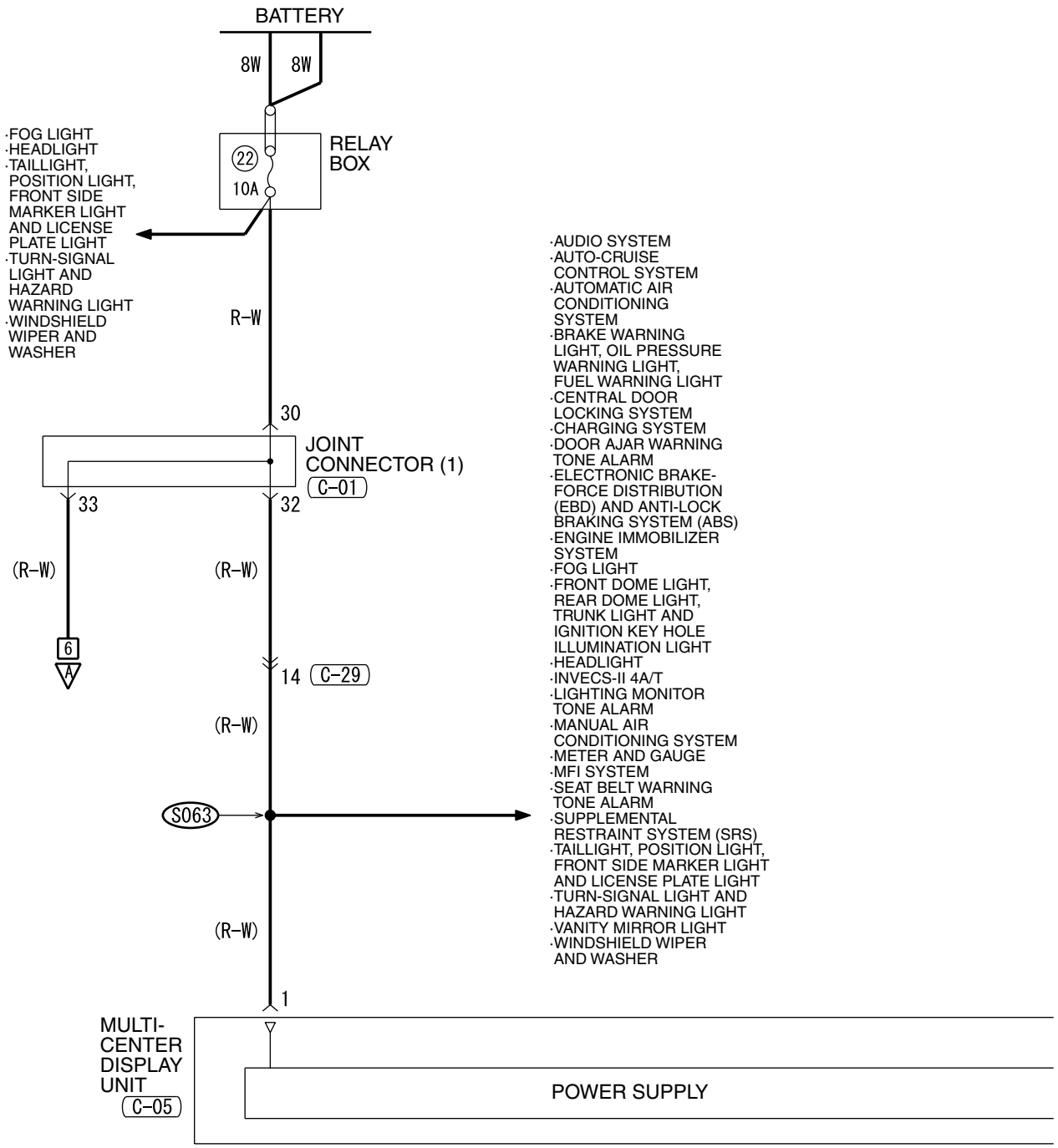

- FOG LIGHT
- HEADLIGHT
- TAILLIGHT, POSITION LIGHT, FRONT SIDE MARKER LIGHT AND LICENSE PLATE LIGHT
- TURN-SIGNAL LIGHT AND HAZARD WARNING LIGHT
- WINDSHIELD WIPER AND WASHER

- AUDIO SYSTEM
- AUTO-CRUISE CONTROL SYSTEM
- AUTOMATIC AIR CONDITIONING SYSTEM
- BRAKE WARNING LIGHT, OIL PRESSURE WARNING LIGHT, FUEL WARNING LIGHT
- CENTRAL DOOR LOCKING SYSTEM
- CHARGING SYSTEM
- DOOR AJAR WARNING TONE ALARM
- ELECTRONIC BRAKE-FORCE DISTRIBUTION (EBD) AND ANTI-LOCK BRAKING SYSTEM (ABS)
- ENGINE IMMOBILIZER SYSTEM
- FOG LIGHT
- FRONT DOME LIGHT, REAR DOME LIGHT, TRUNK LIGHT AND IGNITION KEY HOLE ILLUMINATION LIGHT
- HEADLIGHT
- INVECS-II 4A/T
- LIGHTING MONITOR
- TONE ALARM
- MANUAL AIR CONDITIONING SYSTEM
- METER AND GAUGE
- MFI SYSTEM
- SEAT BELT WARNING TONE ALARM
- SUPPLEMENTAL RESTRAINT SYSTEM (SRS)
- TAILLIGHT, POSITION LIGHT, FRONT SIDE MARKER LIGHT AND LICENSE PLATE LIGHT
- TURN-SIGNAL LIGHT AND HAZARD WARNING LIGHT
- VANITY MIRROR LIGHT
- WINDSHIELD WIPER AND WASHER

(C-01)

1	2	3	4	5	6	7	8	9	10	11
12	13	14	15	16	17	18	19	20	21	22
23	24	25	26	27	28	29	30	31	32	33

(C-03)

1	2	3	4	5	6	7	8	9	10	11
12	13	14	15	16	17	18	19	20	21	22
23	24	25	26	27	28	29	30	31	32	33

(C-05)

(MU801585)

1	2	3	4	5	6	7	8	9	10
11	12	13	14	15	16	17	18	19	20

(C-29)

1	2	3	4	5	6	7	8	9	10	11	12	13
14	15	16	17	18	19	20	21	22	23	24	25	
26	27	28	29						30	31		38
32	33	34			35				36	37		

(C-219) JUNCTION BLOCK SIDE

20	19	18	17	16	15	14	13	12	11	10	9	8	7	6	5	4	3	2	1
----	----	----	----	----	----	----	----	----	----	----	---	---	---	---	---	---	---	---	---

6

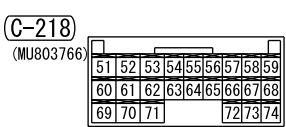
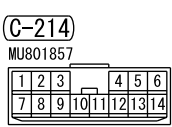
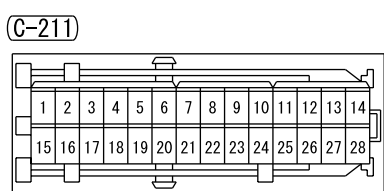
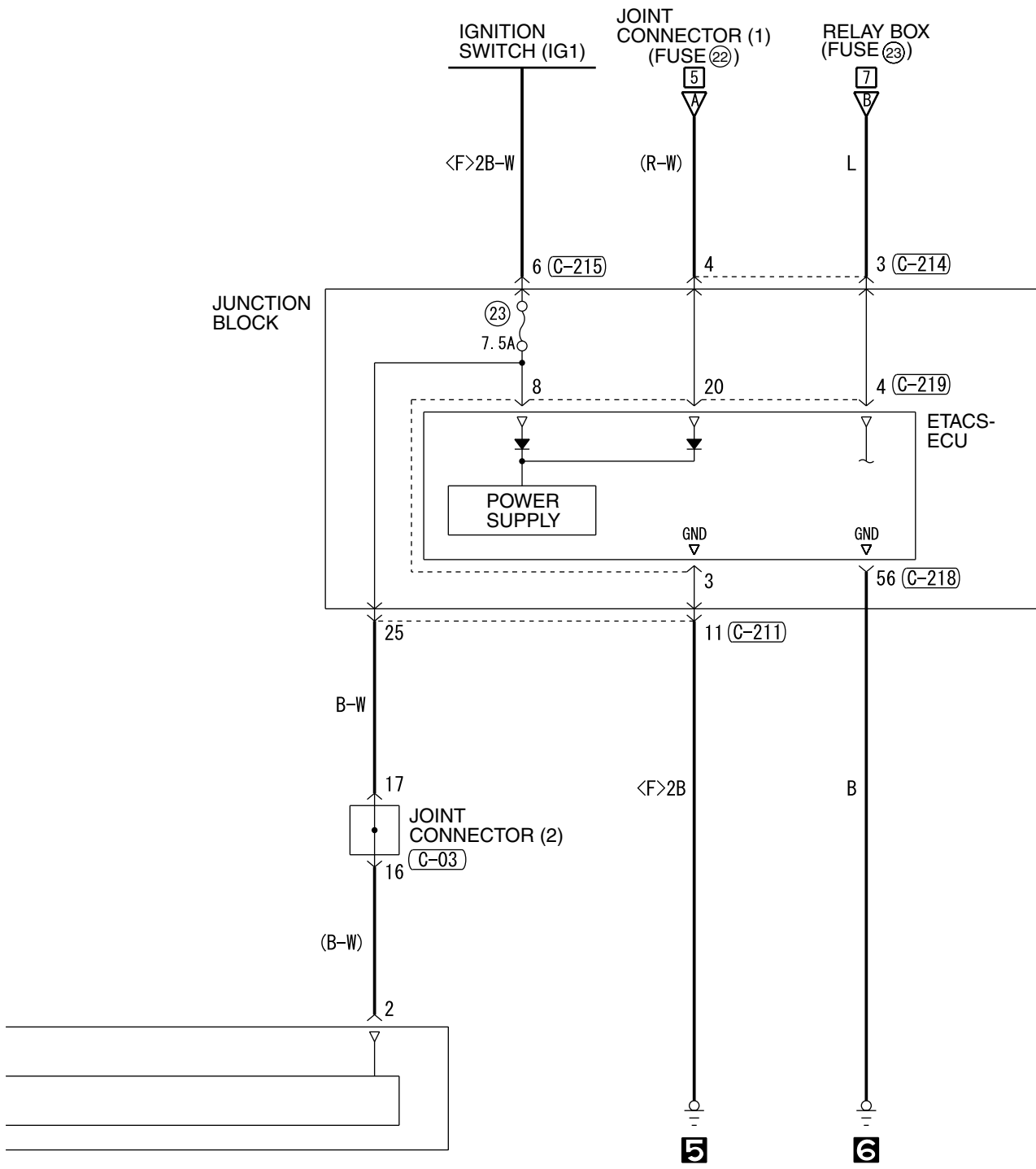

CONTROLLER AREA NETWORK (CAN) (CONTINUED)

7

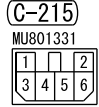
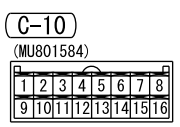
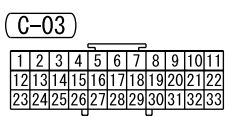
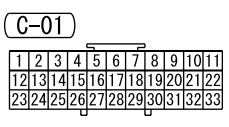
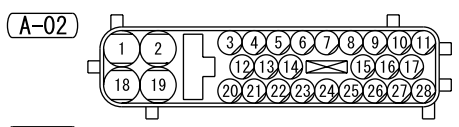
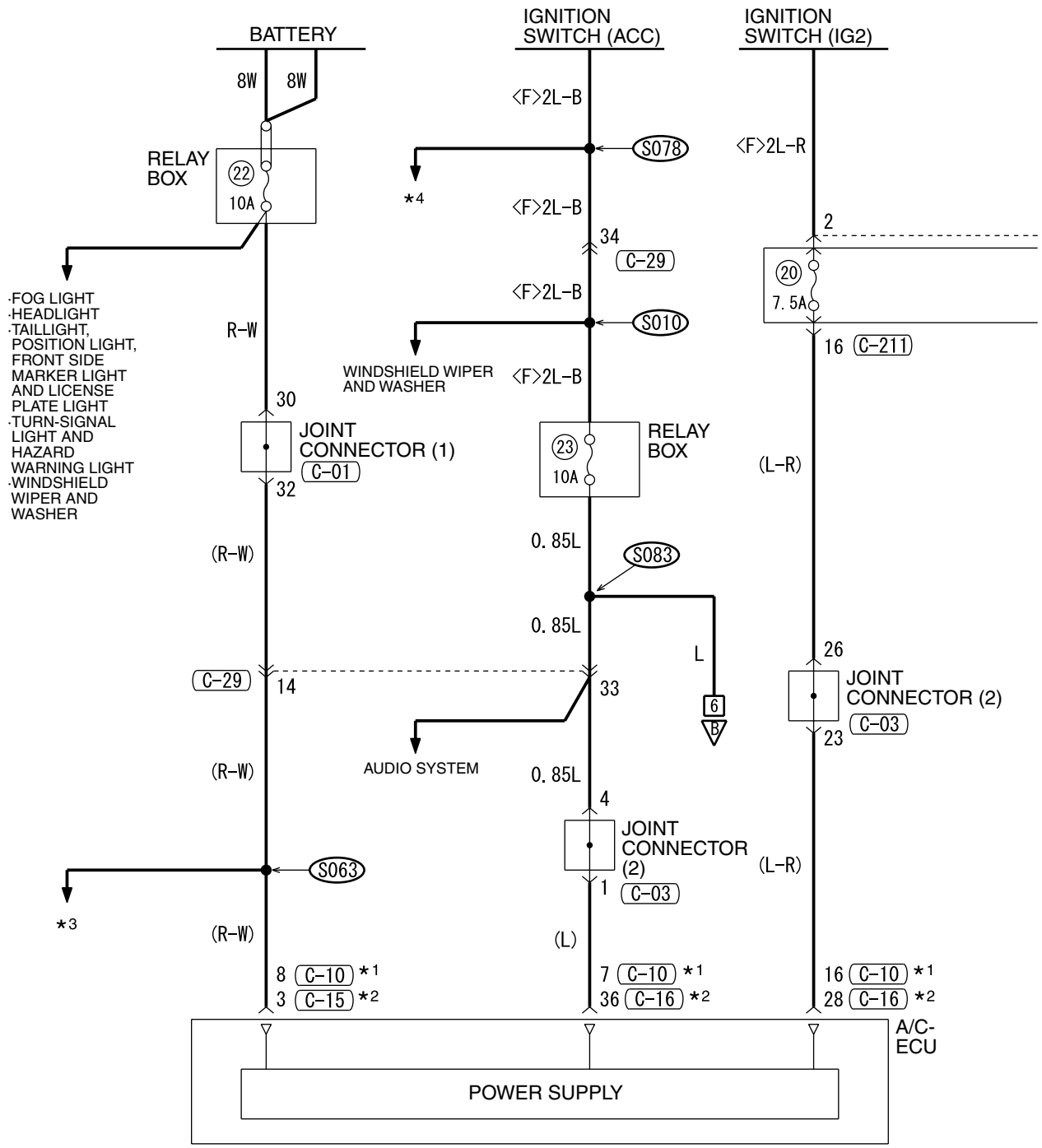



8

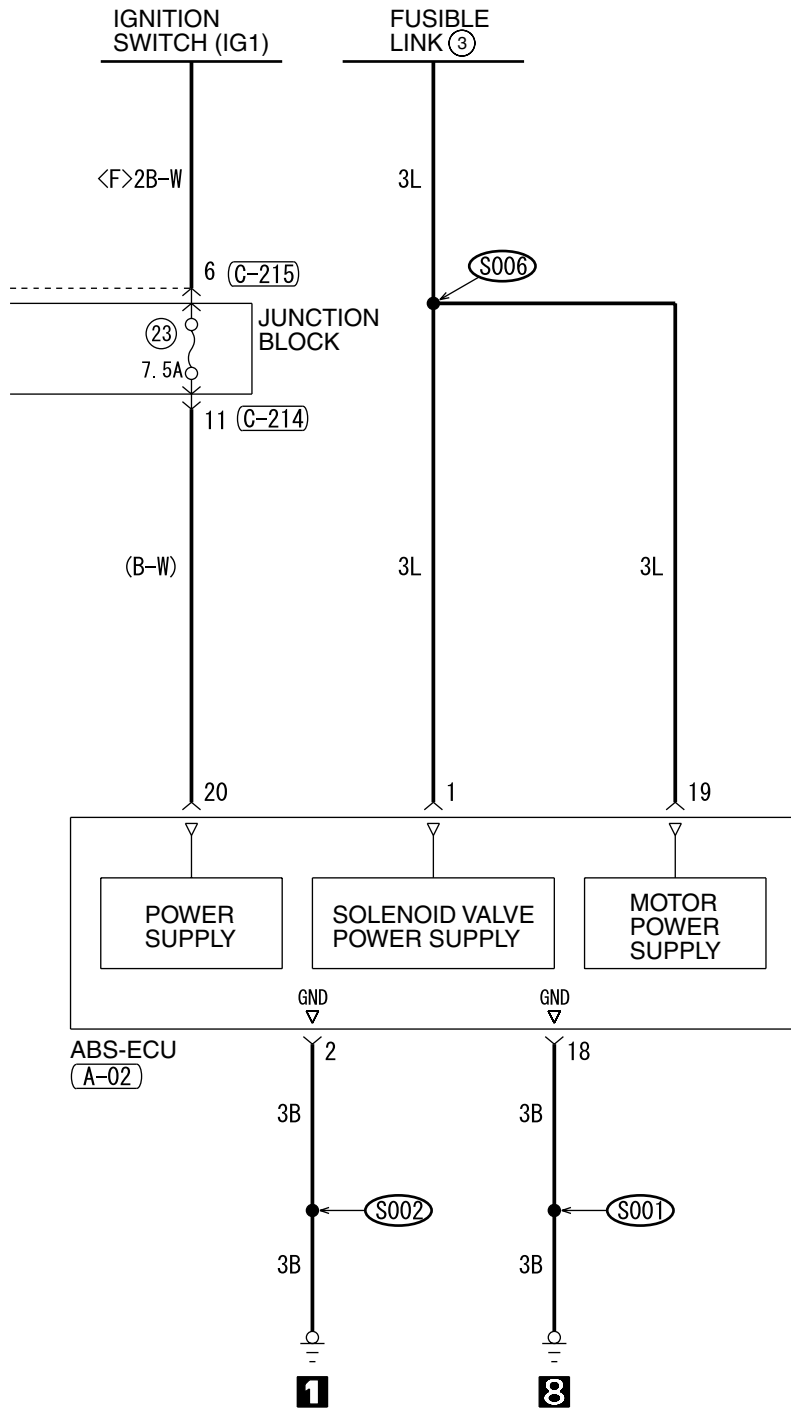

NOTE

- \*1 MANUAL AIR CONDITIONING SYSTEM <LOW>
- \*2 MANUAL AIR CONDITIONING SYSTEM <MIDDLE> OR AUTOMATIC AIR CONDITIONING SYSTEM
- \*3 : AUDIO SYSTEM  
 .AUTO-CRUISE CONTROL SYSTEM  
 .BRAKE WARNING LIGHT, OIL PRESSURE WARNING LIGHT, FUEL WARNING LIGHT  
 .CENTRAL DOOR LOCKING SYSTEM  
 .CHARGING SYSTEM  
 .DOOR AJAR WARNING TONE ALARM  
 .ELECTRONIC BRAKE-FORCE DISTRIBUTION (EBD) AND ANTI-LOCK BRAKING SYSTEM (ABS)  
 .ENGINE IMMOBILIZER SYSTEM  
 .FOG LIGHT  
 .FRONT DOME LIGHT, REAR DOME LIGHT, TRUNK LIGHT AND IGNITION KEY HOLE ILLUMINATION LIGHT  
 .HEADLIGHT  
 .INVECS-II 4A/T  
 .LIGHTING MONITOR TONE ALARM  
 .METER AND GAUGE  
 .MFI SYSTEM  
 .MULTI-CENTER DISPLAY  
 .SEAT BELT WARNING TONE ALARM  
 .SUPPLEMENTAL RESTRAINT SYSTEM (SRS)  
 .TAILLIGHT, POSITION LIGHT, FRONT SIDE MARKER LIGHT AND LICENSE PLATE LIGHT  
 .TURN-SIGNAL LIGHT AND HAZARD WARNING LIGHT  
 .VANITY MIRROR LIGHT  
 .WINDSHIELD WIPER AND WASHER
- \*4 : CENTRAL DOOR LOCKING SYSTEM  
 .FRONT DOME LIGHT, REAR DOME LIGHT, TRUNK LIGHT AND IGNITION KEY HOLE ILLUMINATION LIGHT  
 .REMOTE CONTROLLED MIRROR

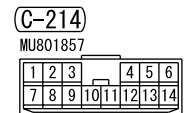
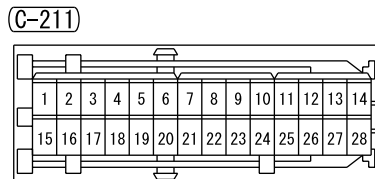
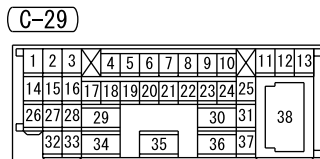
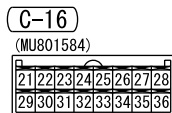
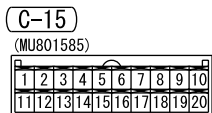

CONTROLLER AREA NETWORK (CAN) (CONTINUED)

9

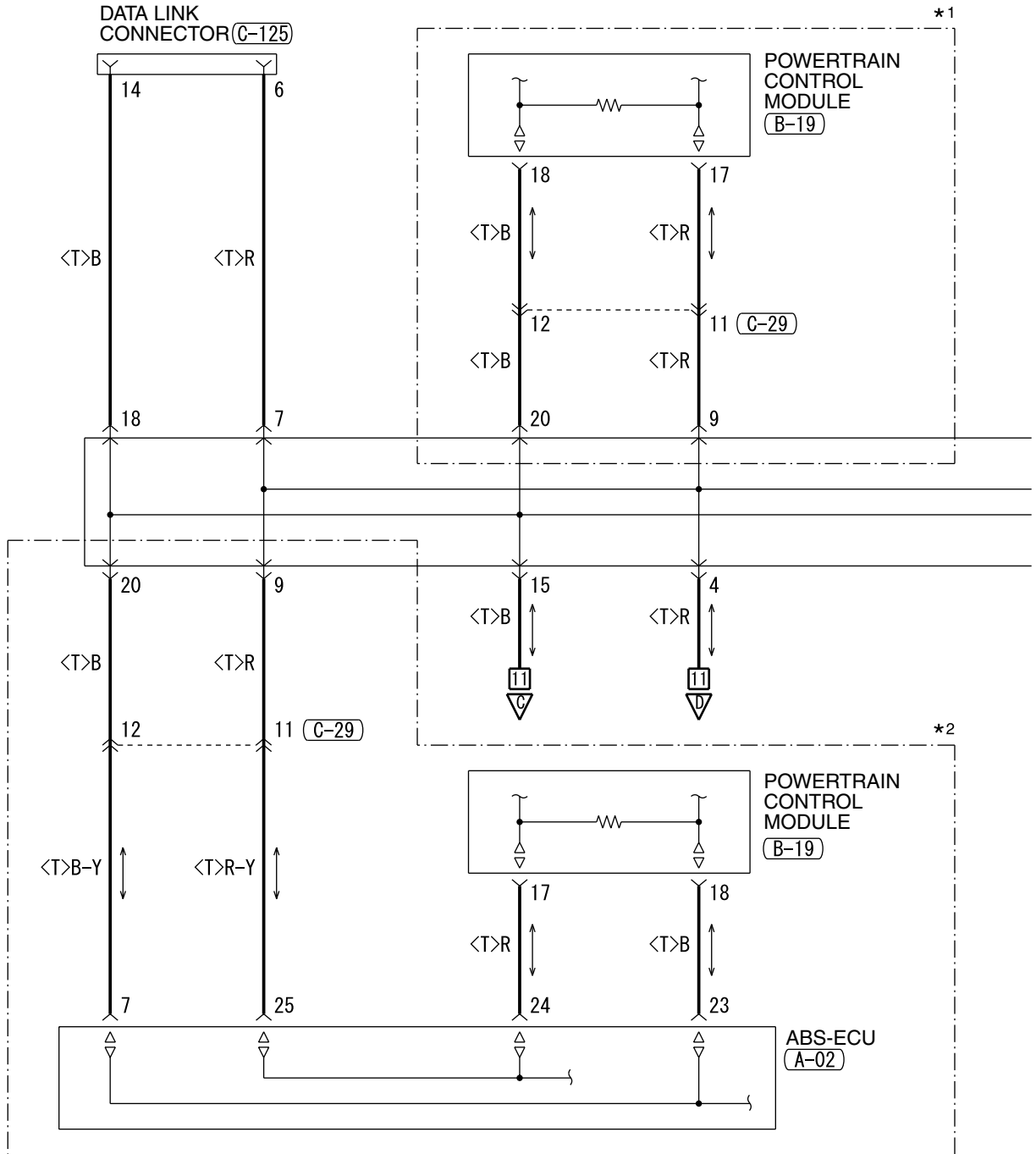

(A-02)

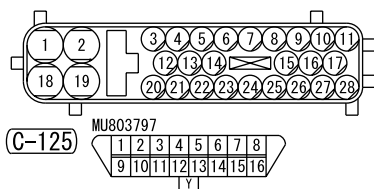

(B-19)

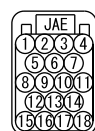

(C-02)

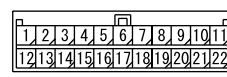

(C-218)

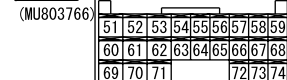

(C-05)

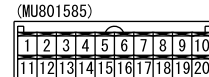

(C-10)

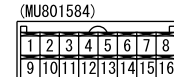

10

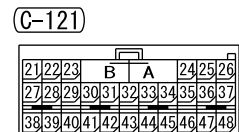
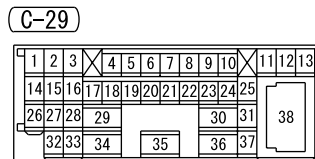
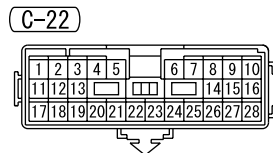
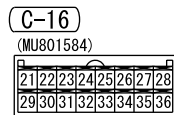
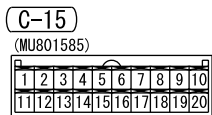
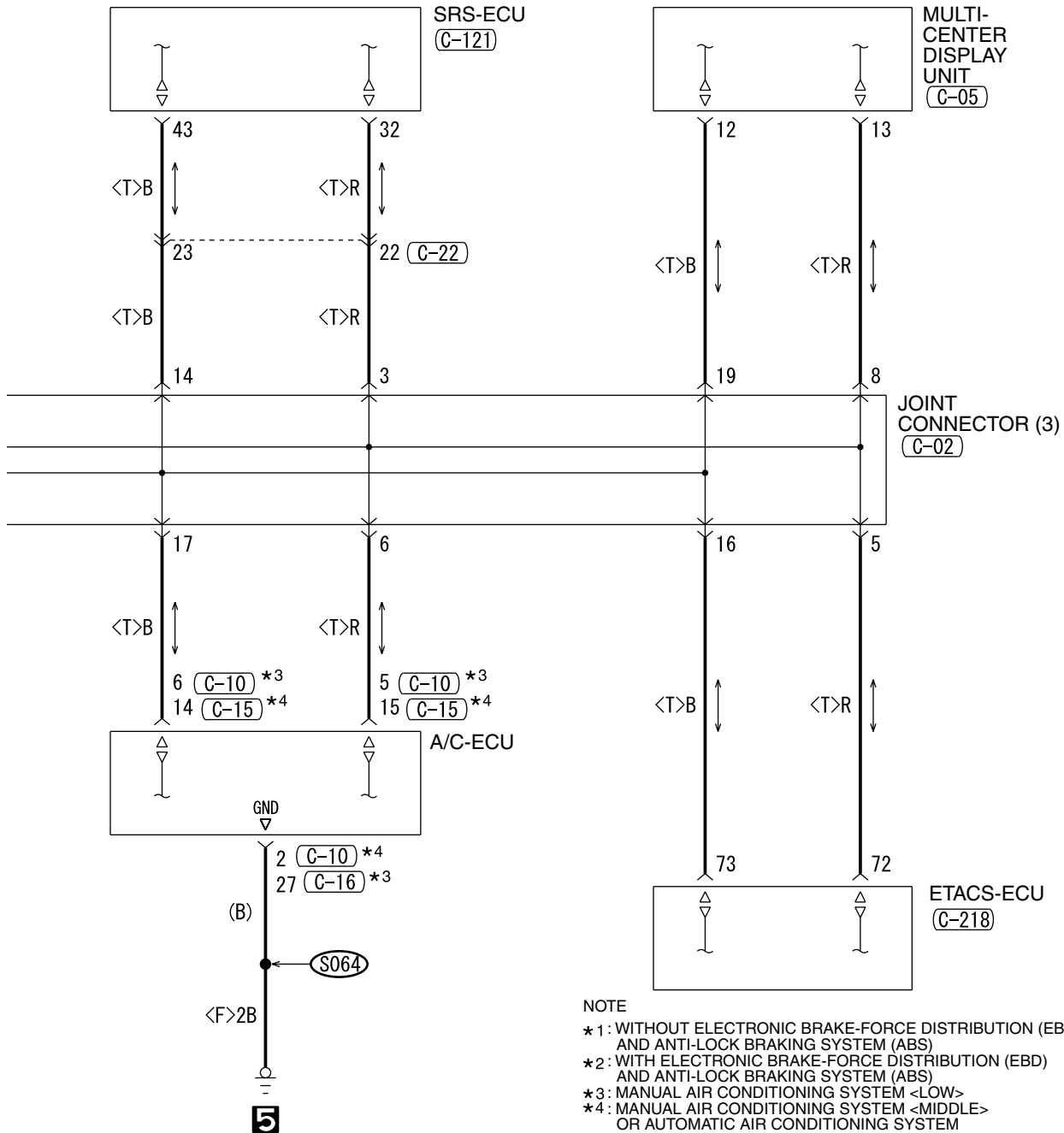

CONTROLLER AREA NETWORK (CAN) (CONTINUED)

11

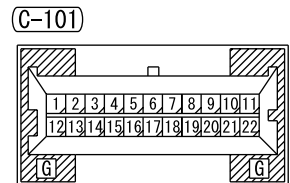
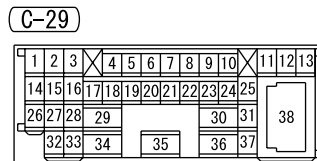
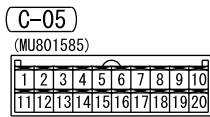
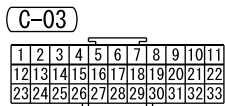
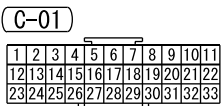
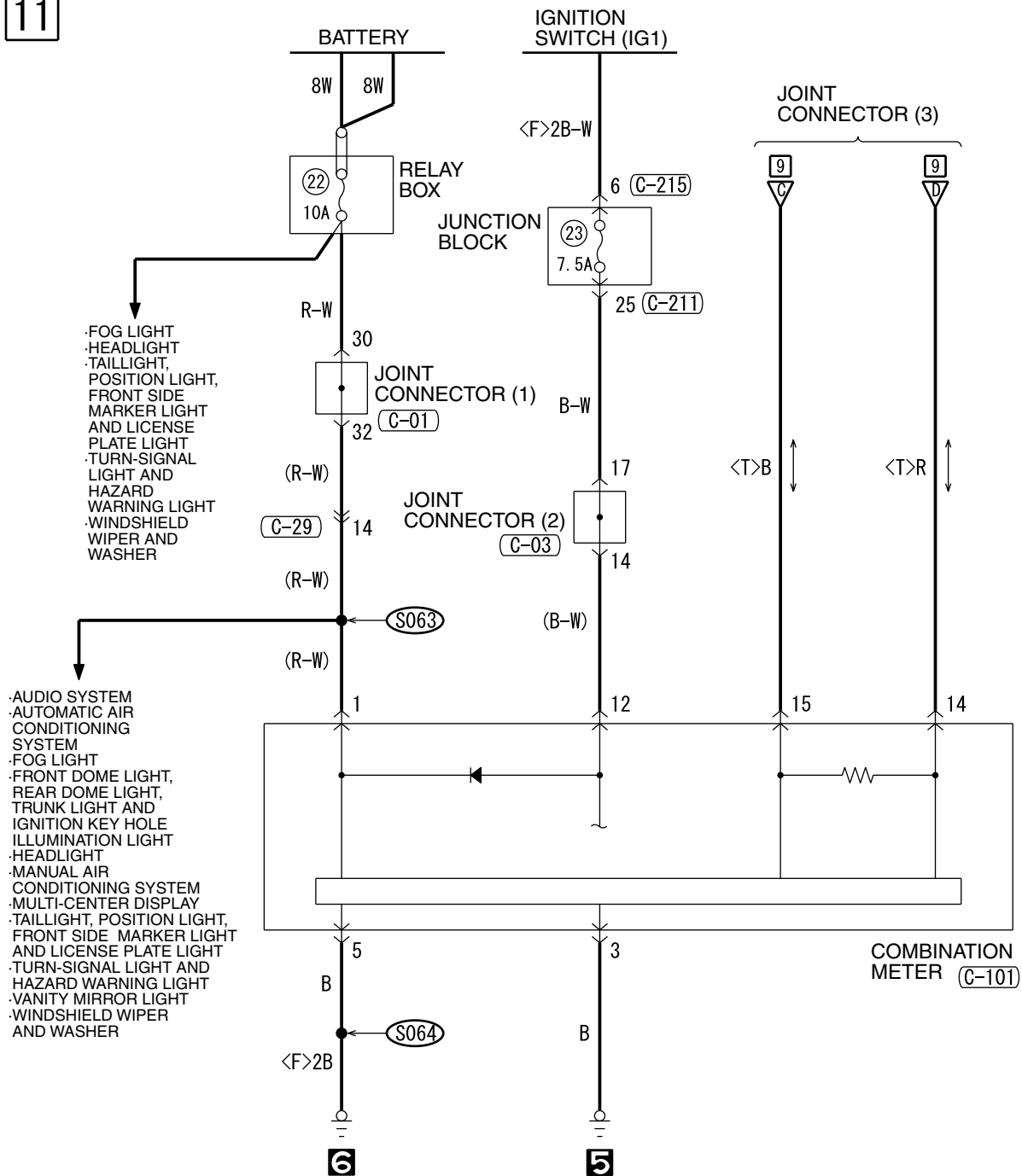

12

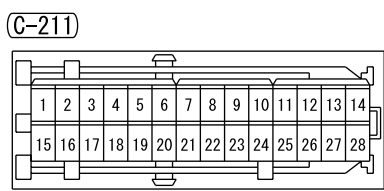
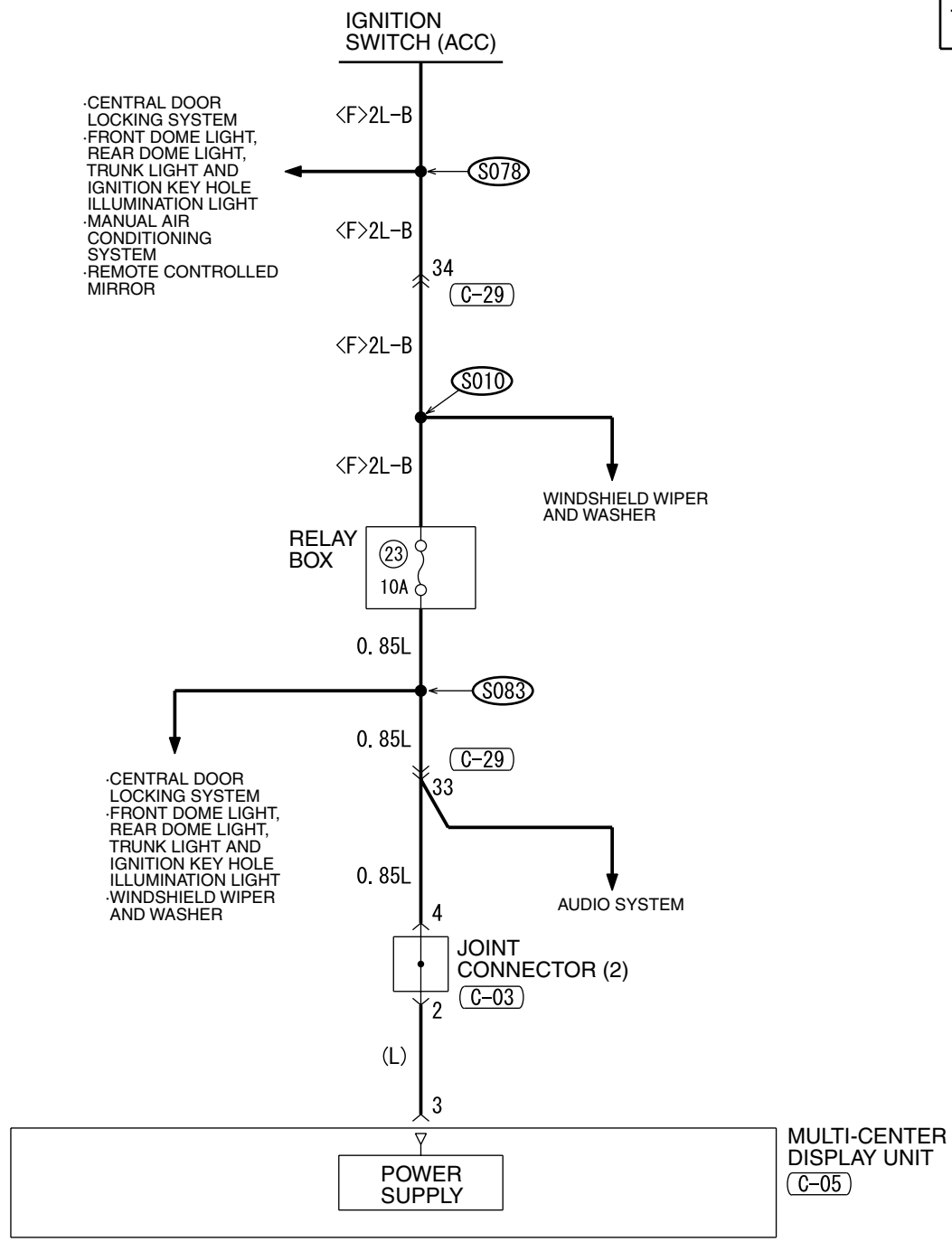

WIRE COLOR CODE  
 B: BLACK LG: LIGHT GREEN G: GREEN L: BLUE  
 BR: BROWN O: ORANGE GR: GRAY R: RED W: WHITE  
 SB: SKY BLUE P: PINK Y: YELLOW V: VIOLET

---

## NOTES