

GENERAL INFORMATION

SECTION **GI**

GI

MA

EM

LC

EF &
EC

FE

CL

MT

AT

TF

PD

FA

RA

BR

ST

BF

HA

EL

IDX

CONTENTS

PRECAUTIONS	2	Model Variation.....	14
General Precautions.....	2	Identification Number.....	17
Precautions for Multiport Fuel Injection System or ECCS Engine.....	3	Dimensions.....	20
Precautions for a Three Way Catalyst.....	4	Wheels & Tires.....	21
Engine Oils.....	4	LIFTING POINTS AND TOW TRUCK TOWING	22
Precautions for Fuel.....	5	Screw Jack.....	22
HOW TO USE THIS MANUAL	6	Garage Jack and Safety Stand.....	22
HOW TO READ WIRING DIAGRAM	8	2-pole Lift.....	23
HOW TO FOLLOW FLOW CHART IN TROUBLE		Tow Truck Towing.....	24
DIAGNOSES	11	TIGHTENING TORQUE OF STANDARD BOLTS	26
IDENTIFICATION INFORMATION	14	SAE J1930 TERMINOLOGY LIST	27
		SAE J1930 Terminology List.....	27

STARTING IDENTIFICATION NUMBER NISSAN SHATAI HIRATSUKA PLANT

JN6SD11S*RX431001
 JN6HD12S*RX428001
 JN6SD16S*RX433001
 JN6HD16S*RX428001
 JN6SD11Y*RX428001
 JN6HD11Y*RX428001
 JN6SD16Y*RX428001
 JN6HD16Y*RX429001

KYUSHU PLANT

JN8HD17S*RW200001
 JN8HD17Y*RW200001
 JN6HD17S*RW200001

PRECAUTIONS

The following precautions should be observed to ensure safe and proper service operations. These precautions are not described in each individual section.

General Precautions

1. Do not operate the engine for an extended period of time without proper exhaust ventilation.
Keep the work area well ventilated and free of any inflammable materials. Special care should be taken when handling any inflammable or poisonous materials, such as gasoline, refrigerant gas, etc. When working in a pit or other enclosed area, be sure to properly ventilate the area before working with hazardous materials.
Do not smoke while working on the vehicle.
2. Before jacking up the vehicle, apply wheel chocks or other tire blocks to the wheels to prevent the vehicle from moving. After jacking up the vehicle, support the vehicle weight with safety stands at the points designated for proper lifting before working on the vehicle.
These operations should be done on a level surface.
3. When removing a heavy component such as the engine or transaxle/transmission, take care not to lose your balance and drop it. Also, do not allow it to hit against adjacent parts, especially brake tube and brake master cylinder.
4. Before starting repairs which do not require battery power, always turn off the ignition switch, then disconnect the ground cable from the battery to prevent accidental short circuit.
5. To prevent serious burns, avoid contact with hot metal parts such as the radiator, exhaust manifold, tail pipe and muffler.
Do not remove the radiator cap when the engine is hot.
6. To prevent scratches and soiling, protect fenders, upholstery and carpeting with appropriate covers before starting servicing.
Take caution that keys, buckles or buttons on your person do not scratch the paint.

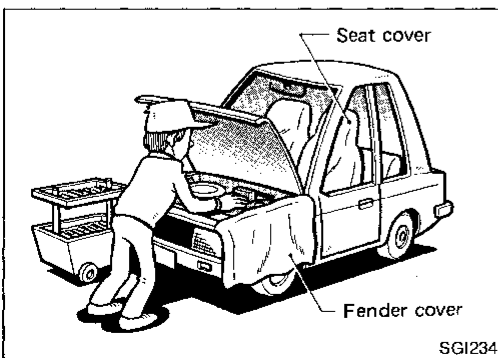
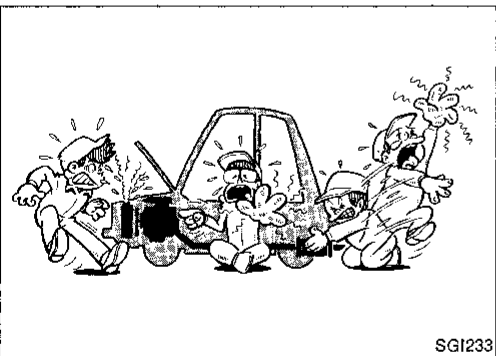
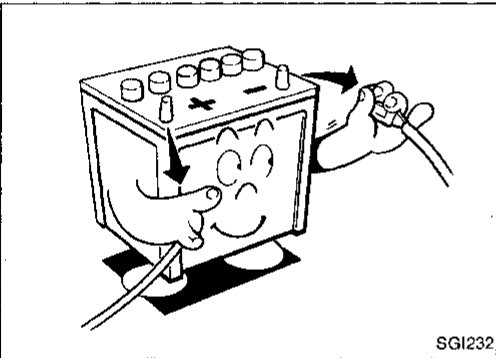
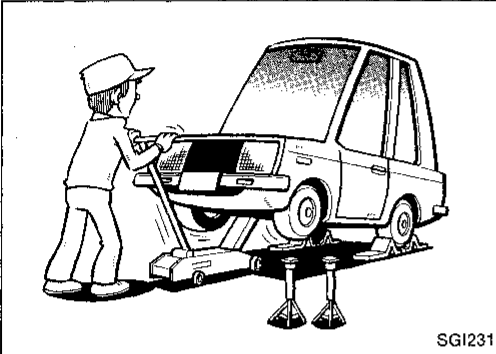
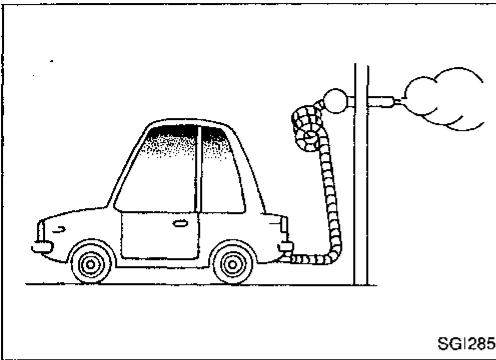

PRECAUTIONS

General Precautions (Cont'd)

7. Clean all disassembled parts in the designated liquid or solvent prior to inspection or assembly.
8. Replace oil seals, gaskets, packings, O-rings, locking washers, cotter pins, self-locking nuts, etc. as instructed and discard used ones.
9. Tapered roller bearings and needle bearings should be replaced as a set of inner and outer races.
10. Arrange the disassembled parts in accordance with their assembled locations and sequence.
11. Do not touch the terminals of electrical components which utilize microcomputers such as ECMs. Static electrical charges stored in your body may damage internal electronic components.
12. After disconnecting vacuum hose or air hose, attach tag which indicates the proper connection to prevent incorrect connection.
13. Use only the fluids and the lubricants specified in MA section, or their equivalents.
14. Use approved bonding agent, sealants or their equivalents when required.
15. The use of the proper tools and recommended essential tools should be used where specified for proper, safe and efficient service repairs.
16. When effecting repairs on the fuel, oil, water, vacuum or exhaust systems, make certain to check all affected lines for leaks.
17. Dispose of drained oil or the solvent used for cleaning parts in an appropriate manner.

GI

MA

EM

LC

EF &
EC

FE

CL

MT

AT

TF

PD

FA

RA

BR

ST

BF

HA

EL

IDX

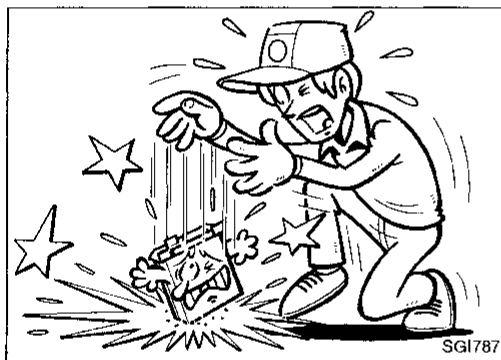

Precautions for Multiport Fuel Injection System or ECCS Engine

1. Before connecting or disconnecting multiport fuel injection system or ECCS harness connector to or from any multiport fuel injection system or ECM (ECCS control module), be sure to turn the ignition switch to the "OFF" position and disconnect the negative battery terminal. Otherwise, there may be damage to ECM.
2. Before disconnecting pressurized fuel line from fuel pump to injectors, be sure to release fuel pressure to eliminate danger.
3. Be careful not to jar components such as ECM and mass air flow sensor.

PRECAUTIONS

Precautions for a Three Way Catalyst

If a large amount of unburned fuel flows into the converter, the converter temperature will be excessively high. To prevent this, follow the procedure below.

1. Use unleaded gasoline only. Leaded gasoline will seriously damage the three way catalyst.
2. When checking for ignition spark or measuring engine compression, make tests quickly and only when necessary.
3. Do not run engine when the fuel tank level is low, otherwise the engine may misfire causing damage to the converter.
4. Do not place the vehicle on inflammable material. Keep inflammable material off the exhaust pipe.

Engine Oils

Prolonged and repeated contact with mineral oil will result in the removal of natural fats from the skin, leading to dryness, irritation and dermatitis. In addition, used engine oil contains potentially harmful contaminants which may cause skin cancer. Adequate means of skin protection and washing facilities must be provided.

HEALTH PROTECTION PRECAUTIONS

1. Avoid prolonged and repeated contact with oils, particularly used engine oils.
2. Wear protective clothing, including impervious gloves where practicable.
3. Do not put oily rags in pockets.
4. Avoid contaminating clothes, particularly underpants, with oil.
5. Heavily soiled clothing and oil-impregnated footwear should not be worn. Overalls must be cleaned regularly.
6. First Aid treatment should be obtained immediately for open cuts and wounds.
7. Use barrier creams, applying them before each work period, to help the removal of oil from the skin.
8. Wash with soap and water to ensure all oil is removed (skin cleansers and nail brushes will help). Preparations containing lanolin replace the natural skin oils which have been removed.
9. Do not use gasoline, kerosine, diesel fuel, gas oil, thinners or solvents for cleaning skin.
10. If skin disorders develop, obtain medical advice without delay.
11. Where practicable, degrease components prior to handling.
12. Where there is a risk of eye contact, eye protection should be worn, for example, chemical goggles or face shields; in addition an eye wash facility should be provided.

ENVIRONMENTAL PROTECTION PRECAUTIONS

Burning used engine oil in small space heaters or boilers can be recommended only for units of approved design. The heating system must meet the requirements of HM Inspectorate of Pollution for small burners of less than 0.4 MW. If in doubt check with the appropriate local authority and/or manufacturer of the approved appliance.

PRECAUTIONS

Engine Oils (Cont'd)

Dispose of used oil and used oil filters through authorized waste disposal contractors to licensed waste disposal sites, or to the waste oil reclamation trade. If in doubt, contact the local authority for advice on disposal facilities.

It is illegal to pour used oil on to the ground, down sewers or drains, or into water courses.

The regulations concerning the pollution of the environment will vary from country to country.

Precautions for Fuel

Use unleaded gasoline with an octane rating of at least 87 AKI (Anti-Knock Index) number (research octane number 91).

CAUTION:

Do not use leaded gasoline. Using leaded gasoline will damage the three way catalyst.

GI

MA

EM

LC

EF &
EC

FE

CL

MT

AT

TF

PD

FA

RA

BR

ST

BF

HA

EL

IDX

HOW TO USE THIS MANUAL



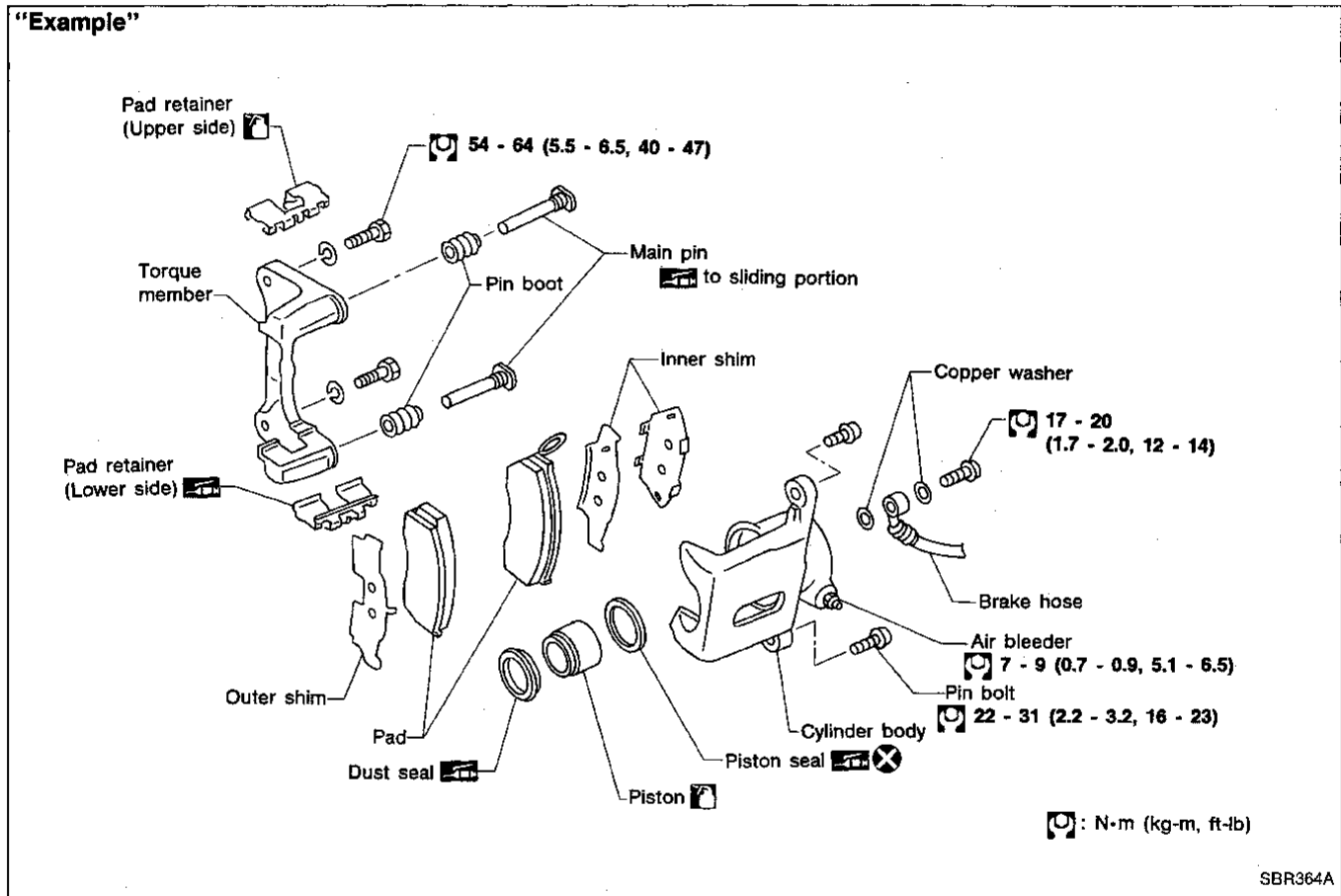







1. **ALPHABETICAL INDEX** is provided at the end of this manual so that you can rapidly find the item and page you are searching for.
2. **A QUICK REFERENCE INDEX**, a black tab (e.g. **BR**) is provided on the first page. You can quickly find the first page of each section by mating it to the section's black tab.
3. **THE CONTENTS** are listed on the first page of each section.
4. **THE TITLE** is indicated on the upper portion of each page and shows the part or system.
5. **THE PAGE NUMBER** of each section consists of two letters which designate the particular section and a number (e.g. "BR-5").
6. **THE LARGE ILLUSTRATIONS** are exploded views (See below) and contain tightening torques, lubrication points and other information necessary to perform repairs. The illustrations should be used in reference to service matters only. When ordering parts, refer to the appropriate **PARTS CATALOG**.



7. **THE SMALL ILLUSTRATIONS** show the important steps such as inspection, use of special tools, knacks of work and hidden or tricky steps which are not shown in the previous large illustrations. Assembly, inspection and adjustment procedures for the complicated units such as the automatic transaxle or transmission, etc. are presented in a step-by-step format where necessary.

HOW TO USE THIS MANUAL

8. The following **SYMBOLS AND ABBREVIATIONS** are used:

- | | |
|--|---|
| <p> : Tightening Torque</p> <p> : Should be lubricated with grease.
Unless otherwise indicated, use recommended multi-purpose grease.</p> <p> : Should be lubricated with oil.</p> <p> : Sealing point</p> <p> (L) : Apply locking sealant.</p> <p> : Checking point</p> <p> (X) : Always replace after every disassembly.</p> <p> (P) : Apply petroleum jelly.</p> <p> (H) : High-temperature grease points</p> <p> (ATF) : Apply ATF.</p> <p>★ : Select with proper thickness.</p> <p>☆ : Adjustment is required.</p> <p>SDS : Service Data and Specifications</p> | <p>LH, RH : Left-Hand, Right-Hand</p> <p>M/T : Manual Transaxle/Transmission</p> <p>A/T : Automatic Transaxle/Transmission</p> <p>4x4 , 4WD : 4-Wheel Drive</p> <p>2WD : 2-Wheel Drive</p> <p>Tool : Special Service Tools</p> <p>ATF : Automatic Transmission Fluid</p> <p>D₁ : Drive range 1st gear</p> <p>D₂ : Drive range 2nd gear</p> <p>D₃ : Drive range 3rd gear</p> <p>D₄ : Drive range 4th gear</p> <p>OD : Overdrive</p> <p>2₂ : 2nd range 2nd gear</p> <p>2₁ : 2nd range 1st gear</p> <p>1₂ : 1st range 2nd gear</p> <p>1₁ : 1st range 1st gear</p> |
|--|---|

9. The **UNITS** given in this manual are primarily expressed as the SI UNIT (International System of Unit), and alternatively expressed in the metric system and in the yard/pound system.

“Example”

Tightening torque:

59 - 78 N·m (6.0 - 8.0 kg-m, 43 - 58 ft-lb)

10. **TROUBLE DIAGNOSES** are included in sections dealing with complicated components.
11. **SERVICE DATA AND SPECIFICATIONS** are contained at the end of each section for quick reference of data.
12. The captions **WARNING** and **CAUTION** warn you of steps that must be followed to prevent personal injury and/or damage to some part of the vehicle.
- **WARNING** indicates the possibility of personal injury if instructions are not followed.
 - **CAUTION** indicates the possibility of component damage if instructions are not followed.
 - **BOLD TYPED STATEMENTS** except **WARNING** and **CAUTION** give you helpful information.

GI

MA

EM

LC

EF &
EC

FE

CL

MT

AT

TF

PD

FA

RA

BR

ST

BF

HA

EL

IDX

HOW TO READ WIRING DIAGRAM

Example

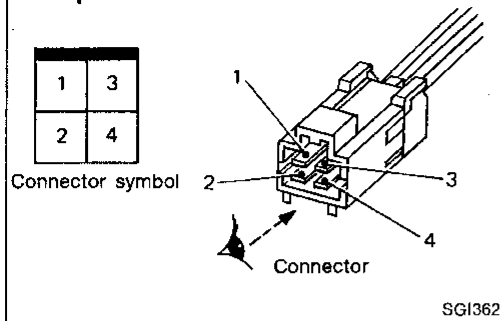

CONNECTOR SYMBOLS

- All connector symbols in wiring diagrams are shown from the terminal side.

Example

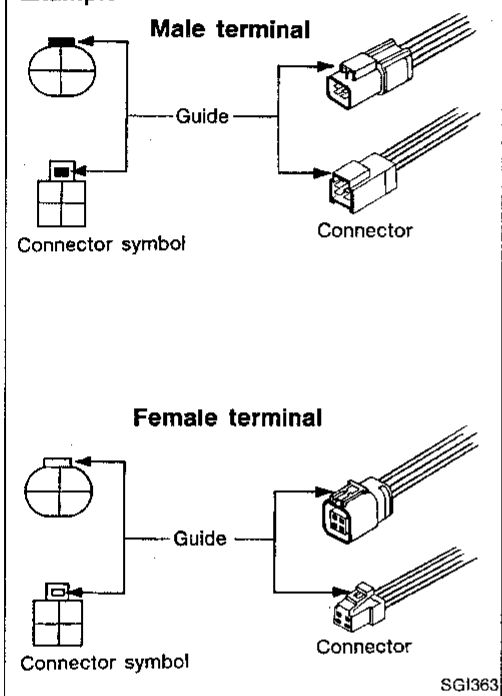

- Male and female terminals
Connector guides for male terminals are shown in black and female terminals in white in wiring diagrams.

MULTIPLE SWITCH

The continuity of the multiple switch is identified in the switch chart in wiring diagrams.

Example

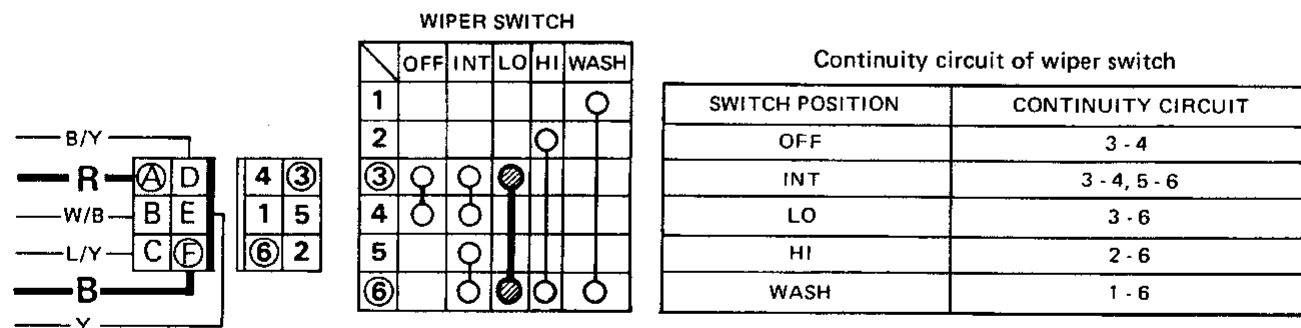

Example: Wiper switch in LO position

Continuity circuit: Red wire - (A) terminal - (3) terminal - Wiper switch (● - ● : LO) - (6) terminal - (F) terminal - Black wire

SGI365

GI

MA

EM

LC

EF &
EC

FE

CL

MT

AT

TF

PD

FA

RA

BR

ST

BF

HA

EL

IDX

HOW TO READ WIRING DIAGRAM

SUPER MULTIPLE JUNCTION (SMJ)

- The "SMJ" indicated in wiring diagrams is shown in a simplified form. The terminal arrangement should therefore be referred to in the foldout at the end of the Service Manual.
- The foldout should be spread to read the entire wiring diagram.

Example

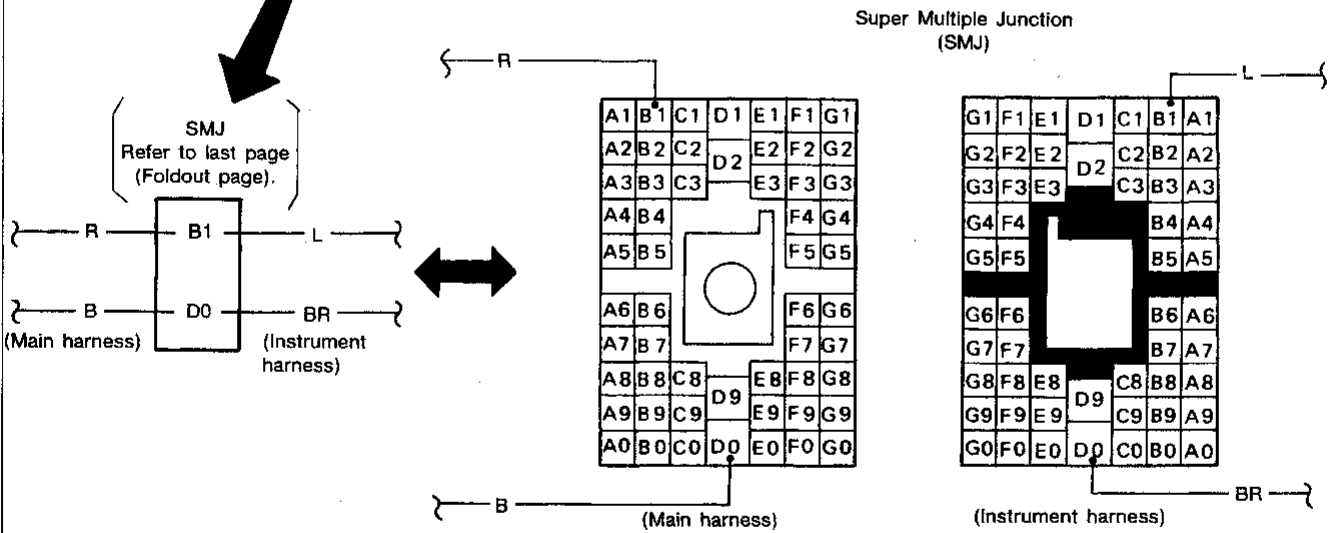
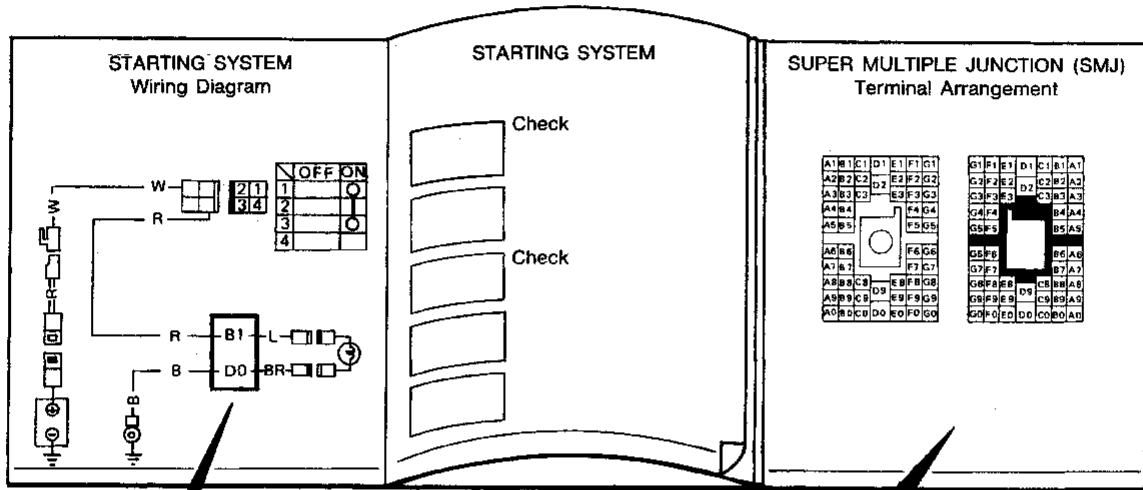

SGI818

HOW TO FOLLOW FLOW CHART IN TROUBLE DIAGNOSES

Example

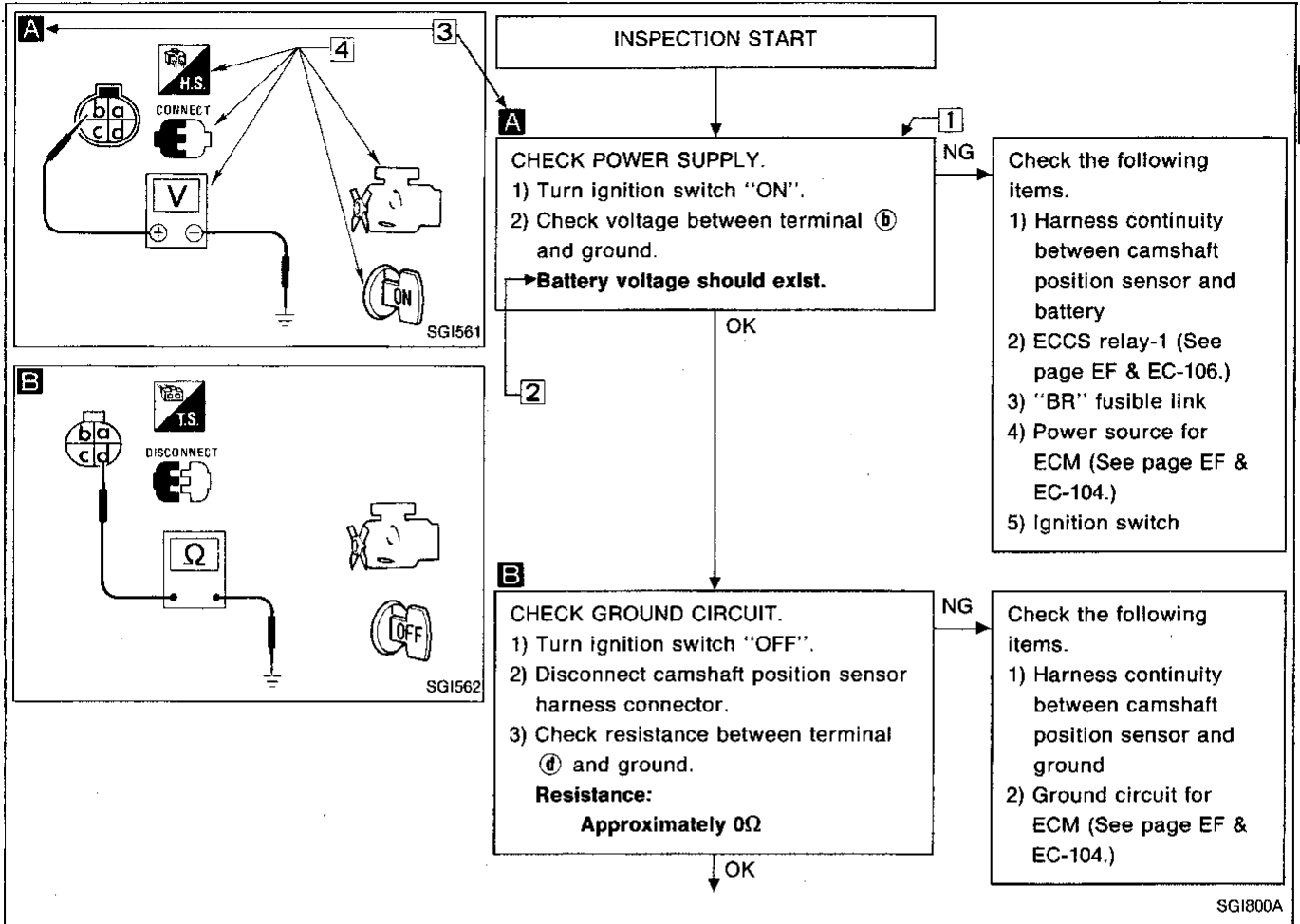

NOTICE

The flow chart indicates work procedures required to diagnose problems effectively. Observe the following instructions before diagnosing.

- 1) Use the flow chart after locating probable causes of a problem following the "Preliminary Check" or the "Symptom Chart".
- 2) After repairs, re-check that the problem has been completely eliminated.
- 3) Refer to Component Parts Location and Harness Layout for the Systems described in each section for identification/location of components and harness connectors.
- 4) Refer to the Circuit Diagram for Quick Pinpoint Check. If you must check circuit continuity between harness connectors in more detail, such as when a sub-harness is used, refer to Wiring Diagram and Harness Layout in EL section for identification of harness connectors.
- 5) When checking circuit continuity, ignition switch should be "OFF".
- 6) Before checking voltage at connectors, check battery voltage.
- 7) After accomplishing the Diagnostic Procedures and Electrical Components Inspection, make sure that all harness connectors are reconnected as they were.

HOW TO FOLLOW FLOW CHART IN TROUBLE DIAGNOSES

HOW TO FOLLOW THIS FLOW CHART

1 Work and diagnostic procedure

Start to diagnose a problem using procedures indicated in enclosed blocks, as shown in the following example.

A

CHECK POWER SUPPLY.

- 1) Turn ignition switch "ON".
- 2) Check voltage between terminal **(b)** and ground.

Battery voltage should exist.

← Check item being performed.

Procedure, steps or measurement results

2 Measurement results

Required results are indicated in bold type in the corresponding block, as shown below: These have the following meanings:

Battery voltage → 11 - 14V or approximately 12V

Voltage: Approximately 0V → Less than 1V

3 Cross reference of work symbols in the text and illustrations

Illustrations are provided as visual aids for work procedures. For example, symbol **A** indicated in the left upper portion of each illustration corresponds with the symbol in the flow chart for easy identification. More precisely, the procedure under the "CHECK POWER SUPPLY" outlined previously is indicated by an illustration **A**.

4 Symbols used in illustrations

Symbols included in illustrations refer to measurements or procedures. Before diagnosing a problem, familiarize yourself with each symbol.

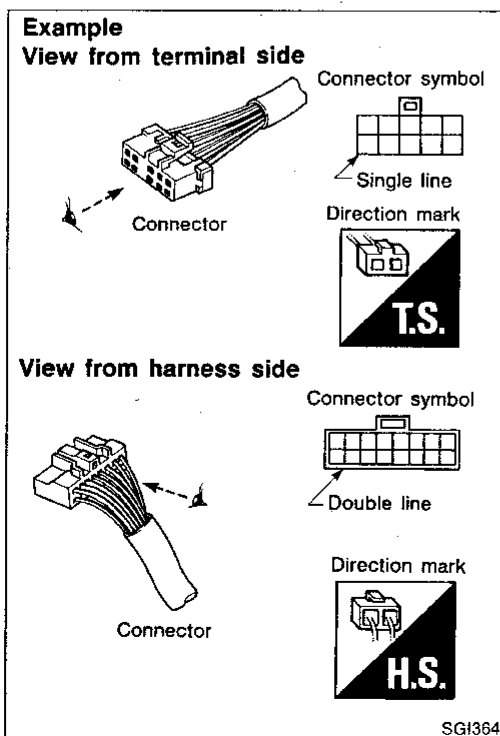

Direction mark

A direction mark is shown to clarify the side of connector (terminal side or harness side). Direction marks are mainly used in the illustrations indicating terminal inspection.



: View from terminal side ... TS

- All connector symbols shown from the terminal side are enclosed by a single line.























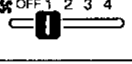

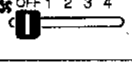



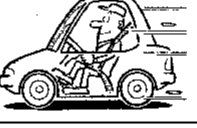





: View from harness side ... HS

- All connector symbols shown from the harness side are enclosed by a double line.

HOW TO FOLLOW FLOW CHART IN TROUBLE DIAGNOSES

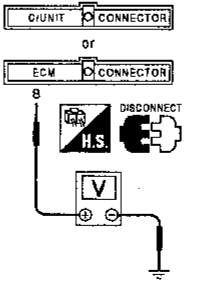
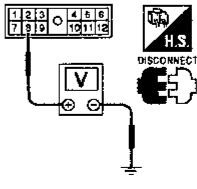
Key to symbols signifying measurements or procedures

Symbol	Symbol explanation	Symbol	Symbol explanation
	Check after disconnecting the connector to be measured.		A/C switch is "OFF".
	Check after connecting the connector to be measured.		A/C switch is "ON".
	Insert key into ignition switch.		REC switch is "ON".
	Turn ignition switch to "OFF" position.		REC switch is "OFF".
	Turn ignition switch to "ON" position.		DEF switch is "ON".
	Turn ignition switch to "START" position.		VENT switch is "ON".
	Turn ignition switch from "OFF" to "ACC" position.		Fan switch is "ON". (At any position except for "OFF" position)
	Turn ignition switch from "ACC" to "OFF" position.		Fan switch is "OFF".
	Turn ignition switch from "OFF" to "ON" position.		Apply battery voltage directly to components.
	Turn ignition switch from "ON" to "OFF" position.		Drive vehicle.
	Do not start engine, or check with engine stopped.		Disconnect battery negative cable.
	Start engine, or check with engine running.		Depress brake pedal.
	Apply parking brake.		Release brake pedal.
	Release parking brake.		Depress accelerator pedal.
	Check after engine is warmed up sufficiently.		Release accelerator pedal.
	Voltage should be measured with a voltmeter.	 <p>Pin terminal check for SMJ type ECM and A/T control unit connectors. For details regarding the terminal arrangement, refer to the foldout page.</p> 	
	Circuit resistance should be measured with an ohmmeter.		
	Current should be measured with an ammeter.		

GI

MA

EM

LC

EF & EC

FE

CL

MT

AT

TF

PD

FA

RA

BR

ST

BF

HA

EL

IDX

IDENTIFICATION INFORMATION

Model Variation

2-WHEEL DRIVE TRUCK

Destination	Body		Engine	KA24E			VG30E		
			Transmission	FS5W71C	RL4R01A (Floor shift)	RL4R01A (Column shift)	FS5R30A	RE4R01A (Floor shift)	
			Differential carrier	H190A	H190A	H190A	H233B	H233B	
Non-California, U.S.A.	Regular Cab	E	Standard wheelbase	SLD21FBU	—	SLD21YBU	—	—	
	King Cab	E	Long wheelbase	KSLGD21FBU	KSLGD21KBU	—	—	—	
		SE		—	—	—	KHLGD21PFBU	KHLGD21PKBU	
Regular Cab (Heavy duty)	E	—		—	—	—	EHLGD21FBU	—	
California, U.S.A.	Regular Cab	E	Standard wheelbase	SLD21FBV	—	SLD21YBV	—	—	
	King Cab	E	Long wheelbase	KSLGD21FBV	KSLGD21KBV	—	—	—	
		SE		—	—	—	KHLGD21PFBV	KHLGD21PKBV	
Regular Cab (Heavy duty)	E	—		—	—	—	EHLGD21FBV	—	
Canada	Regular Cab	E	Standard wheelbase	SLD21FBN	—	SLD21YBN	—	—	
	King Cab	E	Long wheelbase	KSLGD21FBN	KSLGD21KBN	—	—	KHLGD21FBN	KHLGD21KBN
		SE		—	—	—	KHLGD21PFBN	KHLGD21PKBN	

4-WHEEL DRIVE TRUCK

Destination	Body		Engine	KA24E		VG30E			
			Transmission	FS5W71C		FS5R30A		RE4R01A	
			Transfer	TX10		TX10		TX10	
			Differential carrier	Front R180A	Rear H233B	Front R200A	Rear H233B	Front R200A	Rear H233B
Non-California, U.S.A.	Regular Cab	E	Standard wheelbase	SLYD21FBU		—		—	
	King Cab	E	Long wheelbase	KSLMD21FBU		—		—	
		SE		—	KHLMD21PFBU		KHLMD21PKBU		
California, U.S.A.	Regular Cab	E		Standard wheelbase	SLYD21FBV		—		—
	King Cab	E	Long wheelbase	KSLMD21FBV		—		—	
		SE		—	KHLMD21PFBV		KHLMD21PKBV		
Canada	Regular Cab	E		Standard wheelbase	SLYD21FBN		—		—
	King Cab	E	Long wheelbase	—		KHLMD21FBN		KHLMD21KBN	
		SE		—	KHLMD21PFBN		KHLMD21PKBN		

IDENTIFICATION INFORMATION

Model Variation (Cont'd)

2-WHEEL DRIVE PATHFINDER

Destination	Body	Grade	Engine	VG30E	
			Transmission	FS5R30A (Manual)	RE4R01A (Auto)
			Differential carrier	H233B	H233B
Non-California, U.S.A.	Wagon	XE	4-door	WHLD21DJFBU	WHLD21DJKBU
California, U.S.A.				WHLD21DJFBV	WHLD21DJKBV

4-WHEEL DRIVE PATHFINDER

Destination	Body	Grade	Engine	VG30E			
			Transmission	FS5R30A (Manual)		RE4R01A (Auto)	
			Transfer	TX10		TX10	
			Differential carrier	Front R200A	Rear H233B	Front R200A	Rear H233B
Non-California, U.S.A.	Wagon	XE	4-door	WHLYD21DJFBU		WHLYD21DJKBU	
		SE		WHLYD21DPFBU		WHLYD21DPKBU	
California, U.S.A.		XE		WHLYD21DJFBV		WHLYD21DJKBV	
		SE		WHLYD21DPFBV		WHLYD21DPKBV	
Canada		XE		WHLYD21DJFBN		WHLYD21DJKBN	
		SE		WHLYD21DPFBN		WHLYD21DPKBN	

GI
MA
EM
LC
EF & EC
FE
CL
MT
AT
TF
PD
FA
RA
BR
ST
BF
HA
EL
IDX

IDENTIFICATION INFORMATION

Model Variation (Cont'd)

Prefix and suffix designations:

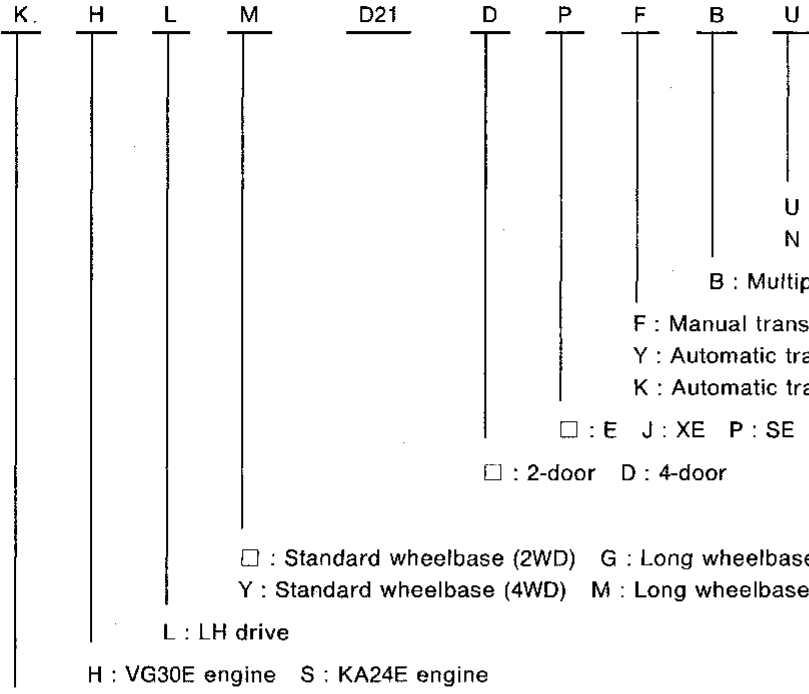

U : Non-California, U.S.A. V : California, U.S.A.
N : Canada

B : Multiport fuel injection system engine

F : Manual transmission (5-speed floor shift)

Y : Automatic transmission (4-speed column shift)

K : Automatic transmission (4-speed floor shift)

□ : E J : XE P : SE

□ : 2-door D : 4-door

□ : Standard wheelbase (2WD) G : Long wheelbase (2WD)

Y : Standard wheelbase (4WD) M : Long wheelbase (4WD)

L : LH drive

H : VG30E engine S : KA24E engine

□ : Regular Cab K : King Cab E : Regular Cab (Heavy duty) W : Wagon

Note: □ means no indication.

IDENTIFICATION INFORMATION

Identification Number

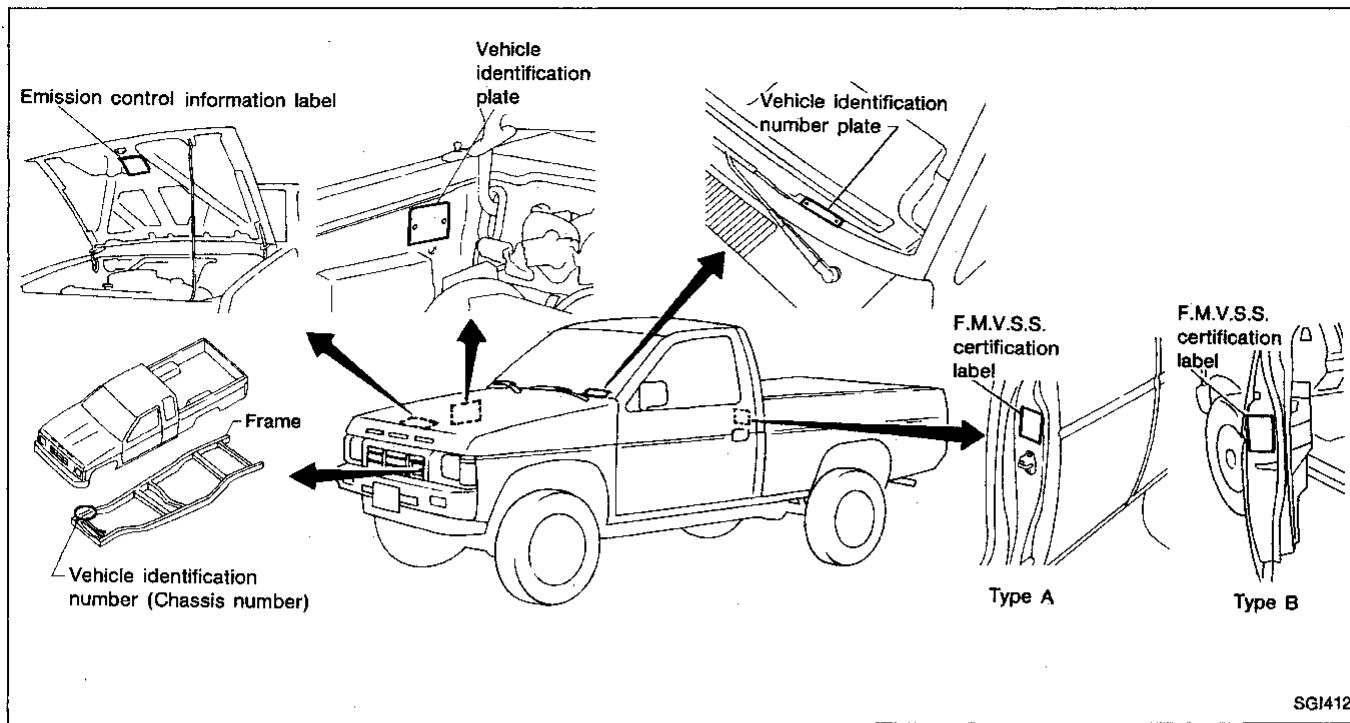

VEHICLE IDENTIFICATION NUMBER ARRANGEMENT

JN6	H	D	1	1	S	*	R	W	000001
									Vehicle serial number
									Manufacturing plant W : Kyushu X : Nissan Shatai Hiratsuka C : Smyrna, Tennessee
									Model year R : 1994 model year
									Check digit (0 to 9 or X) The code for the check digit is determined by mathematical computation.
									Gross vehicle weight rating S : Standard (2-wheel drive) or heavy duty version Y : Standard (4-wheel drive)
									Body type 1 : Standard wheelbase 2 : Long wheelbase 6 : King Cab 7 : 4-door Wagon & Van
									Model change
									Vehicle line D : Nissan Truck, Nissan Pathfinder
									Engine type H : VG30E S : KA24E
Manufacturer									
JN6 : Japan produced truck 1N6 : U.S.A. produced truck JN8 : Japan produced multi-purpose passenger vehicle									

GI
 MA
 EM
 LC
 EF & EC
 FE
 CL
 MT
 AT
 TF
 PD
 FA
 RA
 BR
 ST
 BF
 HA
 EL
 IX
 21

IDENTIFICATION INFORMATION

Identification Number (Cont'd)

IDENTIFICATION PLATE

NISSAN MOTOR CO., LTD. JAPAN			
型式	TYPE	△1	
	TIPO		
CHASSIS NO.		△2	
NO. DE CHASSIS			
MODEL		△3	
MODELO			
○ カラー COLOR TRIM		△4	△5
トリアム COLOR GUARNICION			
エン ENGINE		△6	△7
ジン MOTOR			
ミッション TRANS, AXLE		△8	△9
アクスル TRANS, EJE			
	工場		PLANT
			PLANTA
日産自動車株式会社		MADE IN JAPAN	

○ CC

- 1 Type
- 2 Vehicle identification number (Chassis number)
- 3 Model
- 4 Body color code
- 5 Trim color code
- 6 Engine model
- 7 Engine displacement
- 8 Transmission model
- 9 Axle model

SGI756-A

ENGINE SERIAL NUMBER

VG30E engine

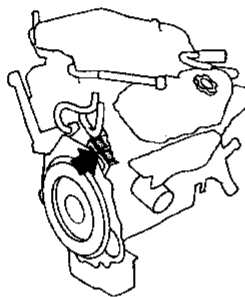

KA24E engine

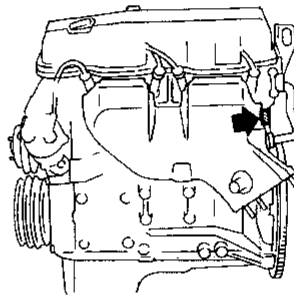

SGI757-A

TRANSMISSION SERIAL NUMBER

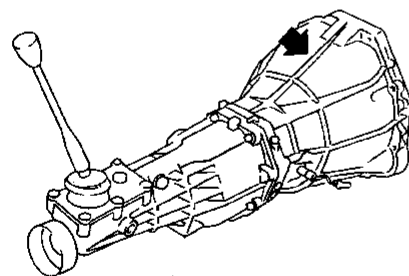

Manual transmission number

SGI758-A

IDENTIFICATION INFORMATION

Identification Number (Cont'd)

TRANSMISSION SERIAL NUMBER

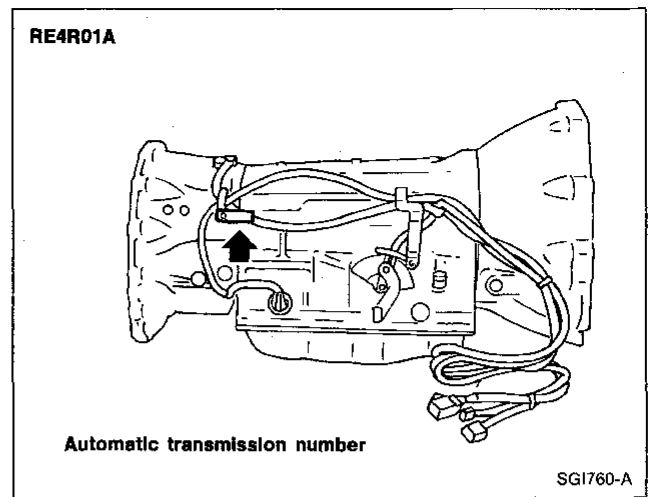
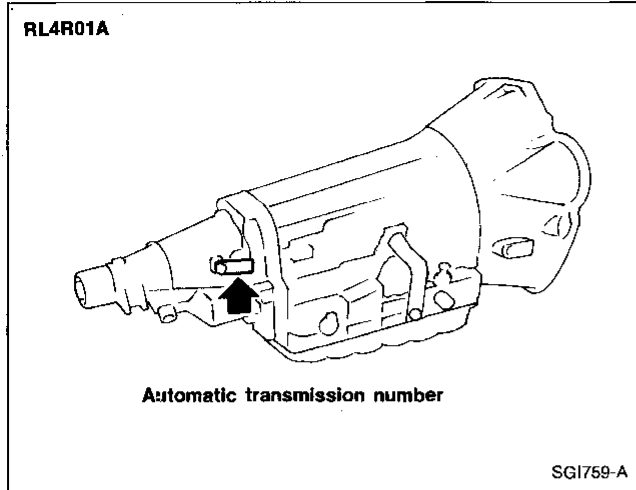

TRANSFER SERIAL NUMBER

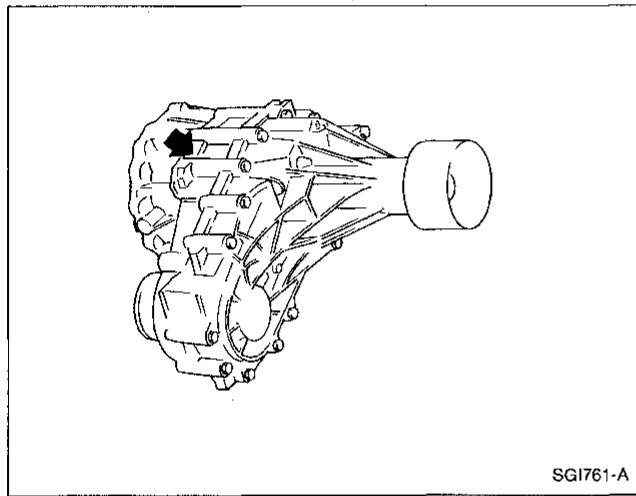

GI
MA
EM
LC
EF &
EC
FE
CL
MT
AT
TF
PD
FA
RA
BR
ST
BF
HA
EL
IDX
23

IDENTIFICATION INFORMATION

Dimensions

Truck

Unit: mm (in)

		2-wheel drive			4-wheel drive	
		Regular Cab	King Cab	Heavy duty	Regular Cab	King Cab
		Standard wheelbase	Long wheelbase		Standard wheelbase	Long wheelbase
Overall length*		4,435 (174.6)	4,825 (190.0)	4,825 (190.0)	4,435 (174.6)	4,825 (190.0)
Overall width		1,650 (65.0)	1,650 (65.0)	1,650 (65.0)	1,690 (66.5)	1,690 (66.5)
Overall height (KA24E engine models)		1,575 (62.0)	1,575 (62.0)	—	1,705 (67.1)	1,705 (67.1)
Overall height (VG30E engine models)		—	1,575 (62.0)	1,575 (62.0)	—	1,705 (67.1)
Front tread (KA24E engine models)		1,395 (54.9)	1,395 (54.9)	—	1,445 (56.9)	1,445 (56.9)
Front tread (VG30E engine models)		—	1,415 (55.7)	1,395 (54.9)	—	1,445 (56.9)
Rear tread (KA24E engine models)		1,385 (54.5)	1,385 (54.5)	—	1,430 (56.3)	1,430 (56.3)
Rear tread (VG30E engine models)		—	1,430 (56.3)	1,410 (55.5)	—	1,430 (56.3)
Wheelbase		2,650 (104.3)	2,950 (116.1)	2,950 (116.1)	2,650 (104.3)	2,950 (116.1)
Cargo space	Length	1,875 (73.8)	1,895 (74.6)	2,265 (89.2)	1,875 (73.8)	1,895 (74.6)
	Width	1,520 (59.8)	1,520 (59.8)	1,520 (59.8)	1,520 (59.8)	1,520 (59.8)
	Height	435 (17.1)	435 (17.1)	435 (17.1)	435 (17.1)	435 (17.1)

*: On step bumper equipped models, the bumper adds 140 mm (5.5 in) to the overall length.

Pathfinder

Unit: mm (in)

	Wagon
	VG30E
Overall length*1	4,365 (171.9)
Overall width	1,690 (66.5)
Overall height	1,670 (65.7)/1,680 (66.1)*2
Front tread	1,425 (56.1)/1,445 (56.9)*2
Rear tread	1,410 (55.5)/1,430 (56.3)*2
Wheelbase	2,650 (104.3)

*1: On models with a spare tire carrier, the overall length is increased by the following lengths depending on the spare tire.

230 mm (9.1 in) for P215/75R tires, 260 mm (10.2 in) for P235/75R tires,

275 mm (10.8 in) for 10.5R tires.

*2: SE model

IDENTIFICATION INFORMATION

Wheels & Tires

FOR U.S.A.

		Grade	Road wheel/offset mm (in)	Tire	Spare tire size
4x2	Regular and King Cab	E	14x5J/40 (1.57) 14x6JJ/30 (1.18)*1	P195/75R14	T135/70D16 P195/75R14*1
		SE	14x6JJ/30 (1.18) 14x6JJ Aluminum/30 (1.18)*1	P215/75R14	T135/70D16 P215/75R14*1
	Heavy duty	E	14x5J/40 (1.57)	LT195/75R14	LT195/75R14
	PATHFINDER	XE	15x5-1-2K/40 (1.57) 15x6JJ/30 (1.18)	P215/75R15 P235/75R15	P215/75R15 P235/75R15*1 T155/90D16
4x4	Regular, King Cab and PATHFINDER	E	15x6JJ aluminum/30 (1.18)	P235/75R15	P215/75R15
		XE	15x5-1/2K/40 (1.57) 15x6JJ/30 (1.18)	P215/75R15 P235/75R15	P215/75R15 P235/75R15*1 T155/90D16
		SE	15x6JJ/30 (1.18) 15x7JJ aluminum/25 (0.98)*1	P235/75R15 31x10.5R15	P215/75R15 P235/75R15*1

*1: Option

FOR CANADA

		Grade	Road wheel/offset mm (in)	Tire	Spare tire size
4x2	Regular and King Cab	E	14x5J/40 (1.57), 14x6J*2 14x6JJ/30 (1.18)	P195/75R14 P215/75R14	T135/70D16
		SE	14x6JJ/30 (1.18) 14x6JJ Aluminum/30 (1.18)*1	P215/75R14	T135/70D16
4x4	Regular, King Cab and PATHFINDER	E	15x6JJ/30 (1.18) 15x6JJ aluminum/30 (1.18)	P235/75R15	P215/75R15 P235/75R15
		XE	15x5-1/2K/40 (1.57) 15x6JJ/30 (1.18)	P215/75R15 P235/75R15	P215/75R15*1 P235/75R15 T155/90D16
		SE	15x6JJ/30 (1.18) 15x7JJ Aluminum/25 (0.98)*1	P235/75R15 31x10.5R15	P215/75R15

*1: Option

*2: For VG30E engine models

GI

MA

EM

LC

EF &
EC

FE

CL

MT

AT

TF

PD

FA

RA

BR

ST

BF

HA

EL

IDX

25

LIFTING POINTS AND TOW TRUCK TOWING

WARNING:

- Never get under the vehicle while it is supported only by the jack. Always use safety stands to support the frame when you have to get under the vehicle.
- Place wheel chocks at both front and back of the wheels on the ground.

Screw Jack

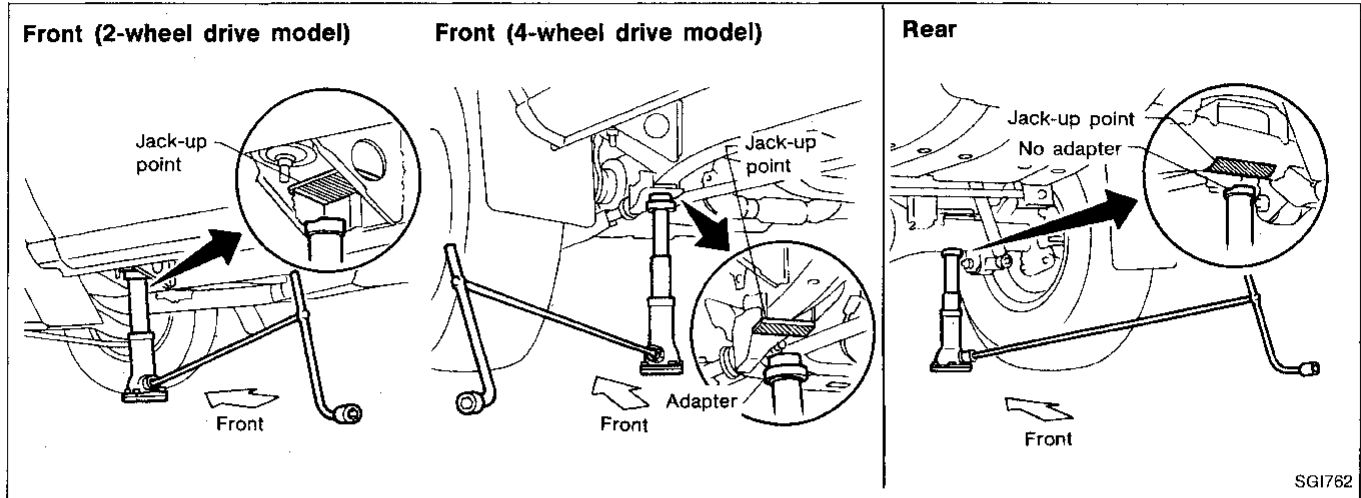

Garage Jack and Safety Stand

CAUTION:

Place a wooden or rubber block between safety stand and vehicle body when the supporting body is flat.

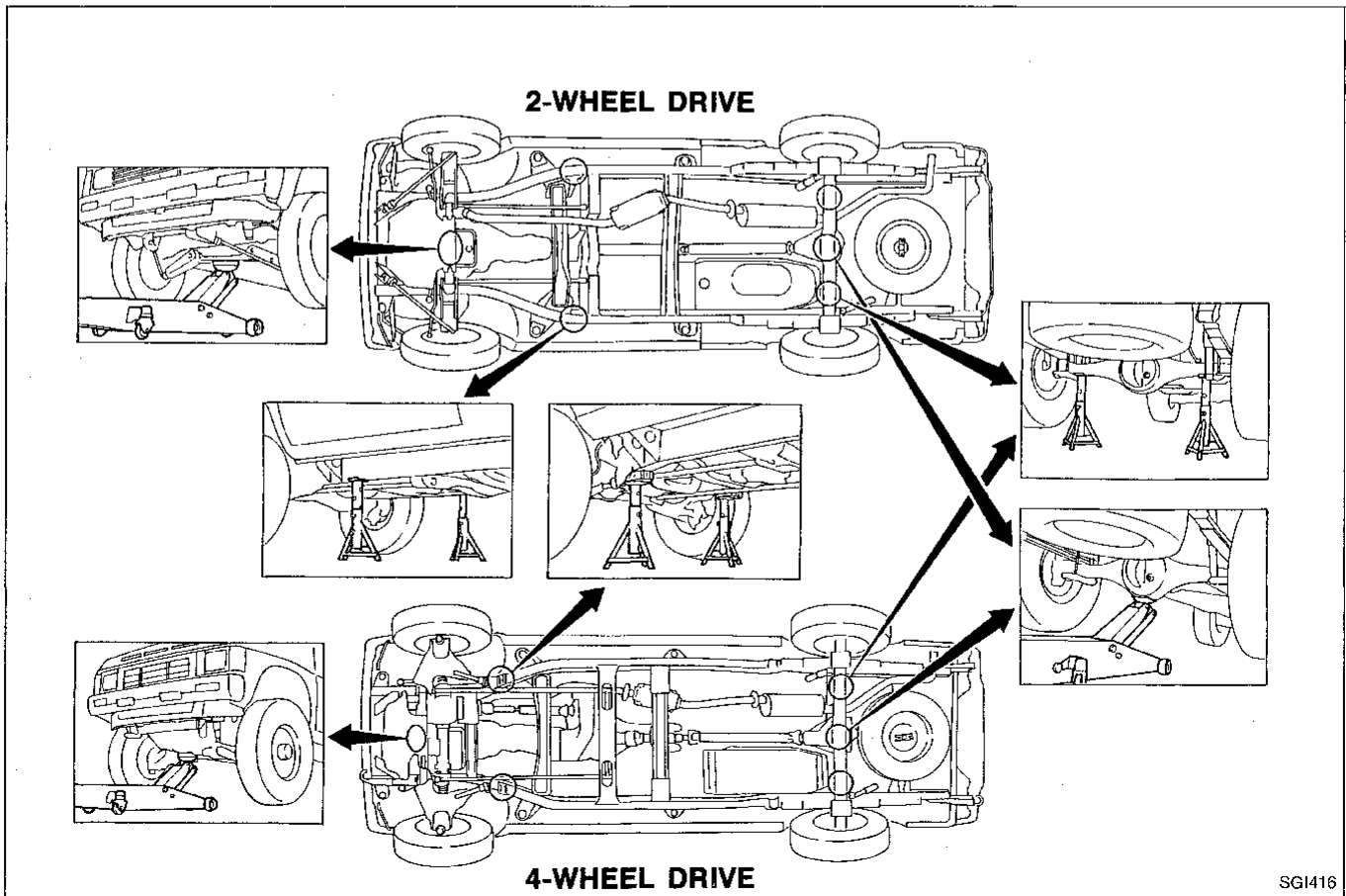

LIFTING POINTS AND TOW TRUCK TOWING

2-pole Lift

WARNING:

When lifting the vehicle, open the lift arms as wide as possible and ensure that the front and rear of the vehicle are well balanced.

When setting the lift arm, do not allow the arm to contact the brake tubes, brake cable and fuel lines.

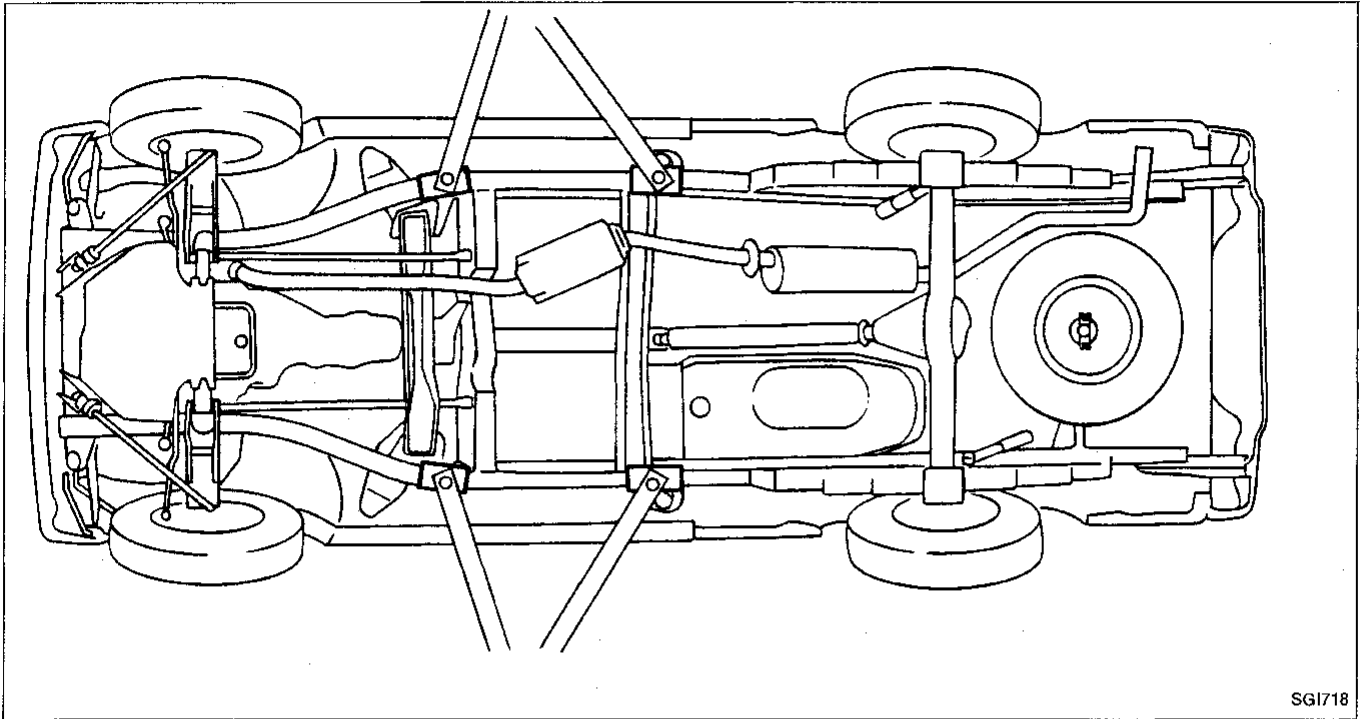

SGI718

GI

MA

EM

LC

EF &
EC

FE

CL

MT

AT

TF

PD

FA

RA

BR

ST

BF

HA

EL

IDX

Tow Truck Towing

CAUTION:

- All applicable state or Provincial (in Canada) laws and local laws regarding the towing operation must be obeyed.
- It is necessary to use proper towing equipment to avoid possible damage to the vehicle during towing operation.
Towing is in accordance with Towing Procedure Manual at dealer.
- Attach safety chains for all towing.
- When towing, make sure that the transmission, steering system and power train are in good order. If any unit is damaged, a dolly must be used.
- When towing with the front wheels on the ground:
Turn the ignition key to the "OFF" position and secure the steering wheel in a straightahead position with a rope or similar device. Never place the ignition key in the "LOCK" position. This will result in damage to the steering lock mechanism.
- When towing with the rear wheels on the ground, release the parking brake and move the gearshift lever to neutral position ("N" position).
- Never tow vehicle from the rear (i.e., backward) with four wheels on the ground as this may cause serious and expensive damage to the transmission.
- For 4-wheel drive model:
Set the free-running hubs to the free position and move both the gearshift and transfer levers to neutral position ("N" position).

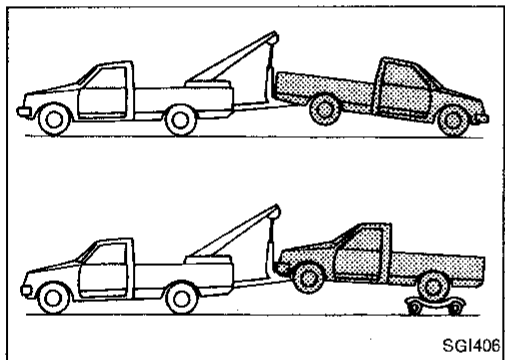

2-WHEEL DRIVE MODELS

NISSAN recommends that vehicle be towed with the driving (rear) wheels off the ground as illustrated.

Towing with four wheels on ground or towing with front wheels raised (With rear wheels on ground)

Observe the following restricted towing speeds and distances.

Automatic transmission model:

Speed: Below 50 km/h (30 MPH)

Distance: Less than 65 km (40 miles)

Manual transmission model with KA24E engine:

Speed: Below 95 km/h (60 MPH)

Distance: Less than 800 km (500 miles)

Manual transmission model with VG30E engine:

Speed: Below 95 km/h (60 MPH)

Distance: Less than 320 km (200 miles)

If the speed or distance must necessarily be greater, remove the propeller shaft beforehand to prevent damage to the transmission.

LIFTING POINTS AND TOW TRUCK TOWING

Tow Truck Towing (Cont'd)

4-WHEEL DRIVE MODELS

NISSAN recommends that a dolly be used as illustrated when towing 4-speed drive models.

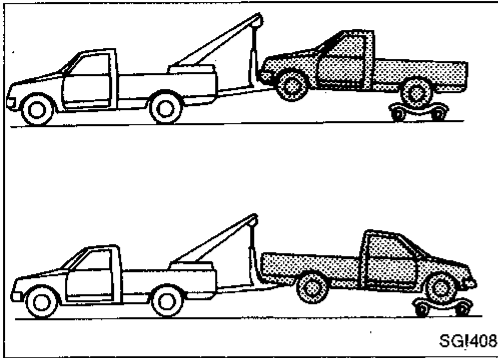

Towing with four wheels on ground or towing with front or rear wheels raised

Observe the following restricted towing speeds and distances.

Automatic transmission model:

Speed: Below 50 km/h (30 MPH)

Distance: Less than 65 km (40 miles)

Manual transmission model:

Speed: Below 95 km/h (60 MPH)

Distance: Less than 800 km (500 miles)

If the speed or distance must necessarily be greater, remove the front and rear propeller shafts beforehand to prevent damage to the transmission.

TOWING POINT

- Never tow the vehicle using only the towing hooks. Use proper towing equipment when towing. Otherwise, the vehicle body will be damaged.
- Always pull the cable straight out from the vehicle. Never pull on the hook at a sideways angle.

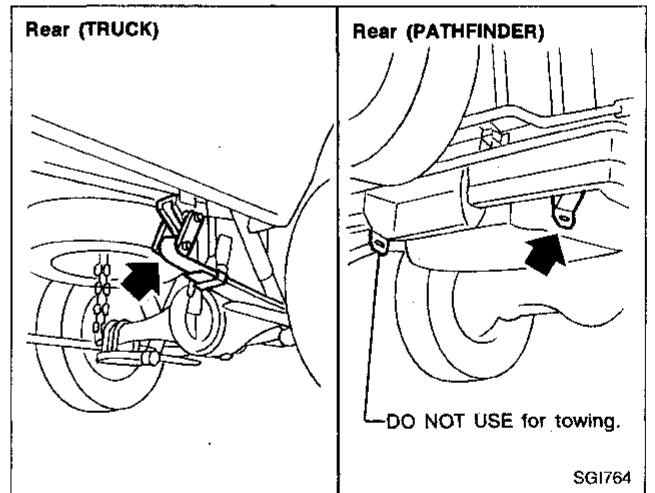
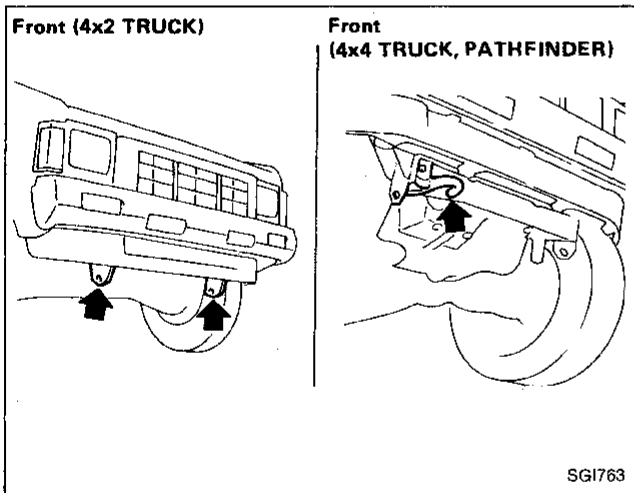

GI

MA

EM

LC

EF &
EC

FE

CL

MT

AT

TF

PD

FA

RA

BR

ST

BF

HA

EL

IDX

29

TIGHTENING TORQUE OF STANDARD BOLTS

Grade	Bolt size	Bolt diameter* mm	Pitch mm	Tightening torque (Without lubricant)					
				Hexagon head bolt			Hexagon flange bolt		
				N·m	kg·m	ft·lb	N·m	kg·m	ft·lb
4T	M6	6.0	1.0	5.1	0.52	3.8	6.1	0.62	4.5
	M8	8.0	1.25	13	1.3	9	15	1.5	11
			1.0	13	1.3	9	16	1.6	12
	M10	10.0	1.5	25	2.5	18	29	3.0	22
			1.25	25	2.6	19	30	3.1	22
	M12	12.0	1.75	42	4.3	31	51	5.2	38
1.25			46	4.7	34	56	5.7	41	
M14	14.0	1.5	74	7.5	54	88	9.0	65	
7T	M6	6.0	1.0	8.4	0.86	6.2	10	1.0	7
	M8	8.0	1.25	21	2.1	15	25	2.5	18
			1.0	22	2.2	16	26	2.7	20
	M10	10.0	1.5	41	4.2	30	48	4.9	35
			1.25	43	4.4	32	51	5.2	38
	M12	12.0	1.75	71	7.2	52	84	8.6	62
1.25			77	7.9	57	92	9.4	68	
M14	14.0	1.5	127	13.0	94	147	15.0	108	
9T	M6	6.0	1.0	12	1.2	9	15	1.5	11
	M8	8.0	1.25	29	3.0	22	35	3.6	26
			1.0	31	3.2	23	37	3.8	27
	M10	10.0	1.5	59	6.0	43	70	7.1	51
			1.25	62	6.3	46	74	7.5	54
	M12	12.0	1.75	98	10.0	72	118	12.0	87
1.25			108	11.0	80	137	14.0	101	
M14	14.0	1.5	177	18.0	130	206	21.0	152	

1. Special parts are excluded.

2. This standard is applicable to bolts having the following marks embossed on the bolt head.

*: Nominal diameter

Grade	Mark
4T	4
7T	7
9T	9

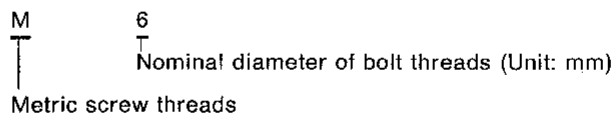

SAE J1930 TERMINOLOGY LIST

SAE J1930 Terminology List

All emission related terms used in this publication are listed in accordance with SAE J1930. Accordingly, new terms, new acronyms/abbreviations and old terms are listed in the following chart.

***: Not applicable

NEW TERM	NEW ACRONYM / ABBREVIATION	OLD TERM
Air cleaner	ACL	Air cleaner
Barometric pressure	BARO	***
Barometric pressure sensor-BCDD	BAROS-BCDD	BCDD
Camshaft position	CMP	***
Camshaft position sensor	CMPS	Crank angle sensor
Carburetor	CARB	Carburetor
Charge air cooler	CAC	Intercooler
Closed loop	CL	Closed loop
Closed throttle position switch	CTP switch	Idle switch
Clutch pedal position switch	CPP switch	Clutch switch
Continuous fuel injection system	CFI system	***
Continuous trap oxidizer system	CTOX system	***
Crankshaft position	CKP	***
Crankshaft position sensor	CKPS	***
Data link connector	DLC	***
Data link connector for CONSULT	DLC for CONSULT	Diagnostic connector for CONSULT
Diagnostic test mode	DTM	Diagnostic mode
Diagnostic test mode selector	DTM selector	Diagnostic mode selector
Diagnostic test mode I	DTM I	Mode I
Diagnostic test mode II	DTM II	Mode II
Diagnostic trouble code	DTC	Malfunction code
Direct fuel injection system	DFI system	***
Distributor ignition system	DI system	Ignition timing control
Early fuel evaporation-mixture heater	EFE-mixture heater	Mixture heater
Early fuel evaporation system	EFE system	Mixture heater control
Electrically erasable programmable read only memory	EEPROM	***
Electronic ignition system	EI system	Ignition timing control
Engine control module	ECM	ECCS control unit
Engine coolant temperature	ECT	Engine temperature
Engine coolant temperature sensor	ECTS	Engine temperature sensor
Engine modification	EM	***
Engine speed	RPM	Engine speed
Erasable programmable read only memory	EPROM	***
Evaporative emission system	EVAP system	Evaporative emission control system
Exhaust gas recirculation valve	EGR valve	EGR valve

GI
 MA
 EM
 LC
 EF & EC
 FE
 CL
 MT
 AT
 TF
 PD
 FA
 RA
 BR
 ST
 BF
 HA
 EL

SAE J1930 TERMINOLOGY LIST

SAE J1930 Terminology List (Cont'd)

***: Not applicable

NEW TERM	NEW ACRONYM / ABBREVIATION	OLD TERM
Exhaust gas recirculation control -BPT valve	EGRC-BPT valve	BPT valve
Exhaust gas recirculation control -solenoid valve	EGRC-solenoid valve	EGR control solenoid valve
Exhaust gas recirculation temperature sensor	EGR temperature sensor	Exhaust gas temperature sensor
Flash electrically erasable programmable read only memory	FEEPROM	***
Flash erasable programmable read only memory	FEPROM	***
Flexible fuel sensor	FFS	***
Flexible fuel system	FF system	***
Heated oxygen sensor	HO2S	Exhaust gas sensor
Idle air control system	IAC system	Idle speed control
Idle air control valve-air regulator	IACV-air regulator	Air regulator
Idle air control valve-auxiliary air control valve	IACV-AAC valve	Auxiliary air control(AAC) valve
Idle air control valve-FICD solenoid valve	IACV-FICD solenoid valve	FICD solenoid valve
Idle air control valve-idle up control solenoid valve	IACV-idle up control solenoid valve	Idle up control solenoid valve
Idle speed control-FI pot	ISC-FI pot	FI pot
Idle speed control system	ISC system	***
Ignition control module	ICM	***
Indirect fuel injection system	IFI system	***
Intake air temperature sensor	IATS	Air temperature sensor
Knock	***	Detonation
Knock sensor	KS	Detonation sensor
Malfunction indicator lamp	MIL	Check engine light
Manifold absolute pressure	MAP	***
Manifold absolute pressure sensor	MAPS	***
Manifold differential pressure	MDP	***
Manifold differential pressure sensor	MDPS	***
Manifold surface temperature	MST	***
Manifold surface temperature sensor	MSTS	***
Manifold vacuum zone	MVZ	***
Manifold vacuum zone sensor	MVZS	***
Mass air flow sensor	MAFS	Air flow meter
Mixture control solenoid valve	MC solenoid valve	Air-fuel ratio control solenoid valve
Multiport fuel injection System	MFI system	Fuel injection control
Neutral position switch	***	Neutral switch
Non-volatile random access memory	NVRAM	***
On-board diagnostic system	OBD system	Self-diagnosis
Open loop	OL	Open loop
Oxidation catalyst	OC	Catalyst

SAE J1930 TERMINOLOGY LIST

SAE J1930 Terminology List (Cont'd)

***: Not applicable

NEW TERM	NEW ACRONYM / ABBREVIATION	OLD TERM
Oxidation catalytic converter system	OC system	***
Oxygen sensor	O2S	Exhaust gas sensor
Park position switch	***	Park switch
Park/neutral position switch	PNP switch	Park/neutral switch
Periodic trap oxidizer system	PTOX system	***
Powertrain control module	PCM	***
Programmable read only memory	PROM	***
Pulsed secondary air injection control solenoid valve	PAIRC solenoid valve	AIV control solenoid valve
Pulsed secondary air injection system	PAIR system	Air induction valve(AIV) control
Pulsed secondary air injection valve	PAIR valve	Air induction valve
Random access memory	RAM	***
Read only memory	ROM	***
Scan tool	ST	***
Secondary air injection pump	AIR pump	***
Secondary air injection system	AIR system	***
Sequential multiport fuel injection system	SFI system	Sequential fuel injection
Service reminder indicator	SRI	***
Simultaneous multiport fuel injection system	***	Simultaneous fuel injection
Smoke puff limiter system	SPL system	***
Supercharger	SC	***
Supercharger bypass	SCB	***
System readiness test	SRT	***
Thermal vacuum valve	TVV	Thermal vacuum valve
Three way catalyst	TWC	Catalyst
Three way catalytic converter system	TWC system	***
Three way + oxidation catalyst	TWC + OC	Catalyst
Three way + oxidation catalytic converter system	TWC + OC system	***
Throttle body	TB	Throttle chamber SPi body
Throttle body fuel injection system	TBI system	Fuel injection control
Throttle position	TP	Throttle position
Throttle position sensor	TPS	Throttle sensor
Throttle position switch	TP switch	Throttle switch
Torque converter clutch solenoid valve	TCC solenoid valve	Lock-up cancel solenoid Lock-up solenoid
Turbocharger	TC	Turbocharger
Vehicle speed sensor	VSS	Vehicle speed sensor
Volume air flow sensor	VAFS	Air flow meter

GI
 MA
 EM
 LC
 EF & EC
 FE
 CL
 MT
 AT
 TF
 PD
 FA
 RA
 BR
 ST
 BF
 HA
 EL

SAE J1930 TERMINOLOGY LIST

SAE J1930 Terminology List (Cont'd)

***: Not applicable

NEW TERM	NEW ACRONYM / ABBREVIATION	OLD TERM
Warm up oxidation catalyst	WU-OC	Catalyst
Warm up oxidation catalytic converter system	WU-OC system	***
Warm up three-way catalyst	WU-TWC	Catalyst
Warm up three-way catalytic converter system	WU-TWC system	***
Wide open throttle position switch	WOTP switch	Full switch