

G - TESTS W/CODES

1992 Infiniti G20

1992 ENGINE PERFORMANCE
Infiniti Self-Diagnostics

G20

INTRODUCTION

If no faults were found while performing F - BASIC TESTING, proceed with self-diagnostics. If no fault codes or only pass codes are present after entering self-diagnostics, proceed to H - TESTS W/O CODES article in the ENGINE PERFORMANCE Section article for diagnosis by symptom (i.e., ROUGH IDLE, NO START, etc.).

SELF-DIAGNOSTIC SYSTEM

Self-diagnostic system is used for diagnosing malfunctions of Electronic Concentrated Control System (ECCS) sensors and actuators. Electronic Control Unit (ECU) has 2 available diagnostic modes. Before entering self-diagnostics, perform BASIC DIAGNOSTIC PROCEDURES. This prevents wasted diagnostic time and invalid diagnostic results.

NOTE: When performing BASIC DIAGNOSTIC PROCEDURES, DO NOT erase any diagnostic information stored in ECU memory.

Hard Failures

Hard failures cause CHECK ENGINE light to glow and remain on until problem is repaired. If light comes on and remains on (light may flash) during vehicle operation, cause of malfunction must be determined using diagnostic code charts. If a sensor fails, control unit will use a substitute value in its calculations to continue engine operation. In this condition, commonly known as limp-in mode, vehicle runs but driveability will not be optimum.

Intermittent Failures

Intermittent failures may cause CHECK ENGINE light to flicker or glow and go out after intermittent fault goes away. However, corresponding trouble code will be stored in ECU memory. Not all trouble codes will illuminate CHECK ENGINE light. If related fault does not reoccur within a certain time frame, related trouble code will be erased from ECU memory. Intermittent failures may be caused by sensor, connector or wiring related problems. See INTERMITTENTS in H - TESTS W/O CODES article in the ENGINE PERFORMANCE Section.

NOTE: Follow proper diagnostic routine when diagnosing system. See DIAGNOSTIC ROUTINE table.

DIAGNOSTIC ROUTINE TABLE

Procedure	Order
Basic Diagnostic Procedures (1)	1st
Entering Diagnostics	2nd
Retrieving Trouble Codes	3rd
Symptoms (2)	4th
Intermittents (2)	5th

(1) - See F - BASIC TESTING article in the ENGINE PERFORMANCE Section.

(2) - Symptoms and intermittents are covered in H - TESTS

W/O CODES article in the ENGINE PERFORMANCE Section.

CHECK ENGINE LIGHT

NOTE: Not all trouble codes activate CHECK ENGINE LIGHT.

All models are equipped with a CHECK ENGINE light. As a bulb check, light glows when ignition is turned on and engine is not running.

On California models, CHECK ENGINE light glows when a fault is detected with engine running. A corresponding trouble code will set in ECU memory. CHECK ENGINE light also glows if ECU or crank angle sensor malfunctions.

On Federal models, CHECK ENGINE light glows only when ECU or crank angle sensor malfunctions with engine running.

DIAGNOSTIC MODES

Self-diagnostic system can detect ECCS malfunctions and store related trouble codes. Intermittent codes are also stored. All codes are stored until cleared from memory. If an intermittent does not reoccur within 50 ignition key cycles, it will be cleared from memory.

Switching modes is not possible when engine is running. During diagnosis, self-diagnostic system will automatically return to Mode I from Mode II when ignition is turned off.

Mode I

This is normal operating mode. In this mode, CHECK ENGINE light and Red Light Emitting Diode (LED) inspection light in ECU stay on when ignition is turned on, engine off (bulb check). If engine is started, CHECK ENGINE light and Red LED in ECU should turn off, unless a fault or trouble code is present (California) or if ECU or crank angle sensor is malfunctioning (California and Federal).

Mode II

This is self-diagnostic mode for retrieving fault or trouble codes. See RETRIEVING CODES. With engine running, Mode II can monitor air/fuel mixture feedback control. CHECK ENGINE light and red LED in ECU will flash on (lean) and off (rich) more than 5 times every 10 seconds with engine speed at 2000 RPM when system is in closed loop. CHECK ENGINE light and red LED do not flash (remain on or off) if system is in open loop.

ECU LOCATION

ECU is located under dash, in center console.

ENTERING SELF-DIAGNOSTICS

1) Turn ignition on, but leave engine off. Using a small screwdriver, turn diagnostic mode selector on ECU fully clockwise. Wait at least 2 seconds, and then turn diagnostic mode selector fully counterclockwise. Mode II self-diagnostics will result and CHECK ENGINE light and Red LED inspection light will flash codes (if present).

2) If engine is started at this stage, CHECK ENGINE light and Red LED inspection light will display condition of air/fuel mixture, monitored by O2 sensor, whether system is in closed or open loop.

NOTE: Turn back diagnostic mode selector to fully counterclockwise position whenever vehicle is in use. Switching modes is not

possible when engine is running.

RETRIEVING CODES

Use Mode II to retrieve trouble codes from self-diagnostic system. Read codes using either CHECK ENGINE light or Red LED inspection light on ECU. Trouble codes will flash after selecting Mode II.

Trouble codes are indicated by number of flashes from CHECK ENGINE light or Red LED inspection light. For example, 3 long (.6 second) flashes followed by 2 short (.3 second) flashes of CHECK ENGINE light or Red LED indicate a Code 32.

CLEARING CODES

NOTE: Ensure all diagnostic codes are accessed from ECU memory before disconnecting battery or switching from Mode II to Mode I.

Memory Erase

Stored memory can be erased by disconnecting battery or selecting Mode I after Mode II has been accessed.

TROUBLE CODE DEFINITION

NOTE: When using trouble code charts, refer to Fig. 1 for symbol identification.

TROUBLE CODE IDENTIFICATION CHART

Code	System Affected	Probable Cause
11 (1)	Crank Angle Sensor	(2) No Crank Signal
12	Airflow Meter Circuit	Open/Shorted Circuit
13	Coolant Temperature Sensor	Open/Shorted Circuit
14	Vehicle Speed Sensor (VSS)	No VSS Signal
21 (1)	Ignition Signal Circuit	(2) Open/Shorted Circuit
31	ECU	Signals Not Normal
32 (4)	EGR Function	No EGR Action
34 (1)	Knock Sensor	Open/Shorted Circuit
35 (4)	Exhaust Temperature Sensor	Open/Shorted Circuit
43	Throttle Sensor	Open/Shorted Circuit
45 (4)	Injector Leak	Leak At Injectors
51 (4)	Injector Circuit	Injector Does Not Work
55 (1)	No Malfunction	Normal Condition

- (1) - Trouble code will not activate CHECK ENGINE light.
- (2) - If Codes 11 and 21 are present at same time, check items causing a malfunction of crank angle sensor circuit first.
- (3) - See ANTI-LOCK BRAKE SYSTEM article in the BRAKES Section.

(4) - California models.

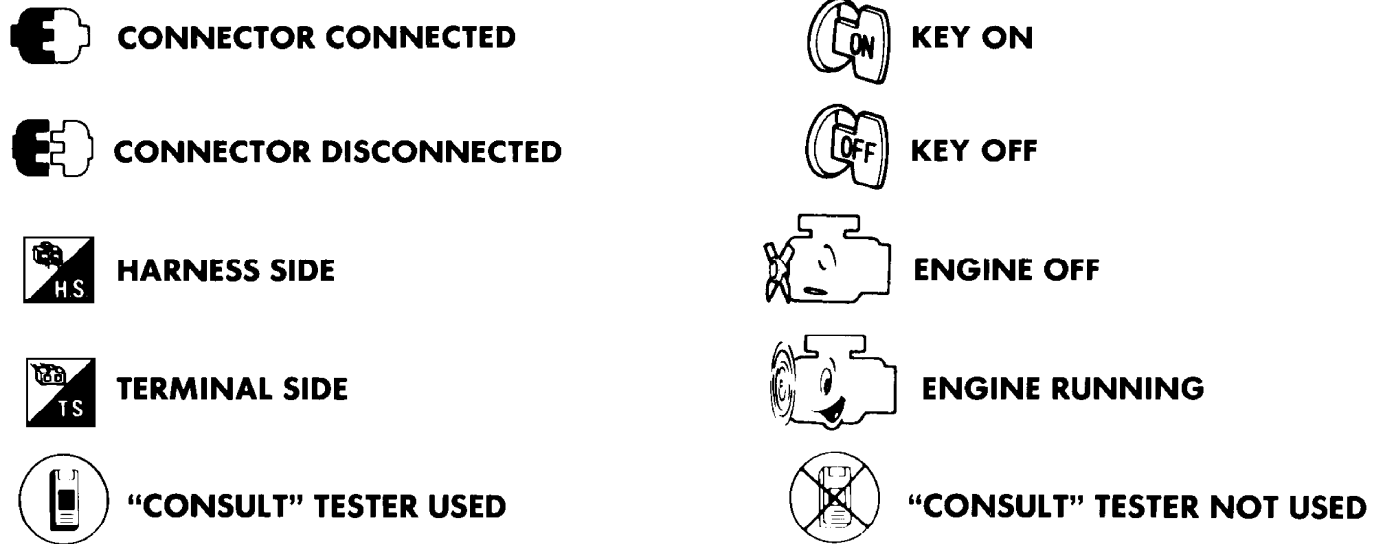

90F18734

Fig. 1: Identifying Trouble Code Chart Symbols
Courtesy of Nissan Motor Co., U.S.A.

TROUBLE CODE CHARTS

READ THIS FIRST

NOTE: Most code charts shown include procedures using Nissan Consult Tester (J-38465). If consult tester is not available, disregard steps using consult tester and use alternate test procedure. OK = Okay; NG = No Good.

CODE 11 - CRANK ANGLE SENSOR

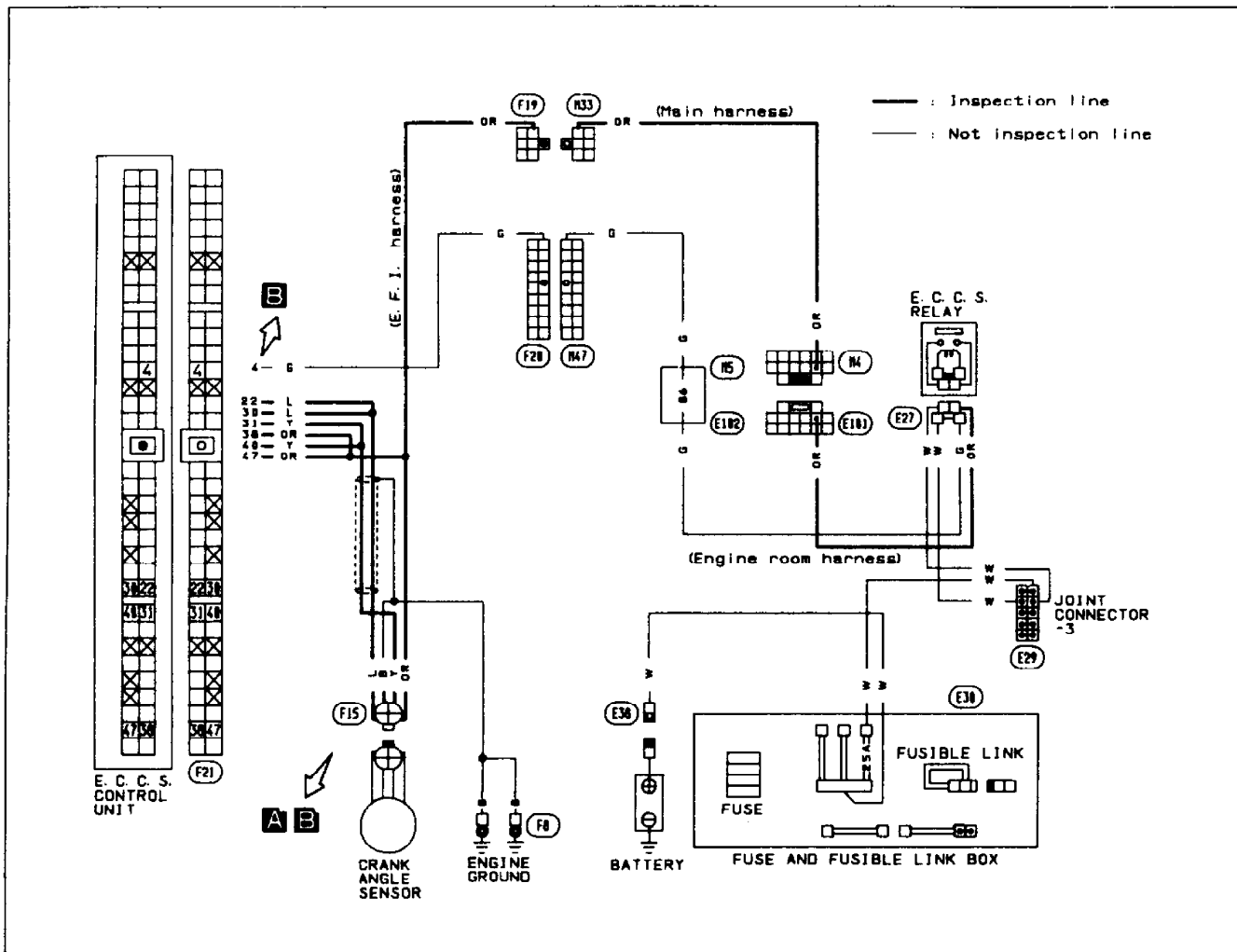

Harness layout

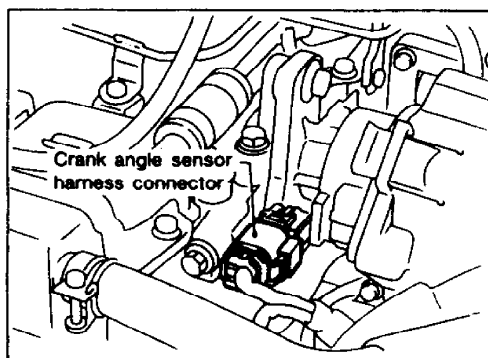
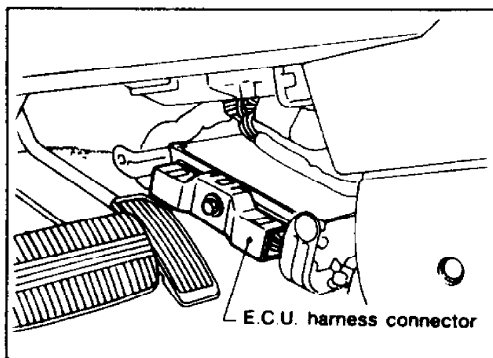

CONTINUED ON NEXT GRAPHIC

Fig. 2: Code 11 Schematic - Crank Angle Sensor
 Courtesy of Nissan Motor Co., U.S.A.

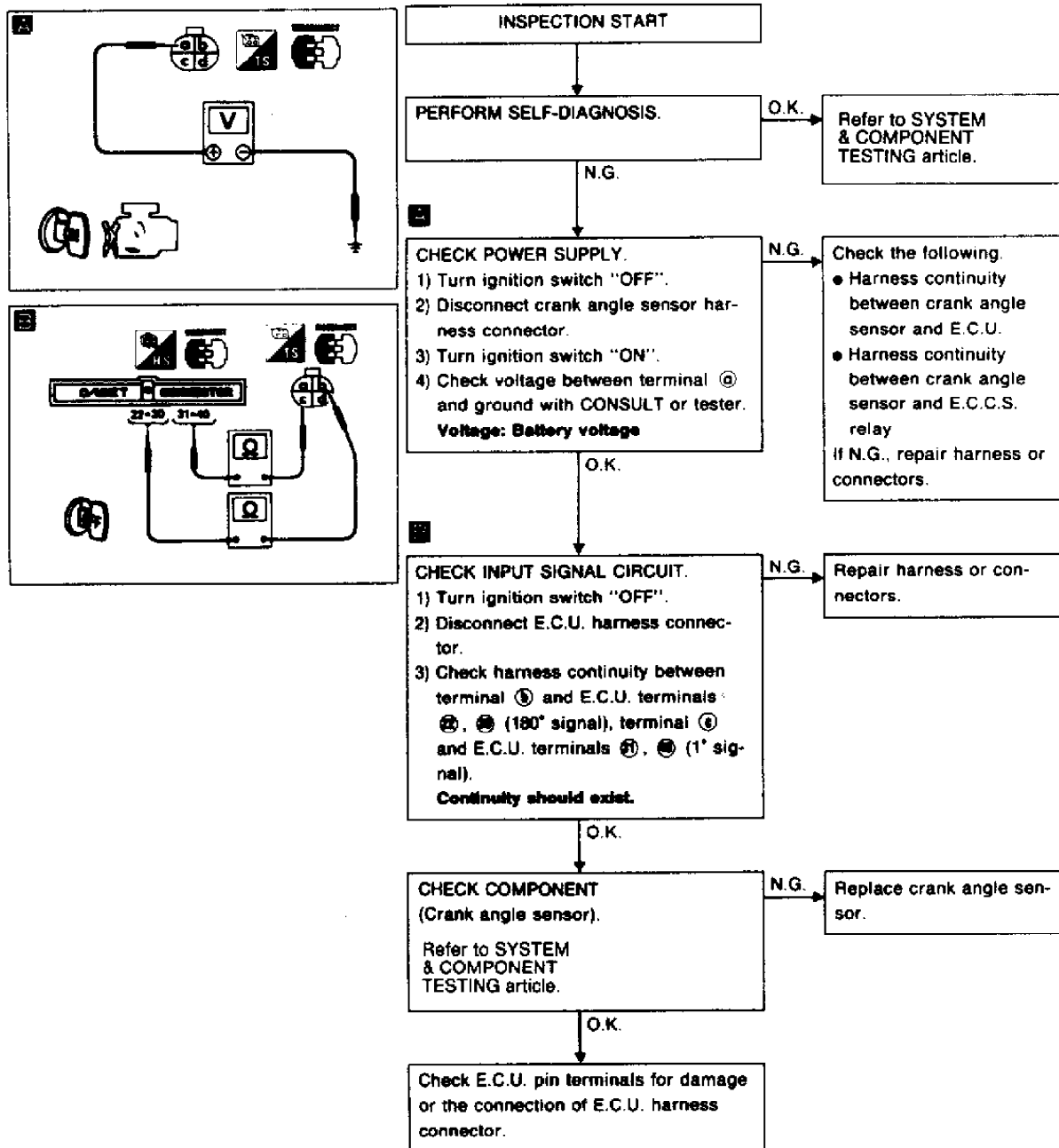

WHEN ALL DIAGNOSIS AND REPAIRS ARE COMPLETED, CLEAR CODES AND VERIFY OPERATION.

92G25714

Fig. 3: Code 11 Chart - Crank Angle Sensor
Courtesy of Nissan Motor Co., U.S.A.

CODE 12 - AIRFLOW METER

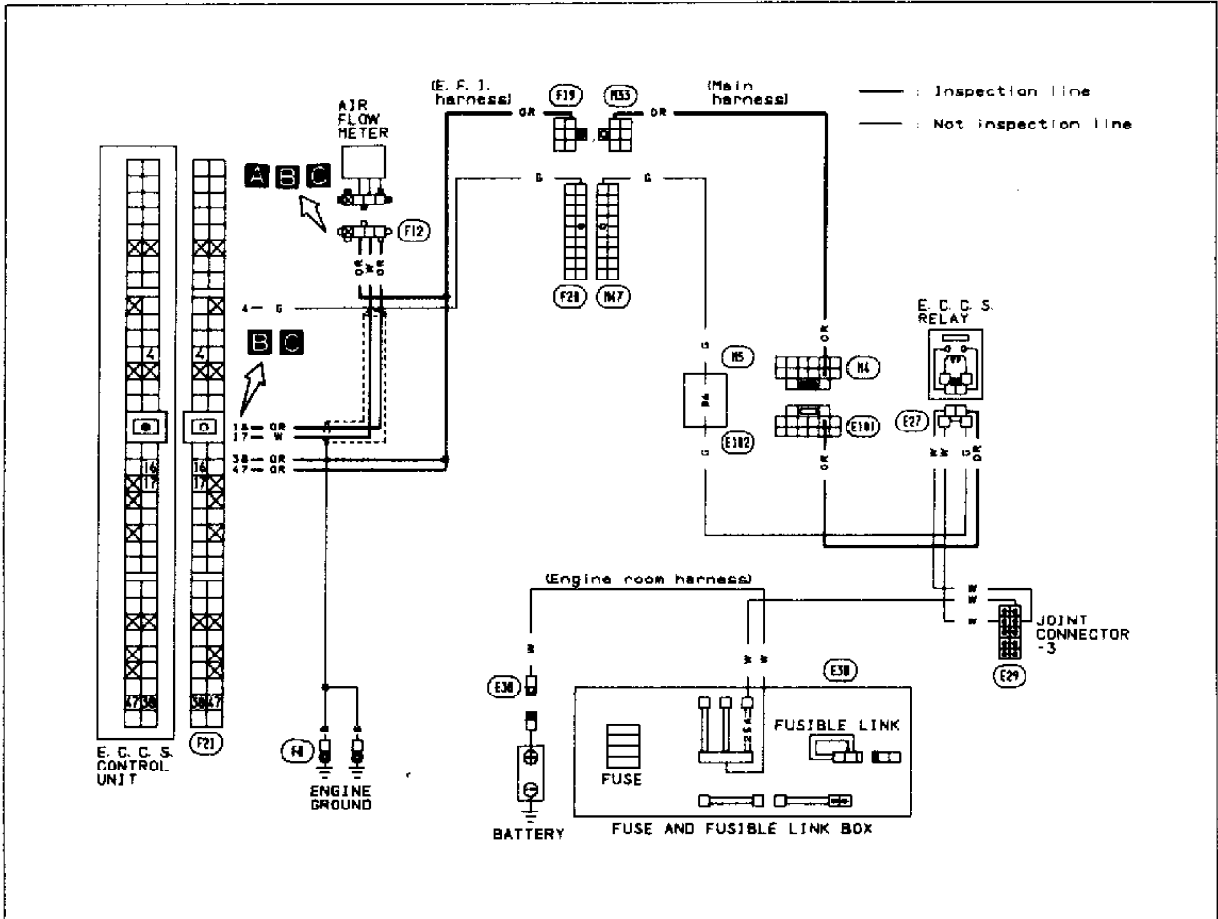

Harness layout

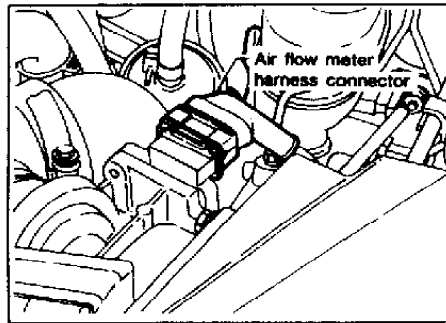
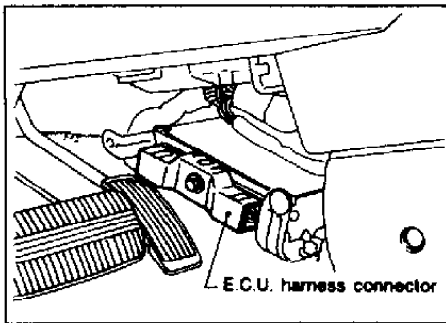

CONTINUED ON NEXT GRAPHIC

92H25715

Fig. 4: Code 12 Schematic - Airflow Meter
 Courtesy of Nissan Motor Co., U.S.A.

Continued From Previous Graphic

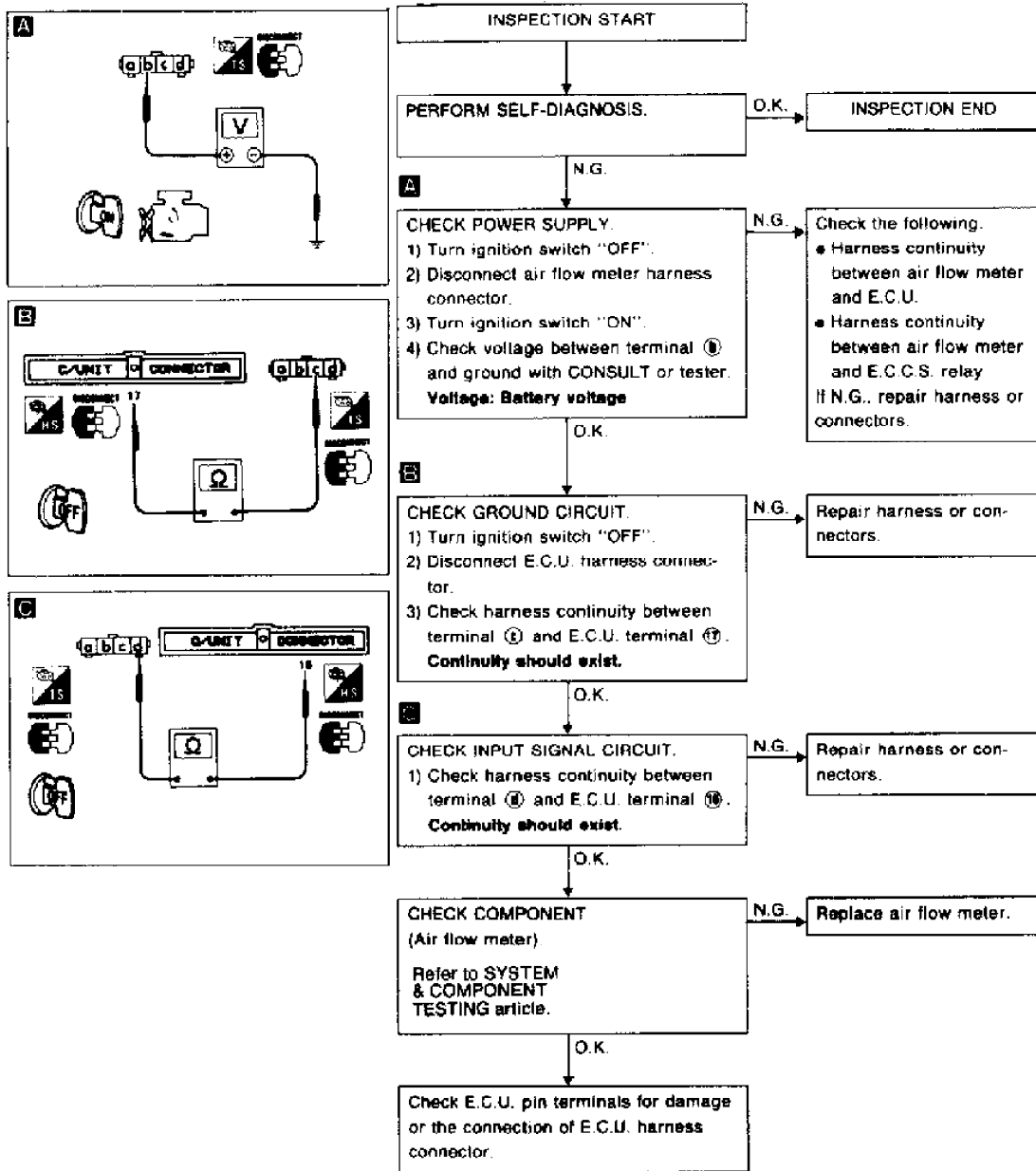

WHEN ALL DIAGNOSIS AND REPAIRS ARE COMPLETED, CLEAR CODES AND VERIFY OPERATION.

92I25716

Fig. 5: Code 12 Chart - Airflow Meter
Courtesy of Nissan Motor Co., U.S.A.

CODE 13 - ENGINE (COOLANT) TEMPERATURE SENSOR

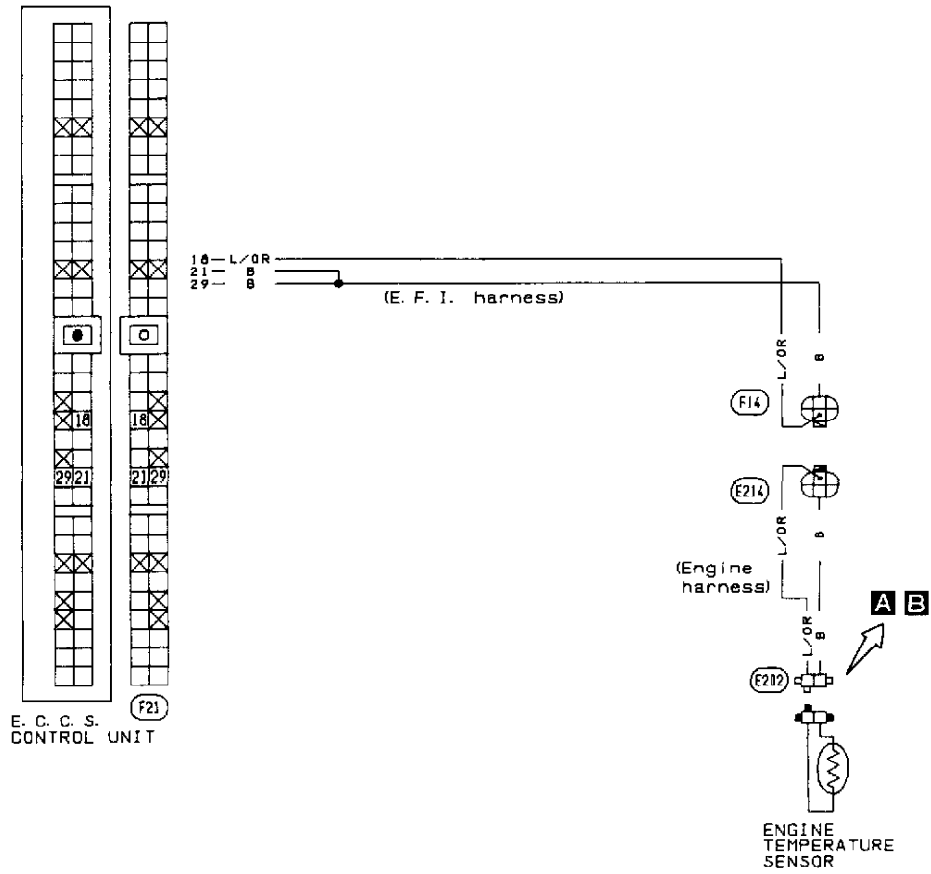

Fig. 6: Code 13 Schematic - Engine (Coolant) Temperature Sensor
 Courtesy of Nissan Motor Co., U.S.A.

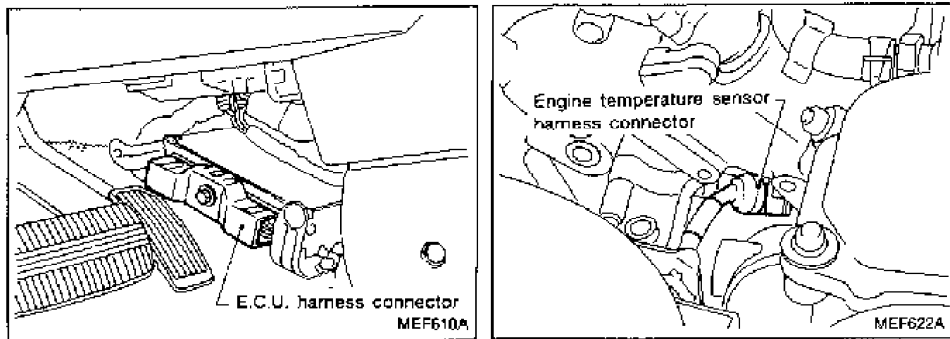
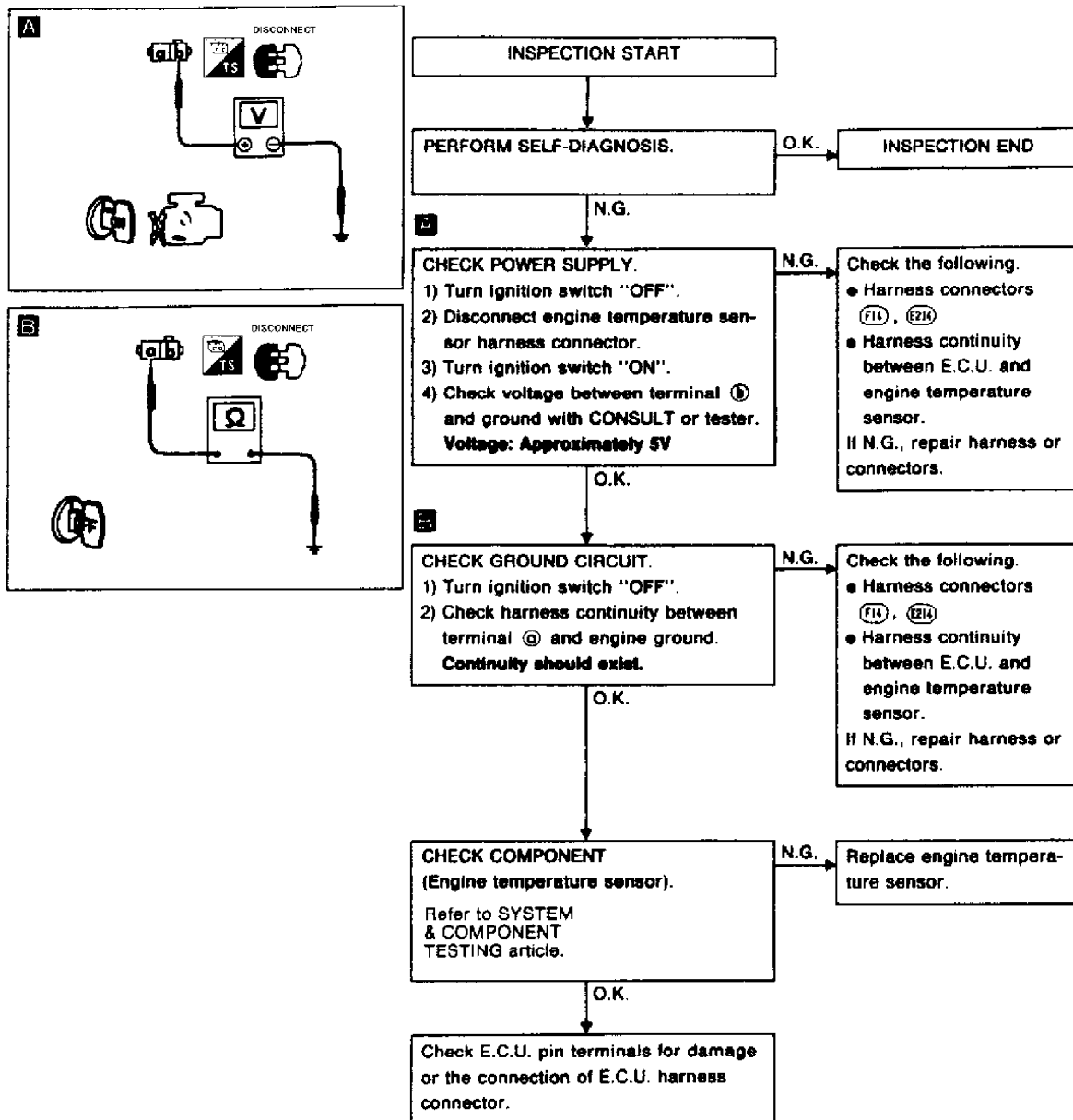

Fig. 7: Code 13 Connector ID - Engine (Coolant) Temperature Sensor
 Courtesy of Nissan Motor Co., U.S.A.



WHEN ALL DIAGNOSIS AND REPAIRS ARE COMPLETED, CLEAR CODES AND VERIFY OPERATION.

92J25717

Fig. 8: Code 13 Chart - Engine (Coolant) Temperature Sensor
Courtesy of Nissan Motor Co., U.S.A.

CODE 14 - VEHICLE SPEED SENSOR

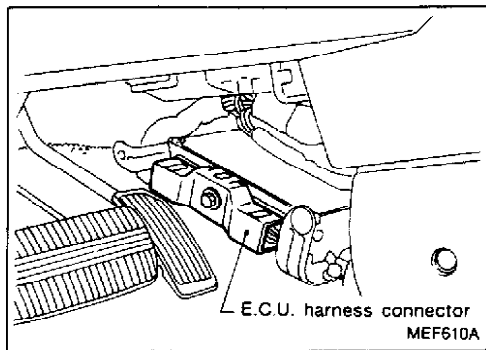
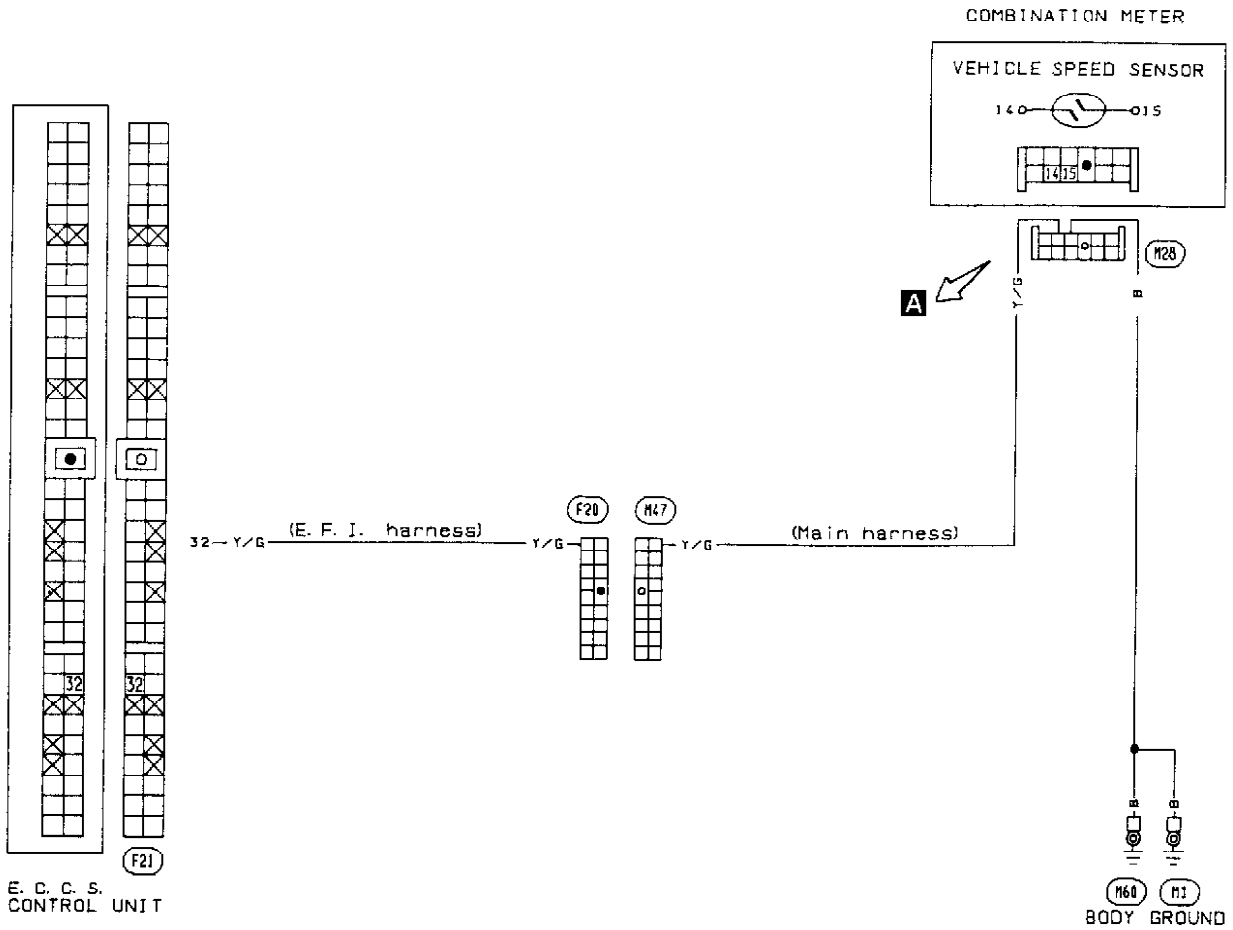
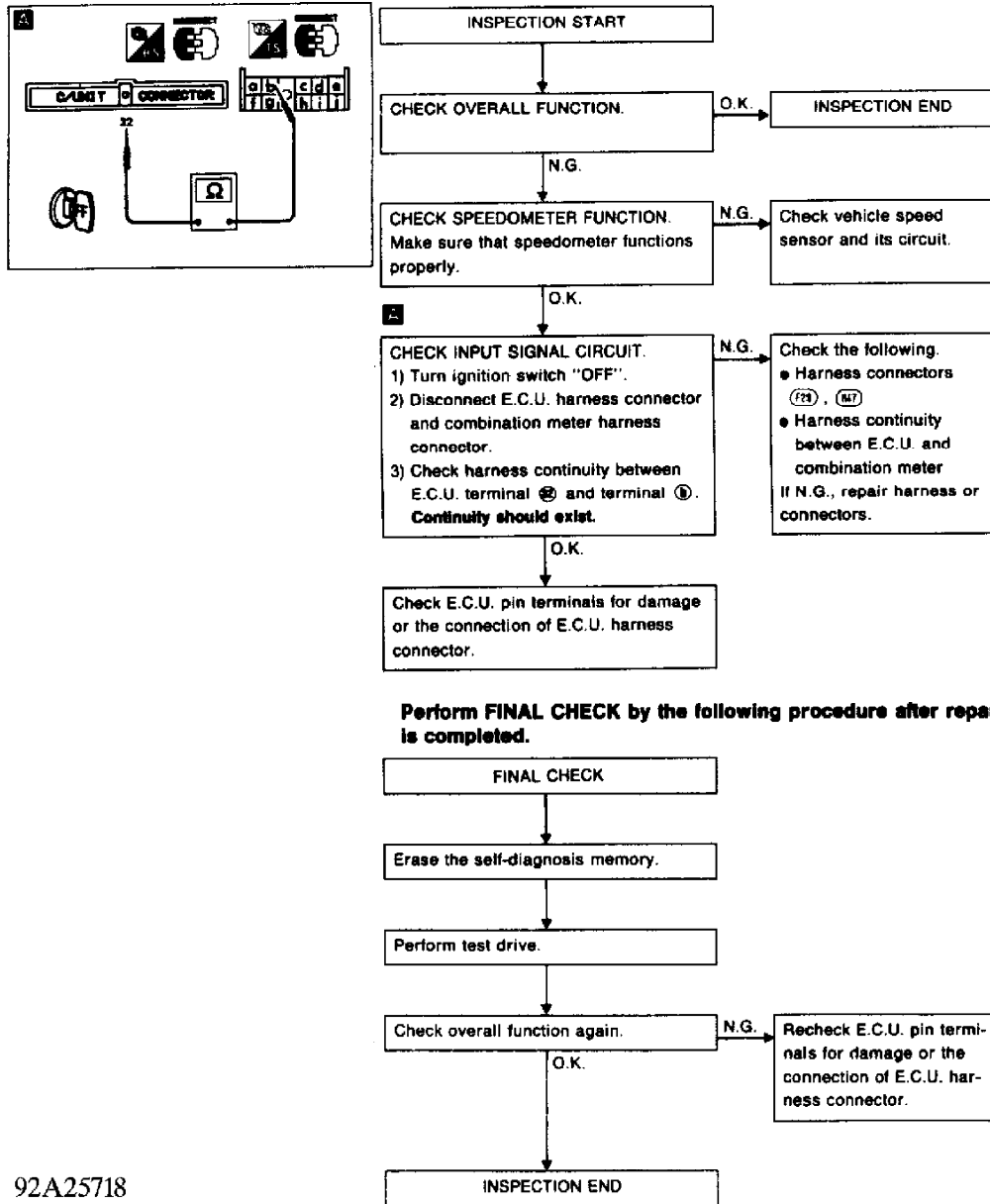

Fig. 9: Code 14 Schematic - Vehicle Speed Sensor
 Courtesy of Nissan Motor Co., U.S.A.

**CODE 14
VEHICLE SPEED SENSOR (Cont.)
G20**



92A25718

WHEN ALL DIAGNOSIS AND REPAIRS ARE COMPLETED, CLEAR CODES AND VERIFY OPERATION.

Fig. 10: Code 14 Chart - Vehicle Speed Sensor
Courtesy of Nissan Motor Co., U.S.A.

CODE 21 - IGNITION SIGNAL CIRCUIT

IGNITION SIGNAL CIRCUIT G20

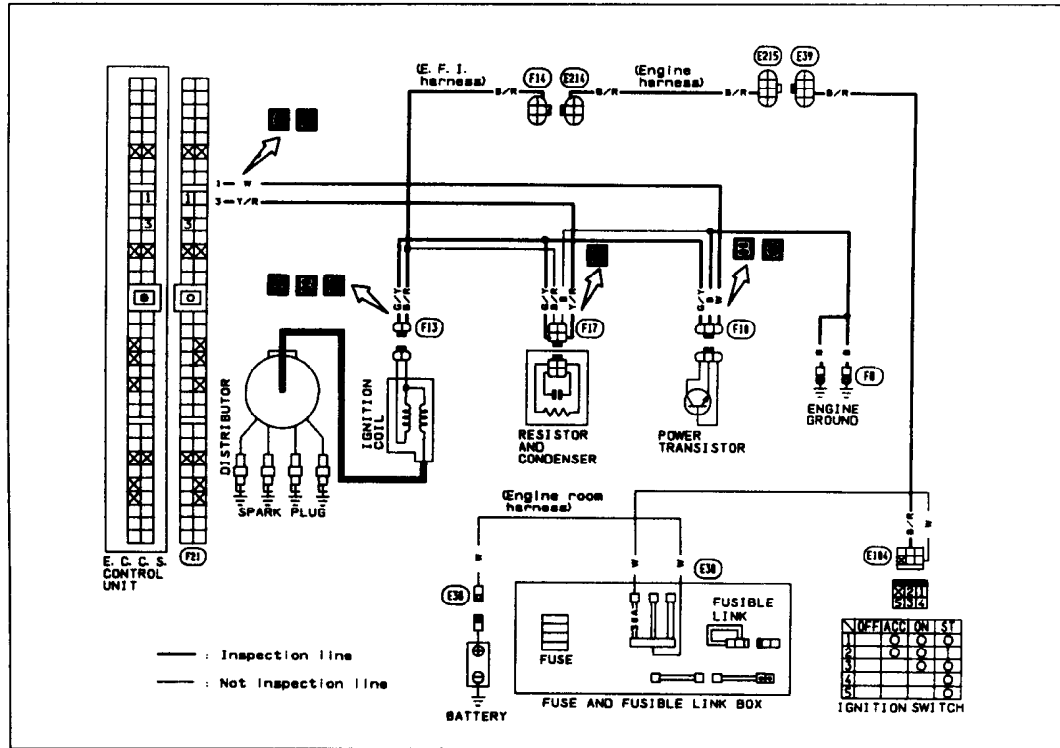

Harness layout

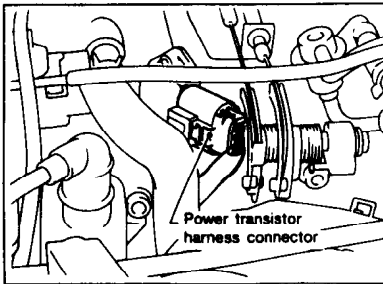
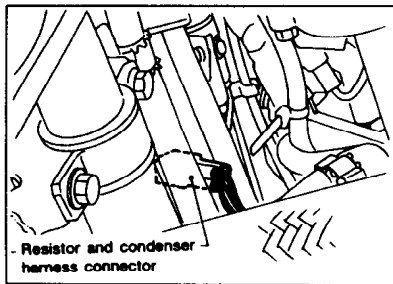
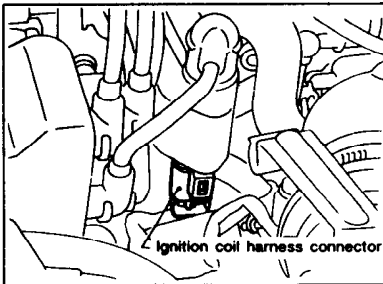
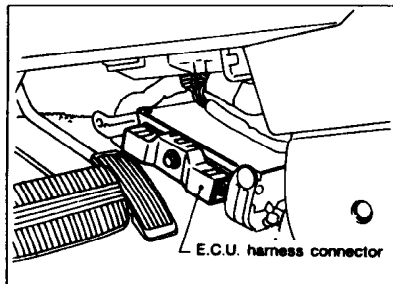

92B25719

CONTINUED ON NEXT PAGE

Fig. 11: Code 21 Schematic - Ignition Signal Circuit
 Courtesy of Nissan Motor Co., U.S.A.

IGNITION SIGNAL CIRCUIT (Cont.) G20

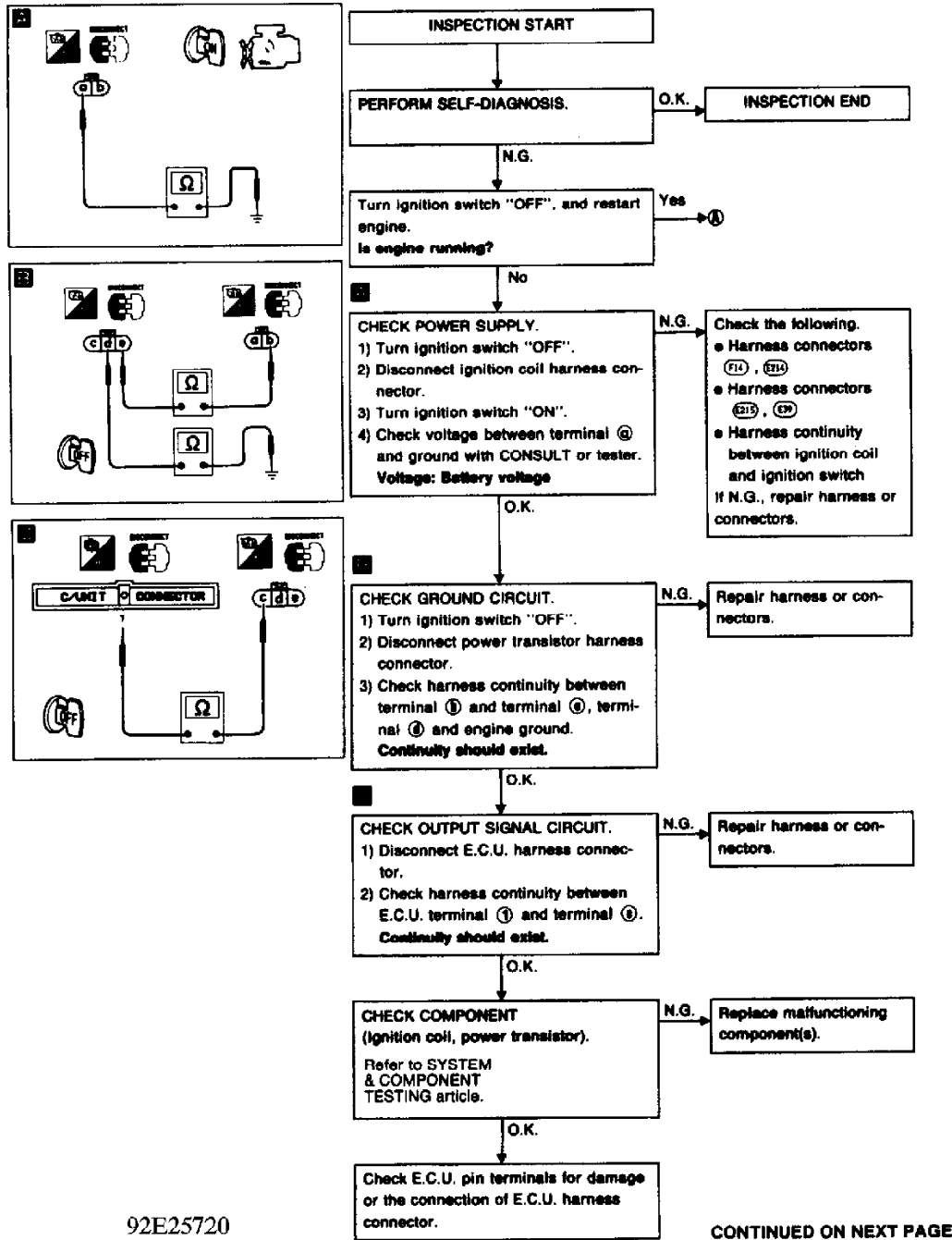

92E25720

CONTINUED ON NEXT PAGE

Fig. 12: Code 21 Chart (1 of 2) - Ignition Signal Circuit
Courtesy of Nissan Motor Co., U.S.A.

Continued From Previous Graphic

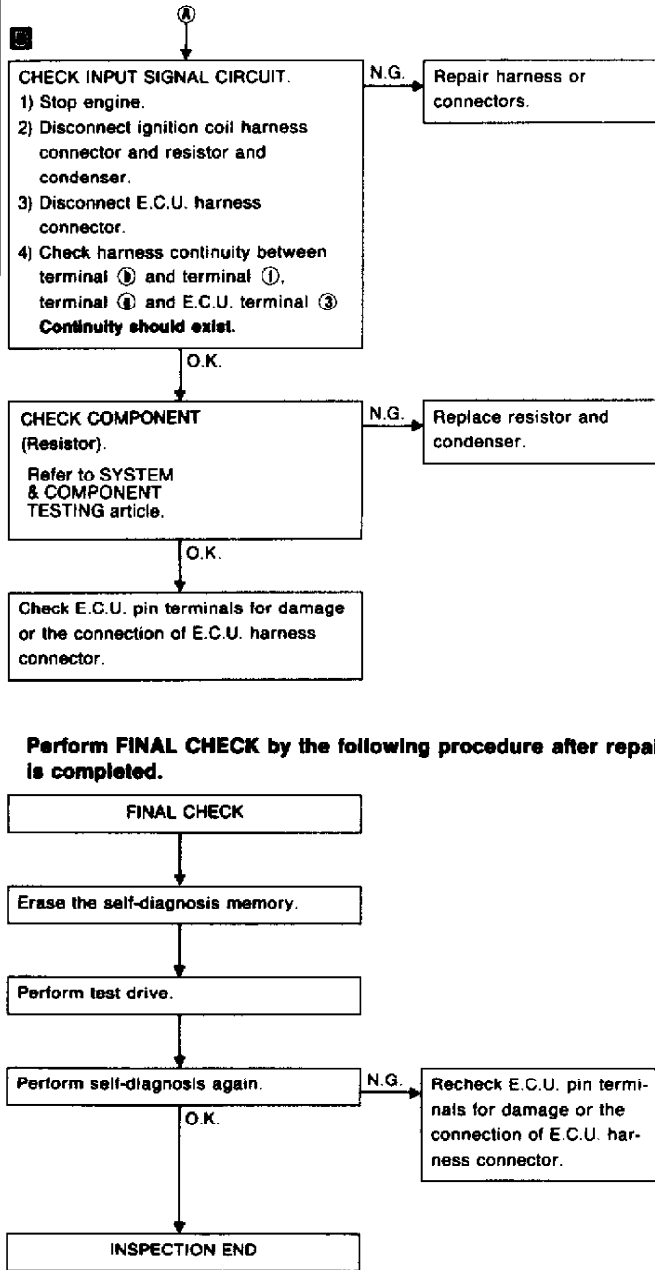
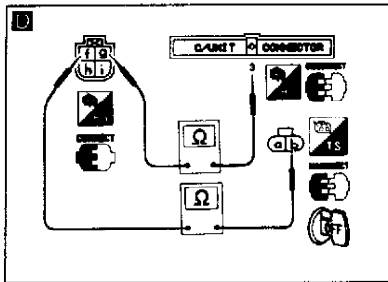

WHEN ALL DIAGNOSIS AND REPAIRS ARE COMPLETED, CLEAR CODES AND VERIFY OPERATION.

92F25721

Fig. 13: Code 21 Chart (2 of 2) - Ignition Signal Circuit
 Courtesy of Nissan Motor Co., U.S.A.

CODE 31 - ENGINE CONTROL UNIT (ECU)

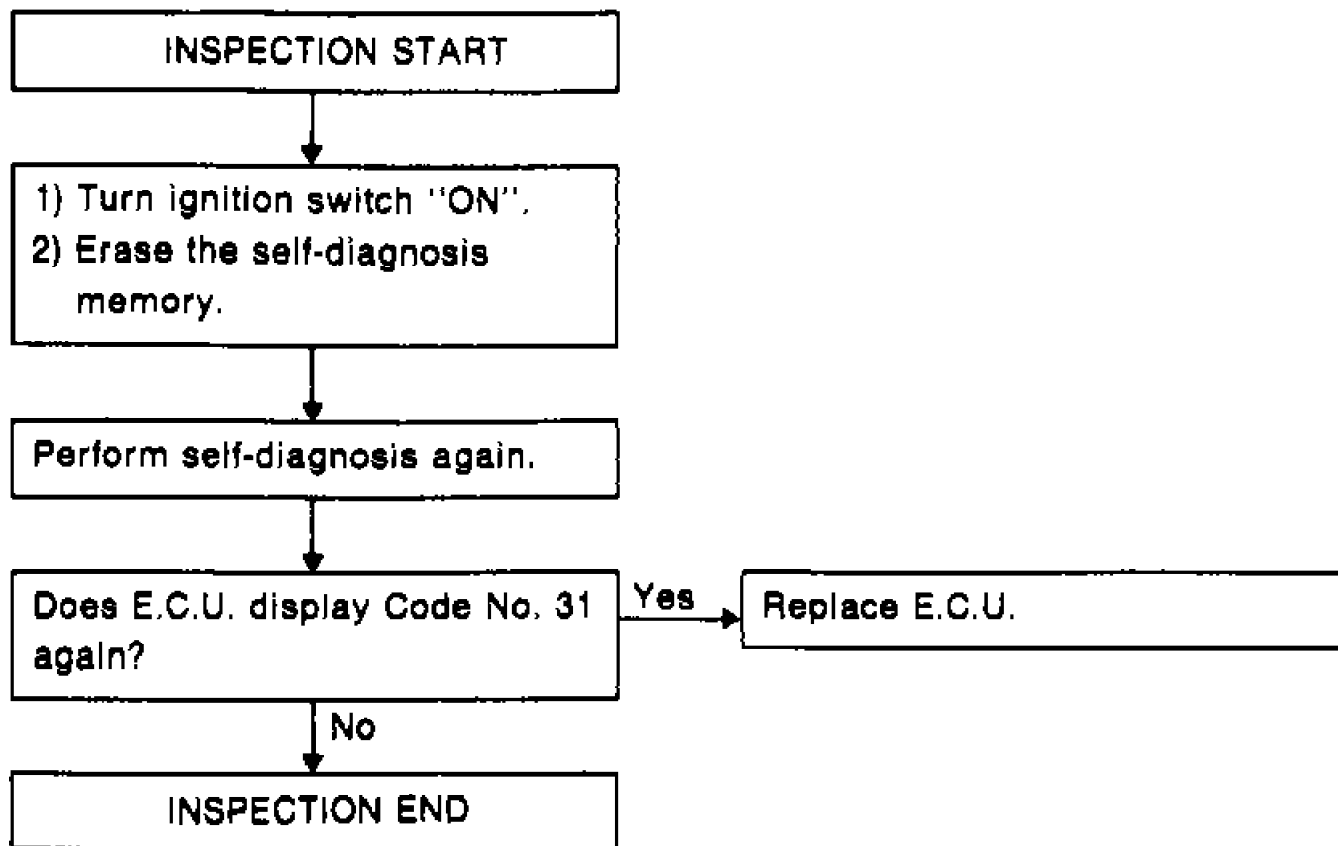
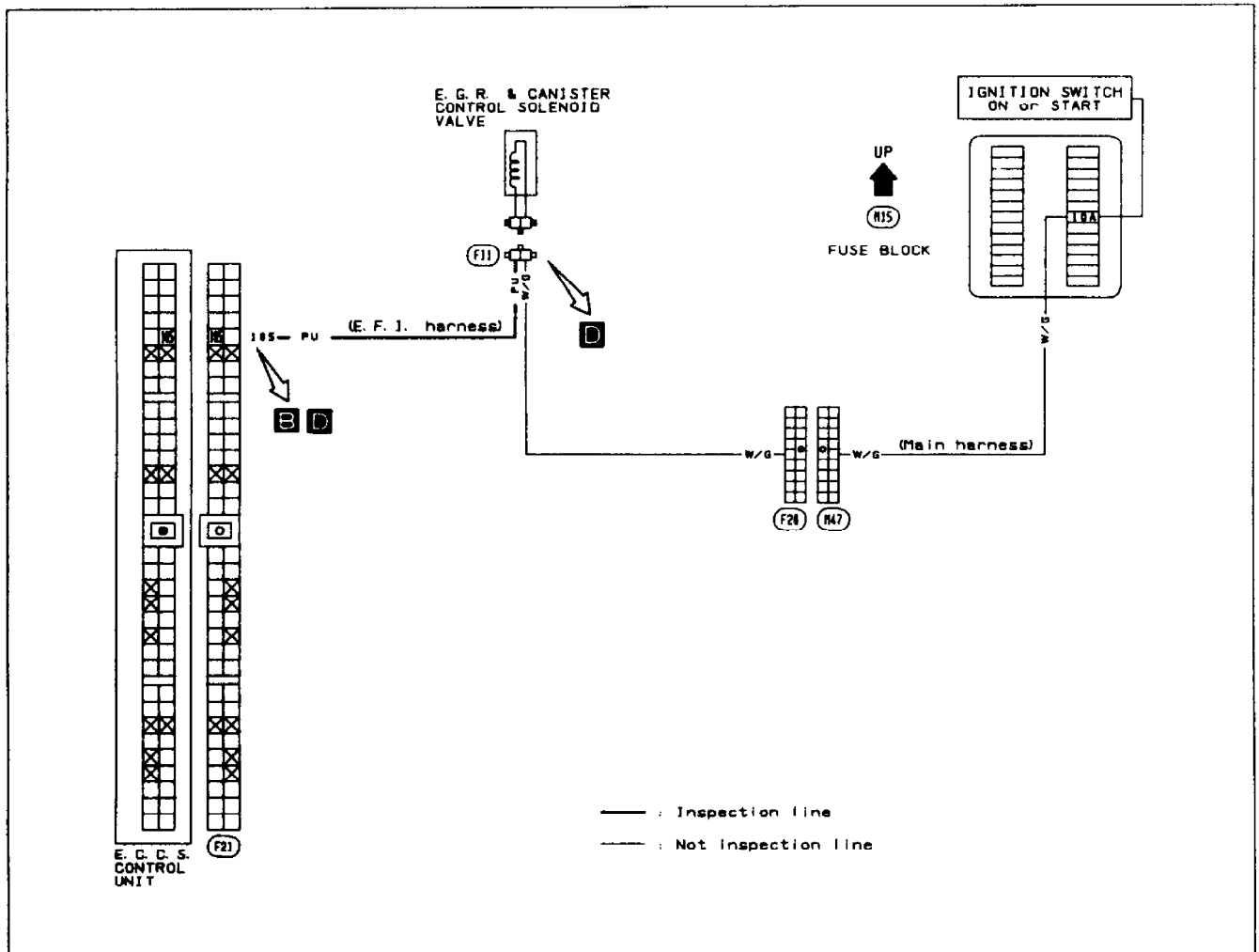
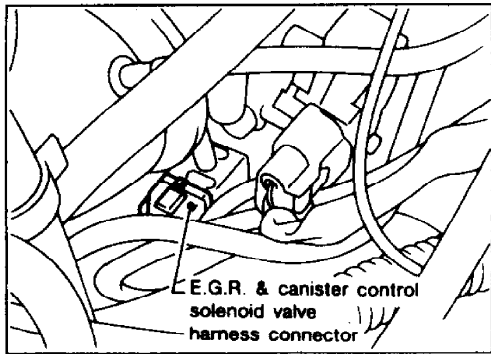
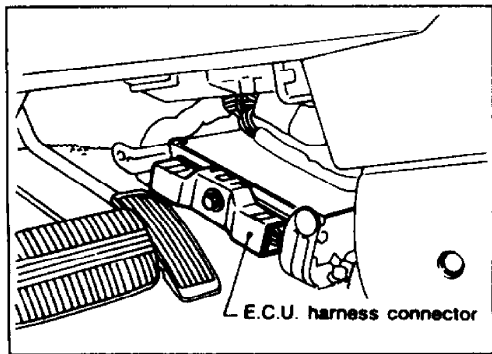

Fig. 14: Code 31 Chart - Engine Control Unit (ECU)
Courtesy of Nissan Motor Co., U.S.A.

CODE 32 - EGR SYSTEM FUNCTION



Harness layout



CONTINUED ON NEXT GRAPHIC

92G25722

Fig. 15: Code 32 Schematic - EGR System Function
 Courtesy of Nissan Motor Co., U.S.A.

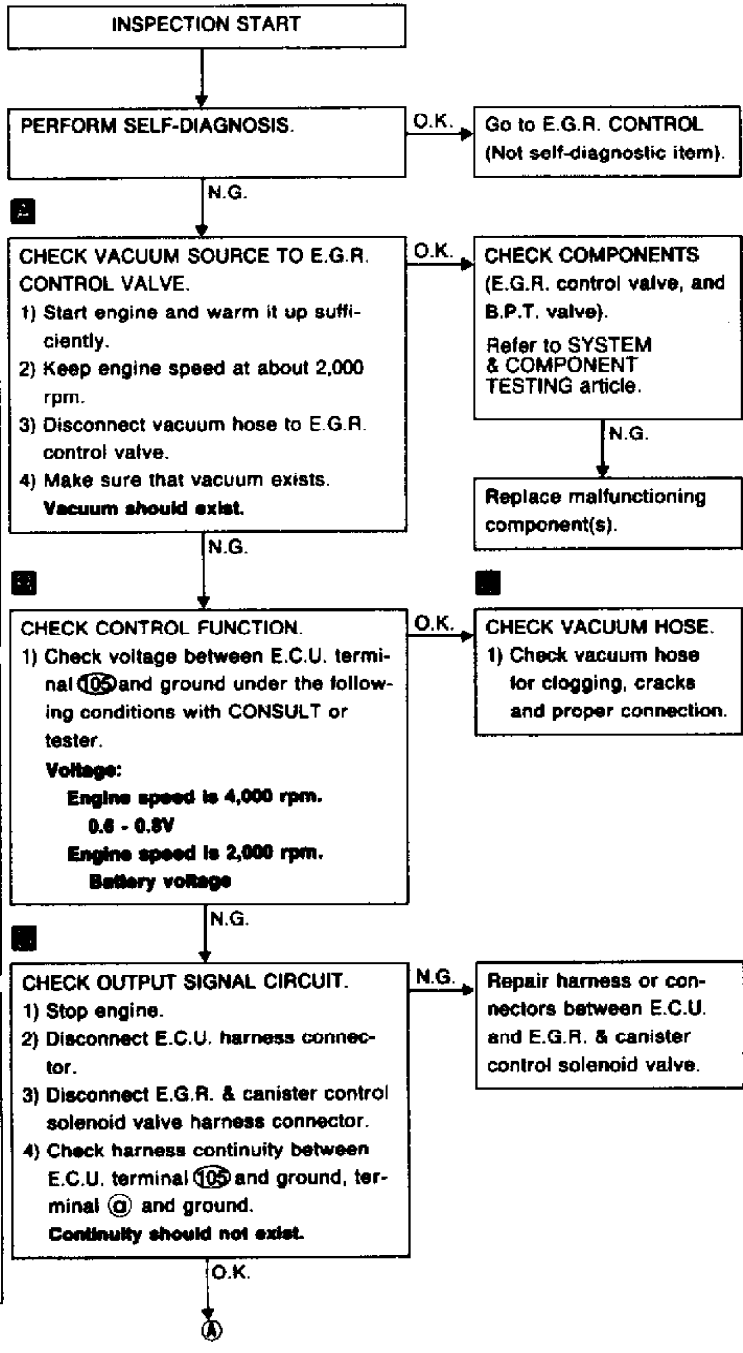
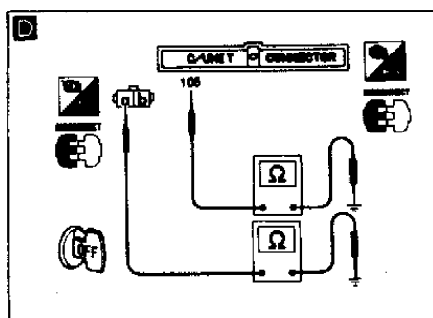
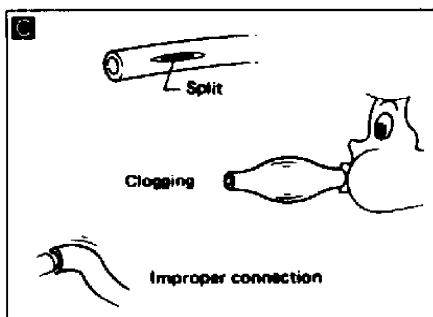
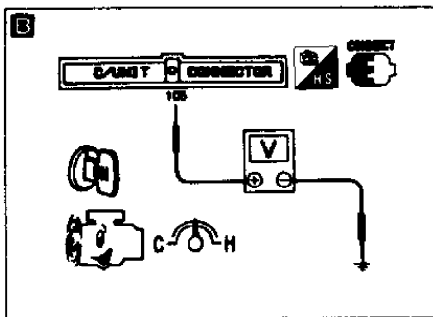
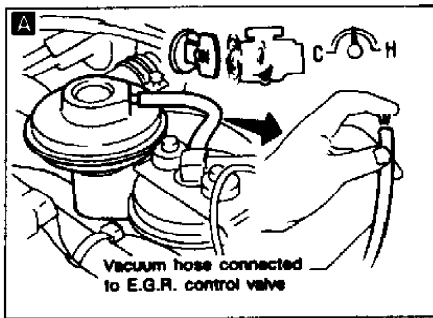

CONTINUED ON NEXT GRAPHIC

92H25723

Fig. 16: Code 32 Chart (1 of 2) - EGR System Function
 Courtesy of Nissan Motor Co., U.S.A.

Continued From Previous Graphic

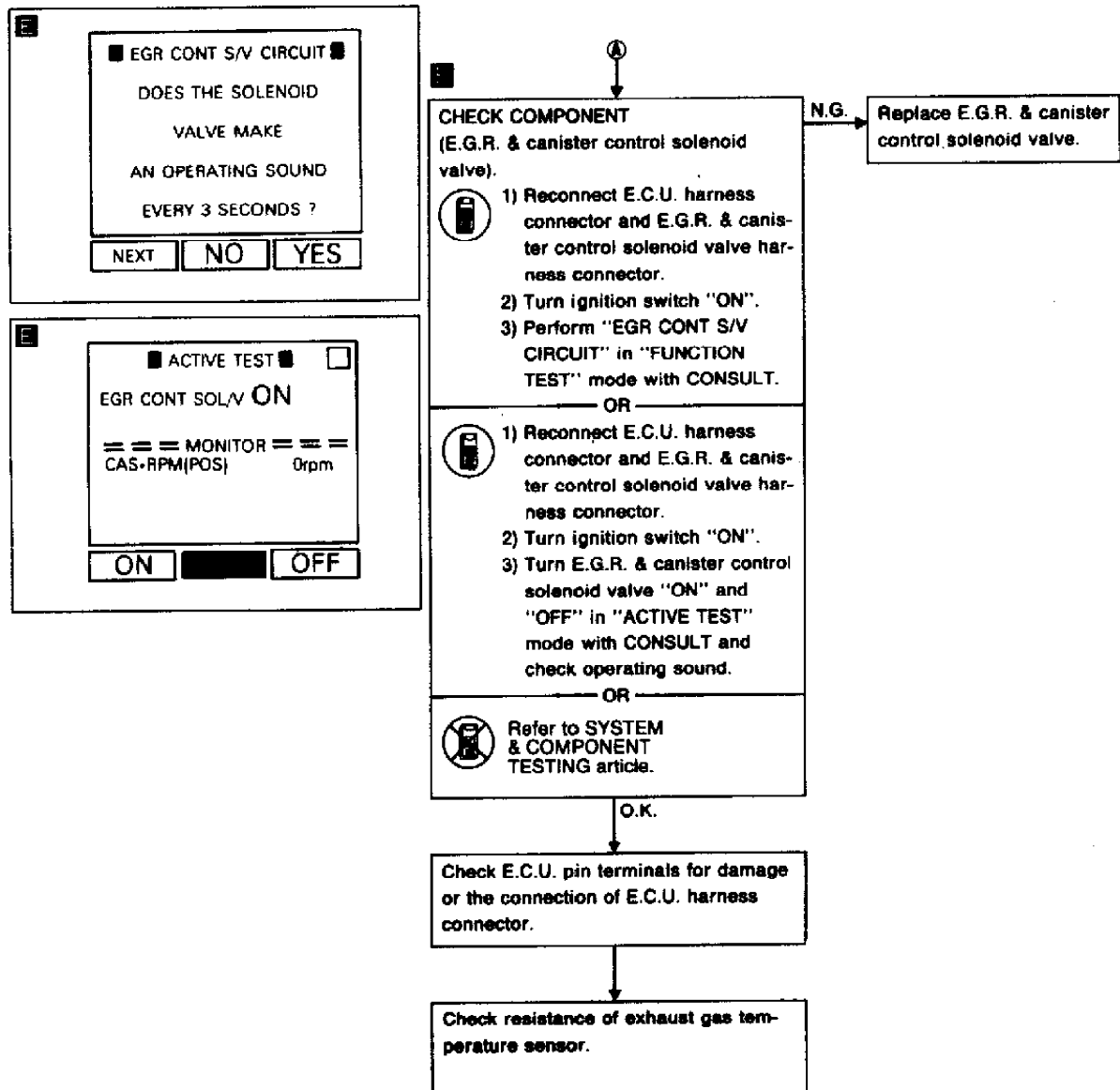

WHEN ALL DIAGNOSIS AND REPAIRS ARE COMPLETED, CLEAR CODES AND VERIFY OPERATION.

92I25724

Fig. 17: Code 32 Chart (2 of 2) - EGR System Function
 Courtesy of Nissan Motor Co., U.S.A.

CODE 33 - OXYGEN SENSOR

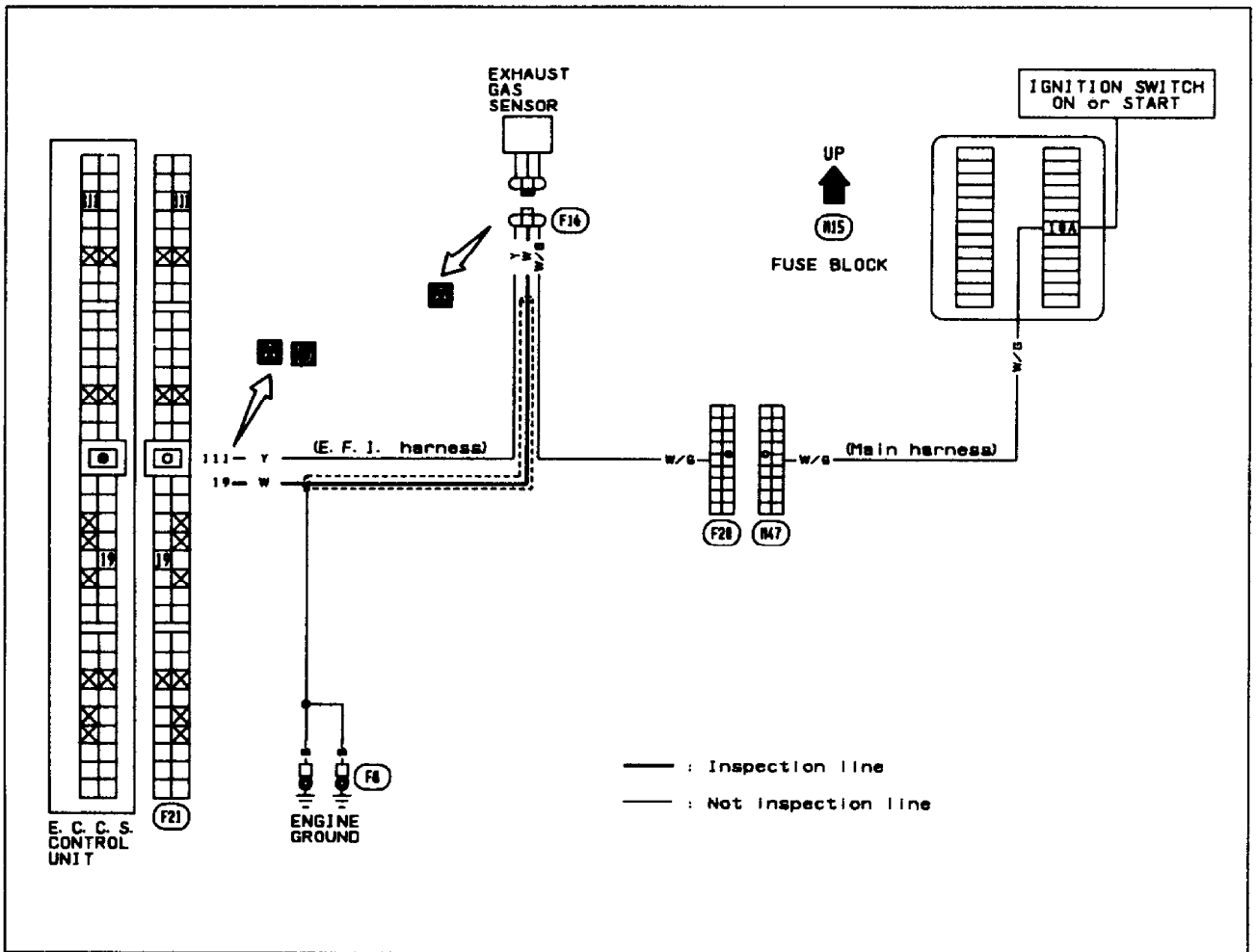

Harness layout

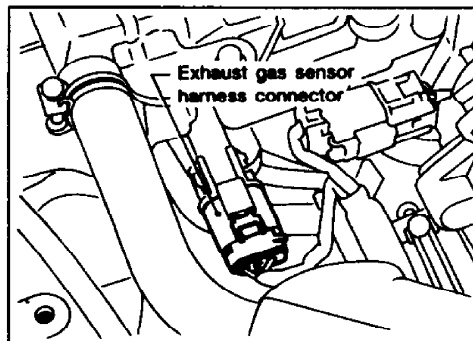
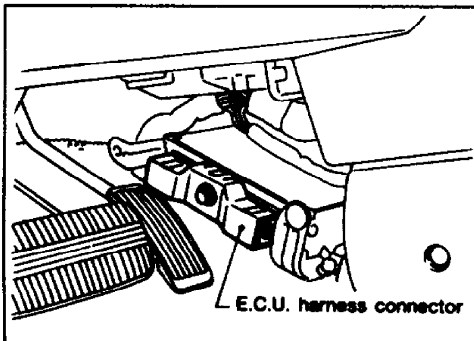

CONTINUED ON NEXT GRAPHIC

92A25726

Fig. 18: Code 33 Schematic - Oxygen Sensor
 Courtesy of Nissan Motor Co., U.S.A.

OXYGEN SENSOR (Cont.) G20

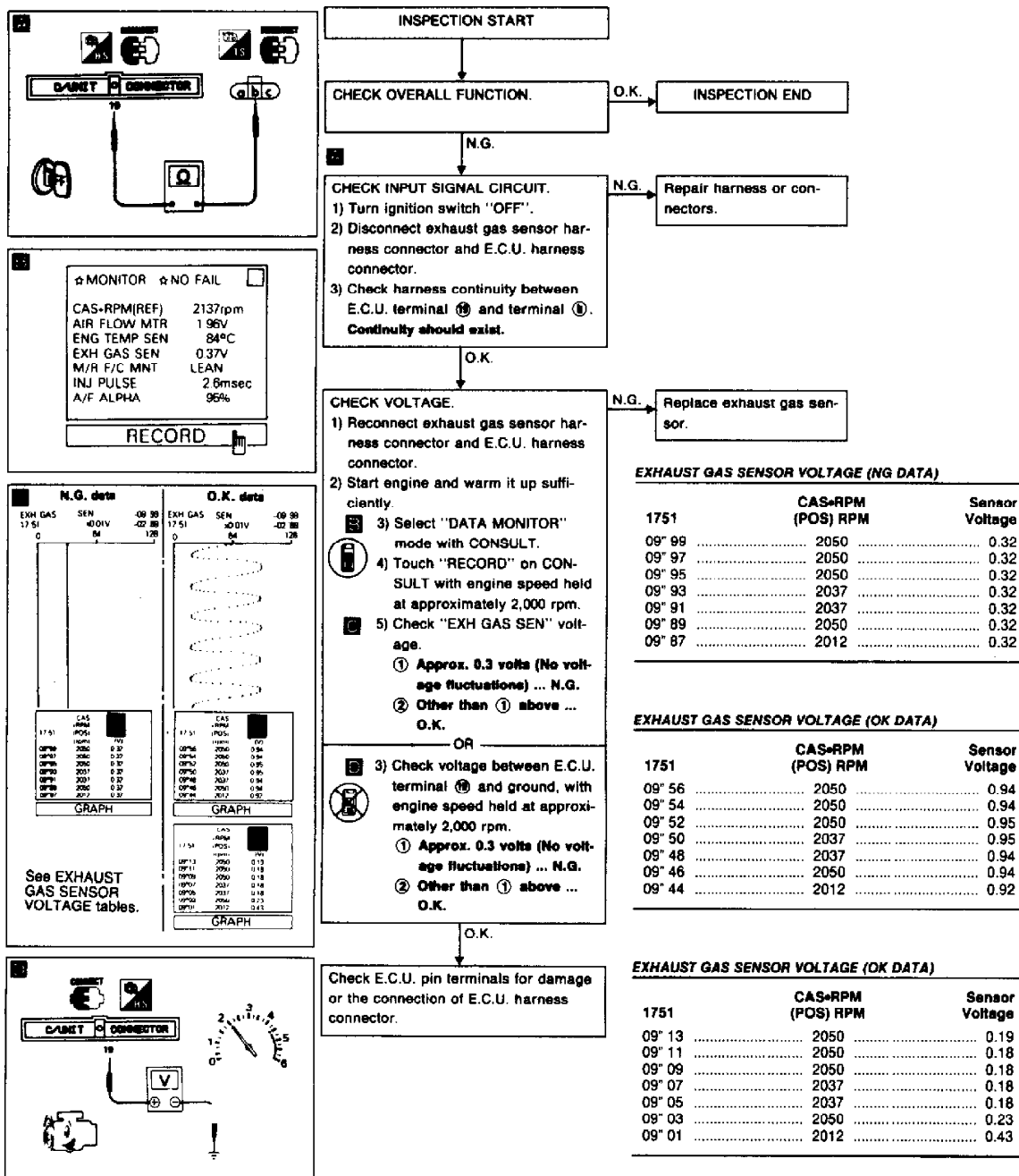

WHEN ALL DIAGNOSIS AND REPAIRS ARE COMPLETED, CLEAR CODES AND VERIFY OPERATION.

92B25727

Fig. 19: Code 33 Chart - Oxygen Sensor
Courtesy of Nissan Motor Co., U.S.A.

CODE 34 - KNOCK (DETONATION) SENSOR

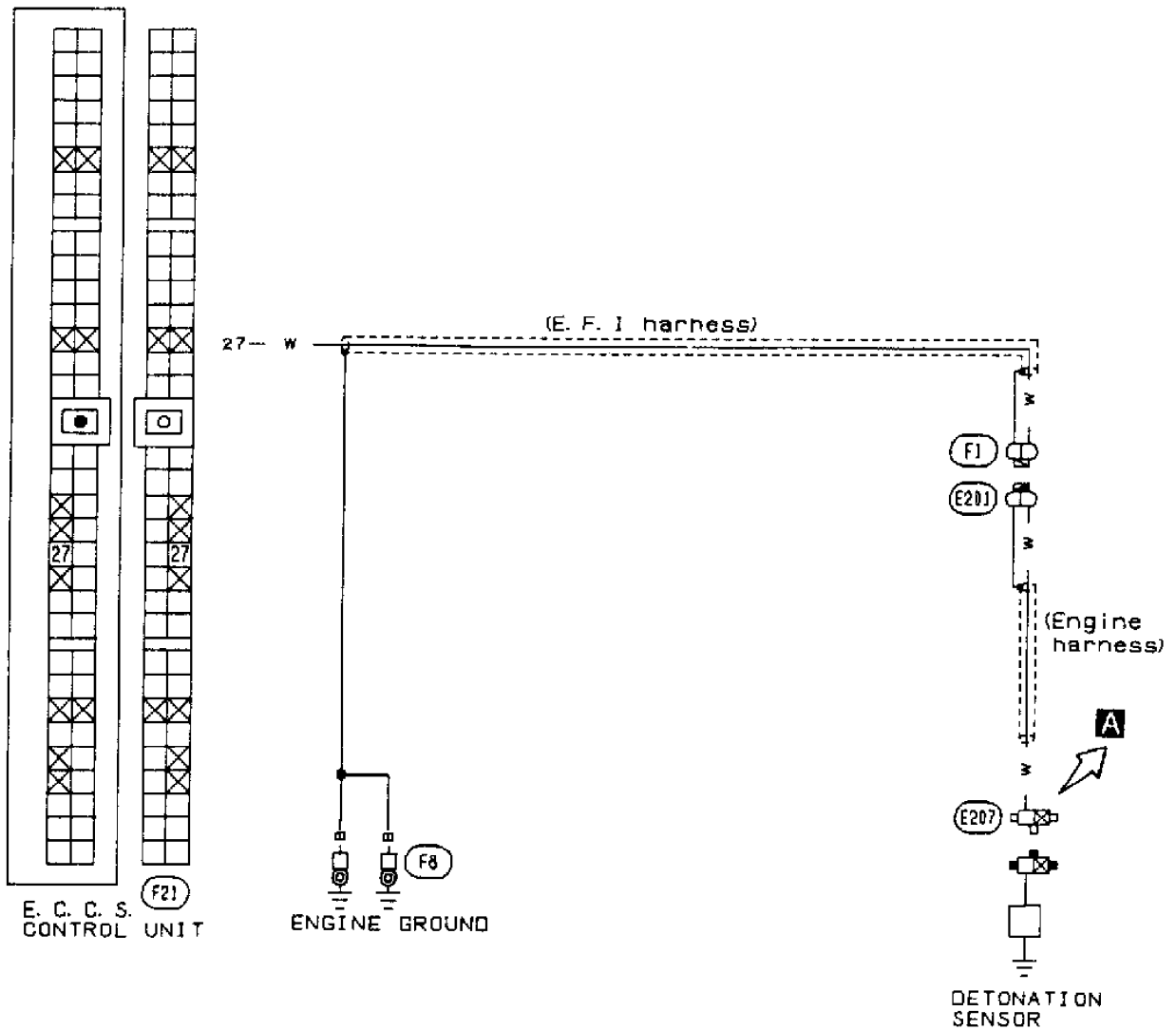

Fig. 20: Code 34 Schematic - Knock (Detonation) Sensor
 Courtesy of Nissan Motor Co., U.S.A.

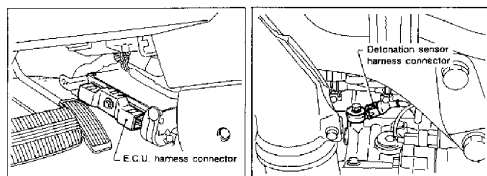

Fig. 21: Code 34 Connector ID - Knock (Detonation) Sensor
 Courtesy of Nissan Motor Co., U.S.A.

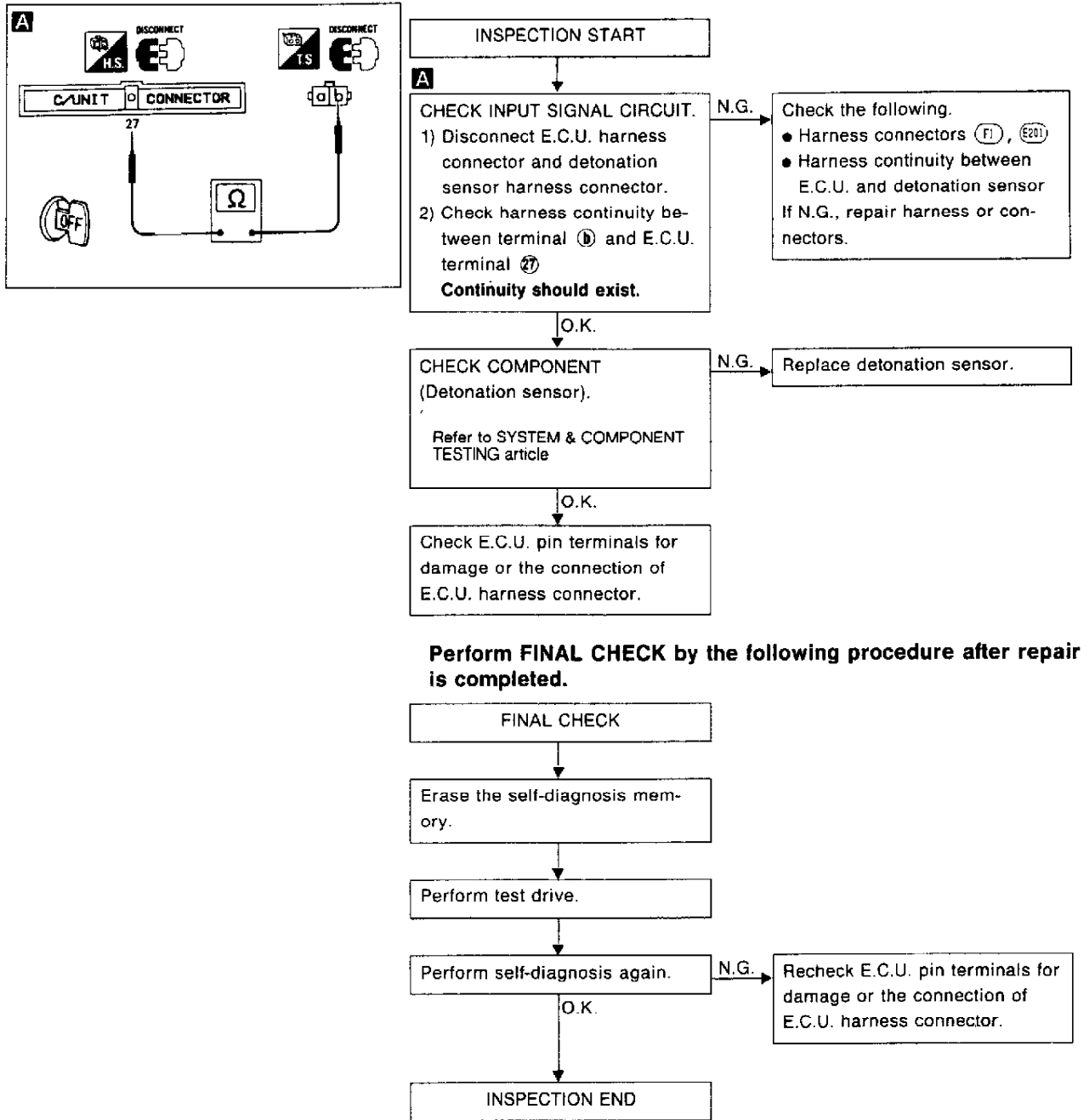
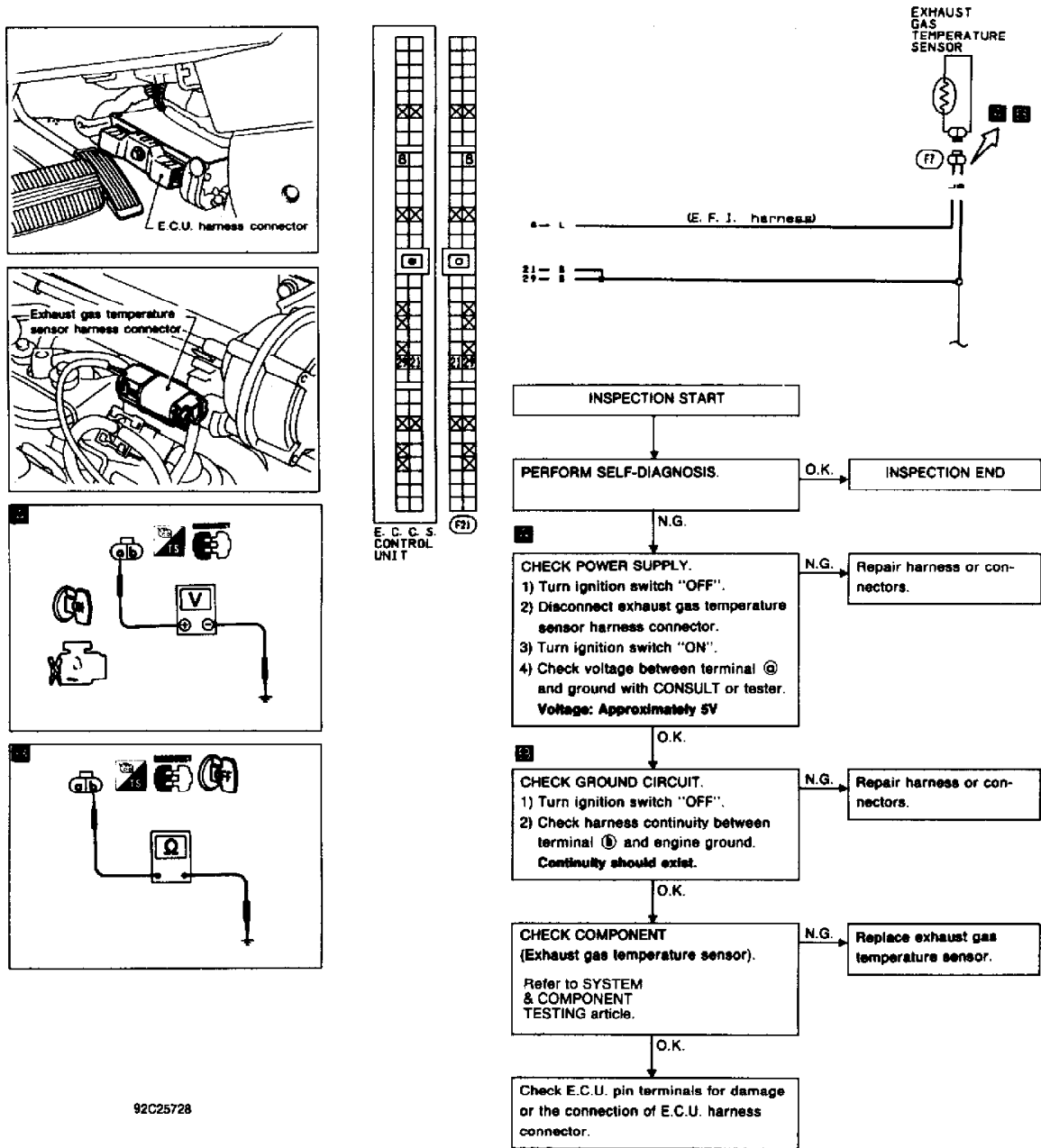

Fig. 22: Code 34 Chart - Knock (Detonation) Sensor
 Courtesy of Nissan Motor Co., U.S.A.

CODE 35 - EXHAUST GAS TEMPERATURE SENSOR

EXHAUST GAS TEMPERATURE SENSOR G20



WHEN ALL DIAGNOSIS AND REPAIRS ARE COMPLETED, CLEAR CODES AND VERIFY OPERATION.

Fig. 23: Code 35 Chart - Exhaust Gas Temperature Sensor
Courtesy of Nissan Motor Co., U.S.A.

CODE 43 - THROTTLE POSITION SENSOR

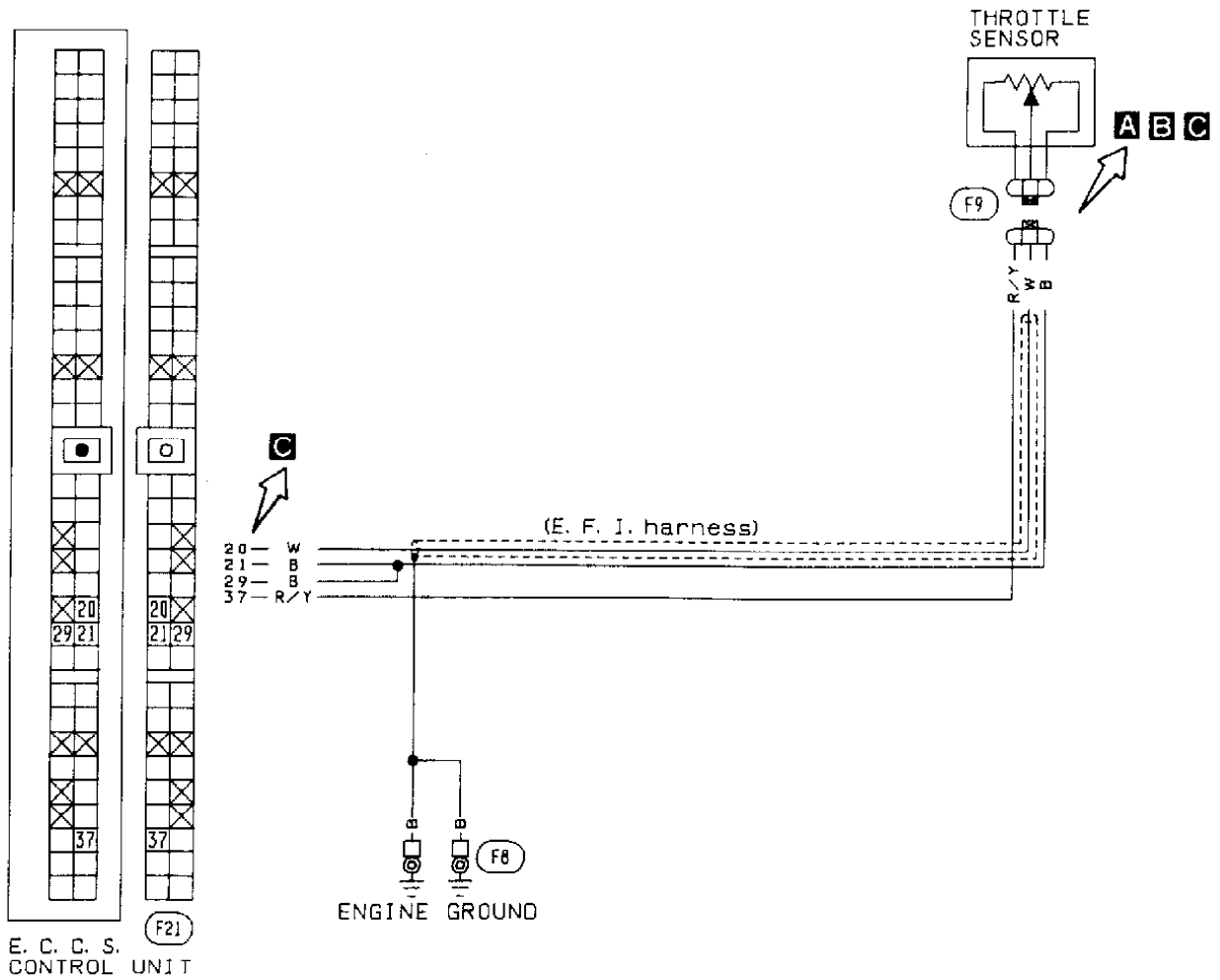

Fig. 24: Code 33 Schematic - Throttle Position Sensor
 Courtesy of Nissan Motor Co., U.S.A.

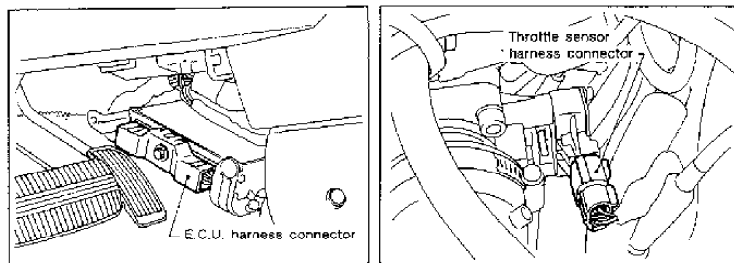
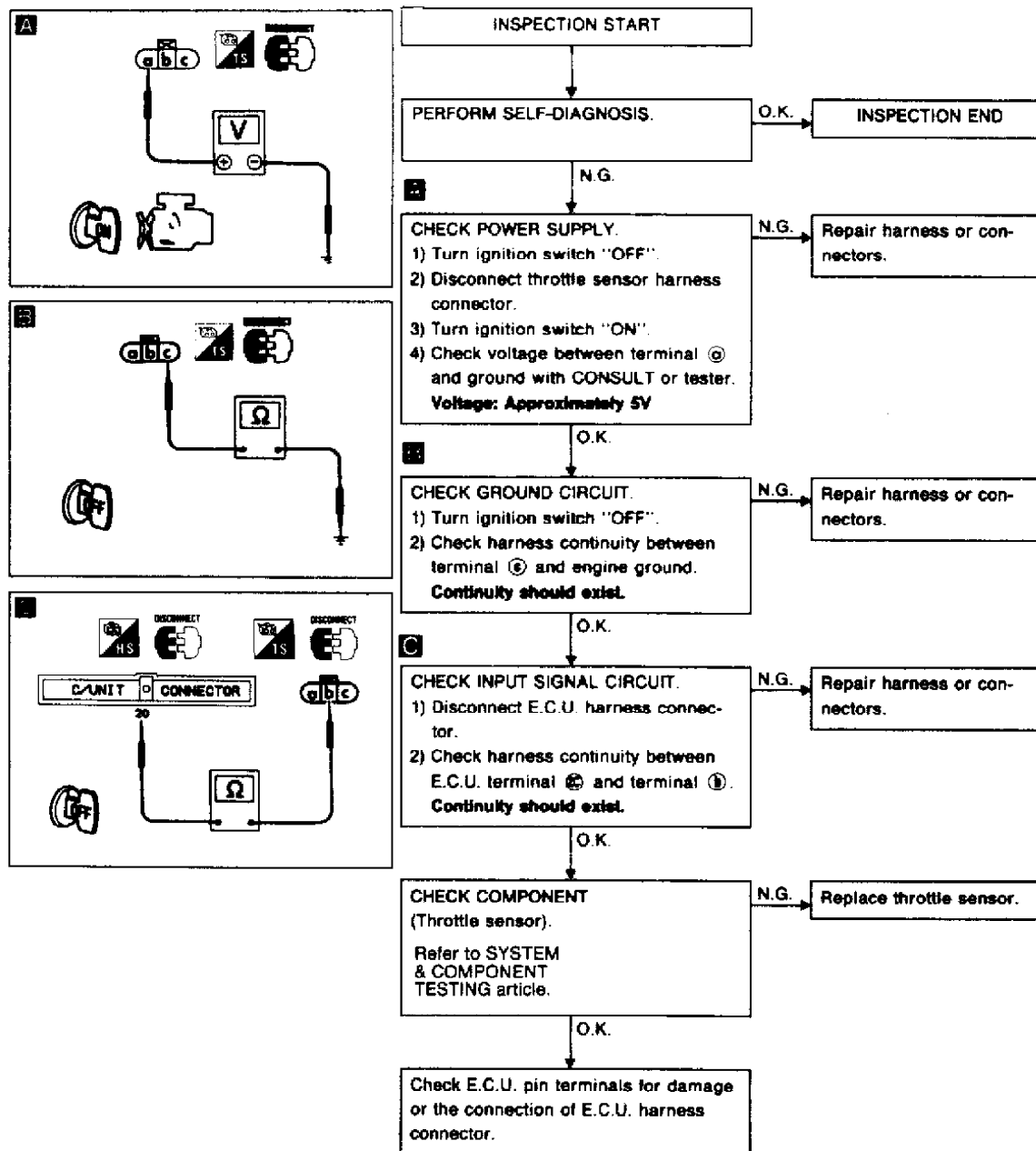

Fig. 25: Code 33 Connector ID - Throttle Position Sensor
 Courtesy of Nissan Motor Co., U.S.A.

CODE 43 THROTTLE POSITION SENSOR (Cont.) G20



WHEN ALL DIAGNOSIS AND REPAIRS ARE COMPLETED, CLEAR CODES AND VERIFY OPERATION.

92D25729

Fig. 26: Code 43 Chart - Throttle Position Sensor
Courtesy of Nissan Motor Co., U.S.A.

CODE 45 - INJECTOR LEAK

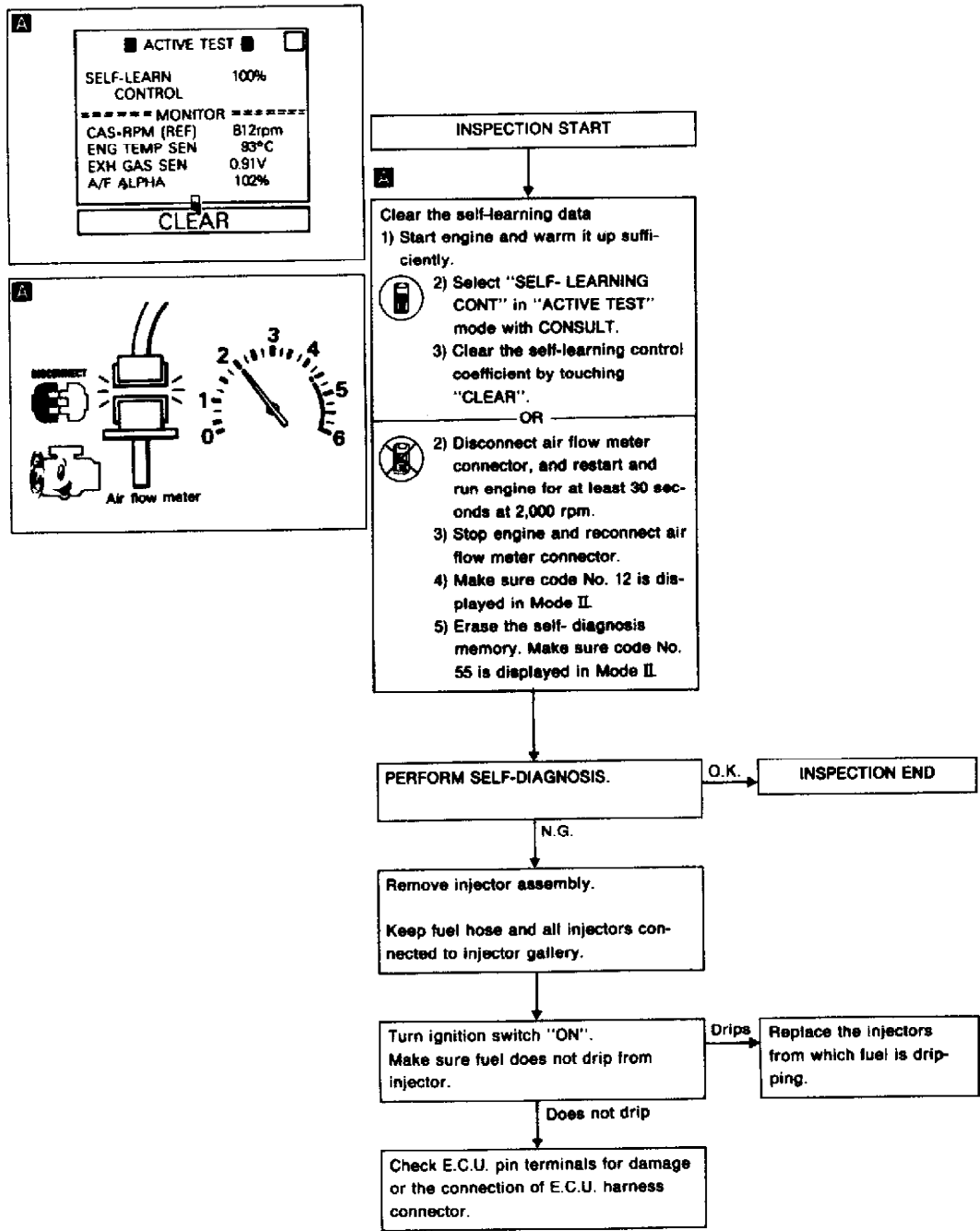

WHEN ALL DIAGNOSIS AND REPAIRS ARE COMPLETED, CLEAR CODES AND VERIFY OPERATION.

92G25730

Fig. 27: Code 45 Chart - Injector Leak
Courtesy of Nissan Motor Co., U.S.A.

SUMMARY

If no hard fault codes (or only pass codes) are present, driveability symptoms exist or intermittent codes exist, proceed to H - TESTS W/O CODES article in the ENGINE PERFORMANCE Section for diagnosis by symptom (i.e., ROUGH IDLE, NO START, etc.) or intermittent diagnostic procedures.