

# PARKING BRAKE AND BRAKE FLUID LEVEL WARNING SYSTEM

WIRING SYSTEM

## 34. Parking Brake and Brake Fluid Level Warning System

### A: SCHEMATIC

BRAKE/W-01

BRAKE/W-01

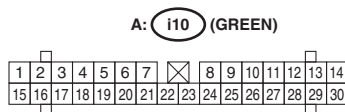
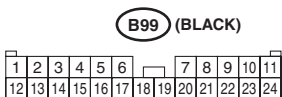
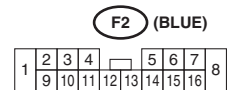
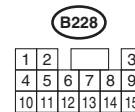
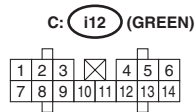
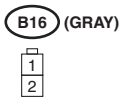
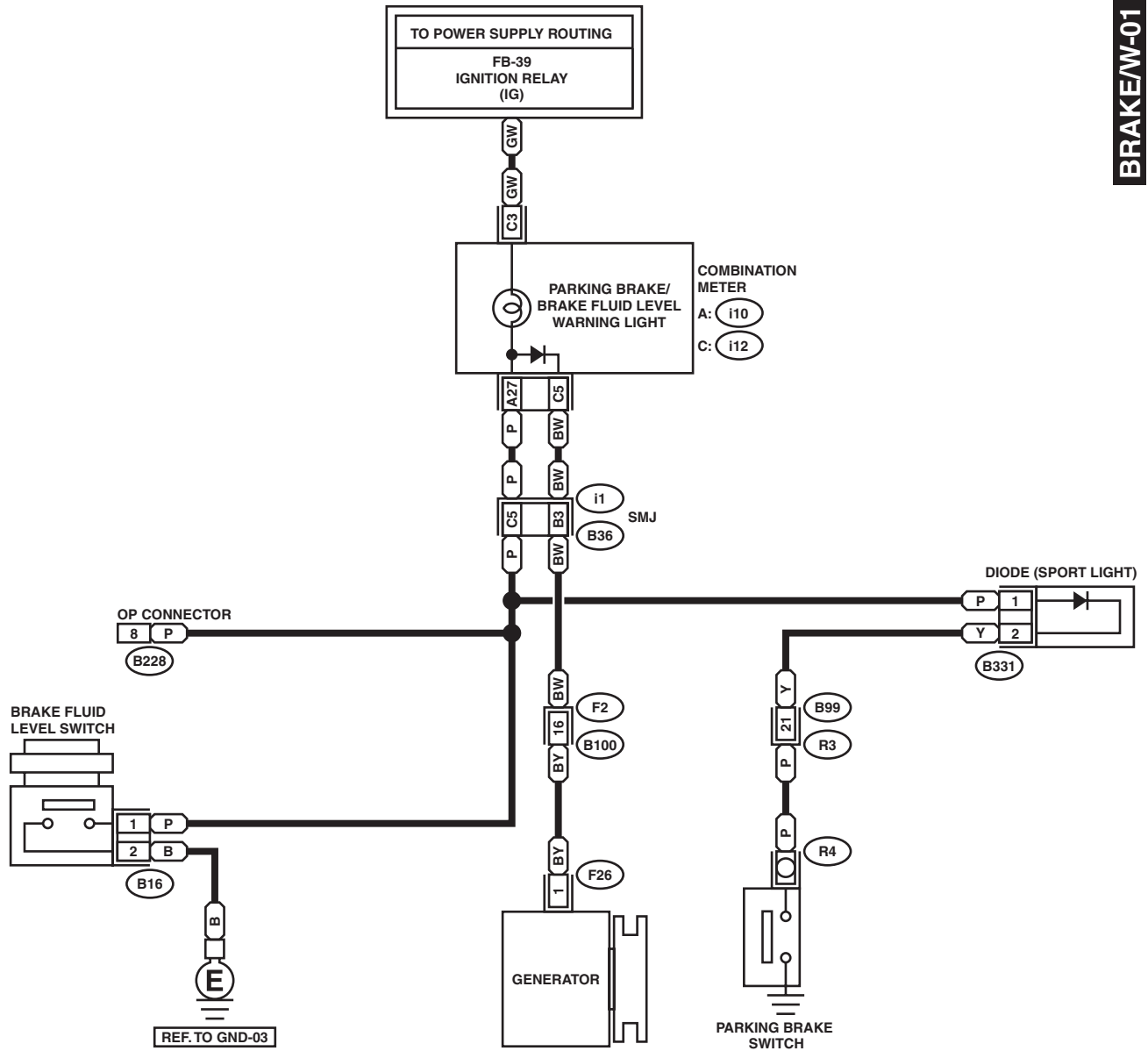

WI-05854