

SEAT BELT WARNING SYSTEM

WIRING SYSTEM

41. Seat Belt Warning System

A: SCHEMATIC

S/BELT-01

S/BELT-01

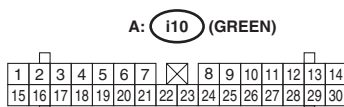
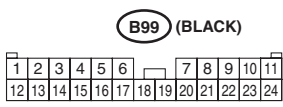
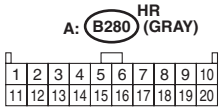
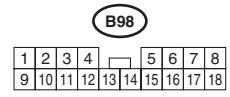
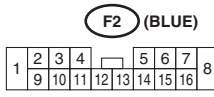
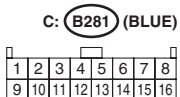
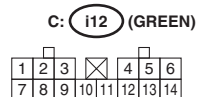
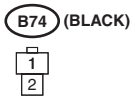
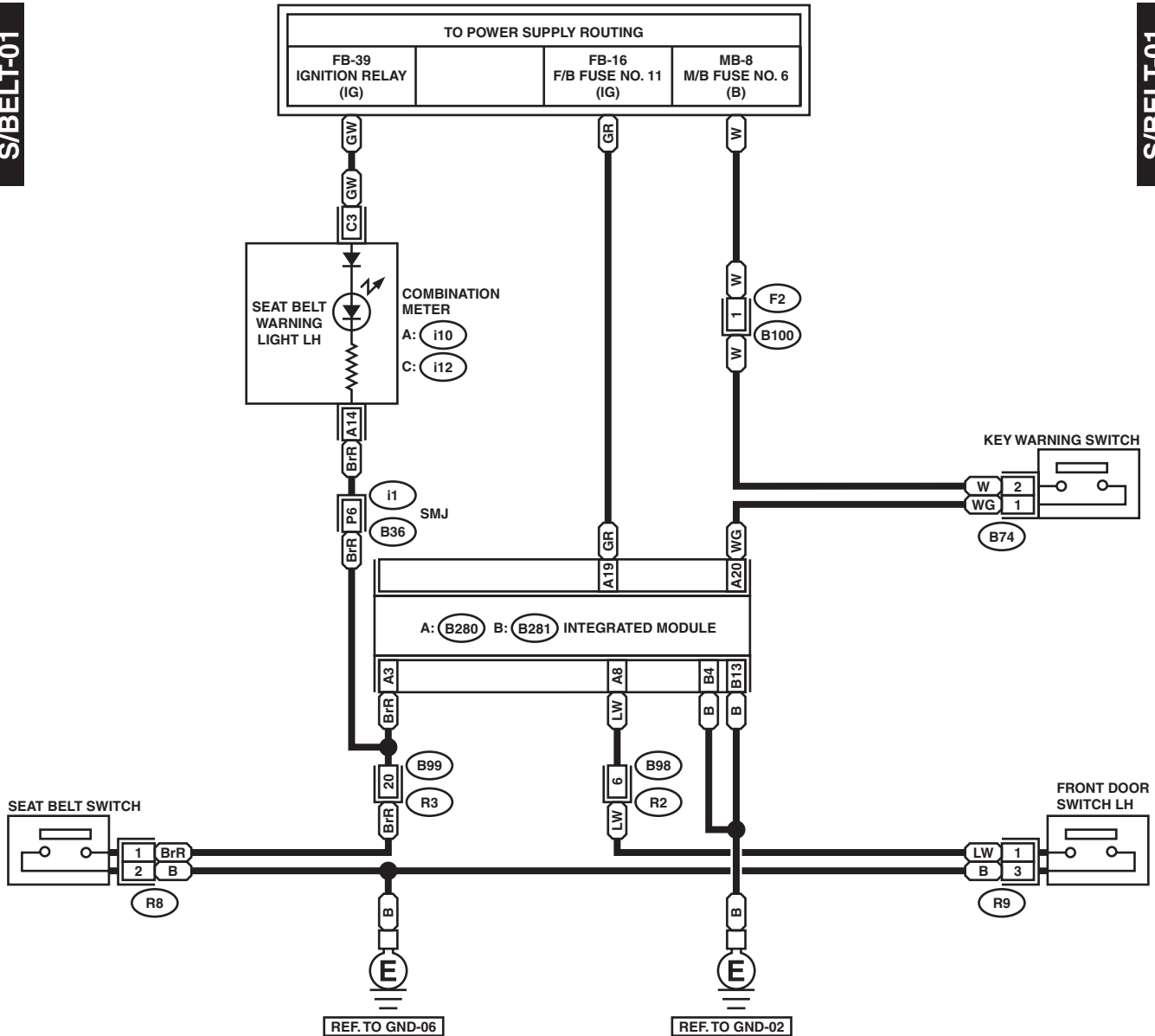

WI-06818