

AT CONTROL SYSTEM

WIRING SYSTEM

9. AT Control System

A: SCHEMATIC

1. NON-TURBO ENGINE MODEL

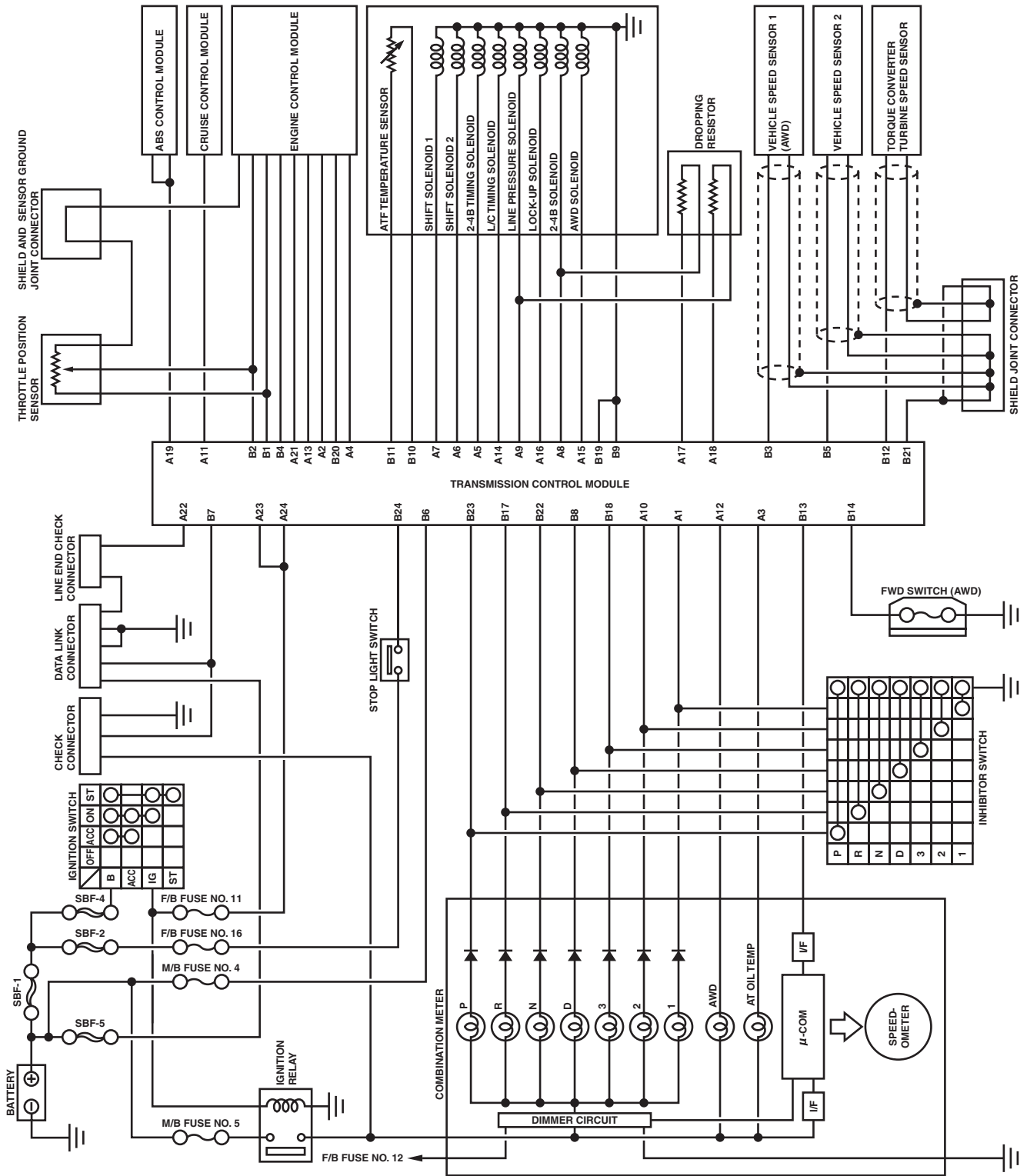

WI-05809

AT CONTROL SYSTEM

WIRING SYSTEM

AT(NA)-01

AT(NA)-01

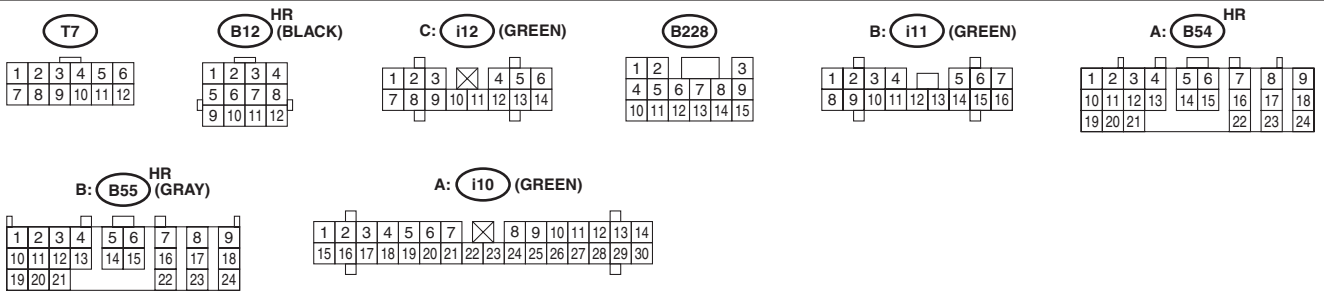
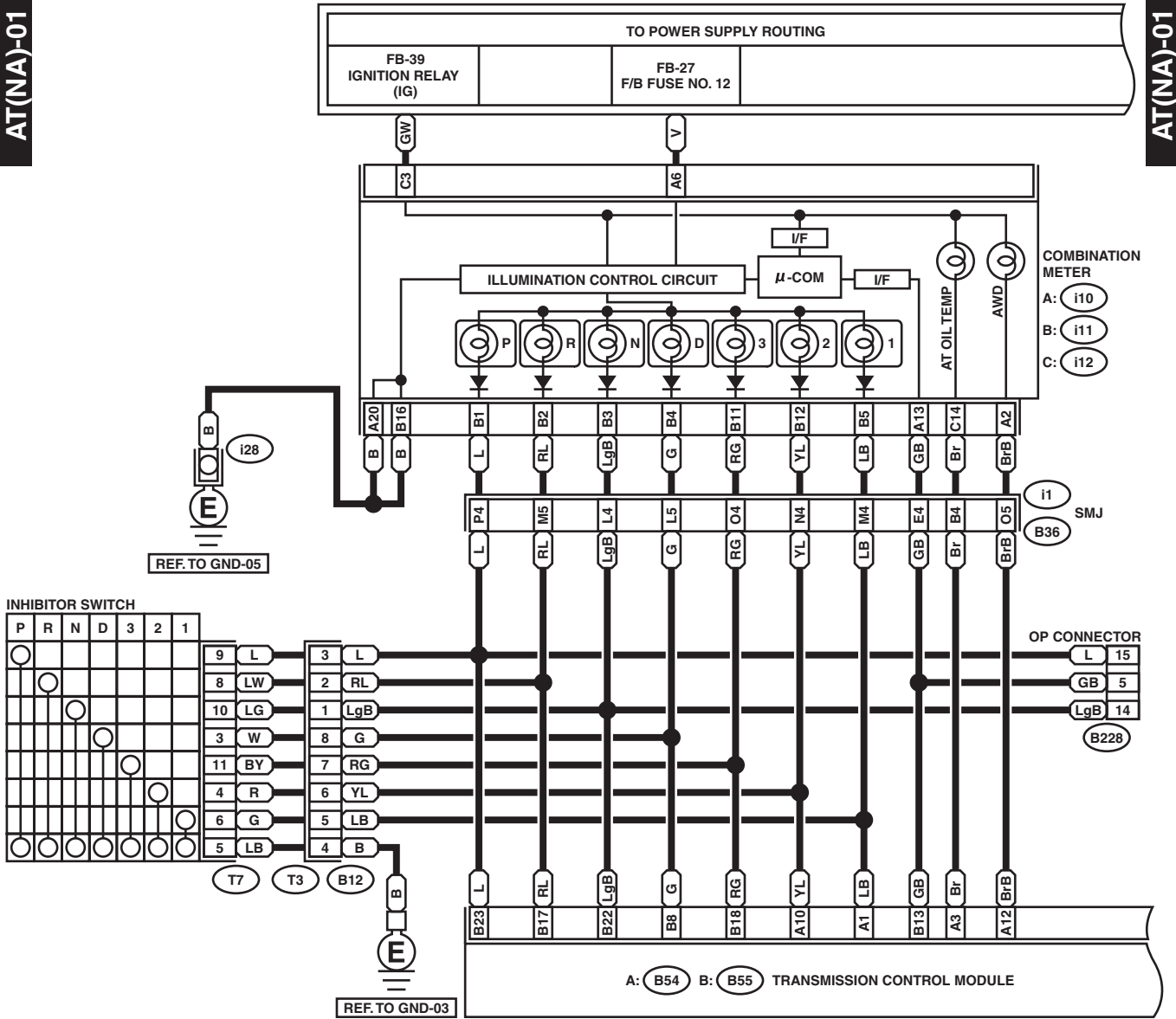

WI-06765

AT CONTROL SYSTEM

WIRING SYSTEM

AT(NA)-02

AT(NA)-02

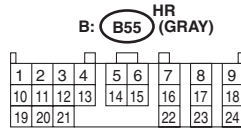
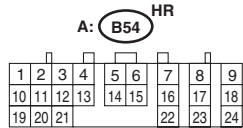
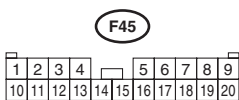
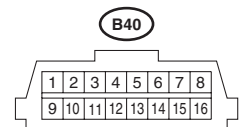
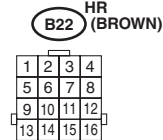
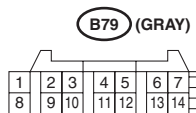
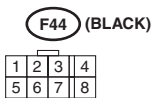
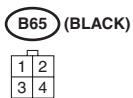
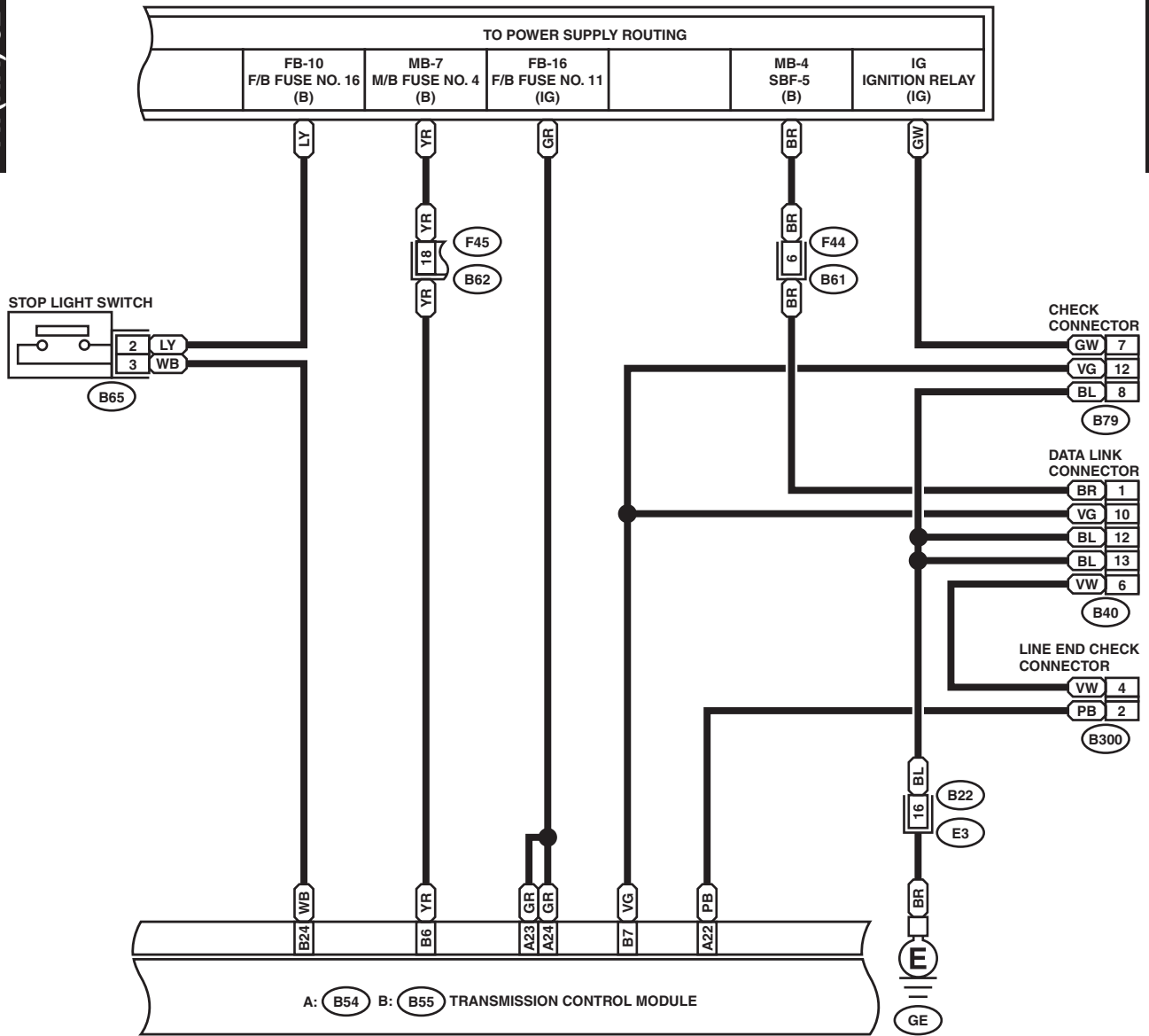

WI-06766

AT CONTROL SYSTEM

WIRING SYSTEM

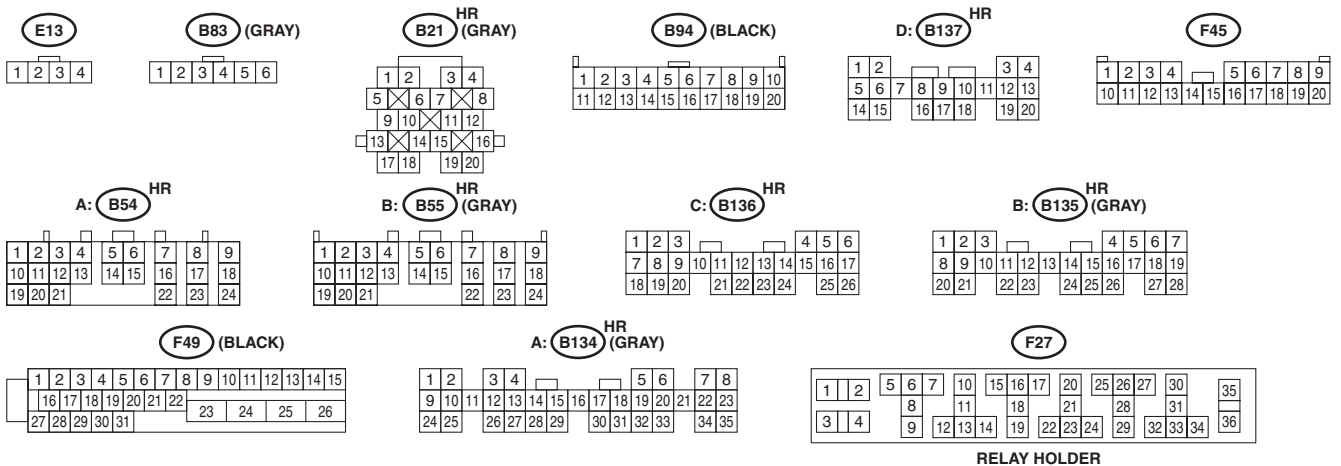
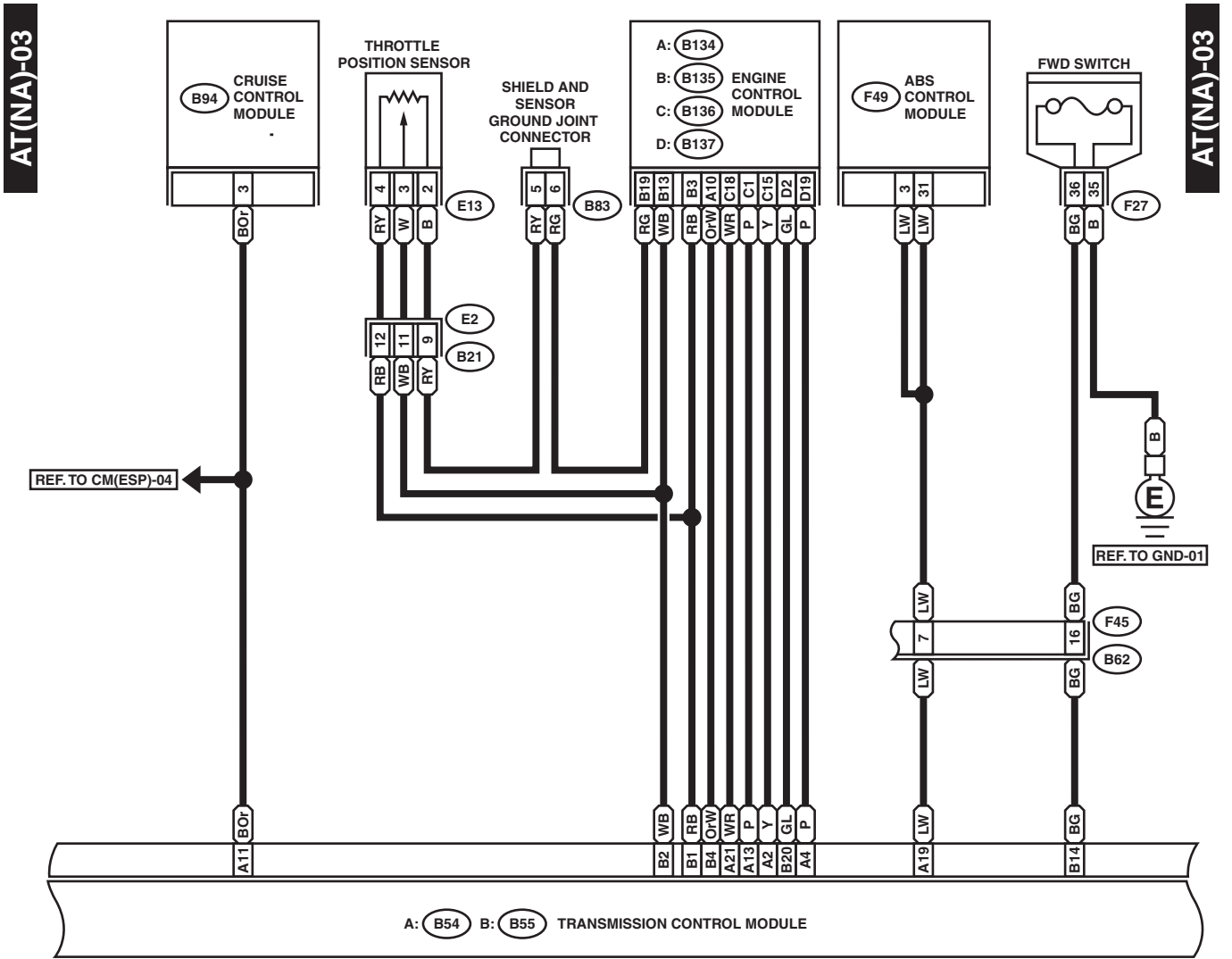

RELAY HOLDER

WI-06767

AT CONTROL SYSTEM

WIRING SYSTEM

AT(NA)-04

AT(NA)-04

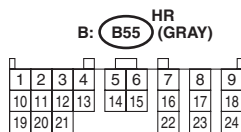
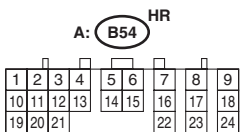
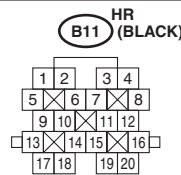
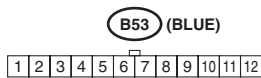
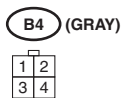
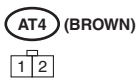
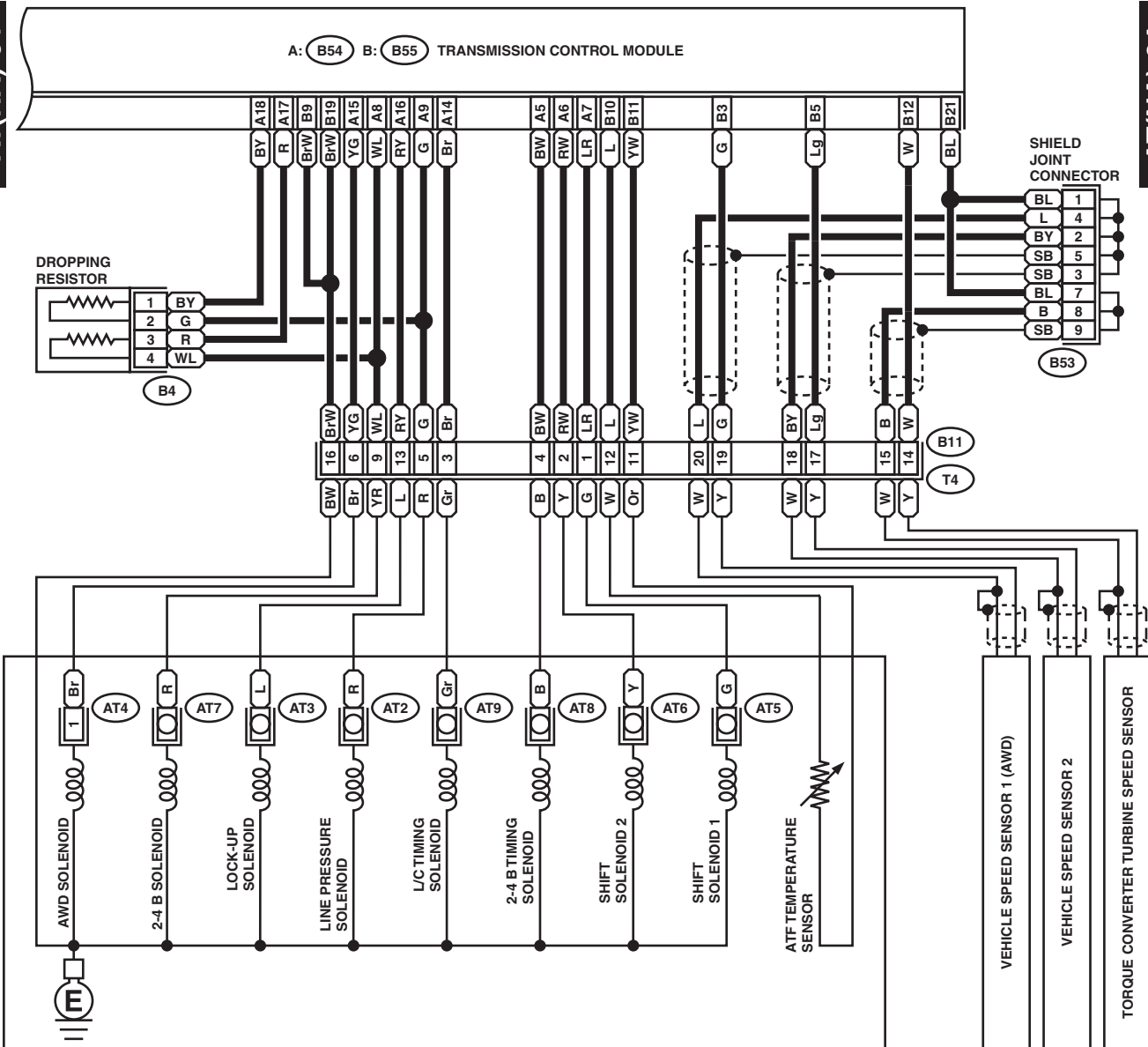

WI-06768

2. TURBO ENGINE MODEL

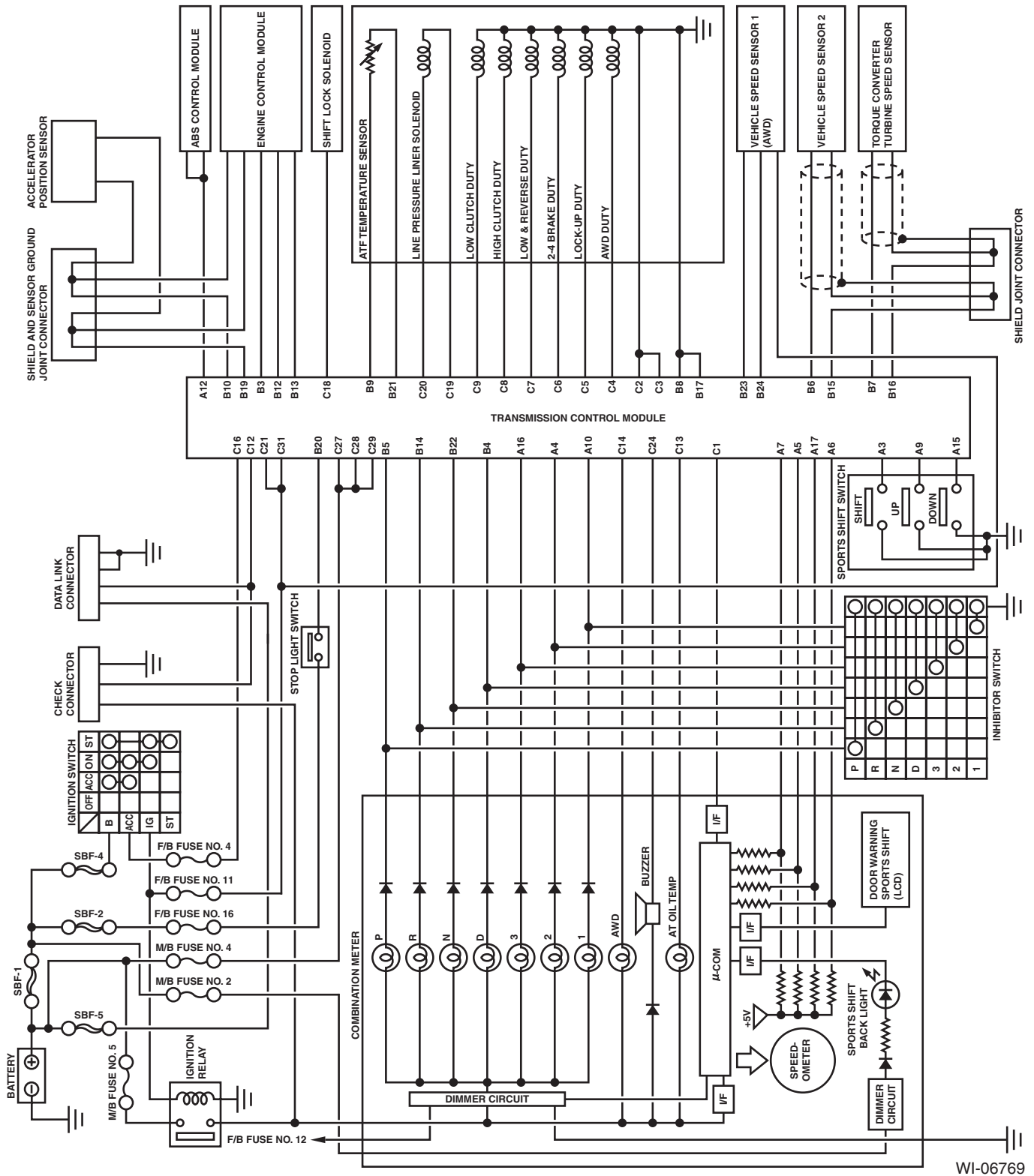

AT CONTROL SYSTEM

WIRING SYSTEM

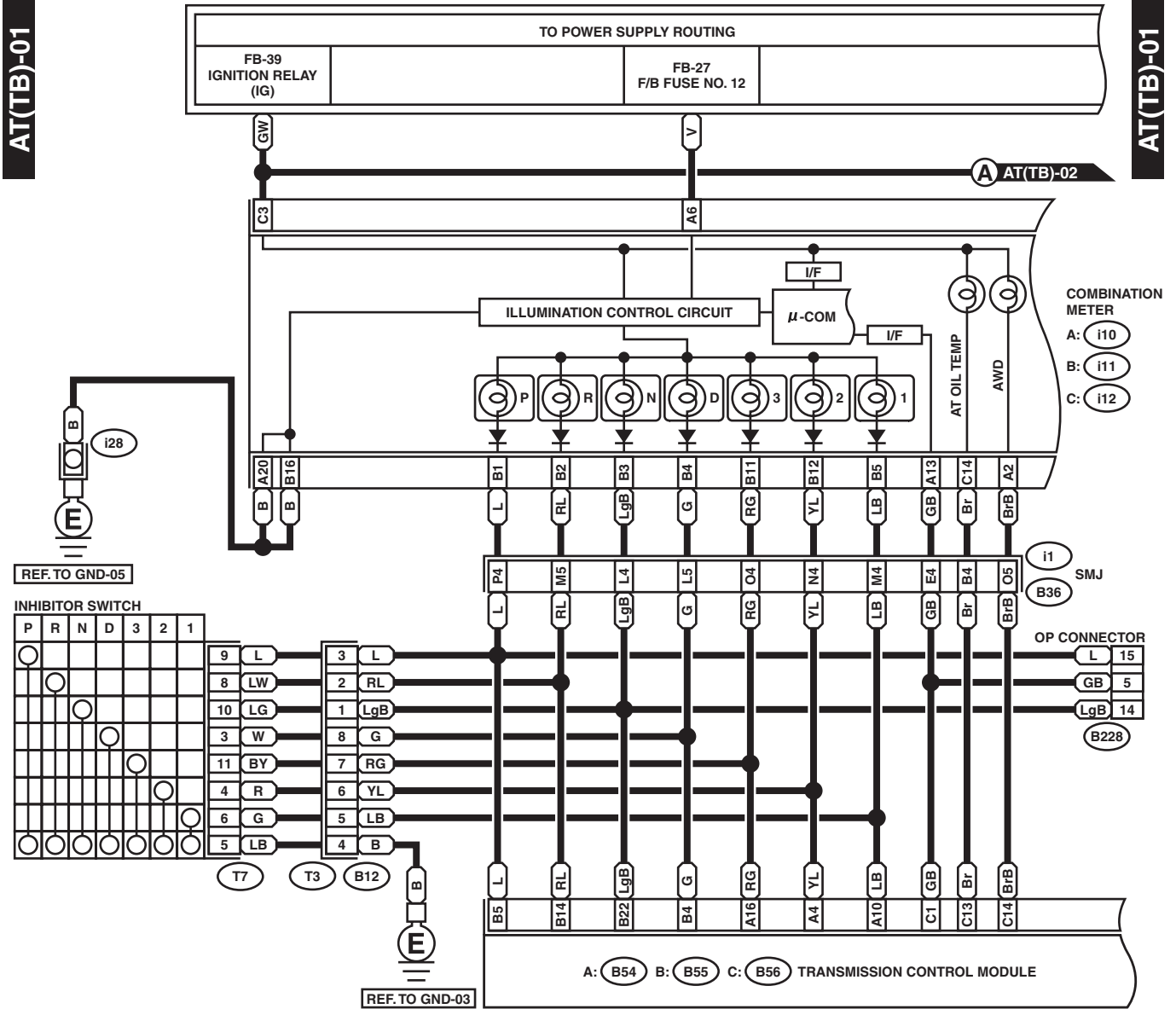
AT(TB)-01
AT(TB)-01

REF. TO GND-05

INHIBITOR SWITCH

P	R	N	D	3	2	1
<input type="checkbox"/>	<input type="checkbox"/>	<input type="checkbox"/>	<input type="checkbox"/>	<input type="checkbox"/>	<input type="checkbox"/>	<input type="checkbox"/>
<input type="checkbox"/>	<input type="checkbox"/>	<input type="checkbox"/>	<input type="checkbox"/>	<input type="checkbox"/>	<input type="checkbox"/>	<input type="checkbox"/>
<input type="checkbox"/>	<input type="checkbox"/>	<input type="checkbox"/>	<input type="checkbox"/>	<input type="checkbox"/>	<input type="checkbox"/>	<input type="checkbox"/>
<input type="checkbox"/>	<input type="checkbox"/>	<input type="checkbox"/>	<input type="checkbox"/>	<input type="checkbox"/>	<input type="checkbox"/>	<input type="checkbox"/>
<input type="checkbox"/>	<input type="checkbox"/>	<input type="checkbox"/>	<input type="checkbox"/>	<input type="checkbox"/>	<input type="checkbox"/>	<input type="checkbox"/>
<input type="checkbox"/>	<input type="checkbox"/>	<input type="checkbox"/>	<input type="checkbox"/>	<input type="checkbox"/>	<input type="checkbox"/>	<input type="checkbox"/>
<input type="checkbox"/>	<input type="checkbox"/>	<input type="checkbox"/>	<input type="checkbox"/>	<input type="checkbox"/>	<input type="checkbox"/>	<input type="checkbox"/>
<input type="checkbox"/>	<input type="checkbox"/>	<input type="checkbox"/>	<input type="checkbox"/>	<input type="checkbox"/>	<input type="checkbox"/>	<input type="checkbox"/>
<input type="checkbox"/>	<input type="checkbox"/>	<input type="checkbox"/>	<input type="checkbox"/>	<input type="checkbox"/>	<input type="checkbox"/>	<input type="checkbox"/>
<input type="checkbox"/>	<input type="checkbox"/>	<input type="checkbox"/>	<input type="checkbox"/>	<input type="checkbox"/>	<input type="checkbox"/>	<input type="checkbox"/>

9	L	3	L
8	LW	2	RL
10	LG	1	LgB
3	W	8	G
11	BY	7	RG
4	R	6	YL
6	G	5	LB
5	LB	4	B

REF. TO GND-03

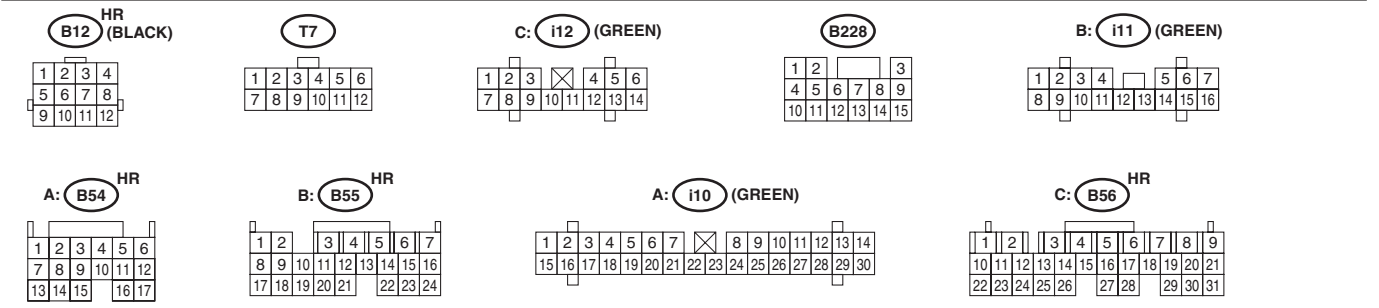

WI-06770

AT CONTROL SYSTEM

WIRING SYSTEM

AT(TB)-02

AT(TB)-02

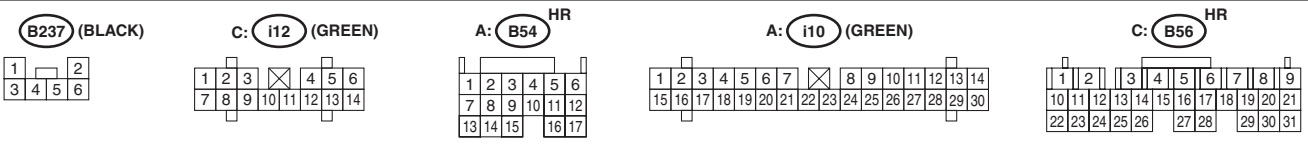
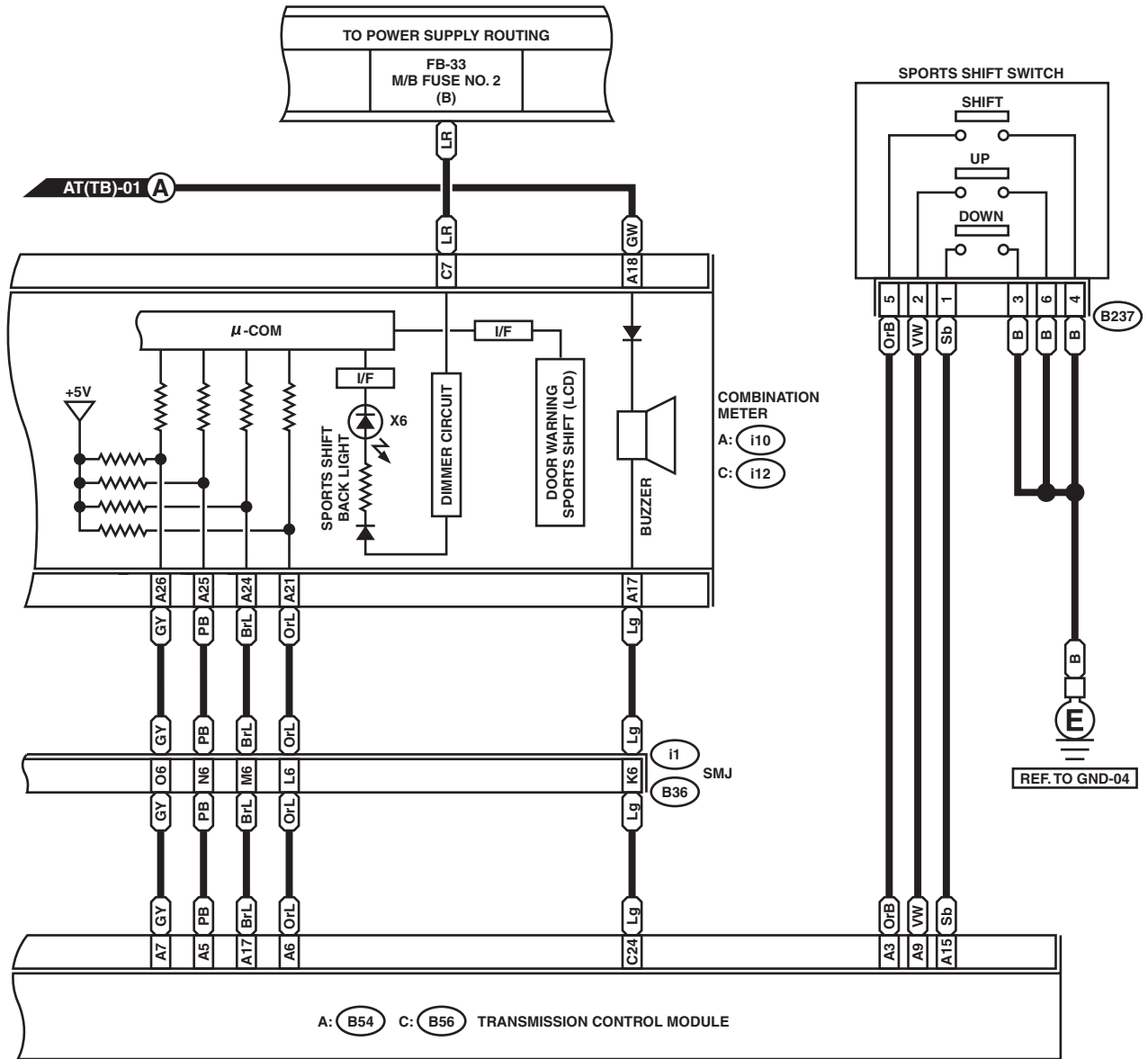

WI-06827

AT CONTROL SYSTEM

WIRING SYSTEM

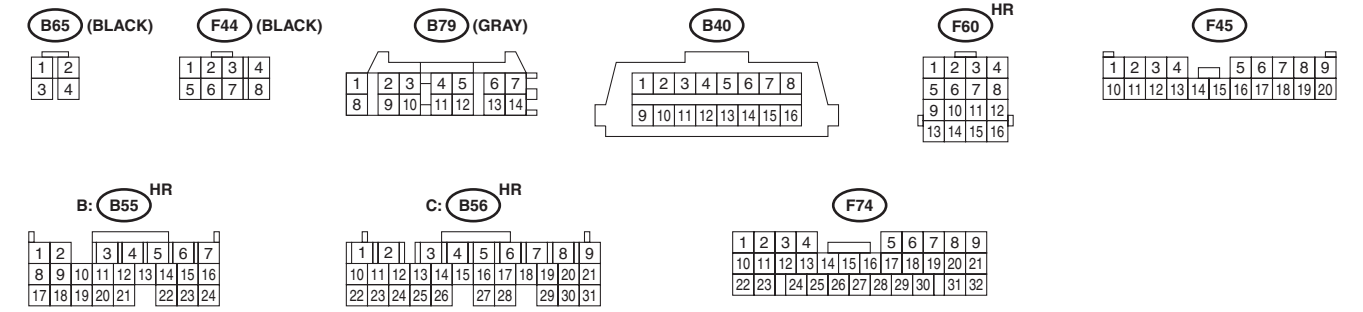
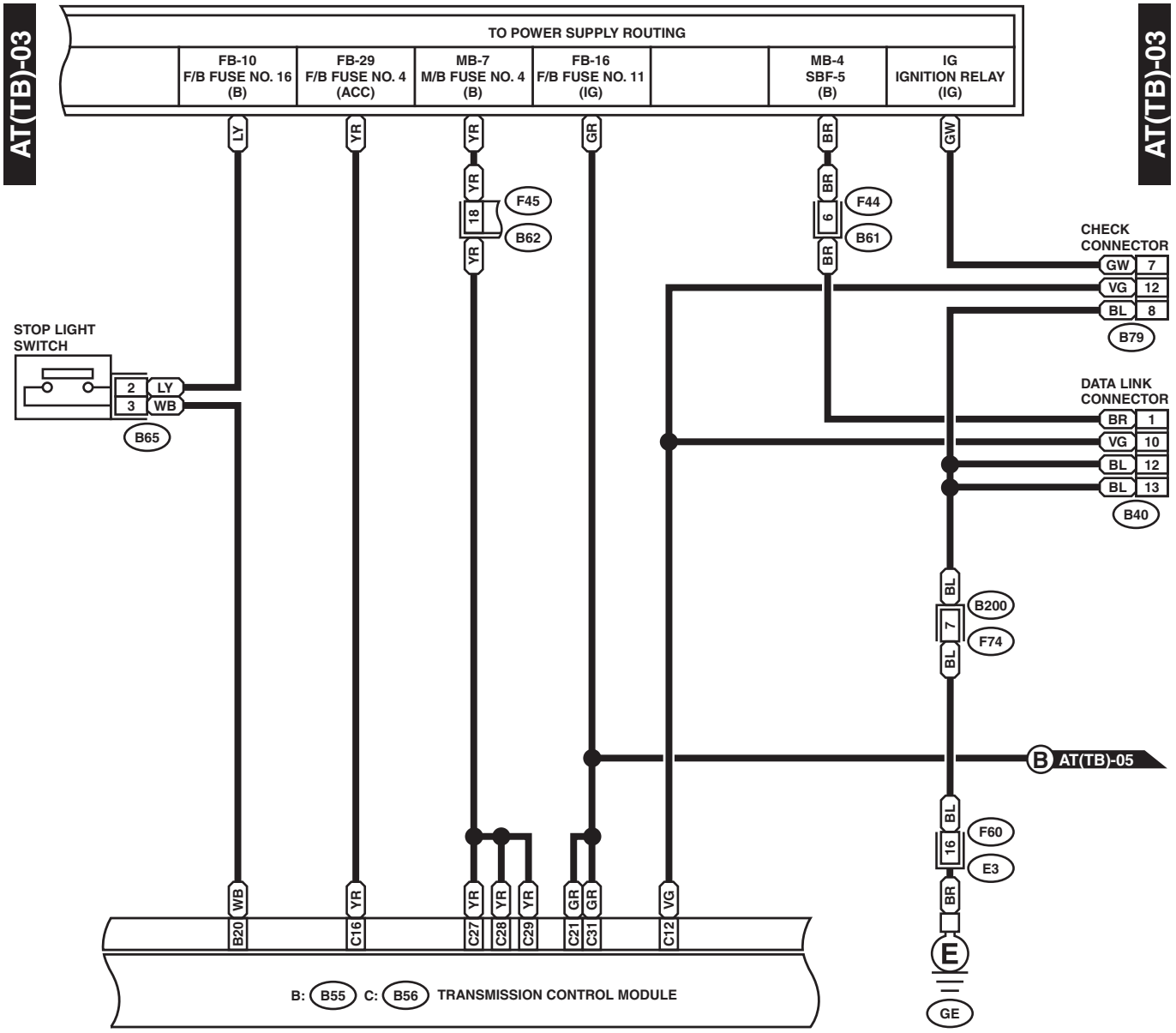

WI-06772

AT CONTROL SYSTEM

WIRING SYSTEM

AT(TB)-04

AT(TB)-04

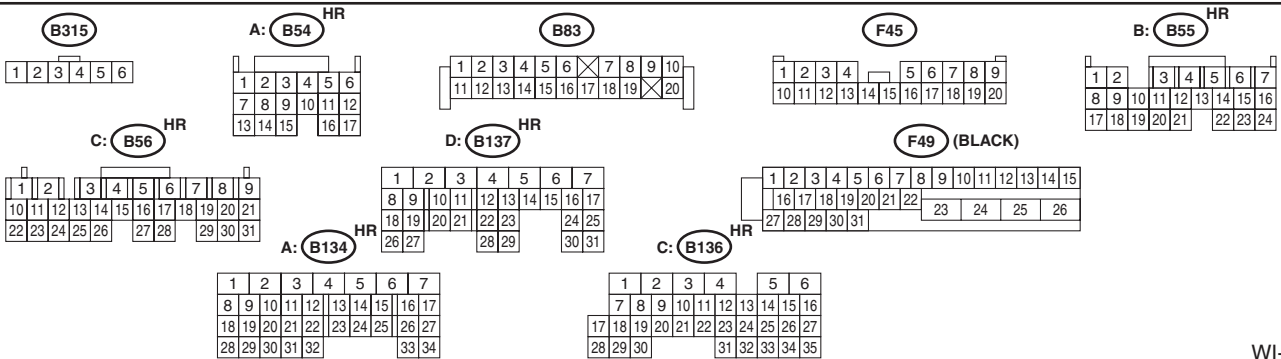
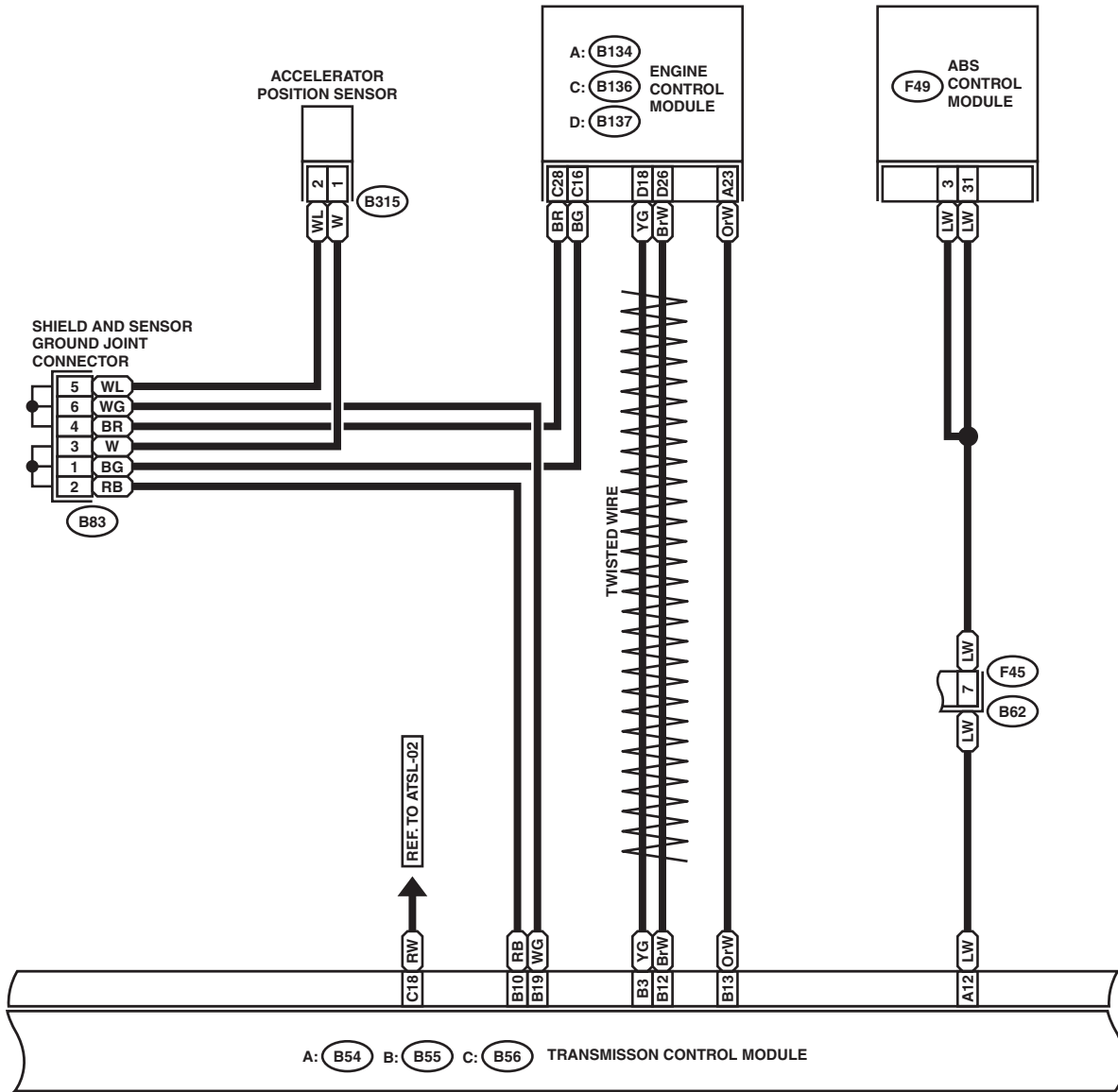

WI-06773

AT CONTROL SYSTEM

WIRING SYSTEM

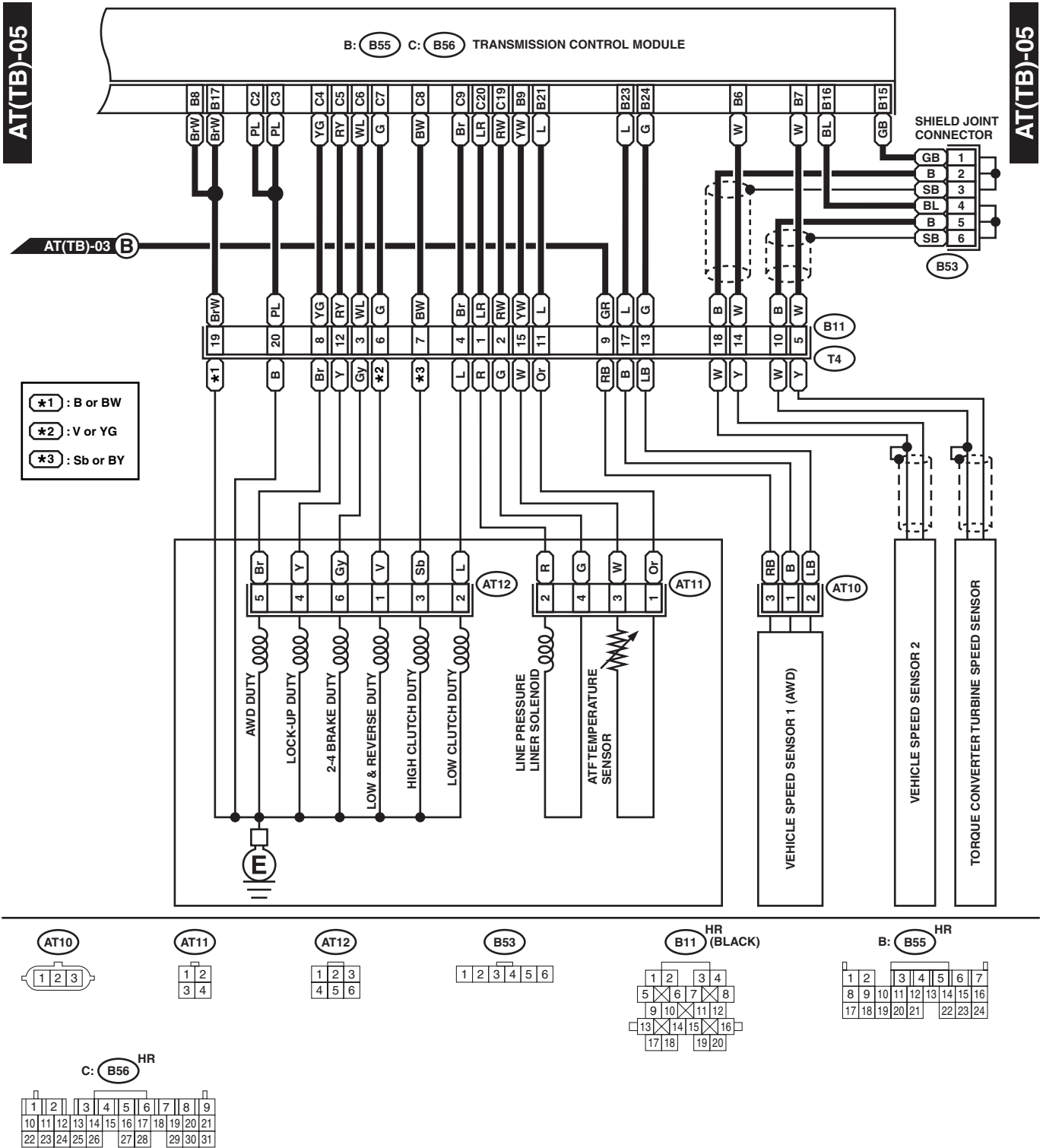

WI-10723

MEMO: