

TO POWER SUPPLY CIRCUIT
 FB-36
 F/B FUSE NO. 14
 (IG)

- ◀ NA : NON-TURBO MODEL
- ◀ TB : TURBO MODEL
- ★1 : 2.0L MODEL : 6
2.5L MODEL : 11
- ★2 : 2.0L MODEL : R
2.5L MODEL : BL
- ★3 : 2.0L MODEL : BP
2.5L MODEL : BY

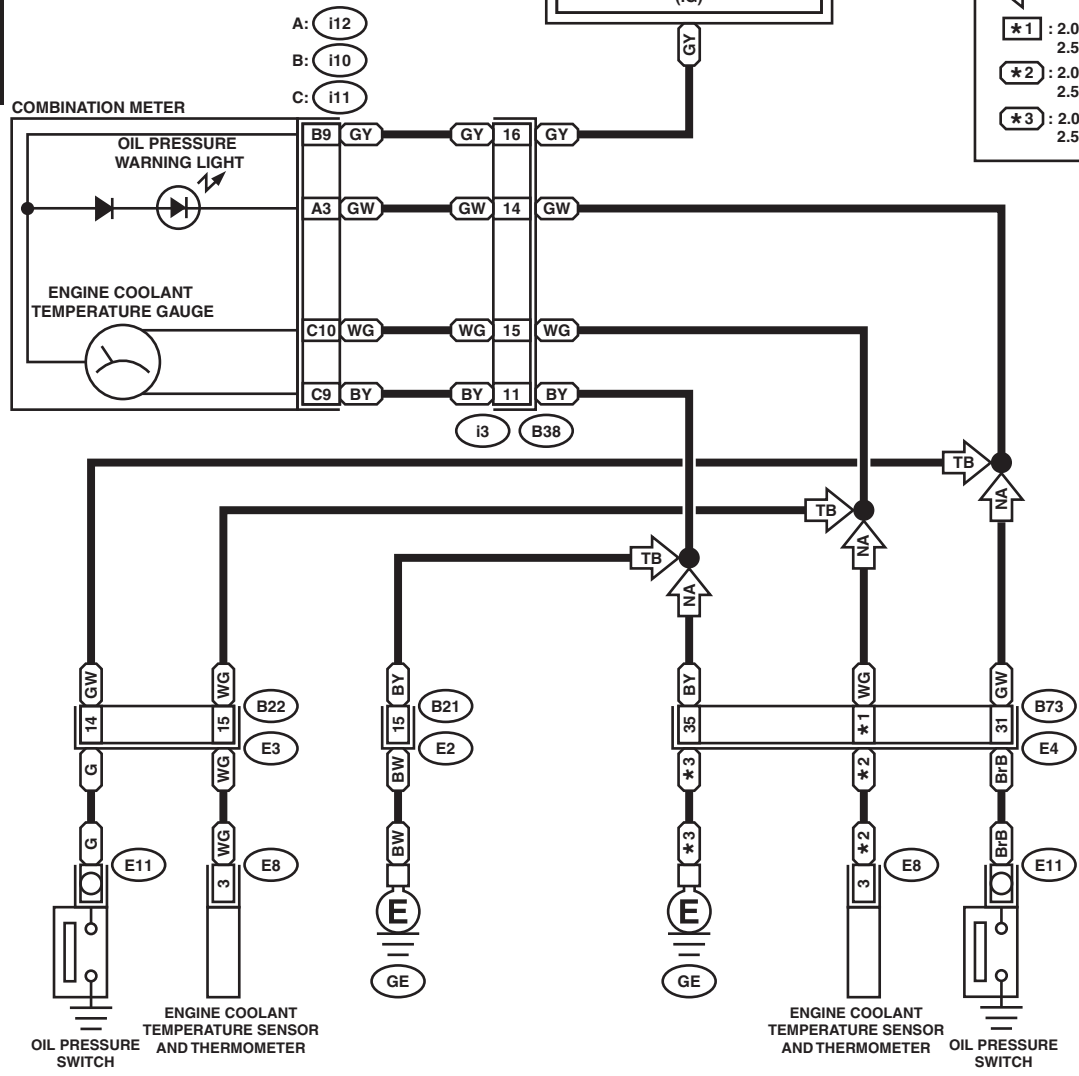

E8 (LIGHT GRAY) C: i11 (GREEN)

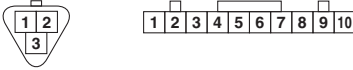

A: i12 (GREEN)

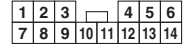

B21 HR (BROWN)

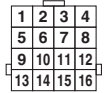

B22 HR (BLACK)

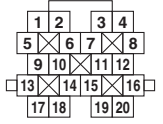

B: i10 (GREEN)

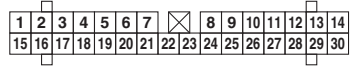

i3

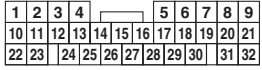

B73 (BLACK)

