



Technicians Reference Booklet

Supplemental Restraint System (SRS)

Module 602-SRS

MSA5P0136C

Technical Training

© Copyright 2001

Subaru of America, Inc.

All rights reserved. This book may not be reproduced in whole or in part without the express permission of Subaru of America, Inc.

Subaru of America, Inc. reserves the right at any time to make changes or modifications to systems, procedures, descriptions, and illustrations contained in this book without necessarily updating this document. Information contained herein is considered current as of March 2001.

Table of Contents

SRS Supplemental Restraint System (1992 SVX) -----	4
SRS System Precautions -----	4
Component Overview -----	5
Component Operation -----	7
Roll Connector Phasing -----	8
Connector Double Lock Sensors -----	9
Air Bag Module -----	10
Inflator Igniter -----	11
Air Bag -----	11
Air Bag Warning Lamps -----	11
Air Bag Deployment -----	12
Diagnostics and Servicing -----	12
SRS System Servicing -----	13
1995 Model Legacy -----	14
1996 Model Legacy and Outback -----	14
1998 Model Forester -----	15
2000 Model Legacy and Outback -----	17
2001 Model Legacy -----	19
2002 Model Impreza WRX -----	20

Supplemental Restraint System (SRS)

SRS SUPPLEMENTAL RESTRAINT SYSTEM

SVX System Overview

The SRS Air Bag System is a safety device designed to function in conjunction with a knee bolster, seat belts and shoulder belts. Similar to other manufacturers, it deploys in frontal collisions only. It is an electrically operated system which uses a chemical deployment device.



The SRS System features built-in Self Diagnostics and a redundant Safety Design with back-ups built into all of the circuits.

The system safeguards include double locking connectors with diagnostic sensors, a self-shorting inflator SRS air bag module connector to prevent accidental deployment during servicing, and a steering roll connector. A capacitor supplies back-up power.

Finally, for redundancy, there are two front inertia sensors and two safing sensor circuits.

NOTE: THE SRS AIR BAG SYSTEM IS THOROUGHLY DESIGNED TO PREVENT ACCIDENTAL DEPLOYMENT, HOWEVER, CAUTION SHOULD ALWAYS BE USED WHEN SERVICING OR DIAGNOSING THE SYSTEM. THE SRS SYSTEM, WHEN HANDLED PROPERLY, IS LESS HAZARDOUS TO SERVICE THAN A CAR BATTERY OR FUEL SYSTEM.

SRS SYSTEM PRECAUTIONS

1. Whenever serving the SRS System disconnect the battery and wait at least 10 minutes before proceeding.
2. Always store the SRS Air Bag Module (steering wheel pad) facing up.
3. All of the SRS components are sealed - DO NOT DISASSEMBLE.
4. All of the SRS wiring is enclosed in a yellow housing for quick identification. Use care whenever working near a yellow housing. These wires may not be repaired if they are damaged. They MUST be replaced.
5. Do not drop any of the components. This could alter their sensitivity.
6. The SRS Module must avoid extreme heat exposure (200 degrees F. or greater).

NOTE: EXPOSURE TO TEMPERATURES OF 300 DEGREES F. OR GREATER WILL CAUSE DEPLOYMENT.

7. Wear protective clothing when handling deployed air bag components. Always use gloves and eye protection. Although the residue is NOT toxic, it may cause minor eye and skin irritation.
8. Never place yourself or test equipment between the Air Bag Module and seat when servicing the air bag system.

NOTE: REVIEW ALL CAUTIONS OUTLINED IN THE SERVICE MANUAL REGARDING SKIN AND EYE EXPOSURE TO DEPLOYED AIR BAG RESIDUES.

Supplemental Restraint System (SRS)

COMPONENT OVERVIEW

The Air Bag and Inflator Module is attached to the steering wheel and covered by the steering wheel pad. It contains the deployment module, air bag and cover pad.

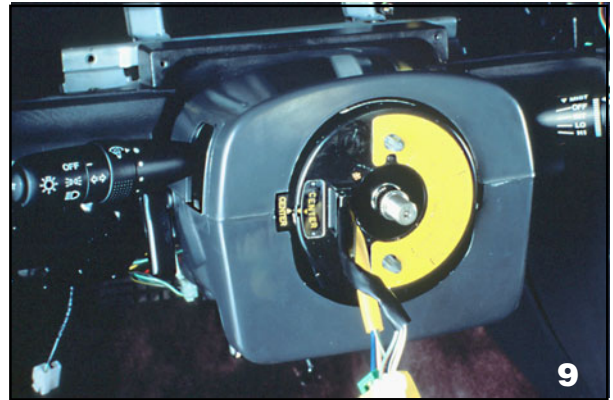

All SRS connectors are equipped with double locks and sensors. The sensors are used to indicate that the connector is not double-locked. For identification purposes, they are green in color.

There are two (2) front sensors located inside the front fenders behind each inner fender liner. In addition, there are two Safeing sensors located inside the ECU.

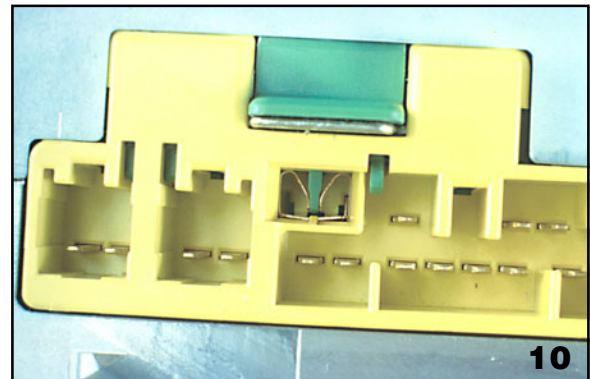
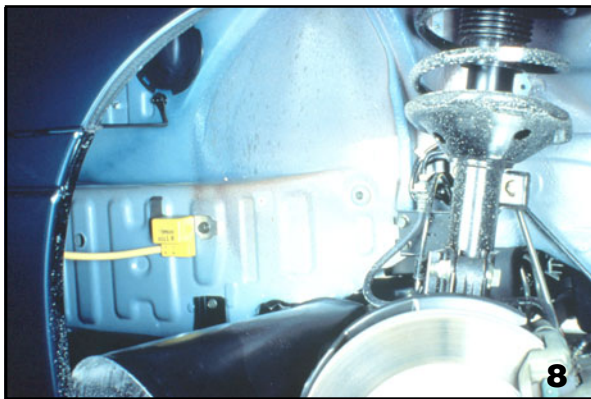

The ECU is located under the center console. It receives sensor input signals in the event of a frontal impact. It then sends a signal to trigger air bag deployment. The ECU features a self-diagnostic capability incorporating long term memory.

The steering roll connector is mounted between the steering wheel and the combination switch. It is an integral part of the combination switch assembly. The design of this assembly allows for steering wheel rotation. It also provides the hard wire connection between the air bag module and the SRS system harness.

Supplemental Restraint System (SRS)

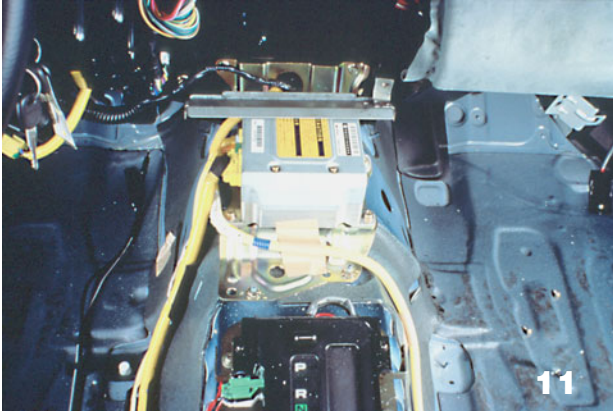

The ECU sends a continuous low voltage signal to monitor the sensors, the harness, the deployment module and to check for connector integrity.

There are two (2) air bag warning lamps located in the combination meter. For safety purposes, there are also two (2) independent drive circuits. Both lights and circuits illuminate only one light position in the combination meter.

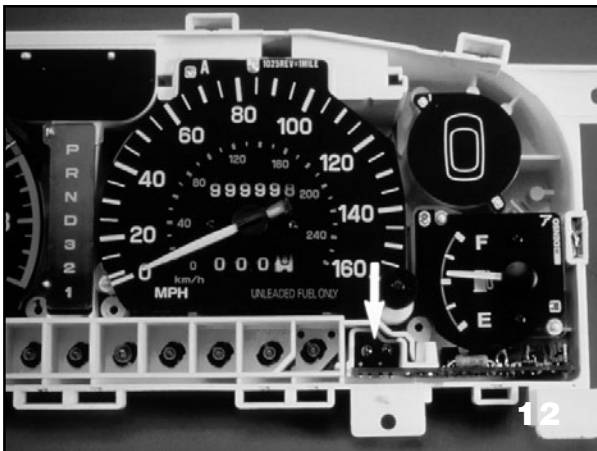

Supplemental Restraint System (SRS)

COMPONENT OPERATION

The ECU controls the SRS Air Bag System by constantly monitoring the input signals from the front sensors, the safing sensors and the double lock circuit. It also generates output signals to the warning lamps and to the inflator module.

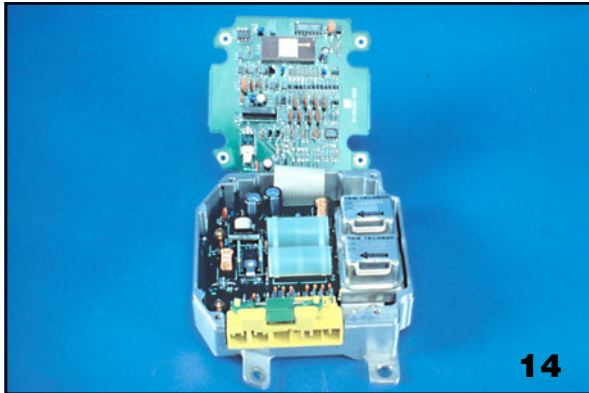

Among other things, the ECU contains two safing sensors which provide input signals, and two capacitors which supplement low battery voltage.

The capacitors also provide back-up voltage in the event of a total loss of battery voltage. They are triggered by an internal voltage regulator.

NOTE: THE CAPACITORS CAN ACTIVATE THE SRS AIR BAG UP TO 10 MINUTES AFTER A TOTAL LOSS OF BATTERY VOLTAGE. THE REGULATOR MONITORS BATTERY VOLTAGE AND CAN SUPPLEMENT BATTERY VOLTAGE AS NEEDED IN THE EVENT OF A COLLISION.



Redundancy is provided by the front left hand and right hand sensors. The hollow roller design provides a movable mass. The roller is mounted on a flat surface and held in place by a flat roller spring. The roller spring allows forward roller movement during frontal impacts of 12.5 MPH or greater. In this case, the roller and spring assembly makes contact with the circuit terminal.

When the roller makes contact with the circuit terminal, it sends a collision signal to the ECU. This completes the sensor circuit and provides a ground circuit to the inflator.

The metal housing of the front sensors are surrounded by resin and filled with inert gas to prevent moisture damage.

CAUTION: DO NOT OPEN THE SENSOR HOUSING. THE INTERNAL COMPONENTS ARE NOT SERVICEABLE.

The continuous sensor harness is molded directly into the sensor body. The harness has only one sensor connector, which is located at the ECU. This provides a one-piece circuit path to the ECU. A damaged harness or sensor must be replaced as an assembly.

Supplemental Restraint System (SRS)

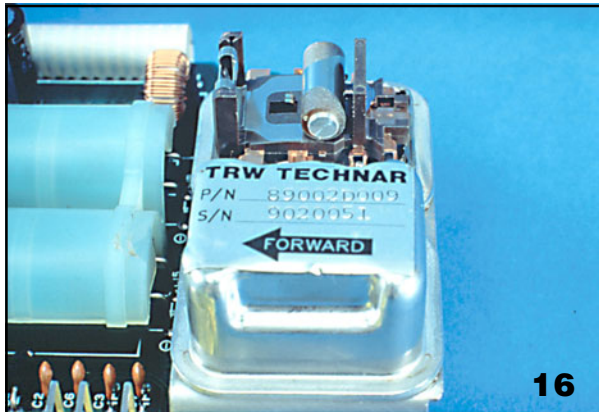

Two safeing sensors located inside the ECU provide redundancy and safety. They operate similar to the front sensors in that they provide a B+ circuit to the inflator. Although they are similar in construction and operation to the front sensors, the safeing sensors are more sensitive.

Weight added to the center of the roller makes it heavier, which in turn, makes the sensor more sensitive to impact. The ECU must be replaced if one of the safeing sensors fail.

The steering roll connector is a continuous flat ribbon-type cable. The cable coils around the hub which allows 2.65 turns (either direction) from the center steering position. This provides a direct hard wire connection between the SRS air bag module and the ECU harness. It also includes the horn circuit. This eliminates the potential circuit interruption inherent to sliding contact-type connectors, which also prevents false trouble codes.



Two guide pins are used to align the roll connector with the steering wheel.

ROLL CONNECTOR PHASING

The roll connector MUST be phased to the steering system. With the front wheels centered, align the inner "center" indicator located behind the window in the roll connector, with the "center" indicator located on the rotating cover next to the window. There is also an alignment arrow on the connector case.

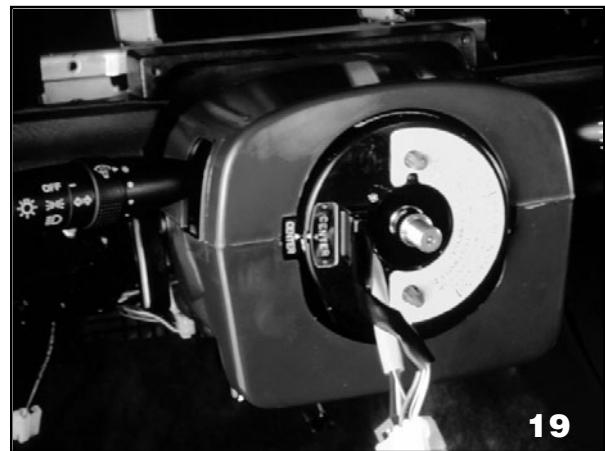

If the inner indicator shows "1R" in the window, rotate the cover one full rotation to the right. If the inner indicator shows "2R" in the window, rotate the cover two full rotations to the right.

Supplemental Restraint System (SRS)

Similarly, if the indicator shows either "1L" or "2L", rotate the cover one or two left hand rotations.

NOTE: TO MAINTAIN PROPER STEERING WHEEL ALIGNMENT, CENTER THE FRONT WHEELS AND SCRIBE AN ALIGNMENT MARK BETWEEN THE STEERING WHEEL HUB AND THE SHAFT, PRIOR TO DISASSEMBLY.

CONNECTOR DOUBLE LOCK SENSORS

Double lock sensor mechanisms are identified by a green color. They are used on all SRS electrical connectors. The system uses four (4) double lock sensors between:

1. The system power supply and the warning light (Connector B58 to AB1)
2. The main ECU connection #1 (Connectors AB4, 5, & 6 to ECU)
3. The ECU harness and the roll connector # at the combination switch (Connector AB2 to AB7)
4. The roll connector and the air bag module #3 located behind the steering wheel pad (Connector AB7 to AB8)

These sensors connect the double lock detecting circuit to the negative side of the igniter circuit. This provides a ground signal circuit for the warning light system.

If any green double-lock lever is not properly latched, the SRS warning lamp will be illuminated and a Trouble Code will be displayed (Code 14).

The double lock (#1) at the ECU secures the main harness connector as well as the two front sensor harness connectors.

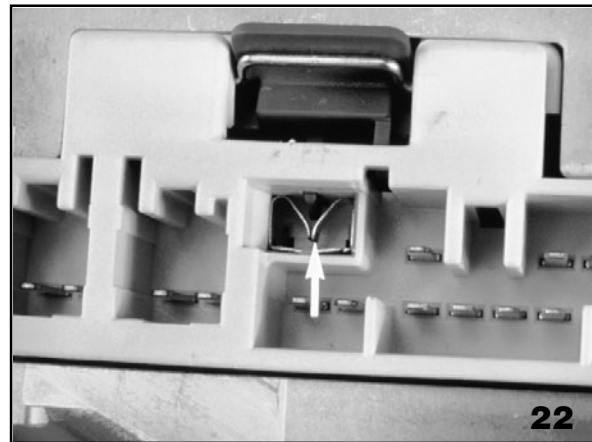

Double lock sensor terminals make contact when they are unlocked and they separate when they are locked. The green tabs mechanically prevent the connector from being removed. The double lock will not latch unless the connectors are completely inserted.

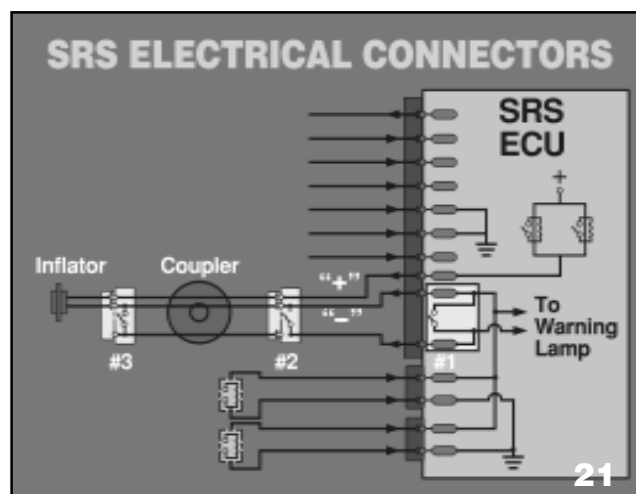

Supplemental Restraint System (SRS)

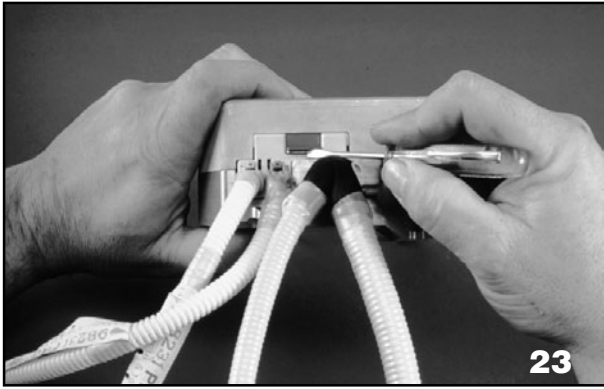

In order to release double lock #1, use a small screw driver. Press in on the metal loop and simultaneously raise the green latch. Then to remove the individual connectors, press down on the primary connector locks.

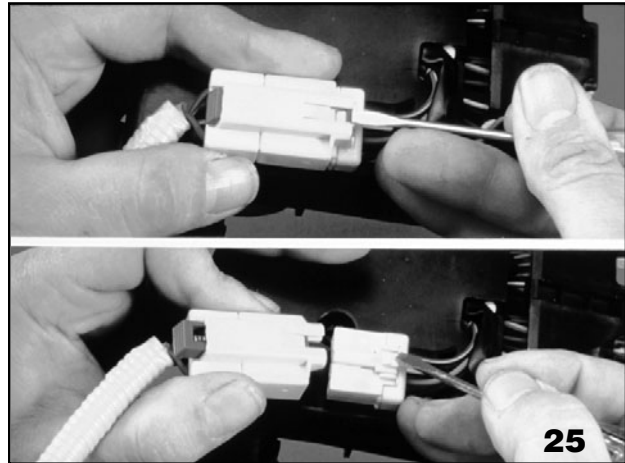

The procedure for locks #2 and #3 are similar to sensor #1 except that they are released at the primary lock in two steps. First, press down once on the spring-loaded green latch and it will pop out. Then press it down a second time in order to remove the connector. To secure the double lock, push in the green latch until a click is heard.

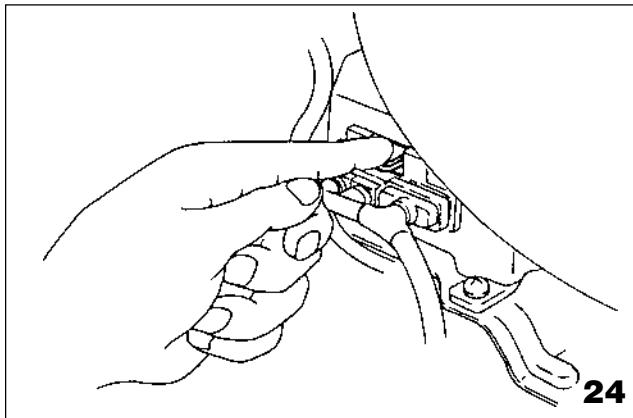

Secure the double lock by pressing the green latch down until a click is heard.

AIR BAG MODULE

The air bag module comes as a one piece assembly with the horn buttons. It is mounted to the steering wheel with four #30 tamper-proof torx bolts.

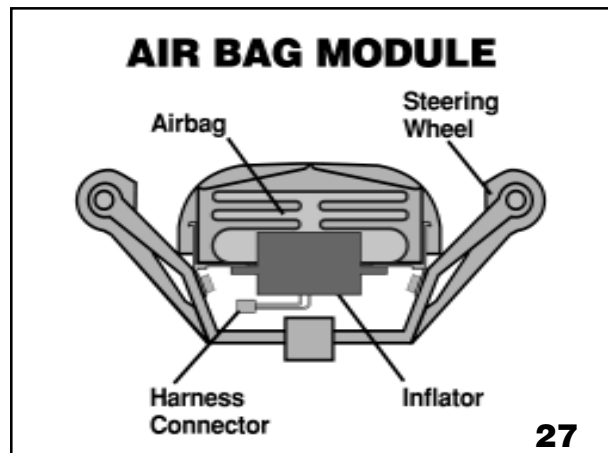

Supplemental Restraint System (SRS)

The air bag module consists of three sub-components:

1. Inflator
2. Air Bag
3. Inflator harness with connector

NOTE: THE AIR BAG MODULE IS SERVICED ONLY AS AN ASSEMBLY. DO NOT ATTEMPT TO DISASSEMBLE OR REPACK THE AIR BAG.

INFLATOR IGNITER

The inflator igniter is designed to ignite a squib after it receives an input from the ECU. The igniter is an electrically heater device with generates temperatures in excess of 300 degrees F. to ignite the squib.

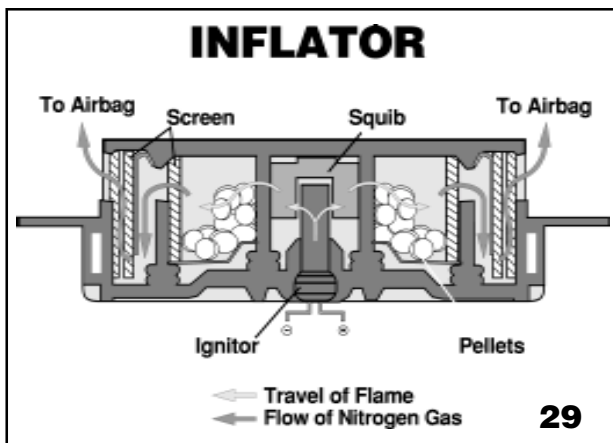

The squib consists of fire transmissive material used to ignite nitrogen pellets. The nitrogen pellets generate nitrogen gas (N₂) during combustion. This creates rapid gas expansion with, in turn, inflates the air bag.

The built-in screen cools and removes hot cinders from the N₂ before the N₂ enters the air bag.

NOTE: FOR MORE SPECIFIC CHEMICAL CONTENT, PLEASE REFER TO THE SUBARU SVX SERVICE MANUAL.

AIR BAG

The air bag itself is located behind the steering wheel center pad. It is made out of nylon material which expands to a diameter of approximately 30 inches(762mm) when inflated.

The bag is coated on the inside with silicone and is coated on the outside with talcum powder or cornstarch. This provides lubrication for deployment. These inner and outer coating produce the majority of the residue found after deployment.

AIR BAG DEPLOYMENT

In order to activate the system, a frontal force of 12.5 MPH or greater is required. This force overcomes the inertia and the tension of the roller springs of the rollers in the front sensors and the safing sensors. The rollers then make contact with the circuit terminals. The front sensors provide a ground circuit while the safing sensors provide a positive circuit.

In order for the ECU to activate the inflator, it must receive at least one collision signal from the front sensors and at least one collision signal from the safing sensors.

After receiving a signal from the ECU, the igniter instantly heats up to 300 degrees F., igniting the squib which burns the nitrogen pellets to create nitrogen gas. The generated N₂ goes through the screen into the air bag. The outer skin (steering wheel pad) of the inflator air bag module then ruptures as the air bag deploys. The Drivers forward movement is absorbed by the air bag as it vents the N₂ through two 1.58 inch(40mm) holes.

The Operational Time Sequence is almost instantaneous:

1. Collision: Zero seconds
2. Operation of the inflator: 3/100 second
3. Discharge of the N₂: About 6/100 second
4. Completion: About 110/1000 second

NOTE: A VEHICLE WITH A DEPLOYED AIR BAG MUST BE TOWED TO THE DEALER FOR SERVICE.

Supplemental Restraint System (SRS)

AIR BAG WARNING LAMPS

Two (2) air bag warning lamps are located on the lower right-hand corner of the combination meter. Two bulbs are used with independent drive circuits for redundancy. The assembly is replaced as one unit.

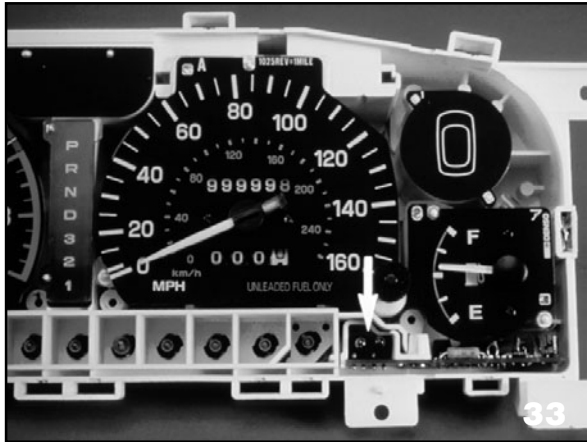

The lamp illuminates for 8 seconds after the key is turned to the "ON" position. It communicates to the operator when service is required and it communicates trouble codes to the technician.

DIAGNOSTICS AND SERVICING

The self-diagnostic system employs three modes similar to the fuel system self-diagnostics:

1. U-Check (User Check)
2. D-Check (Dealer Check)
3. Read Memory

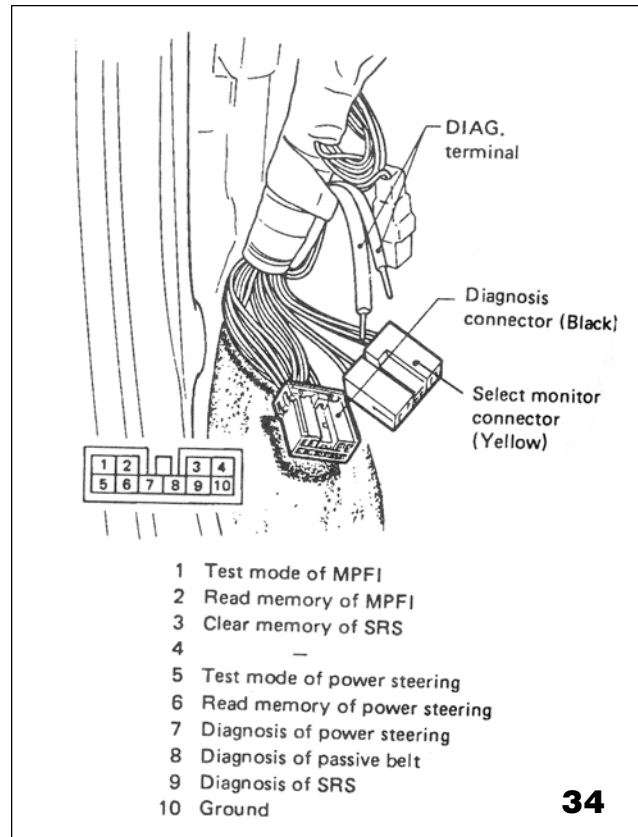

The U-Check Mode warns the driver of a system fault by illumination of the "AIR BAG" light on the dash. The light will turn off if the trouble source corrects itself.

Trouble codes are stored in long term memory and displayed similar to the fuel system codes. They are indicated by the "AIR BAG" light with the following values:

1. 1.2 Second (Long) Flash = 10
2. 0.3 Second (Short) Flash = 1
3. Continuous 0.6 Second Flashes = no trouble

There is also an additional factory long-term memory which can only be accessed by the factory. The purpose of this is for the ECU to maintain a vehicle trouble code history. The long term memory cannot be cleared in the field.

Supplemental Restraint System (SRS)

NOTE: THE DIAGNOSTIC PROCEDURES ARE FOUND IN THE SVX SERVICE MANUAL, SECTION 5-5.















CAUTION: DO NOT UNLOCK "DOUBLE LOCK" CONNECTORS OR DISCONNECT SYSTEM CONNECTORS WITH THE IGNITION "ON". THE ECU WILL SET A TROUBLE CODE IMMEDIATELY. THESE CODES WILL ALSO BE SET IN HIDDEN MEMORY AND CANNOT BE CLEARED FROM THE HIDDEN MEMORY.

SRS SYSTEM SERVICING

An SRS inspection is required every ten (10) years. Perform the Self-Diagnostic Checks and verify that the air bag warning lights are functioning. Also verify that there are no codes in memory and no current codes existing.

NOTE: REFER TO THE SUBARU SVX SERVICE MANUAL, SECTION 1-5, AND REVIEW THE TEN YEAR SERVICE PROCEDURES.

NOTE: REFER TO THE SVX SERVICE MANUAL, SECTION 5-5, TO IDENTIFY THE TEST HARNESSES AND THE CONNECTOR NUMBERS.

98299AE000		Test Harness K
98299FA030		Test Harness H
98299FC000		Test Harness E
98299FC010		Test Harness F
98299FC020		Test Harness G
98299FC040		Test Harness I
98299FC041		Test Harness I 2
98299FE000		Test Harness L
98299FE020		Test Harness M
98299PA000		Test Harness A
98299PA011		Test Harness B
98299PA020		Test Harness C
98299PA040		Test Resistor 1 of 2 needed
98299PA040		Airbag Resistor 2 of 2 needed

35

CAUTION: NEVER USE TEST HARNESS "C" TO CHECK THE RESISTANCE OF THE AIR BAG MODULE.

CAUTION: THE DEPLOYMENT HARNESS SHOULD NEVER BE CONNECTED TO THE AIR BAG MODULE WHILE THE MODULE IS IN THE VEHICLE.

CAUTION: ALWAYS USE A DIGITAL TYPE OHM METER WITH AN OUTPUT SPECIFICATION OF 100 MILLE-AMPS OR LESS WHEN TESTING THE AIR BAG MODULE OR SRS CIRCUITS. USE OF THE INCORRECT TYPE OF METER MAY CAUSE ACCIDENTAL DEPLOYMENT. IF YOU ARE NOT SURE ABOUT THE SPECIFICATION OF YOUR METER, DO NOT USE IT UNTIL THE SPECIFICATIONS CAN BE VERIFIED.

Supplemental Restraint System (SRS)

1995 MODEL LEGACY



Dual supplemental restraint system air bags will be standard equipment on all 1995MY Legacys and functions are similar to previous Model Year Legacys. The passenger side air bag module is wired in parallel with the driver's side. Both sides will deploy in the event of a frontal collision of 12.5mph or greater.



Four (4) position, three (3) point seat belts with ELRS are used in the front seats. The outer rear seat positions use a three (3) point seat belt with ALR assemblies. The center rear seat position uses a two (2) point seat belt.

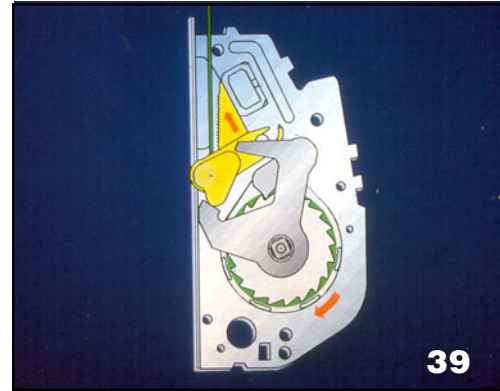

CAUTION: BEFORE SERVICING ANY SRS COMPONENT, DISCONNECT THE BATTERY AND WAIT 30 SECONDS FOR THE CAPACITORS TO DISCHARGE.

1996 MODEL LEGACY AND OUTBACK

All 1996MY Legacy and Outback vehicles will have dual air bags. However, the electrical systems operating them will differ.

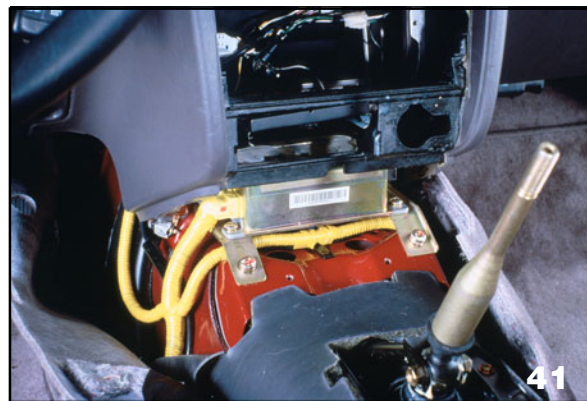

The Outback utilizes the same system as was used on the 1995MY Legacy front sensors and safety sensors incorporated in the SRS control unit. The 1996MY Legacy vehicles no longer have separate front sensors. A "G" sensor located in the control unit performs all impact sensing.

Supplemental Restraint System (SRS)

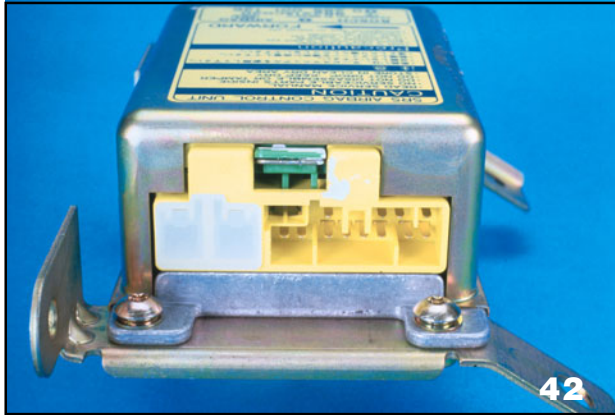

Both models use a floating type SRS air bag module. The 1996MY Legacy steering wheel will no longer have horn buttons. To use the horn, press on the SRS air bag module, which activates a switch plate.



1998 MODEL FORESTER

The SRS air bag system for the 1998MY Forester employs both a driver and passenger side air bag. Please observe all warning precautions listed on the appropriate service publications and warning labels of the vehicle.

The driver side air bag is unchanged from that of the 1997 Impreza. Dashboard configuration for the passenger side requires a new air bag design. The air bag module can be removed or installed with the instrument panel in place.

The inflator of the passenger side air bag is a new design. During deployment, a liquid fuel (Alcohol 10 milliliters) is ignited. The expansion of gasses during the burning of the fuel inflates the air bag.

Gasses produced during burning include Argon and Helium.



Supplemental Restraint System (SRS)

Control unit location is just forward of the shifter assembly.

The connector appearance and double lock feature have changed.

The control unit connector plate is designed for use with other Subaru SRS systems as well as the North American models. The connector is yellow with 20 pins.

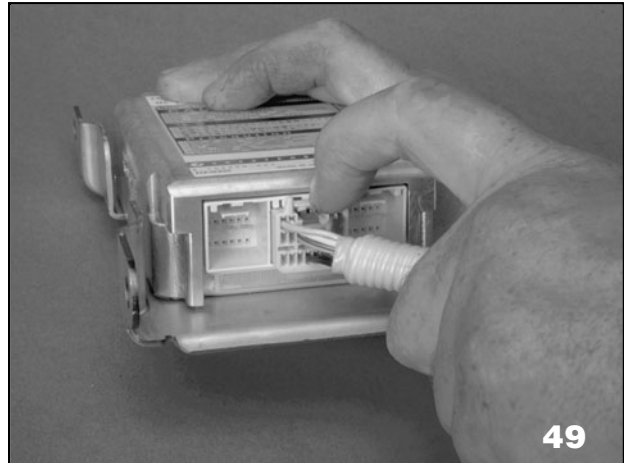

The connector "double-locks" for the driver side and passenger side air bag modules have also changed.

To disengage, push down on the yellow tab and slide the green tab in the direction of the arrow. Next, release the tab and pull gently on the connector. Failure to release the tab before attempting separation will result in the connector remaining engaged.

The new test harnesses are labeled, respectfully: **E, F, and G.**

The same test resistor is used when checking driver side or passenger side air bag module integrity.

The window of the Steering Roll Connector has been deleted. Follow the direction on the Steering Roll Connector and the service manual when working with an area that will change the wheel to Steering Roll Connector phasing.

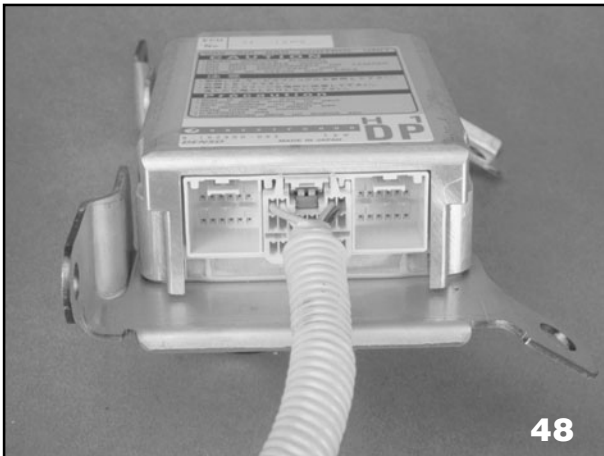

The connector is disengaged by pushing down on the top tab and gently pulling, applying force to the tab and the connector.

A plastic tab inside the connector area separates the contacts that monitor the circuit for loose connections (Code 14).

Supplemental Restraint System (SRS)

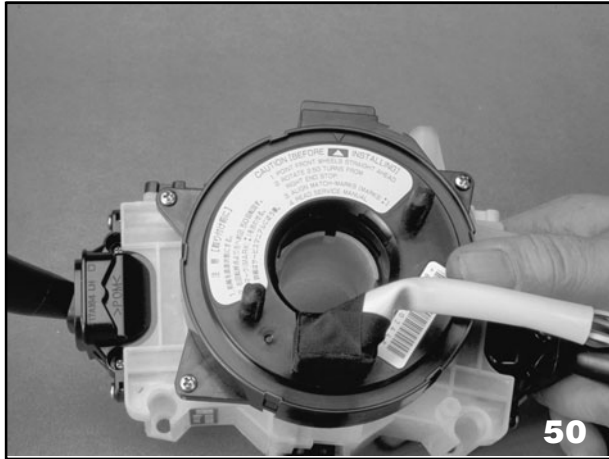

Side impacts to the rear door of the vehicle are absorbed by the door and body of the vehicle as well as to the shield under the rear passenger seat. The transferred force is then distributed through the shield and back in to the body of the vehicle.

2000 MODEL LEGACY AND OUTBACK

The SRS air bag control unit has been changed to include the addition of inputs and provide the output necessary for side air bag and seat belt pretensioner operation.

The Legacy SRS air bag system utilizes the same type of control unit and connectors with the addition of two (2) front sub-sensors mounted just forward of the wheel arch area. Their input to the SRS ECM influences deployment, however, deployment is not dependent on the front sensors switches closing. The ECM makes the final determination to deploy or not using logic that contains preset values.

Side SRS airbags are equipped on GT Limited and Outback Limited models. They are designed to deploy on impact to the side of the vehicle. The severity of the impact is determined by the side air bag sensor located in the B-Pillar.

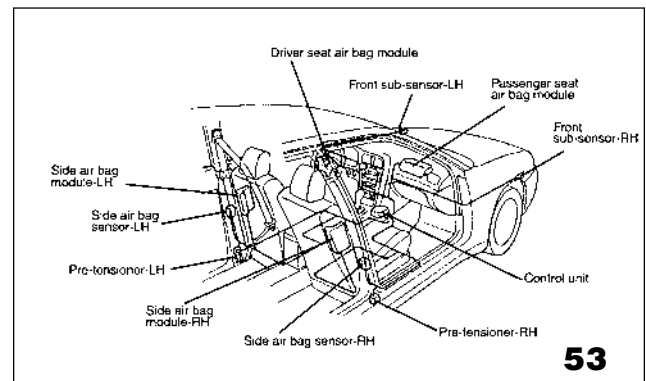

This diagram illustrates the electrical layout of the SRS air bag system without side air bags. The front sub-sensors are located in the front bumper area. The seat belt pretensioners will activate at the same time the front air bags activate.



Supplemental Restraint System (SRS)

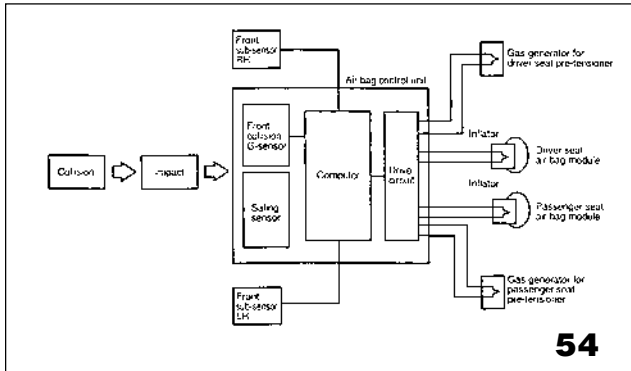

54

This diagram illustrates the total SRS air bag system electrical layout. During a frontal impact, the front sub-sensors and sensors contained in the SRS control unit determine the severity of impact. If the impact exceeds pre-established parameters, the front air bags, driver and passenger side, as well as both front seatbelt pretensioners activate.

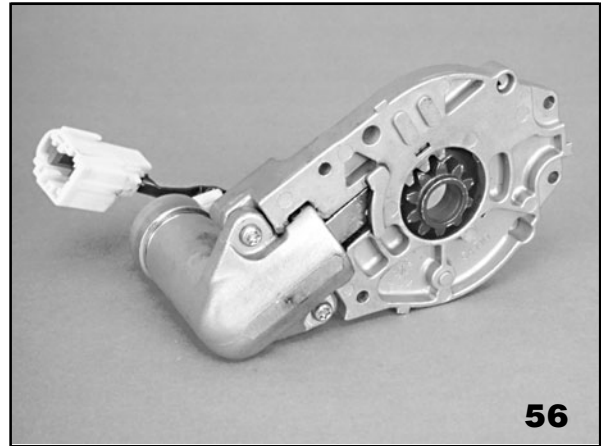

56

The GT and Outback models have a 6-way power driver seat. When servicing this seat, disconnect the side SRS air bag connector after positioning the seat for mounting bolt removal and disconnecting the battery. (Wait 30 seconds before proceeding).

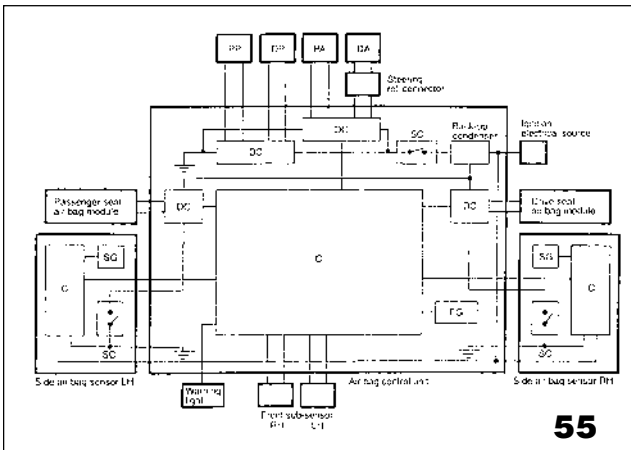

55



57

Seatbelt pretensioner operation winds the belt to restrain the occupant. The gas generator when activated pushes a piston, which is made onto a rack-type gear. This gear rotates the winding gear creating the motion and force necessary to wind the belt inward. When the force of the belt reaches a fixed value, the force limiter contained in the seatbelt assembly operates to control the restraint force so it does not increase further.



58

Supplemental Restraint System (SRS)

2001 MODEL LEGACY



All Legacy vehicles will share an enhancement to the passenger side SRS Air Bag System.

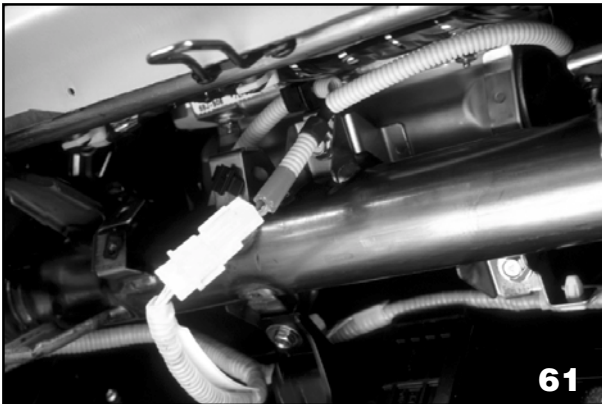

The air bag module now contains 2 inflation units. (Figure 57) Each one independently controlled by the SRS ECM. During an impact of lower speeds (above the deployment minimum specification) 1 side of the module will be activated followed by the other side. The time between the 2 sides activating for deployment is controlled by the ECM to decrease the impact of the bag with the passenger. The higher the impact speed, the shorter the time between the 2 sides activating for deployment. The 2 sides will be activated together above a higher impact speed.

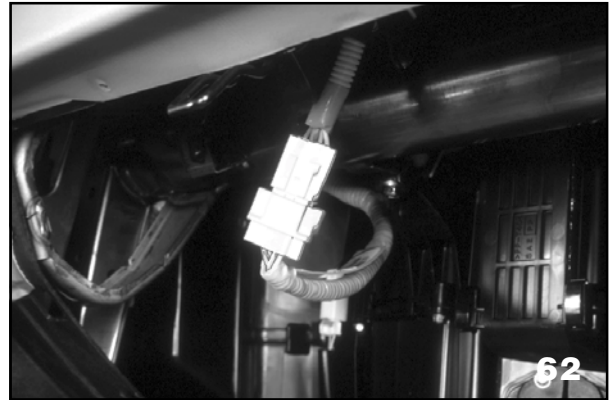

A new style of connector is used for the passenger side airbag module. The connector is disengaged by pulling down on the wider portion of the body harness while supporting the lower portion.



There is no change to the driver side SRS Airbag.

Supplemental Restraint System (SRS)

2002 MODEL IMPREZA WRX

WRX models will have side air bags as standard equipment.

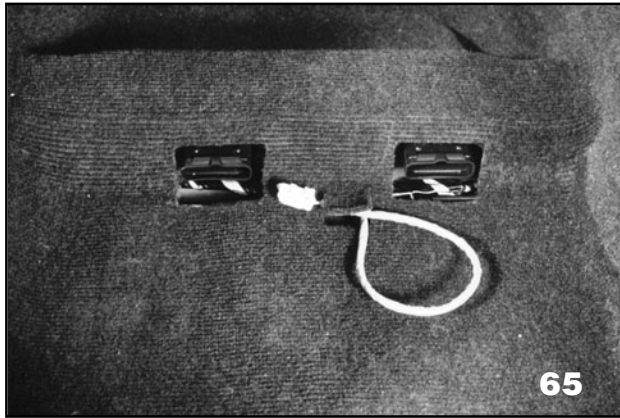

Caution must be observed while removing the front seats to ensure the SRS wiring harness is not damaged.

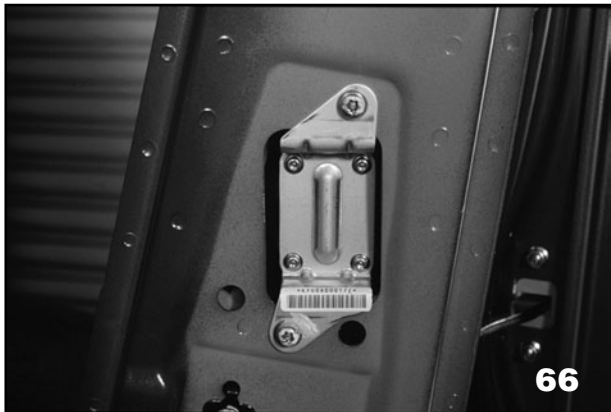

The side impact switch is mounted on the left and right B pillars behind the seat belt trim panels.



The SRS Air Bag for Impreza 2002 will include the addition of seat belt pretensioners for all models (Passenger side air bag module is the single deployment type).



The control unit is located in front of the gate type shifter.

