

General Description

AIRBAG SYSTEM (DIAGNOSTICS)

3. General Description

A: CAUTION

Refer to "CAUTION" in "General Description" in Airbag System. <Ref. to AB-11, CAUTION, General Description.>

B: INSPECTION

Measure the battery voltage and check electrolyte.

Standard voltage: 12 V

Specific gravity: 1.260 or more

General Description

AIRBAG SYSTEM (DIAGNOSTICS)

C: PREPARATION TOOL

CAUTION:

To measure the voltage and resistance of airbag system component, be sure to use the specified test harness.

1. SPECIAL TOOL

- Subaru Select Monitor

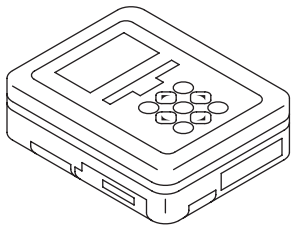
ILLUSTRATION	TOOL NUMBER	DESCRIPTION	REMARKS
 <p>ST1B022XU0</p>	1B022XU0	SUBARU SELECT MONITOR III KIT	Used for troubleshooting the electrical system.

- TEST HARNESS H

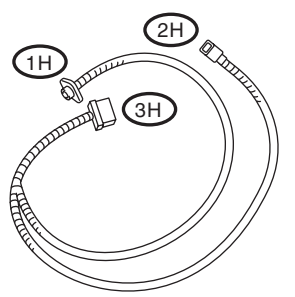
ILLUSTRATION	TOOL NUMBER	DESCRIPTION	REMARKS
 <p>ST98299FA030</p>	98299FA030	TEST HARNESS H	Used when measuring voltage and resistance of front sub sensor and front door impact sensor.

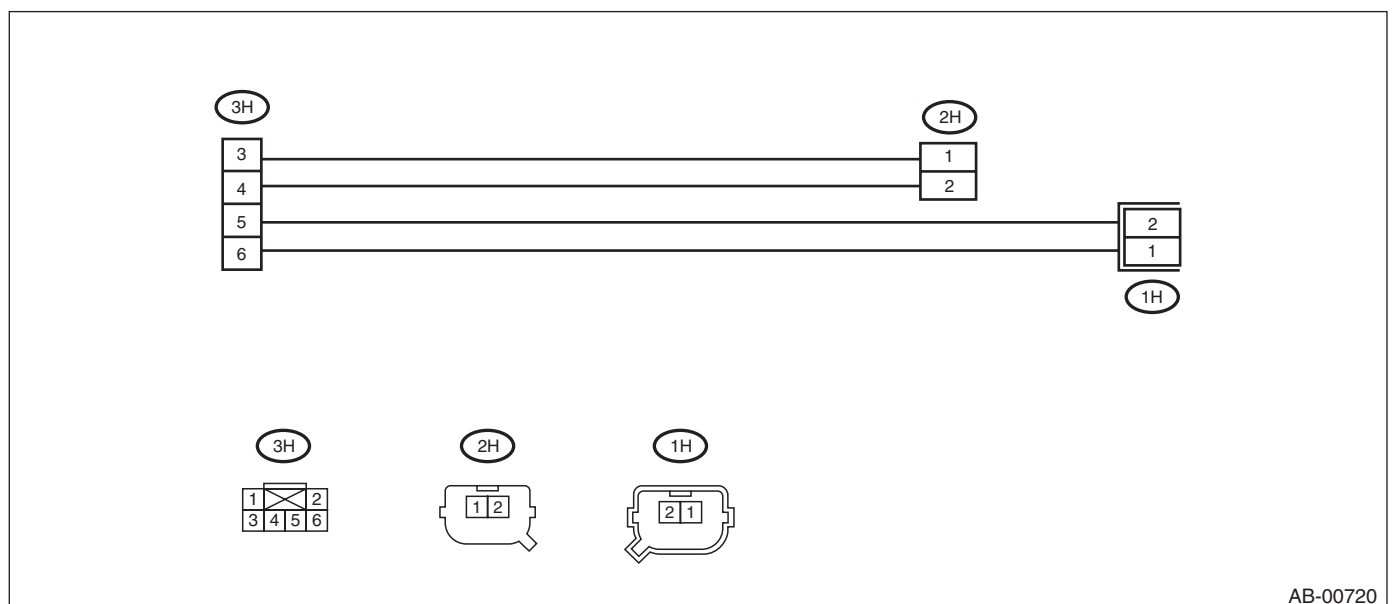

AB-00720

General Description

AIRBAG SYSTEM (DIAGNOSTICS)

- TEST HARNESS N

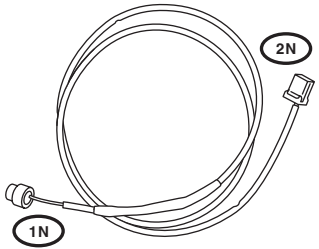
ILLUSTRATION	TOOL NUMBER	DESCRIPTION	REMARKS
 <p data-bbox="326 558 467 579">ST98299SA000</p>	98299SA000	TEST HARNESS N	Used when measuring voltage and resistance of driver's airbag module, seat belt pretensioner and curtain airbag module.

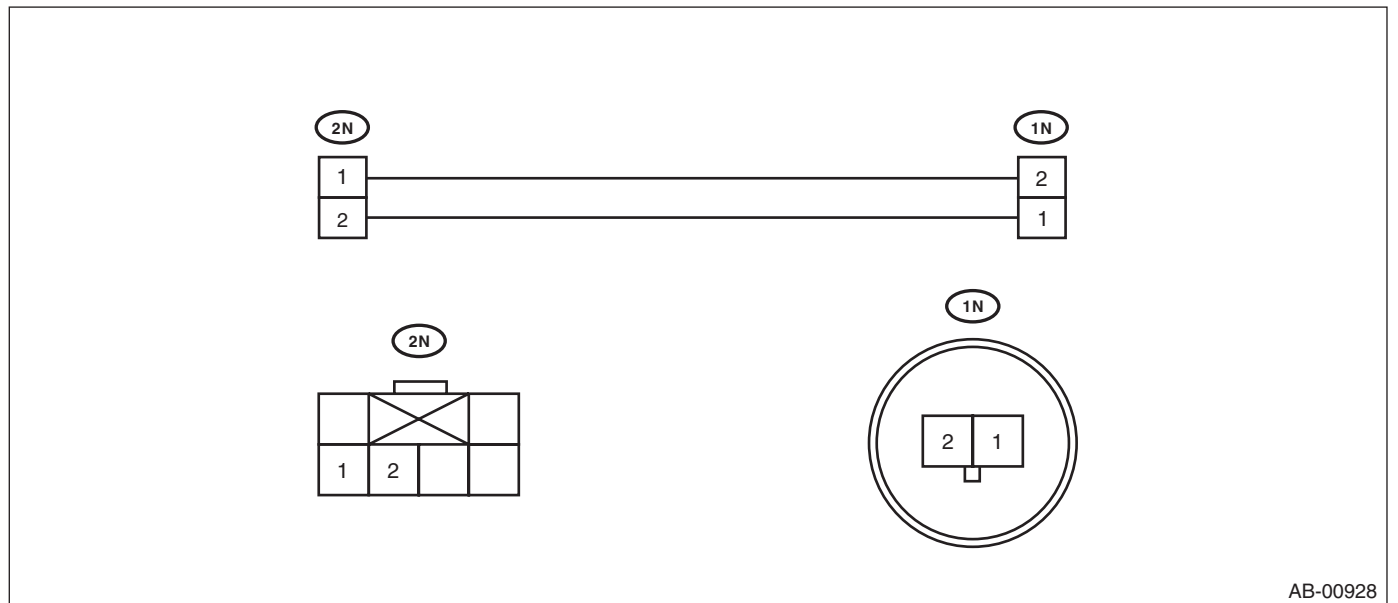

General Description

AIRBAG SYSTEM (DIAGNOSTICS)

- TEST HARNESS Q

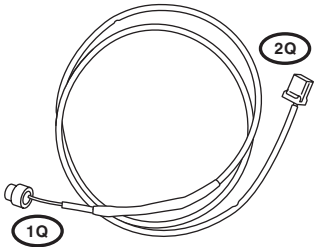
ILLUSTRATION	TOOL NUMBER	DESCRIPTION	REMARKS
 <p>ST98299SA040</p>	98299SA040	TEST HARNESS Q	Used when measuring voltage and resistance of driver's airbag module.

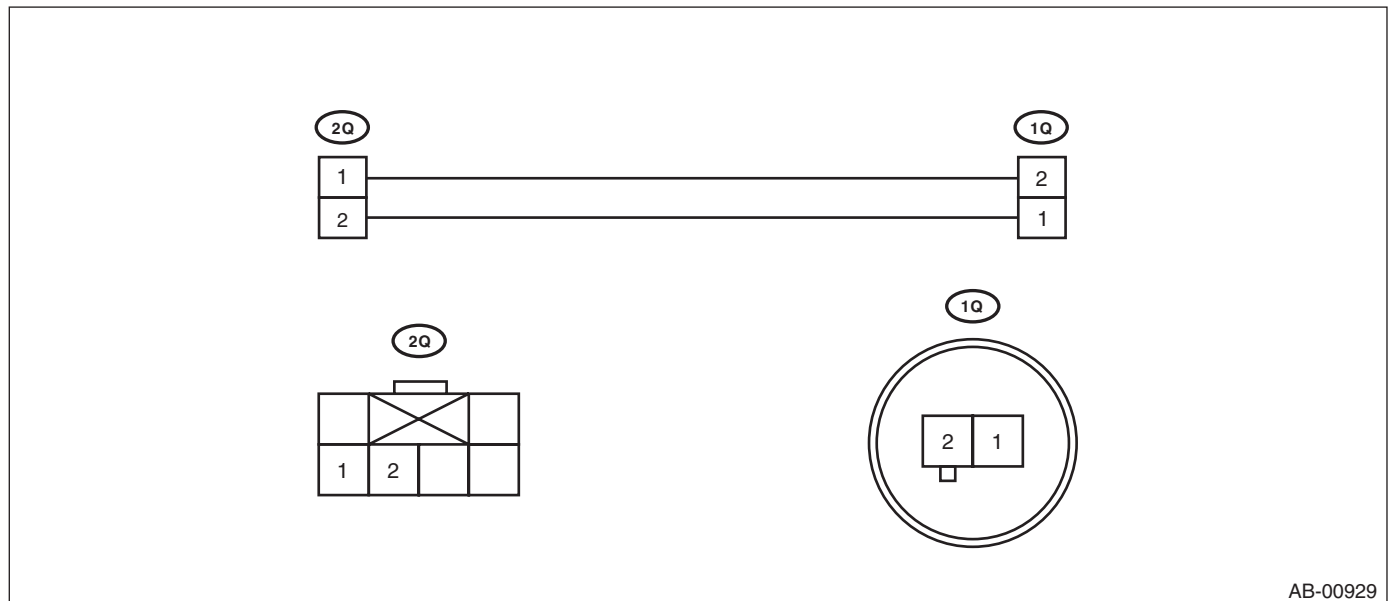

AB-00929

General Description

AIRBAG SYSTEM (DIAGNOSTICS)

- TEST HARNESS AG

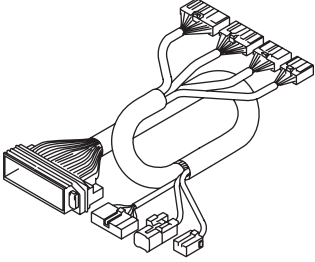
ILLUSTRATION	TOOL NUMBER	DESCRIPTION	REMARKS
 <p>ST98299AG070</p>	98299AG070	TEST HARNESS AG	Used when measuring voltage and resistance of airbag control module.

General Description

AIRBAG SYSTEM (DIAGNOSTICS)

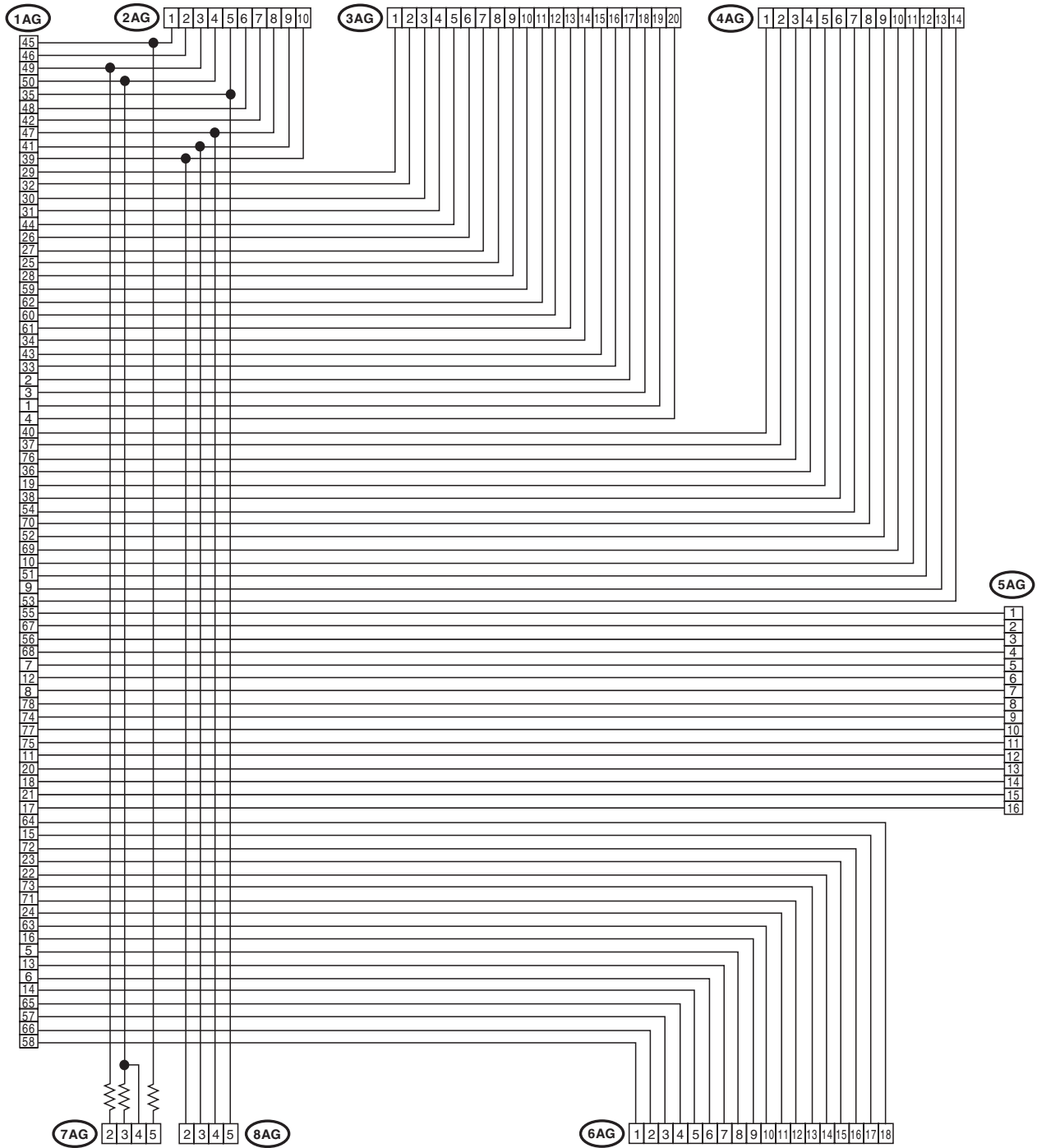

AB-01902

General Description

AIRBAG SYSTEM (DIAGNOSTICS)

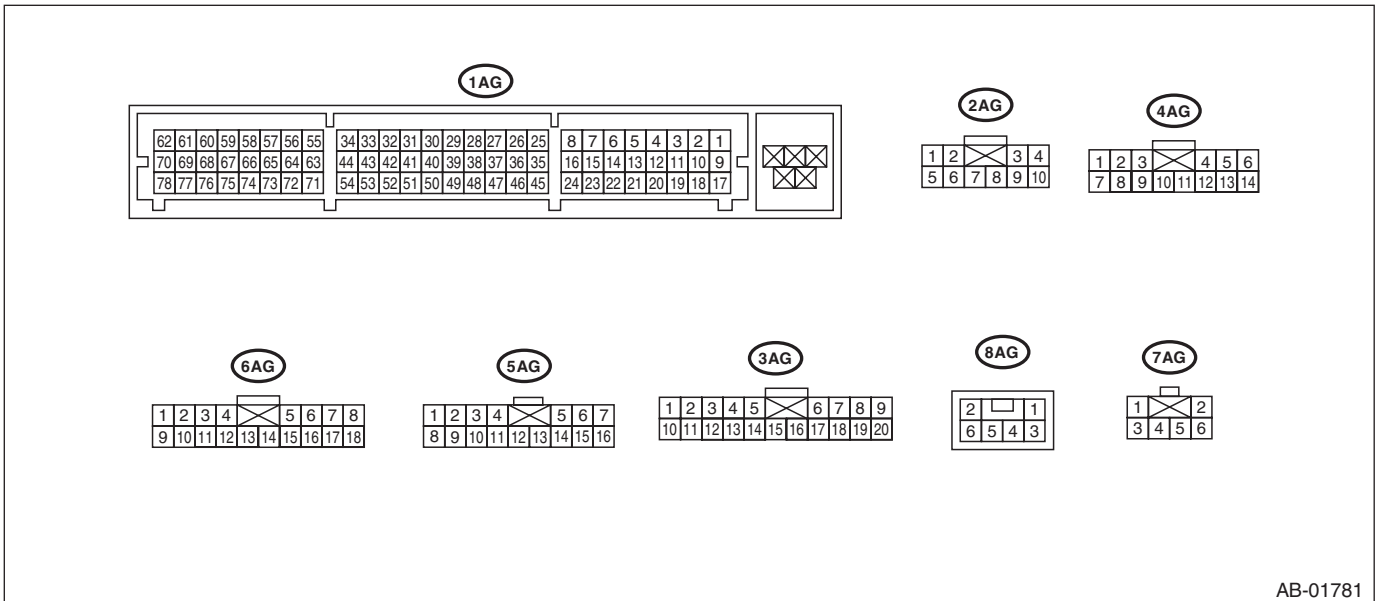

AB-01781

General Description

- TEST HARNESS AH

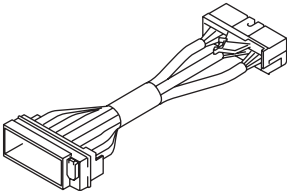
ILLUSTRATION	TOOL NUMBER	DESCRIPTION	REMARKS
 <p>ST98299AG080</p>	98299AG080	TEST HARNESS AH	Used together with test harness AG when measuring voltage and resistance of the airbag control module.

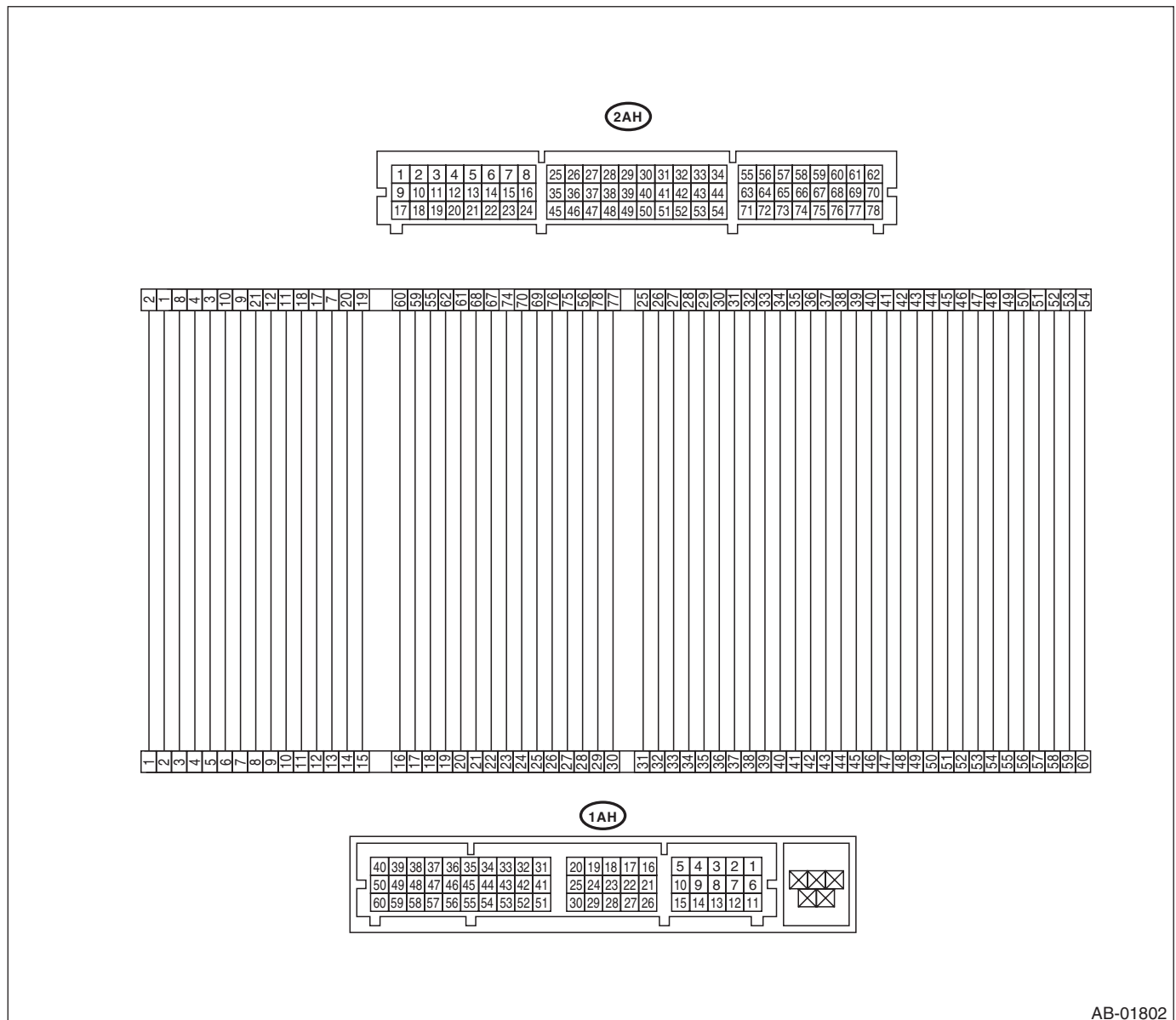

General Description

AIRBAG SYSTEM (DIAGNOSTICS)

- TEST HARNESS V

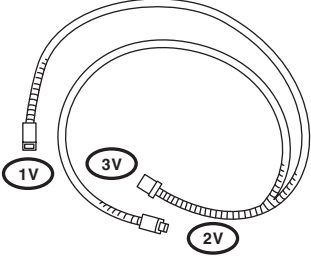
ILLUSTRATION	TOOL NUMBER	DESCRIPTION	REMARKS
 <p>ST98299AG010</p>	98299AG010	TEST HARNESS V	Used when measuring voltage and resistance of side airbag sensor and curtain airbag sensor.

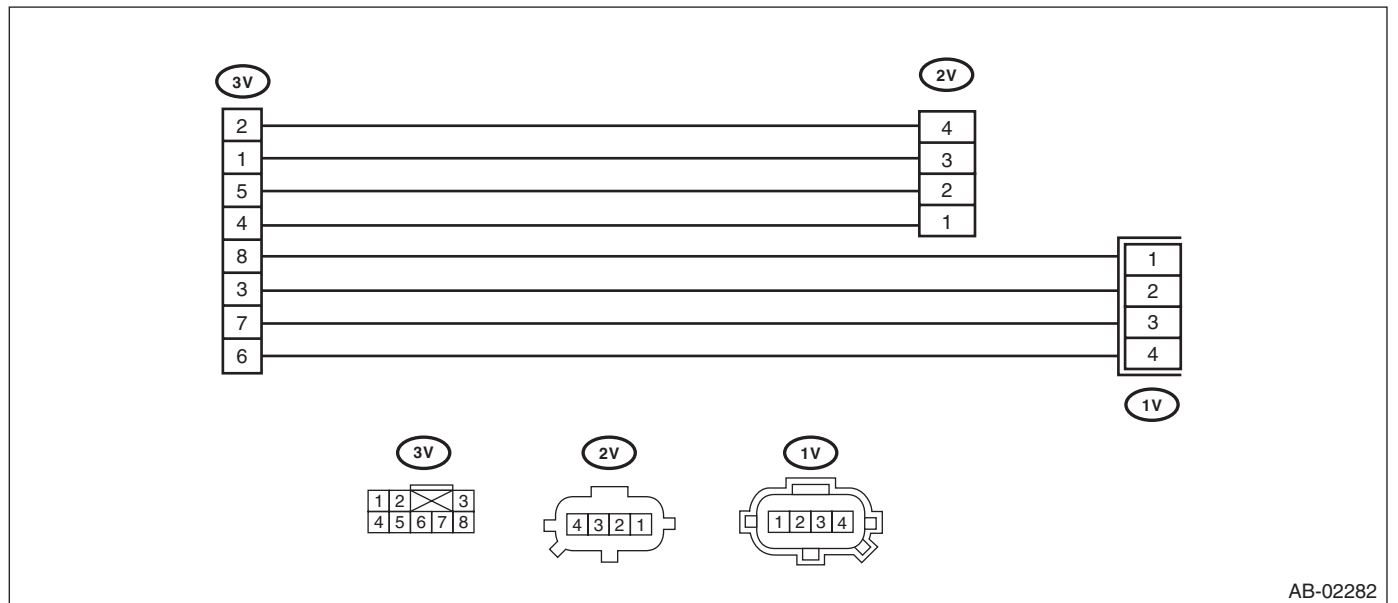

General Description

- AIRBAG RESISTOR

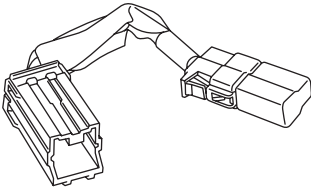
ILLUSTRATION	TOOL NUMBER	DESCRIPTION	REMARKS
 ST98299PA040	98299PA040	AIRBAG RESISTOR	Used in replacement of airbag module for which resistance value is same as airbag module. Two ST are required for diagnosis of two-stage inflator type airbag module.

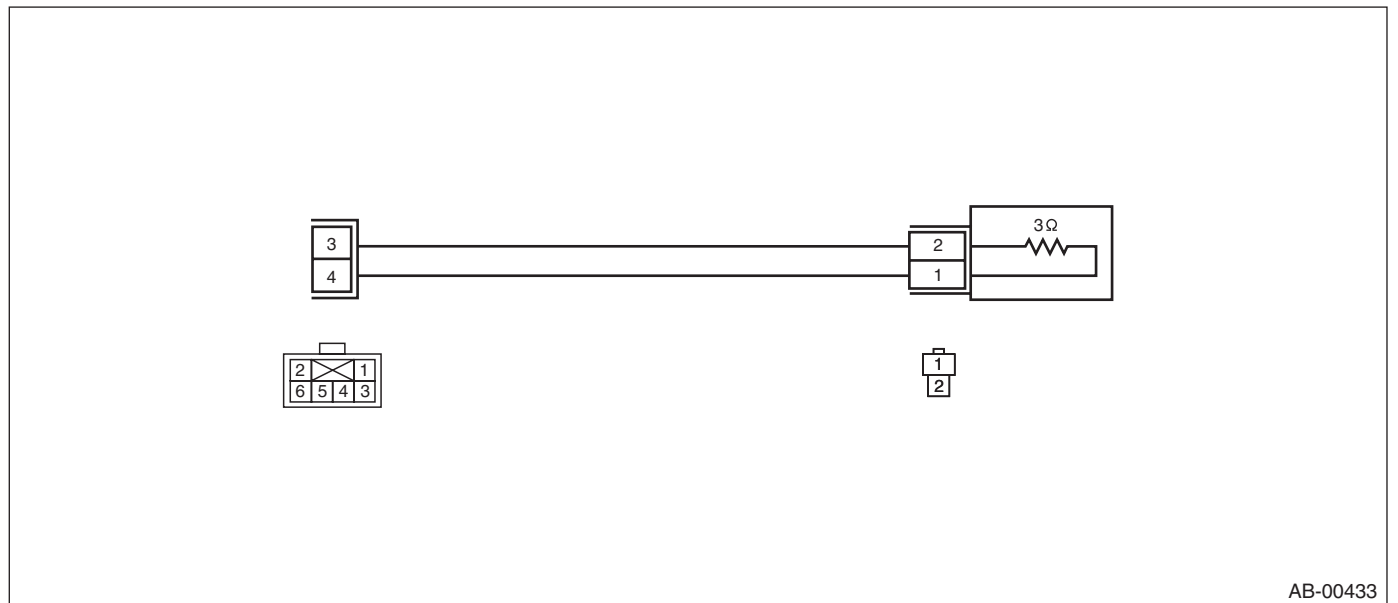

AB-00433

General Description

AIRBAG SYSTEM (DIAGNOSTICS)

- TEST HARNESS AJ

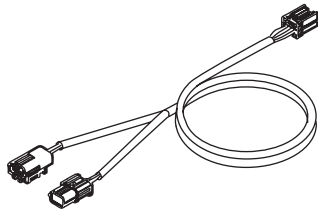
ILLUSTRATION	TOOL NUMBER	DESCRIPTION	REMARKS
 <p>ST98299FG000</p>	98299FG000	TEST HARNESS AJ	Used when measuring power supply and resistance of side airbag harness.

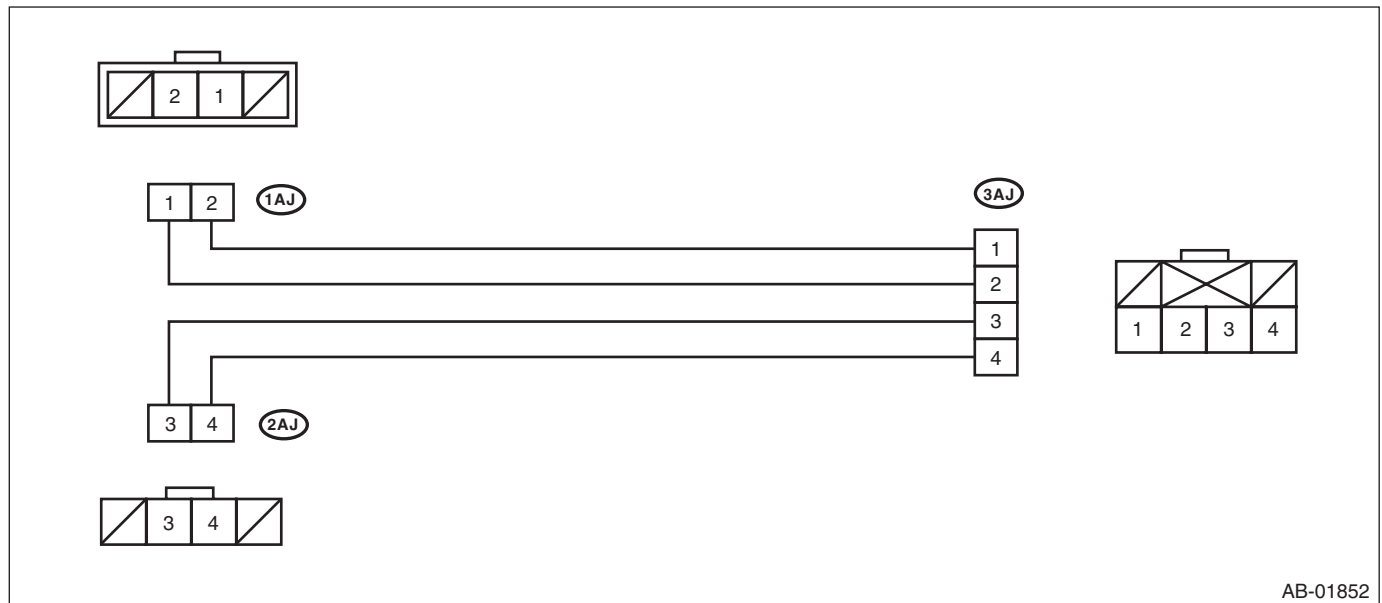

General Description

AIRBAG SYSTEM (DIAGNOSTICS)

• TEST HARNESS AI

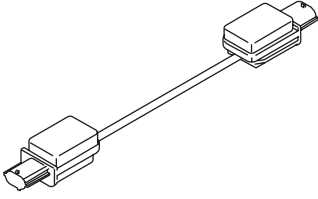
ILLUSTRATION	TOOL NUMBER	DESCRIPTION	REMARKS
 <p data-bbox="321 558 467 579">ST98299AG090</p>	98299AG090	TEST HARNESS AI	<ul style="list-style-type: none"> • Used for diagnoses of side airbag sensor and curtain airbag sensor. • Used together with test harness V.

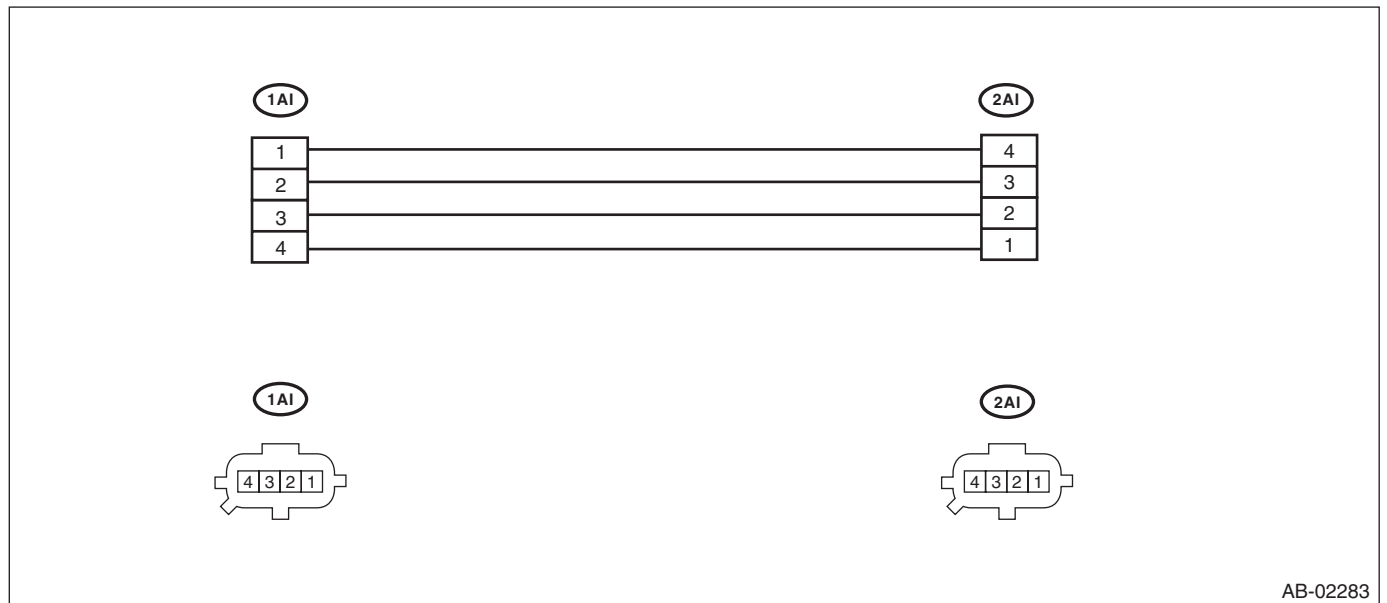

AB-02283

General Description

AIRBAG SYSTEM (DIAGNOSTICS)

2. GENERAL TOOL

TOOL NAME	REMARKS
Circuit tester	Used for measuring resistance, voltage and current.
Oscilloscope	Used for measuring the sensor.
Probe	Used when measuring voltage and resistance of passenger's airbag module.

3. HOW TO USE PROBE

Insert the probe into the harness hole, and contact it with the terminal.

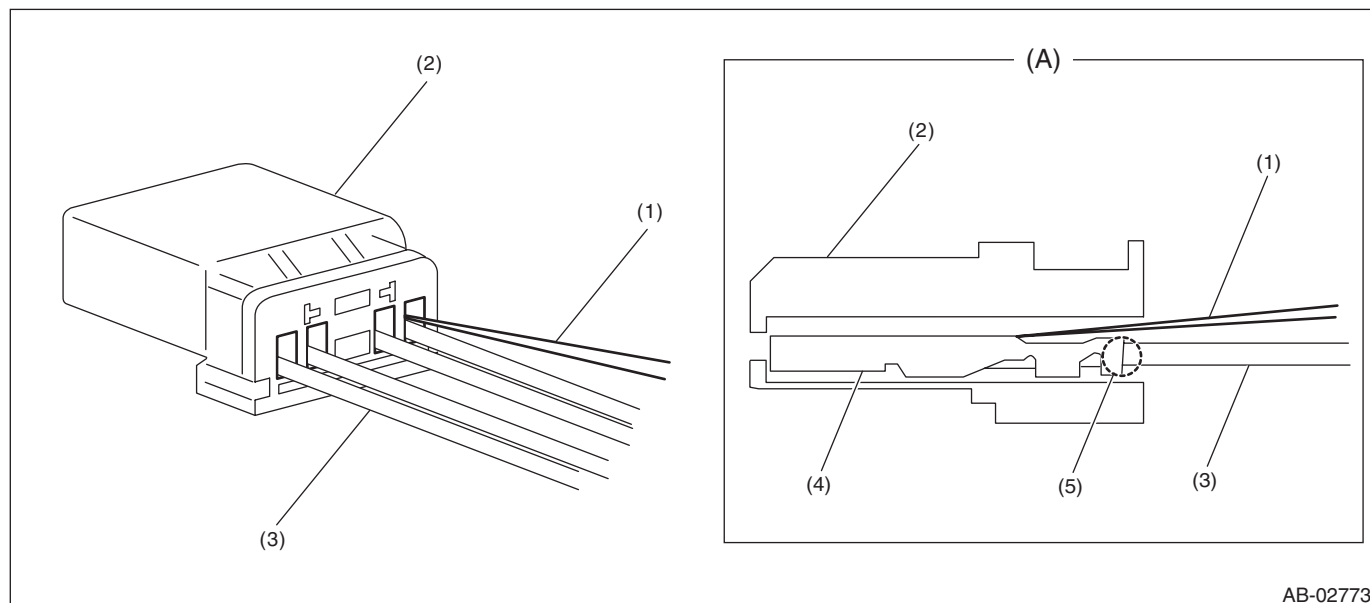

(A) Cross section

(1) Probe

(3) Harness

(5) Connection

(2) Connector (housing)

(4) Terminal

CAUTION:

- Do not insert the probe forcibly.
- Be careful not to contact it to the connection (5) between the terminal and harness. (Harness will come off easily from connector if doing so.)