

1. General Description
2. Relay and Fuse
3. Vehicle Dynamics Control System
4. VDC Control Module and Hydraulic Control Unit (VDCCM&H/U)
5. ABS Sequence Control
6. VDC Sequence Control
7. Brake Lamp Relay
8. Yaw Rate and G Sensor
9. Steering Angle Sensor
10. Front ABS Wheel Speed Sensor
11. Rear ABS Wheel Speed Sensor
12. Front Magnetic Encoder
13. Rear Magnetic Encoder
14. VDC OFF Switch
15. General Diagnostic Table

VEHICLE DYNAMICS CONTROL (VDC) > General Description

CAUTION

- When performing service operation, refer to "Repair Contents" in "General Description". [🔗 Ref. to REPAIR CONTENTS>Repair Contents.](#)
- When performing any work, always wear work clothes, a work cap and protective shoes. Additionally, wear a helmet, protective goggles, etc. if necessary.
- When performing a repair, identify the cause of trouble and avoid unnecessary removal, disassembly and replacement.
- Some vehicle components are extremely hot immediately after driving. Be wary of receiving burns from heated parts.
- Use SUBARU genuine grease, the recommended or equivalent. Do not mix grease etc. of different grades or manufacturers.
- Apply grease onto sliding or revolving surfaces before installation.
- When performing work on the sensors or modules, be careful of the following.
 - Before disconnecting electrical connectors, be sure to disconnect the ground terminal from the battery sensor. [🔗 Ref. to REPAIR CONTENTS>NOTE > BATTERY.](#)
 - Do not apply any impact. If the parts are accidentally dropped, replace with a new part.
 - Do not expose to high-temperature and humidity.
- Refer to "CAUTION" of "General Description" in "AIRBAG SYSTEM" section. [🔗 Ref. to AIRBAG SYSTEM>General Description>CAUTION.](#)
- Before starting works, remove dirt and corrosion around the target area.

VEHICLE DYNAMICS CONTROL (VDC) > General Description

SPECIFICATION

1. ABS WHEEL SPEED SENSOR

• STANDARD DAMPER MODEL

Item		Specification or identification	
ABS wheel speed sensor gap (for reference)	mm (in)	Front	0.62 – 1.57 (0.02 – 0.06)
		Rear	0.46 – 1.73 (0.02 – 0.07)
Identifications of harness (symbol)	Front	RH	P1
		LH	P2
	Rear	RH	P9
		LH	P10

• ELECTRONICALLY-CONTROLLED DAMPER MODEL

Item		Specification or identification	
ABS wheel speed sensor gap (for reference)	mm (in)	Front	0.62 – 1.57 (0.02 – 0.06)
		Rear	0.46 – 1.73 (0.02 – 0.07)
Identifications of harness (symbol)	Front	RH	P5
		LH	P6
	Rear	RH	P7
		LH	P8

2. VDC CM&H/U

Item	Identification	
VDC CM&H/U identification	Models without EyeSight	S4
	Models with EyeSight	S2

VEHICLE DYNAMICS CONTROL (VDC) > General Description

COMPONENT

1. ABS WHEEL SPEED SENSOR

• STANDARD DAMPER MODEL

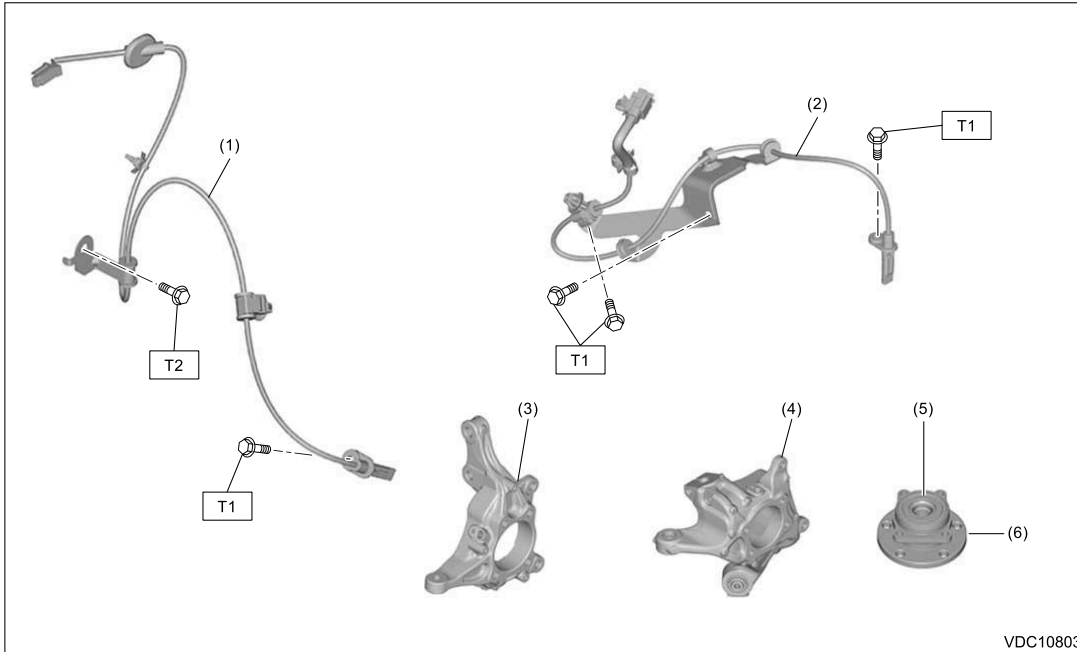

(1) Sensor sub ASSY front

(4) Rear axle housing

Tightening torque: N·m (kgf-m, ft-lb)

(2) Sensor sub ASSY rear

(5) Magnetic encoder

T1: 7.5 (0.8, 5.5)

(3) Front axle housing

(6) Hub unit bearing

T2: 33 (3.4, 24.3)

• ELECTRONICALLY-CONTROLLED DAMPER MODEL

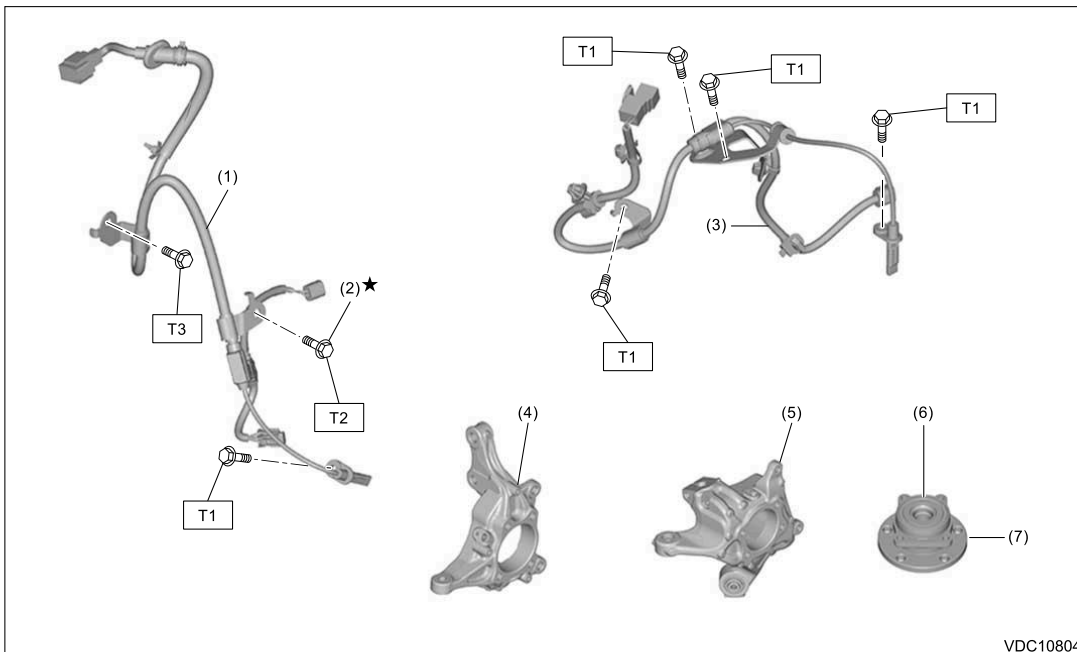

(1) Electric damper harness ABS ASSY front

(5) Rear axle housing

Tightening torque: N·m (kgf-m, ft-lb)

(2) Flange bolt

(6) Magnetic encoder

T1: 7.5 (0.8, 5.5)

- (3) Electric damper harness ABS ASSY rear
- (4) Front axle housing
- (7) Hub unit bearing

T2: 15 (1.5, 11.1)

T3: 33 (3.4, 24.3)

2. STEERING ANGLE SENSOR

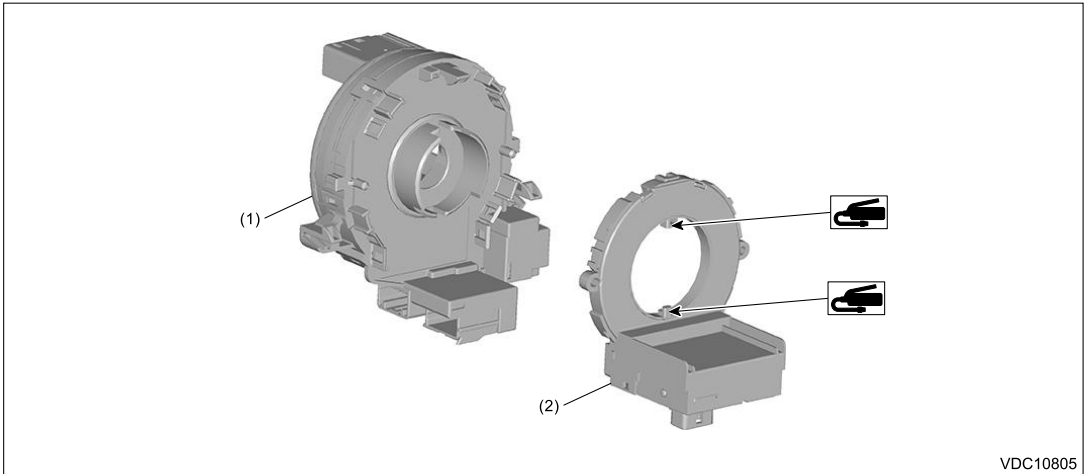

- (1) Steering roll connector
- (2) Sensor ASSY VDC steering

3. VDC CONTROL MODULE & HYDRAULIC CONTROL UNIT (VDC CM&H/U)

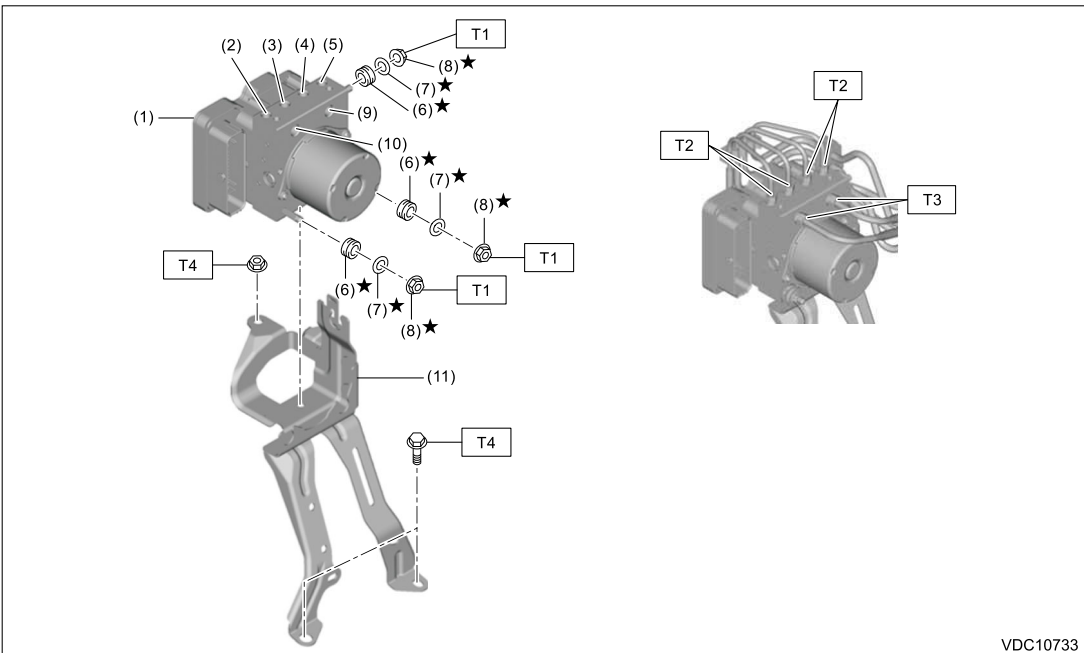

- (1) Hydraulic unit ASSY VDC
- (2) Rear RH outlet
- (3) Front LH outlet
- (4) Front RH outlet
- (5) Rear LH outlet
- (6) Damper
- (7) Washer
- (8) Nut
- (9) Primary inlet
- (10) Secondary inlet
- (11) Bracket COMPL hydraulic unit VDC

Tightening torque: N·m (kgf·m, ft·lb)

T1: 7.5 (0.8, 5.5)

T2: 15 (1.5, 11.1)

T3: 19 (1.9, 14.0)

T4: 33 (3.4, 24.3)

VEHICLE DYNAMICS CONTROL (VDC) > General Description

PREPARATION TOOL

1. SUBARU SPECIAL TOOL

ILLUSTRATION	TOOL NUMBER	DESCRIPTION	REMARKS
 <p>STSSM4</p>	—	SUBARU SELECT MONITOR 4	<p>Used for setting of each function and troubleshooting for electrical system.</p> <p>Note:</p> <ul style="list-style-type: none"> • For detailed operation procedures, refer to “Help” of application. • Used together with interface for Subaru Select Monitor (such as DST-i and DST-010).

2. OTHER

	REMARKS
Oscilloscope	Used for measuring the sensor.
Crowfoot wrench	<p>Used for installing the brake pipe.</p> <p>Note: Use Snap-on FRHM10 or FRHM12, or another manufacturer’s 12-point wrench.</p>
Circuit tester	Used for measuring resistance, voltage and current.
Flare nut wrench	Used for removing and installing the brake pipe.
Pressure gauge	Used for measuring oil pressure.

VEHICLE DYNAMICS CONTROL (VDC) > Relay and Fuse

LOCATION

For the location, refer to "FUSE AND RELAY" in the wiring diagram.  [Ref. to WIRING SYSTEM>Fuse And Relay.](#)

Note:

For details of relay and fuse, refer to "DC POWER SUPPLY CIRCUIT".  [Ref. to WIRING SYSTEM>Power Supply Circuit>WIRING DIAGRAM.](#)

VEHICLE DYNAMICS CONTROL (VDC) > Relay and Fuse

INSPECTION

1. CHECK FUSE

1. Remove the fuse and inspect visually.
2. If the fuse is blown out, replace the fuse.

2. CHECK RELAY

1. Measure the resistance between relay terminals.

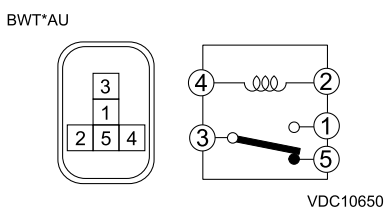
Terminal No.	Inspection conditions	Standard	Circuit
3 - 1	Always	1 M Ω or more	
3 - 5	Always	Less than 1 Ω	
3 - 1	Apply battery voltage between terminals 4 and 2.	Less than 1 Ω	

2. Replace the relay if the inspection result is not within the standard value.

VEHICLE DYNAMICS CONTROL (VDC) > Vehicle Dynamics Control System

WIRING DIAGRAM

For the wiring diagram, refer to "Vehicle Dynamics Control" in the wiring diagram. [🔍 Ref. to WIRING SYSTEM>Vehicle Dynamics Control System>WIRING DIAGRAM.](#)

VEHICLE DYNAMICS CONTROL (VDC) > Vehicle Dynamics Control System

ELECTRICAL SPECIFICATION

For the electrical specification, refer to "Control Module I/O Signal" of "BRAKE CONTROL (DIAGNOSTICS)" section. [🔍 Ref. to BRAKE CONTROL \(DIAGNOSTICS\)>Control Module I/O Signal.](#)

VEHICLE DYNAMICS CONTROL (VDC) > Vehicle Dynamics Control System

INSPECTION

1. BASIC INSPECTION

For the basic inspection, refer to "Basic Diagnostic Procedure" of "BRAKE CONTROL (DIAGNOSTICS)" section. [🔍 Ref. to BRAKE CONTROL \(DIAGNOSTICS\)>Basic Diagnostic Procedure.](#)

2. SYSTEM BLOCK DIAGRAM

For system block diagram, refer to "System Block Diagram" in "BRAKE CONTROL (DIAGNOSTICS)". [🔍 Ref. to BRAKE CONTROL \(DIAGNOSTICS\)>General Description>SYSTEM BLOCK DIAGRAM.](#)

VEHICLE DYNAMICS CONTROL (VDC) > Vehicle Dynamics Control System

NOTE

For operation procedures of components of the vehicle dynamics control system, refer to the sections below.

Note:

For the CAN communication system, refer to the LAN system. [🔍 Ref. to LAN SYSTEM \(DIAGNOSTICS\)>Electrical Component Location.](#)

- VDC control module & hydraulic control unit (VDCCM&H/U): [🔍 Ref. to VEHICLE DYNAMICS CONTROL \(VDC\)>VDC Control Module and Hydraulic Control Unit \(VDCCM&H/U\).](#)
- Yaw rate & G sensor: [🔍 Ref. to VEHICLE DYNAMICS CONTROL \(VDC\)>Yaw Rate and G Sensor.](#)
- Steering angle sensor: [🔍 Ref. to VEHICLE DYNAMICS CONTROL \(VDC\)>Steering Angle Sensor.](#)
- Front ABS wheel speed sensor: [🔍 Ref. to VEHICLE DYNAMICS CONTROL \(VDC\)>Front ABS Wheel Speed Sensor.](#)
- Rear ABS wheel speed sensor: [🔍 Ref. to VEHICLE DYNAMICS CONTROL \(VDC\)>Rear ABS Wheel Speed Sensor.](#)
- Front magnetic encoder: [🔍 Ref. to VEHICLE DYNAMICS CONTROL \(VDC\)>Front Magnetic Encoder.](#)
- Rear magnetic encoder: [🔍 Ref. to VEHICLE DYNAMICS CONTROL \(VDC\)>Rear Magnetic Encoder.](#)
- VDC OFF switch: [🔍 Ref. to VEHICLE DYNAMICS CONTROL \(VDC\)>VDC OFF Switch.](#)

REMOVAL



Caution:

- Avoid unnecessary removal of parts in order to prevent brake fluid leakage.
- When the VDC CM&H/U components are removed, be sure to perform the installation according to the installation procedures.  Ref. to [VEHICLE DYNAMICS CONTROL \(VDC\)>VDC Control Module and Hydraulic Control Unit \(VDCCM&H/U\)>INSTALLATION.](#)

1. Disconnect the ground terminal from battery sensor.  Ref. to [REPAIR CONTENTS>NOTE > BATTERY.](#)
2. Remove the hydraulic unit assembly VDC.

Caution:

- Do not pull on the harness when disconnecting the connector.
- Wrap the brake pipe with a vinyl bag so as not to spill the brake fluid on the painted surface of the vehicle body.
- If brake fluid is spilled on the painted surface of the vehicle body, wash it off immediately with water and wipe clean.

(1) Remove dirt from around the hydraulic unit assembly VDC.

(2) Pull up the lock lever (b) while pressing the lock button (a) to disconnect the hydraulic unit assembly VDC connector.

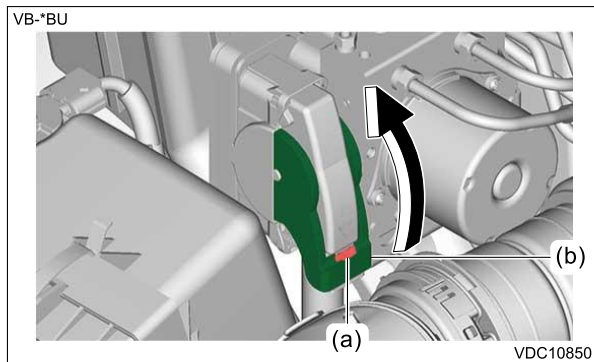

(3) Separate pipe assembly front ABS using a flare nut wrench.

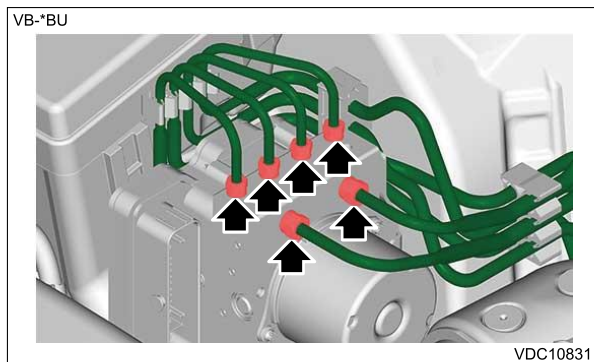

(4) Remove the bolts and nut, and then remove the following parts.

- Bracket COMPL hydraulic unit VDC
- Hydraulic unit assembly VDC

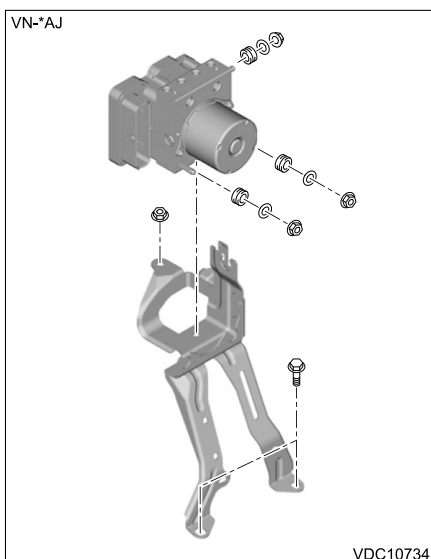

VEHICLE DYNAMICS CONTROL (VDC) > VDC Control Module and Hydraulic Control Unit (VDC CM&H/U)

INSTALLATION

Caution:

- When installing the VDC CM&H/U to the VDC CM&H/U bracket, make sure that there is no oil adhered to the nuts and the threads of VDC CM&H/U. If the oil is adhered, degrease it carefully before tightening.
- Connect the VDC CM&H/U connector securely.
- When the hydraulic unit assembly VDC has been replaced, be sure to perform the module registration.

1. Install the bracket COMPL hydraulic unit VDC and the hydraulic unit assembly VDC.

(1) Attach the bracket COMPL hydraulic unit VDC.

Tightening torque:

33 N·m (3.4 kgf-m, 24.3 ft-lb)

(2) Using a new damper, washers, and nuts, install the hydraulic unit assembly VDC to the bracket COMPL hydraulic unit VDC.

Tightening torque:

7.5 N·m (0.8 kgf-m, 5.5 ft-lb)

(3) Install the pipe assembly front ABS using a flare nut wrench and a crowfoot wrench.

Note:

If the work can be performed with the front and back sides reversed, it is also possible to use a 6-point crowfoot wrench.

Tightening torque:

Calculation formula
$T1 = 15 \text{ N}\cdot\text{m} (1.5 \text{ kgf}\cdot\text{m}, 11.1 \text{ ft}\cdot\text{lb}) \times L1 / (L1 + L2)$
$T2 = 19 \text{ N}\cdot\text{m} (1.9 \text{ kgf}\cdot\text{m}, 14.0 \text{ ft}\cdot\text{lb}) \times L1 / (L1 + L2)$
T: Reading of the torque wrench
L1: Effective length of the torque wrench
L2: Effective length of the crowfoot wrench

Note:

If the effective length of the tool used is unknown, consult the manufacturer of the tool.

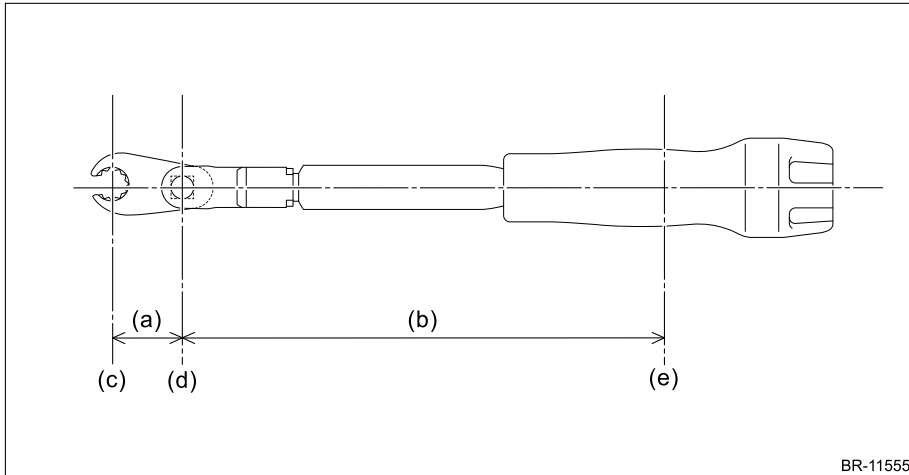

- (a) Effective length of the crowfoot wrench (L2)
- (b) Effective length of the torque wrench (L1)
- (c) Center of the open end of crowfoot wrench
- (d) Center of drive square of the torque wrench
- (e) Center of the position where a force is applied by hand

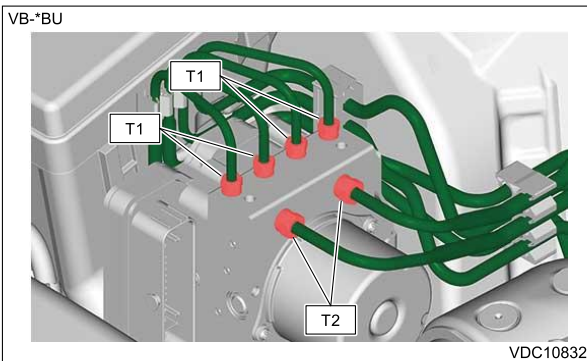

(4) Connect the hydraulic unit assembly VDC connector.

- 2. Connect the ground terminal to battery sensor. [Ref. to REPAIR CONTENTS>NOTE > BATTERY.](#)
- 3. Bleed air from the brake system. [Ref. to BRAKE>Air Bleeding>PROCEDURE.](#)
- 4. Using the Subaru Select Monitor, perform parameter confirmation, selection, and registration.

Note:

- When the VDC CM&H/U is replaced, be sure to perform the parameter selection/registration and the module registration.
- When the registration has not been performed, the DTC code [SELECTED PARAMETER] is detected together with the ABS/EBD/VDC warning light illumination.

- (1) Check that the applied model and grade of the relevant vehicle are included. [Ref. to VEHICLE DYNAMICS CONTROL \(VDC\)>VDC Control Module and Hydraulic Control Unit \(VDCCM&H/U\)>MAINTENANCE MODE > VDCCM PARAMETER CHECK.](#)
- (2) If the applied model and grade of the target vehicle are not included, perform "parameter selection and registration". [Ref. to VEHICLE DYNAMICS CONTROL \(VDC\)>VDC Control Module and Hydraulic Control Unit \(VDCCM&H/U\)>MAINTENANCE MODE > VDCCM PARAMETER SELECTION.](#)
- (3) When the hydraulic unit assembly VDC is replaced, perform the module registration. [Ref. to COMMON \(DIAGNOSTICS\)>Unit Registration>OPERATION.](#)
- 5. Perform "VDC sensor midpoint setting mode". [Ref. to VEHICLE DYNAMICS CONTROL \(VDC\)>VDC Control Module and Hydraulic Control Unit \(VDCCM&H/U\)>ADJUSTMENT > VDC SENSOR MIDPOINT SETTING MODE.](#)

VEHICLE DYNAMICS CONTROL (VDC) > VDC Control Module and Hydraulic Control Unit (VDCCM&H/U)

INSPECTION

- 1. Check the identification (a) of the VDC CM&H/U.

Note:

For the identification, refer to "SPECIFICATION" in "General Description".  Ref. to [VEHICLE DYNAMICS CONTROL \(VDC\)>General Description>SPECIFICATION.](#)

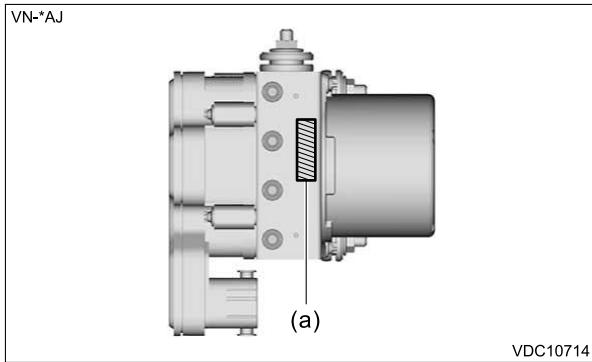

2. Check the condition of connection and settlement of connector, and correct or replace if defective.

1. CHECKING THE HYDRAULIC UNIT ABS OPERATION BY PRESSURE GAUGE

1. Remove the wheels.  Ref. to [WHEEL AND TIRE SYSTEM>Tire and Wheel>REMOVAL.](#)
2. Remove the bleeder screws from the front LH and front RH caliper bodies.
3. Connect two pressure gauges to front LH and front RH caliper bodies.

Caution:

- Use a pressure gauge used exclusively for brake fluid measurement.
- Do not use the pressure gauge used for the measurement of transmission oil pressure. Doing so will cause the piston seal to expand and deform.

Note:

Wrap sealing tape around the pressure gauge.

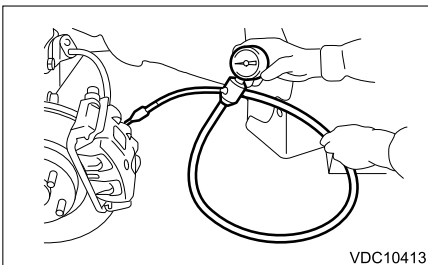

4. Bleed air from the pressure gauges and the front LH and front RH caliper bodies.
5. Perform ABS sequence control.  Ref. to [VEHICLE DYNAMICS CONTROL \(VDC\)>ABS Sequence Control.](#)

Note:

When the hydraulic unit begins to work, first the front LH side performs decompression, hold and compression, and then the front RH side performs decompression, hold and compression.

6. Read values indicated on the pressure gauge and check if the fluctuation of the values between decompression and compression meets the standard values. Depress the brake pedal and check that the kick-back is normal, and tightness is normal.

Inspection conditions	Front wheel	Rear wheel
Initial value	3,500 kPa (36 kgf/cm ² , 511 psi)	3,500 kPa (36 kgf/cm ² , 511 psi)
When depressurized	500 kPa (5 kgf/cm ² , 73 psi) or less	500 kPa (5 kgf/cm ² , 73 psi) or less
When pressurized	3,500 kPa (36 kgf/cm ² , 511 psi) or more	3,500 kPa (36 kgf/cm ² , 511 psi) or more

7. Remove the pressure gauge from the front LH and front RH caliper bodies.
8. Install the bleeder screws of the front LH and front RH caliper bodies.

9. Remove the bleeder screws from the rear LH and rear RH caliper bodies.
10. Connect two pressure gauges to rear LH and rear RH caliper bodies.
11. Bleed air from the pressure gauges and the rear LH and rear RH caliper bodies.
12. Perform ABS sequence control. [Ref. to VEHICLE DYNAMICS CONTROL \(VDC\)>ABS Sequence Control.](#)

Note:

When the hydraulic unit begins to work, first the rear RH side performs decompression, hold and compression, and then the rear LH side performs decompression, hold and compression.

13. Read values indicated on the pressure gauge and check if the fluctuation of the values between decompression and compression meets specification. Depress the brake pedal and check that the kick-back is normal, and tightness is normal.
14. Remove the pressure gauge from the rear LH and rear RH caliper bodies.
15. Install the bleeder screws of the rear LH and rear RH caliper bodies.
16. Bleed air from the brake system. [Ref. to BRAKE>Air Bleeding>PROCEDURE.](#)

2. CHECKING THE HYDRAULIC UNIT VDC OPERATION USING A PRESSURE GAUGE

1. Remove the wheels. [Ref. to WHEEL AND TIRE SYSTEM>Tire and Wheel>REMOVAL.](#)
2. Remove the bleeder screws from the front LH and front RH caliper bodies.
3. Connect two pressure gauges to front LH and front RH caliper bodies.

Caution:

- Use a pressure gauge used exclusively for brake fluid measurement.
- Do not use the pressure gauge used for the measurement of transmission oil pressure. Doing so will cause the piston seal to expand and deform.

Note:

Wrap sealing tape around the pressure gauge.

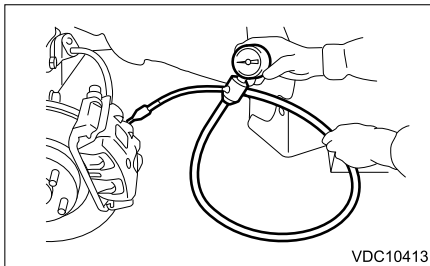

4. Bleed air from the pressure gauge.
5. Perform VDC sequence control. [Ref. to VEHICLE DYNAMICS CONTROL \(VDC\)>VDC Sequence Control.](#)

Note:

When the hydraulic unit begins to work, first the front LH side performs compression, hold and decompression, and then the front RH side performs compression, hold and decompression.

6. Read values indicated on the pressure gauge and check if the fluctuation of the values between decompression and compression meets specification. Depress the brake pedal and check that it is not abnormally hard, and tightness is normal.

Inspection conditions	Front wheel	Rear wheel
When pressurized	3,000 kPa (31 kgf/cm ² , 441 psi) or more	3,000 kPa (31 kgf/cm ² , 441 psi) or more
When depressurized	500 kPa (5 kgf/cm ² , 73 psi) or less	500 kPa (5 kgf/cm ² , 73 psi) or less

7. Remove the pressure gauge from the front LH and front RH caliper bodies.
8. Install the bleeder screws of the front LH and front RH caliper bodies.
9. Remove the bleeder screws from the rear LH and rear RH caliper bodies.
10. Connect two pressure gauges to rear LH and rear RH caliper bodies.
11. Bleed air from the pressure gauges and the rear LH and rear RH caliper bodies.
12. Perform VDC sequence control. [Ref. to VEHICLE DYNAMICS CONTROL \(VDC\)>VDC Sequence Control.](#)

Note:

When the hydraulic unit begins to work, first the rear RH side performs compression, hold and decompression, and then the rear LH side performs compression, hold and decompression.

13. Read the values indicated on the pressure gauges and check if it is within specification. Depress the brake pedal and check that it is not abnormally hard, and tightness is normal.
14. Remove the pressure gauge from the rear LH and rear RH caliper bodies.
15. Install the bleeder screws of the rear LH and rear RH caliper bodies.
16. Bleed air from the brake system.  [Ref. to BRAKE>Air Bleeding>PROCEDURE.](#)

VEHICLE DYNAMICS CONTROL (VDC) > VDC Control Module and Hydraulic Control Unit (VDCCM&H/U)

ADJUSTMENT

1. VDC SENSOR MIDPOINT SETTING MODE

After installing, replacing or adjusting the following parts, perform the VDC sensor midpoint setting mode.

- Steering angle sensor
- Steering wheel
- Suspension parts
- Wheel alignment
- VDC CM&H/U
- VDC CM&H/U bracket

1. Park the vehicle on a level surface, and set the steering wheel to the straight-ahead position.
2. Using the Subaru Select Monitor, display the following items in the [Data monitor] of [Brake Control].  [Ref. to COMMON \(DIAGNOSTICS\)>Data Monitor.](#)
 - [Steering Angle Sensor]
 - [Longitudinal G Sensor]
 - [Lateral G Sensor]
 - (1) Check the steer angle sensor output value.

Specification:

 - Within range of $-10 - 10$ deg: Perform the VDC sensor 0 point setting mode.
 - Out of range of $-10 - 10$ deg: Check the steering wheel neutral position
 - (2) Check the output values for the longitudinal G sensor and lateral G sensor.

Specification:

 - Within range of $-2 - 2$ m/s²: Perform the VDC sensor 0 point setting mode.
 - Out of range of $-2 - 2$ m/s²: Check the installing condition of the VDC CM&H/U and VDC CM&H/U bracket.
3. Using Subaru Select Monitor, select [VSC(VDC) Centering Mode] in [Work Support] of [Brake Control], and perform the operation according to the display screen.  [Ref. to COMMON \(DIAGNOSTICS\)>Work Support.](#)
4. Drive the vehicle for 10 minutes, and check that there is no system malfunction or the warning light illumination while driving.
5. Make sure that the DTC is not stored.

VEHICLE DYNAMICS CONTROL (VDC) > VDC Control Module and Hydraulic Control Unit (VDCCM&H/U)

MAINTENANCE MODE

1. VDCCM PARAMETER READING

Note:

When the VDC CM&H/U is replaced with a replacement part, be sure to perform the parameter selection/registration to the VDC CM&H/U using the "VDCCM parameter selection" function.

1. Using the Subaru Select Monitor, select [Reading of parameter: ECM to SSM] in [Work Support] of [Brake Control].  [Ref. to COMMON \(DIAGNOSTICS\)>Work Support.](#)
2. Save and close the file.



2. VDCCM PARAMETER WRITING

1. Using the Subaru Select Monitor, select [Writing of parameter: SSM to ECM] in [Work Support] of [Brake Control].  [Ref. to COMMON \(DIAGNOSTICS\)>Work Support.](#)
2. Open the file saved in the [Reading of parameter: ECM to SSM].
3. When the confirmation screen indicating the vehicle information appears, check that the correct applied model and grade are displayed and click the [OK] button.

3. VDCCM PARAMETER SELECTION

Note:

- When the VDC CM&H/U is replaced with a replacement part, be sure to perform the parameter selection/registration to the VDC CM&H/U using this function.
- To check the applied model, refer to the "Model number plate" attached to the vehicle.  [Ref. to IDENTIFICATION.](#)
- If you entered a wrong applied model, you can re-write it.
- When the registration has not been performed, the DTC code [SELECTED PARAMETER] is detected together with the ABS/EBD/VDC warning light illumination.
- This function can be used for the replacement part of VDC CM&H/U.

1. Using the Subaru Select Monitor, select [Selection of Parameter] in [Work Support] of [Brake Control].  [Ref. to COMMON \(DIAGNOSTICS\)>Work Support.](#)
2. Check the applied model and option code indicated on the "Model number plate".  [Ref. to IDENTIFICATION.](#)
3. Enter the applied model (alphanumeric characters) and click the [OK] button.
4. When the option code input screen appears after entering the applied model, enter the option code (alphanumeric characters), and click the [OK] button.
5. When the confirmation screen indicating the vehicle information appears, check that the correct applied model and grade are displayed and click the [OK] button.

Note:



When the displayed applied model and grade are different from those of the vehicle, click the [OK] button and then perform the registration operation again.

6. Execute the Clear Memory Mode after parameter selection and registration operations because the DTC for "Parameter selection error" is memorized.  [Ref. to COMMON \(DIAGNOSTICS\)>Clear memory.](#)

4. VDCCM PARAMETER CHECK

Note:

The parameter data registered in the VDCCM is shown on the display.

1. Using the Subaru Select Monitor, select [Confirm on parameter] in [Work Support] of [Brake Control].  [Ref. to COMMON \(DIAGNOSTICS\)>Work Support.](#)
2. Check that the applied model and grade of the target vehicle are included, and click the [OK] button.
3. If the applied model and grade of the target vehicle are not included, perform "parameter selection and registration".  [Ref. to VEHICLE DYNAMICS CONTROL \(VDC\)>VDC Control Module and Hydraulic Control Unit \(VDCCM&H/U\)>MAINTENANCE MODE > VDCCM PARAMETER SELECTION.](#)

OPERATION

1. ABS SEQUENCE CONTROL WITH SUBARU SELECT MONITOR

Note:

- While the ABS sequence control is being performed, the operation of the hydraulic unit can be checked using the brake tester or pressure gauge after the hydraulic unit solenoid valve operation.
- ABS sequence control can be started by the Subaru Select Monitor.
- In the event of any trouble, the ABS sequence control will not operate.

1. Using the Subaru Select Monitor, select [ABS Sequence Control Mode] in [Work Support] of [Brake Control].  Ref. to COMMON (DIAGNOSTICS)>Work Support.
2. Perform the following operations according to the display screen.
 - (1) When using a brake tester, depress the brake pedal with a force of 100 N (10.2 kgf, 22.5 lbf).
 - (2) When using a pressure gauge, press the brake pedal so that the pressure gauge indicates 3,500 kPa (36 kgf/cm², 511 psi).
3. The brake system being operated is displayed on the Subaru Select Monitor.

2. CONDITIONS FOR ABS SEQUENCE CONTROL

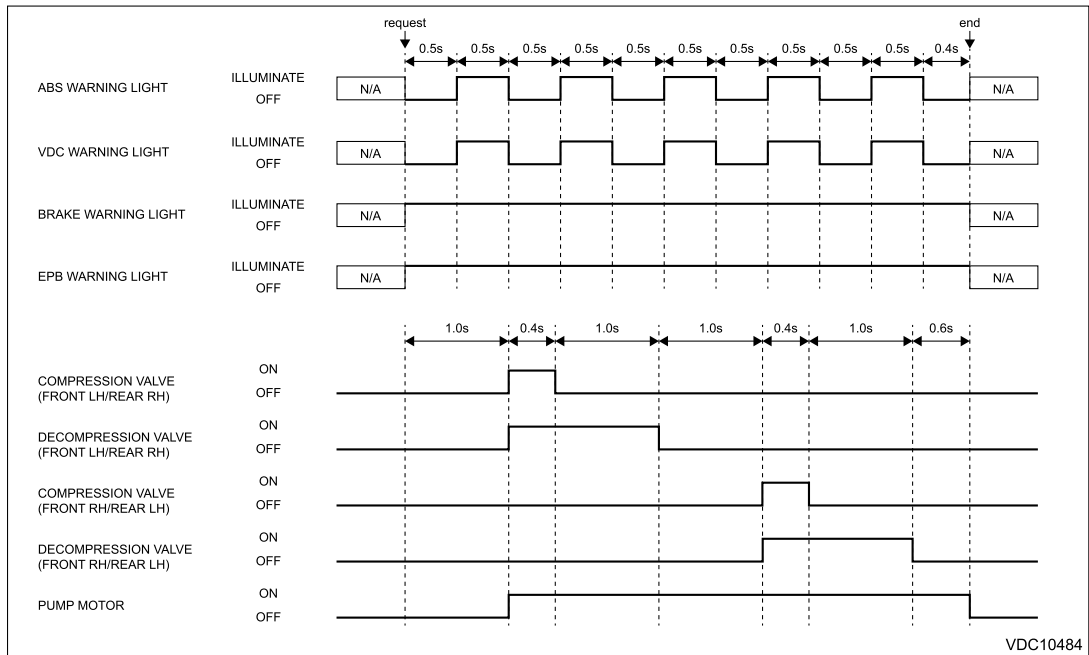

SPECIFICATION

1. CONDITIONS FOR COMPLETION OF ABS SEQUENCE CONTROL

When the following conditions develop, the ABS sequence control stops and ABS operation is returned to the normal control mode.

- When the speed of at least one wheel reaches 10 km/h (6 MPH).
- When the brake pedal is released during ABS sequence control and the stop light switch becomes OFF.
- After completion of ABS sequence control.
- When a malfunction is detected.

OPERATION

1. VDC SEQUENCE CONTROL WITH SUBARU SELECT MONITOR

Note:

- While the VDC sequence control is performed, the operation of the hydraulic unit can be checked using the brake tester or pressure gauge after the hydraulic unit solenoid valve is operated.
- VDC sequence control can be started by Subaru Select Monitor.
- In the event of any trouble, sequence control will not operate.

1. Using the Subaru Select Monitor, select [VDC Check Mode] in [Work Support] of [Brake Control]. [📄 Ref. to COMMON \(DIAGNOSTICS\)>Work Support.](#)
2. Perform the operation according to the display screen.
3. The brake system being operated is displayed on the Subaru Select Monitor.

2. CONDITIONS FOR VDC SEQUENCE CONTROL

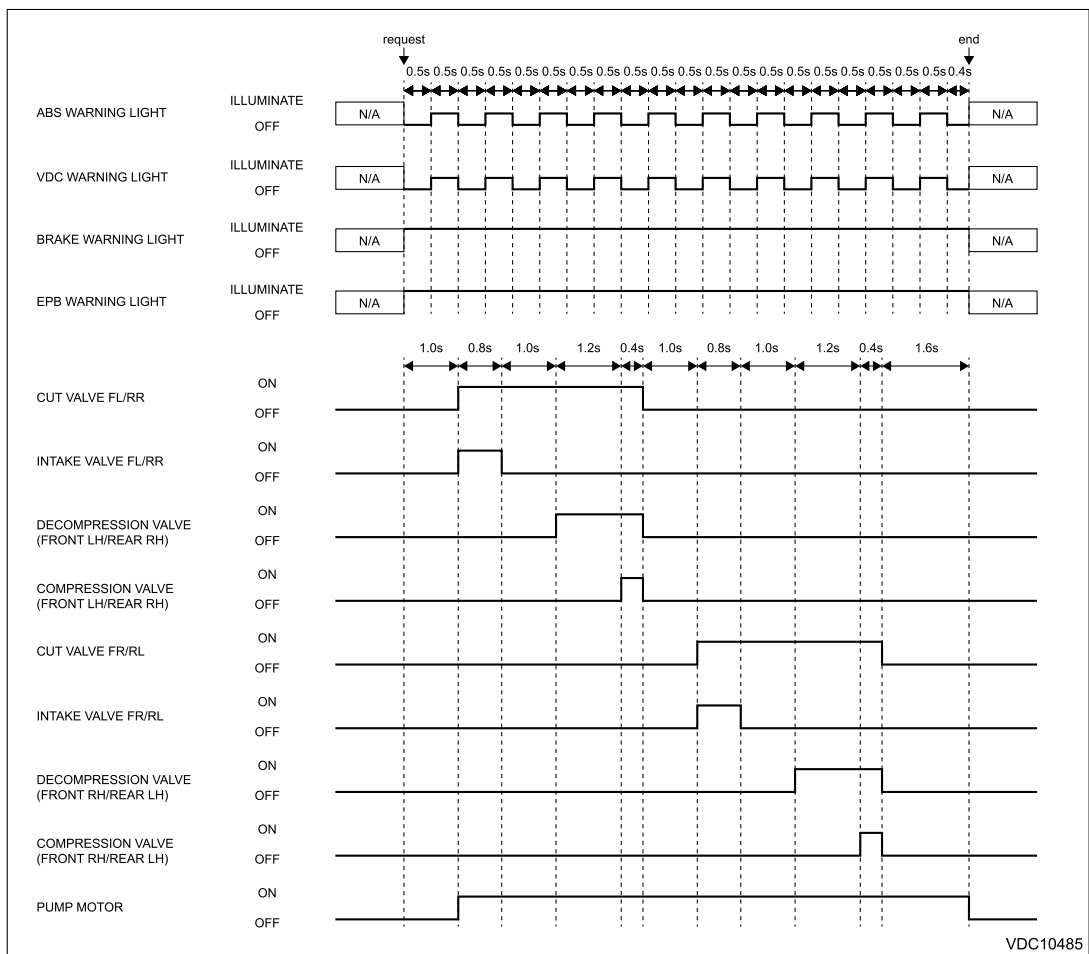

SPECIFICATION

1. CONDITIONS FOR COMPLETION OF VDC SEQUENCE CONTROL

When the following conditions develop, the VDC sequence control stops and VDC operation is returned to the normal control mode.

- When the speed of at least one wheel reaches 10 km/h (6 MPH).
- After completion of VDC sequence control.
- When a malfunction is detected.

VEHICLE DYNAMICS CONTROL (VDC) > Brake Lamp Relay

NOTE

For brake light relay, refer to "Relay and Fuse".  [Ref. to VEHICLE DYNAMICS CONTROL \(VDC\)>Relay and Fuse.](#)

VEHICLE DYNAMICS CONTROL (VDC) > Brake Lamp Relay

OPERATION

1. BRAKE LIGHT LIGHTING OPERATION BY SUBARU SELECT MONITOR

Caution:

Performing brake light relay compulsory operation may cause the EyeSight warning light to illuminate. If the brake light relay compulsory operation is performed, refer to "Basic Diagnostic Procedure" of "EyeSight (DIAGNOSTICS)" and check DTCs and then clear memory.  [Ref. to EyeSight \(DIAGNOSTICS\)>Basic Diagnostic Procedure.](#)

1. Using the Subaru Select Monitor, select [Brake Lamp Lighting Operation] in [Work Support] of [Brake Control].  [Ref. to COMMON \(DIAGNOSTICS\)>Work Support.](#)

Note:

In the event of any trouble, brake light lighting operation will not function.

2. Perform the operation according to the display screen.

VEHICLE DYNAMICS CONTROL (VDC) > Brake Lamp Relay

SPECIFICATION

1. CONDITIONS TO COMPLETE BRAKE LIGHT LIGHTING OPERATION

When the following conditions develop, the brake light lighting operation stops and the normal control mode is restored.

- When the speed of at least one wheel reaches 10 km/h (6 MPH).
- When brake light lighting operation ends.
- When a malfunction is detected.

VEHICLE DYNAMICS CONTROL (VDC) > Yaw Rate and G Sensor

NOTE

Yaw rate & longitudinal G and lateral G sensors are integrated with VDC CM&H/U.

For operation procedures, refer to "VDC Control Module and Hydraulic Control Unit (VDCCM&H/U)".  [Ref. to VEHICLE DYNAMICS CONTROL \(VDC\)>VDC Control Module and Hydraulic Control Unit \(VDCCM&H/U\).](#)

VEHICLE DYNAMICS CONTROL (VDC) > Yaw Rate and G Sensor

INSPECTION

1. YAW RATE & LONGITUDINAL G AND LATERAL G SENSOR SIGNAL

1. CHECK YAW RATE & G SENSOR.

1. Check the installing condition of the hydraulic unit assembly VDC.
2. Turn the ignition switch to ON.
3. Using the Subaru Select Monitor, display the following items in the [Data monitor] of [Brake Control].  [Ref. to COMMON \(DIAGNOSTICS\)>Data Monitor.](#)
 - [Yaw Rate Sensor]
 - [Longitudinal G Sensor]
 - [Lateral G Sensor]
4. Read the output of [Yaw Rate Sensor], [Longitudinal G Sensor] and [Lateral G Sensor].

When the vehicle is placed horizontally, are the displayed values $-1.5 - 1.5 \text{ m/s}^2$ for longitudinal G and lateral G sensor, and $-4 - 4 \text{ deg/s}$ for yaw rate sensor?

Yes

 [Go to 2.](#)

No

Replace the hydraulic unit assembly VDC.  [Ref. to VEHICLE DYNAMICS CONTROL \(VDC\)>VDC Control Module and Hydraulic Control Unit \(VDCCM&H/U\).](#)

2. PERFORM DRIVING TEST.

Drive for approximately 10 minutes, and check that there is no system malfunction or the warning light illumination while driving.

Is there any abnormal movement or the warning light illumination while driving?

Yes

Perform the diagnosis according to DTCs for the VDC system.  [Ref. to BRAKE CONTROL \(DIAGNOSTICS\)>Diagnostic Trouble Code \(DTC\)>LIST.](#)

No

G sensor is normal.





VEHICLE DYNAMICS CONTROL (VDC) > Steering Angle Sensor

REMOVAL

Caution:

Before handling the airbag system components, refer to "CAUTION" of "General Description" in "AIRBAG SYSTEM".

 [Ref. to AIRBAG SYSTEM>General Description>CAUTION.](#)

1. Set the steering wheel to the straight-ahead position.
2. Disconnect the ground terminal from the battery sensor, and wait for at least 60 seconds before starting work.  [Ref. to REPAIR CONTENTS>NOTE > BATTERY.](#)
3. Remove the driver's airbag module.  [Ref. to AIRBAG SYSTEM>Driver's Airbag Module>REMOVAL.](#)
4. Remove the steering wheel assembly.  [Ref. to POWER ASSISTED SYSTEM \(POWER STEERING\)>Steering Wheel>REMOVAL.](#)
5. Remove the column cover assembly.  [Ref. to POWER ASSISTED SYSTEM \(POWER STEERING\)>Steering Column>REMOVAL.](#)
6. Remove the steering roll connector and the sensor assembly VDC steering.  [Ref. to AIRBAG SYSTEM>Roll Connector>REMOVAL.](#)

VEHICLE DYNAMICS CONTROL (VDC) > Steering Angle Sensor

INSTALLATION

Caution:

• Before handling the airbag system components, refer to "CAUTION" of "General Description" in "AIRBAG SYSTEM".

 [Ref. to AIRBAG SYSTEM>General Description>CAUTION.](#)

• When the sensor assembly VDC steering has been replaced, be sure to perform the module registration.

1. Install the sensor assembly VDC steering.
 - (1) When installing a new sensor assembly VDC steering, apply grease to the protrusion (a).

Caution:

Do not rotate the steering angle sensor protrusion.

Note:

If the steering angle sensor is reused, check the grease amount.

If grease is insufficient, additionally apply it.





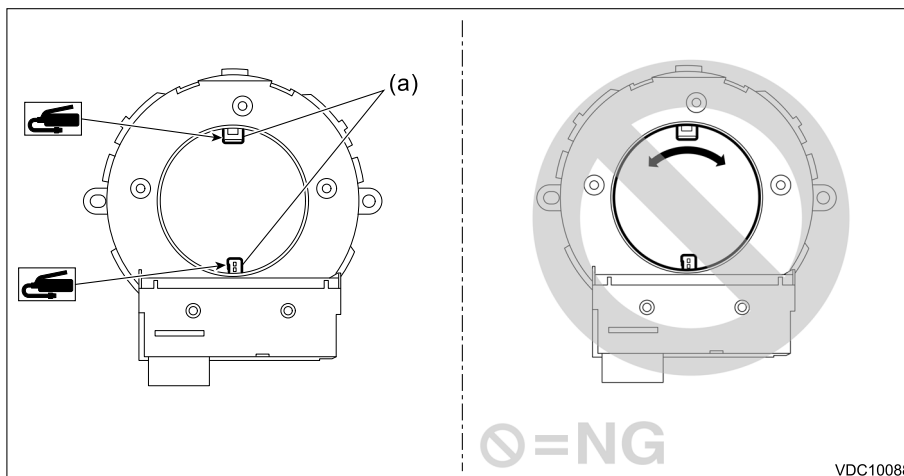

Preparation items:

Grease: An item contained in the steering angle sensor, KYODO YUSHI Multemp L or equivalent



(2) Align the center position of the steering roll connector.  [Ref. to AIRBAG SYSTEM>Roll Connector>ADJUSTMENT.](#)

(3) Align the position of the protrusion and install the sensor assembly VDC steering to the steering roll connector.

2. Install the steering roll connector assembly.
3. Connect the airbag connector.  [Ref. to AIRBAG SYSTEM>Airbag Connector>PROCEDURE > STEERING ROLL CONNECTOR.](#)
4. Install the column cover assembly.  [Ref. to POWER ASSISTED SYSTEM \(POWER STEERING\)>Steering Column>INSTALLATION.](#)
5. Install the steering wheel assembly.  [Ref. to POWER ASSISTED SYSTEM \(POWER STEERING\)>Steering Wheel>INSTALLATION.](#)
6. Install the driver's airbag module.  [Ref. to AIRBAG SYSTEM>Driver's Airbag Module>INSTALLATION.](#)
7. Connect the ground terminal to battery sensor.  [Ref. to REPAIR CONTENTS>NOTE > BATTERY.](#)
8. When the sensor assembly VDC steering has been replaced, perform the module registration.  [Ref. to COMMON \(DIAGNOSTICS\)>Unit Registration>OPERATION.](#)

9. Perform "VDC sensor midpoint setting mode".  Ref. to [VEHICLE DYNAMICS CONTROL \(VDC\)>VDC Control Module and Hydraulic Control Unit \(VDCCM&H/U\)>ADJUSTMENT > VDC SENSOR MIDPOINT SETTING MODE.](#)

REMOVAL



1. STANDARD DAMPER MODEL

1. Disconnect the ground terminal from battery sensor. Ref. to [REPAIR CONTENTS>NOTE > BATTERY](#).
2. Remove the front wheels. Ref. to [WHEEL AND TIRE SYSTEM>Tire and Wheel>REMOVAL](#).
3. Remove the sensor sub assembly front.

Caution:

- Be careful not to damage the sensor.
- Do not apply excessive force to the sensor harness.

(1) Disconnect the connector of the sensor sub assembly front in the engine compartment.

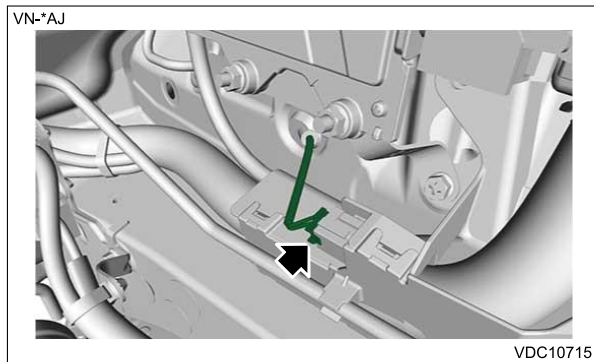

(2) Remove the bolts, the harness clip, and the grommet, and then remove the sensor sub assembly front.

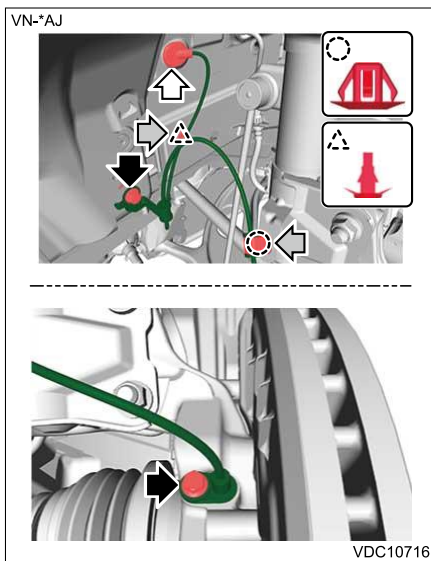

2. ELECTRONICALLY-CONTROLLED DAMPER MODEL

1. Disconnect the ground terminal from battery sensor. Ref. to [REPAIR CONTENTS>NOTE > BATTERY](#).
2. Remove the front wheels. Ref. to [WHEEL AND TIRE SYSTEM>Tire and Wheel>REMOVAL](#).
3. Remove the electric damper harness ABS assembly front.

Caution:

- Be careful not to damage the sensor.
- Do not apply excessive force to the sensor harness.

(1) Disconnect the connector of the electric damper harness ABS assembly front in the engine compartment.

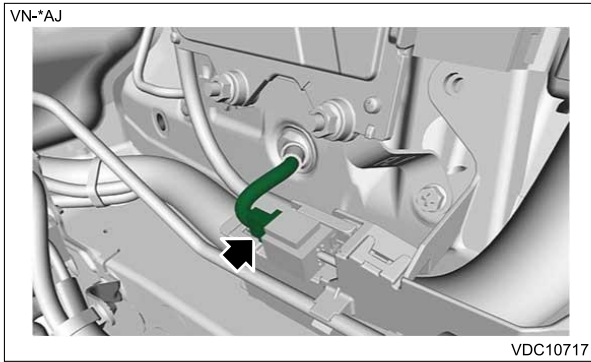

(2) Disconnect connectors.

(3) Remove the bolts, the harness clip, and the grommet, and remove the electric damper harness ABS assembly front.

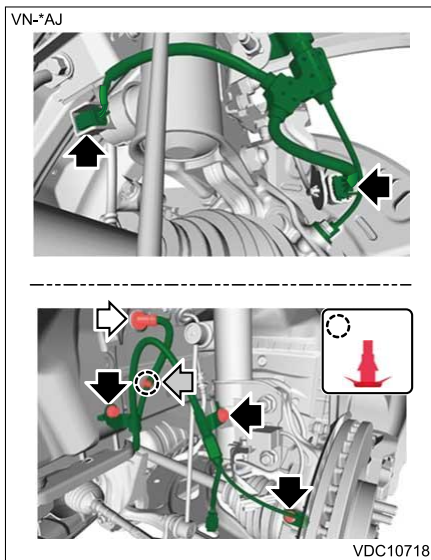

VEHICLE DYNAMICS CONTROL (VDC) > Front ABS Wheel Speed Sensor

INSTALLATION

1. STANDARD DAMPER MODEL

Caution:

- Be careful not to damage the sensor.
- Do not apply excessive force to the sensor harness.

Note:

Check the identification (mark) on the sensor harness to make sure there is no twisting. Ref. to [VEHICLE DYNAMICS CONTROL \(VDC\)>General Description>SPECIFICATION.](#)

1. Install the sensor sub assembly front.

Tightening torque:

Refer to "COMPONENT" of "General Description" for the tightening torque. Ref. to [VEHICLE DYNAMICS CONTROL \(VDC\)>General Description>COMPONENT > ABS WHEEL SPEED SENSOR.](#)

2. Connect the sensor sub assembly front connector.

3. Install the front wheels. Ref. to [WHEEL AND TIRE SYSTEM>Tire and Wheel>INSTALLATION.](#)

Note:

Check if the harness is not pulled and does not come in contact with the suspension or body while operating the steering.

4. Connect the ground terminal to battery sensor. Ref. to [REPAIR CONTENTS>NOTE > BATTERY.](#)

2. ELECTRONICALLY-CONTROLLED DAMPER MODEL

Caution:

- Be careful not to damage the sensor.
- Do not apply excessive force to the sensor harness.

Note:

Check the identification (mark) on the sensor harness to make sure there is no twisting.  [Ref. to VEHICLE DYNAMICS CONTROL \(VDC\)>General Description>SPECIFICATION.](#)

1. Install the electric damper harness ABS assembly front.

Tightening torque:

Refer to "COMPONENT" of "General Description" for the tightening torque.  [Ref. to VEHICLE DYNAMICS CONTROL \(VDC\)>General Description>COMPONENT > ABS WHEEL SPEED SENSOR.](#)



2. Connect each connector of the electric damper harness ABS assembly front.
3. Install the front wheels.  [Ref. to WHEEL AND TIRE SYSTEM>Tire and Wheel>INSTALLATION.](#)

Note:

Check if the harness is not pulled and does not come in contact with the suspension or body while operating the steering.

4. Connect the ground terminal to battery sensor.  [Ref. to REPAIR CONTENTS>NOTE > BATTERY.](#)

VEHICLE DYNAMICS CONTROL (VDC) > Front ABS Wheel Speed Sensor**INSPECTION****1. CHECK WITH SUBARU SELECT MONITOR**

1. Using the Subaru Select Monitor, display the following items in the [Data monitor] of [Brake Control].  [Ref. to COMMON \(DIAGNOSTICS\)>Data Monitor.](#)
 - [FR Wheel Speed]
 - [FL Wheel Speed]
2. Check if the speed indicated on the display changes in the same manner as the speedometer reading during acceleration/deceleration when the steering wheel is in the straight-ahead position.
3. If the speed indicated on the display does not change in the inspection, check the front ABS wheel speed sensor unit.  [Ref. to VEHICLE DYNAMICS CONTROL \(VDC\)>Front ABS Wheel Speed Sensor>INSPECTION > CHECK ABS WHEEL SPEED SENSOR UNIT.](#)

2. CHECK ABS WHEEL SPEED SENSOR UNIT

1. Visually check the tip of the front ABS wheel speed sensor for foreign particles or damage. If necessary, clean the tip or replace the front ABS wheel speed sensor.
2. Disconnect the front ABS wheel speed sensor connector.
3. Check the front ABS wheel speed sensor cable for discontinuity. If defective, replace the front ABS wheel speed sensor.
4. Connect a 12 V power supply to No. 1 terminal of front ABS wheel speed sensor connector, then attach resistance to the No. 2 terminal. Rotate the wheel at about 3 km/h (2 MPH), and measure the voltage using an oscilloscope.

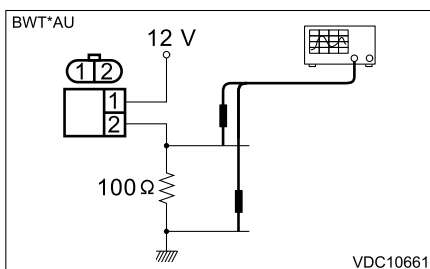

- Vehicle stopped state

Standard value of output voltage:

0.7 – 1.4 V

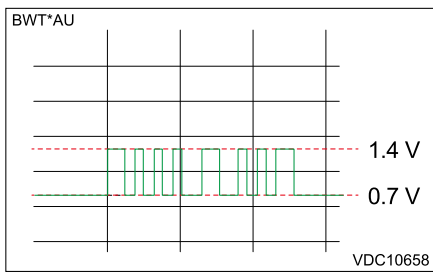

- Driving condition

Standard value of output voltage:

0.7 – 2.8 V

- Driving condition

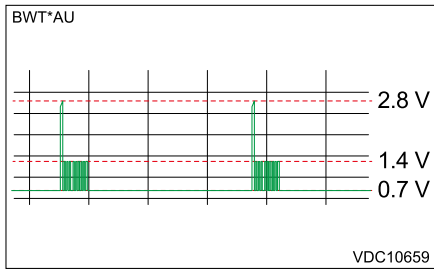

- Driving condition (enlarged view)

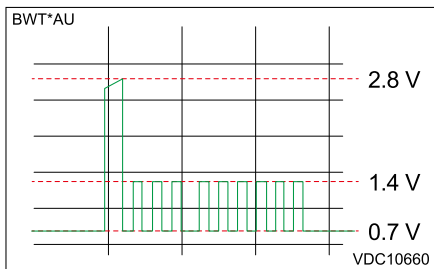

5. Replace the following parts if it is found defective.

- If the output voltage is out of the standard value: Replace the magnetic encoder (front hub unit bearing).
- If the output voltage is within standard value: Replace the hydraulic unit assembly VDC.

REMOVAL



1. STANDARD DAMPER MODEL

1. Disconnect the ground terminal from battery sensor. Ref. to [REPAIR CONTENTS>NOTE > BATTERY](#).
2. Remove the rear wheels. Ref. to [WHEEL AND TIRE SYSTEM>Tire and Wheel>REMOVAL](#).
3. Turn over the mud guard rear.
 - (1) Remove the clip.
 - Type A



- Type B

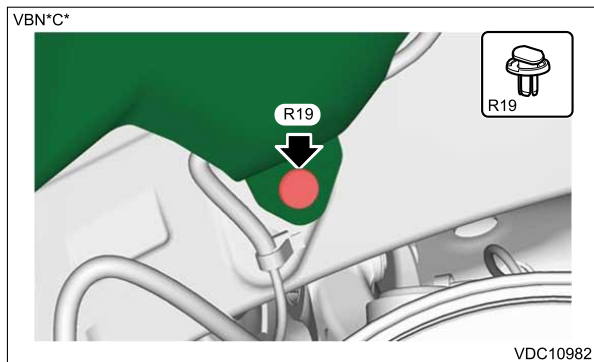

4. Remove the sensor sub assembly rear.

Caution:

- **Be careful not to damage the sensor.**
- **Do not apply excessive force to the sensor harness.**

- (1) Disconnect the sensor sub assembly rear connector.
- (2) Remove the bolt and harness clip, and remove the sensor sub assembly rear.

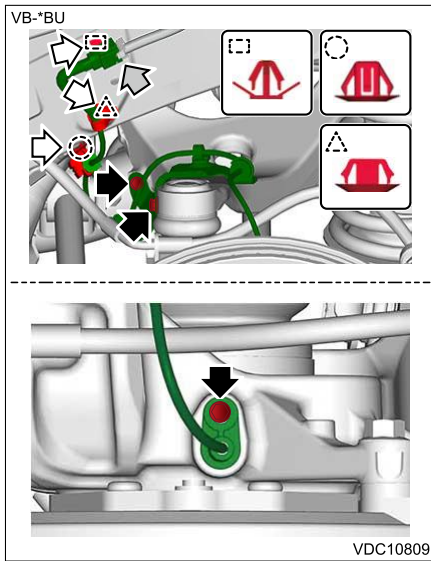

2. ELECTRONICALLY-CONTROLLED DAMPER MODEL

1. Disconnect the ground terminal from battery sensor. [Ref. to REPAIR CONTENTS>NOTE > BATTERY.](#)
2. Remove the rear wheels. [Ref. to WHEEL AND TIRE SYSTEM>Tire and Wheel>REMOVAL.](#)
3. Turn over the mud guard rear.
 - (1) Remove the clip.
 - (2) Turn over the mud guard rear.
 - Type A



- Type B

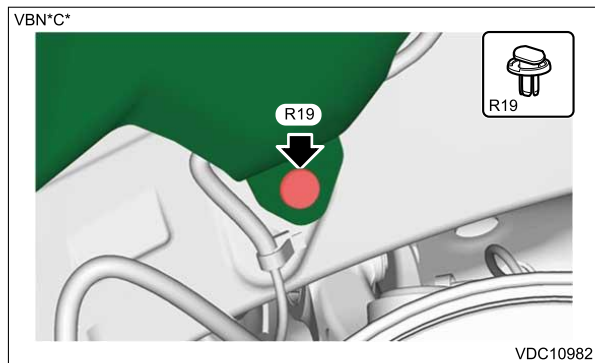

4. Remove the electric damper harness ABS assembly rear.

Caution:

- Be careful not to damage the sensor.
- Do not apply excessive force to the sensor harness.

- (1) Remove the connector and harness clip from the strut assembly.

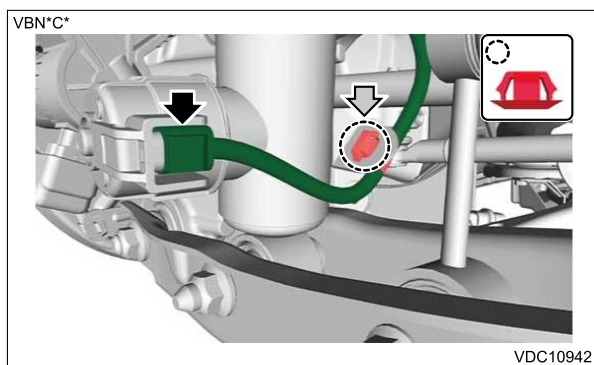

(2) Remove the bolt, connector and harness clip, and remove the electric damper harness ABS assembly rear.

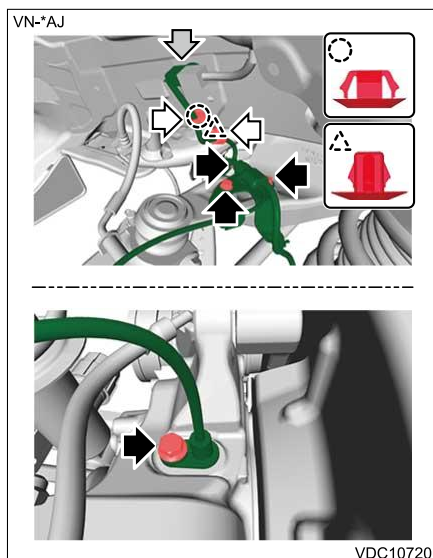

VEHICLE DYNAMICS CONTROL (VDC) > Rear ABS Wheel Speed Sensor

INSTALLATION

1. STANDARD DAMPER MODEL

Caution:

- Be careful not to damage the sensor.
- Do not apply excessive force to the sensor harness.

Note:

Check the identification (mark) on the sensor harness to make sure there is no twisting.  [Ref. to VEHICLE DYNAMICS CONTROL \(VDC\)>General Description>SPECIFICATION.](#)

1. Install the sensor sub assembly rear.

Tightening torque:

7.5 N·m (0.8 kgf·m, 5.5 ft·lb)

2. Connect the sensor sub assembly rear connector.

3. Install the mud guard rear.

4. Install the rear wheels.  [Ref. to WHEEL AND TIRE SYSTEM>Tire and Wheel>INSTALLATION.](#)

5. Connect the ground terminal to battery sensor.  [Ref. to REPAIR CONTENTS>NOTE > BATTERY.](#)

2. ELECTRONICALLY-CONTROLLED DAMPER MODEL

Caution:

- Be careful not to damage the sensor.
- Do not apply excessive force to the sensor harness.

Note:

Check the identification (mark) on the sensor harness to make sure there is no twisting.  [Ref. to VEHICLE DYNAMICS CONTROL \(VDC\)>General Description>SPECIFICATION.](#)

1. Install the electric damper harness ABS assembly rear.

Tightening torque:



7.5 N·m (0.8 kgf-m, 5.5 ft-lb)

2. Connect each connector of the electric damper harness ABS assembly rear.
3. Install the mud guard rear.
4. Install the rear wheels.  [Ref. to WHEEL AND TIRE SYSTEM>Tire and Wheel>INSTALLATION.](#)
5. Connect the ground terminal to battery sensor.  [Ref. to REPAIR CONTENTS>NOTE > BATTERY.](#)

VEHICLE DYNAMICS CONTROL (VDC) > Rear ABS Wheel Speed Sensor

INSPECTION

1. CHECK WITH SUBARU SELECT MONITOR

1. Using the Subaru Select Monitor, display the following items in the [Data monitor] of [Brake Control].  [Ref. to COMMON \(DIAGNOSTICS\)>Data Monitor.](#)
 - [RR Wheel Speed]
 - [RL Wheel Speed]
2. Check if the speed indicated on the display changes in the same manner as the speedometer reading during acceleration/deceleration when the steering wheel is in the straight-ahead position.
3. If the speed indicated on the display does not change in the inspection, check the rear ABS wheel speed sensor unit.  [Ref. to VEHICLE DYNAMICS CONTROL \(VDC\)>Rear ABS Wheel Speed Sensor>INSPECTION > CHECK ABS WHEEL SPEED SENSOR UNIT.](#)

2. CHECK ABS WHEEL SPEED SENSOR UNIT

1. Visually check the tip of the rear ABS wheel speed sensor for foreign particles or damage. If necessary, clean the tip or replace the rear ABS wheel speed sensor.
2. Disconnect the connector from the rear ABS wheel speed sensor.
3. Check the rear ABS wheel speed sensor cable for discontinuity. If defective, replace the rear ABS wheel speed sensor.
4. Connect a 12 V power supply to No. 1 terminal of rear ABS wheel speed sensor connector, then attach resistance to the No. 2 terminal. Rotate the wheel at about 2.75 km/h (2 MPH), and measure the voltage using an oscilloscope.

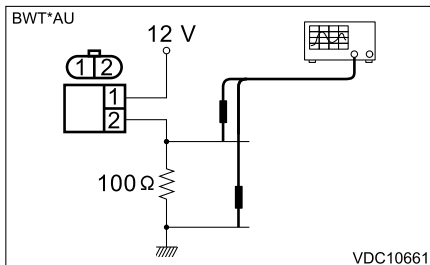

- Vehicle stopped state

Standard value of output voltage:

0.7 – 1.4 V

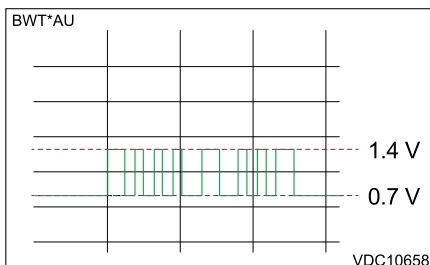

- Driving condition

Standard value of output voltage:

0.7 – 2.8 V

- Driving condition

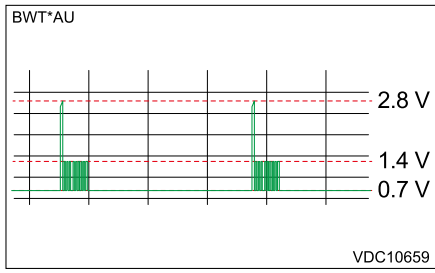

- Driving condition (enlarged view)

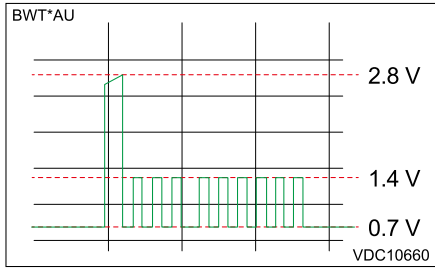

5. Replace the following parts if it is found defective.

- If the output voltage is out of the standard value: Replace the magnetic encoder (rear hub unit bearing).
- If the output voltage is within standard value: Replace the hydraulic unit assembly VDC.

VEHICLE DYNAMICS CONTROL (VDC) > Front Magnetic Encoder

NOTE

The front magnetic encoder is integrated with the front hub unit bearing.

For operation procedures, refer to "Front Hub Unit Bearing" in "PROPELLER SHAFT / DRIVE SHAFT / AXLE" section.  [Ref. to PROPELLER SHAFT / DRIVE SHAFT / AXLE>Front Hub Unit Bearing.](#)

VEHICLE DYNAMICS CONTROL (VDC) > Front Magnetic Encoder

INSPECTION

Visually check the front magnetic encoder for any damage. If necessary, replace with a new front hub unit bearing.

Note:

Because the front magnetic encoder is integrated with the front hub unit bearing, replace the front hub unit bearing with a new part if there is any defect found on the front magnetic encoder.

VEHICLE DYNAMICS CONTROL (VDC) > Rear Magnetic Encoder

NOTE

The rear magnetic encoder is integrated with the rear hub unit bearing.

For operation procedures, refer to "Rear Hub Unit Bearing" in "PROPELLER SHAFT / DRIVE SHAFT / AXLE" section.  [Ref. to PROPELLER SHAFT / DRIVE SHAFT / AXLE>Rear Hub Unit Bearing.](#)

VEHICLE DYNAMICS CONTROL (VDC) > Rear Magnetic Encoder

INSPECTION

Visually check the rear magnetic encoder for any damage. If necessary, replace with a new rear hub unit bearing.

Note:

Because the rear magnetic encoder is integrated with rear hub unit bearing, replace the rear hub unit bearing with a new part if there is any defect found on the rear magnetic encoder.

VEHICLE DYNAMICS CONTROL (VDC) > VDC OFF Switch

REMOVAL

Caution:
 Before handling the airbag system components, refer to "CAUTION" of "General Description" in "AIRBAG SYSTEM".
[Ref. to AIRBAG SYSTEM>General Description>CAUTION.](#)

1. Disconnect the ground terminal from the battery sensor, and wait for at least 60 seconds before starting work. [Ref. to REPAIR CONTENTS>NOTE > BATTERY.](#)
2. Remove the cover LWR driver. [Ref. to EXTERIOR/INTERIOR TRIM>Instrument Panel Lower Cover>REMOVAL.](#)
3. Release the claws and remove the VDC OFF switch (e).

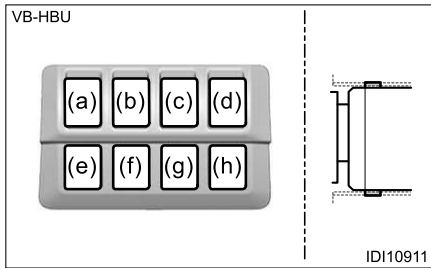

VEHICLE DYNAMICS CONTROL (VDC) > VDC OFF Switch

INSTALLATION

Caution:
 Before handling the airbag system components, refer to "CAUTION" of "General Description" in "AIRBAG SYSTEM".
[Ref. to AIRBAG SYSTEM>General Description>CAUTION.](#)

1. Install the VDC OFF switch.
2. Install the cover LWR driver. [Ref. to EXTERIOR/INTERIOR TRIM>Instrument Panel Lower Cover>INSTALLATION.](#)
3. Connect the ground terminal to battery sensor. [Ref. to REPAIR CONTENTS>NOTE > BATTERY.](#)

VEHICLE DYNAMICS CONTROL (VDC) > VDC OFF Switch

INSPECTION

1. Measure the resistance between the VDC OFF switch terminals.

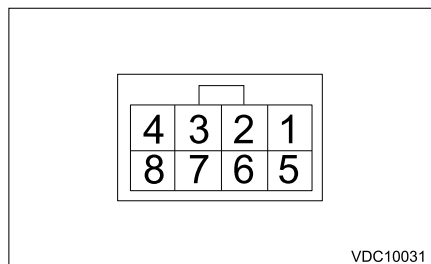

Terminal No.	Inspection conditions	Standard
6 – 8	Switch OFF	1 MΩ or more
	Switch ON	Less than 1 Ω

2. Apply battery voltage between the connector terminals to check lighting condition of illumination inside the switch.

Caution:
 When applying battery voltage, do not mix up the positive (+) side and the negative (-) side.
 Incorrect polarity connection may cause LED damage inside the switch.

Terminals No.	Inspection conditions	Specification
1 (+) – 4 (-)	Apply battery voltage.	Light ON

3. Replace the VDC OFF switch if it is found defective.

VEHICLE DYNAMICS CONTROL (VDC) > General Diagnostic Table

INSPECTION

For general diagnostic table, refer to "General Diagnostic Table" of "BRAKE CONTROL (DIAGNOSTICS)" section.  [Ref. to BRAKE CONTROL \(DIAGNOSTICS\)>General Diagnostic Table>INSPECTION.](#)

-
1. General Description
 2. Front Brake Pad
 3. Front Disc Rotor
 4. Front Disc Brake Assembly
 5. Rear Brake Pad
 6. Rear Disc Rotor
 7. Rear Disc Brake Assembly
 8. Master Cylinder
 9. Brake Booster
 10. Brake Fluid
 11. Air Bleeding
 12. Brake Hose
 13. Brake Pipe
 14. Brake Pedal
 15. Stop Light Switch
 16. Brake Vacuum Pump
 17. General Diagnostic Table

BRAKE > General Description

CAUTION

- When performing service operation, refer to "Repair Contents" in "General Description". [🔗 Ref. to REPAIR CONTENTS>Repair Contents.](#)
- When performing any work, always wear work clothes, a work cap and protective shoes. Additionally, wear a helmet, protective goggles, etc. if necessary.
- When performing a repair, identify the cause of trouble and avoid unnecessary removal, disassembly and replacement.
- Some vehicle components are extremely hot immediately after driving. Be wary of receiving burns from heated parts.
- Use SUBARU genuine grease, the recommended or equivalent. Do not mix grease etc. of different grades or manufacturers.
- Apply grease onto sliding or revolving surfaces before installation.
- Be sure that the surface of brake disc and brake pad is free from grease or oil.
- Do not secure a part in a vise directly. Place cushioning materials such as wood blocks, aluminum plates, or waste cloth between the part and the vise.
- When performing work on the sensors or modules, be careful of the following.
 - Before disconnecting electrical connectors, be sure to disconnect the ground terminal from the battery sensor. [🔗 Ref. to REPAIR CONTENTS>NOTE > BATTERY.](#)
 - Do not apply any impact. If the parts are accidentally dropped, replace with a new part.
 - Do not expose to high-temperature and humidity.
- Refer to "CAUTION" of "General Description" in "AIRBAG SYSTEM" section. [🔗 Ref. to AIRBAG SYSTEM>General Description>CAUTION.](#)
- Before starting works, remove dirt and corrosion around the target area.

BRAKE > General Description

SPECIFICATION

Note:

Refer to "SPECIFICATION" in "PARKING BRAKE" section for parking brake specifications. [🔗 Ref. to PARKING BRAKE>General Description>SPECIFICATION.](#)

1. FRONT DISC BRAKE

Item		Specification	
Size		17-inch	
Type		Floating 2-POT piston type Ventilated disc	
Effective cylinder diameter	mm (in)	40.4 (1.591)	
Pad dimension (Length × Width × Thickness)		117.8 × 50.5 × 11 (4.638 × 1.988 × 0.433)	
Pad thickness	mm (in)	Standard	11 (0.43)
		Limit	1.5 (0.059)
Effective disc diameter		265 (10.43)	
Rotor dimension (Outer diameter × Thickness)		316 × 28 (12.44 × 1.1)	
Disc thickness	mm (in)	Standard	28 (1.1)
		Limit	26 (1.02)
Disc runout	mm (in)	Standard	–
		Limit	0.05 (0.002)
Clearance adjustment		Automatic adjustment	

2. REAR DISC BRAKE

• EXCEPT FOR THE ELECTRONIC PARKING BRAKE MODEL

Item		Specification
Size		16-inch
Type		Floating 1-POT piston type Ventilated disc

Item		Specification	
Effective cylinder diameter	mm (in)	40.4 (1.591)	
Pad dimension (Length × Width × Thickness)	mm (in)	95.5 × 34.7 × 11 (3.76 × 1.37 × 0.433)	
Pad thickness	mm (in)	Standard	11 (0.43)
		Limit	1.5 (0.059)
Effective disc diameter	mm (in)	255 (10.04)	
Rotor dimension (Outer diameter × Thickness)	mm (in)	290 × 18 (11.42 × 0.71)	
Disc thickness	mm (in)	Standard	18 (0.71)
		Limit	16 (0.63)
Disc runout	mm (in)	Standard	–
		Limit	0.05 (0.002)
Clearance adjustment		Automatic adjustment	

● ELECTRONIC PARKING BRAKE MODEL

Item		Specification	
Size		17-inch	
Type		Floating 1-POT piston type (Caliper with electric parking) Ventilated disc	
Effective cylinder diameter	mm (in)	40 (1.575)	
Pad dimension (Length × Width × Thickness)	mm (in)	86.8 × 43.5 × 9 (3.417 × 1.713 × 0.354)	
Pad thickness	mm (in)	Standard	9 (0.354)
		Limit	1.5 (0.059)
Effective disc diameter	mm (in)	255 (10.04)	
Rotor dimension (Outer diameter × Thickness)	mm (in)	300 × 17 (11.81 × 0.67)	
Disc thickness	mm (in)	Standard	17 (0.67)
		Limit	15 (0.59)
Disc runout	mm (in)	Standard	–
		Limit	0.05 (0.002)
Clearance adjustment		Automatic adjustment	

3. MASTER CYLINDER

Item		Specification
Type		Tandem
Effective diameter	mm (in)	23.8 (0.94)
Reservoir type		Sealed type
Brake fluid reservoir capacity	cm ³ (cu in)	240 (14.64)

4. BRAKE BOOSTER

● EXCEPT FOR ELECTRIC BRAKE BOOSTER MODEL

Item		Specification	
Type		Vacuum suspended	
Effective diameter	mm (in)	208 + 229 (8.19 + 9.02)	
Brake fluid pressure		Brake pedal force N (kgf, lbf)	Fluid pressure kPa (kgf/cm ² , psi)
		147 (15, 33)	380 (3.8, 55)
When engine is stopped		294 (30, 66)	1,465 (14.9, 212)

Item	Specification	
When engine is running and vacuum pressure is at 93 kPa (697 mmHg, 27.47 inHg)	147 (15, 33)	9,218 (93.9, 1,336)
	294 (30, 66)	16,120 (164, 2,338)

• **ELECTRIC BRAKE BOOSTER MODEL**

Item	Specification	
Type	Electric brake booster pressure type	
Brake fluid pressure	Brake pedal force N (kgf, lbf)	Fluid pressure kPa (kgf/cm ² , psi)
When the electric brake booster is operated	200 (20.4, 45)	11,170 (113.9, 1,620)
	500 (51, 112.4)	13,220 (134.8, 1,917)

5. BRAKE LINE AND BRAKE PEDAL

Item		Specification
Brake line		Dual circuit system
Brake pedal	Type	Suspended type
	Free play mm (in)	0.5 – 2.7 (0.02 – 0.11) [When pulling the brake pedal upward with a force of less than 10 N (1 kgf, 2 lbf)]

6. BRAKE FLUID

Caution:

- **Do not let brake fluid come into contact with the painted surface of the vehicle. Wash away with water immediately and wipe off if it is spilled by accident.**
- **Do not mix different kinds of brake fluid.**
- **Do not allow water or foreign matter to enter the reservoir tank.**
- **Always use new brake fluid when replacing or refilling the brake fluid.**

Recommended and alternative materials	Capacity
• Recommended materials: FMVSS No. 116 DOT3, or DOT4	—

BRAKE > General Description

COMPONENT

1. FRONT DISC BRAKE

- | | |
|---------------------------------|----------------------------------|
| (1) Mounting bolt | (11) Pad clip |
| (2) Front axle housing | (12) Pad disc brake front outer |
| (3) Bleeder screw | (13) Shim disc brake front outer |
| (4) Bleeder cap | (14) Brake disc front |
| (5) Caliper body | (15) Support front disc brake |
| (6) Piston seal | (16) Pin boot |
| (7) Piston disc brake | (17) Slide pin bushing |
| (8) Boot piston | (18) Slide pin lock |
| (9) Shim disc brake front inner | (19) Slide pin |
| (10) Pad disc brake front inner | |

Tightening torque: N-m (kgf-m, ft-lb)

T1: 8 (0.8, 5.9)

T2: 27 (2.8, 19.9)

T3: 135 (13.8, 99.6)

2. REAR DISC BRAKE

- EXCEPT FOR THE ELECTRONIC PARKING BRAKE MODEL

- | | |
|--------------------------------|------------------------------|
| (1) Mounting bolt | (11) Pin boot |
| (2) Rear axle housing | (12) Slide pin lock |
| (3) Shim disc brake rear inner | (13) Slide pin bushing |
| (4) Pad disc brake rear inner | (14) Support rear disc brake |
| (5) Pad disc brake rear outer | (15) Pad clip |
| (6) Shim disc brake rear outer | (16) Brake disc rear |
| (7) Bleeder cap | (17) Plug |
| (8) Bleeder screw | (18) Boot piston |
| (9) Caliper body | (19) Piston disc brake |
| (10) Slide pin | (20) Piston seal |

Tightening torque: N-m (kgf-m, ft-lb)

T1: 8 (0.8, 5.9)

T2: 27 (2.8, 19.9)

T3: 73 (7.4, 53.8)

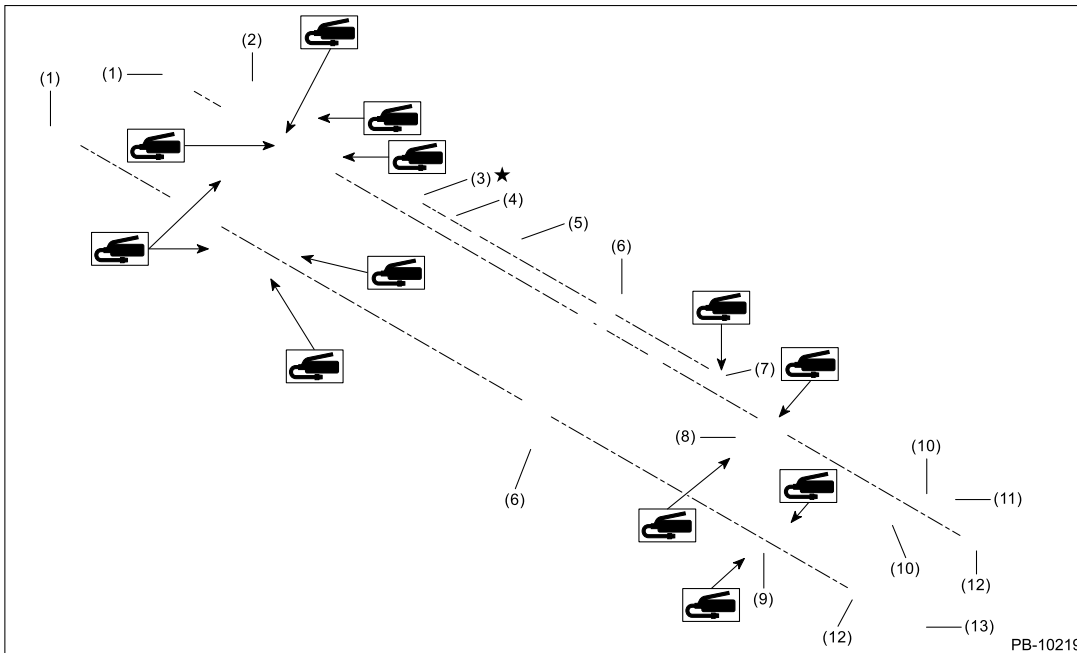

- | | | |
|---------------------------|-----------------------|-----------------|
| (1) Shoe set pin | (6) Brake shoe | (10) Spring A |
| (2) Rear brake back plate | (7) Parking lever pin | (11) Spring rod |

- | | | |
|-------------------|-------------------|------------------------|
| (3) Ring retainer | (8) Strut | (12) Spring shoe clamp |
| (4) Spring washer | (9) Adjuster ASSY | (13) Spring adjuster |
| (5) Parking lever | | |

● **ELECTRONIC PARKING BRAKE MODEL**

- | | | |
|---------------------------------|---------------------------|--|
| (1) Mounting bolt | (10) Pin boot A | Tightening torque: N·m (kgf-m, ft-lb)
T1: 8 (0.8, 5.9)
T2: 17 (1.7, 12.5)
T3: 25 (2.5, 18.4)
T4: 73 (7.4, 53.8) |
| (2) Rear axle housing | (11) Pin boot B | |
| (3) Support rear disc brake | (12) Guide pin rear brake | |
| (4) Pad COMPL inner | (13) Bleeder cap | |
| (5) Pad COMPL outer | (14) Bleeder screw | |
| (6) Brake disc rear | (15) Caliper body*2 | |
| (7) Parking brake actuator*1 *2 | (16) Pad clip | |
| (8) O-ring*2 | (17) Boot piston | |
| (9) Cap | | |

*1: Do not reuse it when the emergency release of parking brake was performed or when the actuator has a malfunction.

*2: When replacing the parking brake actuator or the caliper body, always replace the O-ring with the supplied new part.

3. MASTER CYLINDER

● **EXCEPT FOR ELECTRIC BRAKE BOOSTER MODEL**

- (1) Cap reservoir COMPL
- (2) Filter
- (3) Brake fluid caution label (for C0)
- (4) Reservoir tank
- (5) Seal reservoir
- (6) Cylinder seal ASSY
- (7) Master cylinder ASSY
- (8) Nut
- (9) Bracket harness
- (10) Pin
- (11) Level indicator

Tightening torque: N·m (kgf-m, ft-lb)

T: 13 (1.3, 9.6)

● **ELECTRIC BRAKE BOOSTER MODEL**

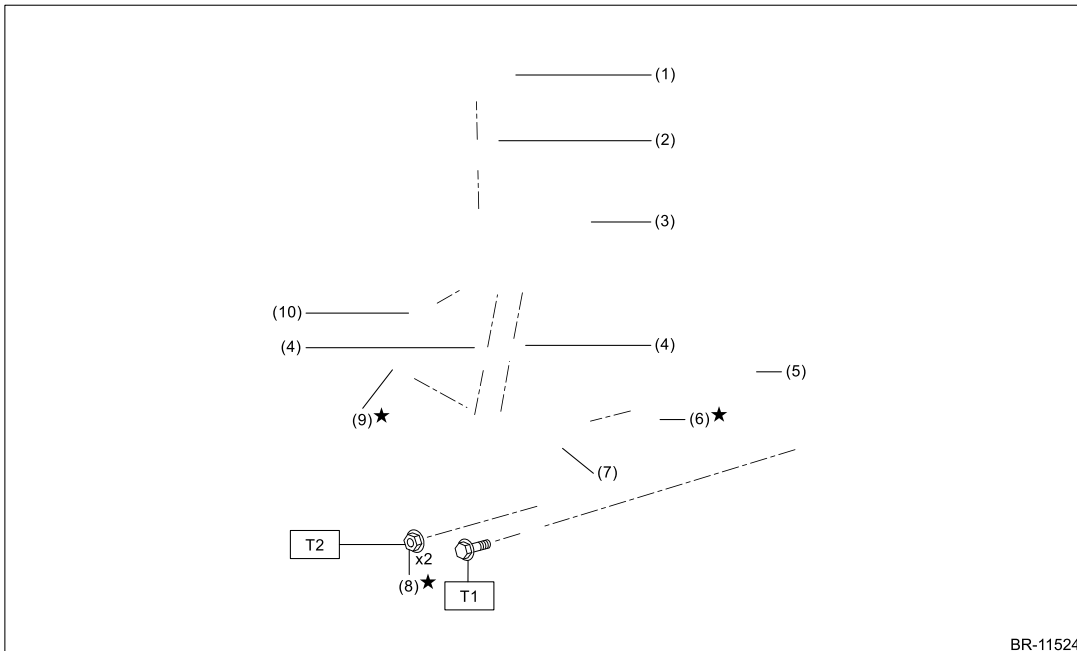

- (1) Cap reservoir COMPL
- (2) Filter
- (3) Reservoir tank
- (4) Seal reservoir
- (6) Cylinder seal ASSY
- (7) Master cylinder ASSY
- (8) Nut
- (9) Pin

Tightening torque: N·m (kgf-m, ft-lb)

T1: 18 (1.8, 13.3)

T2: 20 (2.0, 14.8)

(5) Bracket harness electric booster

(10) Level indicator

4. FRONT BRAKE PIPES AND HOSES

• EXCEPT FOR ELECTRIC BRAKE BOOSTER MODEL

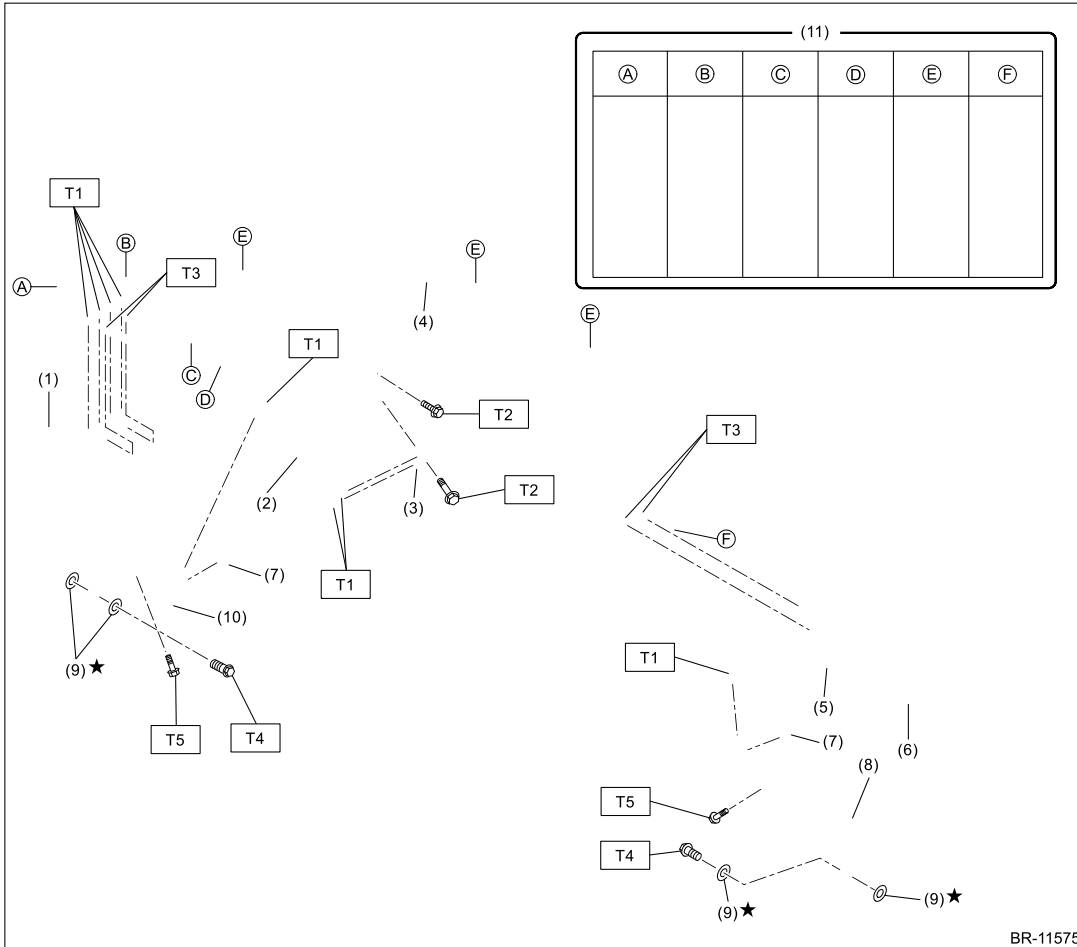

BR-11575

(1) Hydraulic unit ASSY VDC

(7) Clamp brake hose

Tightening torque: N·m (kgf-m, ft-lb)

(2) Clip

(8) Brake hose front LH

T1: 15 (1.5, 11.1)

(3) Connector 2 - two-way

(9) Gasket

T2: 18 (1.8, 13.3)

(4) Pipe ASSY front ABS

(10) Brake hose front RH

T3: 19 (1.9, 14.0)

(5) Vacuum sensor ASSY

(11) Pipe clamp

T4: 26 (2.7, 19.2)

(6) Master cylinder ASSY and vacuum booster ASSY

T5: 33 (3.4, 24.3)

• ELECTRIC BRAKE BOOSTER MODEL

- | | |
|--|-------------------------|
| (1) Hydraulic unit ASSY VDC | (6) Clamp brake hose |
| (2) Clip | (7) Brake hose front LH |
| (3) Connector 2 - two-way | (8) Gasket |
| (4) Pipe ASSY front ABS | (9) Brake hose front RH |
| (5) Master cylinder ASSY and electric booster ASSY | (10) Pipe clamp |

Tightening torque: N·m (kgf·m, ft·lb)

T1: 15 (1.5, 11.1)

T2: 18 (1.8, 13.3)

T3: 19 (1.9, 14.0)

T4: 26 (2.7, 19.2)

T5: 33 (3.4, 24.3)

5. CENTER BRAKE PIPES AND HOSES

- **EXCEPT FOR ELECTRIC BRAKE BOOSTER MODEL**

(1) Fuel pipe bracket A	(6) Brake hose rear RH	Tightening torque: N·m (kgf-m, ft-lb)
(2) Fuel pipe bracket B	(7) Gasket	
(3) Pipe ASSY center*	(8) Brake hose rear LH	
(4) Fuel pipe bracket C	(9) Pipe clamp	
(5) Clamp brake hose		

T1: 15 (1.5, 11.1)

T2: 18 (1.8, 13.3)

T3: 26 (2.7, 19.2)

T4: 33 (3.4, 24.3)

*: For components of the pipe assembly center, refer to "Fuel Line 1" of "FUEL INJECTION (FUEL SYSTEMS)" section.  [Ref. to FUEL INJECTION \(FUEL SYSTEMS\)\(H4DOTC\)>General Description>COMPONENT > FUEL LINE 1.](#)

● ELECTRIC BRAKE BOOSTER MODEL

(1) Fuel pipe bracket A	(6) Brake hose rear RH	Tightening torque: N·m (kgf-m, ft-lb)
(2) Fuel pipe bracket B	(7) Gasket	
(3) Pipe ASSY center*	(8) Brake hose rear LH	
(4) Fuel pipe bracket C	(9) Pipe clamp	
(5) Clamp brake hose		

T1: 15 (1.5, 11.1)

T2: 18 (1.8, 13.3)

T3: 26 (2.7, 19.2)

T4: 33 (3.4, 24.3)

*: For components of the pipe assembly center, refer to "Fuel Line 1" of "FUEL INJECTION (FUEL SYSTEMS)" section.  [Ref. to FUEL INJECTION \(FUEL SYSTEMS\)\(H4DOTC\)>General Description>COMPONENT > FUEL LINE 1.](#)

6. BRAKE BOOSTER

- EXCEPT FOR ELECTRIC BRAKE BOOSTER MODEL

- | | |
|-----------------------|-------------------------|
| (1) Hose clamp | (4) Vacuum booster ASSY |
| (2) Vacuum hose COMPL | (5) Vacuum sensor ASSY |
| (3) Vacuum pipe COMPL | (6) Gasket booster |

Tightening torque: N·m (kgf·m, ft·lb)

T: 18 (1.8, 13.3)

● **ELECTRIC BRAKE BOOSTER MODEL**

- | | |
|---------------------------|------------------------------|
| (1) Electric booster ASSY | (3) Stopper electric booster |
| (2) Gasket A | (4) Gasket B |

Tightening torque: N·m (kgf·m, ft·lb)

T: 18 (1.8, 13.3)

7. BRAKE PEDAL

● **MT MODEL**

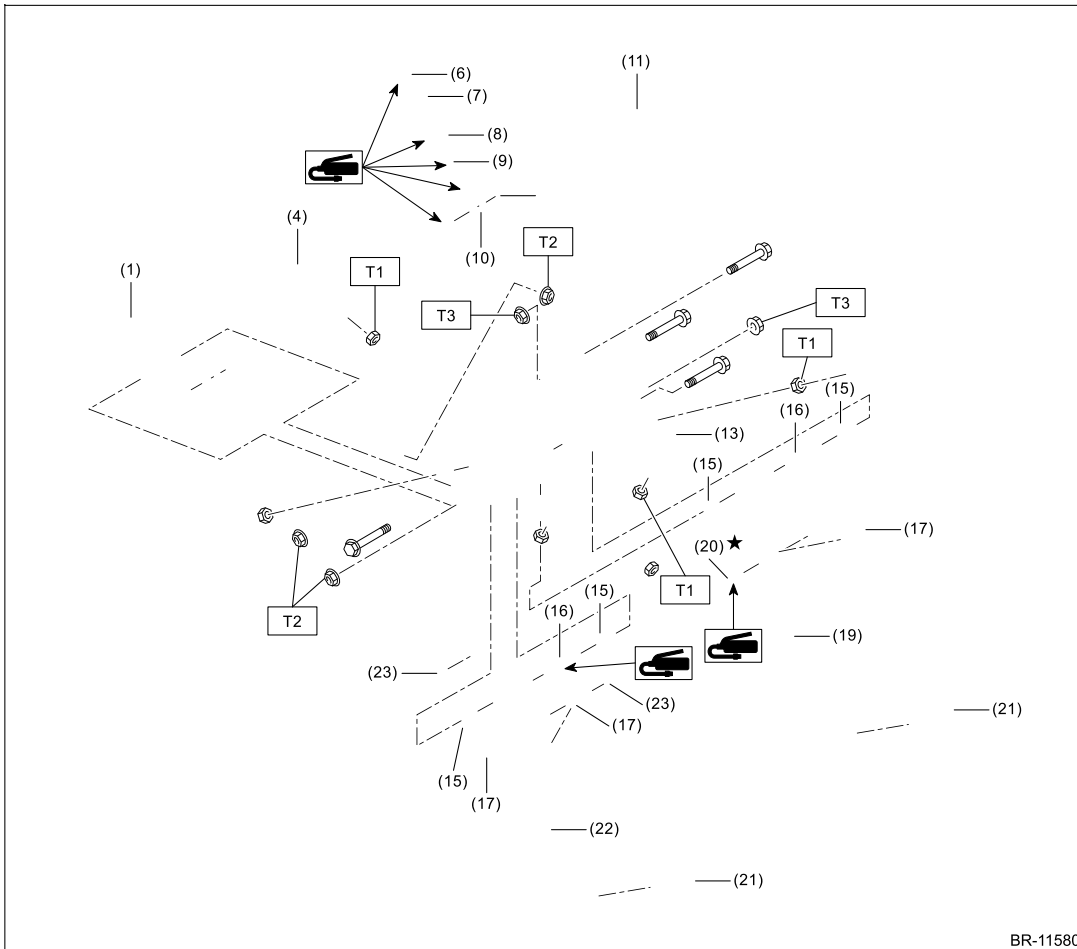

BR-11580

- | | |
|--------------------------|-----------------------------|
| (1) Master cylinder | (13) Clutch switch |
| (2) Clip | (14) Stop light switch ASSY |
| (3) Clevis pin A | (15) Bushing B |
| (4) Clutch start switch | (16) Spacer |
| (5) Assist pin | (17) Stopper |
| (6) Assist bushing A | (18) Snap pin |
| (7) Assist rod A | (19) Pedal COMPL brake |
| (8) Assist spring | (20) Clevis pin B |
| (9) Assist bushing B | (21) Pedal pad |
| (10) Assist rod B | (22) Clutch pedal |
| (11) Harness connector | (23) Bushing A |
| (12) Bracket COMPL pedal | |

Tightening torque: N·m (kgf·m, ft·lb)

T1: 8 (0.8, 5.9)

T2: 18 (1.8, 13.3)

T3: 30 (3.1, 22.1)

● CVT MODEL

- | | | |
|----------------------------|----------------|---|
| (1) Bracket COMPL pedal | (6) Snap pin | Tightening torque: N·m (kgf·m, ft·lb)
T1: 8 (0.8, 5.9)
T2: 18 (1.8, 13.3)
T3: 30 (3.1, 22.1) |
| (2) Stop light switch ASSY | (7) Clevis pin | |
| (3) Pedal pad | (8) Bushing | |
| (4) Pedal COMPL brake | (9) Spacer | |
| (5) Stopper | | |

BRAKE > General Description

PREPARATION TOOL

1. SUBARU SPECIAL TOOL

ILLUSTRATION	TOOL NUMBER	DESCRIPTION	REMARKS
	99099AL000	PISTON BOOT INSTALLER	Used for installing the boot piston.
	—	SUBARU SELECT MONITOR 4	Used for setting of each function and troubleshooting for electrical system. Note: <ul style="list-style-type: none"> • For detailed operation procedures, refer to “Help” of application. • Used together with interface for Subaru Select Monitor (such as DST-i and DST-010).

2. OTHER

	REMARKS
Wobble extension	Used for installing the brake booster.
Penetration nut	Used for securing the brake disc when measuring brake disc run-out. <ul style="list-style-type: none"> • Thread diameter: 12 mm • Pitch: 1.25 mm
Crowfoot wrench	Used for installing the brake pipe. <div style="border: 1px solid black; padding: 2px; margin-top: 5px;"> <p>Note: Use Snap-on FRHM10 or FRHM12, or another manufacturer's 12-point wrench.</p> </div>
Circuit tester	Used for measuring resistance, voltage and current.
Dial gauge	Used for measuring brake disc run-out.
Magnet stand	Used for measuring brake disc run-out.
Micrometer	Used for measuring the brake disc thickness.
Disc brake piston tool	Used for pushing back the electronic parking brake piston. <ul style="list-style-type: none"> • KTC disc parking tool rotor (E•F) ABX104 or equivalent • OTC brake caliper tool adapter No. 7317A or equivalent
Disc brake piston tool	Used for pushing back the piston. (Except for electronic parking brake)
Vacuum gauge	Used for measuring the operation and airtightness of the brake booster.
Flare nut wrench	Used for removing and installing the brake pipe.
Pressure gauge	Used for measuring the operation and airtightness of the brake booster.
Brake fluid caution label (Part No. 25080GA010)	Used when the reservoir tank is replaced. <div style="border: 1px solid black; padding: 2px; margin-top: 5px;"> <p>Note: This is the SUBARU genuine part.</p> </div>
Pedal force gauge	Used for measuring the operation and airtightness of the brake booster.
Hexagon wrench	Used for removing and installing the electronic parking brake caliper. Width across flat 7 mm (0.28 in)
PLUG BOLT (Part No. 26642AL000)	Used for preventing the brake fluid leakage or the air entry inside the caliper when disconnecting the brake hose from the electronic parking brake caliper. <div style="border: 1px solid black; padding: 2px; margin-top: 5px;"> <p>Note: This is the SUBARU genuine part.</p> </div>
PLUG GASKET (Part No. 26642AL010)	Used for preventing the brake fluid leakage or the air entry inside the caliper when disconnecting the brake hose from the electronic parking brake caliper. <div style="border: 1px solid black; padding: 2px; margin-top: 5px;"> <p>Note: This is the SUBARU genuine part.</p> </div>

BRAKE > Front Brake Pad

REMOVAL



1. Remove the front wheels.  [Ref. to WHEEL AND TIRE SYSTEM>Tire and Wheel>REMOVAL.](#)
2. Remove the pad disc brake front.
 - (1) Remove the lower bolt.
 - (2) Raise the caliper body and remove the pad disc brake front.

Note:

Do not disconnect the brake hose from the caliper body.

3. Remove the pad clip.

BRAKE > Front Brake Pad

INSTALLATION

Note:

Before installation, remove mud, foreign matter, and rust from the caliper body and support front disc brake.

1. Check the pad disc brake front.  [Ref. to BRAKE>Front Brake Pad>INSPECTION.](#)
2. Apply a thin coat of grease to the support front disc brake.

Preparation items:

Grease: An item contained in the pad kit, DOW CORNING TORAY Molykote M7439 or equivalent

3. Apply a thin coat of grease to the pad clip.

Preparation items:

Grease: An item contained in the pad kit, DOW CORNING TORAY Molykote M7439 or equivalent

4. Install the pad clip.
5. Press back the piston disc brake with a disc brake piston tool.

Caution:

When pressing back the piston disc brake, the clearance between pad disc brake and brake disc becomes large, which makes the brake pedal effort softer.

After the installation of front wheel, be sure to perform the adjustment of the clearance and the pedal effort by depressing the brake pedal several times.

Note:

Perform this procedure only when required.

6. Install the pad disc brake front.

Caution:

When installing, make sure that the pad wear indicator (a) comes on the lower side.

7. Install the caliper body.

Tightening torque:

27 N·m (2.8 kgf-m, 19.9 ft-lb)

8. Install the front wheels.  [Ref. to WHEEL AND TIRE SYSTEM>Tire and Wheel>INSTALLATION.](#)

BRAKE > Front Brake Pad

INSPECTION

1. BRAKE PAD

1. Check the thickness of the pad disc brake front.

Note:

- When replacing the pad disc brake front, always replace the pads of both wheels and both sides as a set.
- Replace pad clips if they are twisted or worn.
- Replace the pad disc brake front if there is oil or grease on it.
- Pad wear indicators are installed on the pad disc brake front inner and the pad disc brake front outer, and a squeaking sound is heard if the pad is worn to the limit.

	Value in a brand-new state (a)	Wear limit (b)
Brake pad thickness	11 mm (0.43 in)	1.5 mm (0.059 in)

2. If the wear limit is exceeded in the inspection, replace the pad disc brake front.

2. BRAKE PAD SHIM

1. Check the shim disc brake front for excessive rust.
2. Check that the shim disc brake front does not have warpage and it can be attached on the back surface of the pad disc brake front with no gap.
3. Replace the shim disc brake front if faulty is found in the inspection.

BRAKE > Front Disc Rotor

REMOVAL



1. Remove the front wheels.  [Ref. to WHEEL AND TIRE SYSTEM>Tire and Wheel>REMOVAL.](#)
2. Remove the disc brake assembly front.
 - (1) Remove the brake hose bracket and the disc brake assembly front.
 - (2) Prepare wiring harnesses etc. to be discarded, and suspend the disc brake assembly front from the strut assembly.

3. Make markings (a) on the brake disc front and the front hub unit bearing.

Note:

Marking is not necessary if the brake disc front is replaced with a new part.

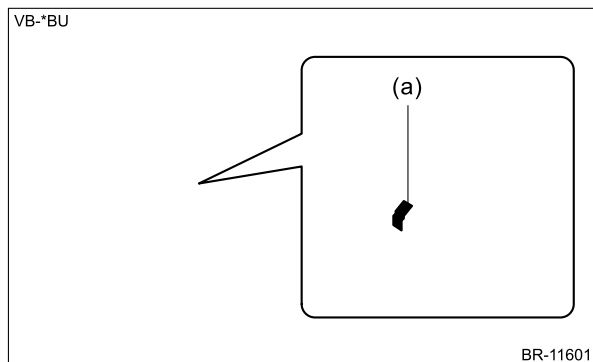

4. Remove the brake disc front.

Note:

When the brake disc front is difficult to be removed, screw in 8 mm (0.31 in) bolt to the threaded part (a), and remove the brake disc front.

BRAKE > Front Disc Rotor

INSTALLATION

Note:

Before installation, remove mud and foreign matter from the disc brake assembly front.

1. Check the brake disc front.  [Ref. to BRAKE>Front Disc Rotor>INSPECTION.](#)
2. Press back the piston disc brake with a disc brake piston tool.

Caution:

When pressing back the piston disc brake, the clearance between pad disc brake and brake disc becomes large, which makes the brake pedal effort softer.

After the installation of front wheel, be sure to perform the adjustment of the clearance and the pedal effort by depressing the brake pedal several times.

Note:

Perform this procedure only when required.

3. Install the brake disc front.

Note:

Install so that the markings (a) of the brake disc front and the front hub unit bearing are aligned with each other.

4. Use new mounting bolts to install the disc brake assembly front.

Tightening torque:

135 N·m (13.8 kgf-m, 99.6 ft-lb)

5. Install the brake hose bracket.

Tightening torque:

33 N·m (3.4 kgf-m, 24.3 ft-lb)

6. Install the front wheels.  [Ref. to WHEEL AND TIRE SYSTEM>Tire and Wheel>INSTALLATION.](#)

BRAKE > Front Disc Rotor

INSPECTION

1. DISC ROTOR RUNOUT CHECK

1. Check the front hub unit bearing for free play and runout before the inspection of brake disc front runout limit. [📄 Ref. to PROPELLER SHAFT / DRIVE SHAFT / AXLE>Front Hub Unit Bearing>INSPECTION.](#)
2. Check the brake disc front runout.
 - (1) Remove the caliper body. [📄 Ref. to BRAKE>Front Disc Brake Assembly>REMOVAL.](#)
 - (2) Secure the brake disc front with the five penetration nuts.
 - (3) Set a dial gauge 10 mm (0.39 in) inward from the brake disc front outer circumference, and check the runout of front side while rotating the brake disc front.

Service limit:

0.05 mm (0.002 in)

Note:

<Example of magnet stand and dial gauge installation>

Attach the magnet stand to the front axle housing or a part that is fastened to the front axle housing (a part without rubber bushing, such as the support front disc brake).

- (4) Set a dial gauge 10 mm (0.39 in) inward from the brake disc front outer circumference, and check the runout of backside while rotating the brake disc front.

Service limit:

0.05 mm (0.002 in)

Note:

<Example of magnet stand and dial gauge installation>

Attach the magnet stand to the front axle housing or a part that is fastened to the front axle housing (a part without rubber bushing, such as the support front disc brake).

3. If the brake disc front runout exceeds service limit, grind the brake disc front.
4. Check the brake disc front thickness after grinding. [📄 Ref. to BRAKE>Front Disc Rotor>INSPECTION > DISC ROTOR THICKNESS CHECK.](#)

2. DISC ROTOR THICKNESS CHECK

1. Remove the caliper body. [📄 Ref. to BRAKE>Front Disc Brake Assembly>REMOVAL.](#)
2. Set a micrometer 10 mm (0.39 in) inward from the brake disc front outer perimeter, and then measure the disc rotor thickness (a).

	Value in a brand-new state	Wear limit
Disc rotor thickness	28 mm (1.1 in)	26 mm (1.02 in)

3. If the wear limit is exceeded in the inspection, replace the brake disc front.

BRAKE > Front Disc Brake Assembly

REMOVAL



Caution:

- Do not allow brake fluid to come in contact with the painted surface of the vehicle body. If it does, wash off with water and wipe away completely.
- Prepare a container to catch grease or oil, etc. If any grease or oil spills, wipe it off and clean immediately to prevent from penetrating into floor or flowing outside.

1. Remove the front wheels.  [Ref. to WHEEL AND TIRE SYSTEM>Tire and Wheel>REMOVAL.](#)
2. Remove the bolts and then remove the brake hose front.

3. Remove the bolt, and remove the caliper body.

4. Remove the pad disc brake front.

5. Remove the pad clip.

6. Remove the mounting bolts, and then remove the support front disc brake.

BRAKE > Front Disc Brake Assembly

INSTALLATION

Note:

Before installation, remove mud, foreign matter, and rust from the caliper body and support front disc brake.

1. Check each part.  [Ref. to BRAKE>Front Disc Brake Assembly>INSPECTION.](#)
2. Apply a thin coat of grease to the support front disc brake.

Preparation items:

Grease: An item contained in the pad kit, DOW CORNING TORAY Molykote M7439 or equivalent

3. Apply a thin coat of grease to the pad clip.

Preparation items:

Grease: An item contained in the pad kit, DOW CORNING TORAY Molykote M7439 or equivalent

4. Install the pad clip.
5. Use new mounting bolts to install the support front disc brake.

Tightening torque:

135 N·m (13.8 kgf-m, 99.6 ft-lb)

6. Press back the piston disc brake with a disc brake piston tool.

Caution:

**When pressing back the piston disc brake, the clearance between pad disc brake and brake disc becomes large, which makes the brake pedal effort softer.
After the installation of front wheel, be sure to perform the adjustment of the clearance and the pedal effort by depressing the brake pedal several times.**

Note:

Perform this procedure only when required.

7. Install the pad disc brake front.

Caution:

When installing, make sure that the pad wear indicator (a) comes on the lower side.

8. Install the caliper body.

Tightening torque:

27 N·m (2.8 kgf-m, 19.9 ft-lb)

9. Connect the brake hose front using a new gasket.

Tightening torque:

26 N·m (2.7 kgf-m, 19.2 ft-lb)

10. Bleed air from the brake line.  [Ref. to BRAKE>Air Bleeding>PROCEDURE > BRAKE LINE.](#)

11. Install the front wheels.  [Ref. to WHEEL AND TIRE SYSTEM>Tire and Wheel>INSTALLATION.](#)

BRAKE > Front Disc Brake Assembly

DISASSEMBLY



Caution:

Be careful not to allow any foreign materials to enter through the brake hose front mounting hole on the caliper body.

Note:

Remove mud and foreign matter from the caliper body.

1. Remove the bleeder cap (a) and the bleeder screw (b) from the caliper body.

2. Remove the piston disc brake from the caliper body.

- (1) Place a wooden block, etc. in the caliper body to prevent the piston disc brake from jumping out and being damaged.
- (2) Using an air gun, gradually apply compressed air via the brake hose front installation hole to push out the piston disc brake.

Note:

Instead of removing the pistons one by one, remove all pistons at once after adjusting the amount of protrusion evenly using a wooden block.

(a) 30 mm (1.18 in)

3. Remove the boot piston (a) and piston seal (b) from the caliper body.

Caution:

Do not damage the cylinder and piston seal groove.

4. Remove the slide pin (a), slide pin lock (b), and pin boot (c) from the support front disc brake.

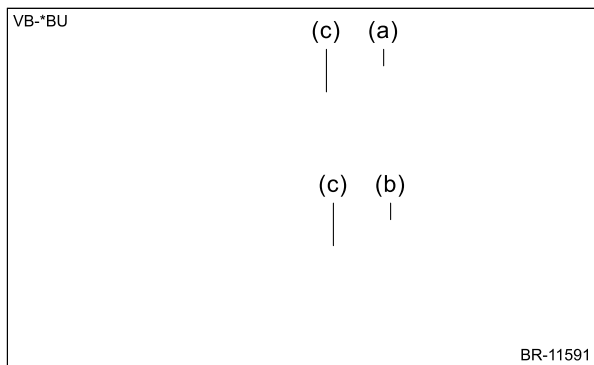

5. Remove the slide pin bushing from the slide pin lock.

BRAKE > Front Disc Brake Assembly

ASSEMBLY

1. Check each part.  [Ref. to BRAKE>Front Disc Brake Assembly>INSPECTION.](#)
2. Install the slide pin, slide pin lock, and pin boot to the support front disc brake.
 - (1) Apply a thin coat of grease to the contact surface of the slide pin bushing of the slide pin lock.

Preparation items:

Grease: An item contained in the piston seal kit, NIPPON GREASE NIGLUBE RX-2 (part No. 000041000) or equivalent

- (2) Install a slide pin bushing to the slide pin lock.
- (3) Apply a thin coat of grease to the slide pin and the slide pin lock.

Preparation items:

Grease: An item contained in the piston seal kit, NIPPON GREASE NIGLUBE RX-2 (part No. 000041000) or equivalent

(4) Apply a thin coat of grease to the contact surface of the support front disc brake pin boot and the pin sliding surface.

Preparation items:

Grease: An item contained in the piston seal kit, NIPPON GREASE NIGLUBE RX-2 (part No. 000041000) or equivalent

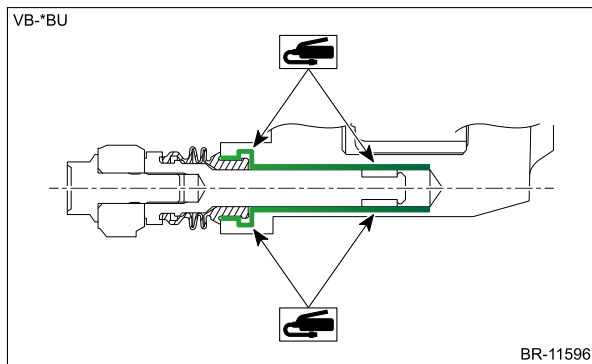

(5) Install a pin boot to the slide pin and the slide pin lock, and insert them into the support front disc brake.

Caution:

After inserting the slide pin and slide pin lock into specified position, make sure that they slide and seat properly by moving each pin by hand.

3. Install the piston seal, the boot piston, and the piston disc brake to the caliper body.

(1) Clean the inside of the caliper body using brake fluid.

Preparation items:

Brake fluid: [Ref. to BRAKE>General Description>SPECIFICATION > BRAKE FLUID.](#)

(2) Apply a thin coat of grease all around new piston seals.

Preparation items:

Grease: An item contained in the piston seal kit or equivalent

(3) Install the piston seal to the groove inside caliper body.

(4) Apply a coat of brake fluid to the entire outer surface of the piston disc brake.

Preparation items:

Brake fluid: [Ref. to BRAKE>General Description>SPECIFICATION > BRAKE FLUID.](#)

(5) Apply a thin coat of grease to the new boot piston.

Preparation items:

Grease: An item contained in the piston seal kit or equivalent

(6) Install the boot piston to the groove on the ends of piston disc brake.

(7) Install the piston disc brake to the caliper body.

Caution:

Do not force the piston disc brake into the sliding part of caliper body.

BRAKE > Front Disc Brake Assembly

INSPECTION

1. Check the piston sliding part of caliper body and the piston for uneven wear, damage or rust.
2. Check the rubber parts for damage or deterioration.
3. If faulty is found in the inspection, replace the relevant part.

REMOVAL



1. EXCEPT FOR THE ELECTRONIC PARKING BRAKE MODEL

- 1.** Remove the rear wheels.  [Ref. to WHEEL AND TIRE SYSTEM>Tire and Wheel>REMOVAL.](#)
- 2.** Remove the pad disc brake rear.
 - (1) Remove the bolts and then remove the brake hose bracket.

(2) Remove the lower bolt.



(3) Raise the caliper body and remove the pad disc brake rear.

Note:

Do not disconnect the brake hose from the caliper body.

- 3.** Remove the pad clip.

2. ELECTRONIC PARKING BRAKE MODEL

1. Release the parking brake.
2. Execute the brake maintenance mode.  [Ref. to PARKING BRAKE>Parking Brake System>OPERATION > BRAKE MAINTENANCE MODE.](#)
3. Disconnect the ground terminal from battery sensor.  [Ref. to REPAIR CONTENTS>NOTE > BATTERY.](#)
4. Remove the rear wheels.  [Ref. to WHEEL AND TIRE SYSTEM>Tire and Wheel>REMOVAL.](#)
5. Remove the pad COMPL.
 - (1) Disconnect the connector.
 - (2) Remove the pad clip.
 - (3) Remove the bolts and then remove the brake hose bracket.

(4) Remove the cap (a).

(5) Using a hexagon wrench, remove the guide pin rear brake (b) and remove the caliper body.

(6) Remove the pad COMPL.

BRAKE > Rear Brake Pad

INSTALLATION

1. EXCEPT FOR THE ELECTRONIC PARKING BRAKE MODEL

Note:

Before installation, remove mud, foreign matter, and rust from the caliper body and support rear disc brake.

1. Check the pad disc brake rear.  [Ref. to BRAKE>Front Brake Pad>INSPECTION.](#)
2. Apply a thin coat of grease to the support rear disc brake.

Preparation items:

Grease: An item contained in the pad kit, DOW CORNING TORAY Molykote M7439 or equivalent

3. Apply a thin coat of grease to the pad clip.

Preparation items:

Grease: An item contained in the pad kit, DOW CORNING TORAY Molykote M7439 or equivalent

4. Install the pad clip.
5. Press back the piston disc brake with a disc brake piston tool.

Caution:

**When pressing back the piston disc brake, the clearance between pad disc brake and brake disc becomes large, which makes the brake pedal effort softer.
After the installation of rear wheel, be sure to perform the adjustment of the clearance and the pedal effort by depressing the brake pedal several times.**

Note:

Perform this procedure only when required.

6. Install the pad disc brake rear.

Caution:

When installing, make sure that the pad wear indicator (a) comes on the lower side.

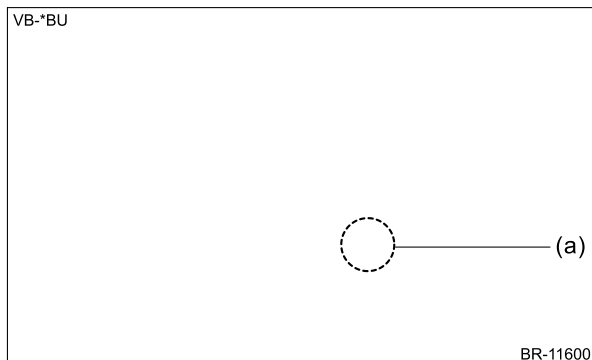

7. Install the caliper body.

Tightening torque:

27 N·m (2.8 kgf·m, 19.9 ft·lb)

8. Install the brake hose bracket.

Tightening torque:

33 N·m (3.4 kgf-m, 24.3 ft-lb)

9. Install the rear wheels.  [Ref. to WHEEL AND TIRE SYSTEM>Tire and Wheel>INSTALLATION.](#)

2. ELECTRONIC PARKING BRAKE MODEL

Note:

- Before installation, remove mud, foreign matter, and rust from the caliper body and support rear disc brake.
- Check that the ground terminal is disconnected from the battery sensor.

1. Apply a thin coat of grease to the support rear disc brake.

Preparation items:

Grease: An item contained in the pad kit, Henkel TEROSON VR 500 or equivalent

2. Install the pad COMPL.

Note:

When installing a new brake pad, refer to the procedures in "REPLACEMENT".  [Ref. to BRAKE>Rear Brake Pad>REPLACEMENT.](#)

3. Using a hexagon wrench, install the caliper body.

Tightening torque:

25 N·m (2.5 kgf-m, 18.4 ft-lb)

4. Install the brake hose bracket.

Tightening torque:

33 N·m (3.4 kgf-m, 24.3 ft-lb)

5. Install the pad clip.

6. Connect the connector.

7. Connect the ground terminal to battery sensor.  [Ref. to REPAIR CONTENTS>NOTE > BATTERY.](#)

8. Exit the brake maintenance mode.  [Ref. to PARKING BRAKE>Parking Brake System>OPERATION > BRAKE MAINTENANCE MODE.](#)

9. After the operation is completed, apply and release the parking brake five times and ensure that the brake operates normally.

10. Install the rear wheels.  [Ref. to WHEEL AND TIRE SYSTEM>Tire and Wheel>INSTALLATION.](#)

BRAKE > Rear Brake Pad

INSPECTION

1. EXCEPT FOR THE ELECTRONIC PARKING BRAKE MODEL

• BRAKE PAD

1. Check the thickness of the pad disc brake rear.

Note:

- When replacing the pad disc brake rear, always replace the pads of both wheels and both sides as a set.
- Replace pad clips if they are twisted or worn.
- Replace the pad disc brake rear if there is oil or grease on it.
- Pad wear indicators are installed on the pad disc brake rear inner, and a squeaking sound is heard if the brake pad is worn to the limit.

	Value in a brand-new state (a)	Wear limit (b)
Brake pad thickness	11 mm (0.43 in)	1.5 mm (0.059 in)

2. If the wear limit is exceeded in the inspection, replace the pad disc brake rear.

● **BRAKE PAD SHIM**

1. Check the shim disc brake rear for excessive rust.
2. Check that the shim disc brake rear does not have warp and it can be attached on the back surface of the pad disc brake rear with no gap.
3. Replace the shim disc brake rear if faulty is found in the inspection.

2. ELECTRONIC PARKING BRAKE MODEL

1. Check the pad COMPL thickness.

Note:

- When replacing the pad COMPL, always replace the pads of both wheels and both sides as a set.
- Replace pad clips if they are twisted or worn.
- Replace the pad COMPL if there is oil or grease on it.
- Pad wear indicators are installed on the pad COMPL inner, and a squeaking sound is heard if the brake pad is worn to the limit.

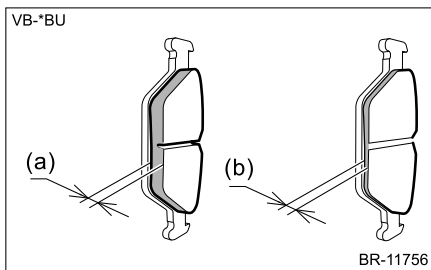

	Value in a brand-new state (a)	Wear limit (b)
Brake pad thickness	9 mm (0.354 in)	1.5 mm (0.059 in)

2. If the wear limit is exceeded in the inspection, replace the pad COMPL.

BRAKE > Rear Brake Pad

REPLACEMENT

1. ELECTRONIC PARKING BRAKE MODEL

● **WHEN THE SUBARU SELECT MONITOR IS AVAILABLE**

1. Release the parking brake.
2. Execute the brake maintenance mode. [🔗 Ref. to PARKING BRAKE>Parking Brake System>OPERATION > BRAKE MAINTENANCE MODE.](#)
3. Remove the pad COMPL. [🔗 Ref. to BRAKE>Rear Brake Pad>REMOVAL > ELECTRONIC PARKING BRAKE MODEL.](#)
4. Push back the piston disc brake.
5. Install the pad COMPL. [🔗 Ref. to BRAKE>Rear Brake Pad>INSTALLATION > ELECTRONIC PARKING BRAKE MODEL.](#)

6. Exit the brake maintenance mode.  [Ref. to PARKING BRAKE>Parking Brake System>OPERATION > BRAKE MAINTENANCE MODE.](#)
7. After the operation is completed, apply and release the parking brake five times and ensure that the brake operates normally.

● **WHEN THE SUBARU SELECT MONITOR IS NOT AVAILABLE**

1. Remove the caliper body and pad COMPL.
2. Remove the bolt securing the lower side of the support rear disc brake, loosen the upper side, and then slide the support rear disc brake upward and hold it.
3. Secure the caliper body to the support rear disc brake, and push back the piston disc brake using a tool.

Preparation tool:

- Disc brake piston tool: KTC disc parking tool rotor (E•F) ABX104 or equivalent
- Disc brake piston tool: OTC brake caliper tool adapter No. 7317A or equivalent

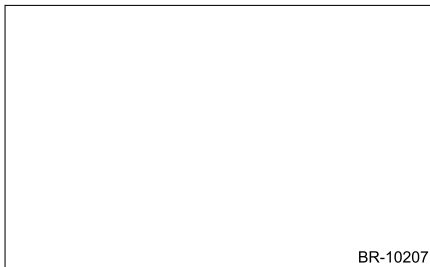

4. Install the support rear disc brake and the caliper body to the specified tightening torque.
Tightening torque:
Refer to "COMPONENT" of "General Description" for the tightening torque.  [Ref. to BRAKE>General Description>COMPONENT > REAR DISC BRAKE.](#)
5. After the operation is completed, apply and release the parking brake five times and ensure that the brake operates normally.

BRAKE > Rear Disc Rotor

REMOVAL



1. EXCEPT FOR THE ELECTRONIC PARKING BRAKE MODEL

1. Remove the rear wheels.  [Ref. to WHEEL AND TIRE SYSTEM>Tire and Wheel>REMOVAL.](#)
2. Release the parking brake.
3. Remove the disc brake assembly rear.
 - (1) Remove the bolts and then remove the brake hose bracket.

(2) Remove the mounting bolt, and remove the disc brake assembly rear.

(3) Prepare wiring harnesses etc. to be discarded, and suspend the disc brake assembly rear from the shock absorber assembly rear.

4. Make markings (a) on the brake disc rear and the rear hub unit bearing.

Note:

Marking is not necessary if the brake disc rear is replaced with a new part.

5. Remove the brake disc rear.

Note:

When the brake disc rear is difficult to be removed, follow the procedure below to remove it.

(1) Remove the plug (a) and insert a flat tip screwdriver to turn the adjuster assembly in the direction (b) where it is shortened.

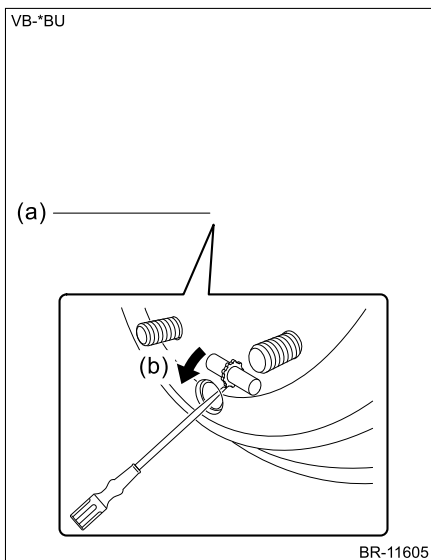

(2) Screw in 8 mm (0.31 in) bolt to the threaded part (a), and remove the brake disc rear.

2. ELECTRONIC PARKING BRAKE MODEL

1. Release the parking brake.
2. Execute the brake maintenance mode. [Ref. to PARKING BRAKE>Parking Brake System>OPERATION > BRAKE MAINTENANCE MODE.](#)
3. Disconnect the ground terminal from battery sensor. [Ref. to REPAIR CONTENTS>NOTE > BATTERY.](#)
4. Remove the rear wheels. [Ref. to WHEEL AND TIRE SYSTEM>Tire and Wheel>REMOVAL.](#)
5. Remove the disc brake assembly rear.
 - (1) Remove the bolts and then remove the brake hose bracket.
 - (2) Remove the connector and mounting bolt, and remove the disc brake assembly rear.

(3) Prepare wiring harnesses etc. to be discarded, and suspend the disc brake assembly rear from the shock absorber assembly rear.

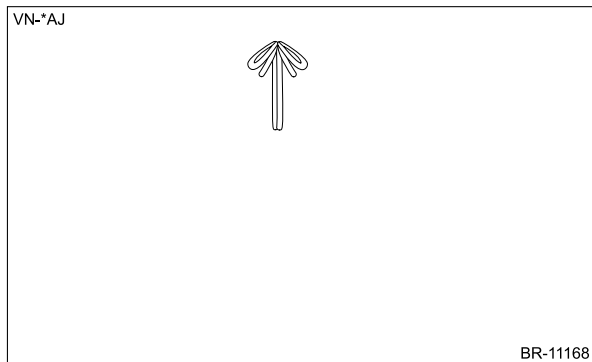

6. Make markings (a) on the brake disc rear and the rear hub unit bearing.

Note:

Marking is not necessary if the brake disc rear is replaced with a new part.

7. Remove the brake disc rear.

Note:

When the brake disc rear is difficult to be removed, screw in 8 mm (0.31 in) bolt to the threaded part of the brake disc rear (a), and remove the brake disc rear.

BRAKE > Rear Disc Rotor

INSTALLATION

1. EXCEPT FOR THE ELECTRONIC PARKING BRAKE MODEL

Note:

Before installation, remove mud and foreign matter from the disc brake assembly rear.

1. Check the brake disc rear.  [Ref. to BRAKE>Front Disc Rotor>INSPECTION.](#)
2. Press back the piston disc brake with a disc brake piston tool.

Caution:

When pressing back the piston disc brake, the clearance between pad disc brake and brake disc becomes large, which makes the brake pedal effort softer.
After the installation of rear wheel, be sure to perform the adjustment of the clearance and the pedal effort by depressing the brake pedal several times.

Note:

Perform this procedure only when required.

3. Install the brake disc rear.

Note:

Install so that the markings (a) of the brake disc rear and the rear hub unit bearing are aligned with each other.

4. Adjust the parking brake.  [Ref. to PARKING BRAKE>Parking Brake Assembly_\(Rear Disc Brake\)>ADJUSTMENT.](#)
5. Use new mounting bolts to install the disc brake assembly rear.

Tightening torque:

73 N·m (7.4 kgf-m, 53.8 ft-lb)

6. Install the brake hose bracket.

Tightening torque:

33 N·m (3.4 kgf-m, 24.3 ft-lb)

7. Install the rear wheels.  [Ref. to WHEEL AND TIRE SYSTEM>Tire and Wheel>INSTALLATION.](#)

2. ELECTRONIC PARKING BRAKE MODEL

Note:

- Before installation, remove mud and foreign matter from the disc brake assembly rear.
- Check that the ground terminal is disconnected from the battery sensor.

1. Check the brake disc rear.  [Ref. to BRAKE>Rear Disc Rotor>INSPECTION.](#)
2. Install the brake disc rear.

Note:

Install so that the markings (a) of the brake disc rear and the rear hub unit bearing are aligned with each other.

3. Use new mounting bolts to install the disc brake assembly rear.



Tightening torque:

73 N·m (7.4 kgf-m, 53.8 ft-lb)



4. Connect the connector.
5. Install the brake hose bracket.

Tightening torque:

33 N·m (3.4 kgf-m, 24.3 ft-lb)

6. Connect the ground terminal to battery sensor.  [Ref. to REPAIR CONTENTS>NOTE > BATTERY.](#)
7. Exit the brake maintenance mode.  [Ref. to PARKING BRAKE>Parking Brake System>OPERATION > BRAKE MAINTENANCE MODE.](#)
8. After the operation is completed, apply and release the parking brake five times and ensure that the brake operates normally.
9. Install the rear wheels.  [Ref. to WHEEL AND TIRE SYSTEM>Tire and Wheel>INSTALLATION.](#)

BRAKE > Rear Disc Rotor**INSPECTION****1. DISC ROTOR RUNOUT CHECK**

1. Check the rear hub unit bearing for free play and runout before the inspection of brake disc rear runout limit.  [Ref. to PROPELLER SHAFT / DRIVE SHAFT / AXLE>Rear Hub Unit Bearing>INSPECTION.](#)
2. Check the brake disc rear runout.
 - (1) Remove the caliper body.  [Ref. to BRAKE>Rear Disc Brake Assembly>REMOVAL.](#)
 - (2) Secure the brake disc rear with the five penetration nuts.
 - (3) Set a dial gauge 10 mm (0.39 in) inward from the brake disc rear outer circumference, and check the runout of front side while rotating the brake disc rear.

Service limit:

0.05 mm (0.002 in)

Note:

<Example of magnet stand and dial gauge installation>

Attach the magnet stand to the rear axle housing or a part that is fastened to the rear axle housing (a part without rubber bushing, such as the support rear disc brake).

- (4) Set a dial gauge 10 mm (0.39 in) inward from the brake disc rear outer circumference, and check the runout of back side while rotating the brake disc rear.

Service limit:

0.05 mm (0.002 in)

Note:

<Example of magnet stand and dial gauge installation>

Attach the magnet stand to the rear axle housing or a part that is fastened to the rear axle housing (a part without rubber bushing, such as the support rear disc brake).

- 3.** If the brake disc rear runout exceeds service limit, grind the brake disc rear.
- 4.** Check the brake disc rear thickness after grinding.  [Ref. to BRAKE>Rear Disc Rotor>INSPECTION > DISC ROTOR THICKNESS CHECK.](#)

2. DISC ROTOR THICKNESS CHECK

- 1.** Remove the caliper body.  [Ref. to BRAKE>Rear Disc Brake Assembly>REMOVAL.](#)
- 2.** Set a micrometer 10 mm (0.39 in) inward from the brake disc rear outer perimeter, and then measure the disc rotor thickness (a).

- Except for the electronic parking brake model

	Value in a brand-new state	Wear limit
Disc rotor thickness	18 mm (0.71 in)	16 mm (0.63 in)

- Electronic parking brake model

	Value in a brand-new state	Wear limit
Disc rotor thickness	17 mm (0.67 in)	15 mm (0.59 in)

3. If the wear limit is exceeded in the inspection, replace the brake disc rear.

REMOVAL



1. EXCEPT FOR THE ELECTRONIC PARKING BRAKE MODEL

Caution:

- **Do not allow brake fluid to come in contact with the painted surface of the vehicle body. If it does, wash off with water and wipe away completely.**
- **Prepare a container to catch grease or oil, etc. If any grease or oil spills, wipe it off and clean immediately to prevent from penetrating into floor or flowing outside.**

1. Remove the rear wheels.  [Ref. to WHEEL AND TIRE SYSTEM>Tire and Wheel>REMOVAL.](#)
2. Remove the bolts and then remove the brake hose rear.

3. Remove the bolt, and remove the caliper body.

4. Remove the pad disc brake rear.

5. Remove the pad clip.

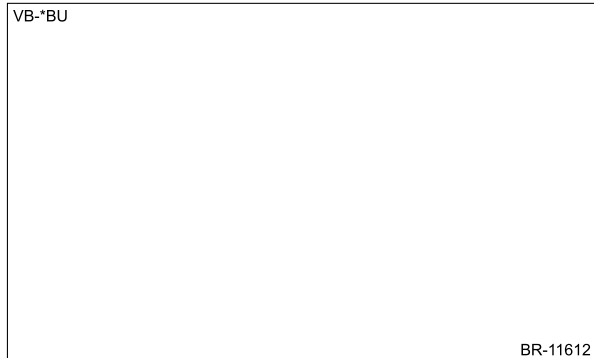

6. Remove the mounting bolts, and then remove the support rear disc brake.



2. ELECTRONIC PARKING BRAKE MODEL

Caution:

- Do not allow brake fluid to come in contact with the painted surface of the vehicle body. If it does, wash off with water and wipe away completely.
- Prepare a container to catch grease or oil, etc. If any grease or oil spills, wipe it off and clean immediately to prevent from penetrating into floor or flowing outside.
- Do not remove the parking brake actuator except when there are system malfunctions (such as emergency release of parking brake or abnormal actuator) or when the caliper is replaced. Also, when the parking brake actuator is reused, always replace the O-ring with a new part contained in the caliper body.

1. Release the parking brake.
2. Execute the brake maintenance mode.  [Ref. to PARKING BRAKE>Parking Brake System>OPERATION > BRAKE MAINTENANCE MODE.](#)
3. Disconnect the ground terminal from battery sensor.  [Ref. to REPAIR CONTENTS>NOTE > BATTERY.](#)
4. Remove the rear wheels.  [Ref. to WHEEL AND TIRE SYSTEM>Tire and Wheel>REMOVAL.](#)
5. Remove the caliper body.

Caution:

- Do not detach the brake hose rear except when replacing the caliper body.
- Install the fluid leakage protection plug to the caliper body when the brake hose rear is disconnected. If air enters or fluid leaks by tilting, replace the caliper body.

- (1) Disconnect the brake hose rear.

(2) Install the fluid leakage protection plug to the caliper body.

Preparation items:

PLUG BOLT (part No. 26642AL000)

PLUG GASKET (part No. 26642AL010)

Tightening torque:

20 N·m (2.0 kgf-m, 14.8 ft-lb)

(3) Remove the pad clip and connector.

(4) Remove the cap (a).

(5) Using a hexagon wrench, remove the guide pin rear brake (b) and remove the caliper body.

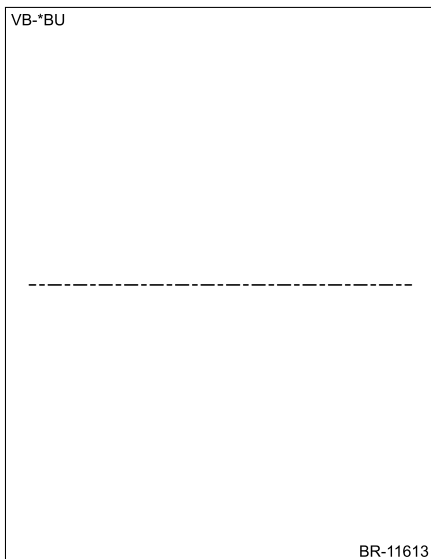

6. Remove the pad COMPL.

7. Remove the mounting bolts, and then remove the support rear disc brake.

BRAKE > Rear Disc Brake Assembly

INSTALLATION

1. EXCEPT FOR THE ELECTRONIC PARKING BRAKE MODEL

Note:

Before installation, remove mud, foreign matter, and rust from the caliper body and support rear disc brake.

1. Check each part.  [Ref. to BRAKE>Front Disc Brake Assembly>INSPECTION.](#)
2. Apply a thin coat of grease to the support rear disc brake.

Preparation items:

Grease: An item contained in the pad kit, DOW CORNING TORAY Molykote M7439 or equivalent

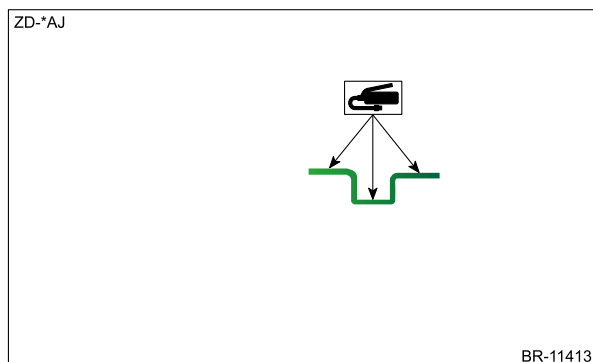

3. Apply a thin coat of grease to the pad clip.

Preparation items:

Grease: An item contained in the pad kit, DOW CORNING TORAY Molykote M7439 or equivalent

4. Install the pad clip.
5. Use new mounting bolts to install the support rear disc brake.

Tightening torque:

73 N·m (7.4 kgf-m, 53.8 ft-lb)

6. Press back the piston disc brake with a disc brake piston tool.

Caution:

When pressing back the piston disc brake, the clearance between pad disc brake and brake disc becomes large, which makes the brake pedal effort softer.
After the installation of rear wheel, be sure to perform the adjustment of the clearance and the pedal effort by depressing the brake pedal several times.

Note:

Perform this procedure only when required.

7. Install the pad disc brake rear.

Caution:

When installing, make sure that the pad wear indicator (a) comes on the lower side.

8. Install the caliper body.

Tightening torque:

27 N·m (2.8 kgf-m, 19.9 ft-lb)

9. Install the brake hose rear using a new gasket.

Tightening torque:

26 N·m (2.7 kgf-m, 19.2 ft-lb)

10. Bleed air from the brake line.  [Ref. to BRAKE>Air Bleeding>PROCEDURE > BRAKE LINE.](#)

11. Install the rear wheels.  [Ref. to WHEEL AND TIRE SYSTEM>Tire and Wheel>INSTALLATION.](#)

2. ELECTRONIC PARKING BRAKE MODEL

Note:

- Before installation, remove mud, foreign matter, and rust from the caliper body and support rear disc brake.
- Check that the ground terminal is disconnected from the battery sensor.

1. Check each part.  [Ref. to BRAKE>Rear Disc Brake Assembly>INSPECTION.](#)

2. Apply a thin coat of grease to the support rear disc brake.

Preparation items:

Grease: An item contained in the pad kit, Henkel TEROSON VR 500 or equivalent

3. Use new mounting bolts to install the support rear disc brake.

Tightening torque:

73 N·m (7.4 kgf-m, 53.8 ft-lb)

4. Install the pad COMPL.

5. Using a hexagon wrench, install the caliper body.

Tightening torque:

25 N·m (2.5 kgf-m, 18.4 ft-lb)

6. Install the cap and pad clip.

7. Connect the connector.

8. Install the brake hose rear using a new gasket.

Tightening torque:

26 N·m (2.7 kgf-m, 19.2 ft-lb)

9. Bleed air from the brake line.  [Ref. to BRAKE>Air Bleeding>PROCEDURE > BRAKE LINE.](#)

10. Connect the ground terminal to battery sensor.  [Ref. to REPAIR CONTENTS>NOTE > BATTERY.](#)

11. Exit the brake maintenance mode.  [Ref. to PARKING BRAKE>Parking Brake System>OPERATION > BRAKE MAINTENANCE MODE.](#)

12. After the operation is completed, apply and release the parking brake five times and ensure that the brake operates normally.

13. Install the rear wheels.  [Ref. to WHEEL AND TIRE SYSTEM>Tire and Wheel>INSTALLATION.](#)

BRAKE > Rear Disc Brake Assembly

DISASSEMBLY



1. EXCEPT FOR THE ELECTRONIC PARKING BRAKE MODEL

Caution:

Be careful not to allow any foreign materials to enter through the brake hose rear mounting hole on the caliper body.

Note:

Remove mud and foreign matter from the caliper body.

1. Remove the bleeder cap (a) and the bleeder screw (b) from the caliper body.

2. Remove the piston disc brake from the caliper body.

(1) Place a wooden block, etc. in the caliper body to prevent the piston disc brake from jumping out and being damaged.

(2) Using an air gun, gradually apply compressed air via the brake hose rear installation hole to push out the piston disc brake.

(a) 30 mm (1.18 in)

3. Remove the boot piston (a) and piston seal (b) from the caliper body.

Caution:

Do not damage the cylinder and piston seal groove.

4. Remove the slide pin (a), slide pin lock (b), and pin boot (c) from the support rear disc brake.

5. Remove the slide pin bushing from the slide pin lock.

2. ELECTRONIC PARKING BRAKE MODEL

Caution:

Do not remove the parking brake actuator except for the system error.

Note:

- **The piston disc brake cannot be removed from the caliper body.**
- **Remove mud and foreign matter from the caliper body.**

1. Remove the boot piston.

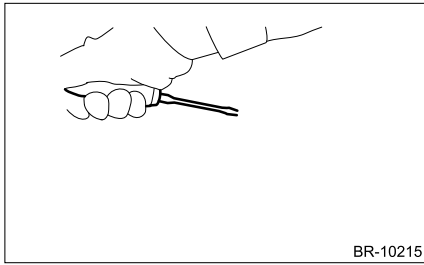

2. Remove the pin boot from caliper body.

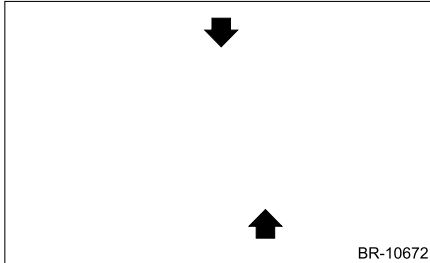

BRAKE > Rear Disc Brake Assembly

ASSEMBLY

1. EXCEPT FOR THE ELECTRONIC PARKING BRAKE MODEL

1. Check each part.  [Ref. to BRAKE>Rear Disc Brake Assembly>INSPECTION.](#)
2. Install the slide pin, slide pin lock, and pin boot to the support rear disc brake.
 - (1) Apply a thin coat of grease to the contact surface of the slide pin bushing of the slide pin lock.

Preparation items:

Grease: An item contained in the piston seal kit, NIPPON GREASE NIGLUBE RX-2 (part No. 000041000) or equivalent

- (2) Install a slide pin bushing to the slide pin lock.
- (3) Apply a thin coat of grease to the slide pin and the slide pin lock.

Preparation items:

Grease: An item contained in the piston seal kit, NIPPON GREASE NIGLUBE RX-2 (part No. 000041000) or equivalent

(4) Apply a thin coat of grease to the contact surface of the support rear disc brake pin boot and the pin sliding surface.

Preparation items:

Grease: An item contained in the piston seal kit, NIPPON GREASE NIGLUBE RX-2 (part No. 000041000) or equivalent

(5) Install a pin boot to the slide pin and the slide pin lock, and insert them into the support rear disc brake.

Caution:

After inserting the slide pin and slide pin lock into specified position, make sure that they slide and seat properly by moving each pin by hand.

3. Install the piston seal, the boot piston, and the piston disc brake to the caliper body.

(1) Clean the inside of the caliper body using brake fluid.

Preparation items:

Brake fluid:  [Ref. to BRAKE>General Description>SPECIFICATION > BRAKE FLUID.](#)

(2) Apply a thin coat of grease all around new piston seals.

Preparation items:

Grease: An item contained in the piston seal kit or equivalent

(3) Install the piston seal to the groove inside caliper body.

(4) Apply a coat of brake fluid to the entire outer surface of the piston disc brake.

Preparation items:

Brake fluid:  [Ref. to BRAKE>General Description>SPECIFICATION > BRAKE FLUID.](#)

(5) Apply a thin coat of grease to the new boot piston.

Preparation items:

Grease: An item contained in the piston seal kit or equivalent

(6) Install the boot piston to the groove on the ends of piston disc brake.

(7) Install the piston disc brake to the caliper body.

Caution:

Do not force the piston disc brake into the sliding part of caliper body.

2. ELECTRONIC PARKING BRAKE MODEL

Note:

If the brake hose rear is disconnected, air enters inside. Therefore, this operation should be performed on the vehicle without disconnecting the brake hose rear.

1. Check each part.  [Ref. to BRAKE>Rear Disc Brake Assembly>INSPECTION.](#)

2. Install the pin boot.

Note:

Place so that the pin boot A (a) comes to the upper side and the pin boot B (b) comes to the lower side when installed to the vehicle.

3. Apply a coat of grease to the inside of the new boot piston.

Preparation items:

Grease: NIPPON GREASE NIGLUBE RX-2 (part No. 000041000) or equivalent

4. Using the ST, install the boot piston.

Preparation tool:

ST: PISTON BOOT INSTALLER (99099AL000)

BRAKE > Rear Disc Brake Assembly

INSPECTION

1. Check the piston sliding part of caliper body and the piston for uneven wear, damage or rust.
2. Check the rubber parts for damage or deterioration.
3. If faulty is found in the inspection, replace the relevant part.



REMOVAL



1. EXCEPT FOR ELECTRIC BRAKE BOOSTER MODEL

Caution:

- **Do not allow brake fluid to come in contact with the painted surface of the vehicle body. If it does, wash off with water and wipe away completely.**
- **Prepare a container to catch grease or oil, etc. If any grease or oil spills, wipe it off and clean immediately to prevent from penetrating into floor or flowing outside.**
- **Before removing the master cylinder assembly, depress the brake pedal several times to make sure that the negative pressure in the vacuum booster assembly is completely removed.**
- **After the master cylinder assembly is removed, inspect the cylinder seal assembly and the sealing surface of the vacuum booster assembly.**
- **If the sealing surface of the vacuum booster assembly has a defect such as flaking paint, damage or rust, it may cause negative pressure leakage. Therefore, replace the vacuum booster assembly with a new part.**

1. Disconnect the ground terminal from battery sensor.  [Ref. to REPAIR CONTENTS>NOTE > BATTERY.](#)
2. Remove the engine control module (ECM).  [Ref. to FUEL INJECTION \(FUEL SYSTEMS\)\(H4DOTC\)>Engine Control Module \(ECM\)>REMOVAL.](#)
3. Drain brake fluid from the reservoir tank completely.
4. Remove the master cylinder assembly.
 - (1) Remove the hose clamp and disconnect the reservoir hose assembly.

(2) Remove the harness clip (a) from the bracket harness, and disconnect the connector (b) of the level indicator.



(3) Separate pipe assembly front ABS using a flare nut wrench.

(4) Remove the nuts, and slowly remove the master cylinder assembly from the vacuum booster assembly.

2. ELECTRIC BRAKE BOOSTER MODEL

Caution:

- Do not allow brake fluid to come in contact with the painted surface of the vehicle body. If it does, wash off with water and wipe away completely.
- Prepare a container to catch grease or oil, etc. If any grease or oil spills, wipe it off and clean immediately to prevent from penetrating into floor or flowing outside.

1. Disconnect the ground terminal from battery sensor.  [Ref. to REPAIR CONTENTS>NOTE > BATTERY.](#)
2. Remove the engine control module (ECM).  [Ref. to FUEL INJECTION \(FUEL SYSTEMS\)\(H4DOTC\)>Engine Control Module \(ECM\)>REMOVAL.](#)
3. Drain brake fluid from the reservoir tank completely.
4. Remove the master cylinder assembly.
 - (1) Disconnect the level indicator connector (a).
 - (2) Separate pipe assembly front ABS (b) using a flare nut wrench.
 - (3) Remove the nuts and bolts, and slowly remove the master cylinder assembly from the electric booster assembly.

BRAKE > Master Cylinder

INSTALLATION

1. EXCEPT FOR ELECTRIC BRAKE BOOSTER MODEL

1. Apply grease to the cylinder seal assembly, vacuum booster assembly, and master cylinder assembly.

Caution:
Be careful not to mix up application locations of each grease.

(1) Apply fluorine grease to the entire outer diameter of a new cylinder seal assembly and the entire contact surface of the vacuum booster assembly with the master cylinder assembly.

Caution:
Apply fluorine grease to the entire circumference. Areas where application was missed may cause rust.

Preparation items:

Grease: An item contained in the seal kit (fluorine grease) or equivalent

- (a) Cylinder seal ASSY
- (b) Vacuum booster ASSY
- (c) Fluorine grease application location

(2) Apply silicone grease to the entire circumference on the piston rod of the master cylinder assembly and the entire inner diameter of a new cylinder seal assembly.

Preparation items:

Grease: An item contained in the seal kit (silicone grease) or equivalent

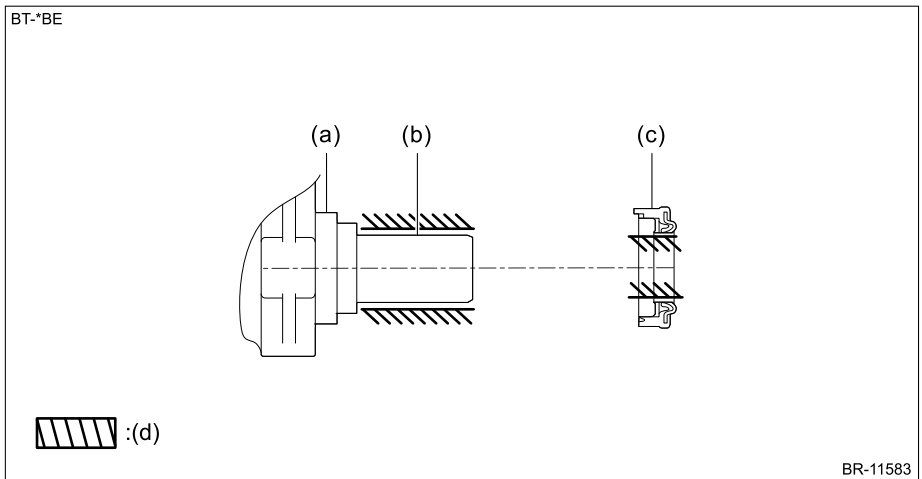

- (a) Master cylinder ASSY
- (b) Piston rod portion
- (c) Cylinder seal ASSY
- (d) Silicone grease application location

2. Install a new cylinder seal assembly to the master cylinder assembly.

Caution:

Be careful not to install the cylinder seal assembly in the wrong location.

(a) Cylinder seal ASSY installation surface (b) Piston rod portion (c) Cylinder seal ASSY

3. Use a new nut to install the master cylinder assembly.

Tightening torque:

13 N·m (1.3 kgf-m, 9.6 ft-lb)

4. Install the pipe assembly front ABS.

Caution:

Be careful not to make scratches or other damage to the inside surface of the brake pipe flare.

- (1) Turn and tighten the flare nut (b) by hand while pushing the pipe assembly front ABS (a) away from yourself.
(2) Tighten the flare nut (b) using a flare nut wrench and a crowfoot wrench.

Note:

If the work can be performed with the front and back sides reversed, it is also possible to use a 6-point crowfoot wrench.



Tightening torque:

Calculation formula
$T = 19 \text{ N}\cdot\text{m} (1.9 \text{ kgf}\cdot\text{m}, 14.0 \text{ ft}\cdot\text{lb}) \times L1 / (L1 + L2)$
T: Reading of the torque wrench L1: Effective length of the torque wrench L2: Effective length of the crowfoot wrench

Note:

If the effective length of the tool used is unknown, consult the manufacturer of the tool.

- (a) Effective length of the crowfoot wrench (L2)
- (b) Effective length of the torque wrench (L1)
- (c) Center of the open end of crowfoot wrench
- (d) Center of drive square of the torque wrench
- (e) Center of the position where a force is applied by hand

5. Connect the level indicator connector.
6. Install the reservoir hose assembly.
7. Install the engine control module (ECM).  [Ref. to FUEL INJECTION \(FUEL SYSTEMS\)\(H4DOTC\)>Engine Control Module \(ECM\)>INSTALLATION.](#)
8. Bleed air from the brake system and clutch system.  [Ref. to BRAKE>Air Bleeding>PROCEDURE.](#)
9. Connect the ground terminal to battery sensor.  [Ref. to REPAIR CONTENTS>NOTE > BATTERY.](#)

2. ELECTRIC BRAKE BOOSTER MODEL

1. Install a new cylinder seal assembly to the master cylinder assembly.

Caution:

Be careful not to install the cylinder seal assembly (a) in the wrong location.

2. Use a bolt and a new nut to install the master cylinder assembly.

Tightening torque:

Flange bolt: 18 N·m (1.8 kgf-m, 13.3 ft-lb)

Nut: 20 N·m (2.0 kgf-m, 14.8 ft-lb)

3. Install the pipe assembly front ABS.

Caution:

Be careful not to make scratches or other damage to the inside surface of the brake pipe flare.



- (1) Turn and tighten the flare nut (b) by hand while pushing the pipe assembly front ABS (a) away from yourself.
- (2) Tighten the flare nut (b) using a flare nut wrench and a crowfoot wrench.

Note:

If the work can be performed with the front and back sides reversed, it is also possible to use a 6-point crowfoot wrench.

Tightening torque:

Calculation formula
$T = 19 \text{ N}\cdot\text{m} (1.9 \text{ kgf}\cdot\text{m}, 14.0 \text{ ft}\cdot\text{lb}) \times L1 / (L1 + L2)$
T: Reading of the torque wrench L1: Effective length of the torque wrench L2: Effective length of the crowfoot wrench
Note: If the effective length of the tool used is unknown, consult the manufacturer of the tool.
(a) Effective length of the crowfoot wrench (L2) (b) Effective length of the torque wrench (L1) (c) Center of the open end of crowfoot wrench (d) Center of drive square of the torque wrench (e) Center of the position where a force is applied by hand

4. Connect the level indicator connector.
5. Install the engine control module (ECM).  [Ref. to FUEL INJECTION \(FUEL SYSTEMS\)\(H4DOTC\)>Engine Control Module \(ECM\)>INSTALLATION.](#)
6. Bleed air from the brake system.  [Ref. to BRAKE>Air Bleeding>PROCEDURE.](#)
7. Connect the ground terminal to battery sensor.  [Ref. to REPAIR CONTENTS>NOTE > BATTERY.](#)

BRAKE > Master Cylinder

DISASSEMBLY



1. Remove the reservoir tank.
 - (1) Place the master cylinder assembly between aluminum plates and fix it on a vise.

Caution:

Be careful not to tighten a vise excessively.

- (2) Drive out the pin using a punch and a hammer to remove the reservoir tank.

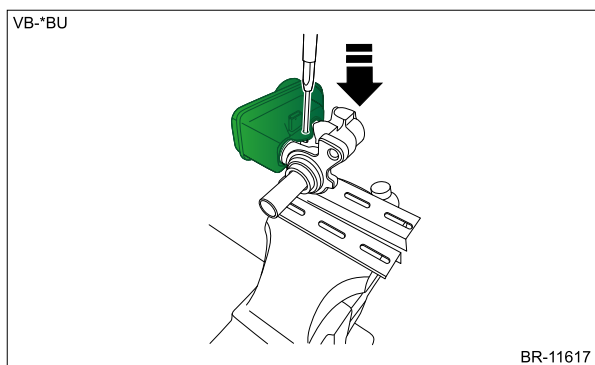

2. Remove the seal reservoir from the master cylinder assembly.
- Except for electric brake booster model

- Electric brake booster model

BRAKE > Master Cylinder

ASSEMBLY

Caution:

**When replacing the reservoir tank, adhere the brake fluid caution label (a) to the position shown in the figure.
(Except for electric brake booster model (for C0))**

Preparation items:

Brake fluid caution label (part No. 25080GA010)

1. Install the seal reservoir to the master cylinder assembly.
2. Install the reservoir tank.
 - (1) Place the master cylinder assembly between aluminum plates and fix it on a vise.

Caution:

Be careful not to tighten a vise excessively.

- (2) Drive a new pin using a punch and a hammer to install the reservoir tank.



REMOVAL



1. EXCEPT FOR ELECTRIC BRAKE BOOSTER MODEL

Caution:

- Do not allow brake fluid to come in contact with the painted surface of the vehicle body. If it does, wash off with water and wipe away completely.
- Before handling the airbag system components, refer to "CAUTION" of "General Description" in "AIRBAG SYSTEM".
 [Ref. to AIRBAG SYSTEM>General Description>CAUTION.](#)
- If the master cylinder assembly has been removed, inspect the sealing surfaces of the cylinder seal assembly and the vacuum booster assembly.
- If the sealing surface of the vacuum booster assembly has a defect such as flaking paint, damage or rust, it may cause negative pressure leakage. Therefore, replace the vacuum booster assembly with a new part.
- Do not disassemble the vacuum booster assembly.
- Make sure that the booster shell and vacuum pipe are not subject to strong impacts.
- Be careful not to drop the vacuum booster assembly. If the vacuum booster assembly is dropped accidentally, replace it.
- Place the removed vacuum booster assembly as shown in the figure below and be careful not to apply a force (a) from above. If a force (a) from above is applied, the resin (b) may become damaged.

1. Disconnect the ground terminal from the battery sensor, and wait for at least 60 seconds before starting work.  [Ref. to REPAIR CONTENTS>NOTE > BATTERY.](#)
2. Remove the intercooler.  [Ref. to INTAKE \(INDUCTION\)\(H4DOTC\)>Intercooler>REMOVAL.](#)
3. Remove the engine control module (ECM).  [Ref. to FUEL INJECTION \(FUEL SYSTEMS\)\(H4DOTC\)>Engine Control Module \(ECM\)>REMOVAL.](#)
4. Remove the hose clamp and disconnect the vacuum hose COMPL.

5. Remove the master cylinder assembly.  [Ref. to BRAKE>Master Cylinder>REMOVAL > EXCEPT FOR ELECTRIC BRAKE BOOSTER MODEL.](#)
6. Disconnect the vacuum sensor assembly connector.

Caution:

- **Do not remove the vacuum sensor assembly. If removed, replace the vacuum booster assembly with a new part.**
- **Do not rotate the vacuum sensor assembly when disconnecting the connector of vacuum sensor assembly. Otherwise the grommet on the mounting location of the vacuum sensor assembly may be damaged.**

7. Remove the clutch pipe.  [Ref. to CLUTCH SYSTEM>Clutch Pipe and Hose>REMOVAL.](#)

8. Remove the pipe assembly front ABS.

(1) Separate pipe assembly front ABS using a flare nut wrench.

(2) Release the pipe clamps, and remove the pipe assembly front ABS.

9. Remove the cover LWR driver.  [Ref. to EXTERIOR/INTERIOR TRIM>Instrument Panel Lower Cover>REMOVAL.](#)

10. Remove the knee airbag module.  [Ref. to AIRBAG SYSTEM>Knee Airbag Module>REMOVAL.](#)

11. Remove the duct foot driver.  [Ref. to AIR CONDITIONER>Air Vent Duct>REMOVAL > FOOT DUCT.](#)

12. Remove the snap pin (a) and clevis pin (b), and remove the operating rod from the pedal COMPL brake.

Caution:



- **Be careful not to apply excessive force to the operating rod when handling the operating rod. The angle may change by $\pm 3^\circ$, and it may result in damage to power piston cylinder.**
- **Do not change the push rod length.**

13. Remove the nuts, and then remove the vacuum booster assembly.

2. ELECTRIC BRAKE BOOSTER MODEL

Caution:

- Do not allow brake fluid to come in contact with the painted surface of the vehicle body. If it does, wash off with water and wipe away completely.
- Before handling the airbag system components, refer to "CAUTION" of "General Description" in "AIRBAG SYSTEM".
 [Ref. to AIRBAG SYSTEM>General Description>CAUTION.](#)
- Do not disassemble the electric booster assembly.
- Be careful not to drop the electric booster assembly. If the electric booster assembly is dropped accidentally, replace it.
- Place the removed electric booster assembly as shown in the figure below and be careful not to apply a force (a) from above. If a force (a) from above is applied, the internal mechanical part (b) may become damaged.

1. Disconnect the ground terminal from the battery sensor, and wait for at least 60 seconds before starting work.  [Ref. to REPAIR CONTENTS>NOTE > BATTERY.](#)
2. Remove the intercooler.  [Ref. to INTAKE \(INDUCTION\)\(H4DOTC\)>Intercooler>REMOVAL.](#)
3. Remove the engine control module (ECM).  [Ref. to FUEL INJECTION \(FUEL SYSTEMS\)\(H4DOTC\)>Engine Control Module \(ECM\)>REMOVAL.](#)
4. Pull up the lock lever (b) while pressing the lock button (a) and disconnect the connector.

5. Remove the harness clip from the bracket harness electric booster.

6. Disconnect connectors.

7. Remove the pipe assembly front ABS.

(1) Separate pipe assembly front ABS using a flare nut wrench.

(2) Release the pipe clamps, and remove the pipe assembly front ABS.

8. Remove the cover LWR driver.  [Ref. to EXTERIOR/INTERIOR TRIM>Instrument Panel Lower Cover>REMOVAL.](#)

9. Remove the knee airbag module.  [Ref. to AIRBAG SYSTEM>Knee Airbag Module>REMOVAL.](#)

10. Remove the duct foot driver.  [Ref. to AIR CONDITIONER>Air Vent Duct>REMOVAL > FOOT DUCT.](#)

11. Remove the snap pin (a) and clevis pin (b), and remove the operating rod from the pedal COMPL brake.

Caution:

- Be careful not to apply excessive force to the operating rod when handling the operating rod. The angle may change by $\pm 3^\circ$, and it may result in damage to power piston cylinder.
- Do not change the push rod length.

12. Remove the nuts, and remove the electric booster assembly.

13. Remove the master cylinder assembly from the electric booster assembly.  [Ref. to BRAKE>Master Cylinder>REMOVAL > ELECTRIC BRAKE BOOSTER MODEL.](#)

Note:

Perform this procedure only when required.

BRAKE > Brake Booster

INSTALLATION

1. EXCEPT FOR ELECTRIC BRAKE BOOSTER MODEL

Caution:

Before handling the airbag system components, refer to "CAUTION" of "General Description" in "AIRBAG SYSTEM".

 [Ref. to AIRBAG SYSTEM>General Description>CAUTION.](#)

1. Check the operating rod of the vacuum booster assembly.

(1) Check the length (a) between the vacuum booster assembly mounting surface and clevis pin hole.

Specification:

136.3 mm (5.37 in)

(2) If the inspection result is not within the standard value, loosen the lock nuts of operating rod, and rotate the rod to adjust the length within the specification.

(3) Tighten the lock nut.

Note:

Check the brake pedal height. When adjusting, also adjust the stop light switch assembly.

Tightening torque:

18 N·m (1.8 kgf-m, 13.3 ft-lb)

2. Apply grease to the cylinder seal assembly, vacuum booster assembly, and master cylinder assembly.

Caution:

Be careful not to mix up application locations of each grease.

- (1) Apply fluorine grease to the entire outer diameter of a new cylinder seal assembly and the entire contact surface of the vacuum booster assembly with the master cylinder assembly.

Caution:

Apply fluorine grease to the entire circumference. Areas where application was missed may cause rust.

Preparation items:

Grease: An item contained in the seal kit (fluorine grease) or equivalent

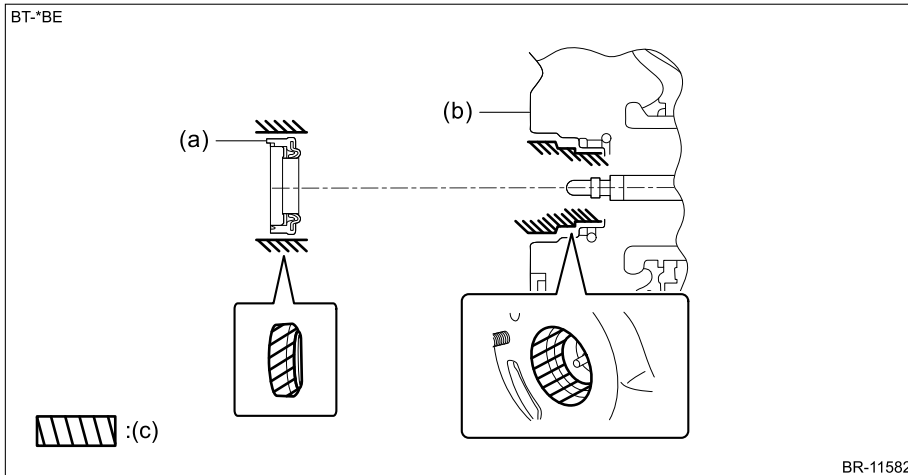

(a) Cylinder seal ASSY

(b) Vacuum booster ASSY

(c) Fluorine grease application location

- (2) Apply silicone grease to the entire circumference on the piston rod of the master cylinder assembly and the entire inner diameter of a new cylinder seal assembly.

Preparation items:

Grease: An item contained in the seal kit (silicone grease) or equivalent

(a) Master cylinder ASSY

(c) Cylinder seal ASSY

(d) Silicone grease application location

(b) Piston rod portion

3. Install a new cylinder seal assembly to the master cylinder assembly.

Caution:

Be careful not to install the cylinder seal assembly in the wrong location.

(a) Cylinder seal ASSY installation surface (b) Piston rod portion (c) Cylinder seal ASSY

4. Install the vacuum booster assembly.

Caution:

- **Replace the gasket booster with a new part.**
- **Use a wobble extension for torque tightening to prevent interference with the column assembly steering.**

Tightening torque:

18 N·m (1.8 kgf-m, 13.3 ft-lb)

5. Install the master cylinder assembly.  [Ref. to BRAKE>Master Cylinder>INSTALLATION > EXCEPT FOR ELECTRIC BRAKE BOOSTER MODEL.](#)

6. Install the operating rod to the pedal COMPL brake.

(1) Apply a thin coat of grease to the new clevis pin.

Preparation items:

Grease: NIPPON GREASE NIGTIGHT LTS No. 2 or equivalent

(2) Using a clevis pin and a snap pin, install the operating rod to the pedal COMPL brake.

7. Install the duct foot driver.  [Ref. to AIR CONDITIONER>Air Vent Duct>INSTALLATION > FOOT DUCT.](#)

8. Install the knee airbag module.  [Ref. to AIRBAG SYSTEM>Knee Airbag Module>INSTALLATION.](#)

9. Install the cover LWR driver.  [Ref. to EXTERIOR/INTERIOR TRIM>Instrument Panel Lower Cover>INSTALLATION.](#)

10. Install the pipe assembly front ABS using a flare nut wrench and a crowfoot wrench.

Note:

If the work can be performed with the front and back sides reversed, it is also possible to use a 6-point crowfoot wrench.

Tightening torque:

Calculation formula
$T = 19 \text{ N}\cdot\text{m} (1.9 \text{ kgf}\cdot\text{m}, 14.0 \text{ ft}\cdot\text{lb}) \times L1 / (L1 + L2)$
T: Reading of the torque wrench
L1: Effective length of the torque wrench
L2: Effective length of the crowfoot wrench

Note:

If the effective length of the tool used is unknown, consult the manufacturer of the tool.

- (a) Effective length of the crowfoot wrench (L2)
- (b) Effective length of the torque wrench (L1)
- (c) Center of the open end of crowfoot wrench
- (d) Center of drive square of the torque wrench
- (e) Center of the position where a force is applied by hand

11. Install the clutch pipe.  [Ref. to CLUTCH SYSTEM>Clutch Pipe and Hose>INSTALLATION.](#)

12. Connect the vacuum sensor assembly connector.

13. Install the vacuum hose COMPL.

14. Install the engine control module (ECM).  [Ref. to FUEL INJECTION \(FUEL SYSTEMS\)\(H4DOTC\)>Engine Control Module \(ECM\)>INSTALLATION.](#)

15. Install the intercooler.  [Ref. to INTAKE \(INDUCTION\)\(H4DOTC\)>Intercooler>INSTALLATION.](#)

16. Bleed air from the brake system and clutch system.  [Ref. to BRAKE>Air Bleeding>PROCEDURE.](#)

17. Connect the ground terminal to battery sensor.  [Ref. to REPAIR CONTENTS>NOTE > BATTERY.](#)

18. Perform a road test to make sure the brakes do not drag.

2. ELECTRIC BRAKE BOOSTER MODEL

Caution:

- Before handling the airbag system components, refer to "CAUTION" of "General Description" in "AIRBAG SYSTEM".
 [Ref. to AIRBAG SYSTEM>General Description>CAUTION.](#)
- When the electric booster assembly is replaced, be sure to perform the module registration.

1. Install the master cylinder assembly.  [Ref. to BRAKE>Master Cylinder>INSTALLATION > ELECTRIC BRAKE BOOSTER MODEL.](#)

2. Install the electric booster assembly.

Caution:

- Replace gasket A and gasket B with new parts.
- Use a wobble extension for torque tightening to prevent interference with the column assembly steering.

Tightening torque:

18 N·m (1.8 kgf-m, 13.3 ft-lb)



3. Install the operating rod to the pedal COMPL brake.

(1) Apply a thin coat of grease to the new clevis pin.

Preparation items:

Grease: NIPPON GREASE NIGTIGHT LTS No. 2 or equivalent

(2) Using a clevis pin and a snap pin, install the operating rod to the pedal COMPL brake.





4. Install the duct foot driver.  [Ref. to AIR CONDITIONER>Air Vent Duct>INSTALLATION > FOOT DUCT.](#)
5. Install the knee airbag module.  [Ref. to AIRBAG SYSTEM>Knee Airbag Module>INSTALLATION.](#)
6. Install the cover LWR driver.  [Ref. to EXTERIOR/INTERIOR TRIM>Instrument Panel Lower Cover>INSTALLATION.](#)
7. Install the pipe assembly front ABS using a flare nut wrench and a crowfoot wrench.

Note:

If the work can be performed with the front and back sides reversed, it is also possible to use a 6-point crowfoot wrench.

Tightening torque:

Calculation formula
$T = 19 \text{ N}\cdot\text{m} (1.9 \text{ kgf}\cdot\text{m}, 14.0 \text{ ft}\cdot\text{lb}) \times L1 / (L1 + L2)$
T: Reading of the torque wrench L1: Effective length of the torque wrench L2: Effective length of the crowfoot wrench
Note: If the effective length of the tool used is unknown, consult the manufacturer of the tool.
(a) Effective length of the crowfoot wrench (L2) (b) Effective length of the torque wrench (L1) (c) Center of the open end of crowfoot wrench (d) Center of drive square of the torque wrench (e) Center of the position where a force is applied by hand

8. Connect each connector.
9. Install the engine control module (ECM).  [Ref. to FUEL INJECTION \(FUEL SYSTEMS\)\(H4DOTC\)>Engine Control Module \(ECM\)>INSTALLATION.](#)
10. Install the intercooler.  [Ref. to INTAKE \(INDUCTION\)\(H4DOTC\)>Intercooler>INSTALLATION.](#)
11. Bleed air from the brake system.  [Ref. to BRAKE>Air Bleeding>PROCEDURE.](#)
12. Connect the ground terminal to battery sensor.  [Ref. to REPAIR CONTENTS>NOTE > BATTERY.](#)
13. When the electric booster assembly is replaced, perform the module registration.  [Ref. to COMMON \(DIAGNOSTICS\)>Unit Registration>OPERATION.](#)

- 14. Check that the brake light operate properly.
- 15. Check the brake pedal.  [Ref. to BRAKE>Brake Pedal>INSPECTION.](#)
- 16. Perform a road test to make sure the brakes do not drag.

BRAKE > Brake Booster

INSPECTION

1. EXCEPT FOR ELECTRIC BRAKE BOOSTER MODEL

Caution:
When checking operation, be sure to apply the parking brake securely.

• WHEN NOT USING MEASURING DEVICE

Note:
When an operation check is performed with no measuring devices, a faulty part cannot be identified correctly. But it is possible to identify the outline of the defect by performing the check according to the following procedures.

- Air tightness check

Note:

- **In case of defective operation, inspect the sealing surface conditions of check valve, vacuum hose, and cylinder seal assembly and vacuum booster assembly.**
- **If parts are damaged, or the sealing surface of the vacuum booster assembly has a defect such as flaking paint, damage or rust, it may cause negative pressure leakage. Therefore, replace the parts and perform the test again.**
- **If no improvement is observed, check precisely with gauges.**

1. Start the engine, and idle it for 1 to 2 minutes, then turn it OFF.
2. Depress the brake pedal several times applying the normal pedal force.

Note:
The pedal stroke should be the longest at the 1st depression, and it should become shorter at each successive depression.

3. If no change occurs in the pedal height when pressed, the vacuum booster assembly is faulty.

- (A) Normal
- (B) Not OK

- (a) 1st
- (b) 2nd
- (c) 3rd

- Check operation

Note:
If a faulty part is detected after inspection, check precisely with measuring devices.

1. While the engine is OFF, depress the brake pedal several times applying the same pedal force, to check for a change in pedal height.

(A) When engine is stopped

(B) When engine is started

2. With the brake pedal depressed, start the engine.
3. As the engine starts, the brake pedal should move slowly toward the floor. If the brake pedal height does not change, the vacuum booster assembly is faulty.

- Loaded air tightness check

Note:

If a faulty part is detected after inspection, check precisely with measuring devices.

1. Depress the brake pedal while the engine is running, and turn the engine to OFF while the pedal is depressed.
2. Keep the pedal depressed for 30 seconds. If the pedal height does not change, the function of vacuum booster assembly is normal. If the pedal height increases, it is faulty.

- **WHEN USING MEASURING DEVICE**

Note:

When using a measuring device to check operation, connect the measuring device as shown in the figure. After bleeding air from the pressure gauge, perform each check.

(a) Pressure gauge

(c) Adapter hose

(e) Pedal force gauge

(b) Vacuum gauge

(d) Vacuum hose

- Air tightness check

1. Start the engine and keep it running at idle until vacuum pressure indicates 66.7 kPa (500 mmHg, 19.69 inHg) while the brake pedal is not depressed.

- (a) Pressure gauge (b) Vacuum gauge

2. Stop the engine and check the vacuum pressure.

If the value matches the following standard, the vacuum booster assembly function is normal.

Standard

The range of vacuum pressure drop within 15 seconds after stopping the engine is 3.3 kPa (25 mmHg, 0.98 inHg) or less

If a faulty part is detected after inspection, it may result from one of the following causes.

- Check valve malfunction
- Leak from vacuum hose
- Leak from shell joint section or stud bolt welded section
- Damaged diaphragm
- Leak from valve body seal and bearing section
- Leak from plate and seal assembly section
- Leak from poppet valve assembly section

• Loaded air tightness check

1. Start the engine and depress the brake pedal with a pedal force of 196 N (20 kgf, 44 lbf).
2. Keep the engine running at idle and the pedal depressed until vacuum pressure of the vacuum gauge indicates 93 kPa (697 mmHg, 27.47 inHg).

- (a) Pressure gauge (b) Vacuum gauge (c) Pedal force gauge (d) Depressed

3. Stop the engine and check the vacuum pressure.

If the value matches the following standard, the vacuum booster assembly function is normal.

Standard

The range of vacuum pressure drop within 15 seconds after stopping the engine is 3.3 kPa (25 mmHg, 0.98 inHg) or less

If a faulty part is detected after inspection, refer to "AIR TIGHTNESS CHECK".  [Ref. to BRAKE>Brake Booster>INSPECTION.](#)

4. If the vacuum booster assembly is faulty, replace it with a new part.

• Lack of boost action check

1. Turn the engine OFF, and set the value of the vacuum gauge to "0".
2. Check the brake fluid pressure when the brake pedal is depressed. The pressure must be greater than the specification listed.

Brake pedal force: N (kgf, lbf)	147 (15, 33)	294 (30, 66)
Brake fluid pressure: kPa (kgf/cm ² , psi)	380 (3.8, 55)	1,465 (14.9, 212)

- Boosting action check
 1. Set the vacuum gauge reading to 93 kPa (697 mmHg, 27.47 inHg) with the engine running.
 2. Check the brake fluid pressure when the brake pedal is depressed. The pressure must be greater than the specification listed.

Brake pedal force: N (kgf, lbf)	147 (15, 33)	294 (30, 66)
Brake fluid pressure: kPa (kgf/cm ² , psi)	9,218 (93.9, 1,336)	16,120 (164, 2,338)

2. ELECTRIC BRAKE BOOSTER MODEL

• VEHICLE CHECK IN A LACK-OF-BOOST-ACTION STATE

1. Remove the fuse (a) of electric brake booster from the sub fuse box.

2. Depress the brake pedal several times by applying the same pedal force and check for a change in pedal height.

• VEHICLE CHECK IN A BOOST-ACTION STATE

1. Install the fuse of electric brake booster.
2. Turn the ignition switch to ON.
3. Depress the brake pedal several times by applying the same pedal force and check for a change in pedal height.
4. Comparing to the lack-of-boost-action state, if no change occurs in the pedal height when depressed, the electric brake booster is faulty.
5. If the electric brake booster still does not operate properly, perform the following diagnostic procedures.  [Ref. to ELECTRIC BRAKE BOOSTER \(DIAGNOSTICS\)>Basic Diagnostic Procedure.](#)

• UNIT INSPECTION

Dimension (A) at the time of electric booster assembly shipping is as shown in the figure below.

(A) 141.3 mm (5.56 in)

Tightening torque:

T: 18 N·m (1.8 kgf-m, 13.3 ft-lb)

Note:

Dimension (A) is the dimension when part (B) in the figure below is removed.

BRAKE > Brake Fluid

INSPECTION

Caution:

- Do not let brake fluid come into contact with the painted surface of the vehicle.
Wash away with water immediately and wipe off if it is spilled by accident.
- Do not mix different kinds of brake fluid.
- Do not allow water or foreign matter to enter the reservoir tank.
- Always use new brake fluid when replacing or refilling the brake fluid.

1. Park the vehicle on a level surface.
2. Check the brake fluid for discoloration.
3. Check that the amount of brake fluid is between the lines of "MIN" and "MAX" from the front view or from the forward right and left within 90°.

Caution:

- Always check the level using the specified direction because there is a partition in the reservoir tank.
 - When using a tool such as a dropper to adjust the fluid amount, do not use one that has been utilized for deteriorated brake fluid or other liquids.
Doing so may cause the sealing parts or brake fluid to deteriorate, resulting in a malfunction.
- Except for electric brake booster model

(a) "MAX"

(b) "MIN"

(c) Brake fluid

- Electric brake booster model

(a) "MAX"

(b) "MIN"

(c) Brake fluid

4. If the brake fluid level is close to "MIN", check the brake pipe or brake hose for any leak first. Then, check that the brake fluid level is reduced due to brake pad wear.
5. If the fluid is extremely discolored or the brake fluid level is less than the specified value after inspection, replenish or replace with the new fluid.

BRAKE > Brake Fluid

REPLACEMENT

Caution:

- Do not let brake fluid come into contact with the painted surface of the vehicle.
Wash away with water immediately and wipe off if it is spilled by accident.
- Do not mix different kinds of brake fluid.
- Do not allow water or foreign matter to enter the reservoir tank.
- Always use new brake fluid when replacing or refilling the brake fluid.
- During the operation, keep the reservoir tank filled with brake fluid at "MIN level" or higher to prevent entry of air.

Note:

- Operate the brake pedal slowly and depress it fully.
- For convenience and safety, perform the work with 2 people.
- The required amount of brake fluid is approximately 500 mL (16.9 US fl oz, 17.6 Imp fl oz) for the entire brake system.

1. Remove the wheels.  [Ref. to WHEEL AND TIRE SYSTEM>Tire and Wheel>REMOVAL.](#)
2. Drain brake fluid from the reservoir tank.

Caution:

**When using a tool such as a dropper to adjust the fluid amount, do not use one that has been utilized for deteriorated brake fluid or other liquids.
Doing so may cause the sealing parts or brake fluid to deteriorate, resulting in a malfunction.**

3. Replenish the reservoir tank with the brake fluid, and perform the same procedure as for air bleeding of the brake line on each brake caliper.  [Ref. to BRAKE>Air Bleeding>PROCEDURE.](#)

Note:

Repeat the full stroke depressing operation of the brake pedal slowly, until new brake fluid comes out from a transparent vinyl tube, etc. (On each brake caliper, 20 times or more of pedal operations is necessary in order for new brake fluid from the master cylinder assembly to come out from the bleeder screw.)





Preparation items:

Brake fluid:  [Ref. to BRAKE>General Description>SPECIFICATION > BRAKE FLUID.](#)

BRAKE > Air Bleeding

PROCEDURE

For air bleed procedure of each part, refer to the following.



- Master cylinder:  [Ref. to BRAKE>Air Bleeding>PROCEDURE > MASTER CYLINDER.](#)
- Brake line:  [Ref. to BRAKE>Air Bleeding>PROCEDURE > BRAKE LINE.](#)
- VDC CM&H/U:  [Ref. to BRAKE>Air Bleeding>PROCEDURE > VDC CM&H/U.](#)
- Caliper:  [Ref. to BRAKE>Air Bleeding>PROCEDURE > CALIPER.](#)

1. MASTER CYLINDER

Caution:

- **During the operation, remove the fuse of electric brake booster from the sub fuse box to prevent the electric brake booster from starting. (Electric brake booster model)**
- **Do not let brake fluid come into contact with the painted surface of the vehicle. Wash away with water immediately and wipe off if it is spilled by accident.**
- **Do not mix different kinds of brake fluid.**
- **Do not allow water or foreign matter to enter the reservoir tank.**
- **Always use new brake fluid when replacing or refilling the brake fluid.**
- **During the operation, keep the reservoir tank filled with brake fluid at "MIN level" or higher to prevent entry of air.**
- **After air bleeding operation, wipe off the brake fluid around each bleeder screw and the reservoir tank.**

Note:

- **When the master cylinder assembly is replaced or the reservoir tank is empty, bleed air from the brake master cylinder and the clutch master cylinder (MT model).
For air bleeding of the clutch system, refer to "Air Bleeding" in "CLUTCH SYSTEM" section.  [Ref. to CLUTCH SYSTEM>Air Bleeding>PROCEDURE.](#)**
- **If air bleeding operation of the master cylinder assembly is not necessary, omit the following procedures, and perform air bleeding of the brake line.  [Ref. to BRAKE>Air Bleeding>PROCEDURE > BRAKE LINE.](#)**
- **For convenience and safety, perform the work with 2 people.**

1. Remove the fuse (a) of electric brake booster from the sub fuse box. (Electric brake booster model)

Note:

This operation is not required if the ground terminal is already removed from the battery sensor.

2. Install the brake pipe to the master cylinder assembly.

Caution:

Be careful not to make scratches or other damage to the inside surface of the brake pipe flare.

- (1) Turn and tighten the flare nut (b) by hand while pressing the brake pipe (a) toward the master cylinder assembly side.
- (2) Tighten the flare nut (b) using a flare nut wrench and a crowfoot wrench.

Note:

If the work can be performed with the front and back sides reversed, it is also possible to use a 6-point crowfoot wrench.

Tightening torque:

Calculation formula
$T = 19 \text{ N}\cdot\text{m} (1.9 \text{ kgf}\cdot\text{m}, 14.0 \text{ ft}\cdot\text{lb}) \times L1 / (L1 + L2)$
T: Reading of the torque wrench L1: Effective length of the torque wrench L2: Effective length of the crowfoot wrench
Note: If the effective length of the tool used is unknown, consult the manufacturer of the tool.
(a) Effective length of the crowfoot wrench (L2) (b) Effective length of the torque wrench (L1) (c) Center of the open end of crowfoot wrench (d) Center of drive square of the torque wrench (e) Center of the position where a force is applied by hand

3. Add the brake fluid to the "MAX".
4. Connect a transparent vinyl tube, etc. to the bleeder screw of the right front caliper body, and the other end of the vinyl tube to a collection container.
5. Loosen the bleeder screw, depress the brake pedal slowly and hold it.
6. Tighten the bleeder screw, and release the brake pedal quickly.
7. Repeat steps 5. and 6. until there are no more air bubbles in the brake fluid in the tube.

Note:

Air bubbles are removed after repeating the procedures six to seven times.

8. Connect a transparent vinyl tube to the bleeder screw of the left front caliper body, and the other end of the vinyl tube to a collection container.
9. Repeat steps 5. and 6. until there are no more air bubbles in the brake fluid in the tube.

Note:

- **Air bubbles are removed after repeating the procedures seven to eight times.**
 - **With the procedures so far, bleed is completed for the air that entered in the master cylinder, front brake piping hose passages and front caliper.**
- Next, perform the following procedures to bleed air that entered in the rear brake piping hose passages and rear caliper from the VDC CM&H/U.**

10. Connect a transparent vinyl tube to the bleeder screw of the left rear caliper body, and the other end of the vinyl tube to a collection container.

11. Loosen the bleeder screw, and repeat the full stroke depressing operation of the brake pedal slowly, until the brake fluid in the tube has no more air bubbles, then tighten the bleeder screw.

Note:

- **By repeating the procedures 15 times or more, air that entered in the rear brake pipe passages from the VDC CM&H/U reaches the bleeder screw of the left rear caliper body and is discharged.**

12. Connect a transparent vinyl tube to the bleeder screw of the right rear caliper body, and the other end of the vinyl tube to a collection container.

13. Perform step 11.

Note:

- **By repeating the procedures 10 times or more, air that entered in the rear brake pipe passages from the VDC CM&H/U reaches the bleeder screw of the right rear caliper body and is discharged.**
 - **With the procedures so far, bleeding of the air that entered in the rear brake piping hose passages and rear caliper from the VDC CM&H/U is completed.**
- Lastly, perform the following procedures to bleed air that may remain in areas where the brake fluid flow stands.**

14. Connect a transparent vinyl tube, etc. to the bleeder screw of the right front caliper body, and the other end of the vinyl tube to a collection container.

15. After repeating firmly depressing of the brake pedal quickly 5 to 6 times, depress and hold the pedal.

16. Loosen the bleeder screw to drain brake fluid. When the brake pedal reaches the full stroke position, tighten the bleeder screw quickly, and release the brake pedal.

17. Repeat steps 15. and 16. until there are no more air bubbles in the tube.

Note:

- **Repeat the procedures approximately four to five times.**

18. Repeat steps 15. to 17. above for each brake caliper.

Note:

- **Bleed air in the order starting from the front RH → front LH → rear LH → rear RH.**

19. Tighten each bleeder screw to the specified torque.

Tightening torque:

Front: 8 N·m (0.8 kgf-m, 5.9 ft-lb)

Rear (except for the electronic parking brake model): 8 N·m (0.8 kgf-m, 5.9 ft-lb)

Rear (electronic parking brake model): 17 N·m (1.7 kgf-m, 12.5 ft-lb)

20. Install the bleeder cap to each bleeder screw.

21. Install the fuse (a) of electric brake booster. (Electric brake booster model)

Note:

- **Perform this operation only when the fuse of electric brake booster is removed.**

- 22. Check that the electric brake booster operates normally. (Electric brake booster model)
- 23. Check that there are no brake fluid leaks at the flare nut portion or in the entire brake system.
- 24. After inspection, wipe off the brake fluid around each bleeder screw and the reservoir tank.
- 25. Perform a road test and ensure that the brakes operate normally.

2. BRAKE LINE

Caution:

- During the operation, remove the fuse of electric brake booster from the sub fuse box to prevent the electric brake booster from starting. (Electric brake booster model)
- Do not let brake fluid come into contact with the painted surface of the vehicle. Wash away with water immediately and wipe off if it is spilled by accident.
- Do not mix different kinds of brake fluid.
- Do not allow water or foreign matter to enter the reservoir tank.
- Always use new brake fluid when replacing or refilling the brake fluid.
- During the operation, keep the reservoir tank filled with brake fluid at "MIN level" or higher to prevent entry of air.
- After air bleeding operation, wipe off the brake fluid around each bleeder screw and the reservoir tank.

Note:

For convenience and safety, perform the work with 2 people.

- 1. Remove the fuse (a) of electric brake booster from the sub fuse box. (Electric brake booster model)

Note:

This operation is not required if the ground terminal is already removed from the battery sensor.

2. When the master cylinder assembly is replaced or the reservoir tank is empty, bleed air from the master cylinder assembly before bleeding air from the brake line.  [Ref. to BRAKE>Air Bleeding>PROCEDURE > MASTER CYLINDER.](#)
3. Add the brake fluid to the "MAX".
4. Connect a transparent vinyl tube, etc. to the bleeder screw and a collection container.

5. Loosen the bleeder screw, and then repeat the full stroke depressing operation of the brake pedal, until brake fluid in the tube has no more air bubbles.

Note:

Air bubbles are removed after repeating the depressing operation 15 times or more for the front caliper, and 20 times or more for the rear caliper.

6. Perform the steps 3. to 5. above on each brake caliper.

Note:

Perform in the order starting from the front RH → front LH → rear LH → rear RH.

7. Tighten the loosened bleeder screw, repeat firmly depressing of the brake pedal quickly 5 to 6 times, and then depress and hold the brake pedal.
8. Loosen the bleeder screw to drain the brake fluid. When the brake pedal reaches the full stroke position, immediately tighten the bleeder screw and return the brake pedal.
9. Repeat steps 7. and 8. until there are no more air bubbles in the tube.
10. Perform the steps 7. to 9. above on each brake caliper.

Note:

Perform in the order starting from the front RH → front LH → rear LH → rear RH.

11. Perform the sequence control mode for the VDC CM&H/U in both ABS and VDC systems.

Caution:

- **If there is a possibility that air enters the pressure control section in the VDC CM&H/U, perform steps 12. to 17.**
- **For normal air bleeding operation, do not operate the sequence control for the VDC CM&H/U. (Operating the sequence control may let air in the normal air bleeding passages move to the pressure control section.)**

Note:

- Normal air bleeding operation does not help bleed air that enters the pressure control section in the VDC CM&H/U.
- If there is a possibility that air enters the pressure control section in the VDC CM&H/U (if ABS or VDC operates with air contained in the normal air bleeding passage), perform the sequence control mode for both of the ABS and VDC systems.

12. Perform the ABS sequence control mode.  [Ref. to VEHICLE DYNAMICS CONTROL \(VDC\)>ABS Sequence Control.](#)

Caution:

Be sure to perform the ABS sequence control mode first.

13. Perform the air bleeding operation of steps 4. and 5. for the bleeder screw on each caliper.

Note:

- Perform in the order starting from the front RH → front LH → rear LH → rear RH.
- As a reference, the number of the full stroke depressing operation is six times.

14. Perform the VDC sequence control mode.  [Ref. to VEHICLE DYNAMICS CONTROL \(VDC\)>VDC Sequence Control.](#)

15. Perform the air bleeding operation of steps 4. and 5. for the bleeder screw on each caliper.

16. Repeat steps 12. to 15. for three cycles.

17. In case air still remains at step 16., repeat steps 12. to 15. again until all air is removed.

18. Add the brake fluid to the "MAX".

19. Tighten each bleeder screw to the specified torque.

Tightening torque:

Front: 8 N·m (0.8 kgf-m, 5.9 ft-lb)

Rear (except for the electronic parking brake model): 8 N·m (0.8 kgf-m, 5.9 ft-lb)

Rear (electronic parking brake model): 17 N·m (1.7 kgf-m, 12.5 ft-lb)

20. Install the bleeder cap to each bleeder screw.

21. Install the fuse (a) of electric brake booster. (Electric brake booster model)

Note:

Perform this operation only when the fuse of electric brake booster is removed.

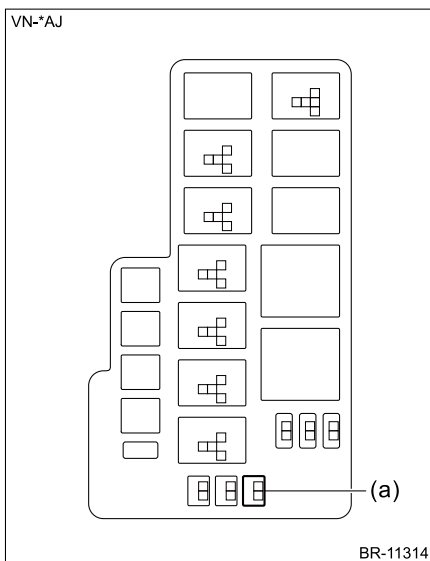

22. Check that the electric brake booster operates normally. (Electric brake booster model)

23. Check that there are no brake fluid leaks at the flare nut portion or in the entire brake system.

24. After inspection, wipe off the brake fluid around each bleeder screw and the reservoir tank.

25. Perform a road test and ensure that the brakes operate normally.

3. VDC CM&H/U

1. Perform steps 1. to 25. in procedure 2 for air bleeding of the brake line.  [Ref. to BRAKE>Air Bleeding>PROCEDURE > BRAKE LINE.](#)

Caution:

- If there is a possibility that air entered the pressure control section in the VDC CM&H/U, perform steps 12. to 17. in section 2.
- For normal air bleeding operation, do not operate the sequence control for the VDC CM&H/U. (Operating the sequence control may let air in the normal air bleeding passages move to the pressure control section.)
- Be sure to perform the ABS sequence control mode first before the VDC sequence control mode.

Note:

If there is a possibility that air enters the pressure control section in the VDC CM&H/U, perform the sequence control mode for both of the ABS and VDC systems. (Refer to steps 11. to 17. for brake lining.)

4. CALIPER

1. Perform steps 1. to 25. in procedure 2 for air bleeding of the brake line.  [Ref. to BRAKE>Air Bleeding>PROCEDURE > BRAKE LINE.](#)

Caution:

- For the caliper with electronic parking actuator, never drain the brake fluid in the caliper.
- When removing the caliper with electronic parking actuator from the vehicle, make sure to apply the brake fluid seal before disconnection.
- For the caliper as replacement part with electronic parking actuator, do not remove the brake fluid seal except when the caliper is installed on the vehicle.

REMOVAL



1. FRONT BRAKE HOSE

1. Remove the front wheels.  [Ref. to WHEEL AND TIRE SYSTEM>Tire and Wheel>REMOVAL.](#)
2. Separate pipe assembly front ABS using a flare nut wrench.

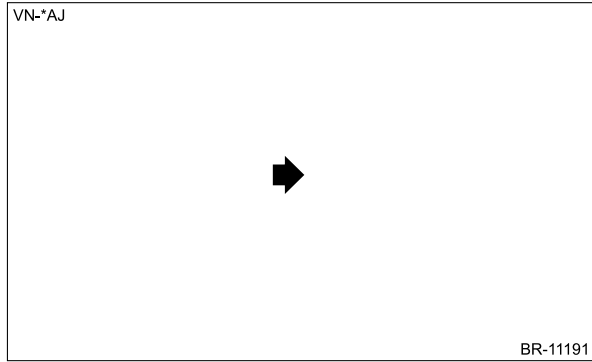

3. Remove the clamp brake hose (a), brake hose bracket bolt (b) and union bolt (c), and remove brake hose front.

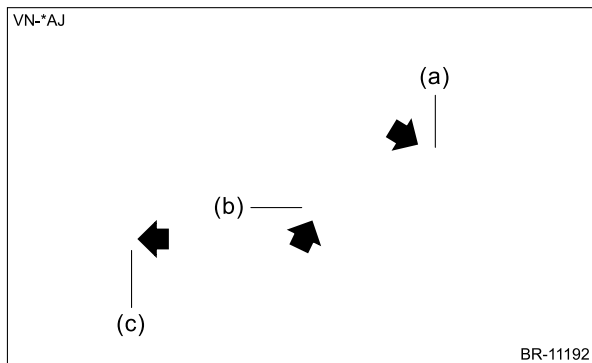

2. REAR BRAKE HOSE

1. Remove the rear wheels.  [Ref. to WHEEL AND TIRE SYSTEM>Tire and Wheel>REMOVAL.](#)
2. Separate the pipe assembly center using a flare nut wrench.

3. Remove the clamp brake hose (a), brake hose bracket bolt (b) and union bolt (c), and remove brake hose rear.
 - Except for electric brake booster model

- Electric brake booster model

BRAKE > Brake Hose

INSTALLATION

1. FRONT BRAKE HOSE

1. Secure the brake hose front to the brake hose mount part of strut COMPL front.

Tightening torque:

33 N·m (3.4 kgf-m, 24.3 ft-lb)

2. Install the brake hose front to the caliper body using a new gasket.

Tightening torque:

26 N·m (2.7 kgf-m, 19.2 ft-lb)

3. Check that the steering wheel is in the straight-ahead position and route the brake hose front through the hole in the bracket on the wheel apron side.

Caution:

Do not twist the brake hose front.

4. Connect the pipe assembly front ABS and brake hose front, and temporarily tighten the flare nut.
5. Secure the brake hose front to wheel apron bracket with the clamp brake hose.
6. Install the pipe assembly front ABS.



Caution:

Be careful not to make scratches or other damage to the inside surface of the brake pipe flare.

- (1) Turn and tighten the flare nut (b) by hand while pushing the pipe assembly front ABS (a) away from yourself.
- (2) Tighten the flare nut (b) using a flare nut wrench and a crowfoot wrench.

Tightening torque:

Calculation formula
$T = 15 \text{ N}\cdot\text{m} (1.5 \text{ kgf}\cdot\text{m}, 11.1 \text{ ft}\cdot\text{lb}) \times L1 / (L1 + L2)$
T: Reading of the torque wrench L1: Effective length of the torque wrench L2: Effective length of the crowfoot wrench
<p style="color: blue; margin: 0;">Note:</p> <p style="color: blue; margin: 0;">If the effective length of the tool used is unknown, consult the manufacturer of the tool.</p>
<p>(a) Effective length of the crowfoot wrench (L2)</p> <p>(b) Effective length of the torque wrench (L1)</p> <p>(c) Center of the open end of crowfoot wrench</p> <p>(d) Center of drive square of the torque wrench</p> <p>(e) Center of the position where a force is applied by hand</p>

7. Bleed air from the brake system.  [Ref. to BRAKE>Air Bleeding>PROCEDURE.](#)
8. Install the front wheels.  [Ref. to WHEEL AND TIRE SYSTEM>Tire and Wheel>INSTALLATION.](#)

2. REAR BRAKE HOSE

1. Route the brake hose rear through the hole of bracket, and lightly tighten the flare nut to connect to the pipe assembly center.
2. Insert the clamp brake hose and secure the brake hose rear.

Tightening torque:

33 N·m (3.4 kgf·m, 24.3 ft·lb)

3. Install the brake hose rear to caliper body using a new gasket.

Tightening torque:

26 N·m (2.7 kgf·m, 19.2 ft·lb)

4. Install the pipe assembly center.

Caution:

Be careful not to make scratches or other damage to the inside surface of the brake pipe flare.

- (1) Turn and tighten the flare nut (b) by hand while pushing the pipe assembly center (a) away from yourself.
- (2) Tighten the flare nut (b) using a flare nut wrench and a crowfoot wrench.

Tightening torque:

Calculation formula
$T = 15 \text{ N}\cdot\text{m} (1.5 \text{ kgf}\cdot\text{m}, 11.1 \text{ ft}\cdot\text{lb}) \times L1 / (L1 + L2)$
T: Reading of the torque wrench L1: Effective length of the torque wrench L2: Effective length of the crowfoot wrench
Note: If the effective length of the tool used is unknown, consult the manufacturer of the tool.
<p>BR-11555</p>
(a) Effective length of the crowfoot wrench (L2) (b) Effective length of the torque wrench (L1) (c) Center of the open end of crowfoot wrench (d) Center of drive square of the torque wrench (e) Center of the position where a force is applied by hand

5. Bleed air from the brake system. [Ref. to BRAKE>Air Bleeding>PROCEDURE.](#)
6. Install the rear wheels. [Ref. to WHEEL AND TIRE SYSTEM>Tire and Wheel>INSTALLATION.](#)

BRAKE > Brake Hose

INSPECTION

1. Check the brake hose for crack, interference with other parts, damage, and fluid leakage on connecting sections.
2. If any faulty is found in the inspection, repair or replace the brake hose.







REMOVAL



1. FRONT BRAKE PIPE

Caution:

- **Before handling the airbag system components, refer to "CAUTION" of "General Description" in "AIRBAG SYSTEM".**
 [Ref. to AIRBAG SYSTEM>General Description>CAUTION.](#)
- **When removing the brake pipe, do not bend.**











1. Disconnect the ground terminal from the battery sensor, and wait for at least 60 seconds before starting work.  [Ref. to REPAIR CONTENTS>NOTE > BATTERY.](#)
2. Remove the front wheels.  [Ref. to WHEEL AND TIRE SYSTEM>Tire and Wheel>REMOVAL.](#)
3. Remove the crossmember support rear RH.  [Ref. to FRONT SUSPENSION>Crossmember Support>REMOVAL.](#)
4. Remove the intercooler.  [Ref. to INTAKE \(INDUCTION\)\(H4DOTC\)>Intercooler>REMOVAL.](#)
5. Remove the engine control module (ECM).  [Ref. to FUEL INJECTION \(FUEL SYSTEMS\)\(H4DOTC\)>Engine Control Module \(ECM\)>REMOVAL.](#)
6. Remove the vacuum booster assembly. (Except for electric brake booster model)  [Ref. to BRAKE>Brake Booster>REMOVAL > EXCEPT FOR ELECTRIC BRAKE BOOSTER MODEL.](#)
7. Remove the electric booster assembly. (Electric brake booster model)  [Ref. to BRAKE>Brake Booster>REMOVAL > ELECTRIC BRAKE BOOSTER MODEL.](#)
8. Remove the pipe assembly front ABS.
 - (1) Separate pipe assembly front ABS using a flare nut wrench.

(2) Remove the pipe assembly front ABS from the clamp and clip.

2. CENTER BRAKE PIPE

Caution:

When removing the brake pipe, do not bend.

1. Disconnect the ground terminal from battery sensor.  [Ref. to REPAIR CONTENTS>NOTE > BATTERY.](#)
2. Remove the rear wheels.  [Ref. to WHEEL AND TIRE SYSTEM>Tire and Wheel>REMOVAL.](#)
3. Remove the crossmember support rear RH.  [Ref. to FRONT SUSPENSION>Crossmember Support>REMOVAL.](#)
4. Remove the fuel tank protector.  [Ref. to FUEL INJECTION \(FUEL SYSTEMS\)\(H4DOTC\)>Fuel Tank Protector>REMOVAL.](#)
5. Remove the under cover rear RH.  [Ref. to EXTERIOR/INTERIOR TRIM>Floor Under Protector>REMOVAL.](#)
6. Remove the rear exhaust pipe.  [Ref. to EXHAUST\(H4DOTC\)>Rear Exhaust Pipe>REMOVAL.](#)
7. Remove the propeller shaft.  [Ref. to PROPELLER SHAFT / DRIVE SHAFT / AXLE>Propeller Shaft>REMOVAL.](#)
8. Remove the cable assembly hand brake. (Except for the electronic parking brake model)  [Ref. to PARKING BRAKE>Parking Brake Cable>REMOVAL.](#)
9. Remove the adapter cord EPB. (Electronic parking brake model)  [Ref. to PARKING BRAKE>Parking Brake Actuator>REMOVAL > PARKING BRAKE HARNESS.](#)
10. Remove the rear differential.  [Ref. to DIFFERENTIALS>Rear Differential \(VB-type\)>REMOVAL.](#)
11. Remove the fuel tank.  [Ref. to FUEL INJECTION \(FUEL SYSTEMS\)\(H4DOTC\)>Fuel Tank>REMOVAL.](#)
12. Remove the support sub frame front.
 - (1) Support the rear suspension assembly using a transmission jack.

Note:

Since the rear suspension assembly is heavy, make sure that it is firmly supported so that it is level.

- (2) Remove the bolts, and remove the support sub frame front.

13. Remove the pipe assembly center.

- (1) Separate the pipe assembly center using a flare nut wrench.

- (2) Remove the pipe assembly center from the pipe clamp.

BRAKE > Brake Pipe

INSTALLATION

1. FRONT BRAKE PIPE

Caution:

- Before handling the airbag system components, refer to "CAUTION" of "General Description" in "AIRBAG SYSTEM".
 [Ref. to AIRBAG SYSTEM>General Description>CAUTION.](#)
- When installing the brake pipe, do not bend.
- After installing the brake hoses, make sure that they do not contact the tires or suspension assembly, etc.

1. Install the pipe assembly front ABS.

- (1) Install the pipe assembly front ABS to the pipe clamp and clip.
- (2) Install the pipe assembly front ABS using a flare nut wrench and a crowfoot wrench.

Note:

If the work can be performed with the front and back sides reversed, it is also possible to use a 6-point crowfoot wrench.









Tightening torque:

Calculation formula
$T = 15 \text{ N}\cdot\text{m} (1.5 \text{ kgf}\cdot\text{m}, 11.1 \text{ ft}\cdot\text{lb}) \times L1 / (L1 + L2)$
T: Reading of the torque wrench L1: Effective length of the torque wrench L2: Effective length of the crowfoot wrench

Note:

If the effective length of the tool used is unknown, consult the manufacturer of the tool.

- (a) Effective length of the crowfoot wrench (L2)
- (b) Effective length of the torque wrench (L1)
- (c) Center of the open end of crowfoot wrench
- (d) Center of drive square of the torque wrench
- (e) Center of the position where a force is applied by hand

2. Install the vacuum booster assembly. (Except for electric brake booster model)  [Ref. to BRAKE>Brake Booster>INSTALLATION > EXCEPT FOR ELECTRIC BRAKE BOOSTER MODEL.](#)
3. Install the electric booster assembly. (Electric brake booster model)  [Ref. to BRAKE>Brake Booster>INSTALLATION > ELECTRIC BRAKE BOOSTER MODEL.](#)
4. Install the engine control module (ECM).  [Ref. to FUEL INJECTION \(FUEL SYSTEMS\)\(H4DOTC\)>Engine Control Module \(ECM\)>INSTALLATION.](#)
5. Install the intercooler.  [Ref. to INTAKE \(INDUCTION\)\(H4DOTC\)>Intercooler>INSTALLATION.](#)
6. Install the crossmember support rear RH.  [Ref. to FRONT SUSPENSION>Crossmember Support>INSTALLATION.](#)
7. Bleed air from the brake system.  [Ref. to BRAKE>Air Bleeding>PROCEDURE.](#)
8. Install the front wheels.  [Ref. to WHEEL AND TIRE SYSTEM>Tire and Wheel>INSTALLATION.](#)
9. Connect the ground terminal to battery sensor.  [Ref. to REPAIR CONTENTS>NOTE > BATTERY.](#)

2. CENTER BRAKE PIPE

Caution:

- When installing the brake pipe, do not bend.
- After installing the brake hoses, make sure that they do not contact the tires or suspension assembly, etc.

1. Install the pipe assembly center.
 - (1) Install the pipe assembly center to the pipe clamp and the rear floor.

Tightening torque:
18 N·m (1.8 kgf-m, 13.3 ft-lb)
 - (2) Install the pipe assembly center using a flare nut wrench and a crowfoot wrench.

Tightening torque:

Calculation formula

$$T = 15 \text{ N}\cdot\text{m} (1.5 \text{ kgf}\cdot\text{m}, 11.1 \text{ ft}\cdot\text{lb}) \times L1 / (L1 + L2)$$

T: Reading of the torque wrench

L1: Effective length of the torque wrench

L2: Effective length of the crowfoot wrench













Note:

If the effective length of the tool used is unknown, consult the manufacturer of the tool.

- (a) Effective length of the crowfoot wrench (L2)
- (b) Effective length of the torque wrench (L1)
- (c) Center of the open end of crowfoot wrench
- (d) Center of drive square of the torque wrench
- (e) Center of the position where a force is applied by hand

2. Install the support sub frame front.**Tightening torque:**

For tightening torque, refer to "COMPONENT" of "General Description" in "REAR SUSPENSION" section. :  [Ref. to REAR SUSPENSION>General Description>COMPONENT > REAR SUSPENSION.](#)

- 3.** Install the fuel tank.  [Ref. to FUEL INJECTION \(FUEL SYSTEMS\)\(H4DOTC\)>Fuel Tank>INSTALLATION.](#)
- 4.** Install the rear differential.  [Ref. to DIFFERENTIALS>Rear Differential \(VB-type\)>INSTALLATION.](#)
- 5.** Install the cable assembly hand brake. (Except for the electronic parking brake model)  [Ref. to PARKING BRAKE>Parking Brake Cable>INSTALLATION.](#)
- 6.** Install the adapter cord EPB. (Electronic parking brake model)  [Ref. to PARKING BRAKE>Parking Brake Actuator>INSTALLATION > PARKING BRAKE HARNESS.](#)
- 7.** Install the propeller shaft.  [Ref. to PROPELLER SHAFT / DRIVE SHAFT / AXLE>Propeller Shaft>INSTALLATION.](#)
- 8.** Install the rear exhaust pipe.  [Ref. to EXHAUST\(H4DOTC\)>Rear Exhaust Pipe>INSTALLATION.](#)
- 9.** Install the under cover rear RH.  [Ref. to EXTERIOR/INTERIOR TRIM>Floor Under Protector>INSTALLATION.](#)
- 10.** Install the fuel tank protector.  [Ref. to FUEL INJECTION \(FUEL SYSTEMS\)\(H4DOTC\)>Fuel Tank Protector>INSTALLATION.](#)
- 11.** Install the crossmember support rear RH.  [Ref. to FRONT SUSPENSION>Crossmember Support>INSTALLATION.](#)
- 12.** Bleed air from the brake system.  [Ref. to BRAKE>Air Bleeding>PROCEDURE.](#)
- 13.** Install the rear wheels.  [Ref. to WHEEL AND TIRE SYSTEM>Tire and Wheel>INSTALLATION.](#)
- 14.** Connect the ground terminal to battery sensor.  [Ref. to REPAIR CONTENTS>NOTE > BATTERY.](#)

BRAKE > Brake Pipe**INSPECTION**

- 1.** Check the brake pipe for crack, damage, and fluid leakage on connecting sections.

Note:

Use a mirror when inspecting back sides and other locations which are hard to see.

- 2.** If any faulty is found in the inspection, repair or replace the brake pipe.

REMOVAL





1. MT MODEL

Caution:

Before handling the airbag system components, refer to "CAUTION" of "General Description" in "AIRBAG SYSTEM".



 [Ref. to AIRBAG SYSTEM>General Description>CAUTION.](#)

1. Disconnect the ground terminal from the battery sensor, and wait for at least 60 seconds before starting work.  [Ref. to REPAIR CONTENTS>NOTE > BATTERY.](#)
2. Remove the intercooler.  [Ref. to INTAKE \(INDUCTION\)\(H4DOTC\)>Intercooler>REMOVAL.](#)
3. Drain the brake fluid.  [Ref. to CLUTCH SYSTEM>Clutch Fluid.](#)
4. Remove the hose clamp and disconnect the reservoir hose assembly.

5. Remove the bolt (a) and the clutch pipe B (b) from the two-way connector.

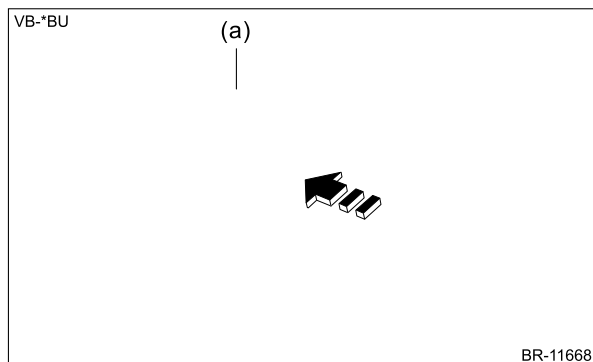
6. Push in the grommet (a) toward the vehicle compartment.



7. Remove the cover LWR driver.  [Ref. to EXTERIOR/INTERIOR TRIM>Instrument Panel Lower Cover>REMOVAL.](#)
8. Remove the knee airbag module.  [Ref. to AIRBAG SYSTEM>Knee Airbag Module>REMOVAL.](#)
9. Remove the duct foot driver.  [Ref. to AIR CONDITIONER>Air Vent Duct>REMOVAL > FOOT DUCT.](#)

10. Remove the universal joint assembly steering.  [Ref. to POWER ASSISTED SYSTEM \(POWER STEERING\)>Universal Joint>REMOVAL.](#)

Caution:

To prevent damage to the universal joint assembly steering and improper steering effort, make sure to remove the universal joint assembly steering.

11. Remove the column assembly steering.  [Ref. to POWER ASSISTED SYSTEM \(POWER STEERING\)>Steering Column>REMOVAL.](#)

12. Disconnect connectors.

- (1) Disconnect the harness from the bracket COMPL pedal.
- (2) Disconnect connectors.

13. Remove the snap pin (a) and clevis pin (b), and remove the operating rod from the pedal COMPL brake.

Caution:

- **Be careful not to apply excessive force to the operating rod when handling the operating rod. The angle may change by $\pm 3^\circ$, and it may result in damage to power piston cylinder.**
- **Do not change the push rod length.**

14. Remove the bolt and nut, and then detach the pedal assembly.

Caution:

Place vinyl, etc. in order not to drop the brake fluid to the floor carpet.

15. Remove the stop light switch assembly. [🔧 Ref. to BRAKE>Stop Light Switch>REMOVAL.](#)

Note:

Perform this procedure only when required.

2. CVT MODEL

Caution:

Before handling the airbag system components, refer to "CAUTION" of "General Description" in "AIRBAG SYSTEM".

[🔧 Ref. to AIRBAG SYSTEM>General Description>CAUTION.](#)

1. Disconnect the ground terminal from the battery sensor, and wait for at least 60 seconds before starting work. [🔧 Ref. to REPAIR CONTENTS>NOTE > BATTERY.](#)
2. Remove the cover LWR driver. [🔧 Ref. to EXTERIOR/INTERIOR TRIM>Instrument Panel Lower Cover>REMOVAL.](#)
3. Remove the knee airbag module. [🔧 Ref. to AIRBAG SYSTEM>Knee Airbag Module>REMOVAL.](#)
4. Remove the duct foot driver. [🔧 Ref. to AIR CONDITIONER>Air Vent Duct>REMOVAL > FOOT DUCT.](#)
5. Remove the universal joint assembly steering. [🔧 Ref. to POWER ASSISTED SYSTEM \(POWER STEERING\)>Universal Joint>REMOVAL.](#)

Caution:

To prevent damage to the universal joint assembly steering and improper steering effort, make sure to remove the universal joint assembly steering.

6. Remove the column assembly steering. [🔧 Ref. to POWER ASSISTED SYSTEM \(POWER STEERING\)>Steering Column>REMOVAL.](#)
7. Remove the pedal assembly brake.
 - (1) Disconnect the stop light switch assembly connector.
 - (2) Disconnect the harness from the bracket COMPL pedal.

(3) Remove the snap pin (a) and clevis pin (b), and remove the operating rod from the pedal COMPL brake.

Caution:

- Be careful not to apply excessive force to the operating rod when handling the operating rod. The angle may change by $\pm 3^\circ$, and it may result in damage to power piston cylinder.
- Do not change the push rod length.

(4) Remove the bolt and nut, and then detach the pedal assembly brake.

8. Remove the stop light switch assembly.  [Ref. to BRAKE>Stop Light Switch>REMOVAL.](#)

Note:

Perform this procedure only when required.

BRAKE > Brake Pedal

INSTALLATION

1. MT MODEL

Caution:

Before handling the airbag system components, refer to "CAUTION" of "General Description" in "AIRBAG SYSTEM".

 [Ref. to AIRBAG SYSTEM>General Description>CAUTION.](#)

1. Install the pedal assembly.

Tightening torque:

18 N·m (1.8 kgf-m, 13.3 ft-lb)



2. Install the operating rod to the pedal COMPL brake.

(1) Apply a thin coat of grease to the new clevis pin.

Preparation items:



Grease: NIPPON GREASE NIGTIGHT LTS No. 2 or equivalent

(2) Using a clevis pin and a snap pin, install the operating rod to the pedal COMPL brake.

3. Install the stop light switch assembly.  [Ref. to BRAKE>Stop Light Switch>INSTALLATION.](#)
4. Connect each connector.
5. Install the column assembly steering.  [Ref. to POWER ASSISTED SYSTEM \(POWER STEERING\)>Steering Column>INSTALLATION.](#)
6. Install the universal joint assembly steering.  [Ref. to POWER ASSISTED SYSTEM \(POWER STEERING\)>Universal Joint>INSTALLATION.](#)

Caution:







- Always install the universal joint assembly steering after installing the steering column to avoid damage to the universal joint assembly steering.
- Be sure to follow the tightening order and tightening torque of the universal joint assembly steering to avoid the steering effort from becoming heavy. After confirming that the steering column position is in the neutral position, tighten the universal joint assembly steering.

7. Install the duct foot driver.  [Ref. to AIR CONDITIONER>Air Vent Duct>INSTALLATION > FOOT DUCT.](#)
8. Install the knee airbag module.  [Ref. to AIRBAG SYSTEM>Knee Airbag Module>INSTALLATION.](#)
9. Install the cover LWR driver.  [Ref. to EXTERIOR/INTERIOR TRIM>Instrument Panel Lower Cover>INSTALLATION.](#)
10. Install the bolt and the clutch pipe B to the two-way connector.

Tightening torque:

Flange bolt: 7.5 N·m (0.8 kgf-m, 5.5 ft-lb)

Clutch pipe B: 15.5 N·m (1.6 kgf-m, 11.4 ft-lb)

11. Install the reservoir hose assembly.
12. Add the recommended brake fluid.  [Ref. to CLUTCH SYSTEM>Clutch Fluid.](#)
13. After bleeding air from the clutch system, ensure that no brake fluid leaks and the clutch operates properly.  [Ref. to CLUTCH SYSTEM>Air Bleeding>PROCEDURE.](#)
14. Adjust the clutch pedal.  [Ref. to CLUTCH SYSTEM>Clutch Pedal>ADJUSTMENT.](#)
15. Install the intercooler.  [Ref. to INTAKE \(INDUCTION\)\(H4DOTC\)>Intercooler>INSTALLATION.](#)
16. Connect the ground terminal to battery sensor.  [Ref. to REPAIR CONTENTS>NOTE > BATTERY.](#)
17. Check the clutch start system.
18. Check that the brake light operate properly.
19. Check the brake pedal.  [Ref. to BRAKE>Brake Pedal>INSPECTION.](#)

2. CVT MODEL

Caution:

Before handling the airbag system components, refer to "CAUTION" of "General Description" in "AIRBAG SYSTEM".

 [Ref. to AIRBAG SYSTEM>General Description>CAUTION.](#)

1. Install the pedal assembly brake.
Tightening torque:
18 N·m (1.8 kgf-m, 13.3 ft-lb)
2. Install the operating rod to the pedal COMPL brake.
(1) Apply a thin coat of grease to the new clevis pin.

Preparation items:

Grease: NIPPON GREASE NIGTIGHT LTS No. 2 or equivalent

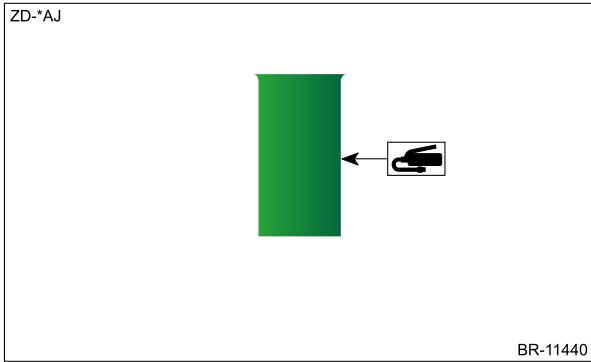

(2) Using a clevis pin and a snap pin, install the operating rod to the pedal COMPL brake.

3. Install the stop light switch assembly. [Ref. to BRAKE>Stop Light Switch>INSTALLATION.](#)
4. Connect the stop light switch assembly connector.
5. Install the column assembly steering. [Ref. to POWER ASSISTED SYSTEM \(POWER STEERING\)>Steering Column>INSTALLATION.](#)
6. Install the universal joint assembly steering. [Ref. to POWER ASSISTED SYSTEM \(POWER STEERING\)>Universal Joint>INSTALLATION.](#)

Caution:

- Always install the universal joint assembly steering after installing the steering column to avoid damage to the universal joint assembly steering.
- Be sure to follow the tightening order and tightening torque of the universal joint assembly steering to avoid the steering effort from becoming heavy. After confirming that the steering column position is in the neutral position, tighten the universal joint assembly steering.

7. Install the duct foot driver. [Ref. to AIR CONDITIONER>Air Vent Duct>INSTALLATION > FOOT DUCT.](#)
8. Install the knee airbag module. [Ref. to AIRBAG SYSTEM>Knee Airbag Module>INSTALLATION.](#)
9. Install the cover LWR driver. [Ref. to EXTERIOR/INTERIOR TRIM>Instrument Panel Lower Cover>INSTALLATION.](#)
10. Connect the ground terminal to battery sensor. [Ref. to REPAIR CONTENTS>NOTE > BATTERY.](#)
11. Check that the brake light operate properly.
12. Check the brake pedal. [Ref. to BRAKE>Brake Pedal>INSPECTION.](#)

BRAKE > Brake Pedal

DISASSEMBLY

1. Remove the bolt and nut, and then remove the pedal COMPL brake from the bracket COMPL pedal.

Caution:

- Turn and remove the nut while holding the bolt side.

- MT model

- CVT model

2. Remove the bushing (a), spacer (b), stopper (c) and pedal pad (d) from the pedal COMPL brake.
- MT model

- CVT model

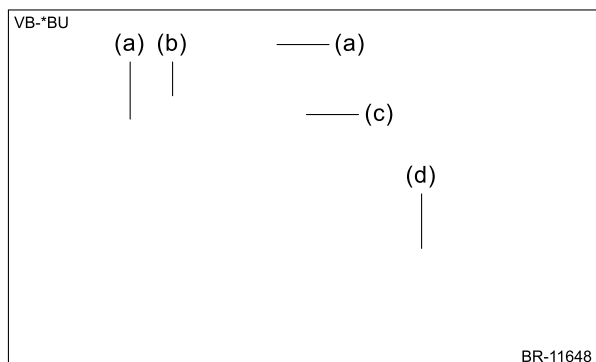

BRAKE > Brake Pedal

ASSEMBLY

1. Apply a thin coat of grease to the spacer.

Preparation items:

Grease: NIPPON GREASE NIGTIGHT LTS No. 2 or equivalent

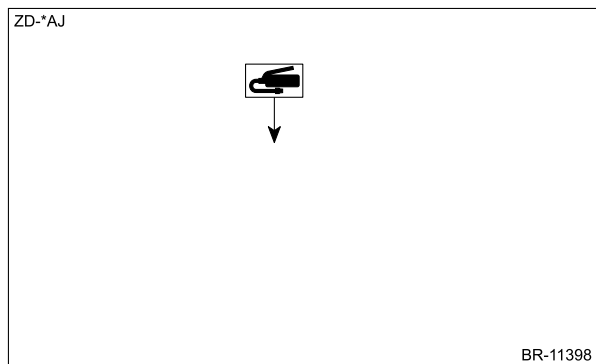

2. Install the bushing, spacer, stopper and pedal pad to the pedal COMPL brake.
3. Install the pedal COMPL brake to the bracket COMPL pedal.

Caution:

While holding the bolt side, tighten the nut to the specified torque.

Tightening torque:

30 N·m (3.1 kgf-m, 22.1 ft-lb)

BRAKE > Brake Pedal

INSPECTION

1. Move the pedal pads in a horizontal direction with a force of approx. 10 N (1 kgf, 2 lbf), and check that the brake pedal deflection is in the range of specifications.

Caution:

If excessive deflection is noted, replace the bushing with a new part.

Limit: 4 mm (0.157 in) or less

2. Check the position of the pedal pad.

Brake pedal height L:

Standard: 129 — 139 mm (5.08 — 5.47 in)

Brake pedal free play A:

Standard: 0.5 — 2.7 mm (0.02 — 0.11 in) [When pulling the brake pedal upward with a force of less than 10 N (1 kgf, 2 lbf)]

- (a) Stop light switch ASSY
- (b) Operating rod
- (c) Toe board
- (d) Mat

3. If it is not within the specification, loosen the lock nuts of operating rod, and rotate the rod to adjust the pedal height L within the specification.
4. Tighten the lock nut.

Note:

Check the brake pedal height. When adjusting, also adjust the stop light switch assembly.

Tightening torque:

18 N·m (1.8 kgf-m, 13.3 ft-lb)

BRAKE > Stop Light Switch

REMOVAL

Caution:

Before handling the airbag system components, refer to "CAUTION" of "General Description" in "AIRBAG SYSTEM".

[Ref. to AIRBAG SYSTEM>General Description>CAUTION.](#)

1. Disconnect the ground terminal from the battery sensor, and wait for at least 60 seconds before starting work. [Ref. to REPAIR CONTENTS>NOTE > BATTERY.](#)
2. Remove the cover LWR driver. [Ref. to EXTERIOR/INTERIOR TRIM>Instrument Panel Lower Cover>REMOVAL.](#)
3. Remove the knee airbag module. [Ref. to AIRBAG SYSTEM>Knee Airbag Module>REMOVAL.](#)
4. Remove the duct foot driver. [Ref. to AIR CONDITIONER>Air Vent Duct>REMOVAL > FOOT DUCT.](#)
5. Remove the stop light switch assembly.
 - (1) Disconnect the stop light switch assembly connector.
 - (2) Remove the nut, and remove the stop light switch assembly.

BRAKE > Stop Light Switch

INSTALLATION

Caution:

Before handling the airbag system components, refer to "CAUTION" of "General Description" in "AIRBAG SYSTEM".

[Ref. to AIRBAG SYSTEM>General Description>CAUTION.](#)

1. Install the stop light switch assembly onto the bracket COMPL pedal and position it with the nut.
2. Adjust the stop light switch assembly position, and then tighten the nut. [Ref. to BRAKE>Stop Light Switch>ADJUSTMENT > CLEARANCE ADJUSTMENT.](#)

Tightening torque:
8 N·m (0.8 kgf-m, 5.9 ft-lb)
3. Connect the stop light switch assembly connector.
4. Install the duct foot driver. [Ref. to AIR CONDITIONER>Air Vent Duct>INSTALLATION > FOOT DUCT.](#)
5. Install the knee airbag module. [Ref. to AIRBAG SYSTEM>Knee Airbag Module>INSTALLATION.](#)
6. Install the cover LWR driver. [Ref. to EXTERIOR/INTERIOR TRIM>Instrument Panel Lower Cover>INSTALLATION.](#)
7. Connect the ground terminal to battery sensor. [Ref. to REPAIR CONTENTS>NOTE > BATTERY.](#)

BRAKE > Stop Light Switch

INSPECTION

1. INSPECT THE SPECIFIED POSITION

1. Measure the clearance (a) between the end of the stop light switch assembly and the stopper.

Caution:

Be careful not to rotate the stop light switch assembly.

Specification:

2.1 mm (0.08 in)

2. Adjust the position of the stop light switch assembly if the inspection result is not within the standard value.  [Ref. to BRAKE>Stop Light Switch>ADJUSTMENT > CLEARANCE ADJUSTMENT.](#)
3. If the stop light switch assembly does not operate properly or it is not secured at the specified position after adjustment, replace the stop light switch assembly.

2. CHECK OUTPUT

1. Check the voltage between connector terminals.

Terminal No.	Inspection conditions	Standard
2 – 3	Apply battery voltage between terminals 1 (+) – 3 (–). When the end of stop light switch is pressed in to make the length (a) 3.6 mm (0.14 in) (actually a little shorter than 3.6 mm (0.14 in)), output voltage will be OFF.	0.5 V or less
	Apply battery voltage between terminals 1 (+) – 3 (–). When the end of stop light switch is pulled back to make the length (a) 3.6 mm (0.14 in) (actually a little longer than 3.6 mm (0.14 in)), output voltage will be ON.	12 V
4 – 3	Apply battery voltage between terminals 5 (+) – 3 (–). When the end of stop light switch is pressed in to make the length (a) 4.5 mm (0.18 in) (actually a little shorter than 4.5 mm (0.18 in)), output voltage will be ON.	12 V
	Apply battery voltage between terminals 5 (+) – 3 (–). When the end of stop light switch is pulled back to make the length (a) 4.5 mm (0.18 in) (actually a little longer than 4.5 mm (0.18 in)), output voltage will be OFF.	0.5 V or less

2. Replace the stop light switch assembly if the inspection result is not within the standard value.

ADJUSTMENT

1. CLEARANCE ADJUSTMENT

1. Loosen the lock nut, and adjust the stop light switch assembly position until the clearance (a) between the threaded end of the stop light switch assembly and stopper becomes 2.1 mm (0.08 in). Then, tighten the lock nut (b) so that the stop light switch assembly position is not displaced.

Tightening torque:

8 N·m (0.8 kgf-m, 5.9 ft-lb)

2. ADJUSTMENT WHEN VDC WARNING LIGHT OR EyeSight WARNING LIGHT IS ILLUMINATING

1. Measure the brake pedal stroke which turns on the stop light switch assembly.

Caution:

Be careful not to damage the steering wheel.

- (1) Release the steering wheel lock, tilt the steering column to the lowest end and fully retract the column by the telescopic system.
- (2) Affix the masking tape (a) to protect the steering wheel from damage, pass the measure (b) through the steering wheel and fix it to the vertical center position of the brake pedal.

Caution:

If the measure (b) interferes with the knee airbag module, remove the knee airbag module.  Ref. to AIRBAG SYSTEM>Knee Airbag Module>REMOVAL.

- (3) Set the measure (b) so that it becomes straight from the brake pedal, and add a marking (c) on the masking tape (a).

(4) Operate the brake pedal, and read the position where the stop light illuminates (the amount of the pedal stroke) using the marking added in the previous step.

Caution:

If the pedal stroke is less than 3 mm (0.12 in), it may lead to an incorrect light illumination by vibrations, etc.

2. If the stop light illuminating position is not within the adjustment value, readjust the stop light switch assembly position.

Note:

Turning the lock nut (b) by 90° changes the amount of pedal stroke by approx. 1 mm (0.04 in).

Adjustment value (amount of pedal stroke):

3 mm (0.12 in) or more, 5 mm (0.2 in) or less

(1) Loosen the lock nut (a).

(2) Turn the lock nut (b) to adjust the stop light switch assembly position so that the stop light illuminating position is within the adjustment value.

(3) After adjustment, tighten the lock nut (a).

Tightening torque:

8 N·m (0.8 kgf-m, 5.9 ft-lb)

(4) After the lock nut is tightened, check again that the stop light illuminating position is within the adjustment value. If it's not within the adjustment value, perform the adjustment procedure again.

Caution:

If the stop light illuminating position is less than 3 mm (0.12 in), it may lead to an incorrect stop light illumination by vibrations etc. even when the brake pedal is not operated while driving.

BRAKE > Brake Vacuum Pump

REMOVAL

1. BRAKE VACUUM PUMP

For removal procedures, refer to "Vacuum Pump" in "MECHANICAL" section.  [Ref. to MECHANICAL\(H4DOTC\)>Vacuum Pump>REMOVAL.](#)

2. BRAKE VACUUM HOSE & PIPE

1. Remove the intercooler.  [Ref. to INTAKE \(INDUCTION\)\(H4DOTC\)>Intercooler>REMOVAL.](#)
2. Remove the vacuum hose COMPL and the vacuum pipe COMPL.

Note:

Perform marking of the vacuum hose COMPL on the vacuum pump side as shown in the figure below.

- (a) Vacuum pipe COMPL
- (b) Marking
- (c) Vacuum hose COMPL
- (d) Vacuum pump

(1) Remove the clamp and disconnect the vacuum hose COMPL from the vacuum pump.

(2) Remove the bolt and disconnect the pipe clamp from the engine rear hanger.

(3) Remove the clamp and disconnect the vacuum hose COMPL from the vacuum booster assembly.

(4) Remove the clamp and disconnect the vacuum hose COMPL from the vacuum pipe COMPL.

Note:

Perform this procedure only when required.

BRAKE > Brake Vacuum Pump

INSTALLATION

1. BRAKE VACUUM PUMP

For installation procedures, refer to "Vacuum Pump" in "MECHANICAL" section.  [Ref. to MECHANICAL\(H4DOTC\)>Vacuum Pump>INSTALLATION.](#)

2. BRAKE VACUUM HOSE & PIPE

1. Install the vacuum hose COMPL and the vacuum pipe COMPL.

Caution:

Install the vacuum hose COMPL on the vacuum pump side so that the marks are aligned.

- (a) Vacuum pipe COMPL
- (b) Marking
- (c) Vacuum hose COMPL
- (d) Vacuum pump

- (1) Install the vacuum hose COMPL to the vacuum pump.
- (2) Install the vacuum hose COMPL to the vacuum booster assembly.
- (3) Install the pipe clamp to the engine rear hanger.

Tightening torque:

18 N·m (1.8 kgf-m, 13.3 ft-lb)

- (4) Install the vacuum hose COMPL to the vacuum pump.

Clearance:

Clearance between vacuum hose COMPL and surrounding parts: 15 mm (0.59 in) or more

2. Install the intercooler.  [Ref. to INTAKE \(INDUCTION\)\(H4DOTC\)>Intercooler>INSTALLATION.](#)

BRAKE > Brake Vacuum Pump

INSPECTION

1. BRAKE VACUUM PUMP

For inspection, refer to "MECHANICAL" section.  [Ref. to MECHANICAL\(H4DOTC\)>Vacuum Pump>INSPECTION.](#)





2. BRAKE VACUUM HOSE & PIPE

Check to see that air only flows in one direction, when air is blown into or sucked from the hose.

BRAKE > General Diagnostic Table

INSPECTION

Symptoms	Possible cause	Corrective action
Insufficient braking	(1) Brake fluid leakage from the hydraulic mechanism	Repair or replace (cup, piston seal, piston boot, master cylinder piston kit, brake pipe or brake hose).
	(2) Entry of air into the hydraulic mechanism	Bleed air.
	(3) Wear, deteriorated surface material, water or brake fluid on pad or lining	Replace, grind or clean.
	(4) Improper operation of master cylinder assembly, brake caliper, vacuum booster assembly or check valve	Repair or replace.
Unstable or uneven braking	(1) Brake fluid on pad surface, lining surface, or brake disc	Correct the cause of brake fluid leakage, and clean or replace.
	(2) Defective brake disc	Repair or replace the brake disc.
	(3) Improper pad or lining contact, deteriorated surface, deteriorated or worn material	Repair by grinding, or replace.
	(4) Deformed brake back plate	Repair or replace.
	(5) Overinflation of tires	Adjust to the specified air pressure.
	(6) Defective wheel alignment	Adjust alignment.
	(7) Loose brake back plate or support installation bolt	Tighten to the specified torque.
	(8) Defective hub unit bearing	Replace.
	(9) Defective hydraulic system	Replace the cylinder, brake pipe or brake hose.
	(10) Unstable performance of the parking brake	Check, adjust or replace the rear brake and cable system.
Excessive pedal stroke	(1) Entry of air into the hydraulic mechanism	Bleed air.
	(2) Excessive play in the master cylinder push rod	Adjust.
	(3) Brake fluid leakage from the hydraulic mechanism	Repair or replace (cup, piston seal, piston boot, master cylinder piston kit, brake pipe or brake hose).
	(4) Improper pad or lining contact or wear	Repair or replace.
Brake dragging or improper brake return	(1) Insufficient pedal play	Adjust play.
	(2) Improper master cylinder return	Clean or replace the cylinder.
	(3) Clogged hydraulic system	Replace.
	(4) Improper return or adjustment of parking brake	Repair or adjust.
	(5) Weakened spring tension or breakage of shoe return spring	Replace the spring.
	(6) Improper brake caliper operation	Repair or replace.
	(7) Defective hub unit bearing	Replace.
Brake noise (creaking sound)	(1) Hardened or deteriorated brake pad	Replace the brake pad.
	(2) Worn brake pad	Replace the brake pad.
	(3) Loose brake back plate or support installation bolt	Tighten to the specified torque.
	(4) Loose hub unit bearing	Tighten to the specified torque.
	(5) Dirt on brake disc	Clean the brake disc.

Symptoms	Possible cause	Corrective action
		Clean or replace brake assembly.
Brake noise (hissing sound)	(1) Worn brake pad	Replace the brake pad.
	(2) Improperly installed brake pad	Correct or replace the brake pad.
	(3) Loose or bent brake disc	Retighten or replace.
Brake noise (click sound)	Excessively worn brake pad or support	Replace the brake pad or the support.
VDC warning light or EyeSight warning light illuminating	(1) Stop light switch adjustment malfunction	Adjust the stop light switch.  Ref. to BRAKE>Stop Light Switch>ADJUSTMENT > ADJUSTMENT WHEN VDC WARNING LIGHT OR EyeSight WARNING LIGHT IS ILLUMINATING.
	(2) VDC system failure	Check the VDC system.  Ref. to BRAKE CONTROL (DIAGNOSTICS)>Basic Diagnostic Procedure.
	(3) EyeSight system failure	Check the EyeSight system.  Ref. to EyeSight (DIAGNOSTICS)>Basic Diagnostic Procedure.
Stop light illuminating due to vibrations, etc. during driving (brake operation not performed)	Stop light switch adjustment malfunction	Adjust the stop light switch.  Ref. to BRAKE>Stop Light Switch>ADJUSTMENT > ADJUSTMENT WHEN VDC WARNING LIGHT OR EyeSight WARNING LIGHT IS ILLUMINATING.

-
1. General Description
 2. Relay and Fuse
 3. Parking Brake System
 4. Parking Brake Lever
 5. Parking Brake Cable
 6. Parking Brake Assembly (Rear Disc Brake)
 7. Parking Brake Actuator
 8. Parking Brake Switch
 9. Emergency Release of Electronic Parking Brake
 10. General Diagnostic Table

PARKING BRAKE > General Description

CAUTION

- When performing service operation, refer to "Repair Contents" in "General Description". [Ref. to REPAIR CONTENTS>Repair Contents.](#)
- When performing any work, always wear work clothes, a work cap and protective shoes. Additionally, wear a helmet, protective goggles, etc. if necessary.
- When performing a repair, identify the cause of trouble and avoid unnecessary removal, disassembly and replacement.
- Some vehicle components are extremely hot immediately after driving. Be wary of receiving burns from heated parts.
- Use SUBARU genuine grease, the recommended or equivalent. Do not mix grease etc. of different grades or manufacturers.
- Apply grease onto sliding or revolving surfaces before installation.
- Be sure that the surface of brake disc, brake pad or brake shoe is free from grease or oil.
- Before starting works, remove dirt and corrosion around the target area.
- When performing work on the sensors or modules, be careful of the following.
 - Before disconnecting electrical connectors, be sure to disconnect the ground terminal from the battery sensor. [Ref. to REPAIR CONTENTS>NOTE > BATTERY.](#)
 - Do not apply any impact. If the parts are accidentally dropped, replace with a new part.
 - Do not expose to high-temperature and humidity.

PARKING BRAKE > General Description

SPECIFICATION

1. EXCEPT FOR THE ELECTRONIC PARKING BRAKE MODEL

Item		Specification	
Type		Drum in disc duo servo type	
Effective drum diameter	mm (in)	190 (7.48)	
Lining dimension (Length × Width × Thickness)	mm (in)	165 × 30 × 3.5 (6.5 × 1.18 × 0.14)	
Inside diameter	mm (in)	Standard	190 (7.48)
		Limit	191 (7.52)
Lining thickness	mm (in)	Standard	3.5 (0.14)
		Limit	1.5 (0.06)
Clearance adjustment		Manual adjustment	
Free play adjusting method		Auto adjuster	
Operation method		Manual lever type	
Lever stroke	Notches/N (kgf, lbf)	7 – 8/200 (20.4, 45)	

2. ELECTRONIC PARKING BRAKE MODEL

Item		Specification
Type		Electric type
Clearance adjustment		Automatic adjusting
Operation method		Switch type

PARKING BRAKE > General Description

COMPONENT

1. EXCEPT FOR THE ELECTRONIC PARKING BRAKE MODEL

(1) Mounting bolt	(11) Pin boot	Tightening torque: N-m (kgf-m, ft-lb) T1: 8 (0.8, 5.9) T2: 27 (2.8, 19.9) T3: 73 (7.4, 53.8)
(2) Rear axle housing	(12) Slide pin lock	
(3) Shim disc brake rear inner	(13) Slide pin bushing	
(4) Pad disc brake rear inner	(14) Support rear disc brake	
(5) Pad disc brake rear outer	(15) Pad clip	
(6) Shim disc brake rear outer	(16) Brake disc rear	
(7) Bleeder cap	(17) Plug	
(8) Bleeder screw	(18) Boot piston	
(9) Caliper body	(19) Piston disc brake	
(10) Slide pin	(20) Piston seal	

(1) Shoe set pin

(6) Brake shoe

(10) Spring A

- | | | |
|---------------------------|-----------------------|------------------------|
| (2) Rear brake back plate | (7) Parking lever pin | (11) Spring rod |
| (3) Ring retainer | (8) Strut | (12) Spring shoe clamp |
| (4) Spring washer | (9) Adjuster ASSY | (13) Spring adjuster |
| (5) Parking lever | | |

- | | | |
|----------------------------|------------------------------|--|
| (1) Switch ASSY hand brake | (6) Clamp hand brake | Tightening torque: N·m (kgf-m, ft-lb) |
| (2) Lever ASSY hand brake | (7) Cable ASSY hand brake RH | T1: 1.5 (0.2, 1.1) |
| (3) Flange lock nut | (8) Clamp hand brake cable | T2: 18 (1.8, 13.3) |
| (4) Equalizer | (9) Cable ASSY hand brake LH | |
| (5) Bracket console COMPL | | |

2. ELECTRONIC PARKING BRAKE MODEL

(1) Mounting bolt	(10) Pin boot A	Tightening torque: N·m (kgf-m, ft-lb) T1: 8 (0.8, 5.9) T2: 17 (1.7, 12.5) T3: 25 (2.5, 18.4) T4: 73 (7.4, 53.8)
(2) Rear axle housing	(11) Pin boot B	
(3) Support rear disc brake	(12) Guide pin rear brake	
(4) Pad COMPL inner	(13) Bleeder cap	
(5) Pad COMPL outer	(14) Bleeder screw	
(6) Brake disc rear	(15) Caliper body*2	
(7) Parking brake actuator*1 *2	(16) Pad clip	
(8) O-ring*2	(17) Boot piston	
(9) Cap		

*1: Do not reuse it when the emergency release of parking brake was performed or when the actuator has a malfunction.

*2: When replacing the parking brake actuator or the caliper body, always replace the O-ring with the supplied new part.

(1) Switch ASSY EPB

(3) Adapter cord EPB LH

**Tightening torque: N·m (kgf·m,
ft·lb)**

(2) Adapter cord EPB RH

T: 18 (1.8, 13.3)

PARKING BRAKE > General Description

PREPARATION TOOL

1. SUBARU SPECIAL TOOL

ILLUSTRATION	TOOL NUMBER	DESCRIPTION	REMARKS
	—	SUBARU SELECT MONITOR 4	Used for setting of each function and troubleshooting for electrical system. Note: <ul style="list-style-type: none">• For detailed operation procedures, refer to "Help" of application.• Used together with interface for Subaru Select Monitor (such as DST-i and DST-010).

2. OTHER

	REMARKS
Circuit tester	Used for measuring resistance, voltage and current.
TORX® E12	Used for turning the caliper body spindle bolt.
Caliper	Used for measuring the dimension.
Hexagon wrench	Used for removing and installing the parking brake actuator. Width across flat 5 mm (0.2 in)

PARKING BRAKE > Relay and Fuse

LOCATION

For the location, refer to "FUSE AND RELAY" in the wiring diagram. [.Ref. to WIRING SYSTEM>Fuse And Relay.](#)

Note:

For details of relay and fuse, refer to "DC POWER SUPPLY CIRCUIT". [.Ref. to WIRING SYSTEM>Power Supply Circuit>WIRING DIAGRAM.](#)

PARKING BRAKE > Relay and Fuse

INSPECTION

1. CHECK FUSE

1. Remove the fuse and inspect visually.
2. If the fuse is blown out, replace the fuse.

PARKING BRAKE > Parking Brake System

WIRING DIAGRAM

For the wiring diagram, refer to "Parking Brake / Brake Fluid Level Warning Light System" in the wiring diagram. [Ref. to WIRING SYSTEM>Parking Brake / Brake Fluid Level Warning Light System>WIRING DIAGRAM.](#)

PARKING BRAKE > Parking Brake System

ELECTRICAL SPECIFICATION

For the electrical specification, refer to "Control Module I/O Signal" of "BRAKE CONTROL (DIAGNOSTICS)" section. [Ref. to BRAKE CONTROL \(DIAGNOSTICS\)>Control Module I/O Signal.](#)

PARKING BRAKE > Parking Brake System

INSPECTION

For inspection, refer to "Basic Diagnostic Procedure" of "BRAKE CONTROL (DIAGNOSTICS)" section. [Ref. to BRAKE CONTROL \(DIAGNOSTICS\)>Basic Diagnostic Procedure.](#)

PARKING BRAKE > Parking Brake System

OPERATION

1. BRAKE MAINTENANCE MODE

Caution:

- When DTC other than C1984 is detected, repair or replace the faulty parts and perform the brake maintenance mode.
- DTCs may be stored after starting the brake maintenance mode. When the brake maintenance mode is complete, clear the DTCs.
- When the brake maintenance mode is completed, the electronic parking brake automatically operates. Check if any other works are not performed in advance. Sufficient safety consideration is required.

Note:

- This function is used when inspecting and repairing the rear brake related parts.
- When the brake maintenance mode is performed, the electronic parking brake warning light and the electronic parking brake operation light illuminate, and DTC C1984 is stored. If the system returns from the brake maintenance mode to the normal mode, the electronic parking brake warning light goes off, and DTC is cleared.
- During the brake maintenance mode, the electronic parking brake cannot be applied/released.

1. Using the Subaru Select Monitor, select [Brake Maintenance Mode] in [Work Support] of [Brake Control]. [Ref. to COMMON \(DIAGNOSTICS\)>Work Support.](#)
2. Perform the operation according to the display screen.

PARKING BRAKE > Parking Brake System

NOTE

For operation procedures of components of the parking brake system, refer to the following sections.

- Parking brake lever: [Ref. to PARKING BRAKE>Parking Brake Lever.](#)
- Parking brake cable: [Ref. to PARKING BRAKE>Parking Brake Cable.](#)
- Parking brake assembly (rear disc brake): [Ref. to PARKING BRAKE>Parking Brake Assembly \(Rear Disc Brake\).](#)
- Parking brake actuator: [Ref. to PARKING BRAKE>Parking Brake Actuator.](#)
- Parking brake switch: [Ref. to PARKING BRAKE>Parking Brake Switch.](#)
- Emergency release of parking brake: [Ref. to PARKING BRAKE>Emergency Release of Electronic Parking Brake.](#)

PARKING BRAKE > Parking Brake Lever

REMOVAL

1. Disconnect the ground terminal from battery sensor. [Ref. to REPAIR CONTENTS>NOTE > BATTERY.](#)
2. Remove the console box assembly. [Ref. to EXTERIOR/INTERIOR TRIM>Console Box>REMOVAL.](#)
3. Release the parking brake.
4. Remove the lever assembly hand brake.
 - (1) Disconnect the connector of the switch assembly hand brake.
 - (2) Remove the flange lock nut.

(3) Remove the inner cable end from the equalizer.

(4) Remove the bolt, and then remove the lever assembly hand brake.

PARKING BRAKE > Parking Brake Lever

INSTALLATION

1. Install the lever assembly hand brake.

Tightening torque:
18 N·m (1.8 kgf-m, 13.3 ft-lb)
2. Apply grease to the tooth face of the lever assembly hand brake.

Preparation items:

Grease: NIPPON GREASE NIGTIGHT LTS No. 2 or equivalent

3. Apply grease to the sliding area of the inner cable end.

Preparation items:

Grease: NIPPON GREASE Spray Grease G2272 or equivalent

4. Install the inner cable end to equalizer.
5. Install a new flange lock nut.
6. Connect the connector of the switch assembly hand brake.
7. Adjust the parking brake. [Ref. to PARKING BRAKE>Parking Brake Assembly \(Rear Disc Brake\)>ADJUSTMENT.](#)
8. Install the console box assembly. [Ref. to EXTERIOR/INTERIOR TRIM>Console Box>INSTALLATION.](#)
9. Connect the ground terminal to battery sensor. [Ref. to REPAIR CONTENTS>NOTE > BATTERY.](#)

PARKING BRAKE > Parking Brake Lever

INSPECTION

1. Operate the lever assembly hand brake 3 to 4 times and fully return the lever assembly hand brake.
2. While slowly pulling up the lever assembly hand brake with a force of 200 N (20.4 kgf, 45 lbf), count the notches.

Specification:

7 — 8 notches

3. Adjust the parking brake if the inspection result is not within the standard value. [Ref. to PARKING BRAKE>Parking Brake Assembly \(Rear Disc Brake\)>ADJUSTMENT.](#)

- (6) Remove the nut and detach the clamp.
- (7) Remove the clamp hand brake cable.

PARKING BRAKE > Parking Brake Cable

INSTALLATION

- 1.** Install the cable assembly hand brake.
 - (1) Install the cable assembly hand brake to the parking lever. [Ref. to PARKING BRAKE>Parking Brake Assembly \(Rear Disc Brake\)>INSTALLATION.](#)
 - (2) Install the clamp hand brake cable.
 - (3) Install the grommet to the floor.
 - (4) Install the cable assembly hand brake.

Tightening torque:
18 N·m (1.8 kgf-m, 13.3 ft-lb)
- 2.** Install the rear exhaust pipe. [Ref. to EXHAUST\(H4DOTC\)>Rear Exhaust Pipe>INSTALLATION.](#)
- 3.** Install the fuel tank protector. [Ref. to FUEL INJECTION \(FUEL SYSTEMS\)\(H4DOTC\)>Fuel Tank Protector>INSTALLATION.](#)
- 4.** Install the clamp hand brake.

Tightening torque:
18 N·m (1.8 kgf-m, 13.3 ft-lb)
- 5.** Apply grease to the sliding area of the inner cable end and install it to the equalizer.

Preparation items:
Grease: NIPPON GREASE Spray Grease G2272 or equivalent
- 6.** Install a new flange lock nut.
- 7.** Adjust the parking brake. [Ref. to PARKING BRAKE>Parking Brake Assembly \(Rear Disc Brake\)>ADJUSTMENT.](#)
- 8.** Install the console box assembly. [Ref. to EXTERIOR/INTERIOR TRIM>Console Box>INSTALLATION.](#)
- 9.** Install the rear wheels. [Ref. to WHEEL AND TIRE SYSTEM>Tire and Wheel>INSTALLATION.](#)
- 10.** Connect the ground terminal to battery sensor. [Ref. to REPAIR CONTENTS>NOTE > BATTERY.](#)

PARKING BRAKE > Parking Brake Cable

INSPECTION

- 1.** Check the parking brake cable for smooth operation.
- 2.** Check the inner cable for damage and rust.
- 3.** Check the outer cable for damage, bends and cracks.
- 4.** Replace the parking brake cable if it is found defective.

PARKING BRAKE > Parking Brake Assembly (Rear Disc Brake)

REMOVAL

1. EXCEPT FOR THE ELECTRONIC PARKING BRAKE MODEL

1. Release the parking brake.
2. Remove the rear wheels. [Ref. to WHEEL AND TIRE SYSTEM>Tire and Wheel>REMOVAL.](#)
3. Remove the disc brake assembly rear and brake disc rear. [Ref. to BRAKE>Rear Disc Rotor>REMOVAL.](#)
4. Remove the spring A.

5. Remove the spring rod (a) and the strut (b).

6. Remove the spring adjuster (a) and the adjuster assembly (b).

7. Remove the shoe set pin (a) and the spring shoe clamp (b) and then remove the front brake shoe (c).

8. Remove the rear brake shoe.

(1) Remove the shoe set pin (a) and the spring shoe clamp (b) and then remove the rear brake shoe (c).

(2) Remove the cable assembly hand brake (a) from the parking lever (b).

9. Remove the parking lever from the rear brake shoe.

Note:

Perform this procedure only when required.

(1) Remove the ring retainer.

(2) Remove the spring washer (a) and then remove the parking lever (b) from the brake shoe.

2. ELECTRONIC PARKING BRAKE MODEL

For removal procedures, refer to "Rear Disc Brake Assembly" of "BRAKE" section. [Ref. to BRAKE>Rear Disc Brake Assembly>REMOVAL > ELECTRONIC PARKING BRAKE MODEL.](#)

PARKING BRAKE > Parking Brake Assembly (Rear Disc Brake)

INSTALLATION

1. EXCEPT FOR THE ELECTRONIC PARKING BRAKE MODEL

1. Apply a thin coat of grease to the contact surface of the brake shoe of the rear brake back plate.

Preparation items:

Grease: DOW CORNING TORAY Molykote 44MA or equivalent

2. Install the parking lever to the rear brake shoe.

- (1) Apply a thin coat of grease to the contact surface of the parking lever of the parking lever pin.

Preparation items:

Grease: DOW CORNING TORAY Molykote 44MA or equivalent

- (2) Install the parking lever pin, the parking lever, the spring washer, and a new ring retainer to the brake shoe.
- (3) Swage the ring retainer to secure.

3. Install the cable assembly hand brake to the parking lever.
4. Apply a thin coat of grease to the adjuster assembly.

Preparation items:

Grease: DOW CORNING TORAY Molykote 44MA or equivalent

5. Apply a thin coat of grease to the strut.

Preparation items:

Grease: DOW CORNING TORAY Molykote 44MA or equivalent

6. Install the adjuster assembly and the spring adjuster to the front and rear brake shoes.

Caution:

Install the adjuster assembly so that the screw section on the LH side will be towards the rear of the vehicle, and the screw section on the RH side will be towards the front of the vehicle.

(A) LH side

(B) RH side

(a) Front side of vehicle

- 7.** Install the rear brake shoe with the shoe set pin and the spring shoe clamp.
- 8.** Install the strut.
- 9.** Install the front brake shoe with the shoe set pin and the spring shoe clamp.
- 10.** Install the spring rod.
- 11.** Install the spring A.
- 12.** Make sure that each part is installed correctly.

(A) LH side

(B) RH side

(a) Front side of vehicle

- 13.** Install the brake disc rear and the disk brake assembly rear. [Ref. to BRAKE>Rear Disc Rotor>INSTALLATION.](#)
- 14.** Adjust the parking brake. [Ref. to PARKING BRAKE>Parking Brake Assembly \(Rear Disc Brake\)>ADJUSTMENT.](#)
- 15.** Install the rear wheels. [Ref. to WHEEL AND TIRE SYSTEM>Tire and Wheel>INSTALLATION.](#)
- 16.** If the brake shoes are replaced with new parts, perform break-in driving.
 - (1) Drive the vehicle at approximately 35 km/h (22 MPH) or more.

- (2) While pressing the button of the lever assembly hand brake, pull the lever assembly hand brake with a force of 150 N (15.3 kgf, 33.7 lbf).
- (3) Drive the vehicle for about 200 m (0.12 mile) in the conditions described in (2).
- (4) Wait 5 to 10 minutes for the parking brake to cool down, and repeat steps (1) through (3).
- (5) After breaking-in, re-adjust the parking brakes. [Ref. to PARKING BRAKE>Parking Brake Assembly_\(Rear Disc Brake\)>ADJUSTMENT.](#)

2. ELECTRONIC PARKING BRAKE MODEL

For installation procedures, refer to "Rear Disc Brake Assembly" of "BRAKE" section. [Ref. to BRAKE>Rear Disc Brake Assembly>INSTALLATION > ELECTRONIC PARKING BRAKE MODEL.](#)

PARKING BRAKE > Parking Brake Assembly (Rear Disc Brake)

INSPECTION

1. EXCEPT FOR THE ELECTRONIC PARKING BRAKE MODEL

- **CHECK DISC ROTOR INNER DIAMETER**

- 1. Using a caliper, check the inner diameter of the brake disc rear.

	Value in a brand-new state	Wear limit
Disc rotor inner diameter	190 mm (7.48 in)	191 mm (7.52 in)

- 2. If the wear limit is exceeded or scoring or worn is found on the disc in the inspection, replace the brake disc rear.

- **CHECK LINING THICKNESS**

- 1. Check the lining thickness (a).

	Value in a brand-new state	Wear limit
Lining thickness	3.5 mm (0.14 in)	1.5 mm (0.06 in)

- 2. If the wear limit is exceeded in the inspection, replace the brake shoe.

Caution:
Replace the right and left brake shoe as a set.

PARKING BRAKE > Parking Brake Assembly (Rear Disc Brake)

ADJUSTMENT

1. EXCEPT FOR THE ELECTRONIC PARKING BRAKE MODEL

1. Disconnect the ground terminal from battery sensor. [Ref. to REPAIR CONTENTS>NOTE > BATTERY.](#)
2. Remove the console box assembly. [Ref. to EXTERIOR/INTERIOR TRIM>Console Box>REMOVAL.](#)
3. Release the parking brake.
4. Loosen the flange lock nut, and make the cable free.

5. Remove the rear wheels. [Ref. to WHEEL AND TIRE SYSTEM>Tire and Wheel>REMOVAL.](#)
6. Adjust the brake shoe clearance.
 - (1) Remove the plug.

- (2) Turn the adjuster assembly in the direction where it is extended (a) by inserting a flat tip screwdriver until the brake shoe is in close contact with the brake disc.
- (3) Return the adjuster assembly by 10 notches in the direction (b) where it is shortened.

Caution:

Make sure that the adjuster assembly is returned by 10 notches. If it is not returned sufficiently, dragging may occur.

- (4) Check there is no parking brake drag.

(5) Install the plugs.

7. Operate the lever assembly hand brake 3 to 4 times and fully return the lever assembly hand brake.
8. While slowly pulling up the lever assembly hand brake with a force of 200 N (20.4 kgf, 45 lbf), count the notches.
9. Turn and adjust the flange lock nut so that the lever stroke is within the specified value.

Specification:

7 – 8 notches

10. Check there is no parking brake drag.
11. Check that the brake warning light illuminates when the lever assembly hand brake is operated.

Caution:

Check that the light illuminates when the first notch is reached after pulling the lever.

12. Install the rear wheels. [Ref. to WHEEL AND TIRE SYSTEM>Tire and Wheel>INSTALLATION.](#)
13. Install the console box assembly. [Ref. to EXTERIOR/INTERIOR TRIM>Console Box>INSTALLATION.](#)
14. Connect the ground terminal to battery sensor. [Ref. to REPAIR CONTENTS>NOTE > BATTERY.](#)

REMOVAL

1. PARKING BRAKE ACTUATOR

Caution:

- Do not remove the parking brake actuator except when there are system malfunctions (such as emergency release of parking brake or abnormal actuator) or when the caliper is replaced. Also, when the parking brake actuator is reused, always replace the O-ring with a new part contained in the caliper body.
- Do not reuse the parking brake actuator when the emergency release of parking brake was performed, or when the parking brake actuator has a malfunction. Always replace with a new parking brake actuator.

1. Release the parking brake.
2. Execute the brake maintenance mode. [Ref. to PARKING BRAKE>Parking Brake System>OPERATION > BRAKE MAINTENANCE MODE.](#)
3. Disconnect the ground terminal from battery sensor. [Ref. to REPAIR CONTENTS>NOTE > BATTERY.](#)
4. Remove the rear wheels. [Ref. to WHEEL AND TIRE SYSTEM>Tire and Wheel>REMOVAL.](#)
5. Remove the parking brake actuator.
 - (1) Disconnect the connector.

Caution:

Be careful that no water and dust enter inside the connectors.

- (2) Using a hexagon wrench, remove the bolts, and remove the parking brake actuator.

Caution:

When removing the parking brake actuator, do not use any tools. Slide it upward and downward by hand to remove.

2. PARKING BRAKE HARNESS

1. Disconnect the ground terminal from battery sensor. [Ref. to REPAIR CONTENTS>NOTE > BATTERY.](#)
2. Remove the console box assembly. [Ref. to EXTERIOR/INTERIOR TRIM>Console Box>REMOVAL.](#)
3. Disconnect the connector.

4. Remove the rear wheels. [Ref. to WHEEL AND TIRE SYSTEM>Tire and Wheel>REMOVAL.](#)
5. Remove the fuel tank protector. [Ref. to FUEL INJECTION \(FUEL SYSTEMS\)\(H4DOTC\)>Fuel Tank Protector>REMOVAL.](#)
6. Remove the rear exhaust pipe. [Ref. to EXHAUST\(H4DOTC\)>Rear Exhaust Pipe>REMOVAL.](#)
7. Remove the adapter cord EPB.
 - (1) Remove the grommet.
 - (2) Remove the bolt and detach the clamp.
 - (3) Remove the bolt and detach the clamp.
 - (4) Remove the bolt and detach the clamp.
 - (5) Remove the nut and detach the clamp.
 - (6) Remove the nut and detach the clamp.
 - (7) Remove the bolt and detach the clamp.
 - (8) Disconnect the connector.

PARKING BRAKE > Parking Brake Actuator

INSTALLATION

1. PARKING BRAKE ACTUATOR

Caution:

- Do not remove the parking brake actuator except when there are system malfunctions (such as emergency release of parking brake or abnormal actuator) or when the caliper is replaced. Also, when the parking brake actuator is reused, always replace the O-ring with a new part contained in the caliper body.
- Do not reuse the parking brake actuator when the emergency release of parking brake was performed, or when the parking brake actuator has a malfunction. Always replace with a new parking brake actuator.

1. Using a hexagon wrench, install the parking brake actuator.

Caution:

Replace the O-ring with a new part.

Tightening torque:

8 N·m (0.8 kgf-m, 5.9 ft-lb)

2. Connect the connector.
3. Connect the ground terminal to battery sensor. [Ref. to REPAIR CONTENTS>NOTE > BATTERY.](#)
4. Exit the brake maintenance mode. [Ref. to PARKING BRAKE>Parking Brake System>OPERATION > BRAKE MAINTENANCE MODE.](#)
5. After the operation is completed, apply and release the parking brake five times and ensure that the brake operates normally.
6. Install the rear wheels. [Ref. to WHEEL AND TIRE SYSTEM>Tire and Wheel>INSTALLATION.](#)

2. PARKING BRAKE HARNESS

1. Install the adapter cord EPB.
 - (1) Connect the connector.
 - (2) Install the grommet to the floor.
 - (3) Install the adapter cord EPB.

Tightening torque:

18 N·m (1.8 kgf-m, 13.3 ft-lb)

2. Install the rear exhaust pipe. [Ref. to EXHAUST\(H4DOTC\)>Rear Exhaust Pipe>INSTALLATION.](#)
3. Install the fuel tank protector. [Ref. to FUEL INJECTION \(FUEL SYSTEMS\)\(H4DOTC\)>Fuel Tank Protector>INSTALLATION.](#)
4. Install the rear wheels. [Ref. to WHEEL AND TIRE SYSTEM>Tire and Wheel>INSTALLATION.](#)
5. Connect the connector.
6. Install the console box assembly. [Ref. to EXTERIOR/INTERIOR TRIM>Console Box>INSTALLATION.](#)
7. Connect the ground terminal to battery sensor. [Ref. to REPAIR CONTENTS>NOTE > BATTERY.](#)

PARKING BRAKE > Parking Brake Switch

REMOVAL

1. EXCEPT FOR THE ELECTRONIC PARKING BRAKE MODEL

1. Disconnect the ground terminal from battery sensor. [Ref. to REPAIR CONTENTS>NOTE > BATTERY.](#)
2. Remove the console box assembly. [Ref. to EXTERIOR/INTERIOR TRIM>Console Box>REMOVAL.](#)
3. Disconnect the connector of the switch assembly hand brake.

4. Remove the screws, and remove the switch assembly hand brake.

2. ELECTRONIC PARKING BRAKE MODEL

1. Disconnect the ground terminal from battery sensor. [Ref. to REPAIR CONTENTS>NOTE > BATTERY.](#)
2. Remove the cover assembly front. [Ref. to EXTERIOR/INTERIOR TRIM>Console Box>REMOVAL.](#)
3. Remove the switch assembly EPB.
 - (1) Disconnect the connector of the switch assembly EPB.
 - (2) Remove the screws to remove the switch assembly EPB.

PARKING BRAKE > Parking Brake Switch

INSTALLATION

1. EXCEPT FOR THE ELECTRONIC PARKING BRAKE MODEL

1. Install the switch assembly hand brake.

Tightening torque:

1.5 N·m (0.2 kgf-m, 1.1 ft-lb)

2. Connect the connector of the switch assembly hand brake.
3. Install the console box assembly. [Ref. to EXTERIOR/INTERIOR TRIM>Console Box>INSTALLATION.](#)
4. Connect the ground terminal to battery sensor. [Ref. to REPAIR CONTENTS>NOTE > BATTERY.](#)

2. ELECTRONIC PARKING BRAKE MODEL

1. Install the switch assembly EPB.
2. Connect the connector of the switch assembly EPB.
3. Install the cover assembly front. [Ref. to EXTERIOR/INTERIOR TRIM>Console Box>INSTALLATION.](#)
4. Connect the ground terminal to battery sensor. [Ref. to REPAIR CONTENTS>NOTE > BATTERY.](#)

PARKING BRAKE > Parking Brake Switch

INSPECTION

1. EXCEPT FOR THE ELECTRONIC PARKING BRAKE MODEL

1. Measure the resistance between the switch assembly hand brake and chassis ground.

Inspection conditions	Standard
When shaft is free (ON)	Less than 1 Ω
When shaft is pressed in (OFF)	10 kΩ or more

2. Replace the switch assembly hand brake if the inspection result is not within the standard value.

2. ELECTRONIC PARKING BRAKE MODEL

• CHECK SWITCH ASSEMBLY EPB

1. Turn the ignition switch to OFF.
2. Disconnect the connector from the switch assembly EPB.
3. Check the resistance between switch assembly EPB terminals.

Switch position	Terminal No.	Standard
Press	5 – 2	Less than 1 Ω
(Release)	5 – 4	

Switch position	Terminal No.	Standard
Neutral	1 – 2 4 – 5	1 MΩ or more
	5 – 1 2 – 4	Less than 1 Ω
Pull (Lock)	5 – 1 5 – 2	Less than 1 Ω

4. Apply battery voltage between the connector terminals to check the lighting condition of the indicator light and illumination inside the switch.

Caution:

When applying battery voltage, do not mix up the positive (+) side and the negative (-) side. Incorrect polarity connection may cause LED damage inside the switch.

- indicator light

Terminal No.	Inspection conditions	Specification
6 (+) – 10 (-)	Apply battery voltage.	Light ON

- Illumination light

Terminal No.	Inspection conditions	Specification
7 (+) – 9 (-)	Apply battery voltage.	Light ON

5. Replace the switch assembly EPB if it is found defective.

• **CHECK HARNESS**

1. Check the resistance between connector terminals.

Terminal No.	Inspection conditions	Standard
1 – 2 4 – 5	Always	1 MΩ or more

2. If any faulty is found in the inspection, repair or replace the part concerned.

PARKING BRAKE > Emergency Release of Electronic Parking Brake

OPERATION

Caution:

- Perform this operation only when the parking brake must be released in emergency situation such as a system malfunction.
- When performing this procedure, be sure to fully confirm safety in the nearby area and park the vehicle on a horizontal ground.
- Always use the jack-up point when the shop jacks or rigid racks are used to support the vehicle.
- When removing the bolt, the parking brake actuator turns due to reaction force generated by the motor. Be careful not to pinch your hand.
- Wrap the tip of a screwdriver with cloth in order not to damage the caliper body that will be reused.
- Always remove the parking brake actuator while holding it by hand because the parking brake actuator falls off during removal.

1. Using the Subaru Select Monitor, select [Electric Parking Brake Compulsion Release Mode] in [Work Support] of [Brake Control]. [Ref. to COMMON \(DIAGNOSTICS\)>Work Support.](#)
2. Perform the operation according to the display screen.
3. With the following procedure, release the parking brake on the unreleased side.
 - (1) Disconnect the ground terminal from battery sensor. [Ref. to REPAIR CONTENTS>NOTE > BATTERY.](#)
 - (2) Set the wheel stoppers to front tires.
 - (3) Jack-up the rear side of vehicle and support it with rigid racks.
 - (4) Remove the rear wheels. [Ref. to WHEEL AND TIRE SYSTEM>Tire and Wheel>REMOVAL.](#)
 - (5) Disconnect the connector from the parking brake actuator.
 - (6) Using a hexagon wrench, remove the bolts from the parking brake actuator.

Caution:

Do not insert a tool into the seal surface (a) on the parking brake actuator.

- (7) Put a screwdriver between the parking brake actuator and the support rear disc brake (a), and push out the parking brake actuator.

- (8) Insert a screwdriver into the gap (a) made by pushing the parking brake actuator, and then remove it.

(9) Using TORX® E12, turn the caliper body spindle bolt clockwise by approx. 1 rotation.

Note:

Turn both the left and right sides clockwise.

(10) Confirm that the parking brake lock is released and the disc rotor rotates.

(11) Temporarily install the parking brake actuator.

Caution:

- **When the emergency release of parking brake was performed, replace the parking brake actuator with a new part after the system trouble is resolved.**
- **Do not connect the connector. It may be locked again due to continuity.**
- **If the vehicle needs to be moved, cover the connector with vinyl tape to prevent foreign matter from entering, and secure it in an area where no interference occurs.**

(12) Install the parking brake actuator.

Tightening torque:

8 N·m (0.8 kgf-m, 5.9 ft-lb)

(13) Connect the connector to the parking brake actuator.

(14) Install the rear wheels. [_Ref. to WHEEL AND TIRE SYSTEM>Tire and Wheel>INSTALLATION.](#)

(15) Connect the ground terminal to battery sensor. [_Ref. to REPAIR CONTENTS>NOTE > BATTERY.](#)

(16) When the emergency release of parking brake was performed, be sure to perform the inspection related to the parking brake system.

Note:

For inspection, refer to "Basic Diagnostic Procedure" of "BRAKE CONTROL (DIAGNOSTICS)" section. [_Ref. to BRAKE CONTROL \(DIAGNOSTICS\)>Basic Diagnostic Procedure.](#)

PARKING BRAKE > General Diagnostic Table

INSPECTION

1. EXCEPT FOR THE ELECTRONIC PARKING BRAKE MODEL

Symptoms	Possible cause	Corrective action
Brake drag	(1) Lever assembly hand brake is maladjusted.	Adjust.
	(2) Cable assembly hand brake does not work.	Repair or replace.
	(3) Brake shoe clearance is maladjusted.	Adjust.
	(4) Spring A is faulty.	Replace.
Noise from brake	(1) Spring A is faulty.	Replace.
	(2) Spring shoe clamp is faulty.	Replace.

2. ELECTRONIC PARKING BRAKE MODEL

Symptoms	Possible cause	Corrective action
Brake drag	(1) Defective parking brake switch	Replace.
	(2) Defective parking brake harness	Replace.
	(3) Defective parking brake actuator	Replace.
	(4) Loose parking brake actuator and support installation bolt	Tighten to the specified torque.
Noise from brake	(1) Worn or hardened brake pad	Replace.
	(2) Defective parking brake actuator	Replace.