



AIR CONDITIONER

AC

-
1. General Description
 2. Air Conditioning System
 3. Refrigerant Pressure with Manifold Gauge Set
 4. Refrigerant Recovery Procedure
 5. Refrigerant Charging Procedure
 6. Refrigerant Leak Check
 7. Relay and Fuse
 8. Compressor Oil
 9. Blower Motor
 10. Power Transistor
 11. Heater Core
 12. Compressor
 13. Control Unit
 14. Condenser
 15. Heater and Cooling Unit
 16. Evaporator
 17. Expansion Valve
 18. Hose and Pipe
 19. Pressure Sensor
 20. Ambient Sensor
 21. Sunload Sensor (Auto A/C Model)
 22. In-Vehicle Sensor (Auto A/C Model)
 23. Temperature and Humidity Sensor
 24. Evaporator Sensor
 25. FRESH/RECIRC Door Actuator
 26. Mode Door Actuator
 27. Air Mix Door Actuator
 28. Air Vent Grille
 29. Air Vent Duct
 30. A/C Filter
 31. Diagnostics with Phenomenon

AIR CONDITIONER > General Description

CAUTION

- When performing service operation, refer to "Repair Contents" in "General Description".  [Ref. to REPAIR CONTENTS>Repair Contents.](#)
- Refer to "CAUTION" of "General Description" in "AIRBAG SYSTEM" section.  [Ref. to AIRBAG SYSTEM>General Description>CAUTION.](#)
- Use SUBARU genuine grease, the recommended or equivalent. Do not mix grease etc. of different grades or manufacturers.
- When performing work on the sensors or modules, be careful of the following.
 - Before disconnecting electrical connectors, be sure to disconnect the ground terminal from the battery sensor.  [Ref. to REPAIR CONTENTS>NOTE > BATTERY.](#)
 - Do not apply any impact. If the parts are accidentally dropped, replace with a new part.
 - Do not expose to high-temperature and humidity.
- When replacing the parts provided with memory functions, record the memory contents before disconnecting the ground terminal from the battery sensor.
- Apply grease onto sliding or revolving surfaces before installation.
- Some vehicle components are extremely hot immediately after driving. Be wary of receiving burns from heated parts.

1. A/C SYSTEM

Before maintenance, check the refrigerant and compressor oil for the A/C system described on the label (a). Use the listed refrigerant, compressor oil and tools dedicated for the A/C system.

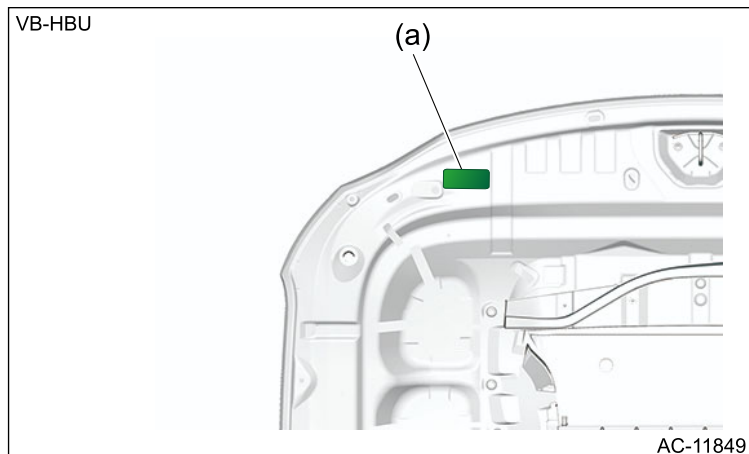

2. COMPRESSOR OIL

- Use the compressor oil listed on the label. The compressor oil is not compatible with any other brands of compressor oil.
- Compressor oil is very hygroscopic. When replacing or installing/removing A/C parts, immediately isolate the oil from atmosphere using a plug or tape. In order to avoid moisture, store the oil in a container with its cap tightly closed.

3. REFRIGERANT

- Use the refrigerant listed on the label.

- If an incorrect or no refrigerant is used, it will result in poor lubrication and the compressor itself may be damaged.

4. HANDLING OF REFRIGERANT

- The refrigerant boils at approx. -30°C (-22°F). When handling it, be sure to wear protective goggles and protective gloves. Direct contact of the refrigerant with skin may cause frostbite. If the refrigerant gets into your eye, avoid rubbing your eyes with your hands. Wash your eyes with plenty of water, and receive medical treatment from an eye doctor.
- Do not heat a service can. If a service can is directly heated, or put into boiling water, the inside pressure will become extremely high. This may cause the can to explode. If a service can must be warmed up, use warm water of 40°C (104°F) or less.
- Do not drop or impact a service can. (Observe the precautions and operation procedure described on the refrigerant container.)
- When the engine is running, do not open the high-pressure valve of manifold gauge. The high-pressure gas will back-flow resulting in an explosion of the can.
- Provide good ventilation and do not work in a closed area.
- In order to prevent global warming, avoid releasing refrigerant into the atmosphere. Using a refrigerant recovery system, discharge and recycle the gas.

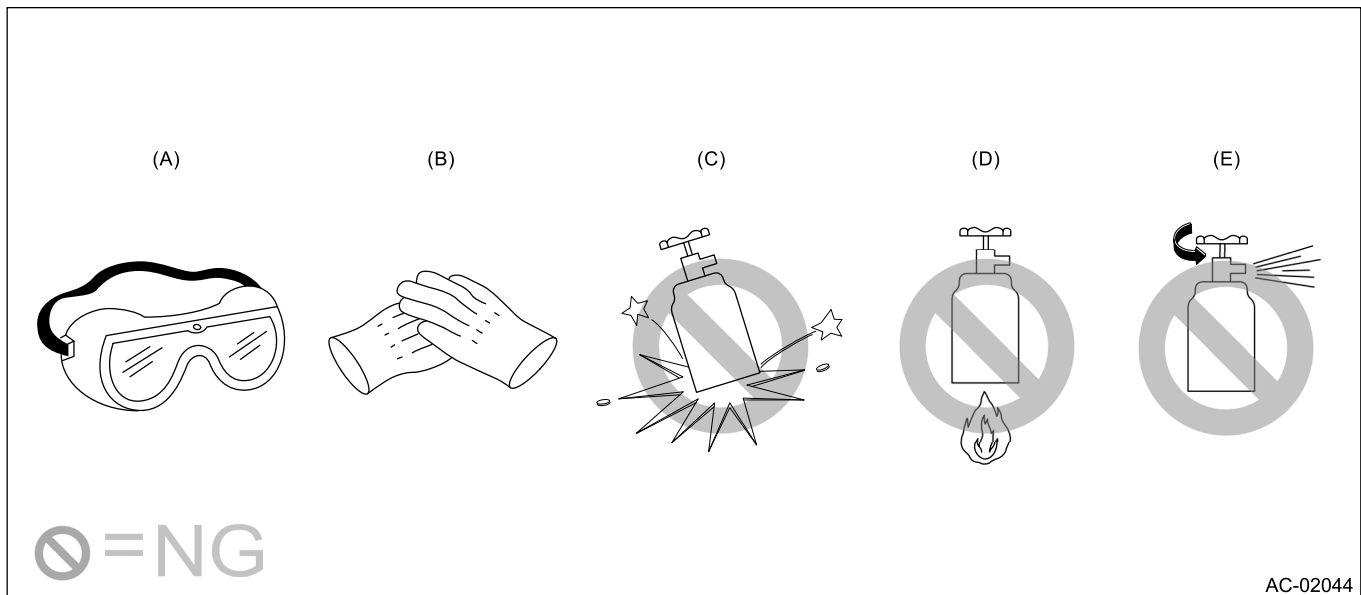

(A) Goggles

(B) Gloves

(C) Do not apply impact

(D) No direct heat on container

(E) Do not discharge

5. O-RING CONNECTIONS

- Always use a new O-ring.
- In order to keep the O-rings free of lint which will cause a refrigerant gas leak, perform work without using gloves or waste cloths.
- Apply compressor oil to O-rings to avoid sticking, before installation.
- Use a torque wrench to tighten the O-ring fittings. Over-tightening will result in damage of the O-ring and deformation of the pipe end.
- If the work is interrupted before completing pipe connections, recap the pipes, components and fittings with a plug or tape to prevent foreign matter from entering.

- Visually check the surfaces and mating surfaces of O-rings, threads and connecting points. If a failure is found, replace the applicable parts.
- Install the O-rings straight against the pipe groove.

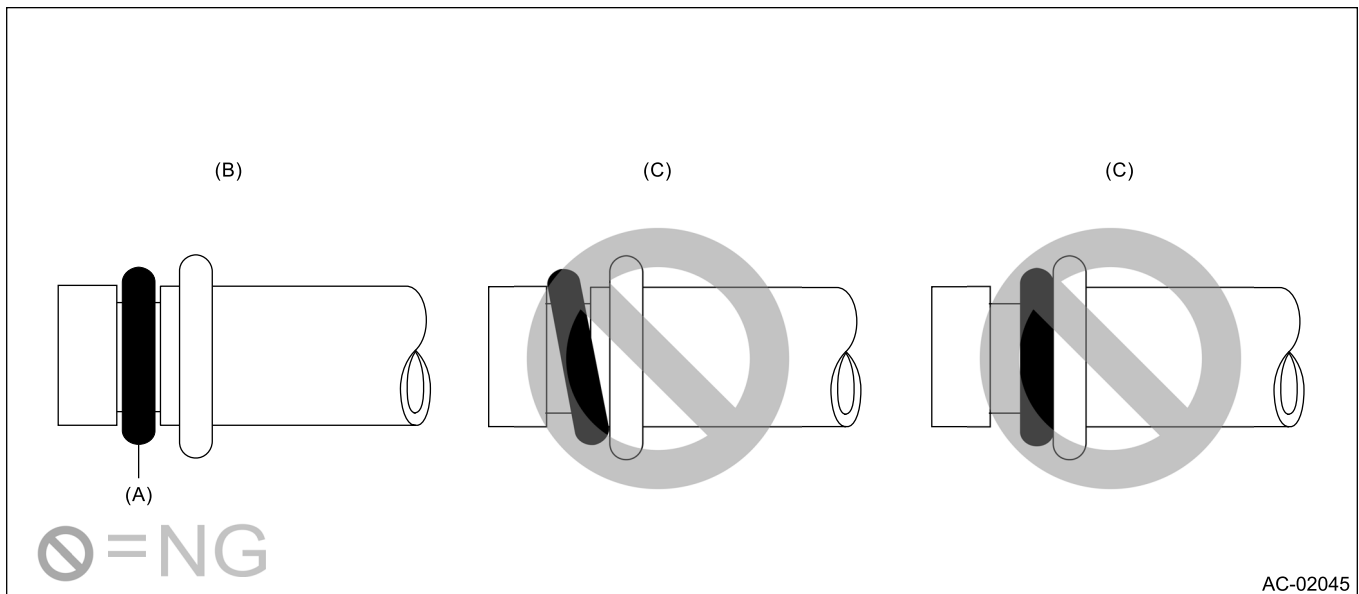

(A) O-ring

(B) OK

(C) NG

- Use the compressor oil indicated on the label to lubricate the O-rings.
- Apply oil to the top and sides of O-rings before installation.
- Apply compressor oil to the pipe grooves.

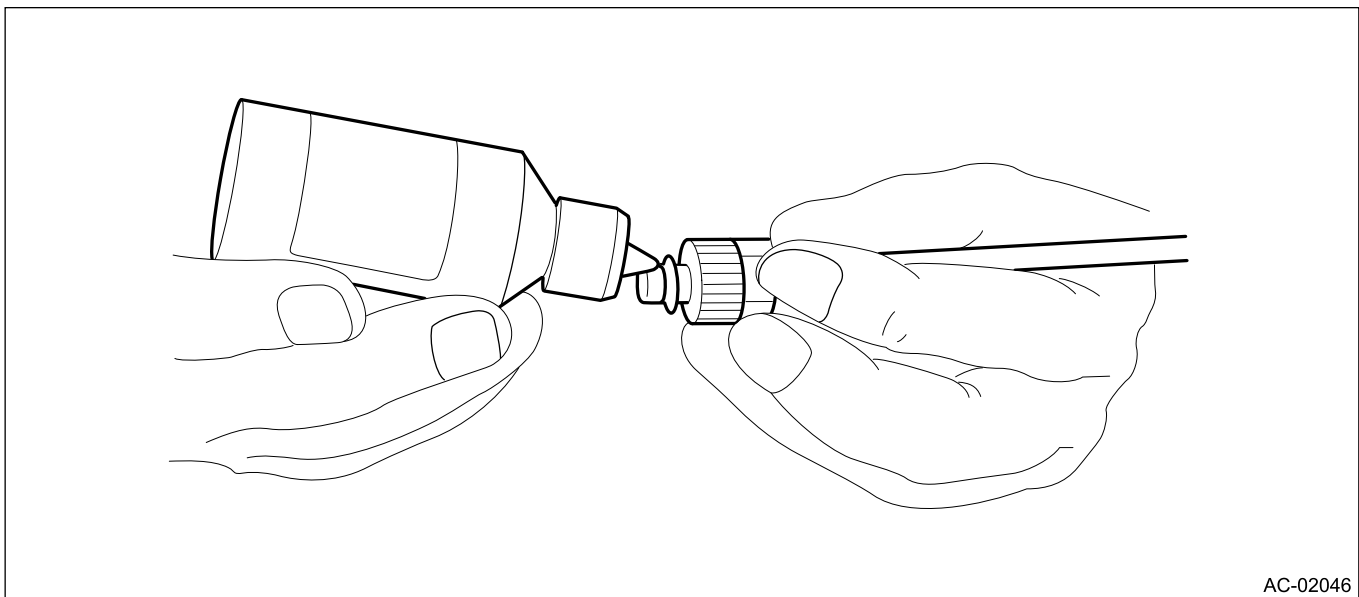

- After tightening, use a clean cloth to remove excess compressor oil from the connections and any oil which may have run on the vehicle body or other parts.
- If any leakage is suspected after tightening, do not tighten the connections further, but disconnect the connections, remove the O-rings, and check the O-rings, threads, and connections.

AIR CONDITIONER > General Description

SPECIFICATION

1. HEATER SYSTEM

Item		Specifications	Condition
Heating capacity		5.0 kW (4,299 kcal/h, 17,059 BTU/h) or more	<ul style="list-style-type: none"> Air flow control switch: FOOT Temperature setting: HI (MAX HOT) Temperature difference between hot water and inlet air: 65°C (149°F) Hot water flow rate: 360 L (95.1 US gal, 79.2 Imp gal)/h
Air flow rate		380 m ³ (13,420 cu ft) /h	<ul style="list-style-type: none"> Temperature setting: HI (MAX HOT) Fan speed: HI (MAX) FRESH/RECIRC position: FRESH Air flow control position: FOOT
Heater core	Size (width × height × thickness)	257.5 × 118.5 × 27 mm (10.14 × 4.67 × 1.06 in)	—
Blower motor	Motor type	Magnet	—
	Power consumption	300 W or less	12 V
	Fan type	Sirocco fan	—
	Size (diameter × height)	160 × 75 mm (6.3 × 2.95 in)	—

2. A/C SYSTEM

Item		Specifications	Condition
Type of air conditioner		Reheat air-mix	—
Cooling capacity		5.5 kW (4,729 kcal/h, 18,765 BTU/h) or more	<ul style="list-style-type: none"> Engine: Warmed up Air vent grille: Full open A/C switch: ON Temperature setting: LO (MAX COOL) Fan speed: HI (MAX) FRESH/RECIRC position: RECIRC

Item		Specifications	Condition
			<ul style="list-style-type: none"> Air flow control position: VENT
Air flow rate		530 m ³ (18,717 cu ft) /h	<ul style="list-style-type: none"> Temperature setting: LO (MAX COOL) Fan speed: HI (MAX) FRESH/RECIRC position: RECIRC Air flow control position: VENT
Compressor	Type	Variable capacity (VCS-14E)	—
	Discharge	140 cm ³ (8.54 cu in)/rev	—
	Max. permissible speed	9,000 r/min	—
	Oil	Recommended materials: VC100YF Capacity: 100 cm ³ (6.10 cu in)	—
Pulley	Type of belt	V-belt 6 PK	—
	Pulley diameter (Effective diameter)	110 mm (4.33 in)	—
	Pulley ratio	1.3	—
Condenser	Type	Corrugated fin (sub cool)	—
	Core face area	0.226 m ² (2.433 sq ft)	—
	Core thickness	12 mm (0.47 in)	—
	Radiation area	5.54 m ² (59.634 sq ft)	—
Receiver drier	Effective inner capacity	148 cm ³ (9.03 cu in)	—
Expansion Valve	Type	Block	—
Evaporator	Type	Double tank	—
	Size (Width × Height × Thickness)	290.1 × 225 × 39 mm (11.42 × 8.86 × 1.54 in)	—
Radiator main fan	Motor type	Magnet	—
	Power consumption	230 W	12 V
	Fan outer diameter	340 mm (13.4 in)	—
Radiator sub fan	Motor type	Magnet	—

Item		Specifications	Condition
	Power consumption	230 W	12 V
	Fan outer diameter	340 mm (13.4 in)	—
Idle speed		700±100 r/min	No load
		700 — 880±100 r/min	A/C ON

3. REFRIGERANT

Caution:
Do not mix different kinds of refrigerant.

Item	Recommended and alternative materials	Capacity
Refrigerant	<ul style="list-style-type: none"> Recommended materials: HFO-1234yf 	0.40±0.025 kg (0.88±0.06 lb)

4. BASIC OPERATION

The cooling system cools down the compartment by using the pipes connecting parts and cycling the evaporative liquid (refrigerant) within the sealed system in a repeated process of “vaporization — liquefaction — re-vaporization”.

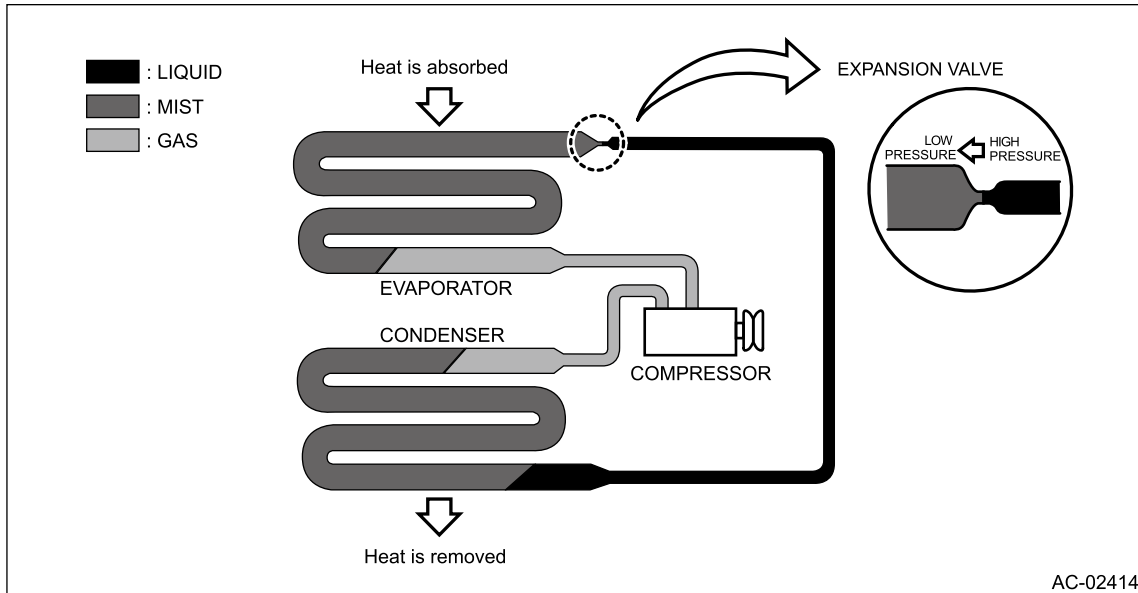

Item	Operation
Compressor	Sucks and pressurizes the low temperature, low pressure refrigerant gas that was vaporized at the evaporator by absorbing heat from the compartment, and sends the high temperature, high pressure refrigerant gas to the condenser.
Condenser	Cools the high temperature, high pressure refrigerant gas sent from the compressor for condense and liquefaction.
Expansion valve	<ul style="list-style-type: none"> Sprays the high temperature, high pressure liquid refrigerant from the small hole in order to let the refrigerant expand rapidly

Item	Operation
	to turn it into low temperature, low pressure mist. <ul style="list-style-type: none"> The refrigerant amount is adjusted according to the refrigerant vaporization condition in the evaporator.
Evaporator	The evaporator turns into a low temperature condition when the mist refrigerant that was turned into a low temperature, low pressure condition at the expansion valve is vaporized in large quantity in the evaporator. Passing air flow through the low temperature evaporator emits cold air.

AIR CONDITIONER > General Description

LOCATION

For location, refer to "Electrical Component Location" for "AIR CONDITIONER (DIAGNOSTICS)" section.

 [Ref. to AIR CONDITIONER\(DIAGNOSTICS\)>Electrical Component Location.](#)

AIR CONDITIONER > General Description

COMPONENT

1. HEATER AND COOLING UNIT ASSEMBLY

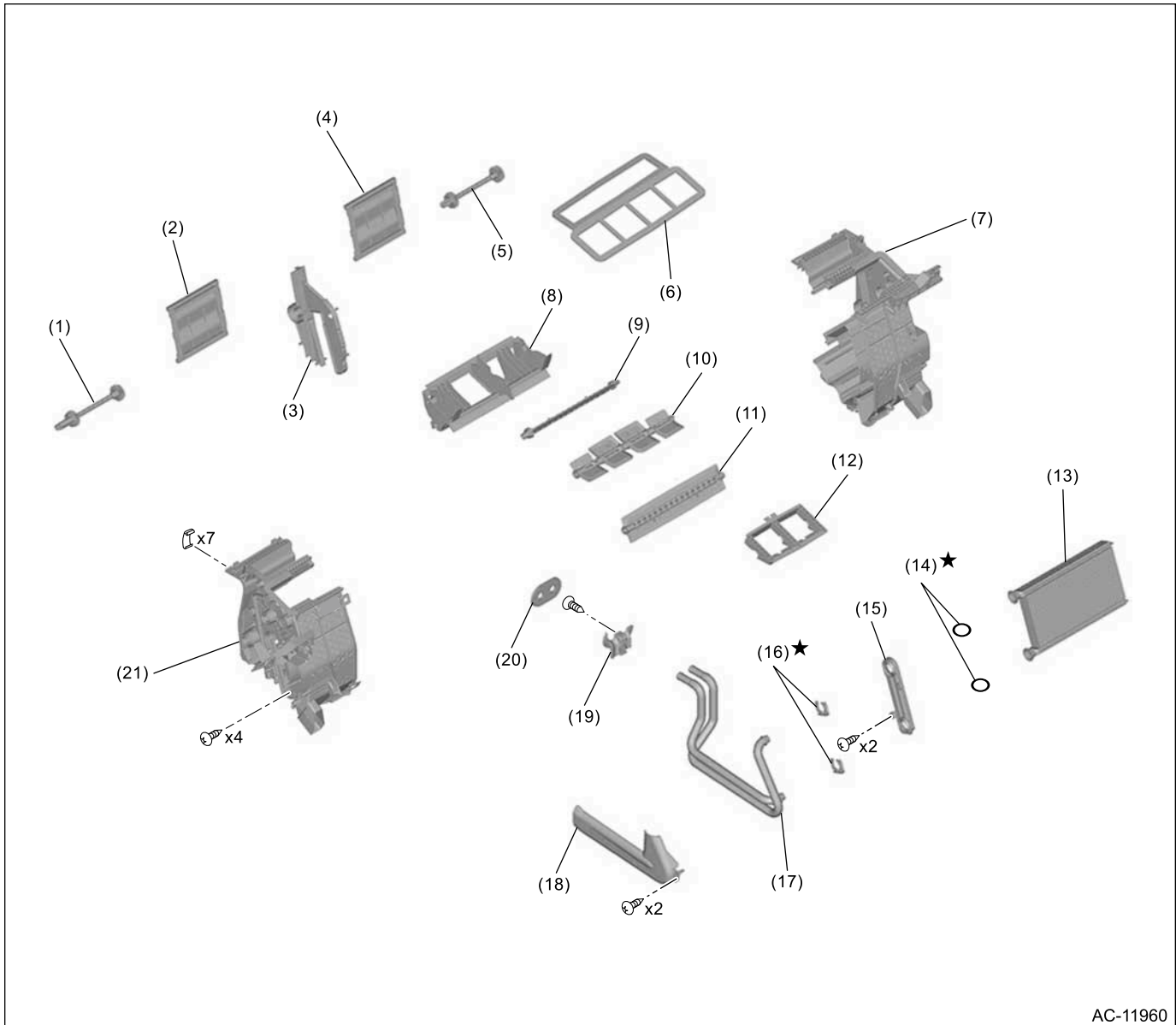

AC-11960

- | | | |
|-------------------------|------------------------|------------------------------|
| (1) Shaft mix LH | (8) Guide baffle plate | (15) Plate heater core |
| (2) Shutter mix LH | (9) Shutter defroster | (16) Clamp pipe |
| (3) Plate | (10) Shutter vent | (17) Pipe heater core |
| (4) Shutter mix RH | (11) Shutter foot | (18) Cover heater core pipe |
| (5) Shaft mix RH | (12) Plate center vent | (19) Clamp heater core pipe |
| (6) Gasket | (13) Heater core | (20) Gasket heater core pipe |
| (7) Case heater unit RH | (14) O-ring | (21) Case heater unit LH |

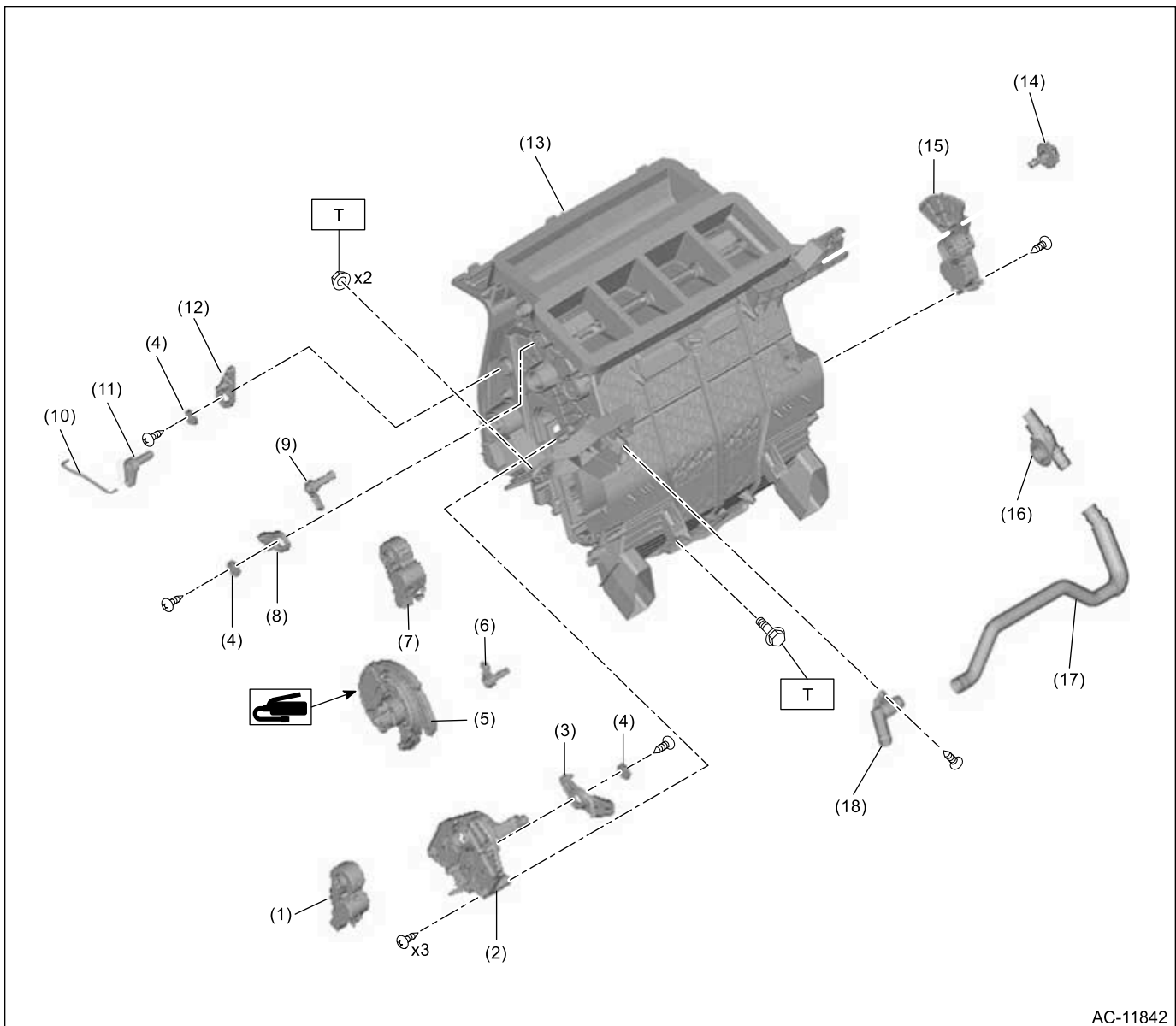

AC-11842

- | | | |
|--|--------------------------|--------------------------------|
| (1) Motor actuator mode | (8) Lever defroster sub | (15) Motor actuator air mix RH |
| (2) Bracket actuator mode | (9) Lever defroster door | (16) Aspirator |
| (3) Lever foot sub | (10) Rod vent | (17) Aspirator hose |
| (4) Washer heater | (11) Lever vent door | (18) Joint aspirator hose |
| (5) Lever mode | (12) Lever vent sub | |
| (6) Lever foot door | (13) Heater unit ASSY | |
| (7) Motor actuator mix LH (dual A/C model) | (14) Lever mix RH | |

Tightening torque: N·m (kgf·m, ft·lb)

T: 7.5 (0.8, 5.5)

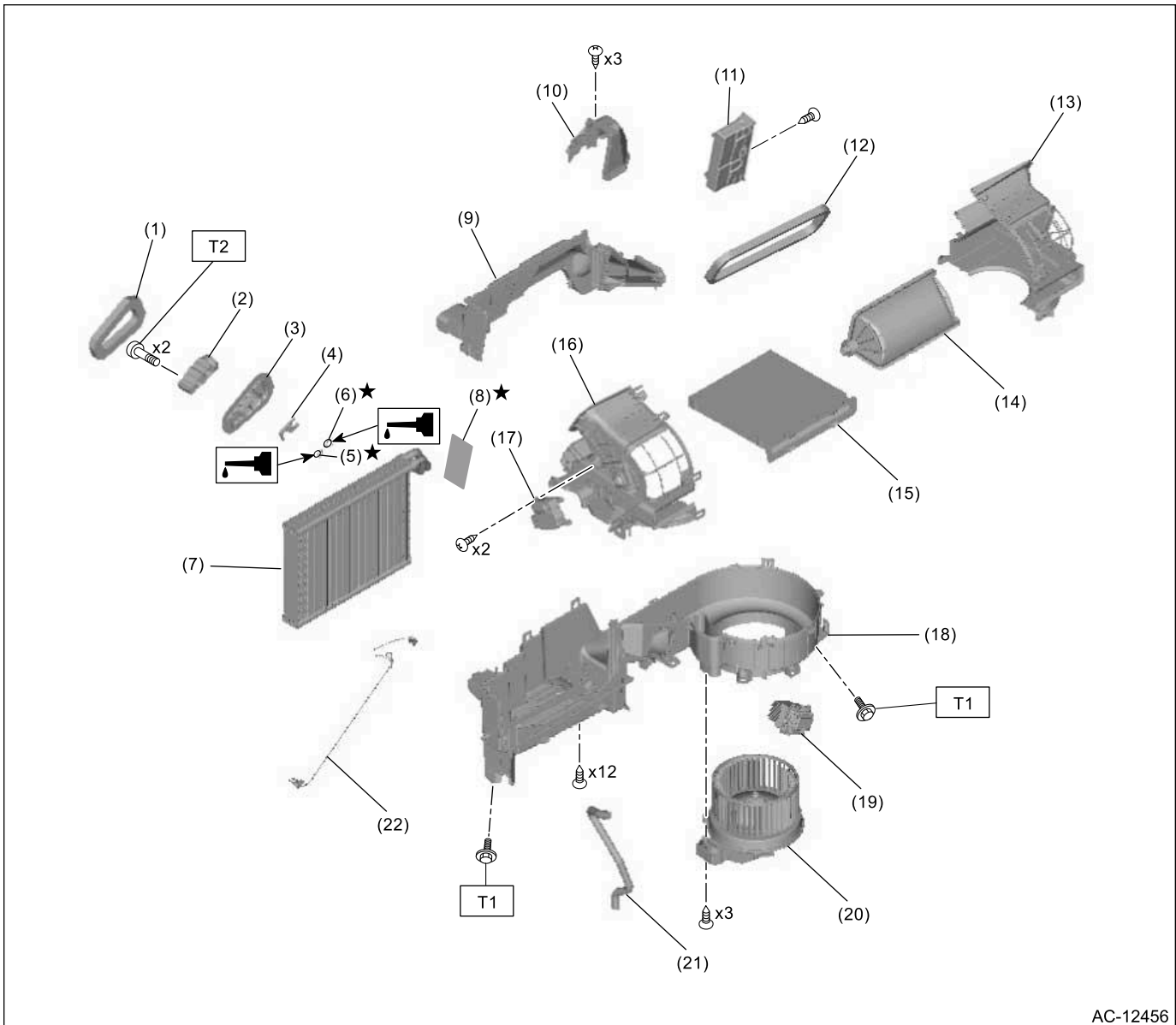

AC-12456

- | | | |
|----------------------------|----------------------------|------------------------|
| (1) Gasket expansion valve | (10) Cover evaporator | (19) Power transistor |
| (2) Expansion valve | (11) Air conditioner CM | (20) Blower motor ASSY |
| (3) Grommet | (12) Gasket intake | (21) Hose drain |
| (4) Plate | (13) Case blower intake RH | (22) Evaporator sensor |
| (5) O-ring | (14) Shutter blower | |
| (6) O-ring | (15) Filter | |
| (7) Evaporator ASSY | (16) Case blower intake LH | |
| (8) Insulator | (17) Motor actuator intake | |
| (9) Case heater UPR | (18) Case heater LWR | |

Tightening torque: N·m (kgf·m, ft·lb)

T1: 7.5 (0.8, 5.5)

T2: 7.7 (0.8, 5.7)

2. AIR CONDITIONING UNIT

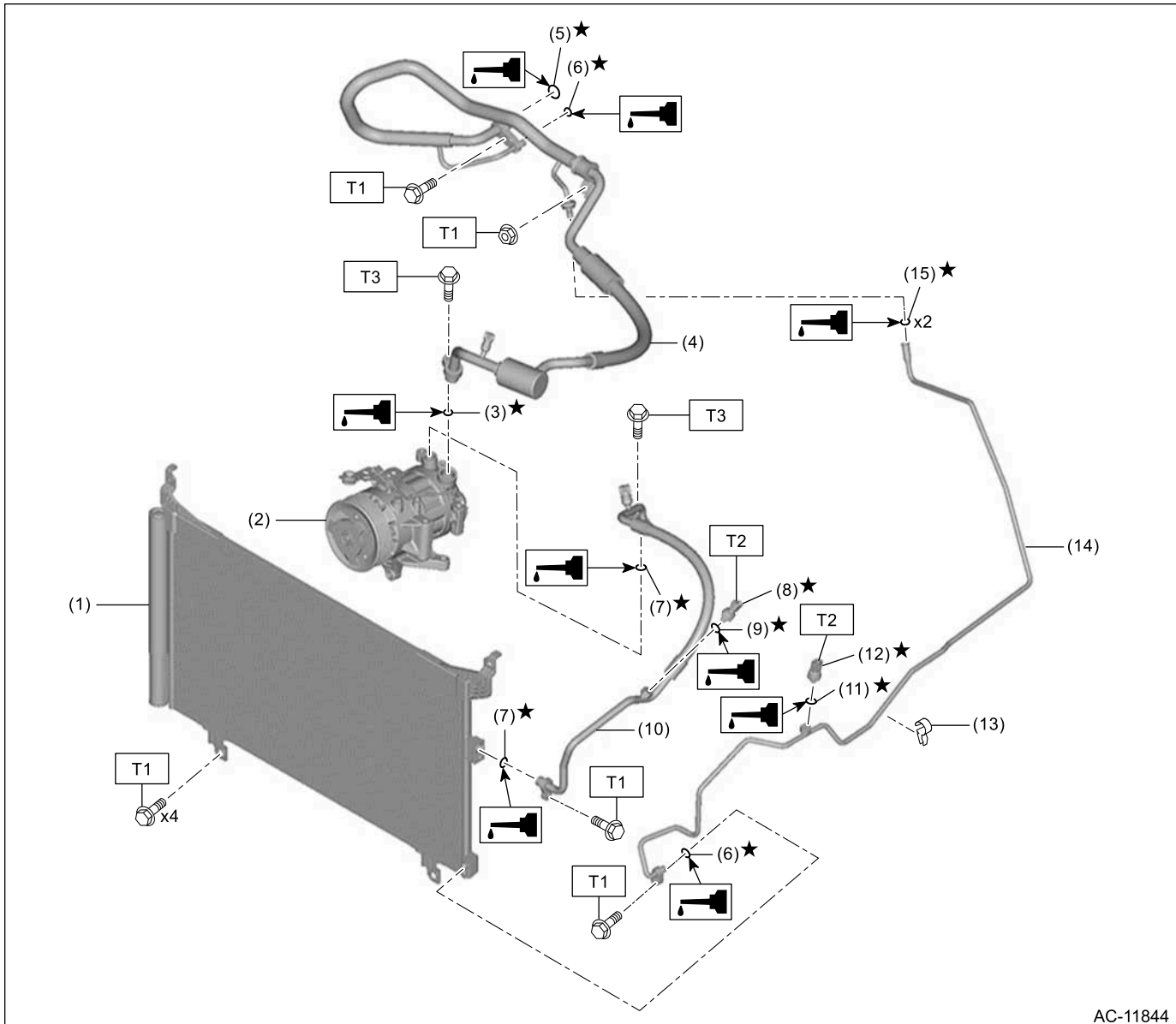

AC-11844

- | | |
|---------------------------|------------------------------|
| (1) Condenser ASSY | (8) Pressure sensor |
| (2) Compressor ASSY | (9) O-ring |
| (3) O-ring | (10) Hose pressure discharge |
| (4) Hose pressure suction | (11) O-ring |
| (5) O-ring | (12) Pressure sensor |
| (6) O-ring | (13) Clip pipe |
| (7) O-ring | (14) Pipe evaporator cooling |

(15) O-ring

Tightening torque: N-m (kgf-m, ft-lb)

T1: 7.5 (0.8, 5.5)

T2: 9.8±1.5 (1.0±0.2, 7.2±1.1)

T3: 10 (1.0, 7.4)

3. HEATER HOSE

- Type A

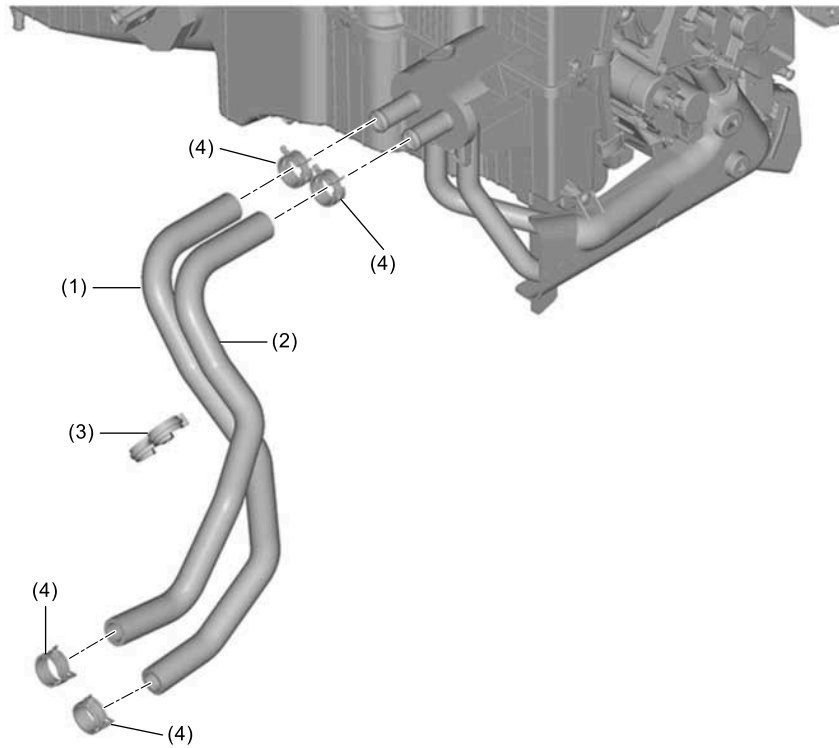

AC-11961

(1) Hose heater outlet

(3) Clip

(4) Heater hose clip

(2) Hose heater inlet

• Type B

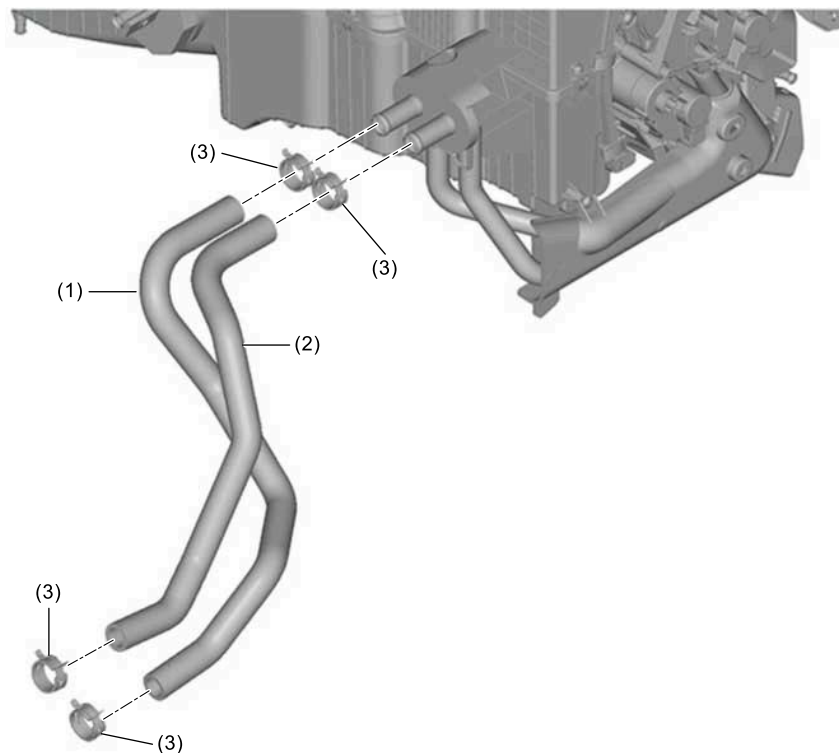

AC-12422

(1) Hose heater outlet

(2) Hose heater inlet

(3) Heater hose clip

4. COMPRESSOR

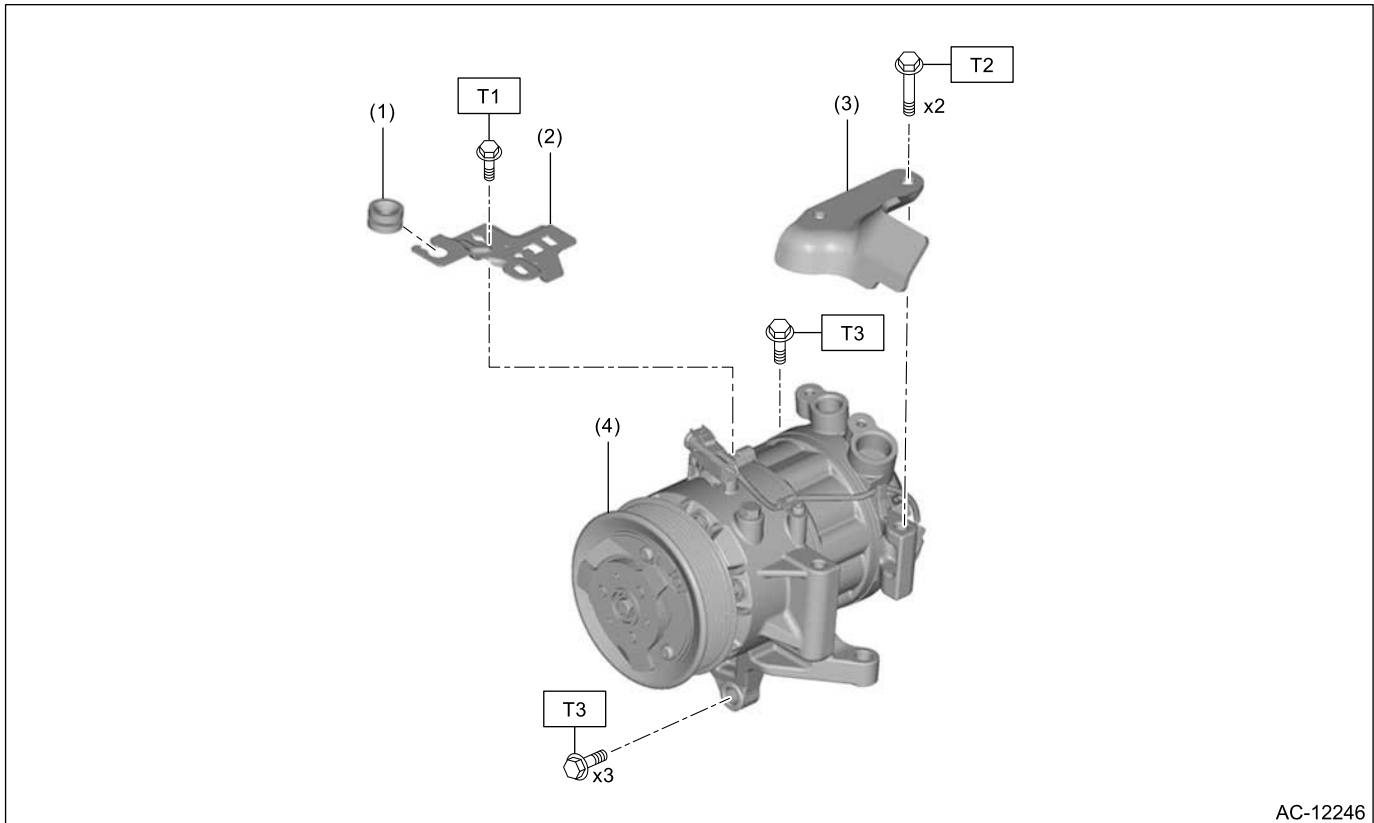

AC-12246

(1) Grommet

(3) Fuel pipe protector No. 1

Tightening torque: N·m (kgf·m, ft·lb)

(2) Bracket V-belt cover

(4) Compressor ASSY

T1: 6.4 (0.7, 4.7)

T2: 25 (2.5, 18.4)

T3:  Ref. to AIR

CONDITIONER>Compresso
r>INSTALLATION.

5. HEATER DUCT

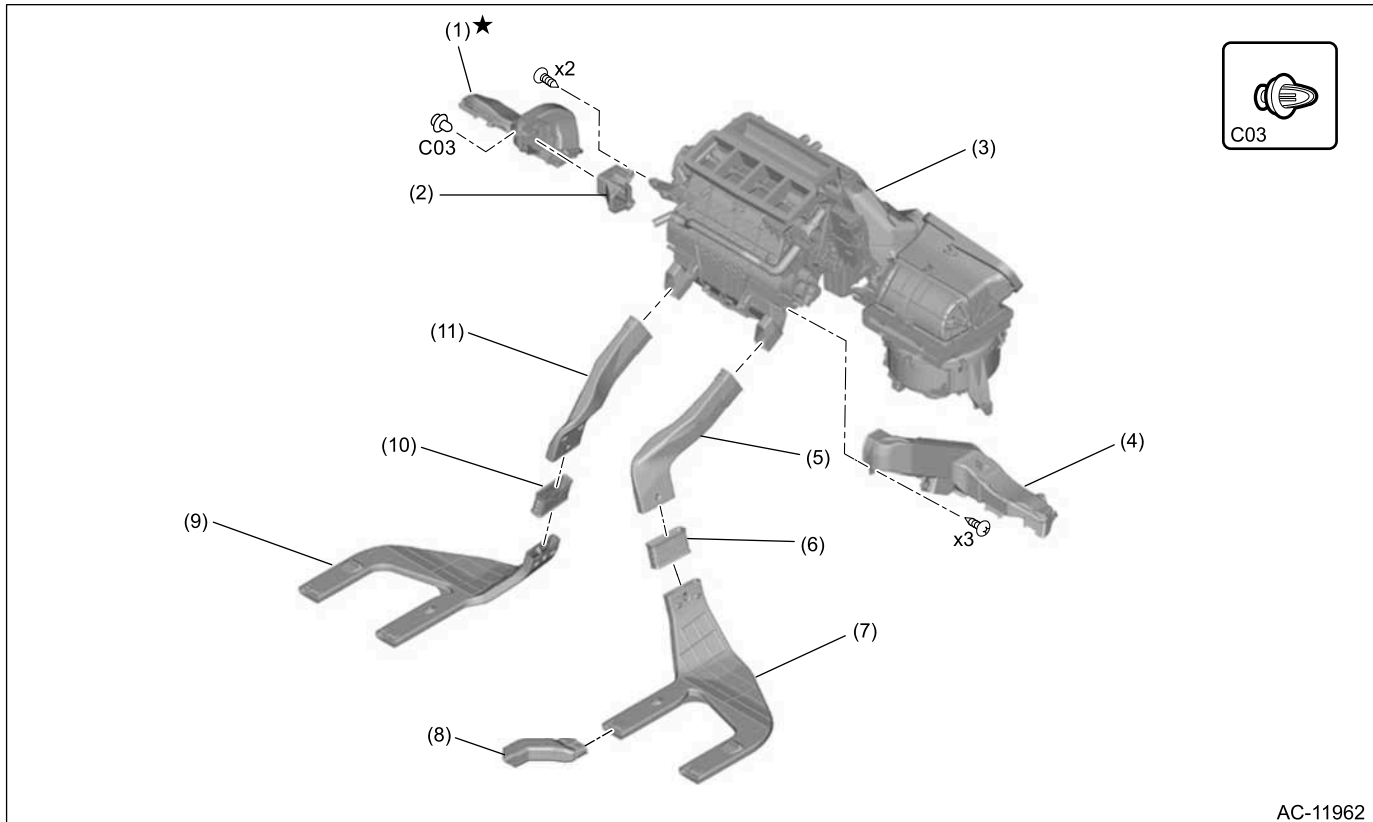

- | | | |
|-------------------------|-------------------------------|--------------------------------|
| (1) Duct foot driver | (5) Duct rear heater front RH | (9) Duct rear heater rear LH |
| (2) Spacer foot | (6) Duct joint RH | (10) Duct joint LH |
| (3) Heater unit ASSY | (7) Duct rear heater rear RH | (11) Duct rear heater front LH |
| (4) Duct foot passenger | (8) Duct extension* | |

*: Model with power amplifier

6. HEATER VENT DUCT AND GRILLE

For components of the air vent duct and air vent grille that are secured on the instrument panel, refer to "Instrument Panel" of "EXTERIOR/INTERIOR TRIM" section. [📄 Ref. to EXTERIOR/INTERIOR TRIM>General Description>COMPONENT > INSTRUMENT PANEL.](#)

AIR CONDITIONER > General Description

PREPARATION TOOL

1. SUBARU SPECIAL TOOL

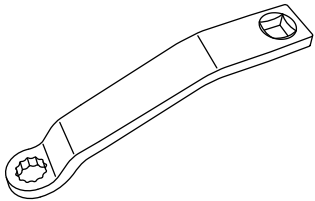
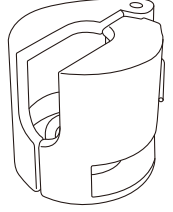
ILLUSTRATION	TOOL NUMBER	DESCRIPTION	REMARKS
 <p>STSSM4</p>	—	SUBARU SELECT MONITOR 4	Used for setting of each function and troubleshooting for electrical system. Note: <ul style="list-style-type: none"> • For detailed operation procedures, refer to "Help" of application. • Used together with interface for Subaru Select Monitor (such as DST-i and DST-010).
 <p>ST73099SG000</p>	73099SG000	SPECIAL TOOL CONDENSER	Used for installing the condenser.
 <p>ST73499SJ000</p>	73499SJ000	DISCONNECT TOOL	Used for separating the A/C pipes of a spring lock coupling type.

2. OTHER

Caution:

- Use only tools and parts dedicated to the HFO-1234yf system. If other types of refrigerant or compressor oil are mixed, it will result in poor lubrication and the compressor may be damaged.
- In order to prevent the mixture of other parts, grease or oil, the types of tools and screws and the replacement valves used are different. Use tools and parts appropriate for the system.

	HFO-1234yf	HFC-134a	CFC-12
Tool and screw type	Millimeter size	Millimeter size	Inch size
Valve type	Quick joint type	Quick joint type	Screw-in type

	REMARKS
Circuit tester	Used for measuring resistance, voltage and current.

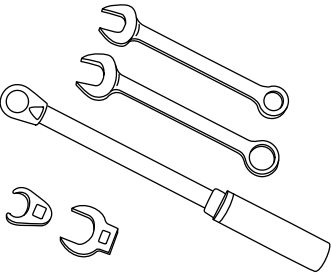
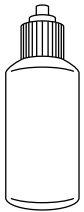
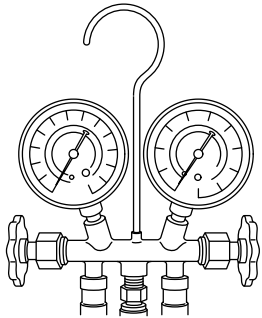
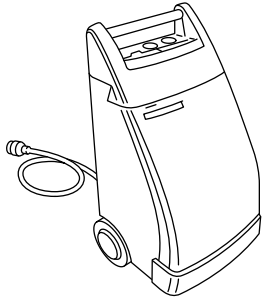
	REMARKS
Hexagon wrench	Used for removing and installing the expansion valve, etc.
Wrench  AC-00213	Various wrenches will be required to service any A/C system. 7 — 40 N·m (0.7 — 4.1 kgf-m, 5 — 30 ft-lb) torque wrench and various crowfoot wrenches will be needed. Open end or flare nut wrenches will be needed to affix the pipe and hose fittings.
Applicator bottle  AC-00012	A small applicator bottle is recommended to apply compressor oil to the various parts. It can be available at a hardware store.
Manifold gauge set  AC-00013	A manifold gauge set (with hoses) is available at either a refrigerant supplier or an automotive equipment supplier.
Refrigerant recovery system  AC-00014	A refrigerant recovery system is used for the recovery and recycling of A/C system refrigerant after contaminants and moisture have been removed from the refrigerant.

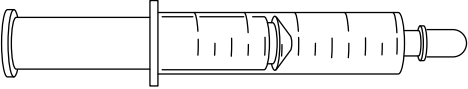
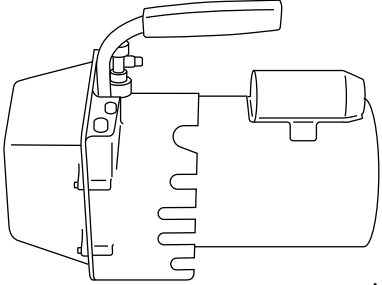
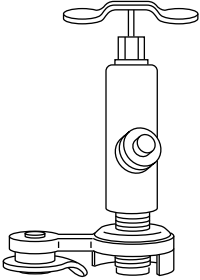
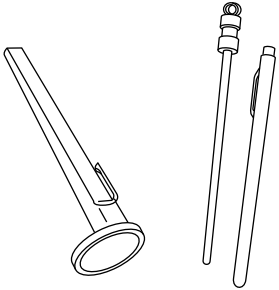
	REMARKS
<p>Syringe</p>  <p style="text-align: right;">AC-00015</p>	<p>A graduated plastic syringe will be needed to add oil into the system again. A syringe can be available at a pharmacy or drug store.</p>
<p>Vacuum pump</p>  <p style="text-align: right;">AC-00016</p>	<p>A vacuum pump is necessary (for a good working condition), and may be available at either a refrigerant supplier or an automotive equipment supplier.</p>
<p>Can tap</p>  <p style="text-align: right;">AC-00017</p>	<p>A can tap for refrigerant cans is available at an automotive equipment supplier.</p>
<p>Thermometer/hygrometer</p>  <p style="text-align: right;">AC-00018</p>	<p>A pocket thermometer/hygrometer is available at either an industrial hardware store or a refrigerant supplier.</p>
<p>Electronic leak detector</p>	<p>An electronic leak detector is available at either a specialty tool supplier or an A/C equipment supplier.</p>

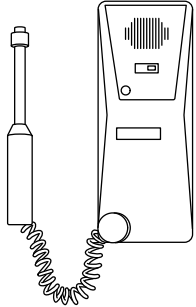
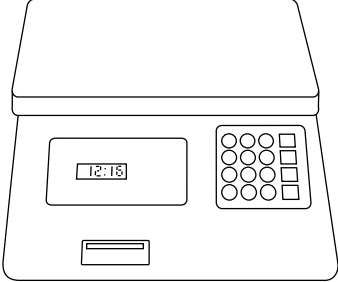
	REMARKS
 <p data-bbox="553 506 646 527">AC-00019</p>	
<p data-bbox="110 558 282 590">Weight scale</p>  <p data-bbox="553 915 646 936">AC-00020</p>	<p data-bbox="724 558 1471 667">A weight scale such as an electronic charging scale or a bathroom scale with digital display will be needed, if a 13.6 kg (30 lb) refrigerant container is used.</p>

AIR CONDITIONER > Air Conditioning System

WIRING DIAGRAM

For the wiring diagram, refer to "Air Conditioning System" in the wiring diagram. [🔍 Ref. to WIRING SYSTEM>Air Conditioning System>WIRING DIAGRAM.](#)

AIR CONDITIONER > Air Conditioning System

INSPECTION

1. BASIC INSPECTION

For basic inspection, refer to "Basic Diagnostic Procedure" of "AIR CONDITIONER (DIAGNOSTICS)" section. [🔍 Ref. to AIR CONDITIONER\(DIAGNOSTICS\)>Basic Diagnostic Procedure.](#)

2. SYSTEM BLOCK DIAGRAM

For system block diagram, refer to "System Block Diagram" in "AIR CONDITIONER (DIAGNOSTICS)" section. [🔍 Ref. to AIR CONDITIONER\(DIAGNOSTICS\)>General Description>SYSTEM BLOCK DIAGRAM.](#)

3. MODULE I/O SIGNAL

For the specification (electrical component), refer to "Control Module I/O Signal" of "AIR CONDITIONER (DIAGNOSTICS)" section. [🔍 Ref. to AIR CONDITIONER\(DIAGNOSTICS\)>Control Module I/O Signal>ELECTRICAL SPECIFICATION.](#)

AIR CONDITIONER > Air Conditioning System

NOTE

For procedure of each component in the air conditioning system, refer to the sections below.

- Blower motor: [🔍 Ref. to AIR CONDITIONER>Blower Motor.](#)
- Power transistor: [🔍 Ref. to AIR CONDITIONER>Power Transistor.](#)
- Compressor: [🔍 Ref. to AIR CONDITIONER>Compressor.](#)
- Heater core: [🔍 Ref. to AIR CONDITIONER>Heater Core.](#)
- Condenser: [🔍 Ref. to AIR CONDITIONER>Condenser.](#)
- Heater and cooling unit: [🔍 Ref. to AIR CONDITIONER>Heater and Cooling Unit.](#)
- Evaporator: [🔍 Ref. to AIR CONDITIONER>Evaporator.](#)
- Expansion valve: [🔍 Ref. to AIR CONDITIONER>Expansion Valve.](#)
- Hose & pipe: [🔍 Ref. to AIR CONDITIONER>Hose and Pipe.](#)
- Pressure sensor: [🔍 Ref. to AIR CONDITIONER>Pressure Sensor.](#)
- Ambient sensor: [🔍 Ref. to AIR CONDITIONER>Ambient Sensor.](#)
- Sunload sensor: [🔍 Ref. to AIR CONDITIONER>Sunload Sensor \(Auto A/C Model\).](#)
- In-vehicle sensor: [🔍 Ref. to AIR CONDITIONER>In-Vehicle Sensor \(Auto A/C Model\).](#)
- Temperature and humidity sensor: [🔍 Ref. to AIR CONDITIONER>Temperature and Humidity Sensor.](#)
- Evaporator sensor: [🔍 Ref. to AIR CONDITIONER>Evaporator Sensor.](#)
- Intake door actuator: [🔍 Ref. to AIR CONDITIONER>FRESH/RECIRC Door Actuator.](#)
- Mode door actuator: [🔍 Ref. to AIR CONDITIONER>Mode Door Actuator.](#)
- Air mix door actuator: [🔍 Ref. to AIR CONDITIONER>Air Mix Door Actuator.](#)

AIR CONDITIONER > Refrigerant Pressure with Manifold Gauge Set

PROCEDURE

1. CHECK REFRIGERANT GAS PRESSURE

1. Prepare the vehicle.
 - Place the vehicle in the shade and windless condition, and open the front hood.
 - Open the front and rear windows and close all doors.
 - Check that the ambient temperature is 25 — 40 °C (77 — 104 °F) and that the humidity is 30 — 80 %.
2. Check the refrigerant pressure.
 - (1) Attach the manifold gauge set.

Caution:

- **During operation, be sure to wear protective goggles and protective gloves.**
- **Follow the detailed operation procedure described in the attached operation manual.**

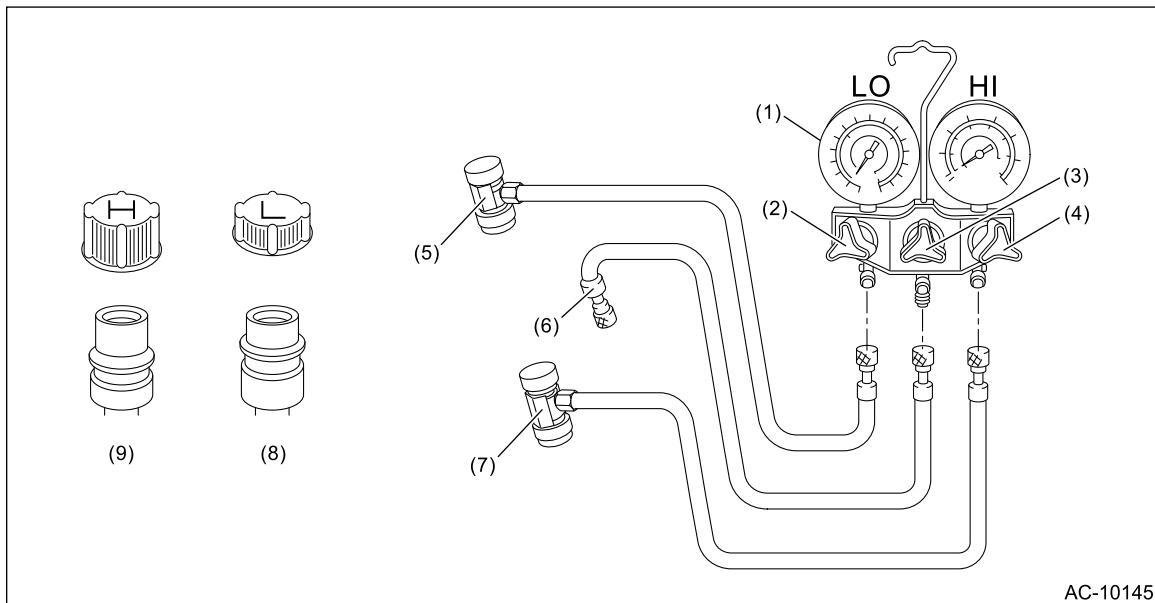

- | | | |
|------------------------|--|--|
| (1) Manifold gauge | (4) High pressure valve | (7) High-pressure hose |
| (2) Low pressure valve | (5) Low-pressure hose | (8) Low-pressure side service port |
| (3) Center valve | (6) Center manifold hose
(vacuum pump and charge) | (9) High-pressure side service
port |

1. Check that all valves are fully closed.
2. Install the low/high pressure hoses to the service ports on the low/high pressure sides of the vehicle respectively.

Caution:

Confirm that the connections are secure.

- (2) Start the engine.
- (3) Set the vehicle to the following conditions.

Item	Condition
Engine	Warming-up

Item	Condition
Air vent grille	Full open
A/C switch	ON
Temperature setting	LO (MAX COOL)
FRESH/RECIRC position	RECIRC
Air flow control position	VENT
Fan speed	5/7 level

(4) Idle the engine for 30 minutes under the conditions in step (3).

(5) Read the gauge values on both high pressure side and low pressure side of the manifold gauge.

3. Using a thermometer and a hygrometer, measure the air vent grille outlet opening temperature, ambient temperature and humidity.

Note:

For outlet opening temperature, measure the average temperature of center grille assembly and side grille assembly.

4. Check that the high and low pressures and outlet opening temperature for ambient temperature and humidity is within the standard value described in the chart below.

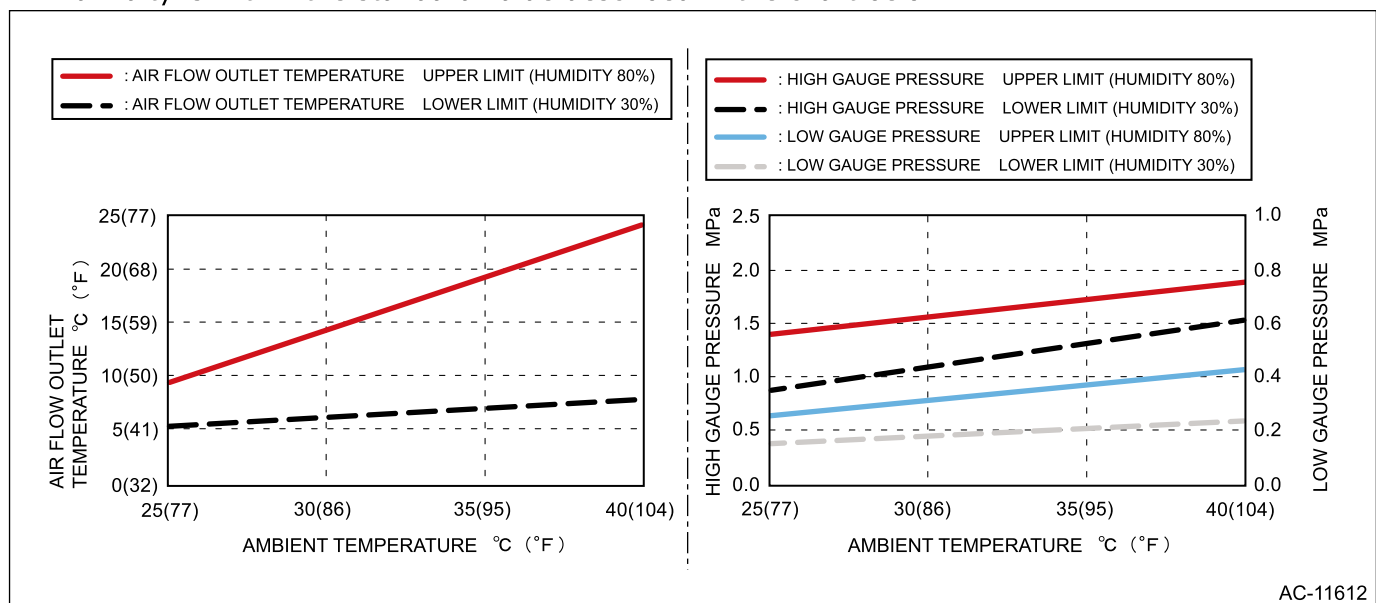







5. Refer to "DIAGNOSIS WITH SYMPTOM" if the inspection result is not within the standard value.  [Ref. to AIR CONDITIONER>Refrigerant Pressure with Manifold Gauge Set>INSPECTION > INSPECTION WITH PRESSURE SYMPTOM.](#)

AIR CONDITIONER > Refrigerant Pressure with Manifold Gauge Set

INSPECTION

1. INSPECTION WITH PRESSURE SYMPTOM

Symptoms	Reference
Pressures on both high and low pressure sides are low	 Ref. to AIR CONDITIONER>Refrigerant Pressure with Manifold Gauge

Symptoms	Reference
	Set>INSPECTION > BOTH HIGH AND LOW PRESSURE SIDES ARE LOW.
Pressures on both high and low pressure sides are high	 Ref. to AIR CONDITIONER>Refrigerant Pressure with Manifold Gauge Set>INSPECTION > BOTH HIGH AND LOW PRESSURE SIDES ARE HIGH.
Pressures on high and low pressure sides are equal, or high-pressure side is low	 Ref. to AIR CONDITIONER>Refrigerant Pressure with Manifold Gauge Set>INSPECTION > HIGH AND LOW PRESSURE SIDES ARE EQUAL, OR HIGH-PRESSURE SIDE IS LOW.
High-pressure side is high	 Ref. to AIR CONDITIONER>Refrigerant Pressure with Manifold Gauge Set>INSPECTION > HIGH-PRESSURE SIDE IS HIGH.
Low-pressure side is low	 Ref. to AIR CONDITIONER>Refrigerant Pressure with Manifold Gauge Set>INSPECTION > LOW-PRESSURE SIDE IS LOW.
Low-pressure side is high	 Ref. to AIR CONDITIONER>Refrigerant Pressure with Manifold Gauge Set>INSPECTION > LOW-PRESSURE SIDE IS HIGH.

2. BOTH HIGH AND LOW PRESSURE SIDES ARE LOW

1. CHECK REFRIGERANT LEAKS.

Check the refrigerant for leaks.  [Ref. to AIR CONDITIONER>Refrigerant Leak Check>INSPECTION.](#)

Note:

When high-pressure side is less than 0.69 MPa: Go to step 2.

Are there refrigerant leaks?

Yes



Repair the refrigerant leaking points.

No

 [Go to 2.](#)

2. FILL PROPER AMOUNT OF REFRIGERANT.

Drain all refrigerant, and refill proper amount of refrigerant.

- Recovery:  [Ref. to AIR CONDITIONER>Refrigerant Recovery Procedure>PROCEDURE.](#)
- Fill:  [Ref. to AIR CONDITIONER>Refrigerant Charging Procedure>PROCEDURE.](#)

Is refrigerant pressure within the standard value?

Yes

Refrigerant pressure is normal.



No

Perform corresponding "INSPECTION WITH PRESSURE SYMPTOM".

3. BOTH HIGH AND LOW PRESSURE SIDES ARE HIGH

1. FILL PROPER AMOUNT OF REFRIGERANT.

Drain all refrigerant, and refill proper amount of refrigerant.

- Recovery:  [Ref. to AIR CONDITIONER>Refrigerant Recovery Procedure>PROCEDURE.](#)
- Fill:  [Ref. to AIR CONDITIONER>Refrigerant Charging Procedure>PROCEDURE.](#)

Is refrigerant pressure within the standard value?

Yes

Refrigerant pressure is normal.

No

Perform corresponding "INSPECTION WITH PRESSURE SYMPTOM".

4. HIGH AND LOW PRESSURE SIDES ARE EQUAL, OR HIGH-PRESSURE SIDE IS LOW

1. CHECK REFRIGERANT LEAKS.

Check the refrigerant for leaks.  [Ref. to AIR CONDITIONER>Refrigerant Leak Check>INSPECTION.](#)

Note:

When high-pressure side is less than 0.69 MPa: Go to step 2.

Are there refrigerant leaks?

Yes



Repair the refrigerant leaking points.

No

 [Go to 2.](#)

2. FILL PROPER AMOUNT OF REFRIGERANT.

Drain all refrigerant, and refill proper amount of refrigerant.

- Recovery:  [Ref. to AIR CONDITIONER>Refrigerant Recovery Procedure>PROCEDURE.](#)
- Fill:  [Ref. to AIR CONDITIONER>Refrigerant Charging Procedure>PROCEDURE.](#)

Is refrigerant pressure within the standard value?

Yes

Refrigerant pressure is normal.

No

Inspect the compressor.  [Ref. to AIR CONDITIONER\(DIAGNOSTICS\)>Diagnostics with Phenomenon>INSPECTION > COLD AIR DOES NOT COME OUT EVEN WHEN THE A/C BUTTON IS PRESSED; THE GLASS CANNOT BE DEFOGGED. \(COMPRESSOR DOES NOT OPERATE.\).](#)

5. HIGH-PRESSURE SIDE IS HIGH

1. CHECK CONDENSER.

Check the condenser.  [Ref. to AIR CONDITIONER>Condenser>INSPECTION.](#)

Is condenser OK?

Yes

 [Go to 2.](#)

No

Clean or replace the condenser.

2. CHECK RADIATOR FAN.

Check the radiator fan system.  [Ref. to COOLING\(H4DOTC\)>Radiator Fan System>INSPECTION.](#)

Is radiator fan system normal?

Yes



 [Go to 3.](#)

No

Repair the radiator fan system or replace the faulty parts.

3. FILL PROPER AMOUNT OF REFRIGERANT.

Drain all refrigerant, and refill proper amount of refrigerant.

- Recovery:  [Ref. to AIR CONDITIONER>Refrigerant Recovery Procedure>PROCEDURE.](#)
- Fill:  [Ref. to AIR CONDITIONER>Refrigerant Charging Procedure>PROCEDURE.](#)

Is refrigerant pressure within the standard value?

Yes

Refrigerant pressure is normal.

No

Check the high-pressure hose and condenser for kinks or clogging, and replace if defective.

6. LOW-PRESSURE SIDE IS LOW

1. CHECK REFRIGERANT LEAKS.

Check the refrigerant for leaks.  [Ref. to AIR CONDITIONER>Refrigerant Leak Check>INSPECTION.](#)

Note:

When high-pressure side is less than 0.69 MPa: Go to step 2.

Are there refrigerant leaks?

Yes

Repair the refrigerant leaking points.

No

 [Go to 2.](#)

2. FILL PROPER AMOUNT OF REFRIGERANT.

Drain all refrigerant, and refill proper amount of refrigerant.

- Recovery: [🔗 Ref. to AIR CONDITIONER>Refrigerant Recovery Procedure>PROCEDURE.](#)
- Fill: [🔗 Ref. to AIR CONDITIONER>Refrigerant Charging Procedure>PROCEDURE.](#)

Is refrigerant pressure within the standard value?

Yes Refrigerant pressure is normal.

No [🔗 Go to 3.](#)

3. REPLACE EXPANSION VALVE.

Replace the expansion valve. [🔗 Ref. to AIR CONDITIONER>Expansion Valve.](#)

Is refrigerant pressure within the standard value?

Yes Refrigerant pressure is normal.

No Inspect the compressor. [🔗 Ref. to AIR CONDITIONER\(DIAGNOSTICS\)>Diagnostics with Phenomenon>INSPECTION > COLD AIR DOES NOT COME OUT EVEN WHEN THE A/C BUTTON IS PRESSED; THE GLASS CANNOT BE DEFOGGED. \(COMPRESSOR DOES NOT OPERATE.\)](#).

7. LOW-PRESSURE SIDE IS HIGH

1. FILL PROPER AMOUNT OF REFRIGERANT.

Drain all refrigerant, and refill proper amount of refrigerant.

- Recovery: [🔗 Ref. to AIR CONDITIONER>Refrigerant Recovery Procedure>PROCEDURE.](#)
- Fill: [🔗 Ref. to AIR CONDITIONER>Refrigerant Charging Procedure>PROCEDURE.](#)

Is refrigerant pressure within the standard value?

Yes Refrigerant pressure is normal.

No [🔗 Go to 2.](#)

2. REPLACE EXPANSION VALVE.

Replace the expansion valve.  [Ref. to AIR CONDITIONER>Expansion Valve.](#)

Is refrigerant pressure within the standard value?

Yes

Refrigerant pressure is normal.

No

Replace the evaporator.  [Ref. to AIR CONDITIONER>Evaporator.](#)

AIR CONDITIONER > Refrigerant Recovery Procedure

PROCEDURE

1. Perform compressor oil return operation.  [Ref. to AIR CONDITIONER>Compressor Oil>OPERATION.](#)
2. Turn the ignition switch to OFF.
3. Attach the manifold gauge set.

Caution:

- During operation, be sure to wear protective goggles and protective gloves.
- Connect the refrigerant recovery system with the manifold gauge set to discharge the refrigerant from the A/C system and recycle the gas.
- When recycling the discharged refrigerant, keep service cans on hand. Because the recovery rate with the recovery system is approx. 90%, service cans are necessary to charge the refrigerant.
- Follow the detailed operation procedure described in the attached operation manual.

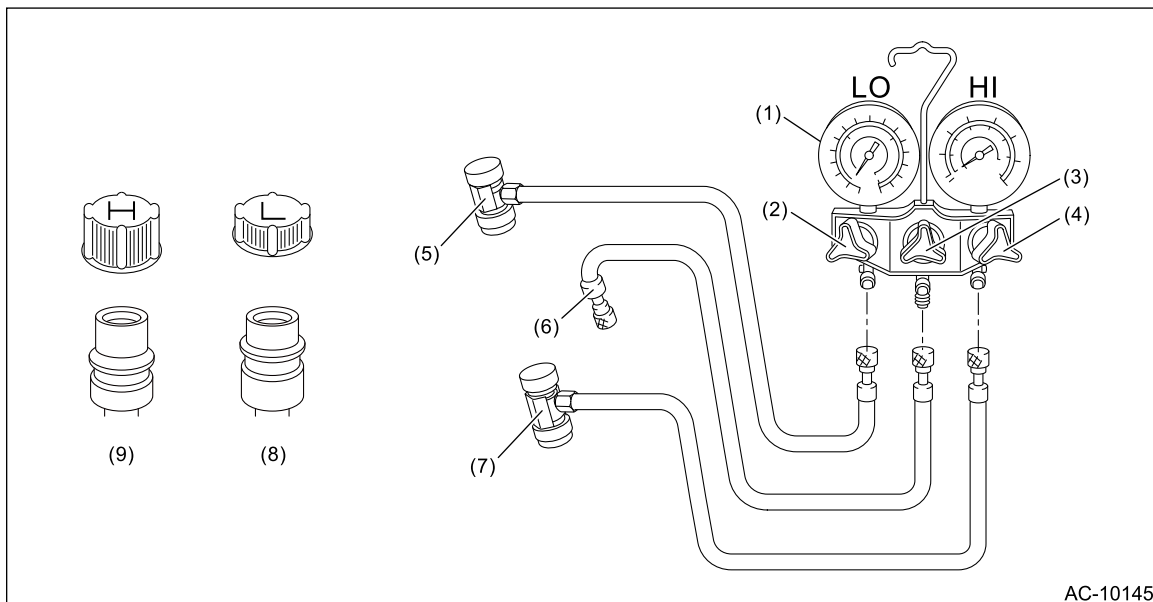

- | | | |
|------------------------|--|--|
| (1) Manifold gauge | (4) High pressure valve | (7) High-pressure hose |
| (2) Low pressure valve | (5) Low-pressure hose | (8) Low-pressure side service port |
| (3) Center valve | (6) Center manifold hose
(vacuum pump and charge) | (9) High-pressure side service
port |

- (1) Check that all valves are fully closed.
- (2) Install the low/high pressure hoses to the service ports on the low/high pressure sides of the vehicle respectively.

Caution:

Confirm that the connections are secure.

- (3) Connect the center manifold hose to the refrigerant recovery system.
4. Follow the operation manual attached to the refrigerant recovery system to collect the refrigerant.

AIR CONDITIONER > Refrigerant Charging Procedure

PROCEDURE

1. Attach the manifold gauge set.

Caution:

- During operation, be sure to wear protective goggles and protective gloves.
- Air in the cycle can cause insufficient air conditioning, and water in the cycle can cause clogging in the cycle (icing) and rust. To remove this air and water content, use a vacuum pump to perform evacuation before filling with refrigerant. By making the inside of the cycle a vacuum, the water content will evaporate even at normal temperatures, and can be removed.
- Follow the detailed operation procedure described in the attached operation manual.

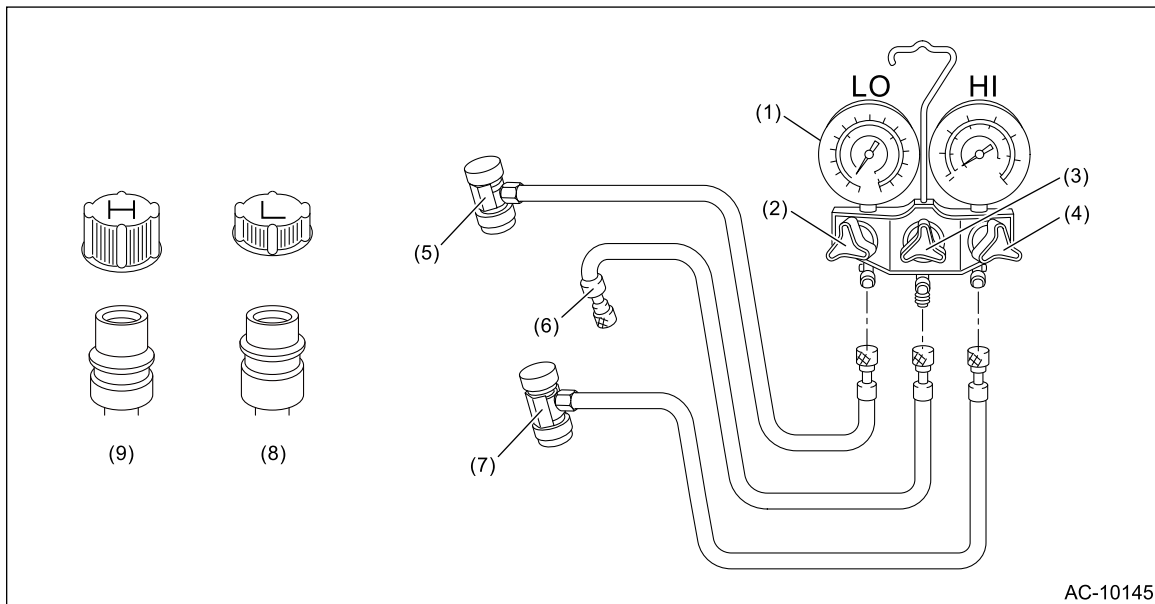

- | | | |
|------------------------|--|--|
| (1) Manifold gauge | (4) High pressure valve | (7) High-pressure hose |
| (2) Low pressure valve | (5) Low-pressure hose | (8) Low-pressure side service port |
| (3) Center valve | (6) Center manifold hose
(vacuum pump and charge) | (9) High-pressure side service
port |

(1) Check that all valves are fully closed.

(2) Install the low/high pressure hoses to the service ports on the low/high pressure sides of the vehicle respectively.

Caution:

Confirm that the connections are secure.

(3) Connect the center manifold hose of the manifold gauge to the vacuum pump.

2. Perform evacuation.

Caution:

Make sure to perform evacuation using a vacuum pump.

(1) Open the low-pressure side valve, high-pressure side valve and center valve.

(2) Operate the vacuum pump.

- (3) Perform evacuation for 5 minutes or more, and when the low pressure gauge needle reaches -0.1 MPa (-1 kgf/cm², -14 psi), close the center manifold hose valve, and stop the vacuum pump.
- (4) Leave alone for 5 to 10 minutes after closing the low pressure valve and high pressure valve, and check whether there is any change in the low pressure gauge needle indication.
If the needle position changes, this indicates a leak. Check the pipe and hose connections, and repair the location with the problem.
After repair, retry charging the refrigerant from the step (1).
- (5) If there is no leakage, continue evacuation for additional 20 – 30 minutes, close all valves and then stop the vacuum pump.

3. Charge refrigerant.

Preparation items:

Refrigerant:  [Ref. to AIR CONDITIONER>General Description>SPECIFICATION > REFRIGERANT.](#)

- (1) Follow the can tap operation manual to attach it to the refrigerant can.
- (2) Disconnect the center manifold hose from the vacuum pump, and connect the hose to the tap valve.

Note:

When 13.6 kg (30 lb) refrigerant container (1) is used, measure the amount of refrigerant with a refrigerant charging scale (2), and connect with the center manifold hose.

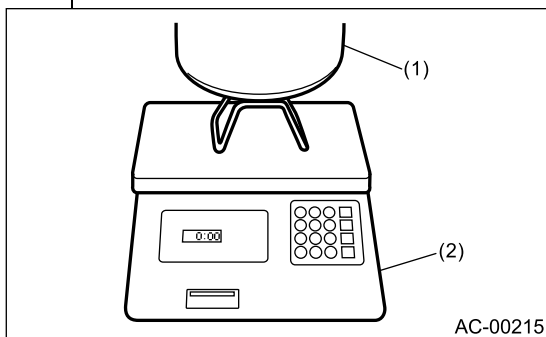

- (3) Open the tap valve of the supply container (refrigerant can or refrigerant container).
- (4) Loosen the center manifold hose connection on the manifold gauge for a few seconds (if there is a purge valve on the manifold gauge, push this instead) to allow the air in the center manifold hose to be bled by the refrigerant pressure.
- (5) Open the low pressure valve and high pressure valve of the manifold gauge to fill with refrigerant.

Note:

If the supply container is empty, close all manifold gauge valves and the tap valve of the supply container, and replace the empty supply container with a new one. After replacing with a new supply container, perform air purge, and resume the filling operation.

- (6) If the low pressure gauge indicates approximately 0.2 MPa (2 kgf/cm², 29 psi) or refrigerant filling efficiency drops, close the low pressure and high pressure valves.
- (7) Check that the low pressure valve and high pressure valve are closed, turn off the A/C switch and start the engine.

Caution:

- **When filling operation is performed with the engine running, do not open the high pressure valve. Always fill from the low pressure valve.**
- **Do not start the engine before charging refrigerant.**

(8) To prevent damage to the compressor, push the A/C switch ON-OFF quickly a few times.

(9) Set the vehicle to the following conditions.

Item	Condition
Engine speed	1,500 r/min
A/C switch	ON
Temperature setting	LO (MAX COOL)
Fan speed	HI (MAX)
FRESH/RECIRC position	RECIRC
Air flow control position	VENT
Window	OPEN

(10) Open the low pressure valve, check the refrigerant pressure with a manifold gauge and fill with refrigerant up to the specified amount.  [Ref. to AIR CONDITIONER>Refrigerant Pressure with Manifold Gauge Set>INSPECTION > INSPECTION WITH PRESSURE SYMPTOM.](#)

4. Using an electronic leak detector (leak tester), check for refrigerant leaks in the system.  [Ref. to AIR CONDITIONER>Refrigerant Leak Check>INSPECTION.](#)
5. After filling with refrigerant, close all valves and remove the manifold gauge set.
6. Attach cap to the service port of the low pressure side and high pressure side.

AIR CONDITIONER > Refrigerant Leak Check

INSPECTION

1. Check the refrigerant gas pressure.  [Ref. to AIR CONDITIONER>Refrigerant Pressure with Manifold Gauge Set>PROCEDURE > CHECK REFRIGERANT GAS PRESSURE.](#)
2. Stop the engine.
3. Using an electronic leak detector (leak tester), start the leak test.

Items	Condition	Corrective action
Pipe	Check the connection between pressure sensor and pipe.	Replace the pressure sensor.
	Check the connection between pipe and condenser.	Check the O-ring at connection and tightening torque. If necessary, replace each part.
Condenser	Check the welded part of condenser and core.	Replace the condenser.
Hose (high-pressure)	Check the connection between hose (high-pressure) and compressor.	Check the O-ring at connection and tightening torque. If necessary, replace each part.
	Check the connection between hose (high-pressure) and condenser.	Check the O-ring at connection and tightening torque. If necessary, replace each part.
	Check the connection between pressure sensor and hose (high pressure).	Replace the pressure sensor.
	Check the rubber part of the flexible hose and pipe seam.	Replace the hose (high pressure).
	Caution: Carefully check the external surface of flexible hoses and pipes at approx. 25 mm (0.98 in) per second.	
Check the valve and cap in the service port.	Check the rubber seal of the valve and cap. If necessary, replace valve or cap.	
Compressor	Check the compressor pulley and vicinity of shaft seal.	Replace the compressor.
	Caution: Some shaft seals will show a slight amount of leakage, about 3 g (0.1 oz) per year. This is not a problem.	
Hose (low-pressure)	Check the connection between hose (low pressure) and expansion valve.	Check the O-ring at connection and tightening torque. If necessary, replace each part.

Items	Condition	Corrective action
	Check the connection between hose (low pressure) and compressor.	Check the O-ring at connection and tightening torque. If necessary, replace each part.
	Check the rubber part of the flexible hose and pipe seam. Caution: Carefully check the external surface of flexible hoses and pipes at approx. 25 mm (0.98 in) per second.	Replace the hose (low pressure).
	Check the valve and cap in the service port.	Check the rubber seal of the valve and cap. If necessary, replace valve or cap.
	Check the connection between hose (low pressure) and pipe.	Check the O-ring and lock spring at the connection. If necessary, replace each part.
Evaporator	Remove the drain hose from the heater case, and check the end part for 10 seconds or more.	Replace the evaporator.
	Check the air vent grille. Note: Turn the ignition switch to ON, and run the blower at high speed for approx. 1 minute. Stop the blower to check the air vent grille on the instrument panel. While moving the tester closer to the grille, run the blower for 1 or 2 seconds, then stop it. Check the grille at that position for at least 10 seconds.	Replace the evaporator.

AIR CONDITIONER > Relay and Fuse

LOCATION

For the location, refer to "FUSE AND RELAY" in the wiring diagram.  [Ref. to WIRING SYSTEM>Fuse And Relay>LOCATION.](#)

Note:

For details of relay and fuse, refer to "DC POWER SUPPLY CIRCUIT".  [Ref. to WIRING SYSTEM>Power Supply Circuit>WIRING DIAGRAM.](#)

AIR CONDITIONER > Relay and Fuse

INSPECTION

1. CHECK FUSE

1. Remove the fuse and inspect visually.
2. If the fuse is blown out, replace the fuse.

Note:

If the fuse is blown again, check the system wiring harness.

2. CHECK RELAY

1. Measure the resistance between relay terminals.

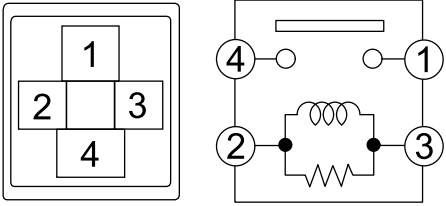
Terminal No.	Inspection conditions	Standard	Circuit
1 - 4	Always	1 M Ω or more	 <p>The diagram shows a relay with four terminals labeled 1, 2, 3, and 4. Terminal 1 is at the top, 2 on the left, 3 on the right, and 4 at the bottom. To the right is a circuit diagram showing terminal 1 connected to a fuse, terminal 4 connected to the other side of the fuse, terminal 2 connected to a coil, and terminal 3 connected to a resistor.</p>
	Apply battery voltage between terminals 2 and 3.	Less than 1 Ω	

AC-02796

2. Replace the relay if the inspection result is not within the standard value.

AIR CONDITIONER > Compressor Oil

OPERATION

Note:

Before making repairs, perform the oil return operation to return the compressor oil in circulation with the refrigerant to the compressor.

1. Start the engine.
2. Set the vehicle to the following conditions.

Item	Condition
Engine speed	1,500 r/min
A/C switch	ON
Temperature setting	LO (MAX COOL)
FRESH/RECIRC position	RECIRC
Fan speed	HI (MAX)

3. Leave in this condition for 10 minutes.

AIR CONDITIONER > Compressor Oil

ADJUSTMENT

Note:

Since the hygroscopicity of compressor oil is high, perform this series of works quickly.

Preparation items:

Compressor oil:  Ref. to AIR CONDITIONER>General Description>SPECIFICATION > A/C SYSTEM.



Compressor oil capacity:

Refer to "SPECIFICATION" for compressor oil capacity.  Ref. to AIR CONDITIONER>General Description>SPECIFICATION > A/C SYSTEM.

- If a component has been replaced, add an appropriate amount of compressor oil (same as the amount of remaining oil in removed component).
- When replacing the compressor, the new compressor will already have the specified amount of oil in it. Adjust the oil amount (so that the amount remains the same as that of the removed compressor) and install the new compressor.

AIR CONDITIONER > Blower Motor

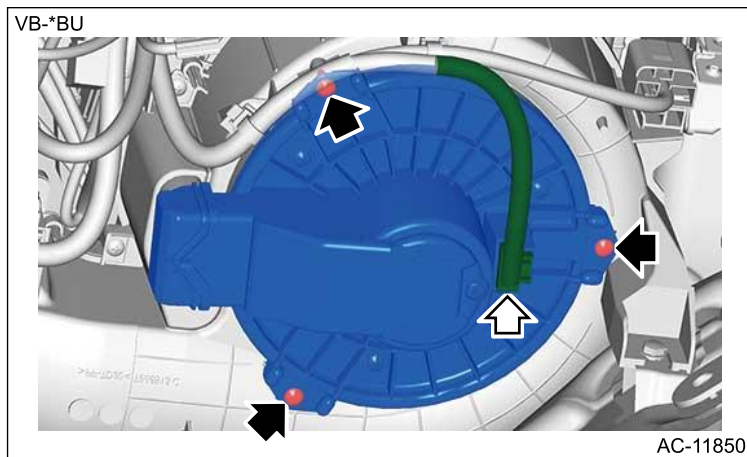

REMOVAL

1. Disconnect the ground terminal from battery sensor.  [Ref. to REPAIR CONTENTS>NOTE > BATTERY.](#)
2. Remove the pocket COMPL and the panel instrument passenger.  [Ref. to EXTERIOR/INTERIOR TRIM>Glove Box>REMOVAL > BACK PANEL.](#)
3. Remove the duct foot passenger.  [Ref. to AIR CONDITIONER>Air Vent Duct>REMOVAL > FOOT DUCT.](#)
4. Remove the blower motor assembly.
 - (1) Disconnect the connector.
 - (2) Remove the screws and detach the blower motor assembly.



AIR CONDITIONER > Blower Motor

INSTALLATION

1. Install the blower motor assembly and connect the connector.
2. Install the duct foot passenger.  [Ref. to AIR CONDITIONER>Air Vent Duct>INSTALLATION > FOOT DUCT.](#)
3. Install the panel instrument passenger and pocket COMPL.  [Ref. to EXTERIOR/INTERIOR TRIM>Glove Box>INSTALLATION > BACK PANEL.](#)
4. Connect the ground terminal to battery sensor.  [Ref. to REPAIR CONTENTS>NOTE > BATTERY.](#)

AIR CONDITIONER > Blower Motor

INSPECTION

1. Check the motor operation when battery voltage is applied between the connector terminals.

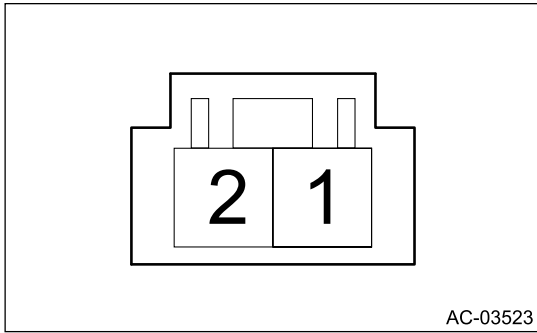



Terminal No.	Inspection conditions	Specification
2 (+) – 1 (-)	Apply battery voltage.	Rotation

2. If the blower motor does not operate normally, replace the blower motor assembly.

AIR CONDITIONER > Power Transistor

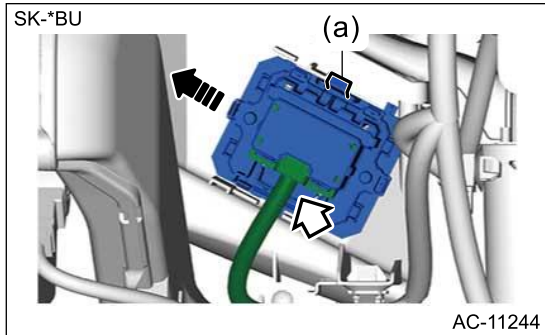

REMOVAL

1. Disconnect the ground terminal from battery sensor.  [Ref. to REPAIR CONTENTS>NOTE > BATTERY.](#)
2. Remove the pocket COMPL and the panel instrument passenger.  [Ref. to EXTERIOR/INTERIOR TRIM>Glove Box>REMOVAL > BACK PANEL.](#)
3. Remove the power transistor.
 - (1) Disconnect the connector.
 - (2) Remove the power transistor by pressing the claw part (a) and sliding it.



AIR CONDITIONER > Power Transistor

INSTALLATION

1. Install the power transistor, and connect the connector.
2. Install the panel instrument passenger and pocket COMPL.  [Ref. to EXTERIOR/INTERIOR TRIM>Glove Box>INSTALLATION > BACK PANEL.](#)
3. Connect the ground terminal to battery sensor.  [Ref. to REPAIR CONTENTS>NOTE > BATTERY.](#)







AIR CONDITIONER > Heater Core

REMOVAL



Caution:

- Before handling the airbag system components, refer to "CAUTION" of "General Description" in "AIRBAG SYSTEM".  [Ref. to AIRBAG SYSTEM>General Description>CAUTION.](#)
- Be careful not to damage the airbag system harness when servicing the instrument panel. Damage may cause the system to malfunction.

1. Using the refrigerant recovery system, discharge refrigerant.  [Ref. to AIR CONDITIONER>Refrigerant Recovery Procedure>PROCEDURE.](#)
2. Disconnect the ground terminal from the battery sensor, and wait for at least 60 seconds before starting work.  [Ref. to REPAIR CONTENTS>NOTE > BATTERY.](#)
3. Drain the coolant from the radiator.  [Ref. to COOLING\(H4DOTC\)>Engine Coolant>REPLACEMENT > DRAINING OF ENGINE COOLANT.](#)
4. Remove the instrument panel assembly and the beam steering COMPL.  [Ref. to EXTERIOR/INTERIOR TRIM>Instrument Panel Assembly>REMOVAL.](#)
5. Remove the heater and cooling unit assembly.  [Ref. to AIR CONDITIONER>Heater and Cooling Unit>REMOVAL.](#)
6. Remove the motor actuator mode and the bracket actuator mode.  [Ref. to AIR CONDITIONER>Mode Door Actuator>REMOVAL.](#)
7. Remove the screws and detach the cover heater pipe.

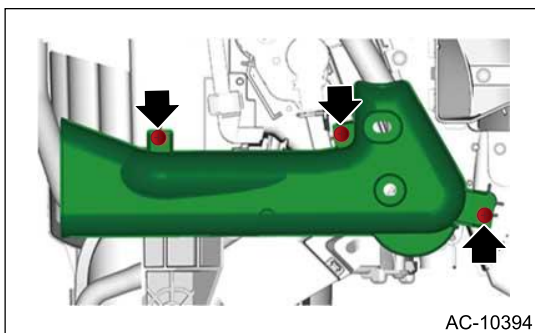

8. Remove the gasket heater core pipe.

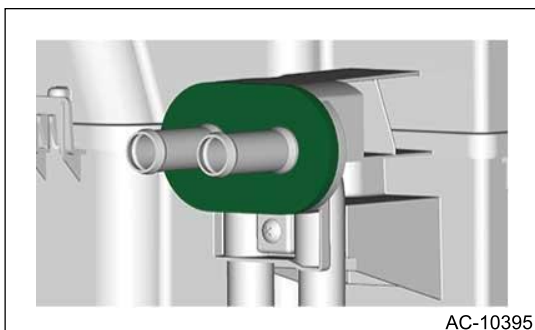

9. Remove the screw and detach the clamp heater core pipe.

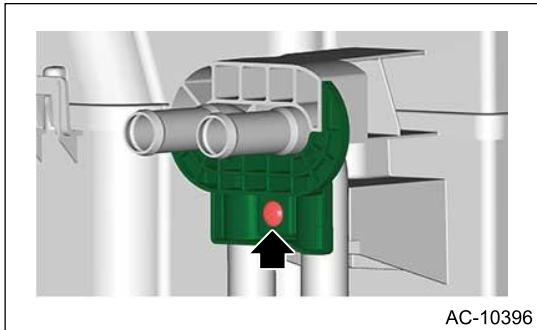

10. Remove the clamp pipe, and then remove the pipe heater core.

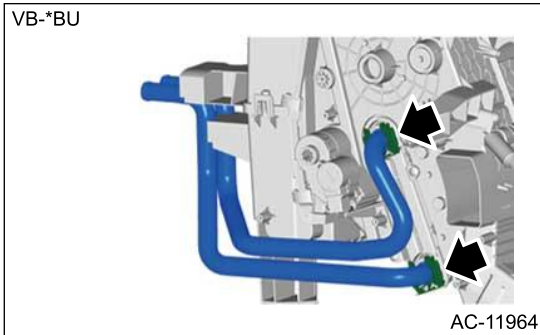

11. Remove the plate heater core.

(1) Remove the screws.

(2) Release the claws and remove the plate heater core.

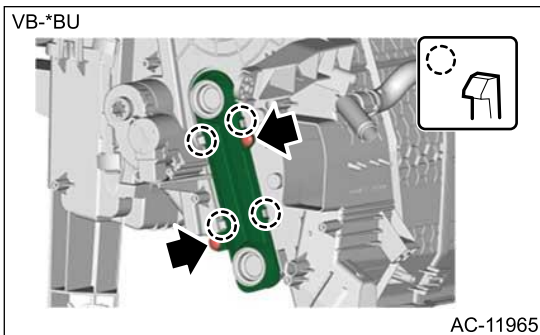

12. Remove the heater core as shown in the figure.

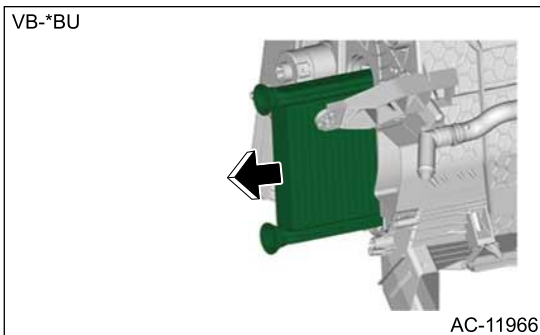





AIR CONDITIONER > Heater Core

INSTALLATION

Caution:



- **Do not start the engine before charging refrigerant.**
- **If the engine is started with no refrigerant charge, replace the compressor assembly.**
- **Replace O-rings and clamp pipes with new parts and install securely.**
- **Before handling the airbag system components, refer to "CAUTION" of "General Description" in "AIRBAG SYSTEM".**  [Ref. to AIRBAG SYSTEM>General Description>CAUTION.](#)

- 1.** Attach the heater core.
- 2.** Attach the plate heater core.
- 3.** Attach the pipe heater core.
- 4.** Install the clamp heater core pipe.
- 5.** Install the gasket heater core pipe.
- 6.** Install the cover heater pipe.
- 7.** Install the bracket actuator mode and the motor actuator mode.  [Ref. to AIR CONDITIONER>Mode Door Actuator>INSTALLATION.](#)
- 8.** Install the heater and cooling unit assembly.  [Ref. to AIR CONDITIONER>Heater and Cooling Unit>INSTALLATION.](#)
- 9.** Install the beam steering COMPL and the instrument panel assembly.  [Ref. to EXTERIOR/INTERIOR TRIM>Instrument Panel Assembly>INSTALLATION.](#)
- 10.** Connect the ground terminal to battery sensor.  [Ref. to REPAIR CONTENTS>NOTE > BATTERY.](#)
- 11.** Fill engine coolant.  [Ref. to COOLING\(H4DOTC\)>Engine Coolant>REPLACEMENT > FILLING OF ENGINE COOLANT.](#)

AIR CONDITIONER > Compressor

REMOVAL



1. Using the refrigerant recovery system, discharge refrigerant.  [Ref. to AIR CONDITIONER>Refrigerant Recovery Procedure>PROCEDURE.](#)
2. Disconnect the ground terminal from battery sensor.  [Ref. to REPAIR CONTENTS>NOTE > BATTERY.](#)
3. Remove the V-belts.  [Ref. to MECHANICAL\(H4DOTC\)>V-belt>REMOVAL.](#)
4. Disconnect the hose pressure discharge and the hose pressure suction.
 - (1) Remove the bolts and disconnect the hose pressure discharge.
 - (2) Remove the bolts and detach the hose pressure suction.

Caution:

Seal the disconnected hose and engaging part of compressor with a plug or vinyl tape to prevent foreign matter from entering.

VB-HBU

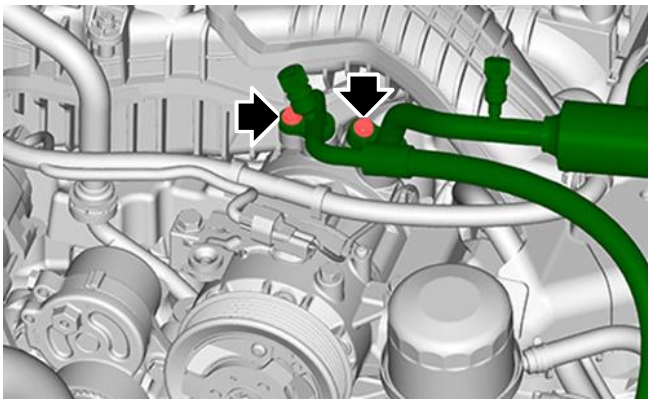

AC-11851

5. Disconnect the compressor assembly connector and detach the harness clip.

VB-HBU

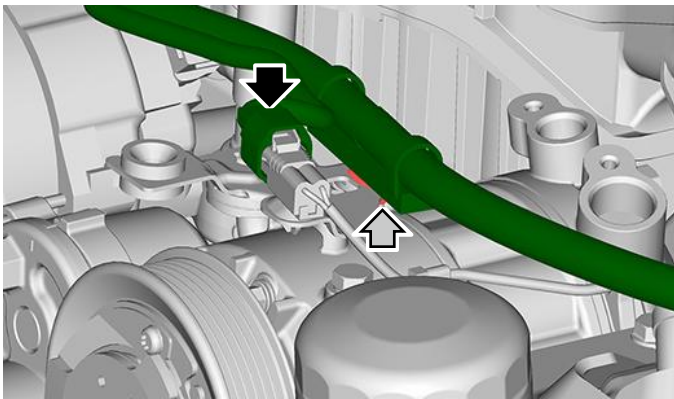

AC-11852

6. Remove the bolts and remove the fuel pipe protector No. 1.

VB-HBU

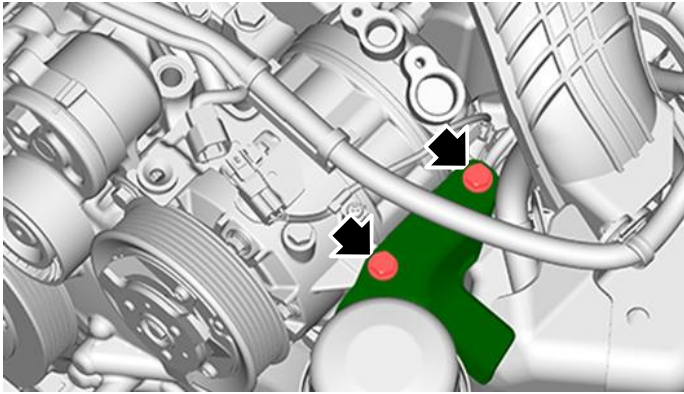

AC-11853

7. Remove the bolts and remove the compressor assembly.

VB-HBU

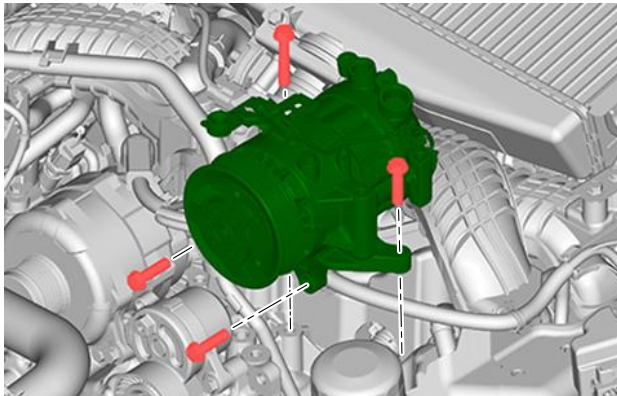

AC-11854

8. Remove the bolt and connector clip, and remove the bracket V-belt cover.

Note:

Perform this procedure only when required.

VB-HBU

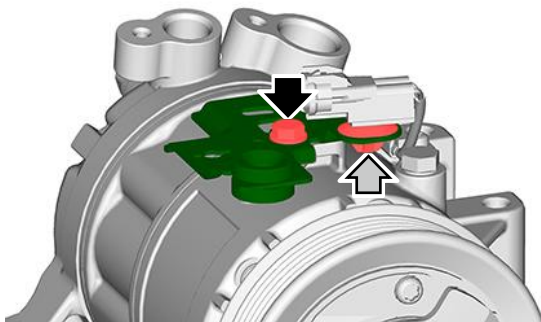

AC-11855

AIR CONDITIONER > Compressor

INSTALLATION

Caution:

- **Do not start the engine before charging refrigerant.**
 - **If the engine is started with no refrigerant charge, replace the compressor assembly.**
 - **Replace the O-rings with new parts, and then apply compressor oil to install completely.**
 - **After replacing the compressor assembly, adjust the amount of the compressor oil.** 
- Ref. to AIR CONDITIONER>Compressor Oil>ADJUSTMENT.**

- 1.** Install the bracket V-belt cover.

Tightening torque:

6.4 N·m (0.7 kgf-m, 4.7 ft-lb)

- 2.** Install the compressor assembly.

(1) Temporarily install the compressor assembly.

(2) Tighten the bolts in the numerical order as shown in the figure.

Tightening torque:

36 N·m (3.7 kgf-m, 26.6 ft-lb)

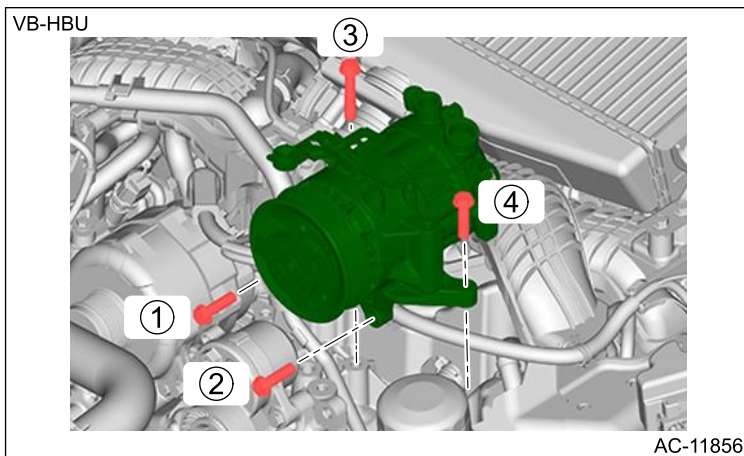

- 3.** Install the fuel pipe protector No. 1.

Tightening torque:

25 N·m (2.5 kgf-m, 18.4 ft-lb)

- 4.** Connect the compressor assembly connector and install the harness clip.

- 5.** Install the hose pressure suction and the hose pressure discharge.

Tightening torque:

10 N·m (1 kgf-m, 7.4 ft-lb)

- 6.** Install the V-belts.  [Ref. to MECHANICAL\(H4DOTC\)>V-belt>INSTALLATION.](#)

- 7.** Connect the ground terminal to battery sensor.  [Ref. to REPAIR CONTENTS>NOTE > BATTERY.](#)



- 8.** Charge refrigerant.  [Ref. to AIR CONDITIONER>Refrigerant Charging Procedure>PROCEDURE.](#)

- 9.** If replacing the compressor assembly with a new part, perform a break-in operation according to the following steps.

Caution:



- **Do not increase the engine speed to and above 4,000 r/min unless the break-in operation finishes.**
- **If the engine may have been started with no refrigerant charge, check for any diagnosis code (DTC) using Subaru Select Monitor. If the code B14A8 (REFRIGERANT NOT SEALED DRIVE ERROR) is output, replace the compressor assembly.**

- (1) Check that the connector is locked securely.

- (2) Reset the air conditioner CM. (Disconnect and then connect the connector)
- (3) Install the delivery mode fuse.  [Ref. to PRE-DELIVERY INSPECTION>PRE-DELIVERY INSPECTION \(PDI\) PROCEDURE > DELIVERY MODE.](#)
- (4) Using Subaru Select Monitor, perform [Variable compressor break-in drive] in the [Maintenance support] of [Air Conditioner].  [Ref. to COMMON \(DIAGNOSTICS\)>Work Support.](#)
- (5) According to the procedure, display [Break-in variable compressor drive, finish status].
- (6) Start and idle the engine at or below 1,800 r/min. (The compressor operation is automatically changed to the break-in drive mode.)
- (7) When [Break-in variable compressor drive, finish status] changes from [incomplete] to [ON], stop the engine.
- (8) Remove the delivery mode fuse.
- (9) The break-in operation finishes.

AIR CONDITIONER > Control Unit

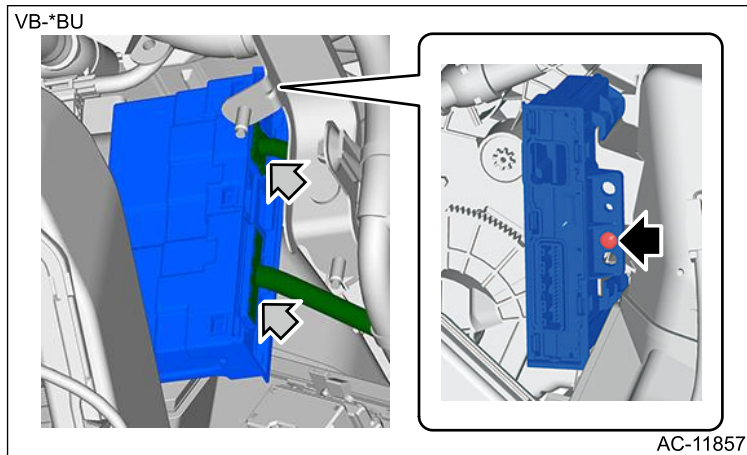

REMOVAL

1. Disconnect the ground terminal from battery sensor.  [Ref. to REPAIR CONTENTS>NOTE > BATTERY.](#)
2. Remove the pocket COMPL and the panel instrument passenger.  [Ref. to EXTERIOR/INTERIOR TRIM>Glove Box>REMOVAL > BACK PANEL.](#)
3. Remove the air conditioner CM.
 - (1) Disconnect the connector.
 - (2) Remove the screws, and then slide the air conditioner CM along the rail to remove it.



AIR CONDITIONER > Control Unit



INSTALLATION

1. Install the air conditioner CM.
 - (1) Slide the air conditioner CM along the rail.
 - (2) Tighten the screws.
 - (3) Connect the connector.
2. Install the panel instrument passenger and pocket COMPL.  [Ref. to EXTERIOR/INTERIOR TRIM>Glove Box>INSTALLATION > BACK PANEL.](#)
3. Connect the ground terminal to battery sensor.  [Ref. to REPAIR CONTENTS>NOTE > BATTERY.](#)

AIR CONDITIONER > Condenser

REMOVAL



1. Using the refrigerant recovery system, discharge refrigerant.  [Ref. to AIR CONDITIONER>Refrigerant Recovery Procedure>PROCEDURE.](#)
2. Remove the air intake duct.  [Ref. to INTAKE \(INDUCTION\)\(H4DOTC\)>Air Intake Duct>REMOVAL.](#)
3. Remove the clips, and remove the cover UPR front.

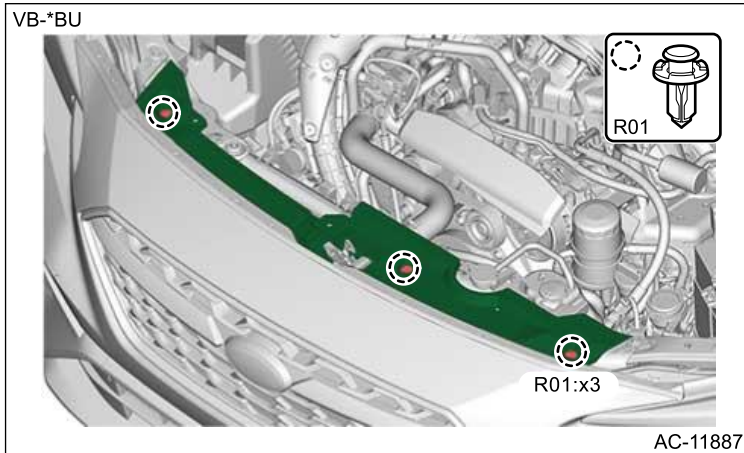

4. Remove the reservoir tank.  [Ref. to COOLING\(H4DOTC\)>Reservoir Tank>REMOVAL.](#)
5. Remove the bolts and remove the radiator upper bracket.

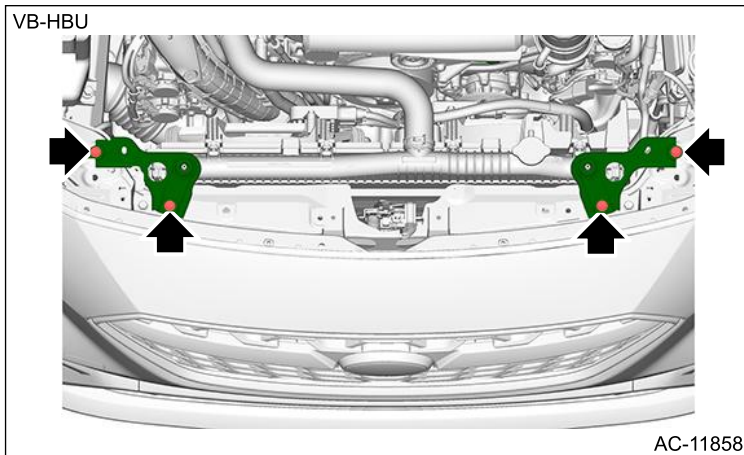

6. Remove the bumper face front. (Model with CVTF cooler (air cool))  [Ref. to EXTERIOR/INTERIOR TRIM>Front Bumper>REMOVAL.](#)
7. Detach the hose pressure discharge and the pipe evaporator cooling.
 - (1) Remove the bolts and disconnect the hose pressure discharge.
 - (2) Remove the bolt, and detach the pipe evaporator cooling.

Caution:

Seal the disconnected hose, pipe and engaging part of condenser assembly with a plug or vinyl tape to prevent foreign matter from entering.

Note:

Push the condenser assembly and radiator toward the engine side to secure working space.

VBN*AJ

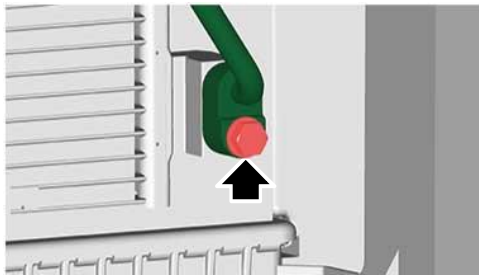
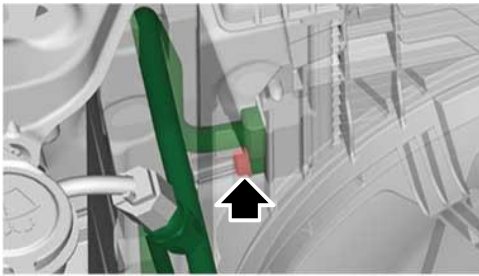

AC-11492

8. Remove the bolts and remove the condenser assembly.

Caution:

- **Push the radiator to the engine side, and pull it out through the space between the radiator and the radiator panel.**
- **Be careful not to damage the condenser and radiator fin.**
- **If a damaged fin is found, repair it using a thin screwdriver.**

Note:

The illustration shows the model with CVTF cooler (air cool).

VB-HBU

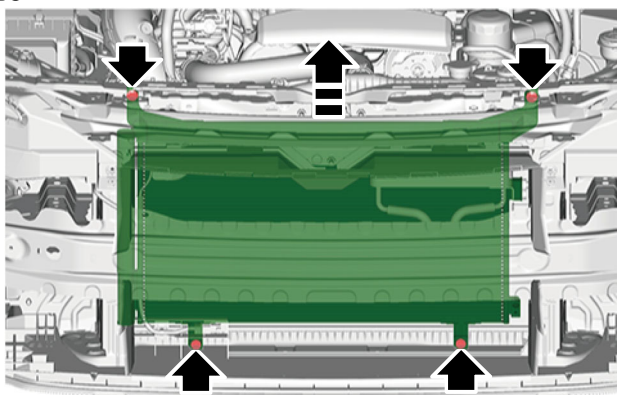

AC-11859

AIR CONDITIONER > Condenser

INSTALLATION

Caution:

- Do not start the engine before charging refrigerant.
- If the engine is started with no refrigerant charge, replace the compressor assembly.
- Replace the O-rings with new parts, and then apply compressor oil to install completely.
- If the condenser assembly has been replaced, add an appropriate amount of compressor oil to the compressor.  [Ref. to AIR CONDITIONER>Compressor Oil>ADJUSTMENT.](#)

1. Install the condenser assembly.

(1) Install the bolts at the upper side of the condenser assembly.

Tightening torque:

7.5 N·m (0.8 kgf·m, 5.5 ft-lb)

(2) Install the bolts at the bottom of the condenser assembly using the ST.

Preparation tool:

ST: Special tool condenser (73099SG000)

Tightening torque:

Calculation formula

$$T = 7.5 \text{ N}\cdot\text{m} (0.8 \text{ kgf}\cdot\text{m}, 5.5 \text{ ft}\cdot\text{lb}) \times L / (100 \text{ mm} (3.94 \text{ in}) + L)$$

T: Tightening torque

L: Effective length of torque wrench

Note:

If the effective length of the torque wrench used is unknown, consult the manufacturer of the torque wrench.

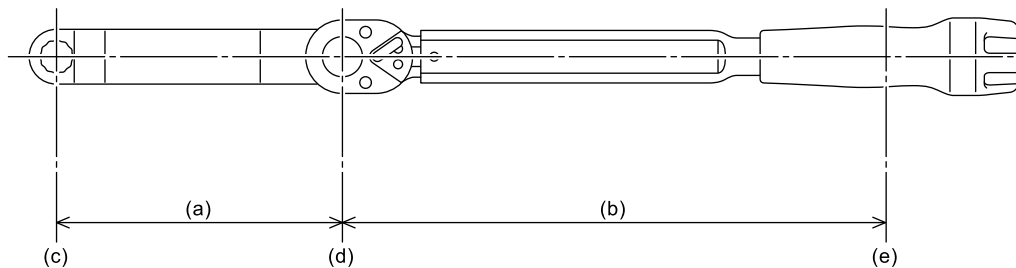

CO-03173

(a) Effective length of the ST (100 mm (3.94 in))

(b) Effective length of the torque wrench (L)

(c) Center of drive square of the ST

(d) Center of drive square of the torque wrench

(e) Center of the position where a force is applied by hand

Note:

The illustration shows the model with CVTF cooler (air cool).



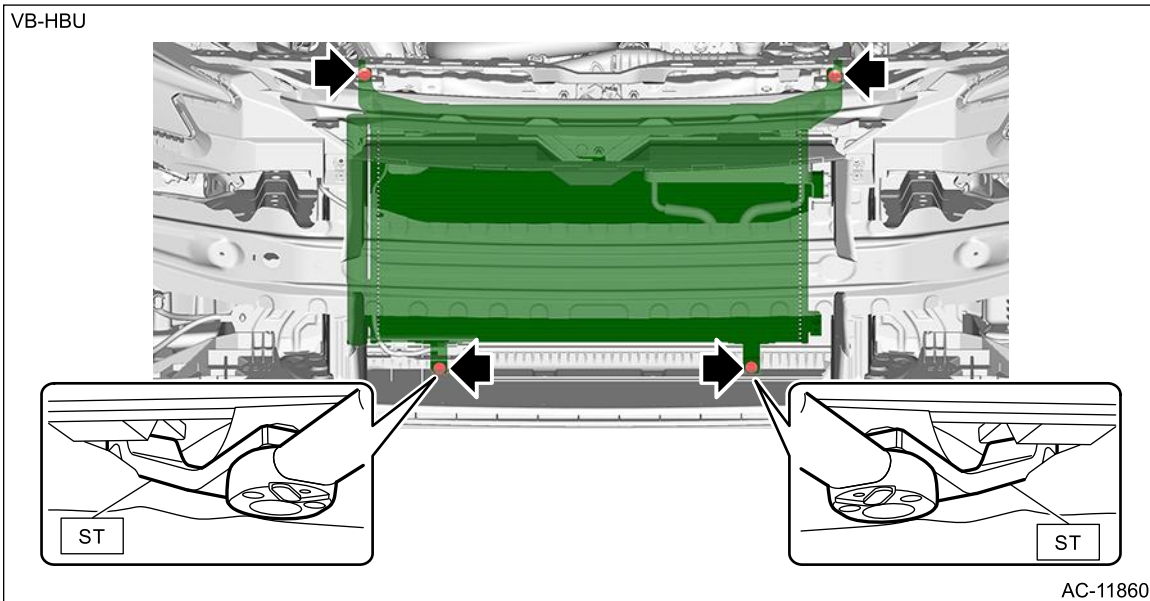

VB-HBU



2. Install the hose pressure discharge and the pipe evaporator cooling.

Tightening torque:

7.5 N·m (0.8 kgf-m, 5.5 ft-lb)

3. Install the bumper face front. (Model with CVTF cooler (air cool))  [Ref. to EXTERIOR/INTERIOR TRIM>Front Bumper>INSTALLATION.](#)
4. Install the radiator upper bracket.
Tightening torque:
27 N·m (2.8 kgf-m, 19.9 ft-lb)
5. Install the reservoir tank.  [Ref. to COOLING\(H4DOTC\)>Reservoir Tank>INSTALLATION.](#)
6. Install the cover UPR front.
7. Install the air intake duct.  [Ref. to INTAKE \(INDUCTION\)\(H4DOTC\)>Air Intake Duct>INSTALLATION.](#)
8. Connect the ground terminal to battery sensor.  [Ref. to REPAIR CONTENTS>NOTE > BATTERY.](#)
9. Charge refrigerant.  [Ref. to AIR CONDITIONER>Refrigerant Charging Procedure>PROCEDURE.](#)

AIR CONDITIONER > Condenser

INSPECTION

1. Check to see that the condenser fins are not clogged with debris or insects. Blow with compressed air or flush fins with water as needed.
2. If any oil leak is found, replace the condenser assembly.





AIR CONDITIONER > Heater and Cooling Unit

REMOVAL





Caution:

- **Before handling the airbag system components, refer to "CAUTION" of "General Description" in "AIRBAG SYSTEM".**  [Ref. to AIRBAG SYSTEM>General Description>CAUTION.](#)
- **Be careful not to damage the airbag system harness when servicing the instrument panel. Damage may cause the system to malfunction.**
- **Seal the disconnected hose, pipe and engaging part of expansion valve with a plug or vinyl tape to prevent foreign matter from entering.**

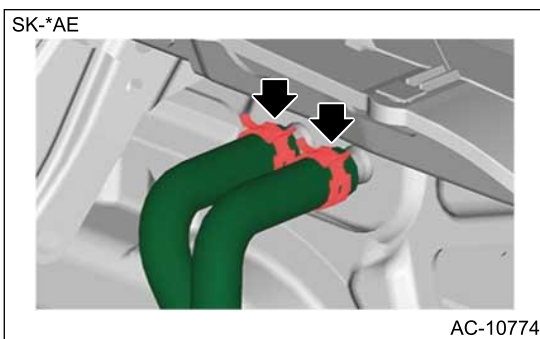
1. Using the refrigerant recovery system, discharge refrigerant.  [Ref. to AIR CONDITIONER>Refrigerant Recovery Procedure>PROCEDURE.](#)
2. Disconnect the ground terminal from the battery sensor, and wait for at least 60 seconds before starting work.  [Ref. to REPAIR CONTENTS>NOTE > BATTERY.](#)
3. Drain the coolant from the radiator.  [Ref. to COOLING\(H4DOTC\)>Engine Coolant>REPLACEMENT > DRAINING OF ENGINE COOLANT.](#)
4. Remove the intercooler.  [Ref. to INTAKE \(INDUCTION\)\(H4DOTC\)>Intercooler>REMOVAL.](#)
5. Disconnect the hose pressure suction on the expansion valve side.  [Ref. to AIR CONDITIONER>Hose and Pipe>REMOVAL.](#)
6. Disconnect the hose heater outlet and the hose heater inlet.
 - (1) Put alignment marks to hoses, heat hose clips, etc.
 - (2) Loosen the heater hose clip, and detach the hose heater outlet.
 - (3) Loosen the heater hose clip, and detach the hose heater inlet.



7. Remove the instrument panel assembly and the beam steering COMPL.  [Ref. to EXTERIOR/INTERIOR TRIM>Instrument Panel Assembly>REMOVAL.](#)
8. Remove the duct foot.  [Ref. to AIR CONDITIONER>Air Vent Duct>REMOVAL > FOOT DUCT.](#)
9. Remove the heater and cooling unit assembly.
 - (1) Remove the hose drain.
 - (2) Remove the bolt and remove the heater and cooling unit assembly.

VB-*BU

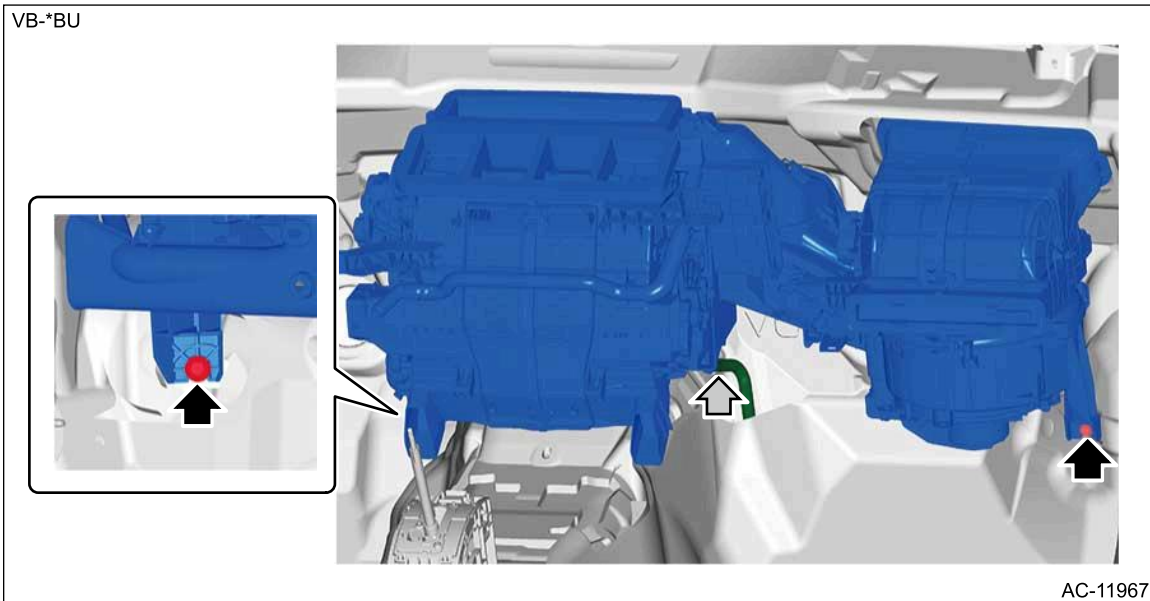

AC-11967

AIR CONDITIONER > Heater and Cooling Unit

INSTALLATION







Caution:

- Do not start the engine before charging refrigerant.
- If the engine is started with no refrigerant charge, replace the compressor assembly.
- Replace the O-rings with new parts, and then apply compressor oil to install completely.
- Before handling the airbag system components, refer to "CAUTION" of "General Description" in "AIRBAG SYSTEM".  [Ref. to AIRBAG SYSTEM>General Description>CAUTION.](#)

1. Install the heater and cooling unit assembly.

Tightening torque:

7.5 N·m (0.8 kgf-m, 5.5 ft-lb)

2. Install the hose drain.
3. Install the duct foot.  [Ref. to AIR CONDITIONER>Air Vent Duct>INSTALLATION > FOOT DUCT.](#)
4. Install the beam steering COMPL and the instrument panel assembly.  [Ref. to EXTERIOR/INTERIOR TRIM>Instrument Panel Assembly>INSTALLATION.](#)
5. Connect the hose heater outlet and the hose heater inlet.
6. Connect the hose pressure suction on the expansion valve side.  [Ref. to AIR CONDITIONER>Hose and Pipe>INSTALLATION.](#)
7. Install the intercooler.  [Ref. to INTAKE \(INDUCTION\)\(H4DOTC\)>Intercooler>INSTALLATION.](#)
8. Connect the ground terminal to battery sensor.  [Ref. to REPAIR CONTENTS>NOTE > BATTERY.](#)
9. Fill engine coolant.  [Ref. to COOLING\(H4DOTC\)>Engine Coolant>REPLACEMENT > FILLING OF ENGINE COOLANT.](#)









AIR CONDITIONER > Evaporator

REMOVAL



Caution:

- Before handling the airbag system components, refer to "CAUTION" of "General Description" in "AIRBAG SYSTEM".  [Ref. to AIRBAG SYSTEM>General Description>CAUTION.](#)
- Be careful not to damage the airbag system harness when servicing the instrument panel. Damage may cause the system to malfunction.

1. Using the refrigerant recovery system, discharge refrigerant.  [Ref. to AIR CONDITIONER>Refrigerant Recovery Procedure>PROCEDURE.](#)
2. Disconnect the ground terminal from the battery sensor, and wait for at least 60 seconds before starting work.  [Ref. to REPAIR CONTENTS>NOTE > BATTERY.](#)
3. Drain the coolant from the radiator.  [Ref. to COOLING\(H4DOTC\)>Engine Coolant>REPLACEMENT > DRAINING OF ENGINE COOLANT.](#)
4. Remove the instrument panel assembly and the beam steering COMPL.  [Ref. to EXTERIOR/INTERIOR TRIM>Instrument Panel Assembly>REMOVAL.](#)
5. Remove the intercooler.  [Ref. to INTAKE \(INDUCTION\)\(H4DOTC\)>Intercooler>REMOVAL.](#)
6. Remove the expansion valve.  [Ref. to AIR CONDITIONER>Expansion Valve>REMOVAL.](#)
7. Remove the heater and cooling unit assembly.  [Ref. to AIR CONDITIONER>Heater and Cooling Unit>REMOVAL.](#)
8. Remove the heater core.  [Ref. to AIR CONDITIONER>Heater Core>REMOVAL.](#)
9. Remove the air conditioner CM.  [Ref. to AIR CONDITIONER>Control Unit>REMOVAL.](#)
10. Remove the cover evaporator.
 - (1) Remove the screws.
 - (2) Remove the connector clamp, and remove the cover evaporator.

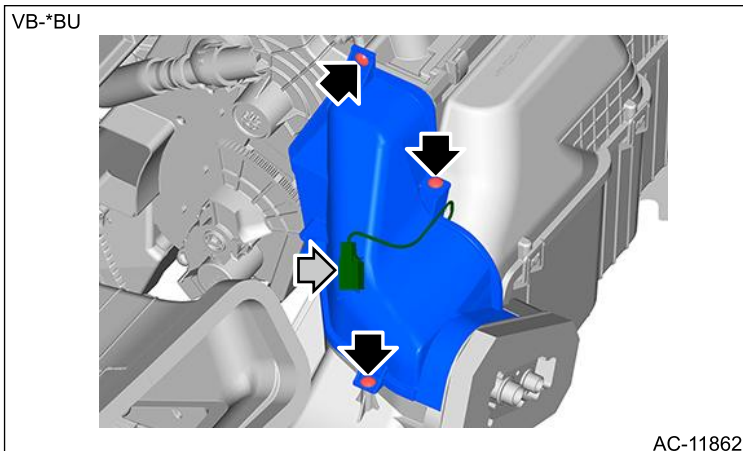

11. Remove the heater unit assembly.
 - (1) Remove the screws.
 - (2) Remove the clip, and remove the heater unit assembly.

VB-*BU

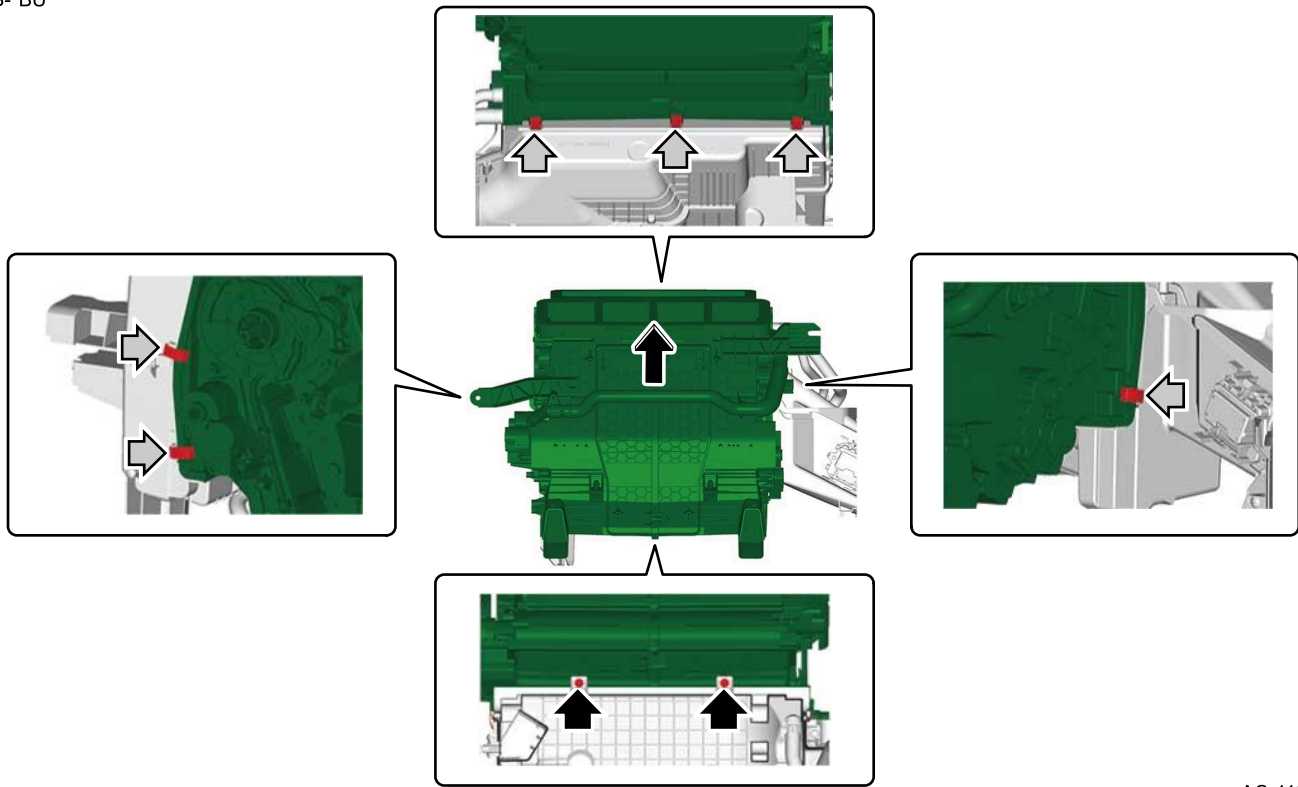

AC-11968

12. Remove the gasket expansion valve.

SK-*AU

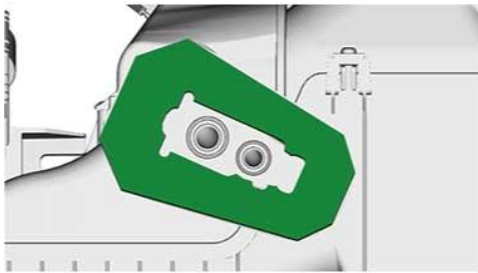

AC-10817

13. Remove the grommet.

SK-*AU

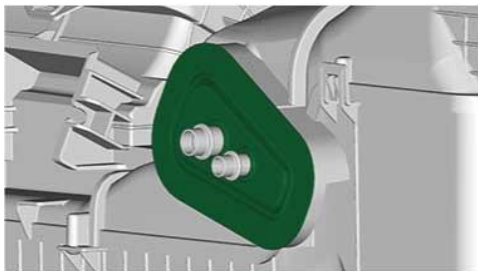

AC-10818

14. Remove the evaporator assembly as shown in the figure.

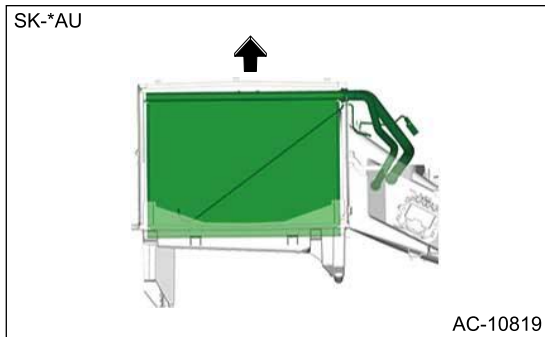

15. Remove the evaporator sensor. [🔧 Ref. to AIR CONDITIONER>Evaporator Sensor>REMOVAL.](#)

AIR CONDITIONER > Evaporator

INSTALLATION

Caution:

- **Do not start the engine before charging refrigerant.**
- **If the engine is started with no refrigerant charge, replace the compressor assembly.**
- **If the evaporator has been replaced, add an appropriate amount of compressor oil to the compressor.** [🔧 Ref. to AIR CONDITIONER>Compressor Oil>ADJUSTMENT.](#)
- **Replace the O-rings with new parts, and then apply compressor oil to install completely.**
- **Before handling the airbag system components, refer to "CAUTION" of "General Description" in "AIRBAG SYSTEM".** [🔧 Ref. to AIRBAG SYSTEM>General Description>CAUTION.](#)

- 1.** Install the evaporator sensor to the specified location. [🔧 Ref. to AIR CONDITIONER>Evaporator Sensor>INSTALLATION.](#)
- 2.** Install the evaporator assembly.
- 3.** Install the grommet.
- 4.** Install the gasket expansion valve.
- 5.** Install the heater unit assembly and the cover evaporator.
- 6.** Install the air conditioner CM. [🔧 Ref. to AIR CONDITIONER>Control Unit>INSTALLATION.](#)
- 7.** Attach the heater core. [🔧 Ref. to AIR CONDITIONER>Heater Core>INSTALLATION.](#)
- 8.** Install the heater and cooling unit assembly. [🔧 Ref. to AIR CONDITIONER>Heater and Cooling Unit>INSTALLATION.](#)
- 9.** Install the expansion valve. [🔧 Ref. to AIR CONDITIONER>Expansion Valve>INSTALLATION.](#)
- 10.** Install the intercooler. [🔧 Ref. to INTAKE \(INDUCTION\)\(H4DOTC\)>Intercooler>INSTALLATION.](#)
- 11.** Install the beam steering COMPL and the instrument panel assembly. [🔧 Ref. to EXTERIOR/INTERIOR TRIM>Instrument Panel Assembly>INSTALLATION.](#)
- 12.** Connect the ground terminal to battery sensor. [🔧 Ref. to REPAIR CONTENTS>NOTE > BATTERY.](#)
- 13.** Fill engine coolant. [🔧 Ref. to COOLING\(H4DOTC\)>Engine Coolant>REPLACEMENT > FILLING OF ENGINE COOLANT.](#)

AIR CONDITIONER > Evaporator

INSPECTION



- 1.** Check the evaporator fin for dust. Blow with compressed air or flush fins with water as needed.

2. If any oil leak is found from the evaporator, replace the evaporator assembly.

AIR CONDITIONER > Expansion Valve

REMOVAL



1. Using the refrigerant recovery system, discharge refrigerant.  [Ref. to AIR CONDITIONER>Refrigerant Recovery Procedure>PROCEDURE.](#)
2. Remove the intercooler.  [Ref. to INTAKE \(INDUCTION\)\(H4DOTC\)>Intercooler>REMOVAL.](#)
3. Disconnect the hose pressure suction on the expansion valve side.

Caution:

Seal the disconnected hose, pipe and engaging part of expansion valve with a plug or vinyl tape to prevent foreign matter from entering.

(1) Remove the nut and bolt.

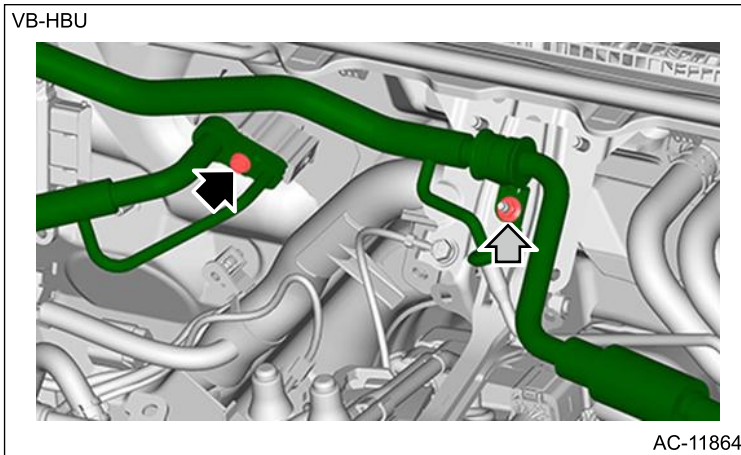

(2) Using the ST, disconnect the hose pressure suction from the pipe evaporator cooling.

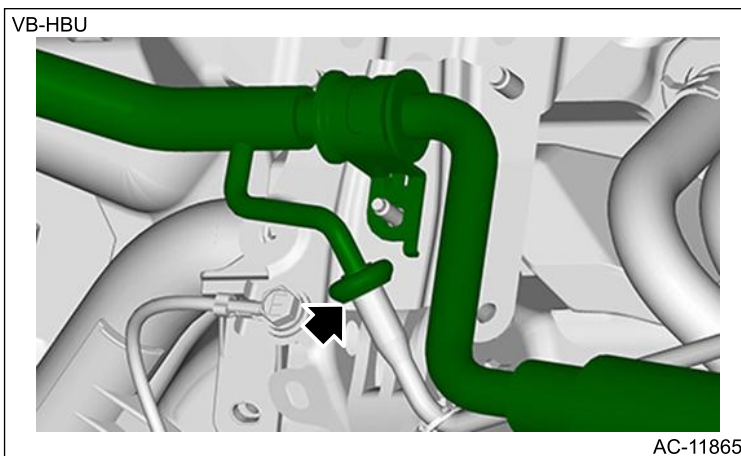

Preparation tool:

ST: DISCONNECT TOOL (73499SJ000)

1. Open the disconnect tool, and set it to the hose pressure suction while aligning the shape.

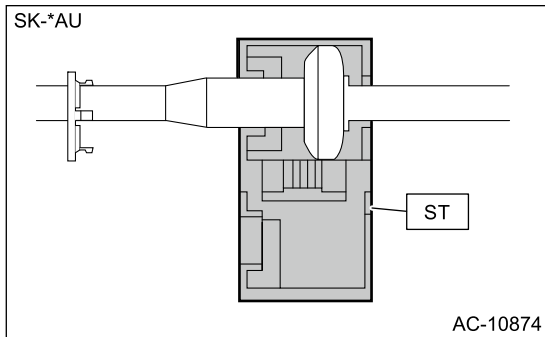

Note:

Spring force closes the cover automatically.

2. While checking through the inspection hole (a) of the disconnect tool, press in the protrusion (b) into the engaging portion of the hose pressure suction.

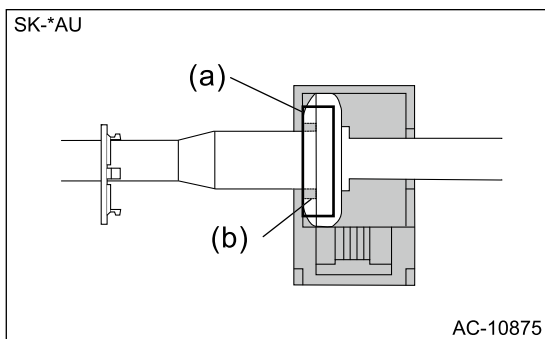

3. While holding the condition in step 2, pull out the hose pressure suction from the pipe evaporator cooling in the direction of the arrow.

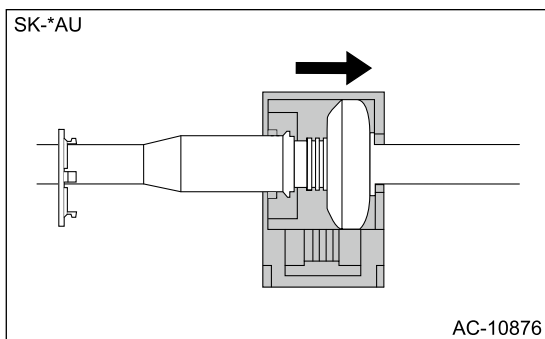

4. Detach the disconnect tool, and remove the indicator ring (a).

Caution:

- **Do not damage the indicator ring remaining on the vehicle, because it will be necessary if the hose pressure suction is reused.**
- **If the indicator ring has been lost or damaged, there is no way to confirm the secure engagement of parts. So replace the hose pressure suction with a new part.**

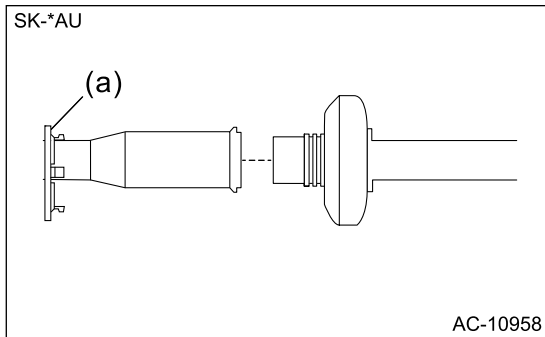

- Using the hexagon wrench, remove the bolts, then remove the expansion valve.

Caution:

Seal the engaging part of pipe and expansion valve with a plug or vinyl tape to prevent foreign matter from entering.

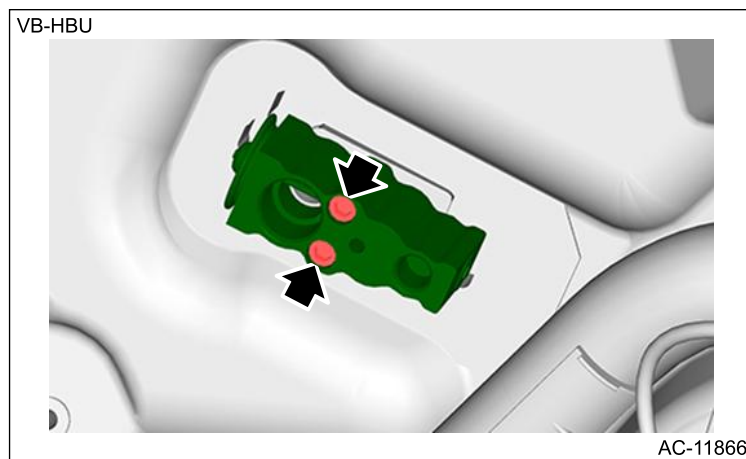

AIR CONDITIONER > Expansion Valve

INSTALLATION

Caution:

- **Do not start the engine before charging refrigerant.**
- **If the engine is started with no refrigerant charge, replace the compressor assembly.**
- **Replace the O-rings with new parts, and then apply compressor oil to install completely.**

- Using the hexagon wrench, install the expansion valve.

Tightening torque:

7.7 N·m (0.8 kgf-m, 5.7 ft-lb)

- Install the hose pressure suction.

(1) If the hose pressure suction is reused, install the indicator ring (a) as shown in the figure.

SK*AU

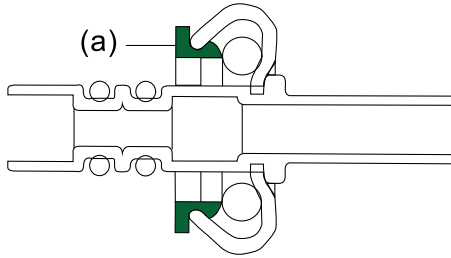

AC-10878

- (2) Engage the hose pressure suction and the pipe evaporator cooling, and press them in until a click sound is heard and the indicator ring jumps out.



Caution:

If the aforementioned phenomenon cannot be confirmed, it is considered that the fastening of the hose pressure suction was not successful. In this case, perform the installation work again by following the procedure.

- (3) Install the hose pressure suction.

Tightening torque:

7.5 N·m (0.8 kgf-m, 5.5 ft-lb)

3. Install the intercooler.  [Ref. to INTAKE \(INDUCTION\)\(H4DOTC\)>Intercooler>INSTALLATION.](#)
4. Charge refrigerant.  [Ref. to AIR CONDITIONER>Refrigerant Charging Procedure>PROCEDURE.](#)

REMOVAL



1. LOW-PRESSURE HOSE

1. Using the refrigerant recovery system, discharge refrigerant. [Ref. to AIR CONDITIONER>Refrigerant Recovery Procedure>PROCEDURE.](#)
2. Remove the intercooler. [Ref. to INTAKE \(INDUCTION\)\(H4DOTC\)>Intercooler>REMOVAL.](#)
3. Remove the hose pressure suction.

Caution:

- Do not apply excessive force to the hose.
- Seal the engaging part of disconnected hose, pipe, compressor assembly, and expansion valve with a plug or vinyl tape to prevent foreign matter from entering.

(1) Remove the nut and bolt.

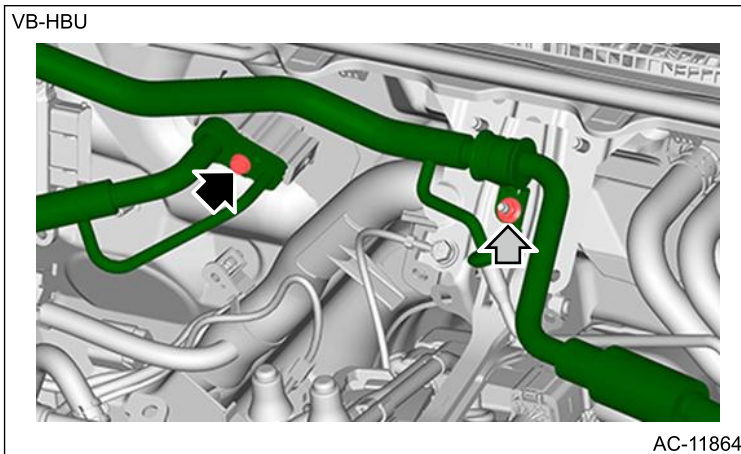

(2) Using the ST, disconnect the hose pressure suction from the pipe evaporator cooling.

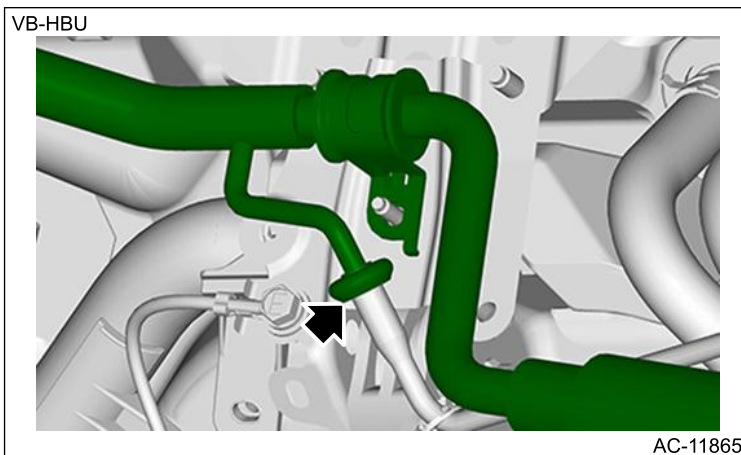

Preparation tool:

ST: DISCONNECT TOOL (73499SJ000)

1. Open the disconnect tool, and set it to the hose pressure suction while aligning the shape.

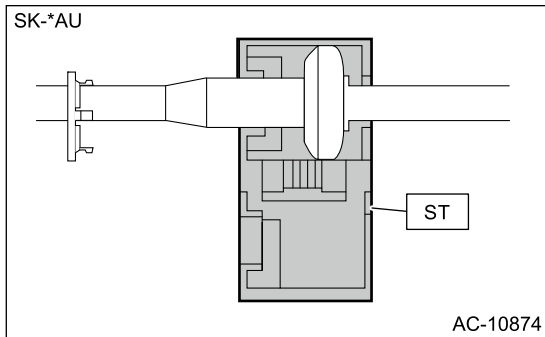

Note:

Spring force closes the cover automatically.

2. While checking through the inspection hole (a) of the disconnect tool, press in the protrusion (b) into the engaging portion of the hose pressure suction.

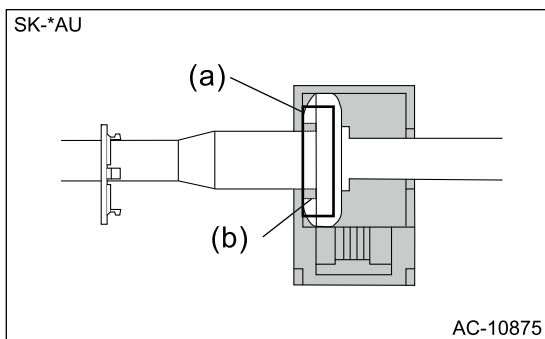

3. While holding the condition in step 2, pull out the hose pressure suction from the pipe evaporator cooling in the direction of the arrow.

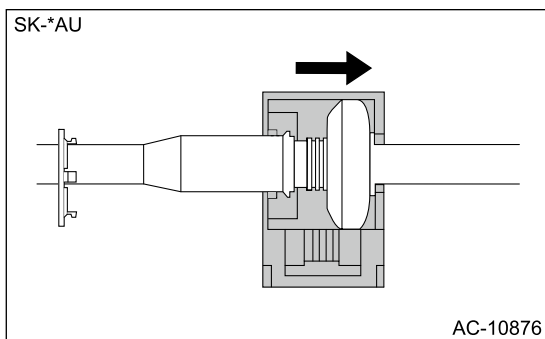

4. Detach the disconnect tool, and remove the indicator ring (a).

Caution:

- **Do not damage the indicator ring remaining on the vehicle, because it will be necessary if the hose pressure suction is reused.**
- **If the indicator ring has been lost or damaged, there is no way to confirm the secure engagement of parts. So replace the hose pressure suction with a new part.**

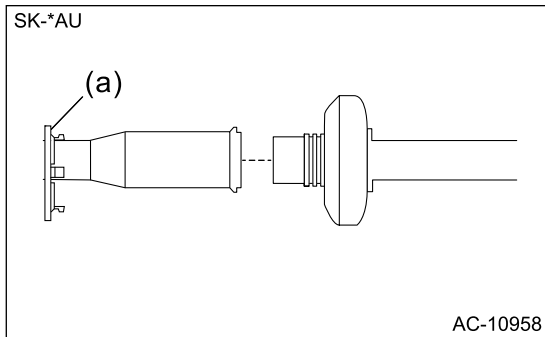

(3) Remove the bolts and remove the hose pressure suction.

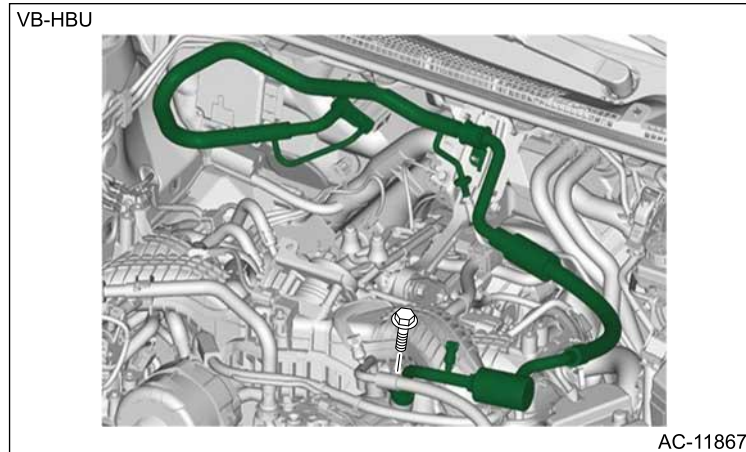

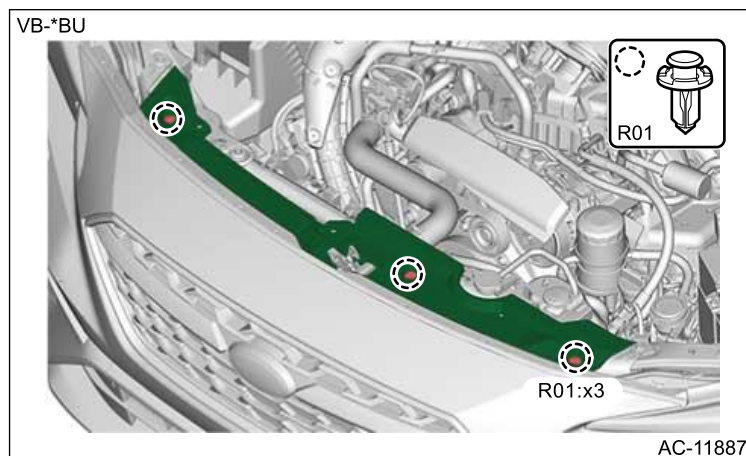

2. HIGH-PRESSURE HOSE

1. Using the refrigerant recovery system, discharge refrigerant. [🔧 Ref. to AIR CONDITIONER>Refrigerant Recovery Procedure>PROCEDURE.](#)
2. Disconnect the ground terminal from battery sensor. [🔧 Ref. to REPAIR CONTENTS>NOTE > BATTERY.](#)
3. Remove the air intake duct. [🔧 Ref. to INTAKE \(INDUCTION\)\(H4DOTC\)>Air Intake Duct>REMOVAL.](#)
4. Remove the clips, and remove the cover UPR front.

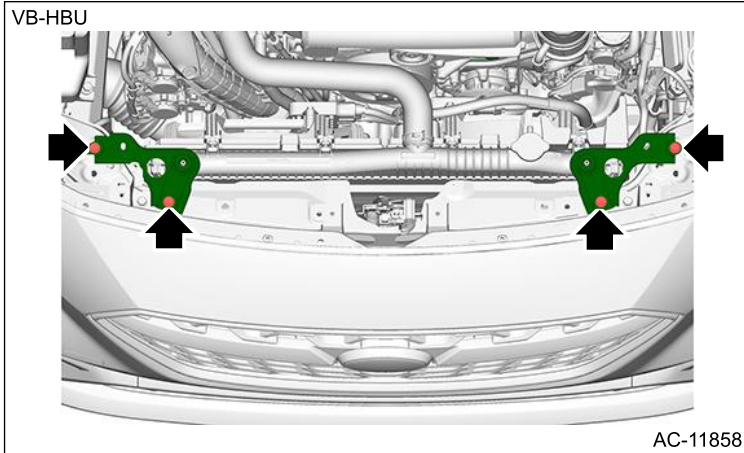

5. Remove the reservoir tank. [🔧 Ref. to COOLING\(H4DOTC\)>Reservoir Tank>REMOVAL.](#)
6. Remove the bolts and remove the radiator upper bracket.



7. Remove the bumper face front. (Model with CVTF cooler (air cool))  [Ref. to EXTERIOR/INTERIOR TRIM>Front Bumper>REMOVAL.](#)
8. Remove the hose pressure discharge.

Caution:

- Do not apply excessive force to the hose.
- Seal the disconnected hose, compressor assembly and engaging part of condenser assembly with a plug or vinyl tape to prevent foreign matter from entering.



Note:

Push the condenser assembly and radiator toward the engine side to secure working space.

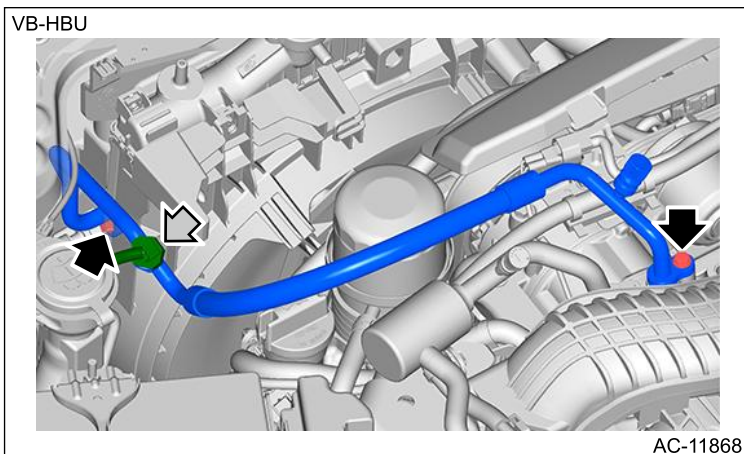
- (1) Disconnect the connector of the pressure sensor.
- (2) Remove the bolts, and remove the hose pressure discharge.



3. A/C PIPE

1. Using the refrigerant recovery system, discharge refrigerant.  [Ref. to AIR CONDITIONER>Refrigerant Recovery Procedure>PROCEDURE.](#)
2. Remove the battery and battery tray.  [Ref. to STARTING/CHARGING SYSTEMS\(H4DOTC\)>Battery>REMOVAL.](#)
3. Remove the hose pressure discharge.  [Ref. to AIR CONDITIONER>Hose and Pipe>REMOVAL > HIGH-PRESSURE HOSE.](#)

4. Remove the hose pressure suction.  [Ref. to AIR CONDITIONER>Hose and Pipe>REMOVAL > LOW-PRESSURE HOSE.](#)
5. Remove the pipe evaporator cooling.

Caution:

- **Do not apply excessive force to the pipe.**
- **Seal the engaging parts of disconnected pipe, expansion valve and condenser assembly with a plug or vinyl tape to prevent foreign matter from entering.**
- **Do not pull the harness and cable forcibly.**

Note:

The illustration shows the model with CVTF cooler (air cool).

- (1) Disconnect the two upper connectors of ECM.  [Ref. to FUEL INJECTION \(FUEL SYSTEMS\) \(H4DOTC\)>Engine Control Module \(ECM\)>REMOVAL.](#)
- (2) Disconnect the main fuse box connector, and detach the harness from the clip.
- (3) Release the claws, and remove the battery cable bracket and engine harness bracket.
- (4) Disconnect the connector of the pressure sensor.
- (5) Remove the bolt, and detach the pipe evaporator cooling.

VB-HBU

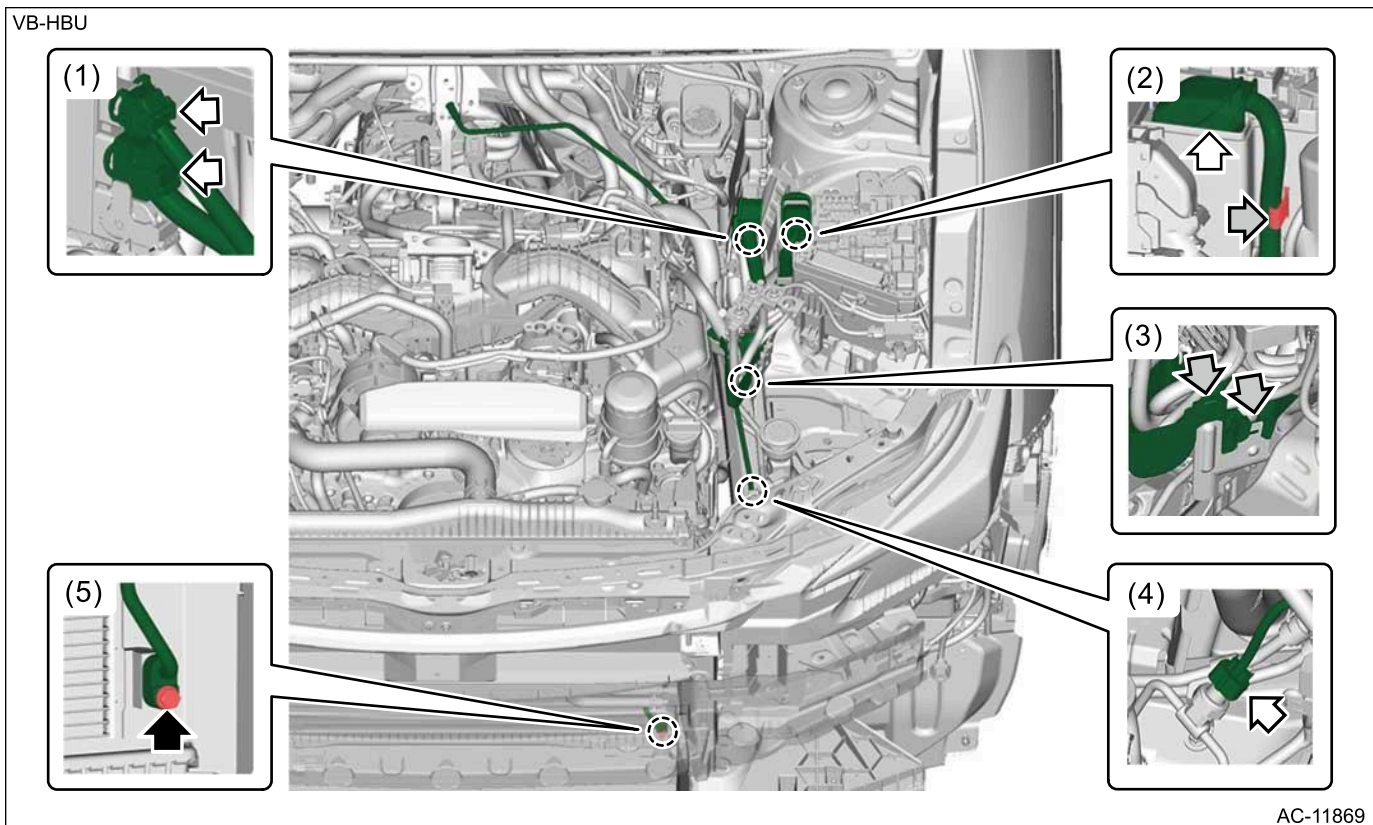

- (6) Disconnect the battery cable assemblies necessary for removing the pipe evaporator cooling.  [Ref. to STARTING/CHARGING SYSTEMS\(H4DOTC\)>Battery Cable Assembly>REMOVAL.](#)
- (7) Remove the pipe evaporator cooling from the clip and clamp.

Note:

Push the condenser assembly and radiator toward the engine side to secure working space.

VB-HBU

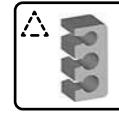
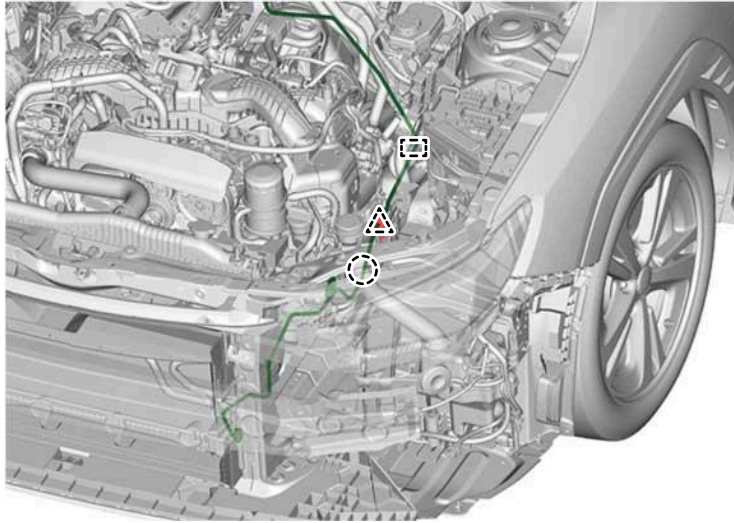

AC-11870

AIR CONDITIONER > Hose and Pipe

INSTALLATION

1. LOW-PRESSURE HOSE

Caution:

- Do not start the engine before charging refrigerant.
- If the engine is started with no refrigerant charge, replace the compressor assembly.
- If the hose and pipe has been replaced, add an appropriate amount of compressor oil to the compressor.  [Ref. to AIR CONDITIONER>Compressor Oil>ADJUSTMENT.](#)
- Replace the O-rings with new parts, and then apply compressor oil to install completely.
- When connecting hoses, do not apply an excessive force to them. After installing, check that no torsion or excessive tension applied to the hoses.
- If the lock spring of the hose pressure suction is damaged, replace it with a new part.

1. Install the hose pressure suction.

(1) If the hose pressure suction is reused, install the indicator ring (a) as shown in the figure.

SK*AU

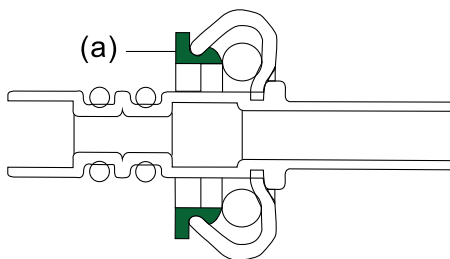

AC-10878

(2) Engage the hose pressure suction and the pipe evaporator cooling, and press them in until a click sound is heard and the indicator ring jumps out.



Caution:

If the aforementioned phenomenon cannot be confirmed, it is considered that the fastening of the hose pressure suction was not successful. In this case, perform the installation work again by following the procedure.

(3) Install the hose pressure suction.

Tightening torque:

Refer to "COMPONENT" of "General Description" for the tightening torque.  [Ref. to AIR CONDITIONER>General Description>COMPONENT > AIR CONDITIONING UNIT.](#)

2. Install the intercooler.  [Ref. to INTAKE \(INDUCTION\)\(H4DOTC\)>Intercooler>INSTALLATION.](#)
3. Charge refrigerant.  [Ref. to AIR CONDITIONER>Refrigerant Charging Procedure>PROCEDURE.](#)

2. HIGH-PRESSURE HOSE

Caution:

- Do not start the engine before charging refrigerant.
- If the engine is started with no refrigerant charge, replace the compressor assembly.
- If the hose and pipe has been replaced, add an appropriate amount of compressor oil to the compressor.  [Ref. to AIR CONDITIONER>Compressor Oil>ADJUSTMENT.](#)
- Replace the O-rings with new parts, and then apply compressor oil to install completely.
- When connecting hoses, do not apply an excessive force to them. After installing, check that no torsion or excessive tension applied to the hoses.

1. Install the hose pressure discharge, and connect the connector.

Tightening torque:

Refer to "COMPONENT" of "General Description" for the tightening torque.  [Ref. to AIR CONDITIONER>General Description>COMPONENT > AIR CONDITIONING UNIT.](#)

2. Install the bumper face front. (Model with CVTF cooler (air cool))  [Ref. to EXTERIOR/INTERIOR TRIM>Front Bumper>INSTALLATION.](#)

3. Install the radiator upper bracket.

Tightening torque:

27 N·m (2.8 kgf-m, 19.9 ft-lb)

4. Install the reservoir tank.  [Ref. to COOLING\(H4DOTC\)>Reservoir Tank>INSTALLATION.](#)

5. Install the cover UPR front.

6. Install the air intake duct.  [Ref. to INTAKE \(INDUCTION\)\(H4DOTC\)>Air Intake Duct>INSTALLATION.](#)

7. Connect the ground terminal to battery sensor.  [Ref. to REPAIR CONTENTS>NOTE > BATTERY.](#)







8. Charge refrigerant.  [Ref. to AIR CONDITIONER>Refrigerant Charging Procedure>PROCEDURE.](#)

3. A/C PIPE

Caution:

- Do not start the engine before charging refrigerant.
- If the engine is started with no refrigerant charge, replace the compressor assembly.
- If the hose and pipe has been replaced, add an appropriate amount of compressor oil to the compressor.  [Ref. to AIR CONDITIONER>Compressor Oil>ADJUSTMENT.](#)
- Replace the O-rings with new parts, and then apply compressor oil to install completely.
- When connecting pipes, do not apply an excessive force to them. After installation, check that the pipes are not damaged.

- 1.** Install the pipe evaporator cooling.
 - (1) Install the pipe evaporator cooling.

Tightening torque:
7.5 N·m (0.8 kgf-m, 5.5 ft-lb)
 - (2) Install the battery cable assembly.  [Ref. to STARTING/CHARGING SYSTEMS\(H4DOTC\)>Battery Cable Assembly>INSTALLATION.](#)
 - (3) Connect the connector of the pressure sensor.
 - (4) Install the battery cable bracket and engine harness bracket.
 - (5) Connect the connector and harness of the main fuse box.
 - (6) Connect the ECM connector.  [Ref. to FUEL INJECTION \(FUEL SYSTEMS\)\(H4DOTC\)>Engine Control Module \(ECM\)>INSTALLATION.](#)
- 2.** Install the hose pressure suction.  [Ref. to AIR CONDITIONER>Hose and Pipe>INSTALLATION > LOW-PRESSURE HOSE.](#)
- 3.** Install the hose pressure discharge.  [Ref. to AIR CONDITIONER>Hose and Pipe>INSTALLATION > HIGH-PRESSURE HOSE.](#)
- 4.** Install the battery tray and battery.  [Ref. to STARTING/CHARGING SYSTEMS\(H4DOTC\)>Battery>INSTALLATION.](#)
- 5.** Charge refrigerant.  [Ref. to AIR CONDITIONER>Refrigerant Charging Procedure>PROCEDURE.](#)

AIR CONDITIONER > Hose and Pipe



INSPECTION

- 1.** Check the hoses for cracks, damage and expansion. If there is a malfunction, replace the hose pressure suction or the hose pressure discharge.
- 2.** Check the pipes for crack or damage. If there is a malfunction, replace the pipe evaporator cooling.

AIR CONDITIONER > Pressure Sensor

REMOVAL



1. Using the refrigerant recovery system, discharge refrigerant.  [Ref. to AIR CONDITIONER>Refrigerant Recovery Procedure>PROCEDURE.](#)
2. Disconnect the ground terminal from battery sensor.  [Ref. to REPAIR CONTENTS>NOTE > BATTERY.](#)
3. Remove the battery. (When the pressure sensor of pipe evaporator cooling is removed)  [Ref. to STARTING/CHARGING SYSTEMS\(H4DOTC\)>Battery>REMOVAL.](#)
4. Remove the pressure sensor.
 - (1) Disconnect the connector.
 - (2) Remove the pressure sensor as shown in the figure.

Caution:

- **Do not deform the pipe.**
- **Seal the engaging sections of the disconnected pipe and the sensor with a plug or vinyl tape to prevent foreign matter from entering.**
- **Do not reuse the sensor.**

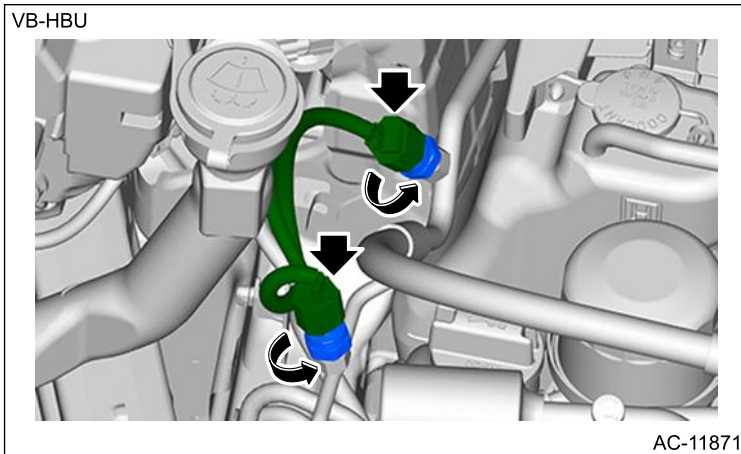

AIR CONDITIONER > Pressure Sensor

INSTALLATION



Caution:

- **Do not start the engine before charging refrigerant.**
- **If the engine is started with no refrigerant charge, replace the compressor assembly.**
- **O-rings are included in the pressure sensor. Apply compressor oil to new O-rings and install it to the pressure sensor completely.**

1. Install a new pressure sensor and O-ring and connect the connector.



Tightening torque:

9.8 ±1.5 N·m (1.0±0.2 kgf-m, 7.2±1.1 ft-lb)

2. Install the battery. (When the pressure sensor of pipe evaporator cooling is removed)  [Ref. to STARTING/CHARGING SYSTEMS\(H4DOTC\)>Battery>INSTALLATION.](#)
3. Connect the ground terminal to battery sensor.  [Ref. to REPAIR CONTENTS>NOTE > BATTERY.](#)
4. Charge refrigerant.  [Ref. to AIR CONDITIONER>Refrigerant Charging Procedure>PROCEDURE.](#)



AIR CONDITIONER > Pressure Sensor

INSPECTION

1. Read the DTC of [Air Conditioner] using the Subaru Select Monitor.  [Ref. to COMMON \(DIAGNOSTICS\)>Diagnostic Trouble Code \(DTC\).](#)
2. If the following diagnosis code (DTC) is displayed, refer to "Diagnostic Procedure with Diagnostic Trouble Code (DTC)" in "AIR CONDITIONER (DIAGNOSTICS)" section.
 - DTC B14A3 (REFRIGERANT PRESSURE SENSOR CIRCUIT OPEN):  [Ref. to AIR CONDITIONER\(DIAGNOSTICS\)>Diagnostic Procedure with Diagnostic Trouble Code \(DTC\)>DTC B14A3 REFRIGERANT PRESSURE SENSOR CIRCUIT OPEN.](#)
 - DTC B14A4 (REFRIGERANT PRESSURE SENSOR CIRCUIT SHORT-CIRCUIT):  [Ref. to AIR CONDITIONER\(DIAGNOSTICS\)>Diagnostic Procedure with Diagnostic Trouble Code \(DTC\)>DTC B14A4 REFRIGERANT PRESSURE SENSOR CIRCUIT SHORT-CIRCUIT .](#)

AIR CONDITIONER > Ambient Sensor

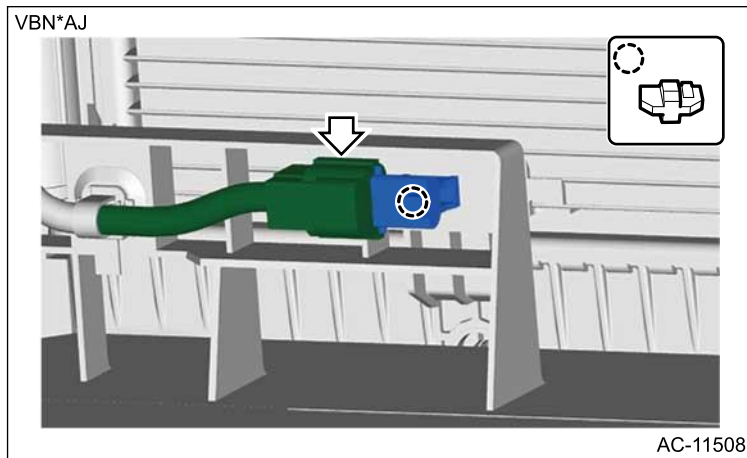

REMOVAL

1. Disconnect the ground terminal from battery sensor.  [Ref. to REPAIR CONTENTS>NOTE > BATTERY.](#)
2. Remove the bumper face front.  [Ref. to EXTERIOR/INTERIOR TRIM>Front Bumper>REMOVAL.](#)
3. Remove the ambient sensor.
 - (1) Disconnect the connector.
 - (2) Release the claws and remove the ambient sensor.



AIR CONDITIONER > Ambient Sensor

INSTALLATION

1. Install the ambient sensor and connect the connector.
2. Install the bumper face front.  [Ref. to EXTERIOR/INTERIOR TRIM>Front Bumper>INSTALLATION.](#)
3. Connect the ground terminal to battery sensor.  [Ref. to REPAIR CONTENTS>NOTE > BATTERY.](#)

AIR CONDITIONER > Ambient Sensor

INSPECTION

1. Visually check the ambient sensor for dirt or damage, and clean or replace as necessary.
2. Measure the resistance between connector terminals.

Caution:

During inspection, be careful not to touch the sensor end in order to avoid misjudgment due to body temperature.

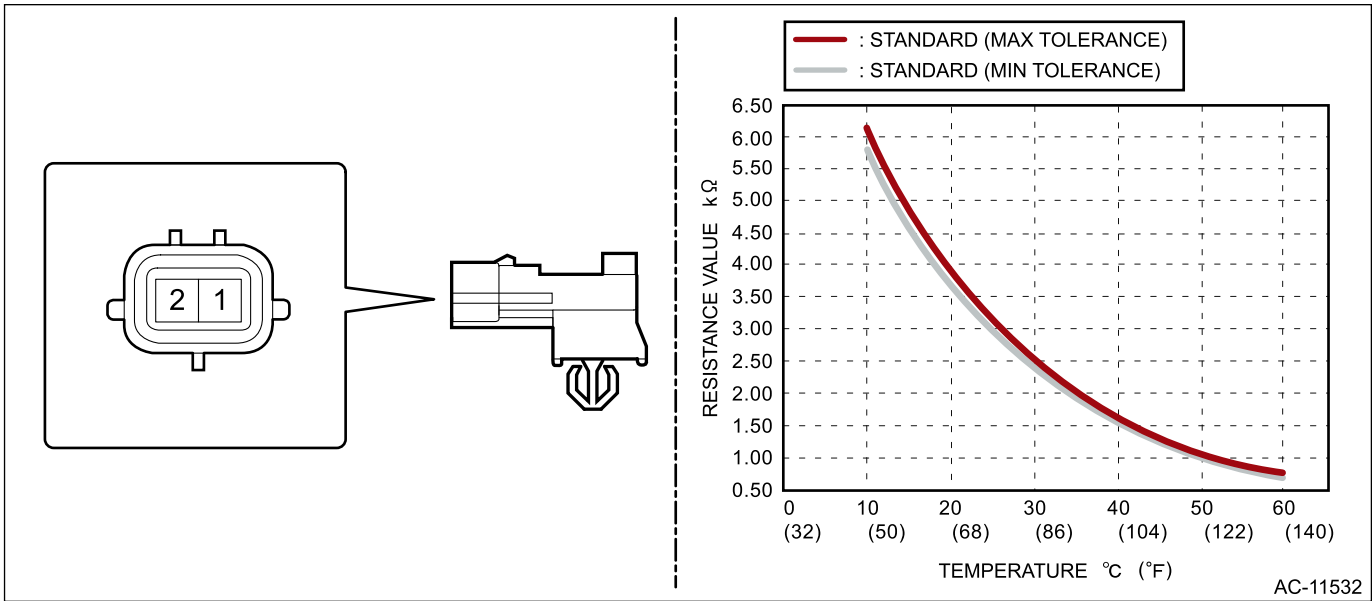



Terminal No.	Inspection conditions	Standard
2 — 1	10°C (50°F)	5.82 — 6.18 kΩ
	15°C (59°F)	4.58 — 4.87 kΩ
	20°C (68°F)	3.64 — 3.86 kΩ
	25°C (77°F)	2.91 — 3.09 kΩ
	30°C (86°F)	2.35 — 2.49 kΩ
	35°C (95°F)	1.9 — 2.02 kΩ
	40°C (104°F)	1.56 — 1.65 kΩ
	45°C (113°F)	1.28 — 1.36 kΩ
	50°C (122°F)	1.06 — 1.12 kΩ
	55°C (131°F)	0.88 — 0.93 kΩ
	60°C (140°F)	0.74 — 0.78 kΩ

3. Replace the ambient sensor if the inspection result is not within the standard value.

AIR CONDITIONER > Sunload Sensor (Auto A/C Model)

REMOVAL

1. Disconnect the ground terminal from battery sensor.  [Ref. to REPAIR CONTENTS>NOTE > BATTERY.](#)
2. Remove the grille speaker side.  [Ref. to ENTERTAINMENT & MONITORING>Front Speaker>REMOVAL > TWEETER.](#)
3. Remove the grille front defroster.
(1) Release the clips.

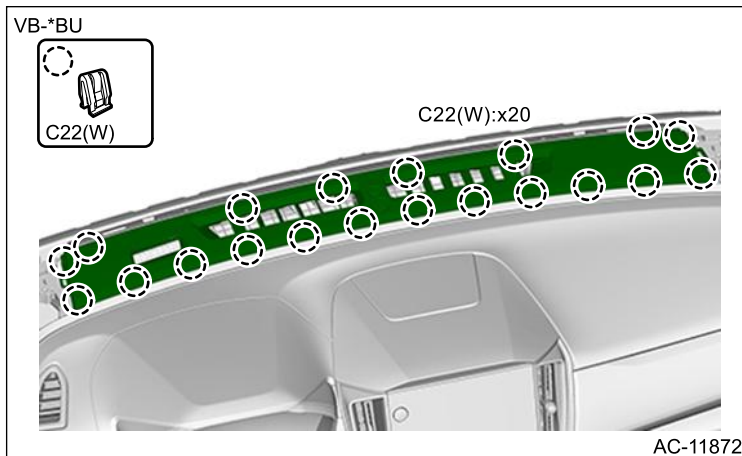

- (2) Disconnect the connector and remove the grille front defroster.
4. Release the claws and remove the sunload sensor.

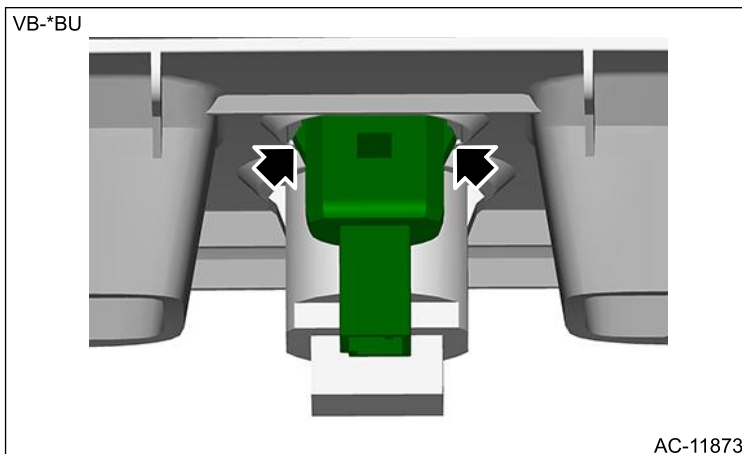

AIR CONDITIONER > Sunload Sensor (Auto A/C Model)

INSTALLATION

1. Install the sunload sensor.
2. Connect the connector, and install the grille front defroster.
3. Install the grille speaker side.  [Ref. to ENTERTAINMENT & MONITORING>Front Speaker>INSTALLATION > TWEETER.](#)
4. Connect the ground terminal to battery sensor.  [Ref. to REPAIR CONTENTS>NOTE > BATTERY.](#)

AIR CONDITIONER > Sunload Sensor (Auto A/C Model)

INSPECTION

1. Check if there is anything that affects sensing, around the sunload sensor.
 - (1) Is the sunload sensor free from any object that disturbs sensing?
 - (2) Is the windshield glass free from any object such as sticker or film that disturbs sensing?
 - **Yes** → **Go to Step 2.**
 - **No** → Remove everything that affects sensing.
2. Check the sunload sensor using the Subaru Select Monitor.
 - (1) Display [Quantity of Sunload] on the [Data Monitor] of [Air Conditioner].  [Ref. to COMMON \(DIAGNOSTICS\)>Data Monitor.](#)
 - (2) Cover the sunload sensor with cloth and the like to avoid direct light. Does [Quantity of Sunload] indicate [0 W/m²]?
 - **Yes** → **Go to Step 3.**
 - **No** → Replace the sunload sensor.
3. From the condition in step 2., expose the sunload sensor to light.
 - (1) Place intense light such as incandescent light at 300 mm (11.81 in) or less from the sunload sensor.
 - (2) Does [Quantity of Sunload] indicate [2,000 W/m²] or less?

Caution:

The value changes depending on the angle of light.



- **Yes** → The sunload sensor is normal.
- **No** → Replace the sunload sensor.

AIR CONDITIONER > In-Vehicle Sensor (Auto A/C Model)

REMOVAL

Caution:

Before handling the airbag system components, refer to "CAUTION" of "General Description" in "AIRBAG SYSTEM".  [Ref. to AIRBAG SYSTEM>General Description>CAUTION.](#)

1. Disconnect the ground terminal from the battery sensor, and wait for at least 60 seconds before starting work.  [Ref. to REPAIR CONTENTS>NOTE > BATTERY.](#)
2. Remove the cover LWR driver.  [Ref. to EXTERIOR/INTERIOR TRIM>Instrument Panel Lower Cover>REMOVAL.](#)
3. Remove the knee airbag module.  [Ref. to AIRBAG SYSTEM>Knee Airbag Module>REMOVAL.](#)
4. Remove the in-vehicle sensor.
 - (1) Disconnect the aspirator hose and connector.

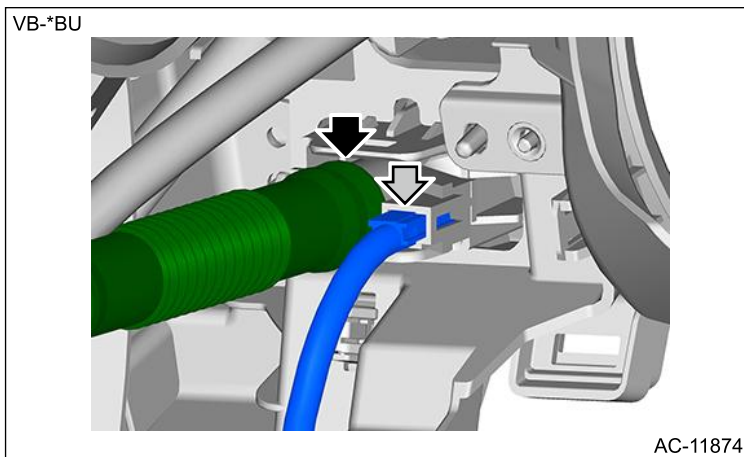

- (2) Release the claws and remove the in-vehicle sensor.

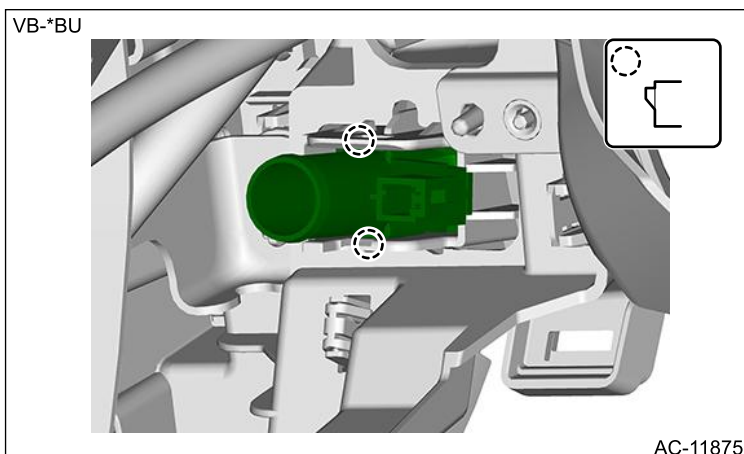



AIR CONDITIONER > In-Vehicle Sensor (Auto A/C Model)

INSTALLATION

Caution:

Before handling the airbag system components, refer to "CAUTION" of "General Description" in "AIRBAG SYSTEM".  [Ref. to AIRBAG SYSTEM>General Description>CAUTION.](#)

1. Install the in-vehicle sensor and connect the connector and aspirator hose.
2. Install the knee airbag module.  [Ref. to AIRBAG SYSTEM>Knee Airbag Module>INSTALLATION.](#)
3. Install the cover LWR driver.  [Ref. to EXTERIOR/INTERIOR TRIM>Instrument Panel Lower Cover>INSTALLATION.](#)
4. Connect the ground terminal to battery sensor.  [Ref. to REPAIR CONTENTS>NOTE > BATTERY.](#)

AIR CONDITIONER > In-Vehicle Sensor (Auto A/C Model)**INSPECTION**

1. Set the vehicle to the following conditions.

Item	Condition
Ignition switch	ON
A/C switch	ON
Temperature setting	HI (MAX HOT)
Air flow control switch	DEF
Fan speed	HI (MAX)

2. Check the suction port (a) for in-vehicle sensor of the panel starter switch.

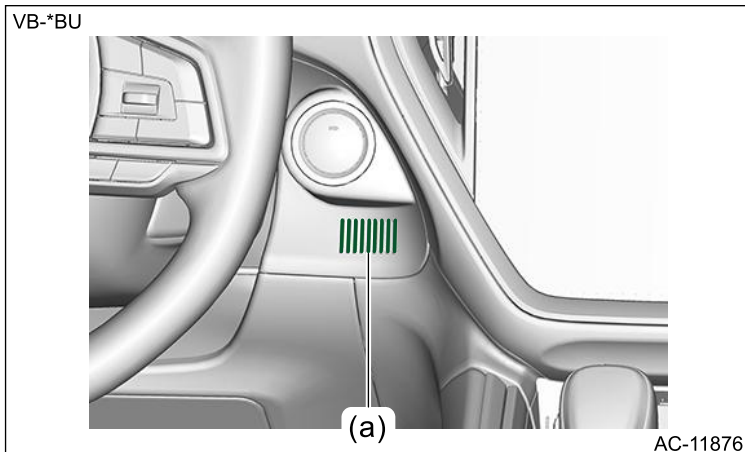

- (1) Put a strip of paper close to the front side of the suction port (a).
- (2) Can you see the paper moving towards the port and the air being sucked into the port?

Caution:

Be careful not to let the paper get sucked into the port.

- **Yes** → **Go to Step 5.**
 - **No** → **Go to step 3.**
3. Check the aspirator hose (a).

VB-*BU

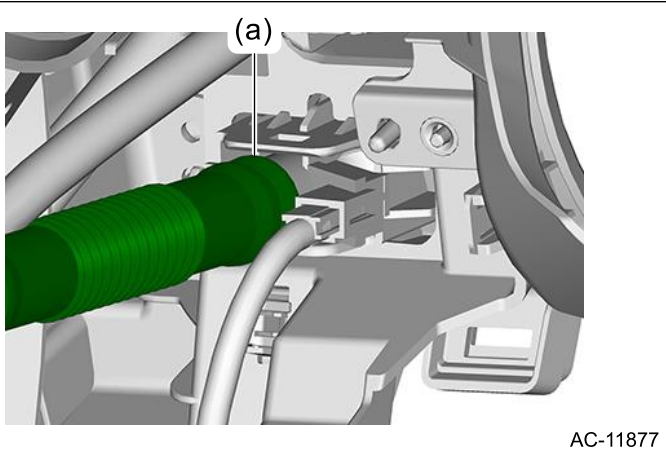

AC-11877

- (1) Are the in-vehicle sensor and aspirator hose connected securely?
- (2) Is the aspirator hose free from any kinks or cracks?
 - **Yes** → **Go to Step 4.**
 - **No** → Repair or replace the aspirator hose if necessary.
- 4.** Check if there is anything that affects sensing, around the in-vehicle sensor.
 - (1) Is the in-vehicle sensor hole free from clogging?
 - (2) Is the peripheral area of the in-vehicle sensor free from any heat-producing parts (such as navigation system etc.)?
 - **Yes** → **Go to Step 5.**
 - **No** → Remove everything that affects sensing.
- 5.** Check in-vehicle sensor.
 - (1) Disconnect the connector.
 - (2) Measure the resistance between connector terminals.

Caution:
 During inspection, be careful not to touch the sensor end in order to avoid misjudgment due to body temperature.

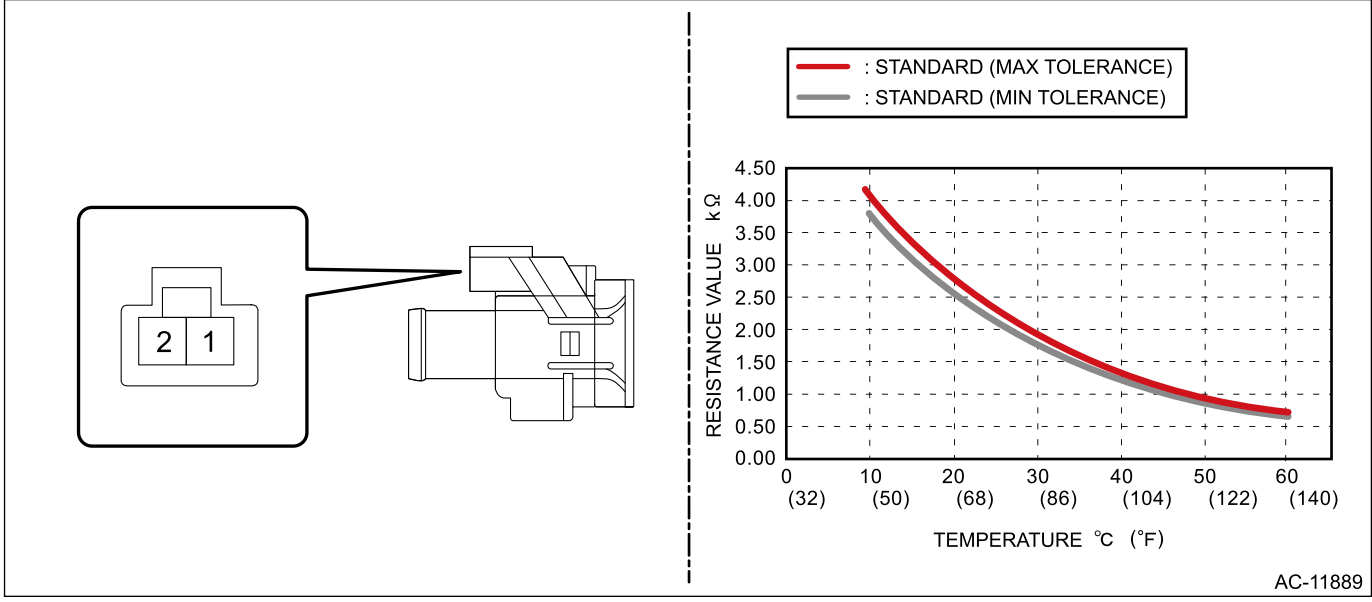

AC-11889

Terminal No.	Inspection conditions	Standard
1 – 2	10°C (50°F)	3.772 – 4.101 kΩ

Terminal No.	Inspection conditions	Standard
	15°C (59°F)	3.096 — 3.338 kΩ
	20°C (68°F)	2.556 — 2.734 kΩ
	25°C (77°F)	2.121 — 2.251 kΩ
	30°C (86°F)	1.756 — 1.878 kΩ
	35°C (95°F)	1.462 — 1.574 kΩ
	40°C (104°F)	1.223 — 1.326 kΩ
	45°C (113°F)	1.028 — 1.122 kΩ
	50°C (122°F)	0.868 — 0.9542 kΩ
	55°C (131°F)	0.7363 — 0.8147 kΩ
	60°C (140°F)	0.6273 — 0.6984 kΩ

(3) Is the resistance within the standard?

- **Yes** → The in-vehicle sensor is normal.
- **No** → Replace the in-vehicle sensor.

AIR CONDITIONER > Temperature and Humidity Sensor

NOTE

For operation procedures for temperature and humidity sensor, refer to "In-vehicle Sensor".  [Ref. to AIR CONDITIONER>In-Vehicle Sensor \(Auto A/C Model\).](#)

AIR CONDITIONER > Temperature and Humidity Sensor

INSPECTION

1. Set the vehicle to the following conditions.

Item	Condition
Ambient temperature	Approx. 25°C (77°F)
Ignition switch	ON
A/C switch	ON
Temperature setting	HI (MAX HOT)
Air flow control switch	DEF
Fan speed	HI (MAX)

2. Check the suction port (a) for the temperature and humidity sensor of the panel starter switch.

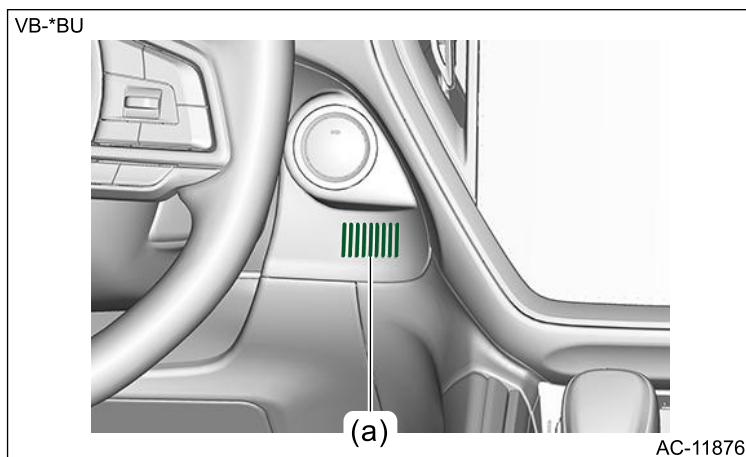

- (1) Put a strip of paper close to the front side of the suction port (a).
- (2) Can you see the paper moving towards the port and the air being sucked into the port?

Caution:

Be careful not to let the paper get sucked into the port.

- **Yes** → **Go to Step 5.**
 - **No** → **Go to step 3.**
3. Check the aspirator hose (a).

VB-*BU

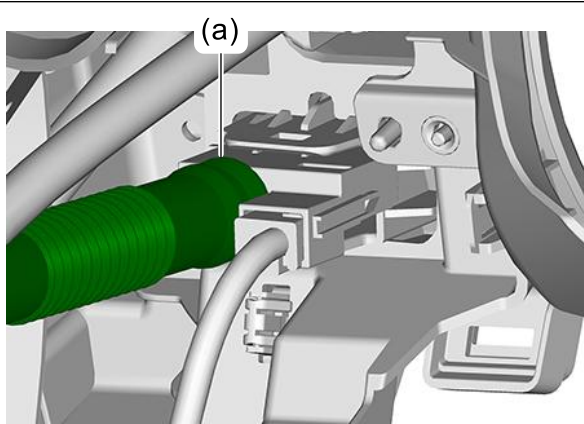

AC-11886

(1) Are the aspirator hoses on both sides of the case and sensor connected securely?

(2) Is the aspirator hose free from any kinks or cracks?

- **Yes** → **Go to Step 4.**
- **No** → Repair or replace the aspirator hose if necessary.

4. Check if there is anything that affects sensing around the temperature and humidity sensor.

(1) Is the temperature and humidity sensor hole free from clogging?

(2) Is the peripheral area of the temperature and humidity sensor free from any heat-producing parts (such as navigation system etc.)?

- **Yes** → **Go to Step 5.**
- **No** → Remove everything that affects sensing.

5. Perform the inspection of temperature and humidity sensor unit.

(1) Is the voltage between terminals of humidity sensor within standard value?

Caution:

During inspection, be careful not to touch the sensor end in order to avoid misjudgment due to body temperature.

Note:

Perform the check from the backside with the connectors connected and with the ignition switch ON.

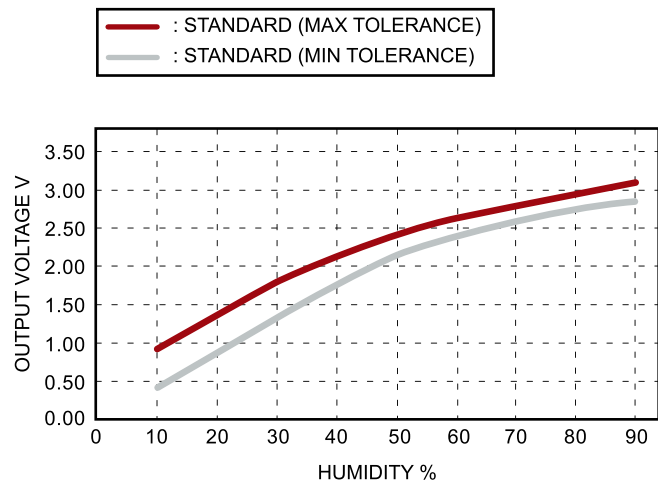
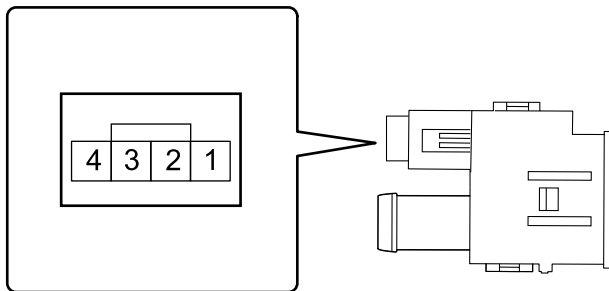

AC-11890

Terminal No.	Inspection conditions	Standard
3 – 2	10%	0.46 – 0.94 V
	20%	0.90 – 1.35 V
	30%	1.35 – 1.78 V
	40%	1.78 – 2.11 V
	50%	2.11 – 2.36 V
	60%	2.34 – 2.59 V
	70%	2.55 – 2.78 V
	80%	2.73 – 2.96 V
	90%	2.90 – 3.15 V

(2) Is the resistance between terminals of temperature sensor within standard value?

Caution:

During inspection, be careful not to touch the sensor end in order to avoid misjudgment due to body temperature.

1. Turn the ignition switch to OFF, then disconnect the ground terminal from the battery sensor.
 [Ref. to REPAIR CONTENTS>NOTE > BATTERY.](#)
2. Disconnect the temperature and humidity sensor connector.
3. Is the resistance between terminals of temperature sensor within standard value?

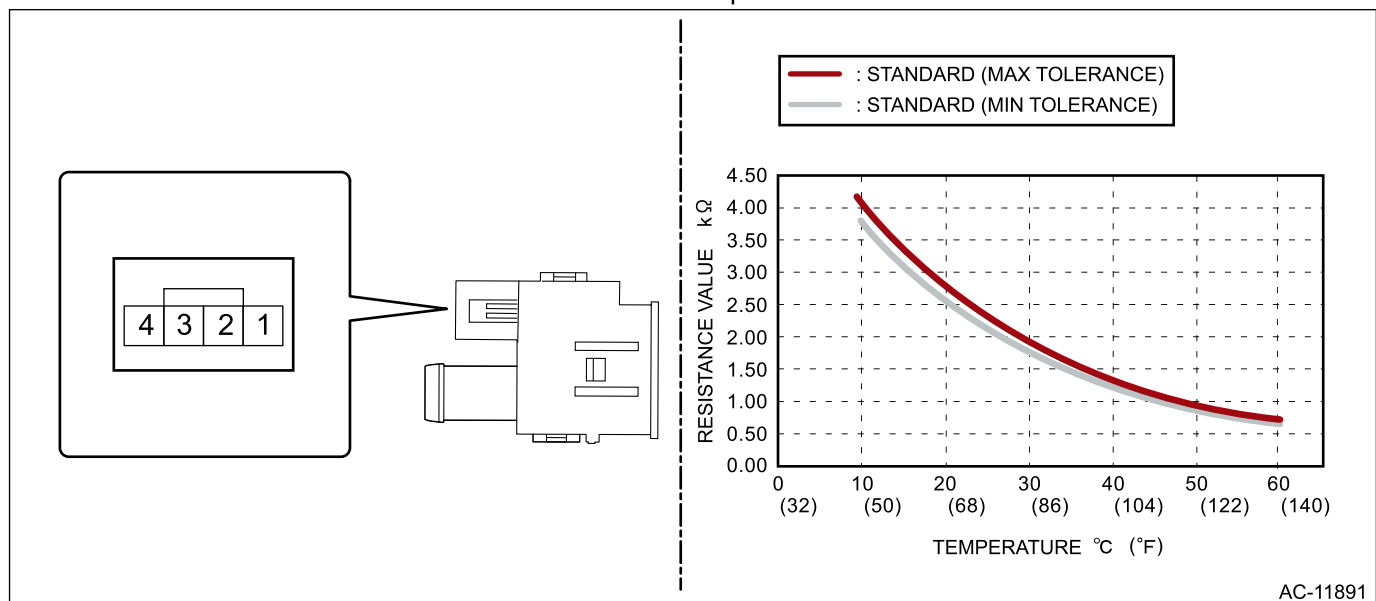

Terminal No.	Inspection conditions	Standard
1 – 2	10°C (50°F)	3.772 – 4.101 kΩ
	15°C (59°F)	3.096 – 3.338 kΩ
	20°C (68°F)	2.556 – 2.734 kΩ
	25°C (77°F)	2.121 – 2.251 kΩ
	30°C (86°F)	1.756 – 1.878 kΩ
	35°C (95°F)	1.462 – 1.574 kΩ
	40°C (104°F)	1.223 – 1.326 kΩ
	45°C (113°F)	1.028 – 1.122 kΩ

Terminal No.	Inspection conditions	Standard
	50°C (122°F)	0.868 — 0.9542 kΩ
	55°C (131°F)	0.7363 — 0.8147 kΩ
	60°C (140°F)	0.6273 — 0.6984 kΩ

- **Yes** → The temperature and humidity sensor is normal.
- **No** → Replace the temperature and humidity sensor.









AIR CONDITIONER > Evaporator Sensor

REMOVAL



Caution:

Before handling the airbag system components, refer to "CAUTION" of "General Description" in "AIRBAG SYSTEM".  [Ref. to AIRBAG SYSTEM>General Description>CAUTION.](#)

1. Using the refrigerant recovery system, discharge refrigerant.  [Ref. to AIR CONDITIONER>Refrigerant Recovery Procedure>PROCEDURE.](#)
2. Disconnect the ground terminal from the battery sensor, and wait for at least 60 seconds before starting work.  [Ref. to REPAIR CONTENTS>NOTE > BATTERY.](#)
3. Drain the coolant from the radiator.  [Ref. to COOLING\(H4DOTC\)>Engine Coolant>REPLACEMENT > DRAINING OF ENGINE COOLANT.](#)
4. Remove the instrument panel assembly and the beam steering COMPL.  [Ref. to EXTERIOR/INTERIOR TRIM>Instrument Panel Assembly>REMOVAL.](#)
5. Remove the intercooler.  [Ref. to INTAKE \(INDUCTION\)\(H4DOTC\)>Intercooler>REMOVAL.](#)
6. Disconnect the hose pressure suction on the expansion valve side.  [Ref. to AIR CONDITIONER>Hose and Pipe>REMOVAL.](#)
7. Remove the heater and cooling unit assembly.  [Ref. to AIR CONDITIONER>Heater and Cooling Unit>REMOVAL.](#)
8. Remove the heater core.  [Ref. to AIR CONDITIONER>Heater Core>REMOVAL.](#)
9. Remove the air conditioner CM.  [Ref. to AIR CONDITIONER>Control Unit>REMOVAL.](#)
10. Remove the cover evaporator.
 - (1) Remove the screws.
 - (2) Remove the connector clamp, and remove the cover evaporator.

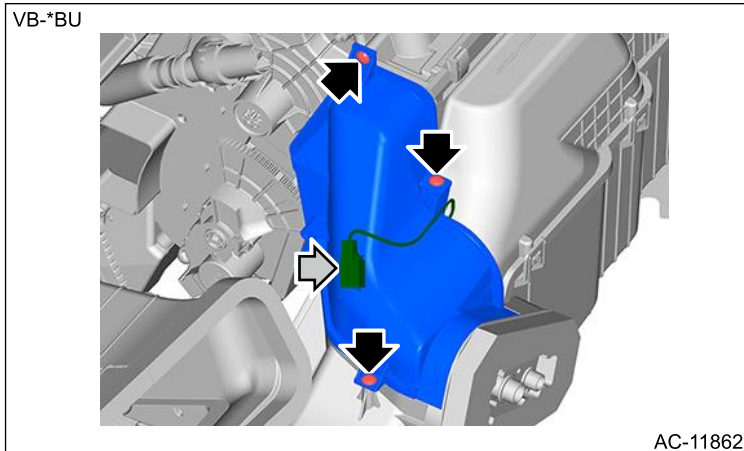

11. Remove the heater unit assembly.
 - (1) Remove the screws.
 - (2) Remove the clip, and remove the heater unit assembly.

VB-*BU

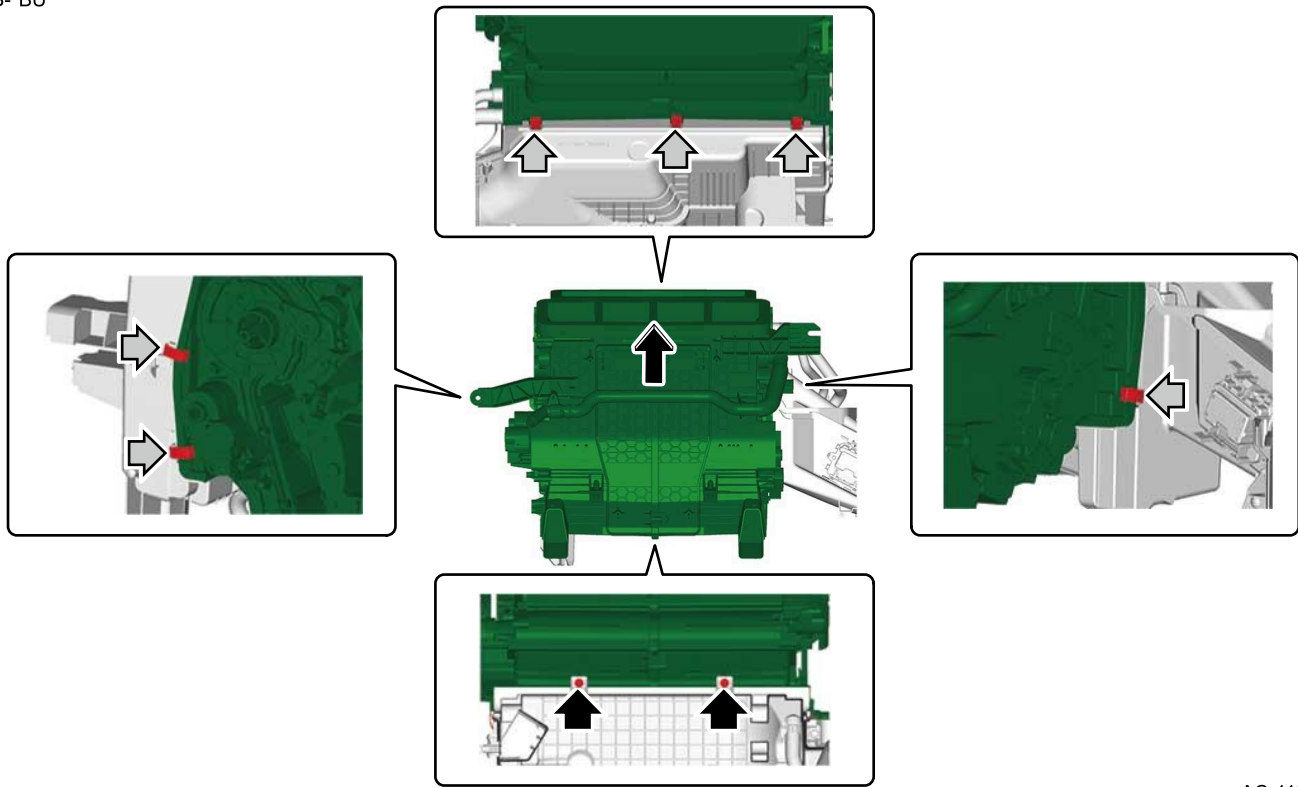

AC-11968

12. Remove the evaporator assembly as shown in the figure.

SK-*AU

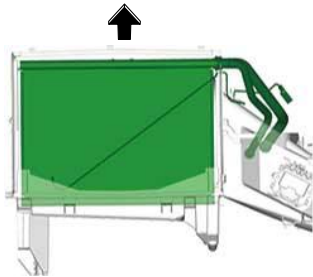

AC-10819

13. Remove the evaporator sensor as shown in the figure.

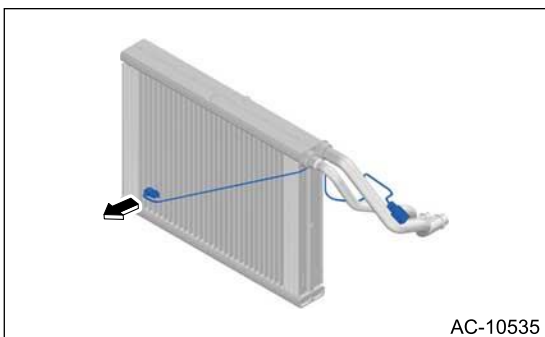

AC-10535

AIR CONDITIONER > Evaporator Sensor

INSTALLATION

Caution:

- Do not start the engine before charging refrigerant.
- If the engine is started with no refrigerant charge, replace the compressor assembly.
- Replace the O-rings with new parts, and then apply compressor oil to install completely.
- Before handling the airbag system components, refer to "CAUTION" of "General Description" in "AIRBAG SYSTEM".  [Ref. to AIRBAG SYSTEM>General Description>CAUTION.](#)





1. Install the evaporator sensor at the position shown in the figure.

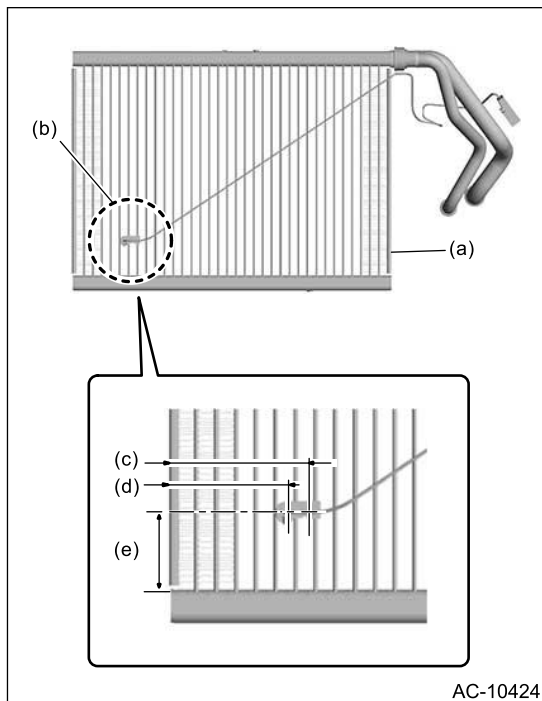



Caution:

The illustration shows when the evaporator assembly is replaced with a new one. If the evaporator assembly is reused, do not use the existing insert hole when installing the temperature sensor to the evaporator. Instead, insert the sensor to the position 5 mm (0.2 in) below the hole center on the same line.



- (a) Evaporator ASSY
- (b) Evaporator sensor
- (c) 57 mm (2.24 in)
- (d) 48 mm (1.89 in)
- (e) 32.6 mm (1.28 in)

2. Install the evaporator assembly.  [Ref. to AIR CONDITIONER>Evaporator>INSTALLATION.](#)
3. Install the heater unit assembly and the cover evaporator.
4. Install the air conditioner CM.  [Ref. to AIR CONDITIONER>Control Unit>INSTALLATION.](#)
5. Attach the heater core.  [Ref. to AIR CONDITIONER>Heater Core>INSTALLATION.](#)
6. Install the heater and cooling unit assembly.  [Ref. to AIR CONDITIONER>Heater and Cooling Unit>INSTALLATION.](#)
7. Connect the hose pressure suction on the expansion valve side.  [Ref. to AIR CONDITIONER>Hose and Pipe>INSTALLATION.](#)

8. Install the intercooler.  [Ref. to INTAKE \(INDUCTION\)\(H4DOTC\)>Intercooler>INSTALLATION.](#)
9. Install the beam steering COMPL and the instrument panel assembly.  [Ref. to EXTERIOR/INTERIOR TRIM>Instrument Panel Assembly>INSTALLATION.](#)
10. Connect the ground terminal to battery sensor.  [Ref. to REPAIR CONTENTS>NOTE > BATTERY.](#)
11. Fill engine coolant.  [Ref. to COOLING\(H4DOTC\)>Engine Coolant>REPLACEMENT > FILLING OF ENGINE COOLANT.](#)

AIR CONDITIONER > Evaporator Sensor

INSPECTION

1. Prepare the vehicle.
 - Place the vehicle in the workshop or in the shade and windless condition.
 - Open all windows.
 - Check that the ambient temperature is 25 — 40 °C (77 — 104 °F) and that the humidity is 30 — 80 %.

2. Set the vehicle to the following conditions.

Item	Condition
Engine	Idling
Air vent grille	Full open
A/C switch	OFF
Temperature setting	LO (MAX COOL)
FRESH/RECIRC position	RECIRC
Air flow control position	VENT
Fan speed	HI (MAX)

3. Using the Subaru Select Monitor, check the evaporator sensor.
 - (1) Display [Evaporator Temperature Target] on the [Data monitor] of [Air Conditioner].  [Ref. to COMMON \(DIAGNOSTICS\)>Data Monitor.](#)
 - (2) Idle the engine for 15 minutes, and then compare the air flow outlet temperature with [Evaporator Temperature Target].

Note:

For outlet opening temperature, measure the average temperature of center grille assembly and side grille assembly using a thermometer.

- (3) Is the difference between outlet opening temperature and [Evaporator Temperature Target] by 3°C (5.4°F) or more?
 - **Yes** → **Go to Step 4.**
 - **No** → Evaporator sensor is normal.
4. Check the evaporator sensor.
 - (1) Disconnect the connector.
 - (2) Measure the resistance between connector terminals.

BWT*BU

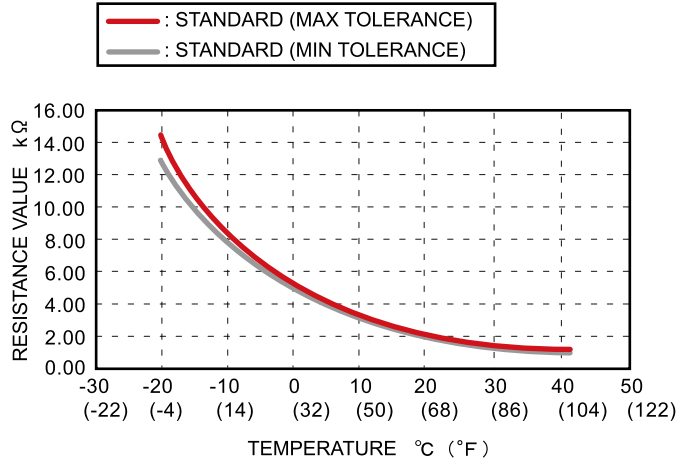
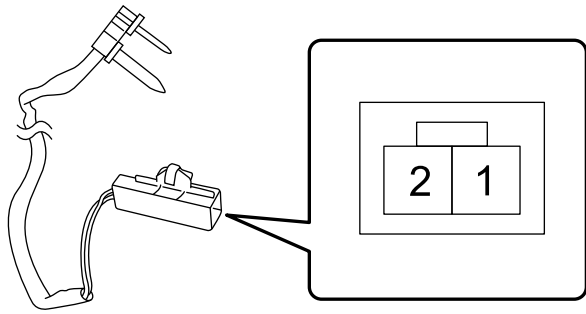

AC-11441



Terminal No.	Inspection conditions	Standard
1 - 2	-20°C (-4°F)	13.584 — 14.541 kΩ
	-15°C (5°F)	10.34 — 10.946 kΩ
	-10°C (14°F)	7.938 — 8.313 kΩ
	-5°C (23°F)	6.143 — 6.366 kΩ
	0°C (32°F)	4.79 — 4.914 kΩ
	5°C (41°F)	3.718 — 3.829 kΩ
	10°C (50°F)	2.889 — 3.031 kΩ
	15°C (59°F)	2.247 — 2.435 kΩ
	20°C (68°F)	1.785 — 1.952 kΩ
	25°C (77°F)	1.427 — 1.574 kΩ
	30°C (86°F)	1.149 — 1.278 kΩ
	35°C (95°F)	0.931 — 1.044 kΩ
	40°C (104°F)	0.759 — 0.858 kΩ

(3) Is the resistance within the standard?

- **Yes** → Evaporator sensor is normal.
- **No** → Replace the evaporator sensor.

AIR CONDITIONER > FRESH/RECIRC Door Actuator

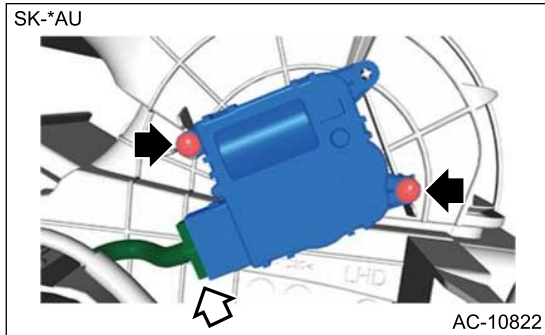

REMOVAL

1. Disconnect the ground terminal from battery sensor.  [Ref. to REPAIR CONTENTS>NOTE > BATTERY.](#)
2. Remove the pocket COMPL and the panel instrument passenger.  [Ref. to EXTERIOR/INTERIOR TRIM>Glove Box>REMOVAL > BACK PANEL.](#)
3. Remove the motor actuator intake.
 - (1) Disconnect the connector.
 - (2) Remove the screws, and remove the motor actuator intake.



AIR CONDITIONER > FRESH/RECIRC Door Actuator

INSTALLATION

1. Install the motor actuator intake and connect the connector.
2. Install the panel instrument passenger and pocket COMPL.  [Ref. to EXTERIOR/INTERIOR TRIM>Glove Box>INSTALLATION > BACK PANEL.](#)
3. Connect the ground terminal to battery sensor.  [Ref. to REPAIR CONTENTS>NOTE > BATTERY.](#)

AIR CONDITIONER > FRESH/RECIRC Door Actuator

INSPECTION

1. ACTUATOR LINK

1. Visually check the operating range of the link, and remove the foreign matter if any.
2. Operate the FRESH/RECIRC switch, and check that the link operates normally.
3. If it does not operate normally as the result of inspection, perform a unit inspection of motor actuator intake.

2. CHECK ACTUATOR

1. Check the actuator operation when battery voltage is applied between the connector terminals.

Caution:

Disconnect the battery immediately after the actuator stops operation. Otherwise, the motor may be damaged.

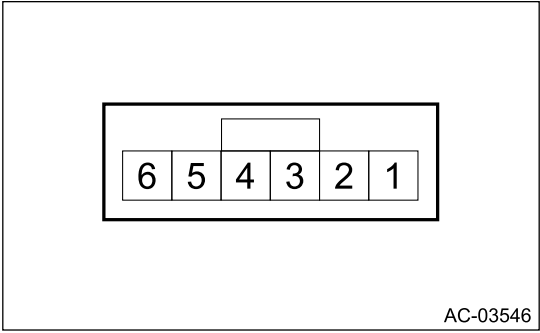

Terminal No.	Inspection conditions	Operating position
1 (+) – 2 (-)	Apply battery voltage.	FRESH
2 (+) – 1 (-)		RECIRC





2. If it is found defective as a result of inspection, replace the motor actuator intake.

AIR CONDITIONER > Mode Door Actuator

REMOVAL

Caution:

Before handling the airbag system components, refer to "CAUTION" of "General Description" in "AIRBAG SYSTEM".  [Ref. to AIRBAG SYSTEM>General Description>CAUTION.](#)

1. Disconnect the ground terminal from the battery sensor, and wait for at least 60 seconds before starting work.  [Ref. to REPAIR CONTENTS>NOTE > BATTERY.](#)
2. Remove the cover LWR driver.  [Ref. to EXTERIOR/INTERIOR TRIM>Instrument Panel Lower Cover>REMOVAL.](#)
3. Remove the knee airbag module.  [Ref. to AIRBAG SYSTEM>Knee Airbag Module>REMOVAL.](#)
4. Remove the duct foot driver.  [Ref. to AIR CONDITIONER>Air Vent Duct>REMOVAL > FOOT DUCT.](#)
5. Remove the motor actuator mode.
 - (1) Disconnect the connector.
 - (2) Release the lock by turning as shown in the figure, and remove the motor actuator mode.

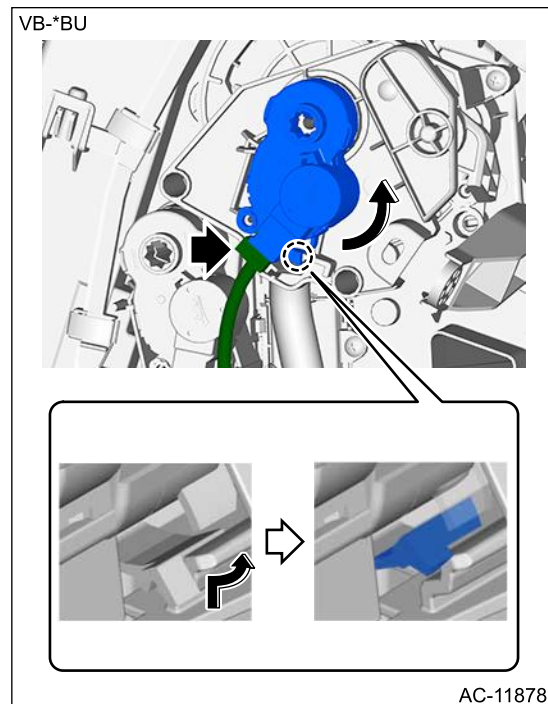

6. Remove the bracket actuator mode.

Note:

Perform this procedure only when required.

- (1) Remove the screws, and remove the bracket actuator mode.

VB-*BU

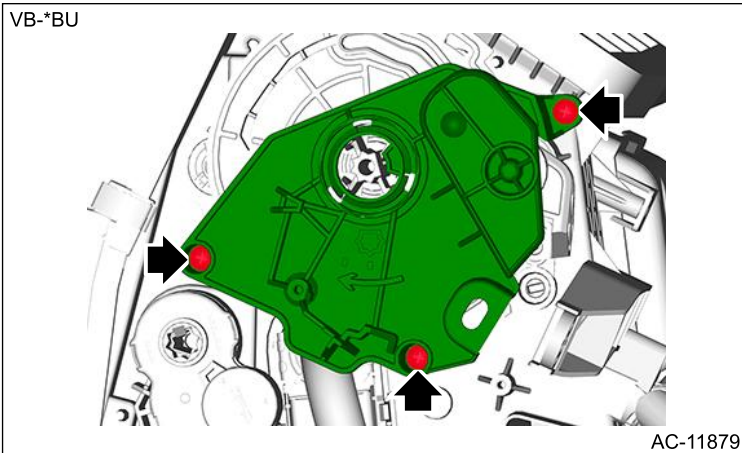

AC-11879

(2) Remove the levers.

AIR CONDITIONER > Mode Door Actuator

INSTALLATION

Caution:

Before handling the airbag system components, refer to "CAUTION" of "General Description" in "AIRBAG SYSTEM".  [Ref. to AIRBAG SYSTEM>General Description>CAUTION.](#)





1. When replacing the lever mode with a new part, apply a thin coat of grease evenly to the contact area inside the rail of lever mode by using approx. 5 mm (0.2 in) width and approx. 0.1 g (0.004 oz) of grease squeezed out from a tube.

Note:

After installing the actuator, perform 3 – 5 times of adaptation for the grease to fit in.

Preparation items:

Grease: SUBARU genuine grease (part No. 72129AJ000)

2. Install each lever and the bracket actuator mode.
3. Install the motor actuator mode and connect the connector.
4. Install the duct foot driver.  [Ref. to AIR CONDITIONER>Air Vent Duct>INSTALLATION > FOOT DUCT.](#)
5. Install the knee airbag module.  [Ref. to AIRBAG SYSTEM>Knee Airbag Module>INSTALLATION.](#)
6. Install the cover LWR driver.  [Ref. to EXTERIOR/INTERIOR TRIM>Instrument Panel Lower Cover>INSTALLATION.](#)
7. Connect the ground terminal to battery sensor.  [Ref. to REPAIR CONTENTS>NOTE > BATTERY.](#)

AIR CONDITIONER > Mode Door Actuator

INSPECTION

1. ACTUATOR LINK

1. Visually check the operating range of the link, and remove the foreign matter if any.
2. Operate the air flow control dial or switch to check that the link operates normally.

3. If it does not operate normally as the result of inspection, perform a unit inspection of motor actuator mode.

2. CHECK ACTUATOR OPERATION

1. Measure the resistance between connector terminals.

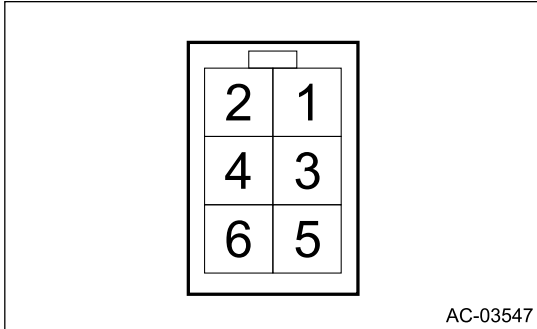

Terminal No.	Inspection conditions	Standard
3 – 1	Always	80 – 100 Ω
3 – 2		
3 – 5		
3 – 6		

2. Replace the motor actuator mode if the inspection result is not within the standard value.

AIR CONDITIONER > Air Mix Door Actuator

REMOVAL

1. DRIVER'S SIDE

Caution:

Before handling the airbag system components, refer to "CAUTION" of "General Description" in "AIRBAG SYSTEM". [Ref. to AIRBAG SYSTEM>General Description>CAUTION.](#)

1. Disconnect the ground terminal from the battery sensor, and wait for at least 60 seconds before starting work. [Ref. to REPAIR CONTENTS>NOTE > BATTERY.](#)
2. Remove the cover LWR driver. [Ref. to EXTERIOR/INTERIOR TRIM>Instrument Panel Lower Cover>REMOVAL.](#)
3. Remove the knee airbag module. [Ref. to AIRBAG SYSTEM>Knee Airbag Module>REMOVAL.](#)
4. Remove the duct foot driver. [Ref. to AIR CONDITIONER>Air Vent Duct>REMOVAL > FOOT DUCT.](#)
5. Remove the motor actuator air mix.
 - (1) Disconnect the connector.
 - (2) Release the lock by turning as shown in the figure, and remove the motor actuator air mix.

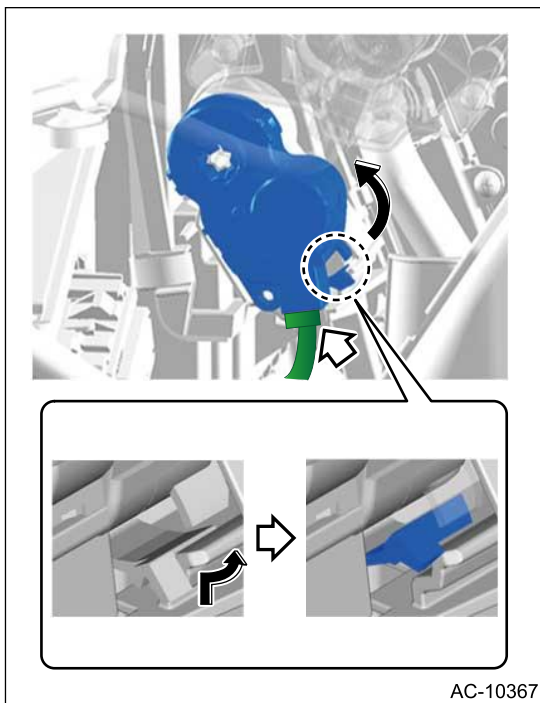

2. PASSENGER'S SIDE

1. Disconnect the ground terminal from battery sensor. [Ref. to REPAIR CONTENTS>NOTE > BATTERY.](#)
2. Remove the pocket COMPL and the panel instrument passenger. [Ref. to EXTERIOR/INTERIOR TRIM>Glove Box>REMOVAL > BACK PANEL.](#)
3. Remove the duct foot passenger. [Ref. to AIR CONDITIONER>Air Vent Duct>REMOVAL > FOOT DUCT.](#)
4. Remove the motor actuator air mix.

- (1) Put the alignment marks on the engaging portion of the lever mix and motor actuator air mix.
- (2) Disconnect the connector.
- (3) Remove the screws and remove the motor actuator air mix.

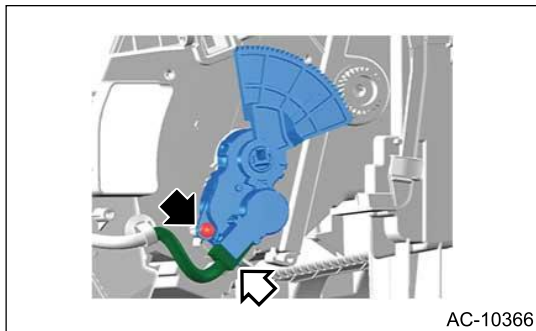





AIR CONDITIONER > Air Mix Door Actuator

INSTALLATION

1. DRIVER'S SIDE

Caution:

Before handling the airbag system components, refer to "CAUTION" of "General Description" in "AIRBAG SYSTEM".  [Ref. to AIRBAG SYSTEM>General Description>CAUTION.](#)



1. Install the motor actuator air mix and connect the connector.
2. Install the duct foot driver.  [Ref. to AIR CONDITIONER>Air Vent Duct>INSTALLATION > FOOT DUCT.](#)
3. Install the knee airbag module.  [Ref. to AIRBAG SYSTEM>Knee Airbag Module>INSTALLATION.](#)
4. Install the cover LWR driver.  [Ref. to EXTERIOR/INTERIOR TRIM>Instrument Panel Lower Cover>INSTALLATION.](#)
5. Connect the ground terminal to battery sensor.  [Ref. to REPAIR CONTENTS>NOTE > BATTERY.](#)

2. PASSENGER'S SIDE

1. Install the motor actuator air mix and connect the connector.

Note:

Align the alignment mark of the lever with that of the motor actuator air mix.

2. Install the duct foot passenger.  [Ref. to AIR CONDITIONER>Air Vent Duct>INSTALLATION > FOOT DUCT.](#)
3. Install the panel instrument passenger and pocket COMPL.  [Ref. to EXTERIOR/INTERIOR TRIM>Glove Box>INSTALLATION > BACK PANEL.](#)
4. Connect the ground terminal to battery sensor.  [Ref. to REPAIR CONTENTS>NOTE > BATTERY.](#)

AIR CONDITIONER > Air Mix Door Actuator

INSPECTION

1. ACTUATOR LINK

1. Visually check the operating range of the link, and remove the foreign matter if any.
2. Operate the temperature setting to check that the link operates normally.
3. If it does not operate normally as the result of inspection, perform a unit inspection of motor actuator air mix.

2. CHECK ACTUATOR OPERATION

1. Measure the resistance between connector terminals.

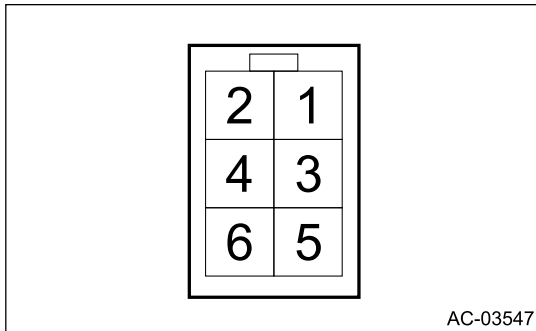



Terminal No.	Inspection conditions	Standard
3 – 1	Always	80 – 100 Ω
3 – 2		
3 – 5		
3 – 6		

2. Replace the motor actuator air mix if the inspection result is not within the standard value.

AIR CONDITIONER > Air Vent Grille

REMOVAL

1. CENTER GRILLE

1. Disconnect the ground terminal from battery sensor.  [Ref. to REPAIR CONTENTS>NOTE > BATTERY.](#)
2. Remove the panel assembly center.  [Ref. to EXTERIOR/INTERIOR TRIM>Centor Cluster>REMOVAL.](#)
3. Release the screw and claws, and then remove the grille ventilation assembly center RH and LH.

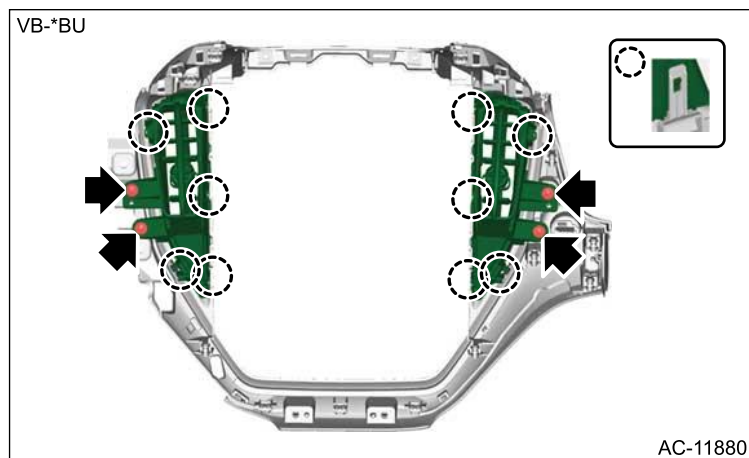

2. SIDE GRILLE

• DRIVER'S SIDE

1. Remove the clips, and remove the cover assembly instrument panel side LH.

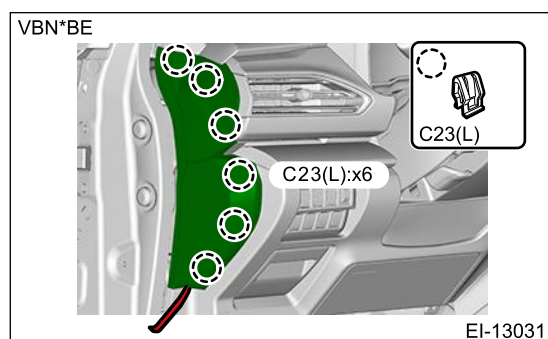

2. Release the clips, and remove the ornament panel mid driver.

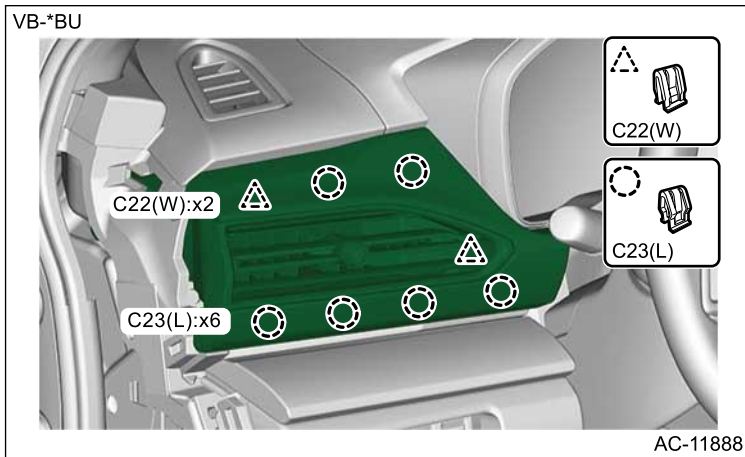

3. Remove the screws and release and clips, then detach the grille ventilation side.

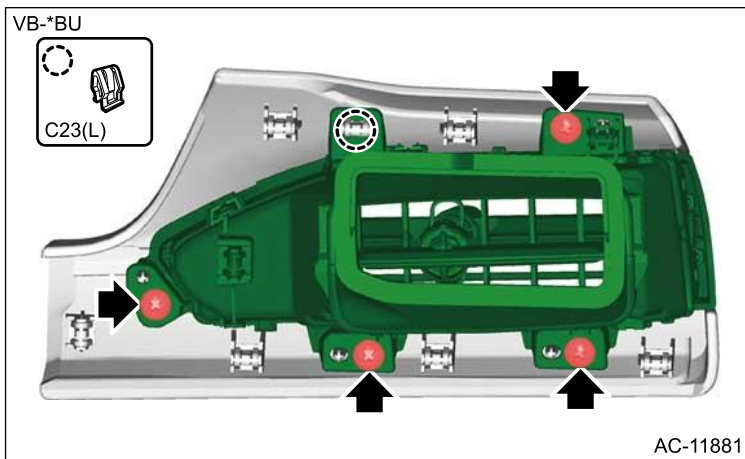

● **PASSENGER'S SIDE**

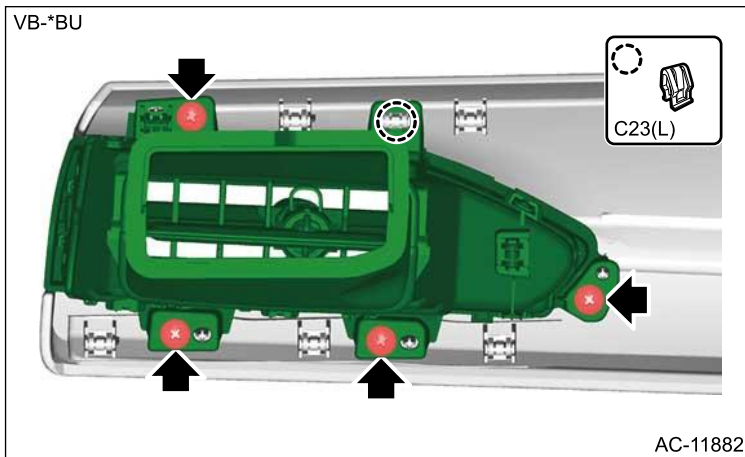

- 1.** Remove the cover assembly instrument panel side RH and the ornament panel mid passenger. 
[Ref. to EXTERIOR/INTERIOR TRIM>Centor Cluster>REMOVAL.](#)
- 2.** Remove the screws and release and clips, then detach the grille ventilation side.



AIR CONDITIONER > Air Vent Grille

INSTALLATION

1. CENTER GRILLE

1. Install the grille ventilation assembly center.
2. Install the panel assembly center.  [Ref. to EXTERIOR/INTERIOR TRIM>Centor Cluster>INSTALLATION.](#)
3. Connect the ground terminal to battery sensor.  [Ref. to REPAIR CONTENTS>NOTE > BATTERY.](#)

2. SIDE GRILLE

Note:

Make sure that the grille assembly is inserted into the air vent duct correctly.

• DRIVER'S SIDE

1. Install the grille ventilation side.
2. Install the ornament panel mid driver.
3. Install the cover assembly instrument panel side LH.

• PASSENGER'S SIDE

1. Install the grille ventilation side.
2. Install the ornament panel mid passenger and cover assembly instrument panel side RH.  [Ref. to EXTERIOR/INTERIOR TRIM>Centor Cluster>INSTALLATION.](#)

AIR CONDITIONER > Air Vent Grille

INSPECTION

1. Check that the direction and the amount of air can be adjusted smoothly. Replace the grille assembly if faulty.
2. Check that the adjustment can be maintained in each position. Replace the grille assembly if faulty.

AIR CONDITIONER > Air Vent Duct



REMOVAL

1. FRONT DUCT

For the procedure of the front duct, refer to "Instrument Panel Assembly" of "EXTERIOR/INTERIOR TRIM" section.  [Ref. to EXTERIOR/INTERIOR TRIM>Instrument Panel Assembly>DISASSEMBLY.](#)

2. REAR DUCT

● FRONT



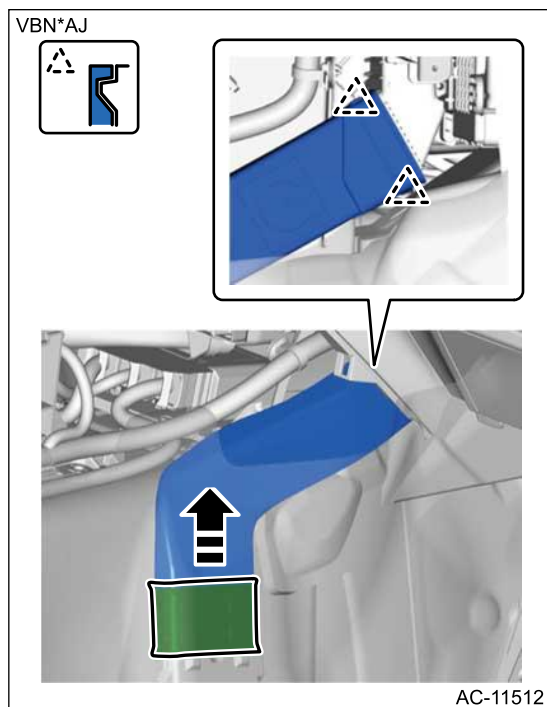







1. Disconnect the ground terminal from battery sensor.  [Ref. to REPAIR CONTENTS>NOTE > BATTERY.](#)
2. Remove the console box assembly.  [Ref. to EXTERIOR/INTERIOR TRIM>Console Box>REMOVAL.](#)
3. Remove the cover center side.  [Ref. to EXTERIOR/INTERIOR TRIM>Center Console>REMOVAL.](#)
4. Remove the duct rear heater front.
 - (1) Remove the slide lock.
 - (2) Release the claws, and remove the duct rear heater front.



● REAR

Caution:

- Before handling the airbag system components, refer to "CAUTION" of "General Description" in "AIRBAG SYSTEM".  [Ref. to AIRBAG SYSTEM>General Description>CAUTION.](#)
- Side impact sensor (under the rear center seat) for the airbag system is located under the front center of the rear seat cushion. Be careful not to apply strong impact to the sensor when working with the rear seat cushion removed.

1. Disconnect the ground terminal from the battery sensor, and wait for at least 60 seconds before starting work.  [Ref. to REPAIR CONTENTS>NOTE > BATTERY.](#)
2. Remove the front seat assembly.  [Ref. to SEATS>Front Seat>REMOVAL.](#)
3. Remove the cover side sill front Rr and the cover side sill front Ft on the left and right sides.  [Ref. to EXTERIOR/INTERIOR TRIM>Lower Inner Trim>REMOVAL.](#)
4. Remove the rear seat cushion assembly.  [Ref. to SEATS>Rear Seat>REMOVAL.](#)
5. Remove the cover side sill rear UPR on the left and right sides.  [Ref. to EXTERIOR/INTERIOR TRIM>Lower Inner Trim>REMOVAL.](#)
6. Remove the console box assembly.  [Ref. to EXTERIOR/INTERIOR TRIM>Console Box>REMOVAL.](#)
7. Remove the right and left cover center sides.  [Ref. to EXTERIOR/INTERIOR TRIM>Center Console>REMOVAL.](#)
8. Remove the damper CM. (Electronically-controlled damper model)  [Ref. to FRONT SUSPENSION>Suspension Control Module>REMOVAL.](#)
9. Remove the power amplifier assembly and the extension duct. (Model with power amplifier)  [Ref. to ENTERTAINMENT & MONITORING>Power Amplifier>REMOVAL.](#)
10. Turn over the floor mat.  [Ref. to EXTERIOR/INTERIOR TRIM>Floor Mat>REMOVAL.](#)

Note:

Remove the clips necessary for removing the duct rear heater rear.

11. Remove the duct rear heater front.  [Ref. to AIR CONDITIONER>Air Vent Duct>REMOVAL > REAR DUCT.](#)
12. Release the claws, and then remove the duct rear heater rear.





3. FOOT DUCT

• DRIVER'S SIDE

Caution:

Before handling the airbag system components, refer to "CAUTION" of "General Description" in "AIRBAG SYSTEM".  [Ref. to AIRBAG SYSTEM>General Description>CAUTION.](#)

1. Disconnect the ground terminal from the battery sensor, and wait for at least 60 seconds before starting work.  [Ref. to REPAIR CONTENTS>NOTE > BATTERY.](#)
2. Remove the cover LWR driver.  [Ref. to EXTERIOR/INTERIOR TRIM>Instrument Panel Lower Cover>REMOVAL.](#)
3. Remove the knee airbag module.  [Ref. to AIRBAG SYSTEM>Knee Airbag Module>REMOVAL.](#)
4. Remove the duct foot driver.



Caution:

If the duct foot driver is detached from the spacer foot, replace the duct foot driver with a new part. If the duct foot driver is reused, the holding force of the claws and clips is reduced and the part may come off.

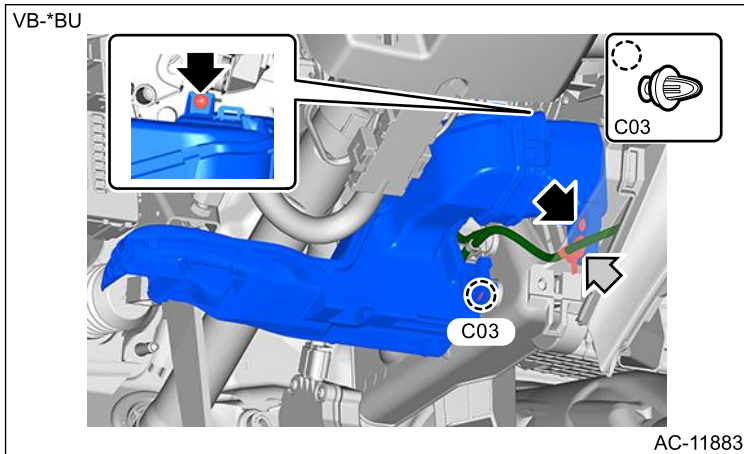
- (1) Remove the harness clip.
- (2) Release the screws and clips that secure the spacer foot.
- (3) Remove the duct foot driver together with the spacer foot.



● **PASSENGER'S SIDE**

1. Disconnect the ground terminal from battery sensor.  [Ref. to REPAIR CONTENTS>NOTE > BATTERY.](#)
2. Remove the pocket COMPL and the panel instrument passenger.  [Ref. to EXTERIOR/INTERIOR TRIM>Glove Box>REMOVAL > BACK PANEL.](#)
3. Remove the screws and remove the duct foot passenger.

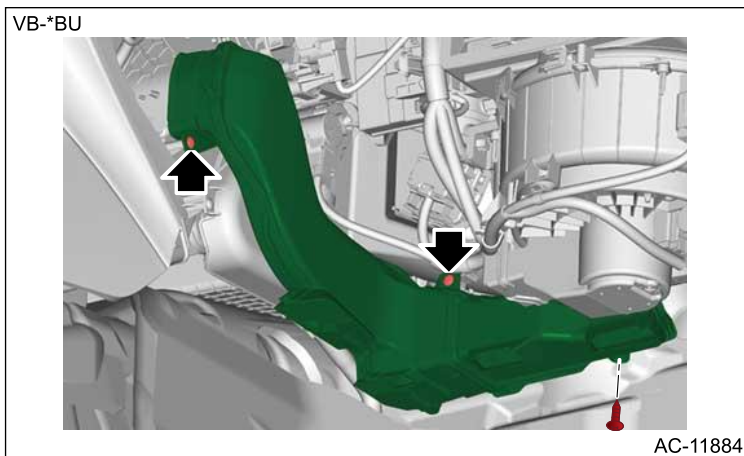

AIR CONDITIONER > Air Vent Duct



INSTALLATION

1. FRONT DUCT

For the procedure of the front duct, refer to "Instrument Panel Assembly" of "EXTERIOR/INTERIOR TRIM" section.  [Ref. to EXTERIOR/INTERIOR TRIM>Instrument Panel Assembly>ASSEMBLY.](#)

2. REAR DUCT













• FRONT

1. Install the duct rear heater front.
2. Install the cover center side.  [Ref. to EXTERIOR/INTERIOR TRIM>Center Console>INSTALLATION.](#)
3. Install the console box assembly.  [Ref. to EXTERIOR/INTERIOR TRIM>Console Box>INSTALLATION.](#)
4. Connect the ground terminal to battery sensor.  [Ref. to REPAIR CONTENTS>NOTE > BATTERY.](#)

• REAR

Caution:

Before handling the airbag system components, refer to "CAUTION" of "General Description" in "AIRBAG SYSTEM".  [Ref. to AIRBAG SYSTEM>General Description>CAUTION.](#)

1. Install the duct rear heater rear.
2. Install the duct rear heater front.
3. Install the floor mat.  [Ref. to EXTERIOR/INTERIOR TRIM>Floor Mat>INSTALLATION.](#)
4. Install the extension duct and the power amplifier assembly. (Model with power amplifier)  [Ref. to ENTERTAINMENT & MONITORING>Power Amplifier>INSTALLATION.](#)
5. Install the damper CM. (Electronically-controlled damper model)  [Ref. to FRONT SUSPENSION>Suspension Control Module>INSTALLATION.](#)
6. Install the cover center side.  [Ref. to EXTERIOR/INTERIOR TRIM>Center Console>INSTALLATION.](#)
7. Install the console box assembly.  [Ref. to EXTERIOR/INTERIOR TRIM>Console Box>INSTALLATION.](#)
8. Install the cover side sill rear UPR.  [Ref. to EXTERIOR/INTERIOR TRIM>Lower Inner Trim>INSTALLATION.](#)
9. Install the rear seat cushion assembly.  [Ref. to SEATS>Rear Seat>INSTALLATION.](#)
10. Install the cover side sill front Ft and the cover side sill front Rr.  [Ref. to EXTERIOR/INTERIOR TRIM>Lower Inner Trim>INSTALLATION.](#)
11. Install the front seat.  [Ref. to SEATS>Front Seat>INSTALLATION.](#)
12. Connect the ground terminal to battery sensor.  [Ref. to REPAIR CONTENTS>NOTE > BATTERY.](#)
13. Regarding the front seat (passenger's seat), perform [Rezeroing] for the occupant detection system.  [Ref. to AIRBAG SYSTEM>Rezero.](#)
14. Regarding the front seat (passenger's seat), perform "Occupant Detection System Inspection" to check if the occupant detection system operates normally.  [Ref. to SEAT BELT SYSTEM>Seat Belt Warning System>INSPECTION.](#)

3. FOOT DUCT

• DRIVER'S SIDE



Caution:

Before handling the airbag system components, refer to "CAUTION" of "General Description" in "AIRBAG SYSTEM".  [Ref. to AIRBAG SYSTEM>General Description>CAUTION.](#)

1. Install the duct foot driver.

Caution:

If the duct foot driver is detached from the spacer foot, replace the duct foot driver with a new part. If the duct foot driver is reused, the holding force of the claws and clips is reduced and the part may come off.

2. Install the knee airbag module.  [Ref. to AIRBAG SYSTEM>Knee Airbag Module>INSTALLATION.](#)
3. Install the cover LWR driver.  [Ref. to EXTERIOR/INTERIOR TRIM>Instrument Panel Lower Cover>INSTALLATION.](#)
4. Connect the ground terminal to battery sensor.  [Ref. to REPAIR CONTENTS>NOTE > BATTERY.](#)

● **PASSENGER'S SIDE**

1. Install the duct foot passenger.
2. Install the panel instrument passenger and pocket COMPL.  [Ref. to EXTERIOR/INTERIOR TRIM>Glove Box>INSTALLATION > BACK PANEL.](#)
3. Connect the ground terminal to battery sensor.  [Ref. to REPAIR CONTENTS>NOTE > BATTERY.](#)

AIR CONDITIONER > Air Vent Duct

INSPECTION

1. Check installation condition of duct. Connect the duct properly if defective.
2. Check that no foreign matter is mixed in the duct. Remove the foreign matter if any.

AIR CONDITIONER > A/C Filter

REPLACEMENT

1. Remove the pocket COMPL.  [Ref. to EXTERIOR/INTERIOR TRIM>Glove Box>REMOVAL.](#)
2. Remove the filter.
(1) Release the lock and remove the filter as shown in the figure.

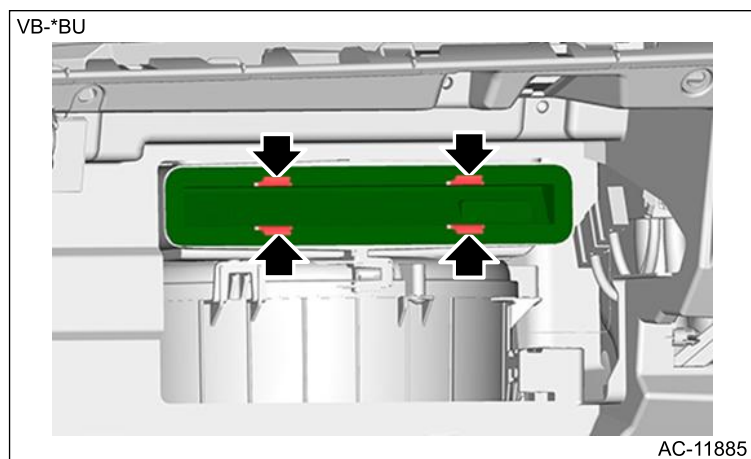

Note:

Slowly pull out while tilting the front side of the filter downward to prevent dirt or dust from falling inside the case.

3. Install a new filter.
4. Install the pocket COMPL.  [Ref. to EXTERIOR/INTERIOR TRIM>Glove Box>INSTALLATION.](#)

AIR CONDITIONER > A/C Filter

INSPECTION

Check the A/C filter for dust or dirt, and clean or replace as necessary.

AIR CONDITIONER > Diagnostics with Phenomenon

INSPECTION

For the diagnostics with phenomenon, refer to "Diagnostics with Phenomenon" of "AIR CONDITIONER (DIAGNOSTICS)".  [Ref. to AIR CONDITIONER\(DIAGNOSTICS\)>Diagnostics with Phenomenon.](#)