



FRONT SUSPENSION

FS

-
1. General Description
 2. Wheel Alignment
 3. Crossmember Support
 4. Stabilizer
 5. Front Arm
 6. Crossmember
 7. Front Strut
 8. Suspension Control Module
 9. G Sensor
 10. General Diagnostic Table

FRONT SUSPENSION > General Description

CAUTION

- When performing service operation, refer to "Repair Contents" in "General Description".  [Ref. to REPAIR CONTENTS>Repair Contents.](#)
- When performing any work, always wear work clothes, a work cap and protective shoes. Additionally, wear a helmet, protective goggles, etc. if necessary.
- When performing a repair, identify the cause of trouble and avoid unnecessary removal, disassembly and replacement.
- Do not secure a part in a vise directly. Place cushioning materials such as wood blocks, aluminum plates, or waste cloth between the part and the vise.
- Be sure that the surface of brake disc and brake pad is free from grease or oil.
- When performing work on the sensors or modules, be careful of the following.
 - Before disconnecting electrical connectors, be sure to disconnect the ground terminal from the battery sensor.  [Ref. to REPAIR CONTENTS>NOTE > BATTERY.](#)
 - Do not apply any impact. If the parts are accidentally dropped, replace with a new part.
 - Do not expose to high-temperature and humidity.
- When replacing the parts provided with memory functions, record the memory contents before disconnecting the ground terminal from the battery sensor.
- Some vehicle components are extremely hot immediately after driving. Be wary of receiving burns from heated parts.
- When handling oil or fuel, adhere to the following to prevent unexpected accident.
 - Be careful with fire.
 - Prepare a container to catch grease or oil, etc. If any grease or oil spills, wipe it off and clean immediately to prevent from penetrating into floor or flowing outside.
 - Follow all government and local regulations concerning disposal of refuse when disposing.
- Before starting works, remove dirt and corrosion around the target area.

FRONT SUSPENSION > General Description

SPECIFICATION

Note:

- **Adjustment must be within the adjustment value, taking aging variation into consideration.**  [Ref. to FRONT SUSPENSION>Wheel Alignment>ADJUSTMENT.](#)
- **Front toe-in, rear toe-in and front camber can be adjusted. Adjust if the value of toe-in or camber exceeds the tolerance range of the specification chart.**
- **Other items except for front toe-in, rear toe-in and front camber that are described in the specification chart cannot be adjusted.**
- **If other items exceed the tolerance range of the specification chart, check the suspension parts and connections for deformation. If defective, replace them.**

1. FRONT WHEEL ALIGNMENT (INSPECTION VALUE)

Suspension height (Tolerance: +24 mm _{-12 mm} (+0.94 in _{-0.47 in}))	mm (in)	138 (5.43)
--	---------	------------

Camber (tolerance: $\pm 45'$ Differences between RH and LH: 45' or less)		$-0^{\circ}40'$
Caster (referential value)		$6^{\circ}00'$
Steering angle (tolerance: $\pm 1.5^{\circ}$)	Inner wheel	37.1°
	Outer wheel	32.7°
Toe-in	mm (in)	0 ± 3 (0 ± 0.12) Toe angle (sum of both wheels): $0^{\circ} \pm 15'$
Kingpin angle (referential value)		$14^{\circ}35'$

A – B = Positive: Toe-in, Negative: Toe-out
 α = Individual toe angles

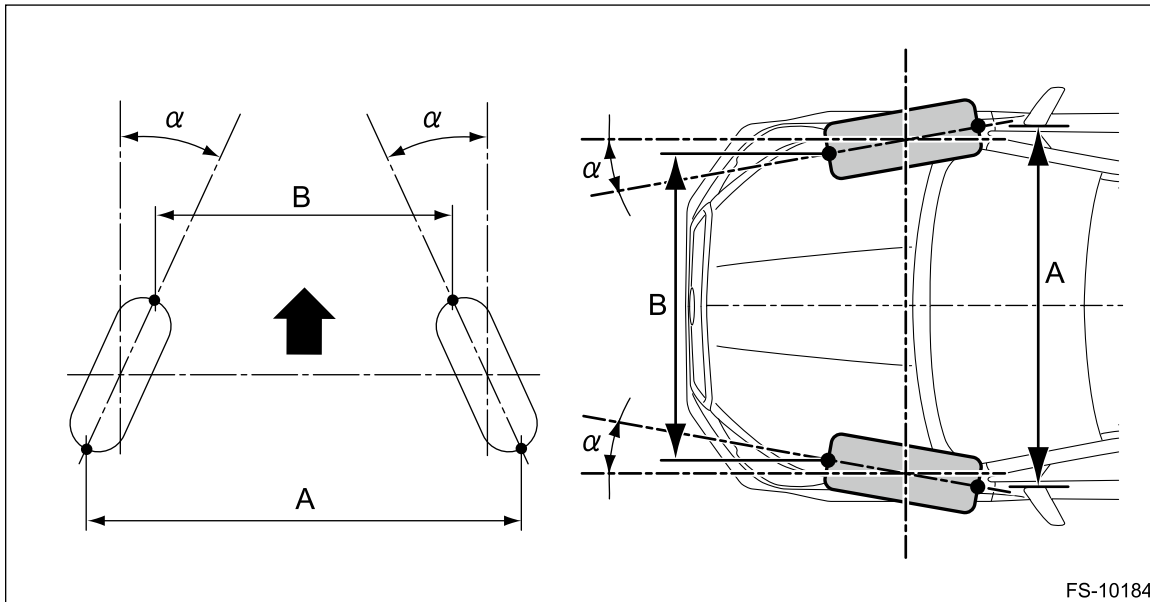

2. REAR WHEEL ALIGNMENT (INSPECTION VALUE)

Suspension height (Tolerance: $+24 \text{ mm}$ -12 mm ($+0.94 \text{ in}$ -0.47 in))		mm (in)	-9 (-0.35)
Camber (tolerance: $\pm 45'$ Differences between RH and LH: 45' or less)			$-1^{\circ}35'$
Toe-in	mm (in)	3 ± 3 (0.12 ± 0.12) Toe angle (sum of both wheels): $0^{\circ}16' \pm 15'$	
Thrust angle (tolerance: $\pm 30'$)			$0^{\circ}00'$

A – B = Positive: Toe-in, Negative: Toe-out
 α = Individual toe angles

SK-*AE

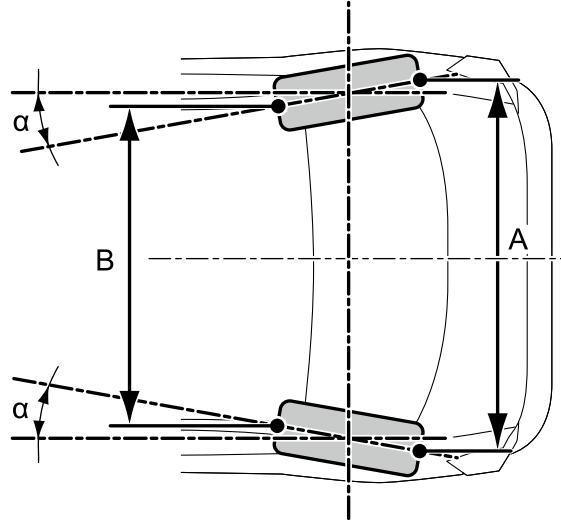
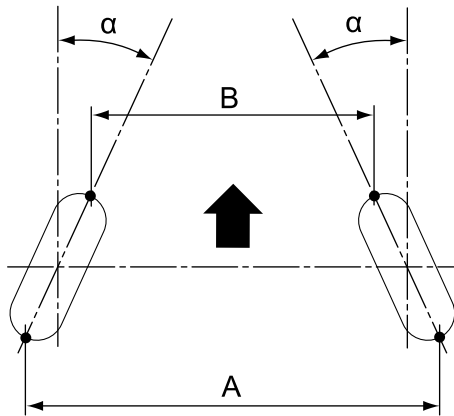

RS-10172

FRONT SUSPENSION > General Description

COMPONENT

1. FRONT SUSPENSION

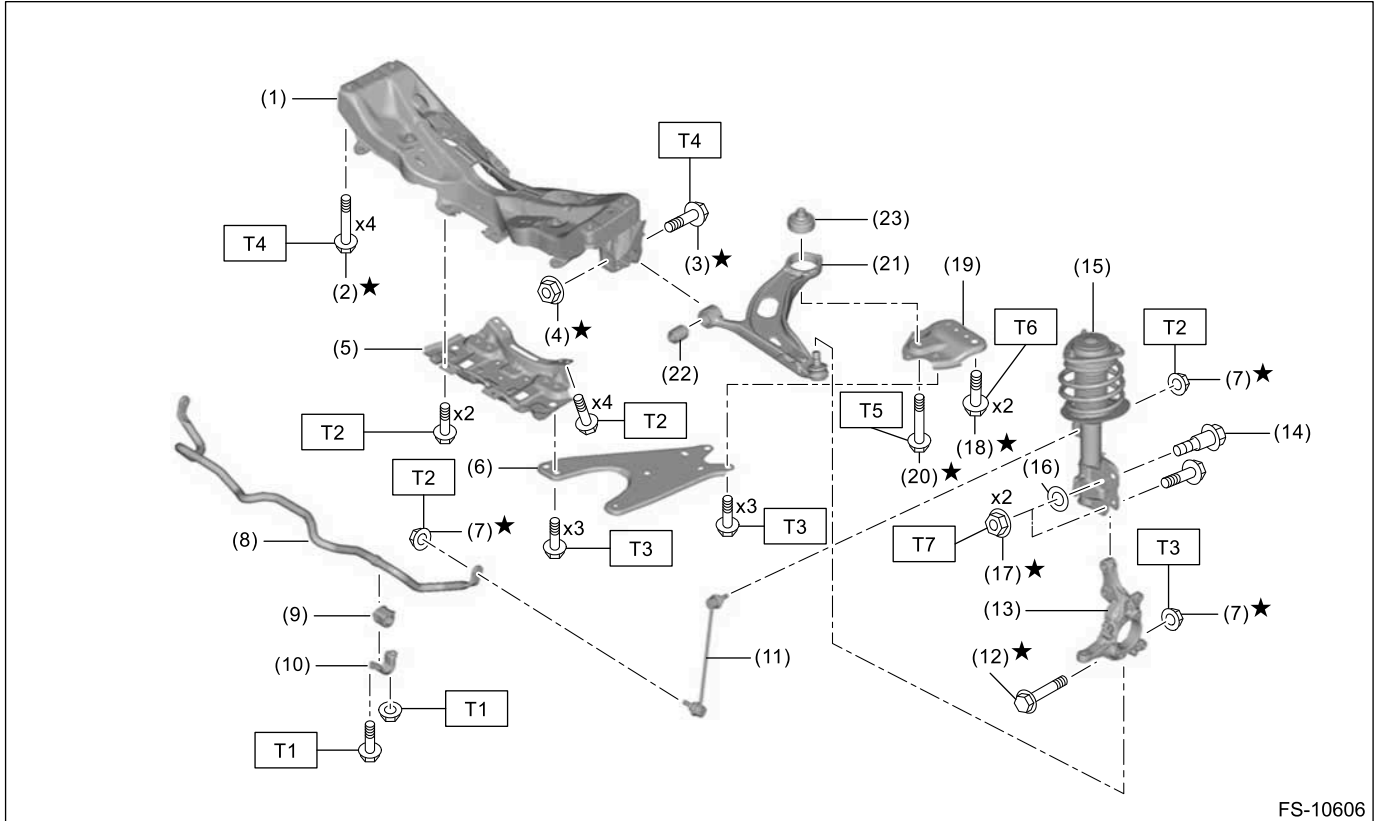

- | | |
|-------------------------------------|-------------------------------|
| (1) Crossmember COMPL front | (13) Front axle housing LH |
| (2) Flange bolt | (14) Adjusting bolt |
| (3) Flange bolt | (15) Strut ASSY LH |
| (4) Self-locking nut | (16) Adjusting washer |
| (5) Crossmember support front | (17) Flange nut |
| (6) Crossmember support rear LH | (18) Flange bolt |
| (7) Flange nut | (19) Front arm rear plate LH |
| (8) Stabilizer front | (20) Flange bolt |
| (9) Rubber bushing stabilizer front | (21) Arm ASSY front LH |
| (10) Clamp stabilizer | (22) Rubber bushing arm front |
| (11) Stabilizer link front LH | (23) Pillow ball bushing |
| (12) Flange bolt | |

Tightening torque: N-m (kgf-m, ft-lb)

- T1: 25 (2.5, 18.4)**
T2: 60 (6.1, 44.3)
T3: 70 (7.1, 51.6)
T4: 95 (9.7, 70.1)
T5: 140 (14.3, 103.3)
T6: 150 (15.3, 110.6)
T7: 155 (15.8, 114.3)

2. FRONT STRUT

• STANDARD DAMPER MODEL

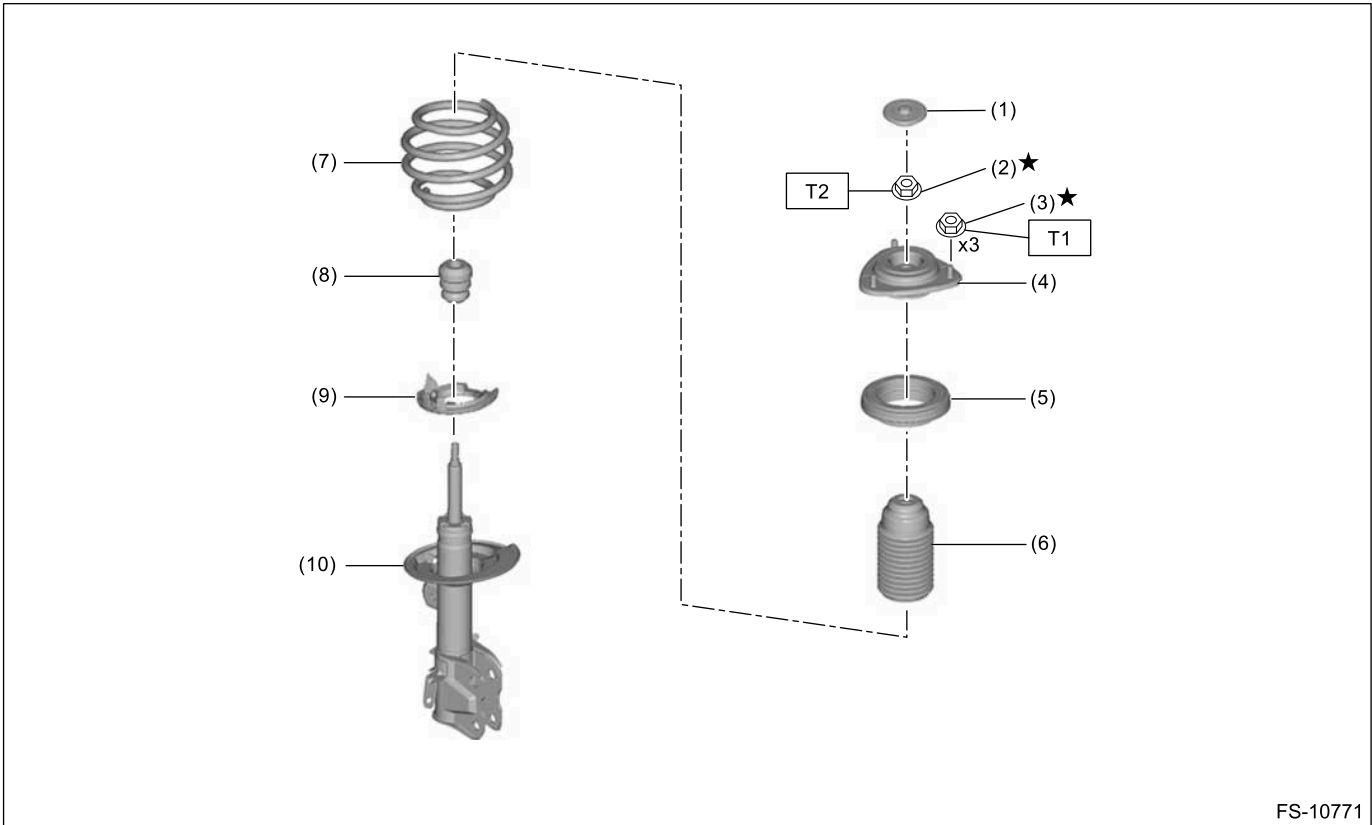

FS-10771

- | | |
|-------------------------|------------------------|
| (1) Dust seal | (6) Dust cover front |
| (2) Self-locking nut | (7) Coil spring front |
| (3) Flange nut | (8) Helper front |
| (4) Mount strut front | (9) Rubber seat LWR |
| (5) Mount bearing front | (10) Strut COMPL front |

Tightening torque: N·m (kgf·m, ft·lb)

T1: 32 (3.3, 23.6)

T2: 55 (5.6, 40.6)

● **ELECTRONICALLY-CONTROLLED DAMPER MODEL**

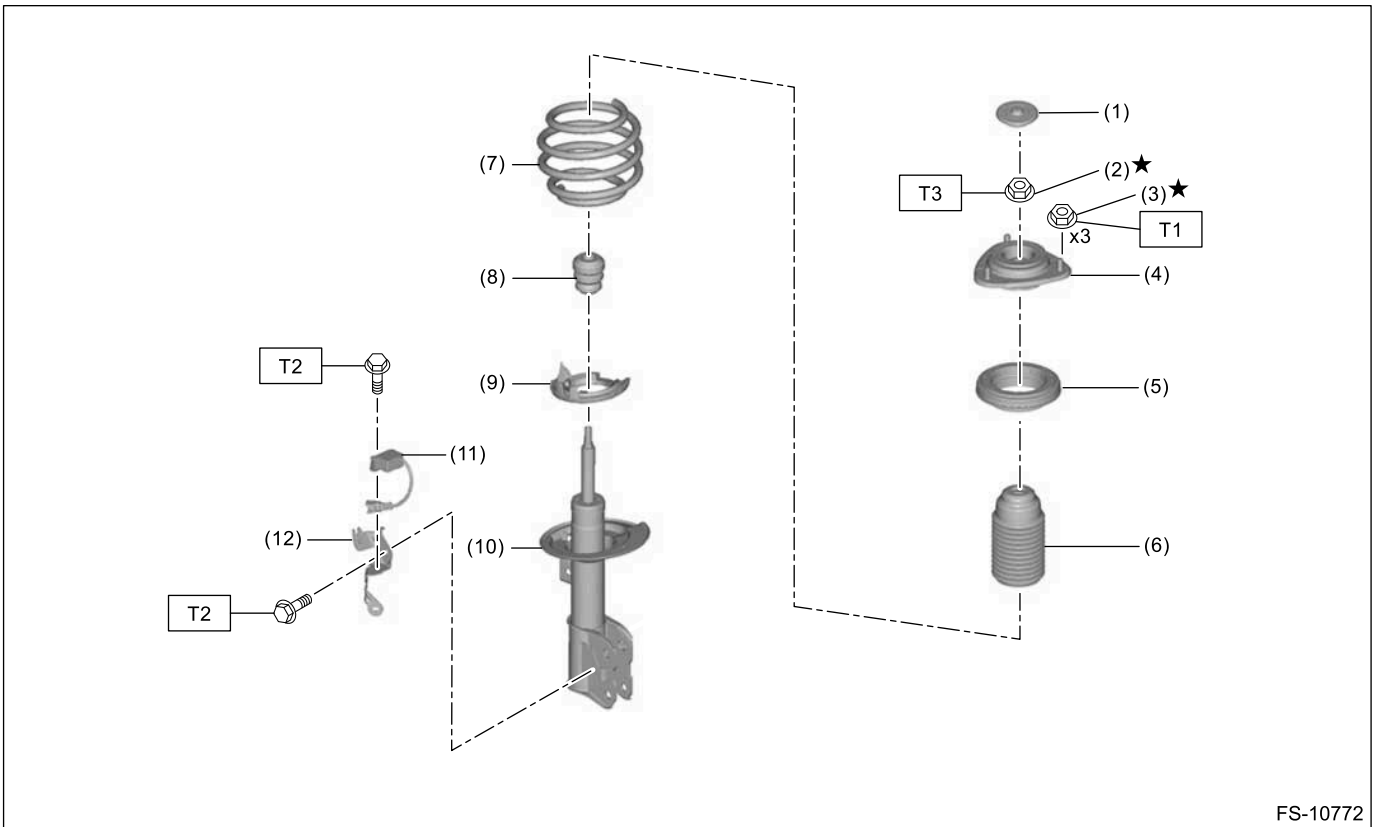

FS-10772

- | | |
|-------------------------|------------------------|
| (1) Dust seal | (7) Coil spring front |
| (2) Self-locking nut | (8) Helper front |
| (3) Flange nut | (9) Rubber seat LWR |
| (4) Mount strut front | (10) Strut COMPL front |
| (5) Mount bearing front | (11) G sensor |
| (6) Dust cover front | (12) Harness bracket |

Tightening torque: N·m (kgf-m, ft-lb)

T1: 32 (3.3, 23.6)

T2: 33 (3.4, 24.3)

T3: 55 (5.6, 40.6)

3. CONTROL MODULE

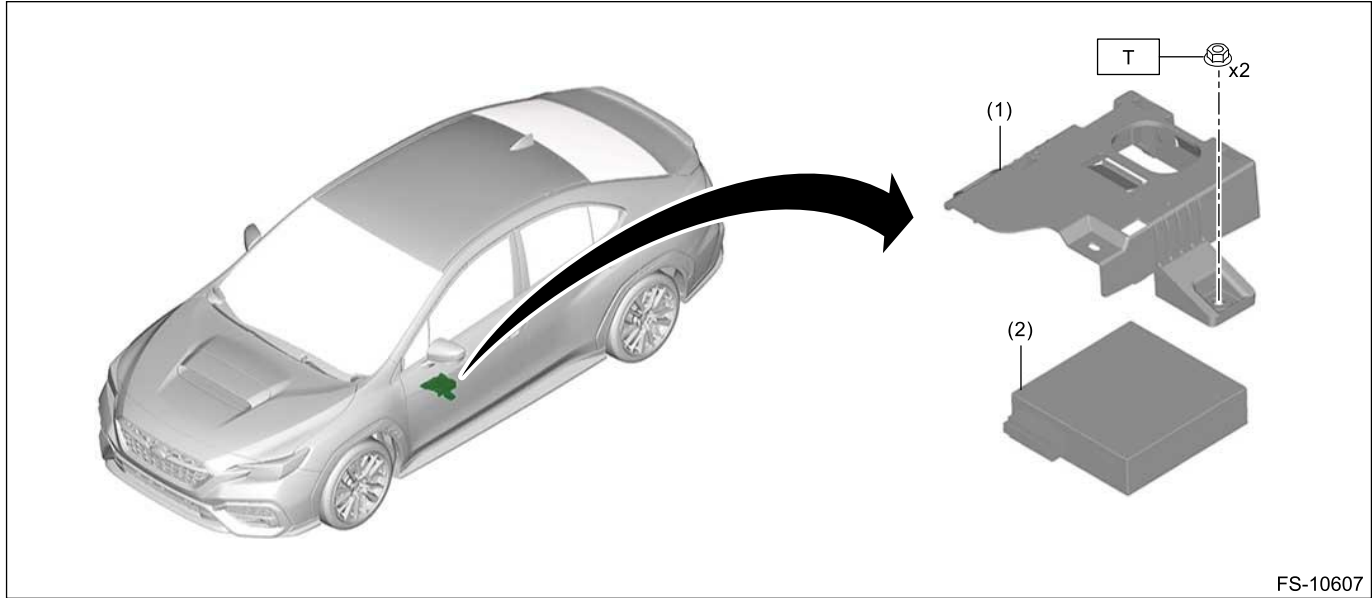

(1) Bracket damper CM

(2) Damper CM

Tightening torque: N-m (kgf-m, ft-lb)

T: 7.5 (0.8, 5.5)

FRONT SUSPENSION > General Description

PREPARATION TOOL

1. SUBARU SPECIAL TOOL

ILLUSTRATION	TOOL NUMBER	DESCRIPTION	REMARKS
<p>ST18360AA040</p>	18360AA040	HANGER	<ul style="list-style-type: none"> Used for removing and installing crossmember COMPL front. Used together with BOLT (18363AA050).
<p>ST18363AA050</p>	18363AA050	BOLT	<ul style="list-style-type: none"> Used for removing and installing crossmember COMPL front. Used together with HANGER (18360AA040).

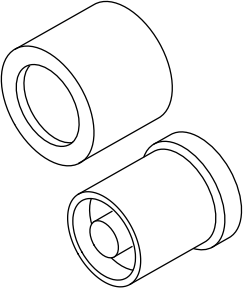
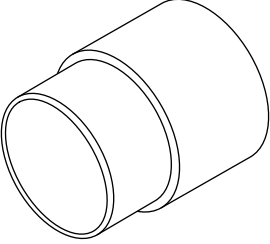
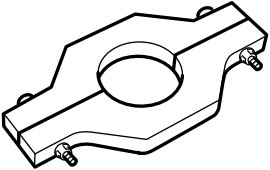
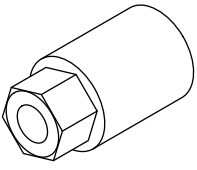
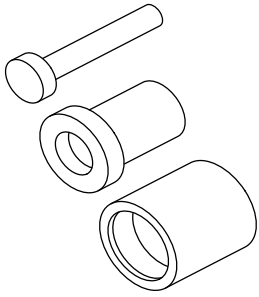

ILLUSTRATION	TOOL NUMBER	DESCRIPTION	REMARKS
 <p data-bbox="305 512 444 533">ST20099AE020</p>	20099AE020	INSTALLER & REMOVER	Used for removing and installing the front arm pillow ball bushing.
 <p data-bbox="305 894 444 915">ST28099PA010</p>	28099PA010	HOUSING STAND	<ul data-bbox="948 569 1422 716" style="list-style-type: none"> • Used for removing the front arm pillow ball bushing. • Used together with INSTALLER & REMOVER (20099AE020).
 <p data-bbox="305 1272 444 1293">ST18723AA000</p>	18723AA000	REMOVER	<ul data-bbox="948 947 1422 1094" style="list-style-type: none"> • Used for installing the front arm pillow ball bushing. • Used together with INSTALLER & REMOVER (20099AE020).
 <p data-bbox="297 1650 449 1671">ST-20399AG000</p>	20399AG000	STRUT MOUNT SOCKET	<ul data-bbox="948 1325 1406 1472" style="list-style-type: none"> • Used for disassembling and assembling the strut assembly. • Used for checking torque of the strut assembly center nut.

ILLUSTRATION	TOOL NUMBER	DESCRIPTION	REMARKS
 <p data-bbox="315 512 443 533">ST-927680000</p>	927680000	INSTALLER & REMOVER SET	Used for removing and installing the rubber bushing arm front of the front arm.
 <p data-bbox="358 888 440 909">STSSM4</p>	—	SUBARU SELECT MONITOR 4	Used for setting of each function and troubleshooting for electrical system. <div data-bbox="954 642 1471 926" style="border: 1px solid black; padding: 5px;"> <p>Note:</p> <ul style="list-style-type: none"> • For detailed operation procedures, refer to “Help” of application. • Used together with interface for Subaru Select Monitor (such as DST-i and DST-010). </div>

2. OTHER

	REMARKS
Alignment gauge	Used for measuring wheel alignment.
Alignment gauge adapter	Used for measuring wheel alignment.
Turning radius gauge	Used for measuring wheel alignment.
Toe-in gauge	Used for toe-in measurement.
Dial gauge	Used for measuring the runout of strut COMPL front.
Magnet stand	Used for measuring the runout of strut COMPL front.
Coil spring compressor	Used for disassembling and assembling the strut assembly.

FRONT SUSPENSION > Wheel Alignment

INSPECTION

Check the following items before performing the wheel alignment measurement.

- Tire inflation pressure
- Uneven wear of RH and LH tires, or difference of sizes
- Tire runout
- Excessive play and wear of ball joint
- Excessive play and wear of tie-rod end
- Excessive play of wheel bearing
- Right and left wheel base imbalance
- Deformation and excessive play of steering parts
- Deformation and excessive play of suspension parts







Check, adjust and measure the wheel alignment in accordance with the following procedures.







Caution:

- **The engine must not be running when performing the adjustment.**
- **When performing the front toe-in adjustment with the steering wheel fixed to the straight-ahead position, be sure to perform the work with the electric power steering assist ON.**
The electric power steering assist is set to ON with the engine stopped, by turning ON the ignition switch within 5 seconds after the engine stops.

Note:

Alignment inspection and adjustment must be performed at the same tilt position as the vehicle was brought in.

1	Suspension height (front and rear wheels)	Inspection:  Ref. to FRONT SUSPENSION>Wheel Alignment>INSPECTION > SUSPENSION HEIGHT.
↓		
2	Camber (front wheel)	Inspection:  Ref. to FRONT SUSPENSION>Wheel Alignment>INSPECTION > CAMBER. Adjustment:  Ref. to FRONT SUSPENSION>Wheel Alignment>ADJUSTMENT > CAMBER (FRONT WHEEL).
	Camber (rear wheel)	Inspection:  Ref. to FRONT SUSPENSION>Wheel Alignment>INSPECTION > CAMBER. Note: Rear camber cannot be adjusted. If the value exceeds the specification, check the suspension parts and connections for deformation. If defective, replace them.
↓		
3	Caster (front wheel)	Inspection:  Ref. to FRONT SUSPENSION>Wheel Alignment>INSPECTION > CASTER.
↓		
4	Adjustment of difference between right and left steering angles	Inspection:  Ref. to FRONT SUSPENSION>Wheel Alignment>INSPECTION > STEERING ANGLE.

		Adjustment:  Ref. to FRONT SUSPENSION>Wheel Alignment>ADJUSTMENT > ADJUSTMENT OF DIFFERENCE BETWEEN RIGHT AND LEFT STEERING ANGLES.
↓		
5	Front toe-in	Inspection:  Ref. to FRONT SUSPENSION>Wheel Alignment>INSPECTION > FRONT TOE-IN. Adjustment:  Ref. to FRONT SUSPENSION>Wheel Alignment>ADJUSTMENT > FRONT TOE-IN.
↓		
6	Rear toe-in	Inspection:  Ref. to FRONT SUSPENSION>Wheel Alignment>INSPECTION > REAR TOE-IN. Adjustment:  Ref. to FRONT SUSPENSION>Wheel Alignment>ADJUSTMENT > REAR TOE-IN.
↓		
7	Thrust angle	Inspection:  Ref. to FRONT SUSPENSION>Wheel Alignment>INSPECTION > THRUST ANGLE. Adjustment:  Ref. to FRONT SUSPENSION>Wheel Alignment>ADJUSTMENT > THRUST ANGLE.

1. SUSPENSION HEIGHT

1. Park the vehicle on a level surface.
2. Empty the vehicle so that it is at "curb weight".

Note:

Unload any cargo, load the spare tire (tire puncture repair kit), jack and service tools, and fill up the fuel tank.

3. Set the steering wheel in a straight-ahead position, and stabilize the suspension by moving the vehicle in a straight line for 5 m (16 ft) or more.
4. Measure the distance (d) from the spindle end (c) to the ground surface.
5. Measure the distances (e) from the end of mounting bolt for the front arm rear plate (point "A" shown in the following figure) and from the end of bolt for the sub frame assembly rear at rear (point "B" shown in the following figure) to the ground surface.

Calculate the suspension heights (a) and (b) using the following calculation:

$$(d) - (e) = \text{suspension height}$$

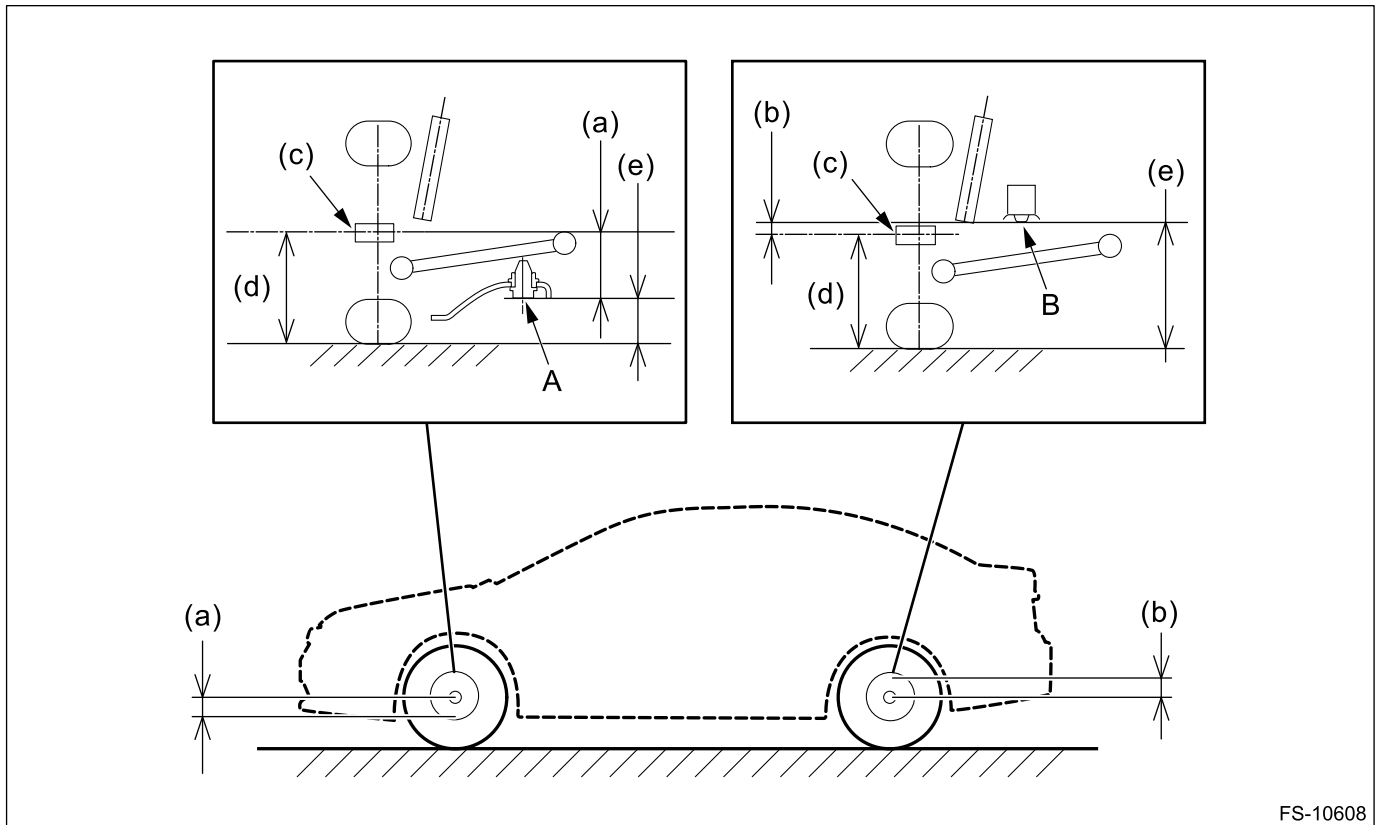

FS-10608

Suspension height specification mm (in) (Tolerance: +24 mm -12 mm (+0.94 in -0.47 in))	
Front	Rear
138 (5.43)	-9 (-0.35)

2. CAMBER

1. Place the tires on the turning radius gauge.

Note:

Make sure that the ground contact surfaces of the front tires and rear tires are at the same level.

2. Set the alignment gauge adapter into the center of wheel, and then set the alignment gauge.

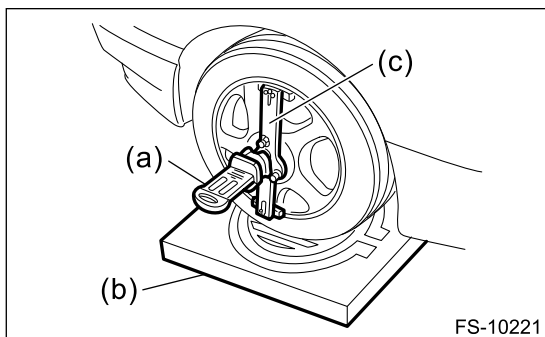

FS-10221

- (a) Alignment gauge
(b) Turning radius gauge

(c) Alignment gauge adapter

3. Measure the camber angle in accordance with the operation manual for alignment gauge.

Front camber (difference between RH and LH 45' or less)	Rear camber (difference between RH and LH 45' or less)
$-0^{\circ}40' \pm 45'$	$-1^{\circ}35' \pm 45'$

3. CASTER

1. Place the front tires on the turning radius gauge.

Note:

Make sure that the ground contact surfaces of the front tires and rear tires are at the same level.

2. Set the alignment gauge adapter into the center of wheel, and then set the alignment gauge.

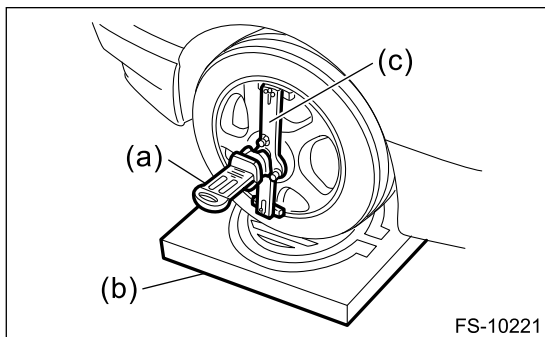

(a) Alignment gauge

(b) Turning radius gauge

(c) Alignment gauge adapter

3. Measure the caster angle in accordance with the operation manual for alignment gauge.

Caster
$6^{\circ}00'$

4. STEERING ANGLE

1. Place the front tires on the turning radius gauge.

Note:

Make sure that the ground contact surfaces of the front tires and rear tires are at the same level.

2. While depressing the brake pedal, turn the steering wheel fully to the left and right.

3. With the steering wheel held at each fully turned position, measure both the inner and outer wheel steering angles.

Inner wheel	Outer wheel
37.1°	32.7°

5. FRONT TOE-IN

Toe-in: Inspection value

0±3 mm (0±0.12 in)

1. Set the toe-in gauge in the position at wheel axis center height behind the right and left front tires.
2. Place a mark at the center of both left and right tires, and measure distance "A" between the marks.
3. Move the vehicle forward to rotate the tires 180°.
4. Measure the distance "B" between the left and right marks.

Calculate toe-in using the following calculation:

$$A - B = \text{Toe-in}$$

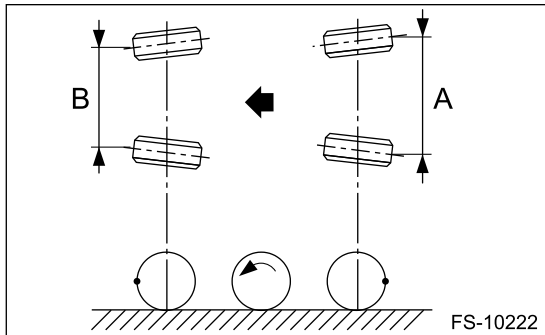

6. REAR TOE-IN

Refer to the FRONT TOE-IN for rear toe-in inspection procedures.  [Ref. to FRONT SUSPENSION>Wheel Alignment>INSPECTION > FRONT TOE-IN.](#)

Toe-in: Inspection value

3±3 mm (0.12±0.12 in)

7. THRUST ANGLE

1. Park the vehicle on a level surface.
2. Move the vehicle 3 — 4 meters (10 — 13 ft) straight forward.
3. Draw the center of loci for both the front and rear axles.
4. Measure distance "L" between the center lines of the axle loci.

Thrust angle: Inspection value

0°00'±30'

Less than 30' when "L" is 23 mm (0.9 in) or less.

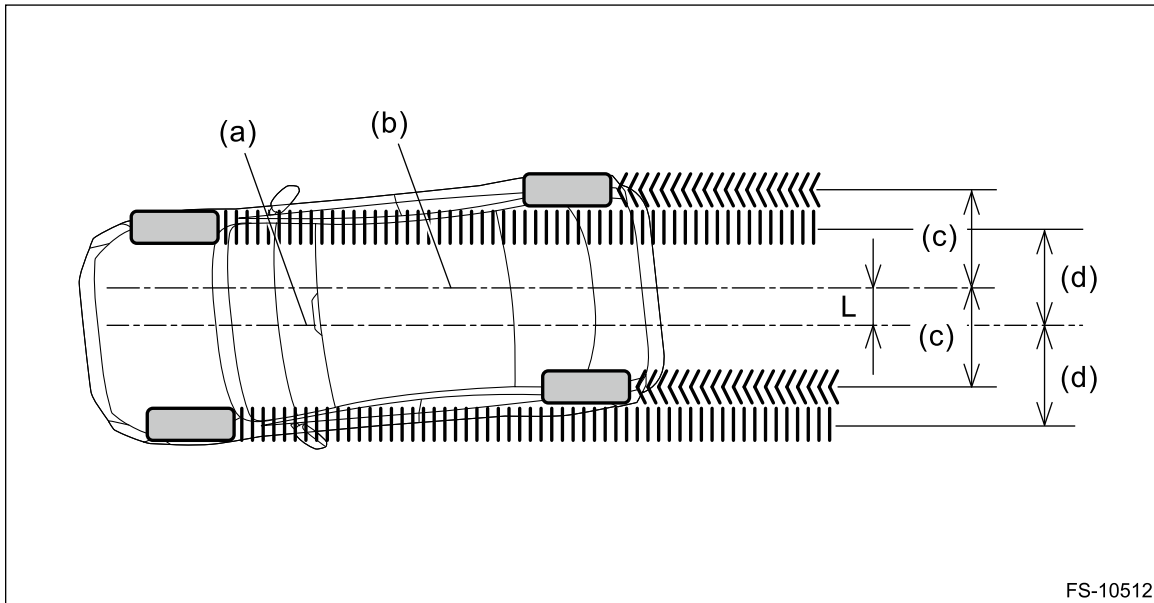

- (a) Center line of loci (front axle)
- (b) Center line of loci (rear axle)
- (c) Same distance
- (d) Same distance

FRONT SUSPENSION > Wheel Alignment

ADJUSTMENT

Caution:

When the wheel alignment has been adjusted, perform the following adjustment.

- **VDC sensor midpoint setting mode:** Ref. to [VEHICLE DYNAMICS CONTROL \(VDC\)>VDC Control Module and Hydraulic Control Unit \(VDCCM&H/U\)>ADJUSTMENT > VDC SENSOR MIDPOINT SETTING MODE.](#)
- **Lane keep assist learning value clear:** Ref. to [EyeSight \(DIAGNOSTICS\)>Work Support.](#)

Note:

When adjusting, adjust so that the value is always within the adjustment value range, taking aging variation into consideration.

1. CAMBER (FRONT WHEEL)

Note:

Rear camber cannot be adjusted.

Adjust the camber angle to the following value.

Camber (difference between RH and LH 35' or less)
$-0^{\circ}40' \pm 30'$

1. Loosen the nut side, while holding the strut assembly bolt side. (2 places at upper and lower)
2. Turn the adjusting bolt so that the camber is set at specification.

Note:

Moving the adjusting bolt by one scale changes the camber by approximately 10'.

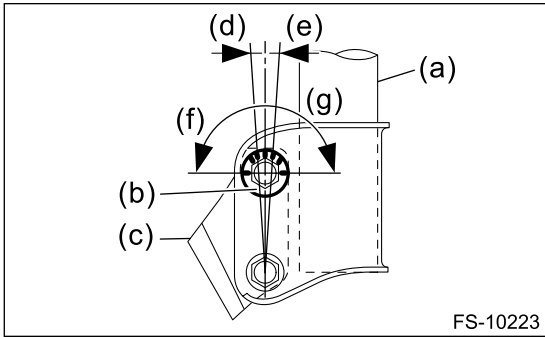

- (a) Strut ASSY
- (b) Adjusting bolt
- (c) Front axle housing
- (d) Outer direction
- (e) Inner direction
- (f) Camber is increased.
- (g) Camber is decreased.

To increase camber:	
Rotate the left side counterclockwise.	Rotate the right side clockwise.
<p style="text-align: center;">FS-00352</p>	<p style="text-align: center;">FS-00353</p>

To decrease camber:	
Rotate the left side clockwise.	Rotate the right side counterclockwise.
<p style="text-align: center;">FS-00353</p>	<p style="text-align: center;">FS-00352</p>

3. Tighten two new flange nuts.

Caution:
While holding the bolt side, tighten the nut to the specified torque.

Note:
First, tighten the adjusting bolt (upper side) to the specified torque.

Tightening torque:
 155 N·m (15.8 kgf-m, 114.3 ft-lb)

2. ADJUSTMENT OF DIFFERENCE BETWEEN RIGHT AND LEFT STEERING ANGLES

1. Operate the steering system from lock to lock and stop operating it at the center position from lock to lock, and then install the steering wheel in the straight-ahead position.

Note:

Using of the Subaru Select Monitor and the data of [Steering angle] will facilitate your work.  Ref. to **POWER STEERING (DIAGNOSTICS)>Data Monitor.**

2. Before adjusting toe-in, be sure to adjust the steering wheel in the straight-ahead position (steering wheel rotational angle: 0 deg).

3. FRONT TOE-IN

Caution:

- The engine must not be running when performing the adjustment.
- When performing the front toe-in adjustment with the steering wheel fixed to the straight-ahead position, be sure to perform the work with the electric power steering assist ON.
The electric power steering assist is set to ON with the engine stopped, by turning ON the ignition switch within 5 seconds after the engine stops.

When adjusting the toe-in, adjust it to the following value.

Toe-in: Adjustment value

0±2 mm (0±0.08 in)

1. Check that the left and right wheel steering angles are within specification.
2. Loosen the tie-rod end lock nuts on the left and right sides.

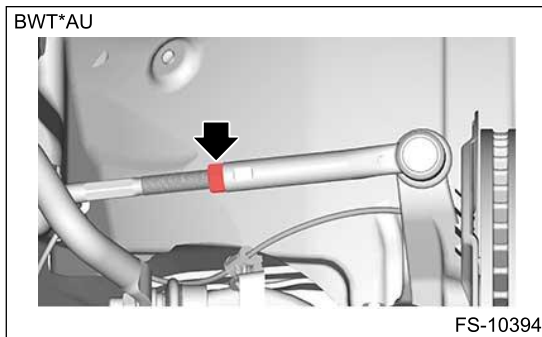

3. Turn the left and right tie-rods by equal amounts until the toe-in is at the specification.

Note:

- Both the left and right tie-rods are right-hand threaded. To increase toe-in, turn both tie-rods clockwise by equal amount (viewing from the inside of vehicle).
- When adjusting toe-in, hold the boot steering gearbox as shown to prevent it from being rotated or twisted. If it becomes twisted, straighten it.

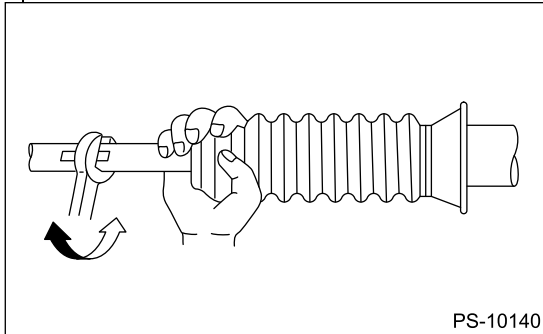

4. Tighten the tie-rod end lock nut.

Tightening torque:

85 N·m (8.7 kgf-m, 62.7 ft-lb)

4. REAR TOE-IN

When adjusting, adjust it to the following value.

Toe-in: Adjustment value

3±2 mm (0.12±0.08 in)

1. Loosen the self-locking nut while holding the bolt side of rear lateral link assembly front.

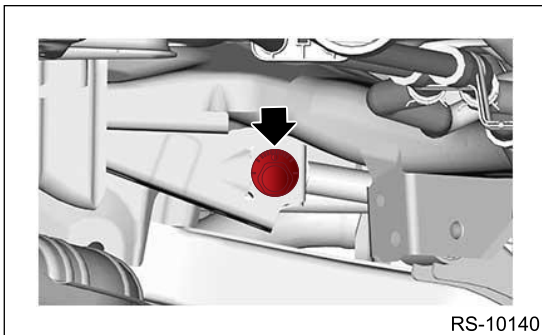

2. Turn the adjusting bolt until toe-in is within the specification.

Note:

When the left and right wheels are adjusted for toe-in at the same time, the movement of one scale graduation changes toe-in by approx. 6 mm (0.24 in).

To increase toe-in:	
Rotate the left side clockwise.	Rotate the right side counterclockwise.

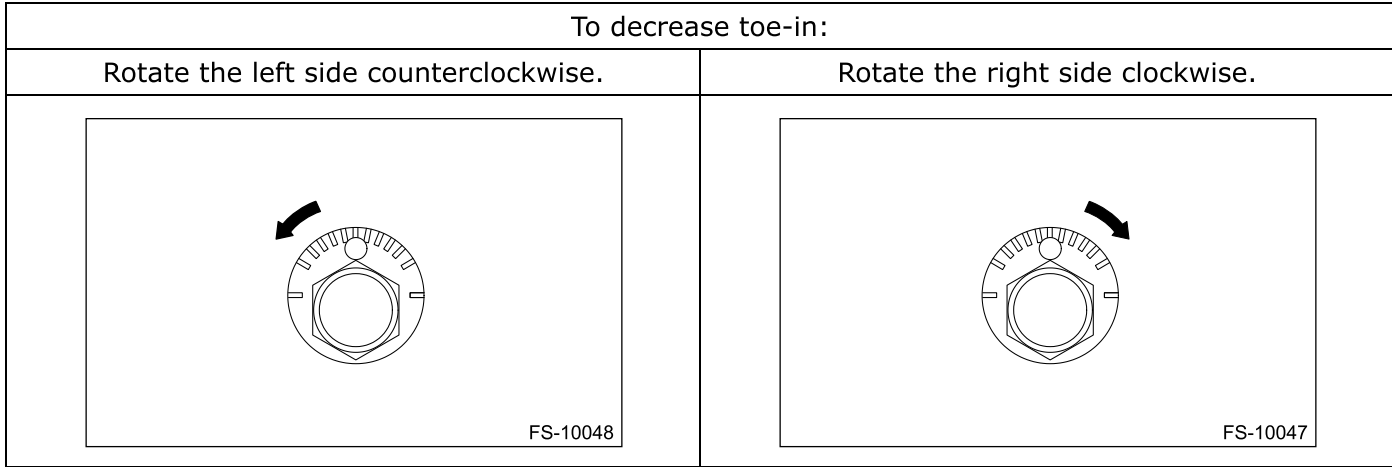
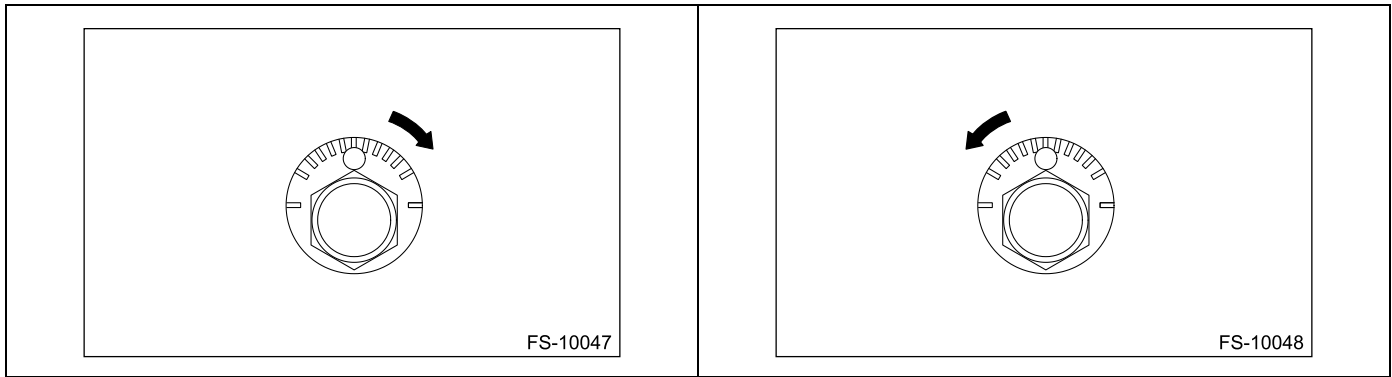

3. Attach and tighten a new self-locking nut.

Caution:
While holding the bolt side, tighten the nut to the specified torque.

Tightening torque:
 100 N·m (10.2 kgf-m, 73.8 ft-lb)

5. THRUST ANGLE

When adjusting, adjust it to the following value.

Thrust angle: Adjustment value

0°00'±20'

Less than 20' when "L" is 15 mm (0.6 in) or less.

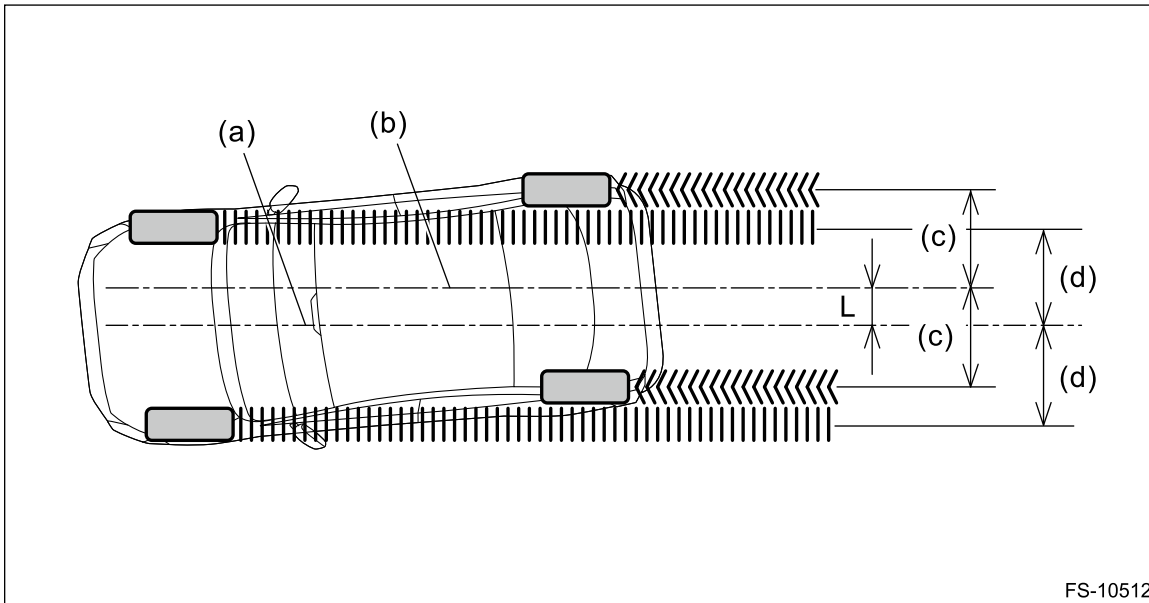

- (a) Center line of loci (front axle) (c) Same distance (d) Same distance
 (b) Center line of loci (rear axle)

1. Make thrust angle adjustments by turning the adjusting bolts of the rear suspension equally in the same direction.
2. When one rear tire is adjusted in a toe-in direction, adjust the other rear tire equally in a toe-out direction, in order to make the thrust angle adjustment.
3. When the left and right adjusting bolts are turned by one graduation, the thrust angle will change approx. 15'. ("L" is approx. 11 mm (0.43 in).)

Note:

Thrust angle is a mean value of left and right toe angles calculated from the vehicle body center line.

Vehicle is driven straight in the thrust angle direction while slanting in the oblique direction depending on the degree of the mean thrust angle.

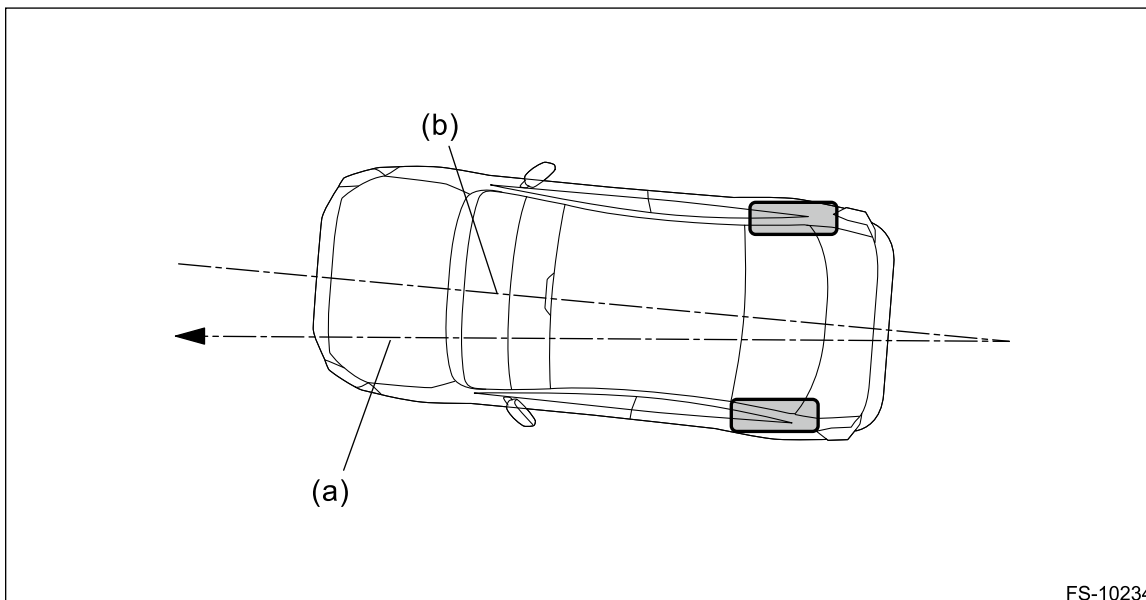

(a) Thrust angle

(b) Body center line

Thrust angle:

$$\gamma = (\alpha - \beta) / 2$$

α : Rear RH toe-in angle

β : Rear LH toe-in angle

Substitute only the positive toe-in values from each tire into α and β in the calculation.

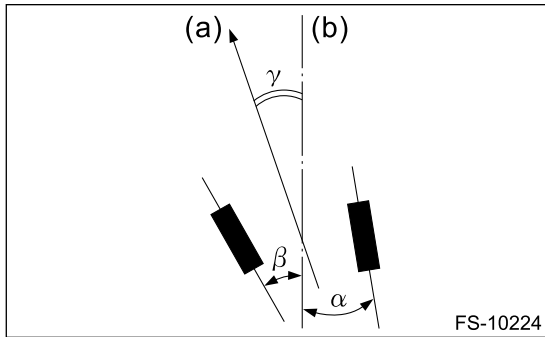

(a) Front

(b) Body center line

FRONT SUSPENSION > Crossmember Support

REMOVAL



1. Remove the under guard front. (When the crossmember support front is removed)  [Ref. to EXTERIOR/INTERIOR TRIM>Front Under Cover>REMOVAL.](#)
2. Remove the bolt, and remove the crossmember support rear.

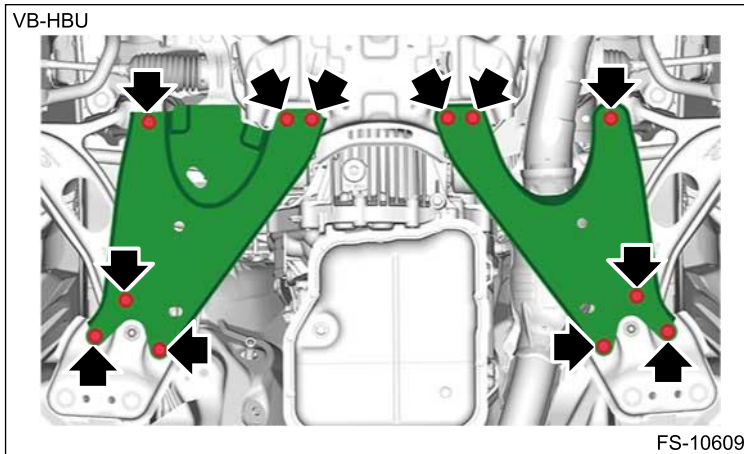

3. Remove the bolt, and remove the crossmember support front.

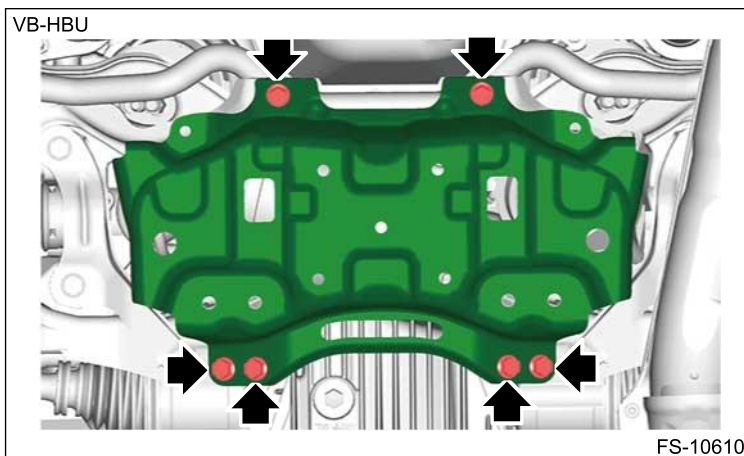

FRONT SUSPENSION > Crossmember Support

INSTALLATION

1. Install the crossmember support front.
Tightening torque:
60 N·m (6.1 kgf-m, 44.3 ft-lb)
2. Install the crossmember support rear.
Tightening torque:
70 N·m (7.1 kgf-m, 51.6 ft-lb)
3. Install the under guard front. (When the crossmember support front was removed)  [Ref. to EXTERIOR/INTERIOR TRIM>Front Under Cover>INSTALLATION.](#)

REMOVAL



1. STABILIZER LINK

Caution:

Be careful not to damage the boot of the ball joint.

1. Remove the front wheels.  [Ref. to WHEEL AND TIRE SYSTEM>Tire and Wheel>REMOVAL.](#)
2. Remove the nut and remove the stabilizer link front.

VBN*AJ

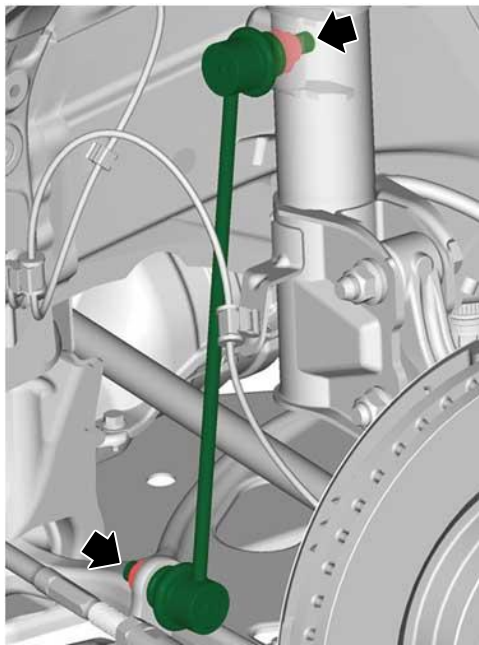

FS-10456

2. STABILIZER BUSHING

1. Remove the under cover front.  [Ref. to EXTERIOR/INTERIOR TRIM>Front Under Cover>REMOVAL.](#)
2. Remove the rubber bushing stabilizer front.
 - (1) Remove the bolt and nut, and remove the clamp stabilizer.
 - (2) Remove the rubber bushing stabilizer front.

VB-HBU

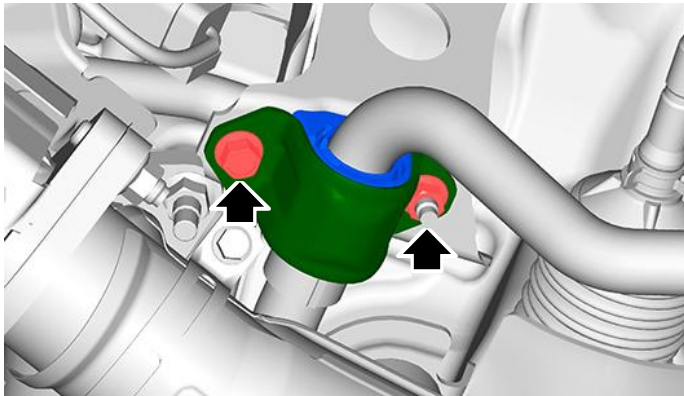





FS-10611

3. STABILIZER

Caution:

Be careful not to damage the boot of the ball joint.

1. Disconnect the ground terminal from battery sensor.  [Ref. to REPAIR CONTENTS>NOTE > BATTERY.](#)
2. Remove the under guard front.  [Ref. to EXTERIOR/INTERIOR TRIM>Front Under Cover>REMOVAL.](#)
3. Remove the crossmember support rear LH.  [Ref. to FRONT SUSPENSION>Crossmember Support>REMOVAL.](#)
4. Remove the center exhaust pipe (rear).  [Ref. to EXHAUST\(H4DOTC\)>Center Exhaust Pipe>REMOVAL > CENTER EXHAUST PIPE \(REAR\).](#)
5. Remove the nut and disconnect the stabilizer link front (lower part).

VB-HBU

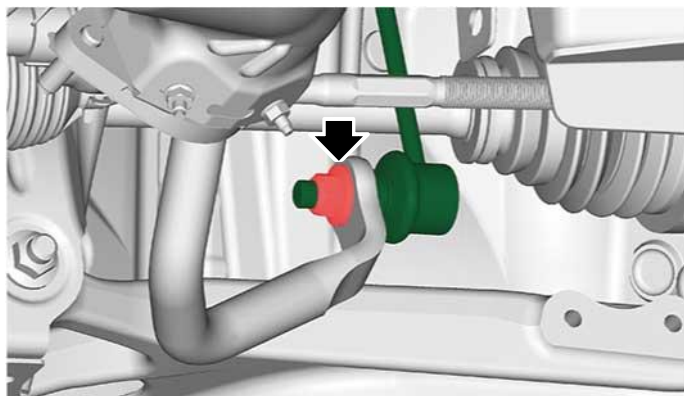

FS-10612

6. Remove the stabilizer front.
 - (1) Remove the bolt and nut, and remove the clamp stabilizer.
 - (2) Remove the rubber bushing stabilizer front.
 - (3) Remove the stabilizer front.

VB-HBU

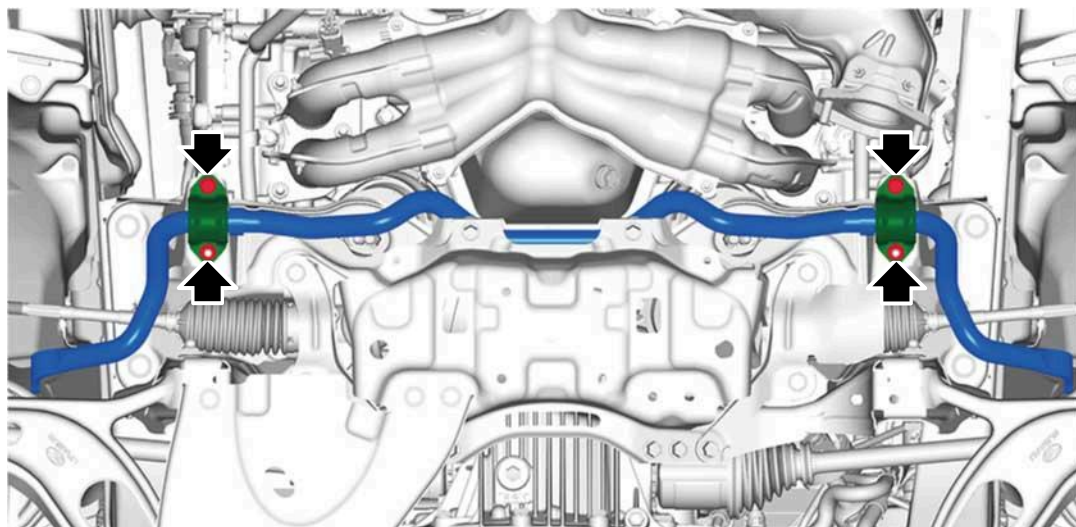

FS-10613

FRONT SUSPENSION > Stabilizer

INSTALLATION

1. STABILIZER LINK

Caution:

For parts which are not reusable, always use new parts.

1. Before installation, check the stabilizer link front for damage.
2. Using a new flange nut, install the stabilizer link front.

Caution:

Be careful not to damage the boot of the ball joint.

Tightening torque:

60 N·m (6.1 kgf-m, 44.3 ft-lb)

3. Install the front wheels.  [Ref. to WHEEL AND TIRE SYSTEM>Tire and Wheel>INSTALLATION.](#)

2. STABILIZER BUSHING

Caution:

- Install the rubber bushing stabilizer front so that the slit does not shift to the right or left.
- Install the clamp stabilizer with the peak of triangle facing the front of the vehicle.

BT*BE

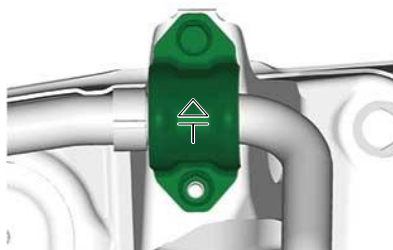

FS-10601

Note:

The rubber bushing stabilizer front can be used with its slit facing either front or rear.

1. Before installation, check the rubber bushing stabilizer front for abnormal cracks, fatigue or damage.
2. Install the rubber bushing stabilizer front.
3. Install the clamp stabilizer.

Tightening torque:

25 N·m (2.5 kgf-m, 18.4 ft-lb)



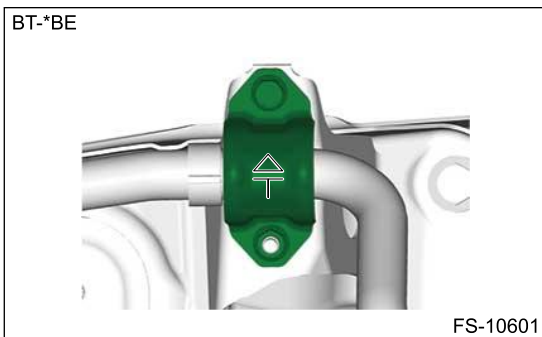

4. Install the under cover front.  [Ref. to EXTERIOR/INTERIOR TRIM>Front Under Cover>INSTALLATION.](#)

3. STABILIZER**Caution:**

- For parts which are not reusable, always use new parts.
- Install the rubber bushing stabilizer front so that the slit does not shift to the right or left.
- Install the clamp stabilizer with the peak of triangle facing the front of the vehicle.

**Note:**

The rubber bushing stabilizer front can be used with its slit facing either front or rear.

1. Install the stabilizer front, the rubber bushing stabilizer front, and the clamp stabilizer.
Tightening torque:
25 N·m (2.5 kgf-m, 18.4 ft-lb)
2. Install the stabilizer link front (bottom part).  [Ref. to FRONT SUSPENSION>Stabilizer>INSTALLATION > STABILIZER LINK.](#)
3. Install the center exhaust pipe (rear).  [Ref. to EXHAUST\(H4DOTC\)>Center Exhaust Pipe>INSTALLATION > CENTER EXHAUST PIPE \(REAR\).](#)
4. Install the crossmember support rear LH.  [Ref. to FRONT SUSPENSION>Crossmember Support>INSTALLATION.](#)
5. Install the under guard front.  [Ref. to EXTERIOR/INTERIOR TRIM>Front Under Cover>INSTALLATION.](#)
6. Connect the ground terminal to battery sensor.  [Ref. to REPAIR CONTENTS>NOTE > BATTERY.](#)

FRONT SUSPENSION > Stabilizer**INSPECTION****1. STABILIZER LINK**

- 1.** Check that there is no deformation, cracks or other damages.
- 2.** Check for excessive rusting.
- 3.** Move the stud as shown in the figure to check that there is no abnormal interference or play.

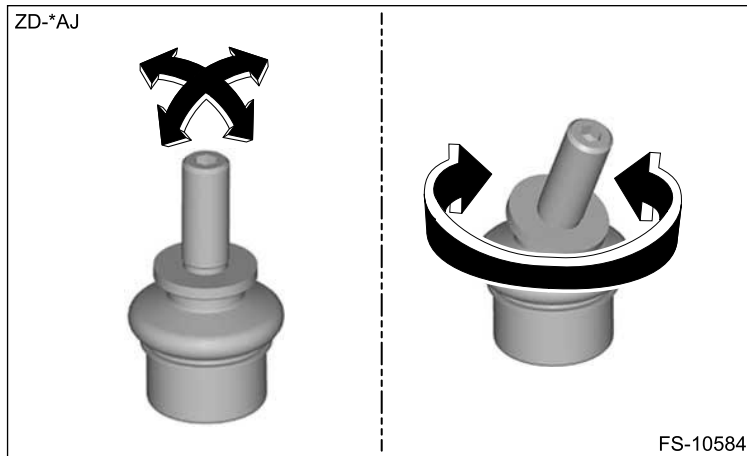

- 4.** If fault is found in the inspection, replace the relevant part.

FRONT SUSPENSION > Front Arm

REMOVAL



1. Remove the front wheels. [Ref. to WHEEL AND TIRE SYSTEM>Tire and Wheel>REMOVAL.](#)
2. Remove the under cover front. [Ref. to EXTERIOR/INTERIOR TRIM>Front Under Cover>REMOVAL.](#)
3. Remove the crossmember support rear. [Ref. to FRONT SUSPENSION>Crossmember Support>REMOVAL.](#)
4. Remove the arm assembly front.
 - (1) Remove the bolt and nut from the front axle housing.
 - (2) Lower the arm assembly front, and remove the ball stud from the front axle housing.

Caution:

Be careful not to damage the boot of the ball joint.

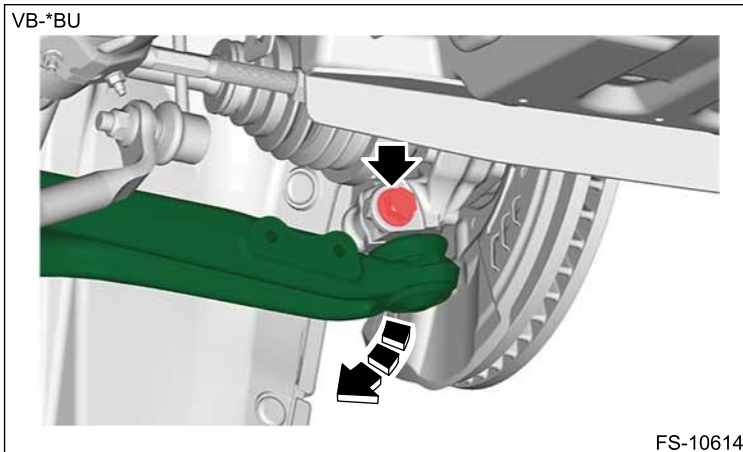

- (3) Remove the bolts, and remove the front arm rear plate.

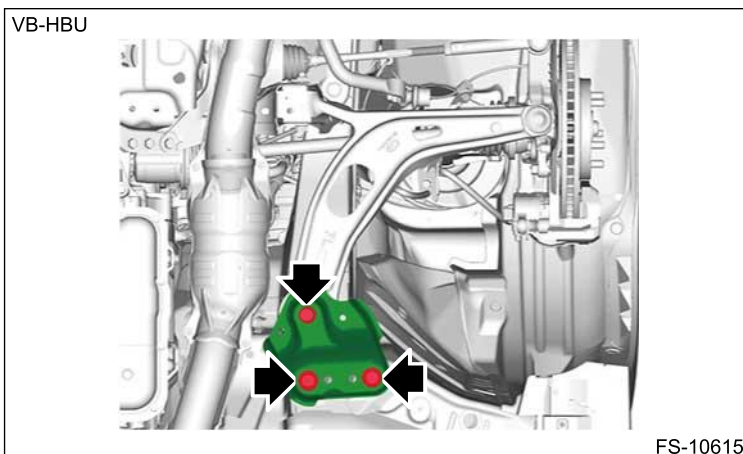

- (4) Remove the bolts and nuts to remove the arm assembly front.

VB-HBU

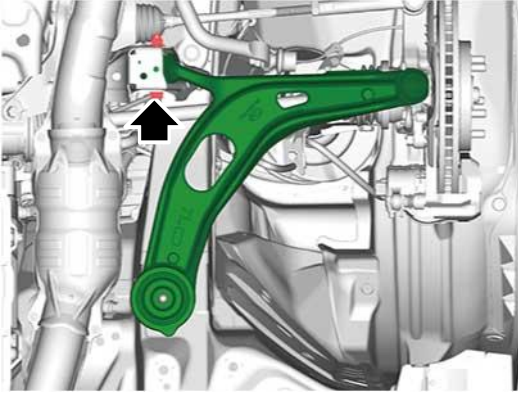

FS-10616

FRONT SUSPENSION > Front Arm

INSTALLATION

Caution:

For the non-reusable parts, always use new parts.

1. Before installation, inspect the following items and replace any faulty part with a new one.
 - Check the arm assembly front for damage or cracks.
 - Check the bushing for abnormal cracks, damage or fatigue.
 - Check the boot on the ball joint for damage.
2. Using a new flange bolt and a new self-locking nut, temporary install the arm assembly front and the front arm rear plate.

Caution:

Be careful not to damage the boot of the ball joint.

3. Tighten the bolts for front arm rear plate.

Tightening torque:

150 N·m (15.3 kgf-m, 110.6 ft-lb)

VB-HBU

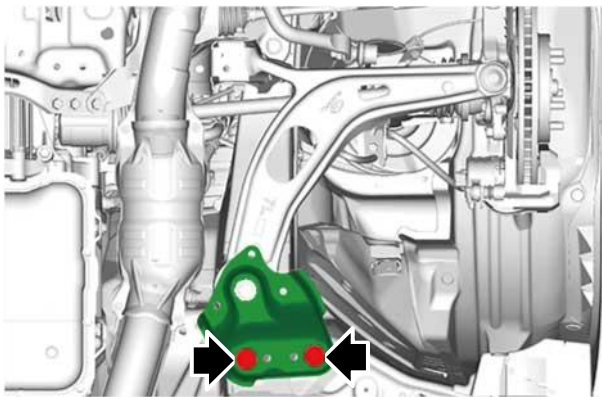

FS-10630

4. Using new flange bolts and new flange nuts, install the arm assembly front ball stud to the front axle housing.

Caution:

- Be careful not to damage the boot of the ball joint.
- While holding the bolt side, tighten the nut to the specified torque.

Tightening torque:

70 N·m (7.1 kgf-m, 51.6 ft-lb)

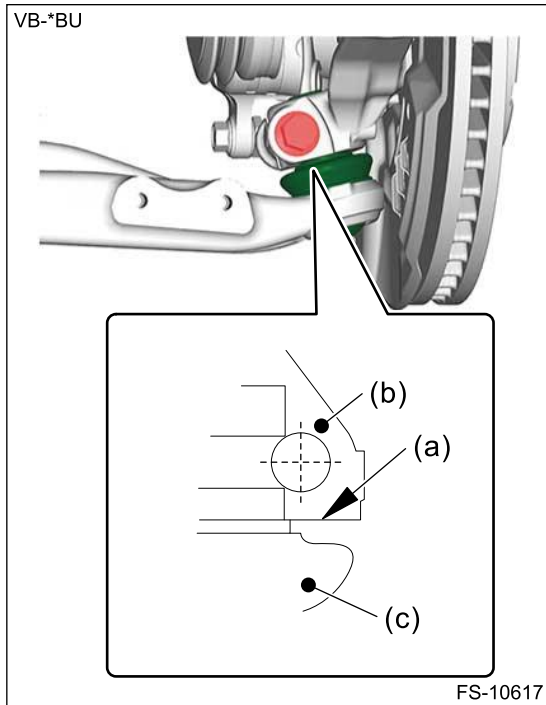

- (a) Bottom surface of front axle housing
- (b) Front axle housing
- (c) Arm ASSY front

5. Install the crossmember support rear.  [Ref. to FRONT SUSPENSION>Crossmember Support>INSTALLATION.](#)
6. Disconnect the strut assembly and the front axle housing.
 - (1) Place an alignment mark (a) on the adjusting bolt and the strut assembly.
 - (2) Remove the adjusting bolts and flange bolts for the strut assembly.

Caution:

Turn and remove the nut while holding the bolt side.

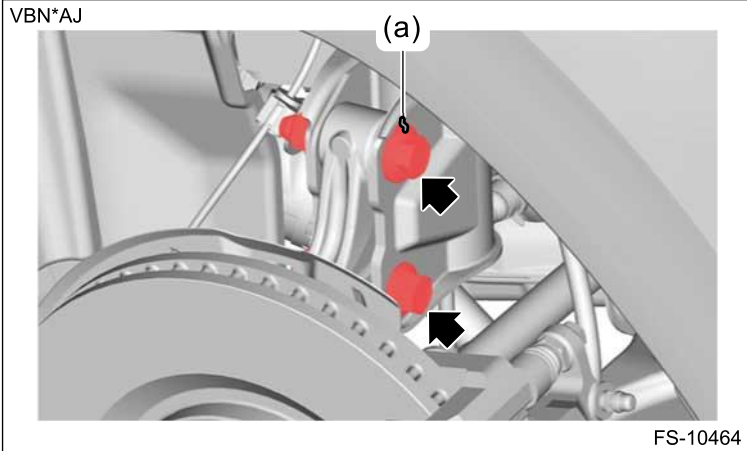

7. Install the arm assembly front.
 (1) Apply a load to the arm assembly front using a transmission jack.

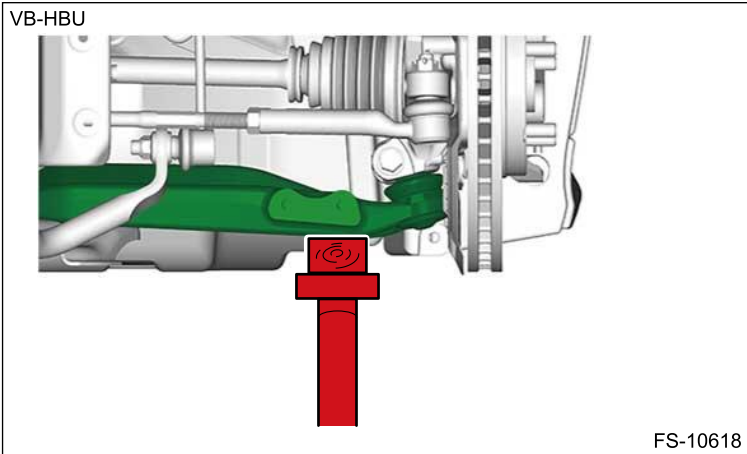

- (2) Adjust the clearance between the upper surface of crossmember support rear and the lower surface of ball joint connection of the arm assembly front.

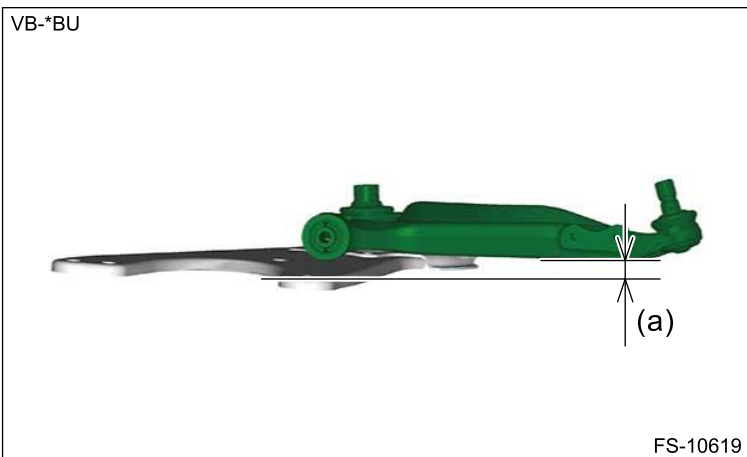

Standard (a)	11.11 mm (0.44 in)
--------------	--------------------

- (3) Tighten the bolts and nuts of the arm assembly front.

Caution:
For T1, tighten the bolt to the specified torque while holding the nut side.
For T2, tighten the bolt to specified torque.

Tightening torque:

T1: 95 N·m (9.7 kgf-m, 70.1 ft-lb)

T2: 140 N·m (14.3 kgf-m, 103.3 ft-lb)

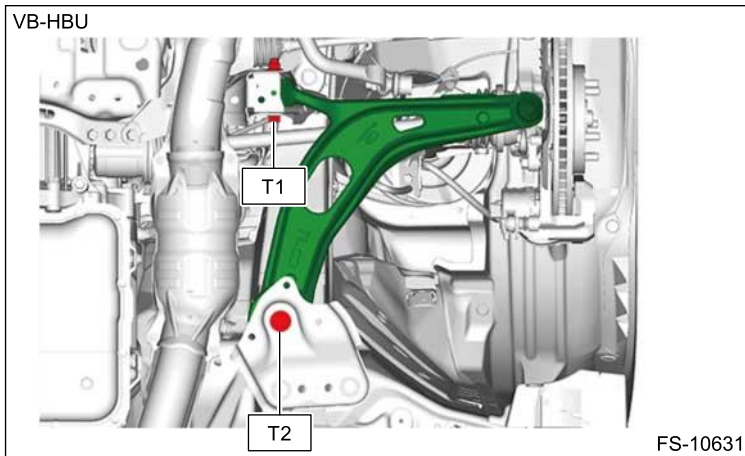

8. Align alignment marks on the adjusting bolt and the strut assembly, and install the strut assembly to the front axle housing using a new flange nut.

Caution:







- While holding the bolt side, tighten the nut to the specified torque.
- Do not forget to install the adjusting washer.

Note:

First, tighten the adjusting bolt (upper side) to the specified torque.

Tightening torque:

155 N·m (15.8 kgf-m, 114.3 ft-lb)

9. Install the under cover front.  [Ref. to EXTERIOR/INTERIOR TRIM>Front Under Cover>INSTALLATION.](#)
10. Install the front wheels.  [Ref. to WHEEL AND TIRE SYSTEM>Tire and Wheel>INSTALLATION.](#)
11. Inspect the wheel alignment and adjust if necessary.
- Inspection:  [Ref. to FRONT SUSPENSION>Wheel Alignment>INSPECTION.](#)
 - Adjustment:  [Ref. to FRONT SUSPENSION>Wheel Alignment>ADJUSTMENT.](#)
12. Perform VDC sensor midpoint setting mode.  [Ref. to VEHICLE DYNAMICS CONTROL \(VDC\)>VDC Control Module and Hydraulic Control Unit \(VDCCM&H/U\)>ADJUSTMENT > VDC SENSOR MIDPOINT SETTING MODE.](#)
13. Perform the lane keep assist learning value clear.  [Ref. to EyeSight \(DIAGNOSTICS\)>Work Support.](#)

FRONT SUSPENSION > Front Arm

DISASSEMBLY



1. RUBBER BUSHING ARM FRONT

1. Remove the rubber bushing arm front using the ST.

Preparation tool:

ST: INSTALLER & REMOVER SET (927680000)

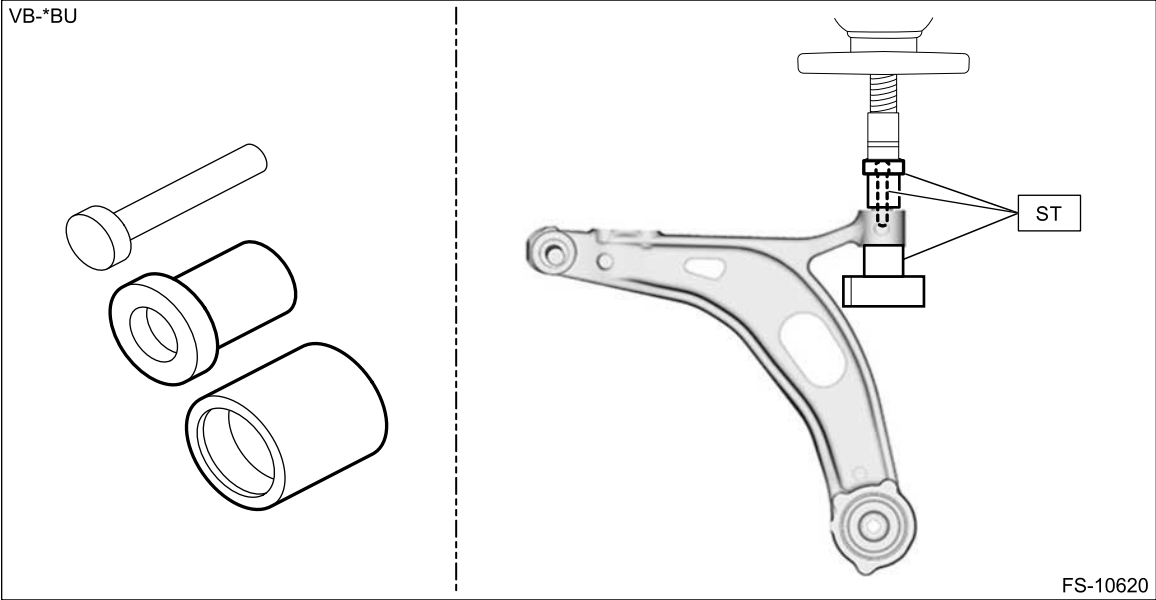

2. PILLOW BALL BUSHING

- 1. Remove the pillow ball bushing using ST1 and ST2.

Preparation tool:

ST1: INSTALLER & REMOVER (20099AE020)

ST2: HOUSING STAND (28099PA010)

Note:
Place a metal plate on the ST1 to use the press.

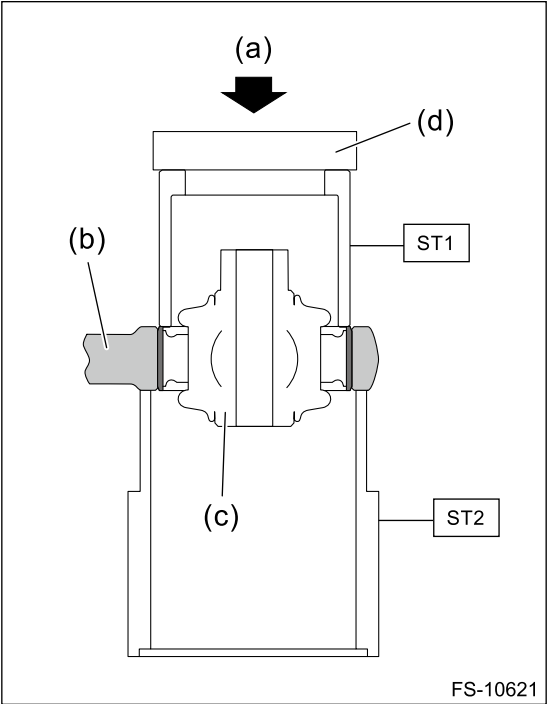

- (a) Press
- (b) Arm ASSY front

(c) Pillow ball bushing

(d) Plate

FRONT SUSPENSION > Front Arm

ASSEMBLY

Caution:

Make sure to press the bushing straight in.

1. RUBBER BUSHING ARM FRONT

1. Before assembly, inspect the following items and replace any faulty part with a new one.
 - Check the arm assembly front for damage or cracks.
 - Check the bushing for abnormal cracks, damage or fatigue.
 - Check the boot on the ball joint for damage.

2. Install the bushing arm front using the ST.

Preparation tool:

ST: INSTALLER & REMOVER SET (927680000)

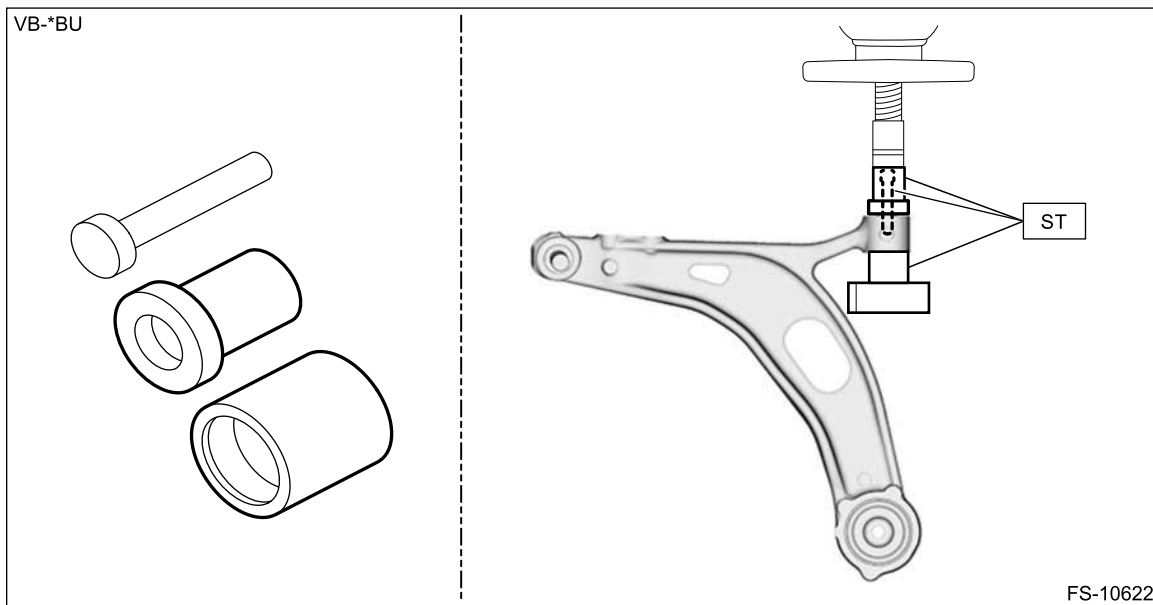

2. PILLOW BALL BUSHING

1. Before installation, inspect the following items and replace any faulty part with a new one.
 - Check the arm assembly front for damage or cracks.
 - Check the bushing for abnormal cracks, damage or fatigue.
 - Check the boot on the ball joint for damage.
2. Install the pillow ball bushing using ST1 and ST2.

Note:

- Align the upper face of arm assembly front and the end of bushing during installation.
- Install so that the upper exposed length (a) of the bushing inner cylinder becomes longer than the lower exposed length (b).

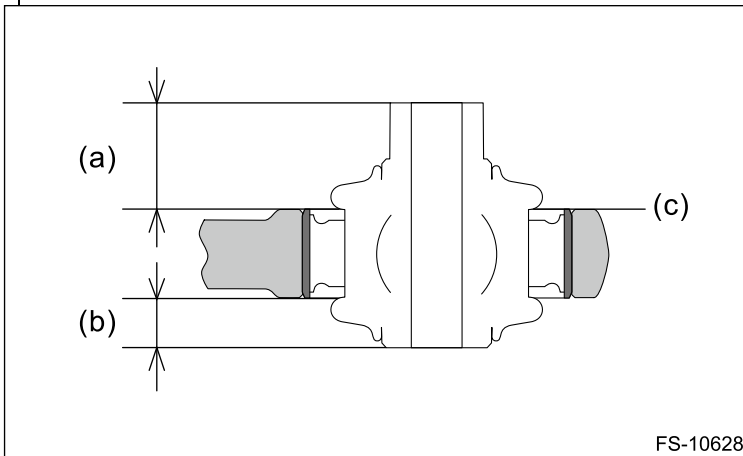

- (a) Exposed length of inner cylinder (upper)
- (b) Exposed length of inner cylinder (lower)
- (c) Alignment line

Preparation tool:

ST1: INSTALLER & REMOVER (20099AE020)

ST2: REMOVER (18723AA000)

Note:

Place a metal plate on the ST1 to use the press.

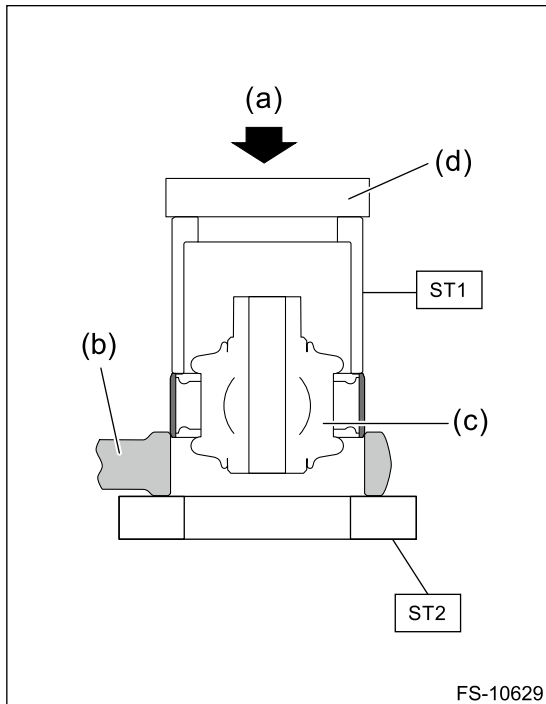

- (a) Press
- (b) Arm ASSY front

(c) Pillow ball bushing

(d) Plate

FRONT SUSPENSION > Front Arm

INSPECTION

1. ON THE VEHICLE INSPECTION

1. Check that there is no deformation, cracks or other damages.
2. Check for excessive rusting.
3. Check the front hub unit bearing for looseness.  [Ref. to PROPELLER SHAFT / DRIVE SHAFT / AXLE>Front Hub Unit Bearing>INSPECTION.](#)
4. Rock the arm assembly front up and down to check the ball joint for looseness.

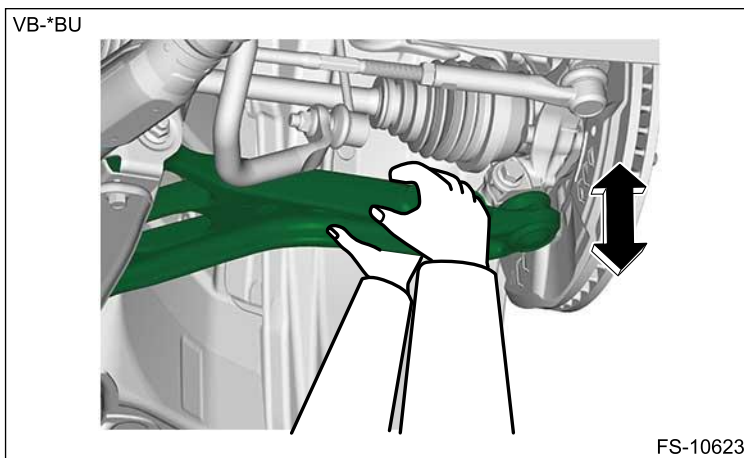

5. If fault is found in the inspection, replace the relevant part.

2. UNIT INSPECTION

1. Move the stud as shown in the figure to check that there is no abnormal interference or play.

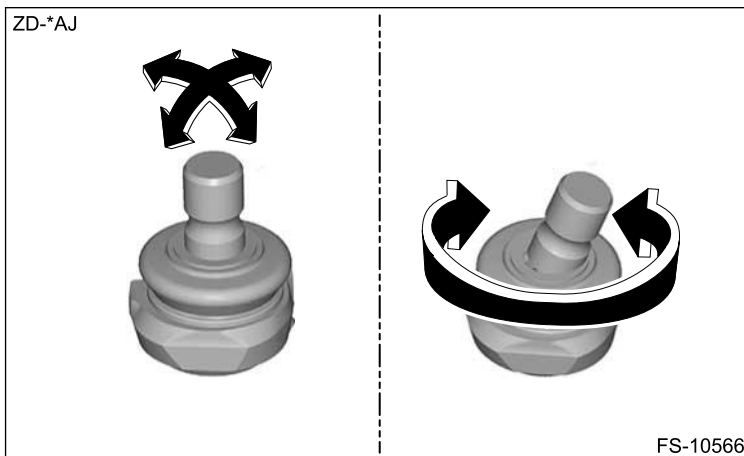

2. If fault is found in the inspection, replace the relevant part.



FRONT SUSPENSION > Crossmember

REMOVAL



Caution:

- **The power steering control module continues to operate after the engine stops and calculates the temperature in the control module. Therefore, before starting service of the power steering system which requires disconnection of the connector, stop the engine and allow approx. 30 minutes until the control module becomes cold.**
- **Be careful not to let any foreign matter (dust, water, oil, etc.) enter into the power steering control module connector when removing or installing. If a foreign matter enters, completely remove it.**

1. Disconnect the ground terminal from battery sensor.  [Ref. to REPAIR CONTENTS>NOTE > BATTERY.](#)
2. Remove the striker assembly front hood.  [Ref. to EXTERIOR BODY PANELS>Front Hood>DISASSEMBLY.](#)
3. Fully open the hood COMPL front.  [Ref. to REPAIR CONTENTS>NOTE > FRONT HOOD GAS STAY.](#)
4. Remove the V-belt covers.

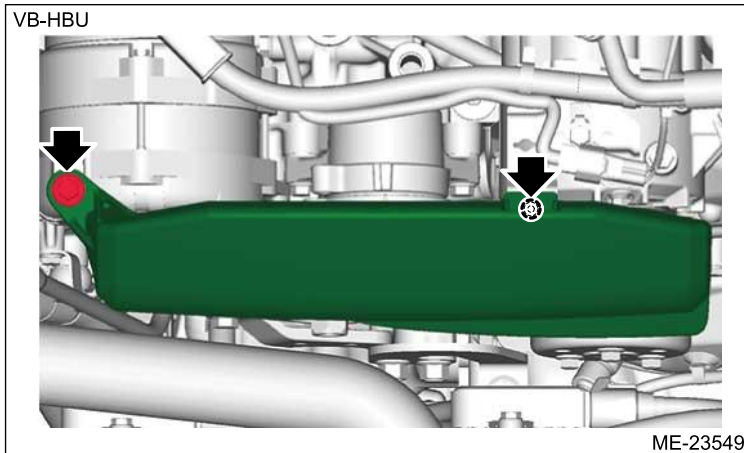

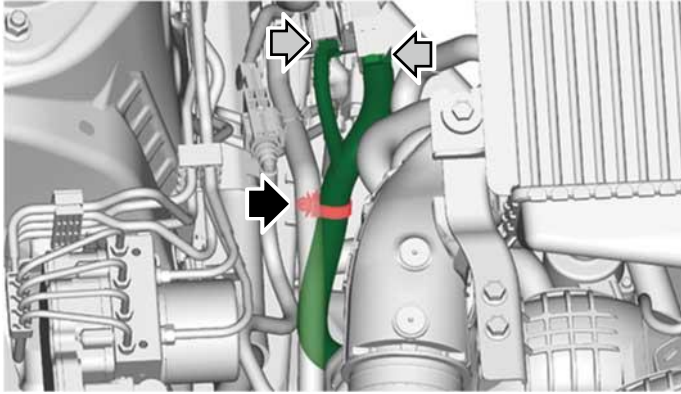

5. Remove the air intake duct.  [Ref. to INTAKE \(INDUCTION\)\(H4DOTC\)>Air Intake Duct>REMOVAL.](#)
6. Disconnect the power steering harness connector and remove the harness clamp.

VB-*BU



PS-10820

- 7.** Remove the front wheels.  [Ref. to WHEEL AND TIRE SYSTEM>Tire and Wheel>REMOVAL.](#)
- 8.** Remove the under guard front.  [Ref. to EXTERIOR/INTERIOR TRIM>Front Under Cover>REMOVAL.](#)
- 9.** Remove the center exhaust pipe (rear).  [Ref. to EXHAUST\(H4DOTC\)>Center Exhaust Pipe>REMOVAL > CENTER EXHAUST PIPE \(REAR\).](#)
- 10.** Remove the nuts which secure the engine mounting to the crossmember.

VB-*BU

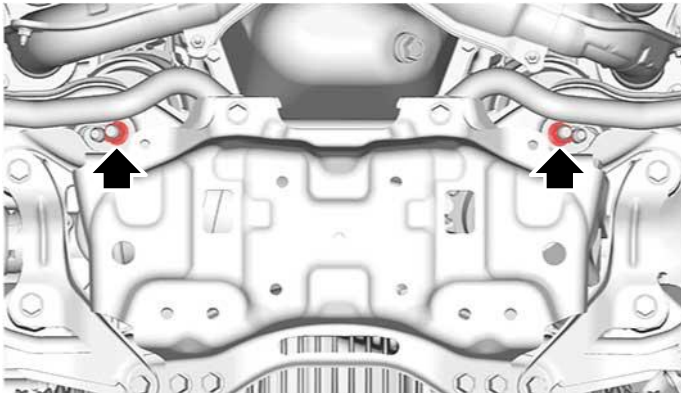

FS-10624

- 11.** Lower the vehicle.
- 12.** Remove the pitching stopper.  [Ref. to CONTINUOUSLY VARIABLE TRANSMISSION\(TR690\)>Transmission Mounting System>REMOVAL > PITCHING STOPPER.](#)
- 13.** Using the ST1, install the ST2 to the engine unit.

Preparation tool:

ST1: BOLT (18363AA050)

ST2: HANGER (18360AA040)

Tightening torque:

43 N·m (4.4 kgf-m, 31.7 ft-lb)

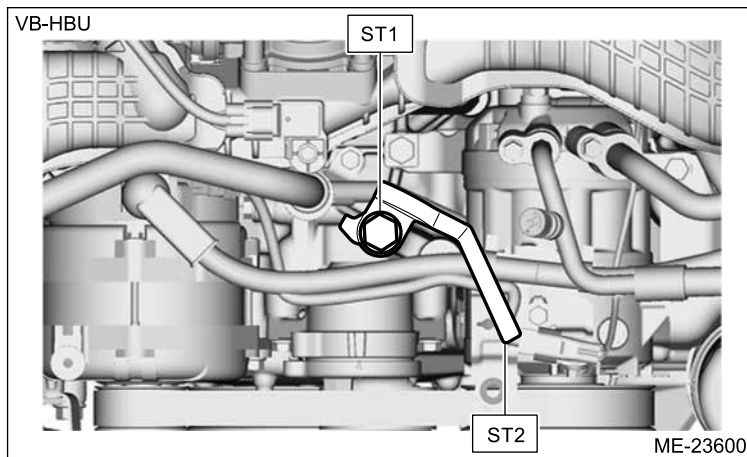

14. Support the engine with a lifting device and wire ropes.

(1) While lifting up the vehicle, also raise up the lifting device simultaneously.

Caution:

Be careful not to damage the vehicle with a lifting device or wire ropes.

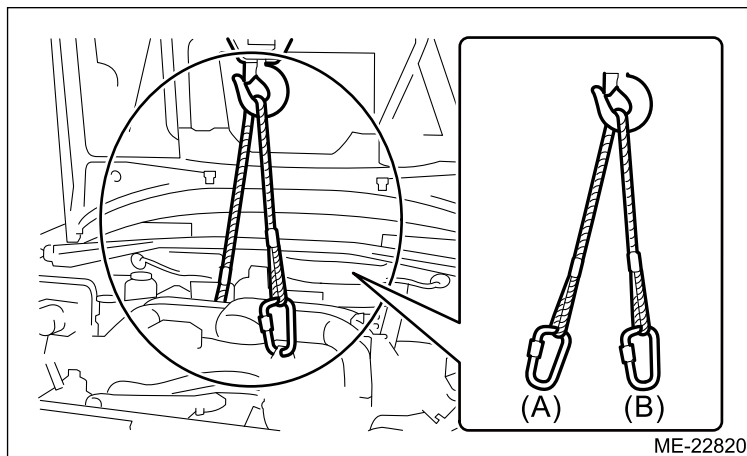

(A) To engine rear hanger

(B) To special tool

(2) Raise up the lifting device, and lift the engine body by approx. 10 mm (0.39 in).

(3) Set the transmission jack under the transmission.

Caution:

- **Be sure to perform this procedure to ensure safety in operation.**
- **Make sure that the support plates of transmission jack do not touch the oil pan.**

15. Remove the crossmember support rear and the crossmember support front.  [Ref. to FRONT SUSPENSION>Crossmember Support>REMOVAL.](#)

16. Remove the stabilizer front.  [Ref. to FRONT SUSPENSION>Stabilizer>REMOVAL > STABILIZER.](#)

17. Disconnect the tie-rod end.  [Ref. to POWER ASSISTED SYSTEM \(POWER STEERING\)>Tie-rod end>REMOVAL.](#)

18. Remove the arm assembly front.  [Ref. to FRONT SUSPENSION>Front Arm>REMOVAL.](#)

19. Remove the universal joint assembly steering.  [Ref. to POWER ASSISTED SYSTEM \(POWER STEERING\)>Universal Joint>REMOVAL.](#)

20. Remove the steering gearbox assembly.  [Ref. to POWER ASSISTED SYSTEM \(POWER STEERING\)>Electric Power Steering Gearbox>REMOVAL.](#)

21. Remove the crossmember COMPL front.

Note:

Since the crossmember is heavy, make sure that it is firmly supported so that it is level.

- (1) Support the crossmember COMPL front from the bottom side using a transmission jack.
- (2) Remove the bolts which secure the crossmember COMPL front to the body.

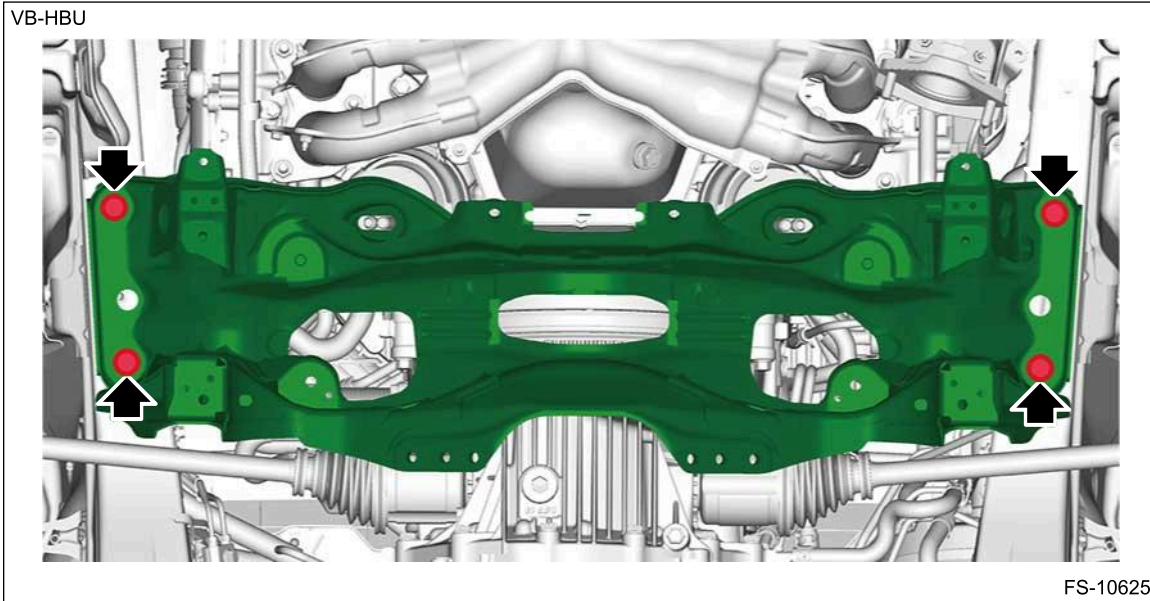

- (3) Lower the transmission jack slowly, and lower the crossmember COMPL front.

Caution:

When lowering the transmission jack, make sure that the crossmember COMPL front and the drive shaft boot do not interfere. The drive shaft boot may be damaged.

FRONT SUSPENSION > Crossmember

INSTALLATION

Caution:

- **When raising the transmission jack, make sure that the crossmember COMPL front and the drive shaft boot do not interfere. The drive shaft boot may be damaged.**
- **For the non-reusable parts, always use new parts.**
- **Always tighten the bushing in the state where the vehicle is at curb weight and the wheels are in full contact with the ground.**
- **Install the clamp stabilizer with the peak of triangle facing the front of the vehicle.**

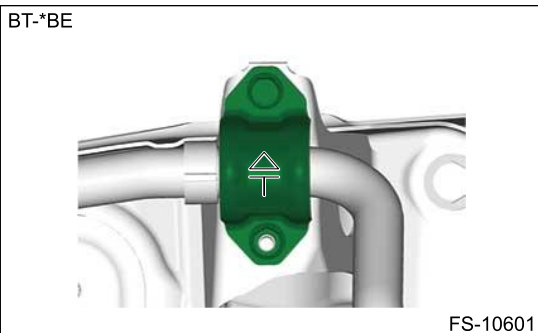

- 1.** Install the crossmember COMPL front.

Note:

- Check the crossmember for damage or cracks, and correct or replace if defective.
- Since the crossmember is heavy, make sure that it is firmly supported so that it is level.

(1) Using new bolts, install the crossmember COMPL front.

Tightening torque:

Refer to "COMPONENT" of "General Description" for the tightening torque.  [Ref. to FRONT SUSPENSION>General Description>COMPONENT > FRONT SUSPENSION.](#)

2. Lower the engine and remove the lifting device and wire ropes.
3. Remove the bolt and hanger of the ST that is installed to the engine unit.
4. Install the engine mounting and the crossmember COMPL front with new nuts.

Note:







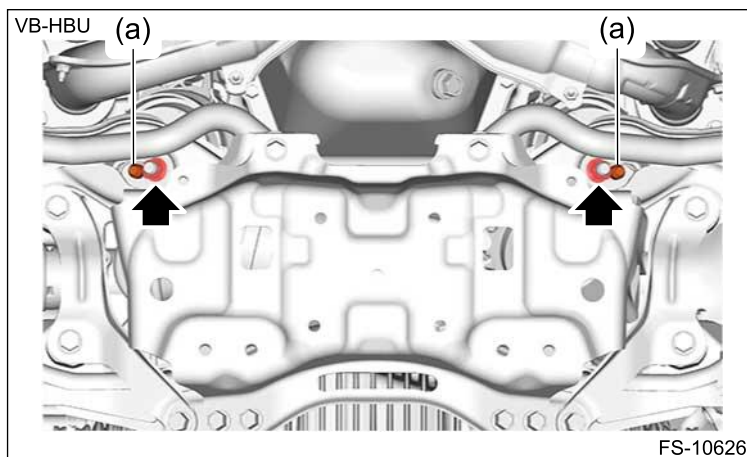

Make sure that locators (a) of the engine mounting are securely inserted.

Tightening torque:

Engine mounting – crossmember COMPL front: 90 N·m (9.2 kgf-m, 66.4 ft-lb)



5. Install the pitching stopper.  [Ref. to CONTINUOUSLY VARIABLE TRANSMISSION\(TR690\)>Transmission Mounting System>INSTALLATION > PITCHING STOPPER.](#)
6. Install the steering gearbox assembly.  [Ref. to POWER ASSISTED SYSTEM \(POWER STEERING\)>Electric Power Steering Gearbox>INSTALLATION.](#)
7. Install the universal joint assembly steering.  [Ref. to POWER ASSISTED SYSTEM \(POWER STEERING\)>Universal Joint>INSTALLATION.](#)
8. Install the arm assembly front.  [Ref. to FRONT SUSPENSION>Front Arm>INSTALLATION.](#)
9. Connect the tie-rod ends.  [Ref. to POWER ASSISTED SYSTEM \(POWER STEERING\)>Tie-rod end>INSTALLATION.](#)
10. Install the stabilizer front.  [Ref. to FRONT SUSPENSION>Stabilizer>INSTALLATION > STABILIZER.](#)
11. Install the center exhaust pipe (rear).  [Ref. to EXHAUST\(H4DOTC\)>Center Exhaust Pipe>INSTALLATION > CENTER EXHAUST PIPE \(REAR\).](#)
12. Install the crossmember support front and the crossmember support rear.  [Ref. to FRONT SUSPENSION>Crossmember Support>INSTALLATION.](#)
13. Install the under guard front.  [Ref. to EXTERIOR/INTERIOR TRIM>Front Under Cover>INSTALLATION.](#)
14. Install the front wheels.  [Ref. to WHEEL AND TIRE SYSTEM>Tire and Wheel>INSTALLATION.](#)
15. Connect the power steering harness connector and install the harness clamp.

- 16.** Install the air intake duct.  [Ref. to INTAKE \(INDUCTION\)\(H4DOTC\)>Air Intake Duct>INSTALLATION.](#)
- 17.** Install the V-belt cover.
Tightening torque:
7 N·m (0.7 kgf-m, 5.2 ft-lb)
- 18.** Set the hood COMPL front to the normal position.  [Ref. to REPAIR CONTENTS>NOTE > FRONT HOOD GAS STAY.](#)
- 19.** Install the striker assembly front hood.  [Ref. to EXTERIOR BODY PANELS>Front Hood>ASSEMBLY.](#)
- 20.** Connect the ground terminal to battery sensor.  [Ref. to REPAIR CONTENTS>NOTE > BATTERY.](#)
- 21.** Inspect the wheel alignment and adjust if necessary.
- Inspection:  [Ref. to FRONT SUSPENSION>Wheel Alignment>INSPECTION.](#)
 - Adjustment:  [Ref. to FRONT SUSPENSION>Wheel Alignment>ADJUSTMENT.](#)
- 22.** Perform VDC sensor midpoint setting mode.  [Ref. to VEHICLE DYNAMICS CONTROL \(VDC\)>VDC Control Module and Hydraulic Control Unit \(VDCCM&H/U\)>ADJUSTMENT > VDC SENSOR MIDPOINT SETTING MODE.](#)
- 23.** Perform the lane keep assist learning value clear.  [Ref. to EyeSight \(DIAGNOSTICS\)>Work Support.](#)

FRONT SUSPENSION > Front Strut

REMOVAL



1. STANDARD DAMPER MODEL

1. Remove the front wheels.  [Ref. to WHEEL AND TIRE SYSTEM>Tire and Wheel>REMOVAL.](#)
2. Remove the nut and disconnect the stabilizer link front (upper part).

VBN*AJ

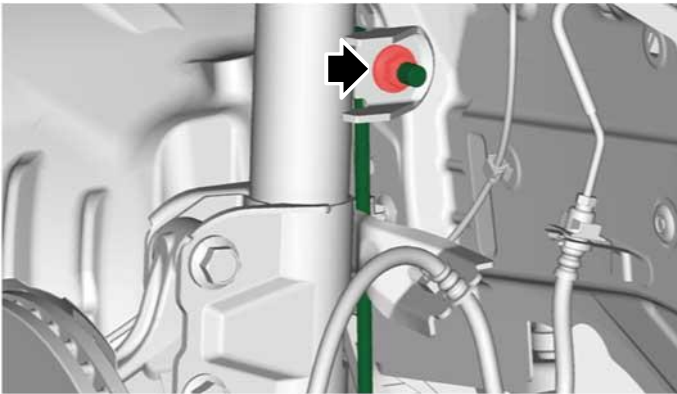

FS-10475

3. Remove the bolt and then remove the brake hose bracket.

VBN*AJ

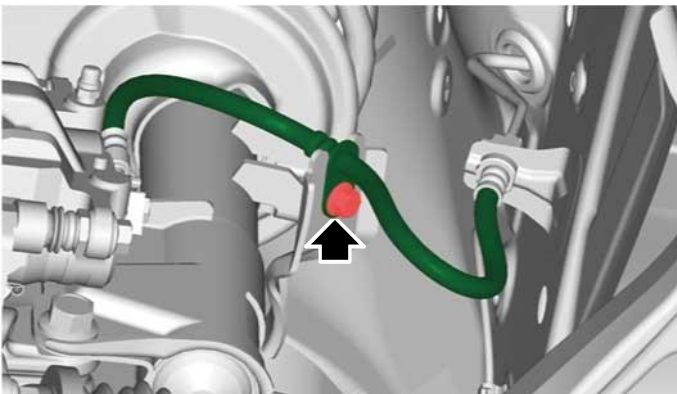

FS-10476

4. Remove the bolt and harness clip, and remove the sensor sub assembly front.

VBN*AJ

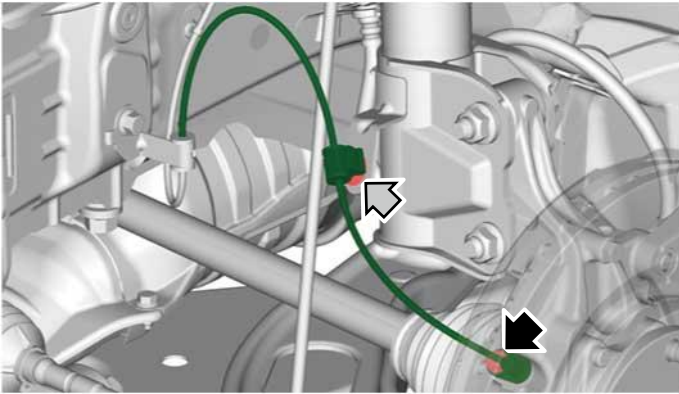

FS-10477

5. Remove the strut assembly.

- (1) Place an alignment mark (a) on the adjusting bolt and the strut assembly.
- (2) Remove the adjusting bolts and flange bolts for the strut assembly.

Caution:

Turn and remove the nut while holding the bolt side.

VBN*AJ

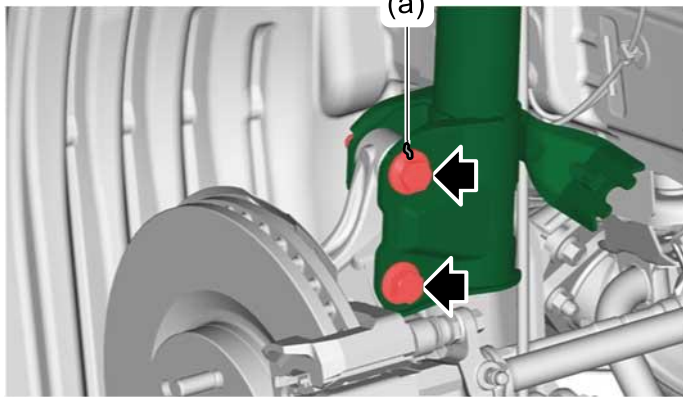

FS-10478

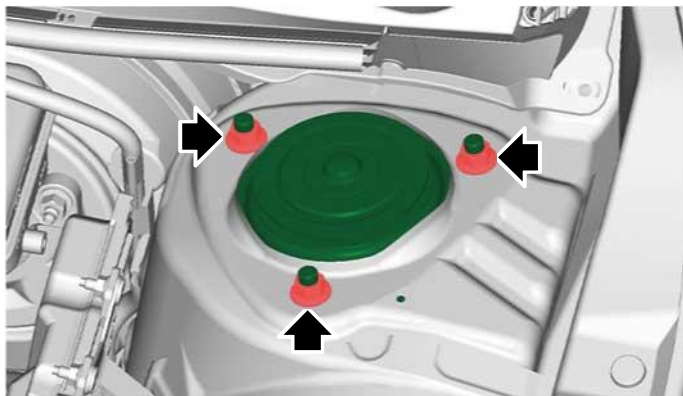

- (3) Remove the nuts, and remove the strut assembly.

VB-*CU



FS-10774

2. ELECTRONICALLY-CONTROLLED DAMPER MODEL

1. Disconnect the ground terminal from battery sensor.  [Ref. to REPAIR CONTENTS>NOTE > BATTERY.](#)
2. Remove the front wheels.  [Ref. to WHEEL AND TIRE SYSTEM>Tire and Wheel>REMOVAL.](#)
3. Remove the nut and disconnect the stabilizer link front (upper part).

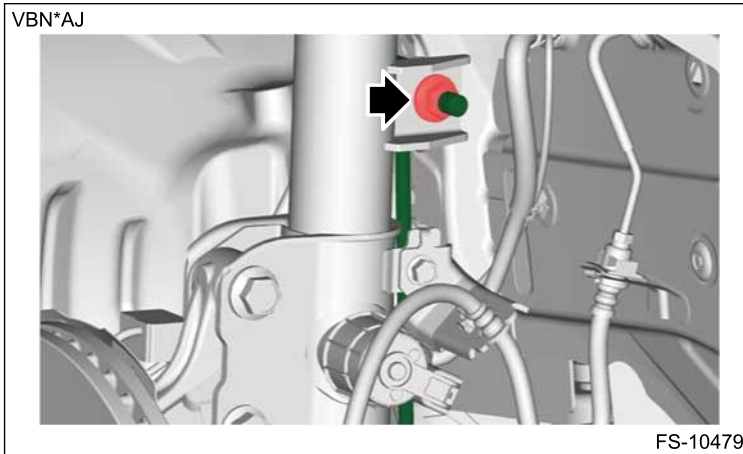

4. Remove the bolt and then remove the brake hose bracket.

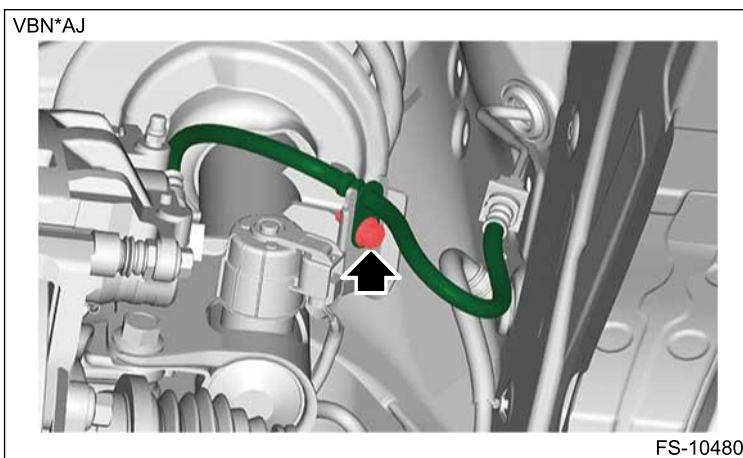

5. Remove the harness bracket and the electric damper harness ABS assembly front.
(1) Disconnect the connector.
(2) Remove the bolts, and remove the harness bracket and the electric damper harness ABS assembly front.

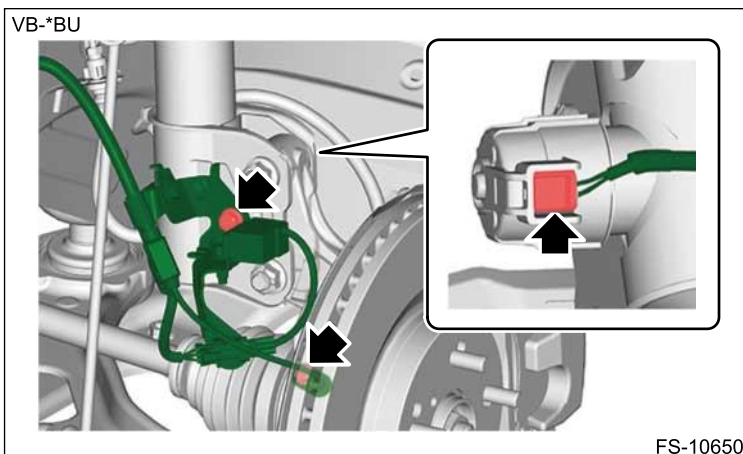

6. Remove the strut assembly.

- (1) Place an alignment mark (a) on the adjusting bolt and the strut assembly.
- (2) Remove the adjusting bolts and flange bolts for the strut assembly.

Caution:

Turn and remove the nut while holding the bolt side.

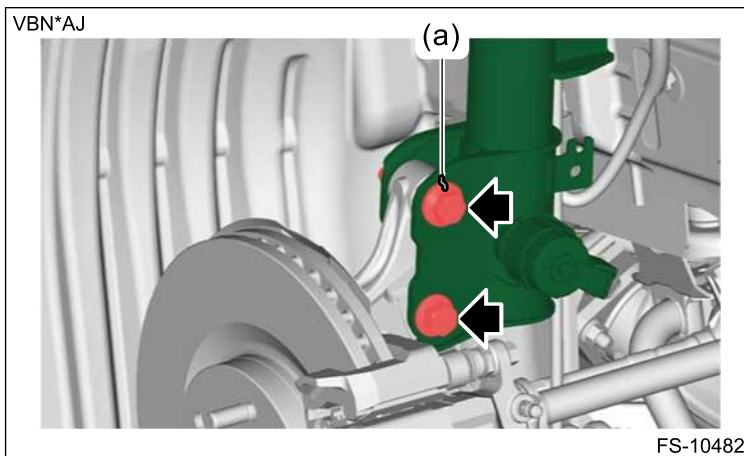

- (3) Remove the nuts, and remove the strut assembly.

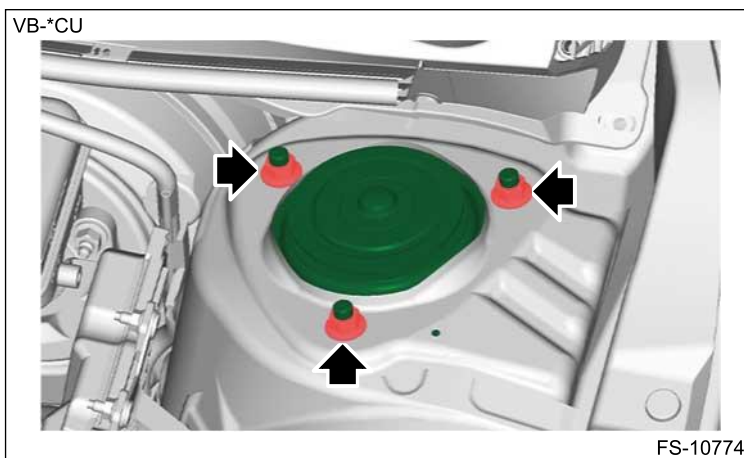

FRONT SUSPENSION > Front Strut

INSTALLATION

1. STANDARD DAMPER MODEL

Caution:

For the non-reusable parts, always use new parts.

1. Install the strut assembly.

- (1) Install the upper side of the strut assembly with new nuts.

Tightening torque:

32 N·m (3.3 kgf-m, 23.6 ft-lb)

- (2) Align alignment marks on the adjusting bolt and the strut assembly, and install the strut assembly to the front axle housing using a new flange nut.

Caution:

- While holding the bolt side, tighten the nut to the specified torque.
- Do not forget to install the adjusting washer.

Note:

First, tighten the adjusting bolt (upper side) to the specified torque.

Tightening torque:

155 N·m (15.8 kgf-m, 114.3 ft-lb)

2. Install the sensor sub assembly front.  Ref. to [VEHICLE DYNAMICS CONTROL \(VDC\)>Front ABS Wheel Speed Sensor>INSTALLATION](#).

3. Install the brake hose bracket.



Tightening torque:

33 N·m (3.4 kgf-m, 24.3 ft-lb)

4. Install the stabilizer link front.  Ref. to [FRONT SUSPENSION>Stabilizer>INSTALLATION > STABILIZER LINK](#).

5. Install the front wheels.  Ref. to [WHEEL AND TIRE SYSTEM>Tire and Wheel>INSTALLATION](#).

6. Inspect the wheel alignment and adjust if necessary.

- Inspection:  Ref. to [FRONT SUSPENSION>Wheel Alignment>INSPECTION](#).
- Adjustment:  Ref. to [FRONT SUSPENSION>Wheel Alignment>ADJUSTMENT](#).

7. Perform VDC sensor midpoint setting mode.  Ref. to [VEHICLE DYNAMICS CONTROL \(VDC\)>VDC Control Module and Hydraulic Control Unit \(VDCCM&H/U\)>ADJUSTMENT > VDC SENSOR MIDPOINT SETTING MODE](#).

8. Perform the lane keep assist learning value clear.  Ref. to [EyeSight \(DIAGNOSTICS\)>Work Support](#).

2. ELECTRONICALLY-CONTROLLED DAMPER MODEL

Caution:

For the non-reusable parts, always use new parts.

1. Install the strut assembly.

(1) Install the upper side of the strut assembly with new nuts.

Tightening torque:

32 N·m (3.3 kgf-m, 23.6 ft-lb)

(2) Align alignment marks on the adjusting bolt and the strut assembly, and install the strut assembly to the front axle housing using a new flange nut.

Caution:

- While holding the bolt side, tighten the nut to the specified torque.
- Do not forget to install the adjusting washer.

Note:

First, tighten the adjusting bolt (upper side) to the specified torque.

Tightening torque:

155 N·m (15.8 kgf-m, 114.3 ft-lb)

2. Install the harness bracket, and connect the connector.

Tightening torque:

33 N·m (3.4 kgf-m, 24.3 ft-lb)

3. Install the electric damper harness ABS assembly front.  Ref. to [VEHICLE DYNAMICS CONTROL \(VDC\)>Front ABS Wheel Speed Sensor>INSTALLATION](#).

4. Install the brake hose bracket.

Tightening torque:



33 N·m (3.4 kgf-m, 24.3 ft-lb)

5. Install the stabilizer link front.  [Ref. to FRONT SUSPENSION>Stabilizer>INSTALLATION > STABILIZER LINK.](#)

6. Install the front wheels.  [Ref. to WHEEL AND TIRE SYSTEM>Tire and Wheel>INSTALLATION.](#)

7. Connect the ground terminal to battery sensor.  [Ref. to REPAIR CONTENTS>NOTE > BATTERY.](#)

8. Inspect the wheel alignment and adjust if necessary.

- Inspection:  [Ref. to FRONT SUSPENSION>Wheel Alignment>INSPECTION.](#)
- Adjustment:  [Ref. to FRONT SUSPENSION>Wheel Alignment>ADJUSTMENT.](#)

9. Perform VDC sensor midpoint setting mode.  [Ref. to VEHICLE DYNAMICS CONTROL \(VDC\)>VDC Control Module and Hydraulic Control Unit \(VDCCM&H/U\)>ADJUSTMENT > VDC SENSOR MIDPOINT SETTING MODE.](#)

10. Perform the lane keep assist learning value clear.  [Ref. to EyeSight \(DIAGNOSTICS\)>Work Support.](#)

FRONT SUSPENSION > Front Strut

DISASSEMBLY



Caution:

- **When installing the coil spring compressor to the coil spring front, follow the operation manual accompanied with the coil spring compressor during operation.**
- **Do not use an impact wrench to compress the coil spring front.**
- **The bearing may be damaged if the spring is pressed while the spring top strongly interferes with the bearing. Be careful with the following items.**
 - **Evenly compress the spring.**
 - **Be careful so that the bearing side gap (a) is not opened wider than 5 mm (0.2 in) during operation.**

VB-*BU

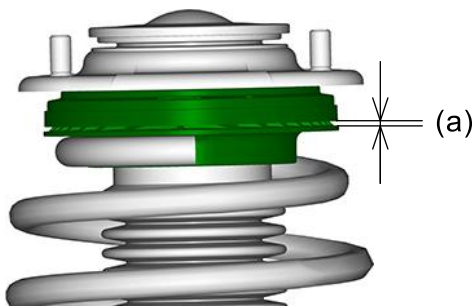

FS-10632

Note:

The procedure shows the standard damper model. For the electronically-controlled damper model, perform the procedure by referring to the standard damper model.

1. Using a coil spring compressor, compress the coil spring front.
2. Remove the dust seal.
3. Remove the mount strut front.

Note:

<Example of coil spring compressor installation>

The installing position of coil spring compressor varies depending on the coil spring front shape and winding number.

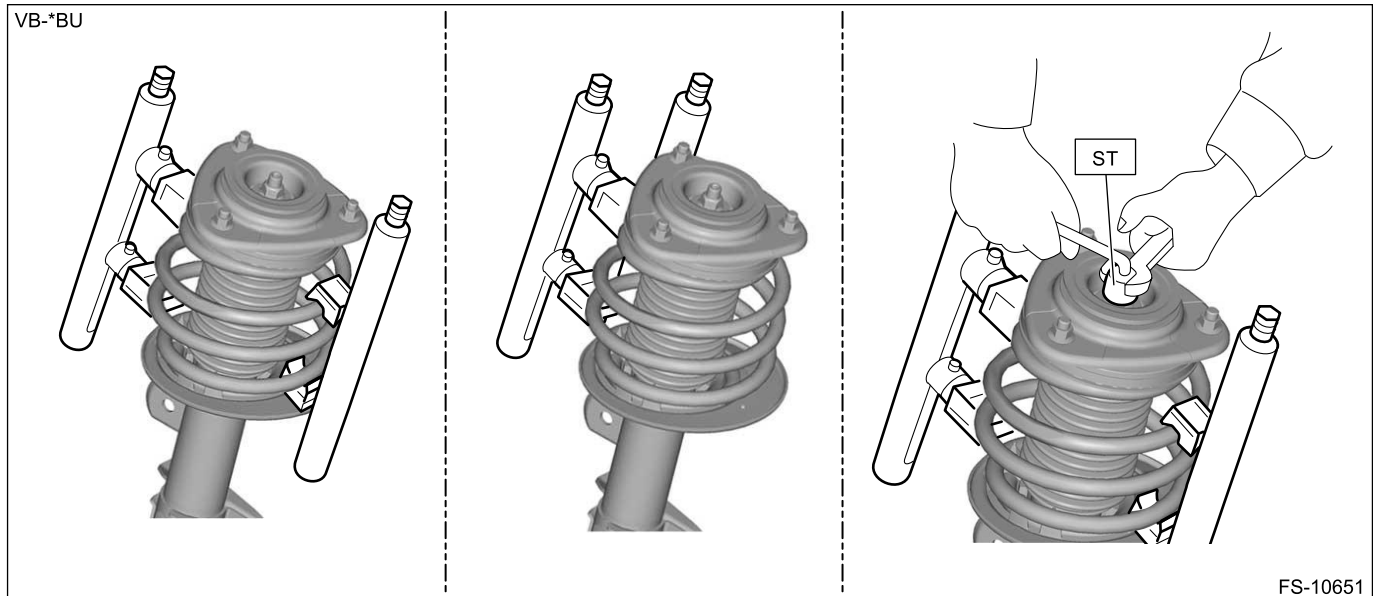

- (1) Using a hexagon wrench, prevent the strut rod of strut COMPL front from turning.
- (2) Using the ST, remove the self-locking nut.

Preparation tool:

ST: STRUT MOUNT SOCKET (20399AG000)

- (3) Remove the mount strut front, the mount bearing front and the dust cover front from the strut COMPL front.
4. Gradually decrease the compression pressure of the coil spring compressor, and remove the coil spring front.
5. Remove the helper front.
6. Remove the rubber seat LWR.

FRONT SUSPENSION > Front Strut

ASSEMBLY

Caution:

- When installing the coil spring compressor to the coil spring front, follow the operation manual accompanied with the coil spring compressor during operation.
- Do not use an impact wrench to compress the coil spring front.
- For parts which are not reusable, always use new parts.

Note:

The procedure shows the standard damper model. For the electronically-controlled damper model, perform the procedure by referring to the standard damper model.

1. Before assembly, check each part.  Ref. to [FRONT SUSPENSION>Front Strut>INSPECTION](#).
2. Using a coil spring compressor, compress the coil spring front.

Note:

Make sure that the vertical installation direction of the coil spring front is as shown in the figure.

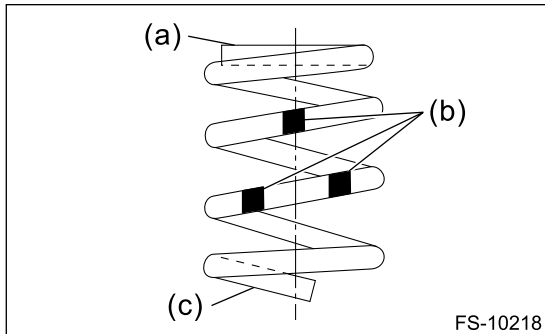

- (a) Diameter is large (upper part)
- (b) Identification paint
- (c) Diameter is small (bottom part)

3. Install the rubber seat LWR to the strut COMPL front.

Caution:

Insert the rubber seat into the protrusion of the spring seat.

Note:

Make sure the coil seating section of the rubber seat is free from foreign matters such as pebbles. Remove the foreign matters such as pebbles if any.

4. Set the coil spring front correctly so that the spring end face (a) fits within the area (c) of the cutout portion (b) of rubber seat LWR as shown in the figure.

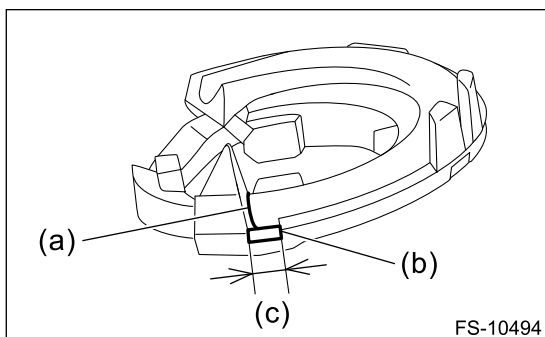

5. Install the helper front to the piston rod.
6. Pull the piston rod fully upward, and install the dust cover front.
7. Install the mount strut front.

Note:

Make sure that the mount bearing front turns smoothly after tightening.

- (1) Temporarily assemble the mount strut front and the mount bearing front, and install it to the piston rod.
- (2) Temporarily install the mount strut front with a new self-locking nut.
- (3) Using a hexagon wrench, prevent the piston rod of strut COMPL front from turning.
- (4) Using the ST, tighten the self-locking nut to the specified torque.

Preparation tool:

ST: STRUT MOUNT SOCKET (20399AG000)

Tightening torque:

55 N·m (5.6 kgf-m, 40.6 ft-lb)

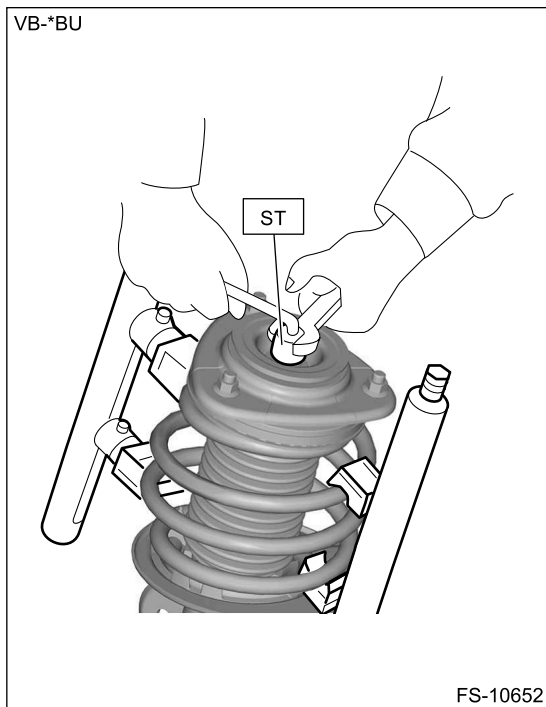

8. Loosen the coil spring compressor carefully.
9. Install the dust seal.

FRONT SUSPENSION > Front Strut

INSPECTION

1. STRUT COMPL FRONT

1. Check for oil leaks.
2. Move the piston rod up and down to check that it operates smoothly without any hitch.
3. Check the piston rod for runout using the dial gauge and magnet stand.
 - (1) Fix the outer shell.
 - (2) Extend the piston rod until it stops retracting, and set the dial gauge at the L position from the end of the piston rod.

Measuring point:

L = 10 mm (0.39 in)

- (3) While applying a force of W_1 [20 N (2 kgf, 4 lbf)] to the arrowed section, read the dial gauge indication P_1 .
- (4) While applying a force of W_2 [20 N (2 kgf, 4 lbf)] from the opposite side of W_1 , read the dial gauge indication P_2 .

Play limit (P1 + P2):

0.8 mm (0.031 in)

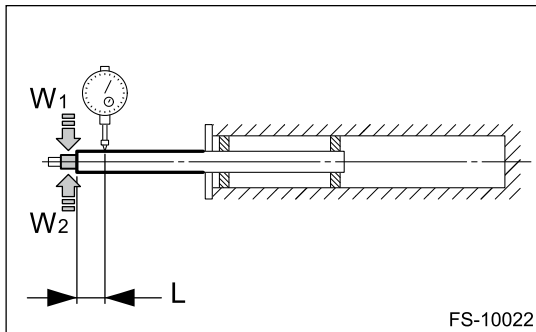

4. Replace the strut COMPL front if a fault is found in the inspection or limit value is exceeded.

2. MOUNT STRUT FRONT

Check the rubber part for deformation, major cracks or deterioration, and then replace it with a new part if defective.

3. RUBBER SEAT LWR

If cracks or damage are found, replace it with a new part.

4. MOUNT BEARING FRONT

If abnormal cracks or any abnormality in rotation are found, replace it with a new part.

5. COIL SPRING FRONT

If major cracks, damage or deformation are found on the spring and the tube, replace them with new parts.

6. HELPER FRONT

If major cracks or damage are found, replace it with a new part.

7. DUST COVER FRONT

If major cracks or damage are found, replace it with a new part.

FRONT SUSPENSION > Front Strut

DISPOSAL

Caution:

- Before handling the strut COMPL front and the shock absorber COMPL rear, be sure to wear goggles to protect eyes from gas, oil and cutting powder.
- Do not disassemble the strut COMPL front and the shock absorber COMPL rear or throw them into flames.
- When discarding the strut COMPL front and the shock absorber COMPL rear filled with gas, use a saw to make a cut on them to purge the gas.

1. Place the strut COMPL front and the shock absorber COMPL rear on a level surface with the piston rod fully expanded.
2. Use a saw and make a cut at the location shown in the figure to purge the gas.

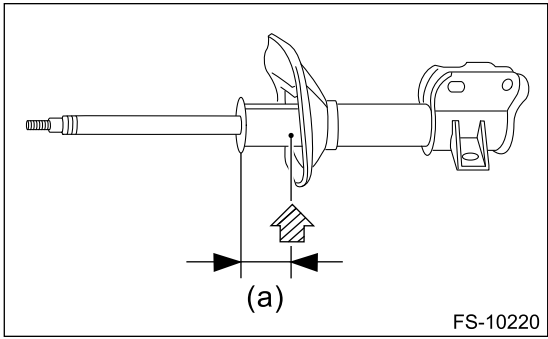



(a) 40 mm (1.57 in)

FRONT SUSPENSION > Suspension Control Module

REMOVAL

Caution:

Before handling the airbag system components, refer to "CAUTION" of "General Description" in "AIRBAG SYSTEM".  [Ref. to AIRBAG SYSTEM>General Description>CAUTION.](#)

1. Prior to starting work, check "Precautions" in the "SEATS" section.  [Ref. to SEATS>General Description>CAUTION.](#)
2. Disconnect the ground terminal from the battery sensor, and wait for at least 60 seconds before starting work.  [Ref. to REPAIR CONTENTS>NOTE > BATTERY.](#)
3. Remove the front seat LH.  [Ref. to SEATS>Front Seat>REMOVAL.](#)
4. Remove the damper CM.
 - (1) Remove the nut and harness clip.

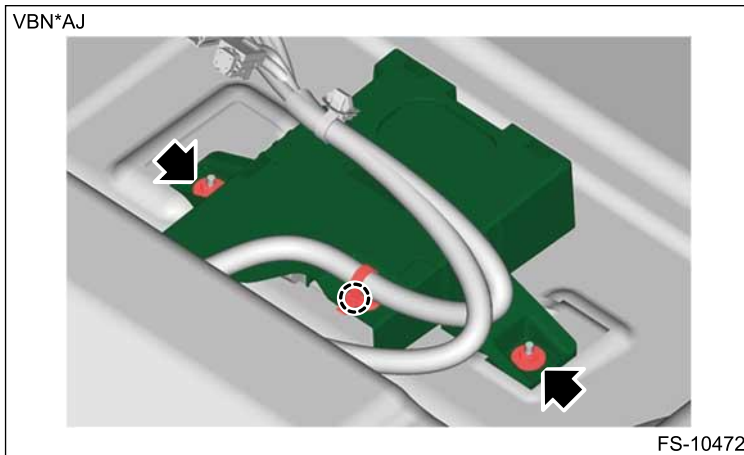

- (2) Disconnect the connector and remove the damper CM.

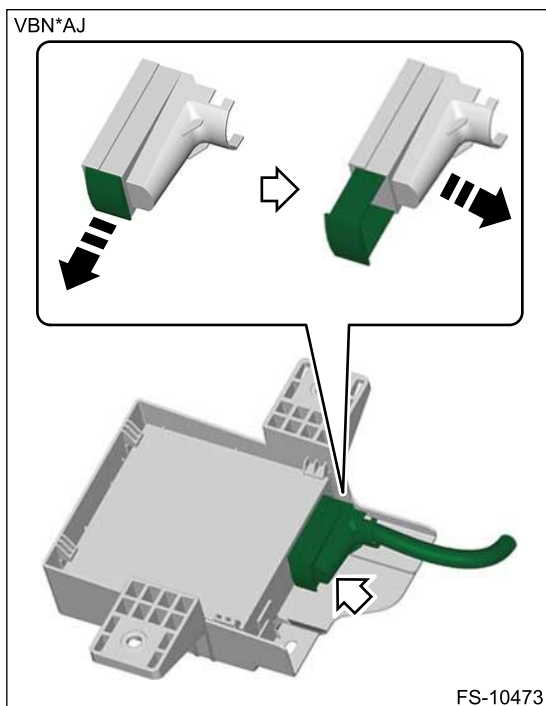

5. Release the claws, and remove the bracket damper CM.

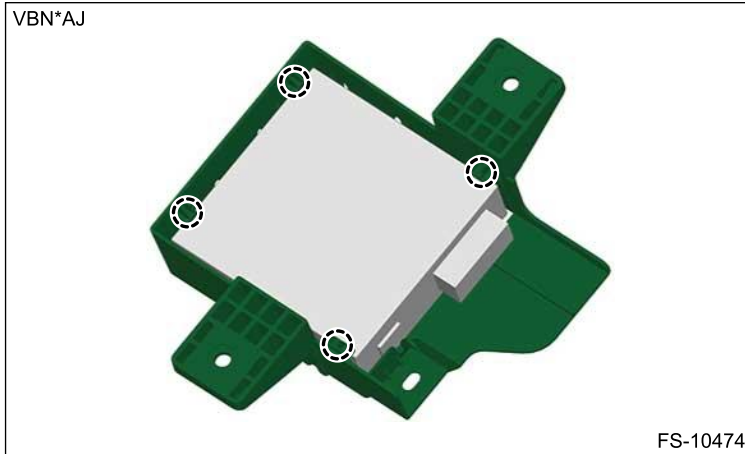



FRONT SUSPENSION > Suspension Control Module

INSTALLATION

Caution:

Before handling the airbag system components, refer to "CAUTION" of "General Description" in "AIRBAG SYSTEM".  [Ref. to AIRBAG SYSTEM>General Description>CAUTION.](#)



1. Install the damper CM.
 - (1) Install the damper CM to the bracket damper CM.
 - (2) Connect the connector to the damper CM.
 - (3) Install the bracket damper CM.

Tightening torque:
7.5 N·m (0.8 kgf-m, 5.5 ft-lb)
2. Install the front seat LH.  [Ref. to SEATS>Front Seat>INSTALLATION.](#)
3. Connect the ground terminal to battery sensor.  [Ref. to REPAIR CONTENTS>NOTE > BATTERY.](#)

FRONT SUSPENSION > G Sensor

REMOVAL



1. Disconnect the ground terminal from battery sensor.  [Ref. to REPAIR CONTENTS>NOTE > BATTERY.](#)
2. Remove the front wheels.  [Ref. to WHEEL AND TIRE SYSTEM>Tire and Wheel>REMOVAL.](#)
3. Remove the harness bracket.
 - (1) Disconnect the connector.
 - (2) Remove the bolts and then remove the harness bracket together with the G sensor.

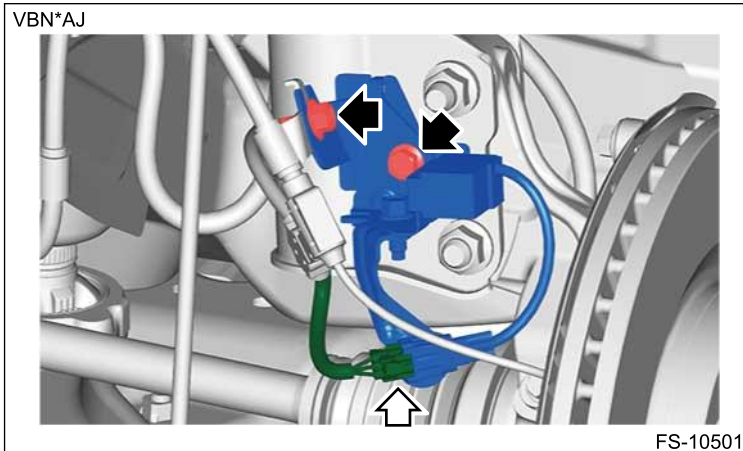

4. Remove the G sensor.
 - (1) Remove the connector clip.
 - (2) Remove the bolts, and then remove the G sensor.

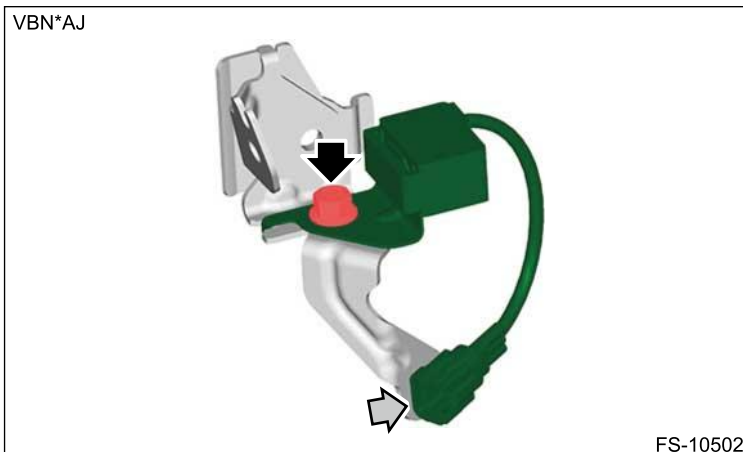

FRONT SUSPENSION > G Sensor

INSTALLATION

1. Attach the G sensor to the harness bracket.

Tightening torque:

33 N·m (3.4 kgf-m, 24.3 ft-lb)

2. Install the harness bracket, and connect the connector.

Tightening torque:

T1: 15 N·m (1.5 kgf-m, 11.1 ft-lb)

T2: 33 N·m (3.4 kgf-m, 24.3 ft-lb)

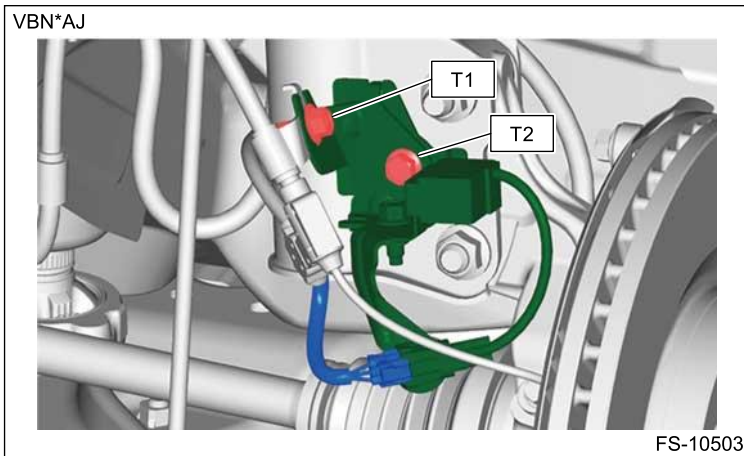

3. Install the front wheels.  [Ref. to WHEEL AND TIRE SYSTEM>Tire and Wheel>INSTALLATION.](#)
4. Connect the ground terminal to battery sensor.  [Ref. to REPAIR CONTENTS>NOTE > BATTERY.](#)

FRONT SUSPENSION > General Diagnostic Table

INSPECTION

1. IMPROPER VEHICLE POSTURE OR IMPROPER SUSPENSION HEIGHT

Possible cause	Corrective action
(1) Deformation, permanent distortion or damage of suspension parts	Replace.
(2) Rough operation of strut COMPL front or shock absorber COMPL rear	Replace.
(3) Improper installation of strut assembly or shock absorber assembly	Replace with appropriate parts.
(4) Installation of the wrong coil spring	Replace with appropriate parts.

2. POOR RIDE COMFORT

1. Large rebound shock.
2. Rocking of the vehicle continues too long after running over bump and hump.
3. Excessive shock in bumping.

Possible cause	Corrective action
(1) Damaged coil spring	Replace.
(2) Overinflation of tires	Adjust to the specified air pressure.
(3) Improper suspension height	Replace the coil springs with new parts.
(4) Defective operation of strut COMPL front or shock absorber COMPL rear	Replace.
(5) Damage or deformation of mount strut front or mount shock absorber rear	Replace.
(6) Unsuitable length (maximum or minimum) of strut COMPL front or shock absorber COMPL rear	Replace with appropriate parts.
(7) Abnormal deformation or loss of bushing	Replace.
(8) Deformation or damage of helper in strut assembly or shock absorber assembly	Replace.
(9) Oil leakage from the strut COMPL front or shock absorber COMPL rear	Replace.

3. NOISE

Possible cause	Corrective action
(1) Wear or damage of strut COMPL front or shock absorber COMPL rear component parts	Replace.
(2) Loosening of the suspension link or arm installing bolt	Tighten to the specified torque.
(3) Abnormal deformation or loss of bushing	Replace.
(4) Unsuitable length (maximum or minimum) of strut COMPL front or shock absorber COMPL rear	Replace with appropriate parts.

Possible cause	Corrective action
(5) Damaged coil spring	Replace.
(6) Wear or damage of the ball joint	Replace.
(7) Deformation of the clamp stabilizer or bushing	Replace.



REAR SUSPENSION

RS

-
1. General Description
 2. Wheel Alignment
 3. Trailing Link
 4. Rear Lateral Link (front)
 5. Rear Lateral Link (rear)
 6. Sub Frame
 7. Stabilizer
 8. Upper Arm
 9. Rear Shock Absorber
 10. Suspension Control Module
 11. General Diagnostic Table

REAR SUSPENSION > General Description

CAUTION

- When performing service operation, refer to "Repair Contents" in "General Description".  [Ref. to REPAIR CONTENTS>Repair Contents.](#)
- When performing any work, always wear work clothes, a work cap and protective shoes. Additionally, wear a helmet, protective goggles, etc. if necessary.
- When performing a repair, identify the cause of trouble and avoid unnecessary removal, disassembly and replacement.
- Do not secure a part in a vise directly. Place cushioning materials such as wood blocks, aluminum plates, or waste cloth between the part and the vise.
- Be sure that the surface of brake disc and brake pad is free from grease or oil.
- When performing work on the sensors or modules, be careful of the following.
 - Before disconnecting electrical connectors, be sure to disconnect the ground terminal from the battery sensor.  [Ref. to REPAIR CONTENTS>NOTE > BATTERY.](#)
 - Do not apply any impact. If the parts are accidentally dropped, replace with a new part.
 - Do not expose to high-temperature and humidity.
- When replacing the parts provided with memory functions, record the memory contents before disconnecting the ground terminal from the battery sensor.
- Some vehicle components are extremely hot immediately after driving. Be wary of receiving burns from heated parts.
- When handling oil or fuel, adhere to the following to prevent unexpected accident.
 - Be careful with fire.
 - Prepare a container to catch grease or oil, etc. If any grease or oil spills, wipe it off and clean immediately to prevent from penetrating into floor or flowing outside.
 - Follow all government and local regulations concerning disposal of refuse when disposing.
- Before starting works, remove dirt and corrosion around the target area.

REAR SUSPENSION > General Description

SPECIFICATION

Refer to "General Description" in "FRONT SUSPENSION" section for rear suspension specifications.  [Ref. to FRONT SUSPENSION>General Description>SPECIFICATION > REAR WHEEL ALIGNMENT \(INSPECTION VALUE\).](#)

REAR SUSPENSION > General Description

COMPONENT

1. REAR SUSPENSION

(1) Sub frame ASSY rear	(11) Rubber bushing trailing link	Tightening torque: N·m (kgf-m, ft-lb)
(2) Stopper upper	(12) Self-locking nut	T1: 30 (3.1, 22.1)
(3) Flange nut	(13) Trailing link ASSY rear	T2: 38 (3.9, 28.0)
(4) Rubber bushing stabilizer rear	(14) Rubber bushing link rear	T3: 45 (4.6, 33.2)
(5) Clamp stabilizer	(15) Rear lateral link ASSY rear	T4: 70 (7.1, 51.6)
(6) Stabilizer rear	(16) Stabilizer link rear	T5: 82.5 (8.4, 60.8)
(7) Bracket stabilizer	(17) Shock absorber ASSY rear LH	T6: 85 (8.7, 62.7)
(8) Flange bolt	(18) Rear axle housing LH (MT model)	T7: 100 (10.2, 73.8)
(9) Support sub frame front LH	(19) Rear axle housing LH (CVT model)*	T8: 145 (14.8, 106.9)
(10) Flange bolt		

*: For CVT model, rubber bushing trailing link cannot be disassembled. If the rubber bushing trailing link has been removed, replace the rear axle housing with a new part.

(1) Sub frame ASSY rear	(8) Arm ASSY rear upper LH (standard damper model)	Tightening torque: N·m (kgf-m, ft-lb)
(2) Adjusting bolt	(9) Arm ASSY rear upper LH (electronically-controlled damper model)	
(3) Rubber bushing lateral link front	(10) Snap pin	T2: 80 (8.2, 59.0)
(4) Rear lateral link ASSY front	(11) Washer (CVT model)	T3: 90 (9.2, 66.4)
(5) Adjusting washer	(12) Rear axle housing LH (CVT model)	T4: 100 (10.2, 73.8)
(6) Self-locking nut	(13) Flange bolt*	
(7) Self-locking nut	(14) Rear axle housing LH (MT model)	

*: The bolt length differs between MT model and CVT model.

2. REAR SHOCK ABSORBER

• STANDARD DAMPER MODEL

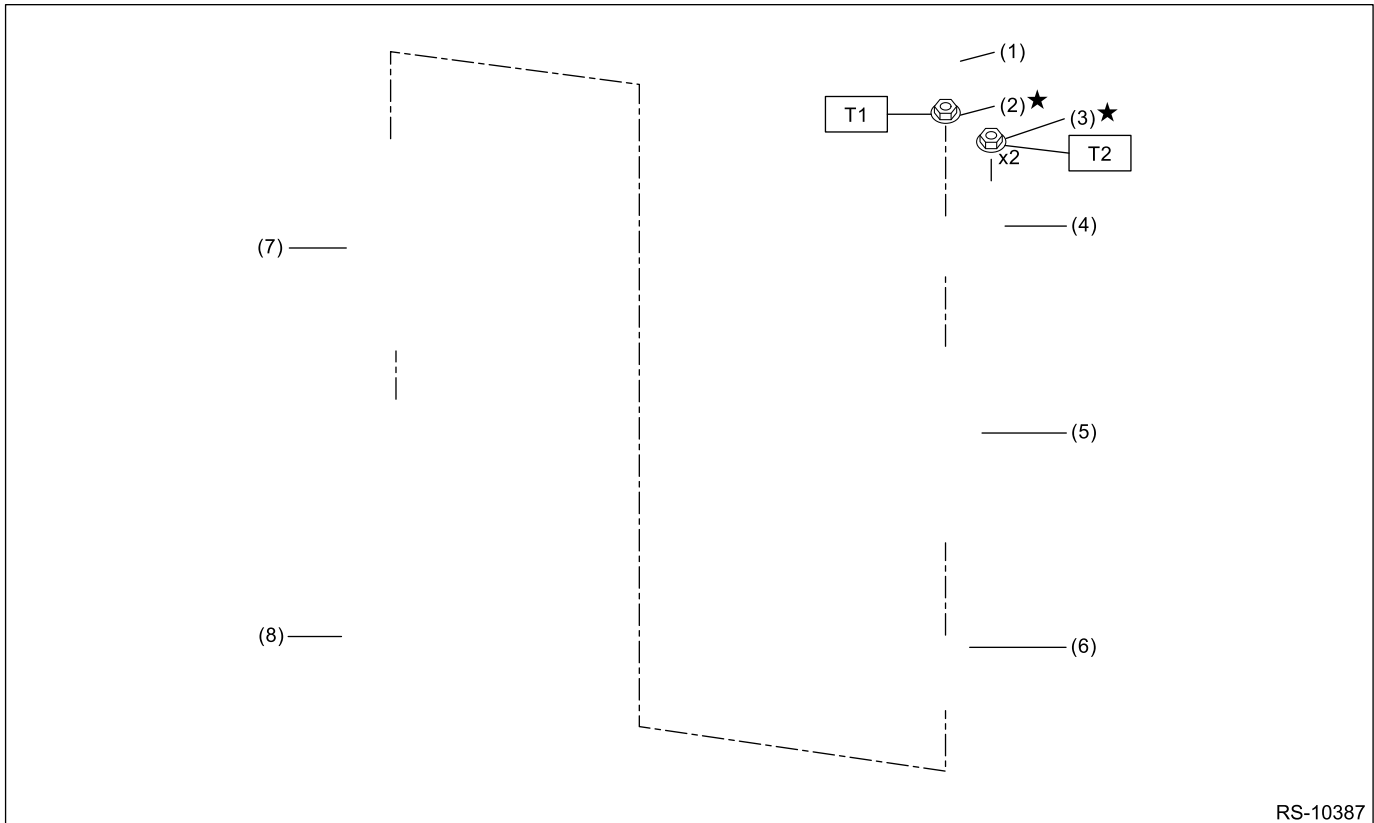

(1) Plug

(5) Dust cover rear

Tightening torque: $N \cdot m$ ($kgf \cdot m$, $ft \cdot lb$)

(2) Self-locking nut

(6) Helper rear

T1: 25 (2.5, 18.4)

(3) Flange nut

(7) Coil spring rear

T2: 30 (3.1, 22.1)

(4) Mount shock absorber rear

(8) Shock absorber COMPL rear

• ELECTRONICALLY-CONTROLLED DAMPER MODEL

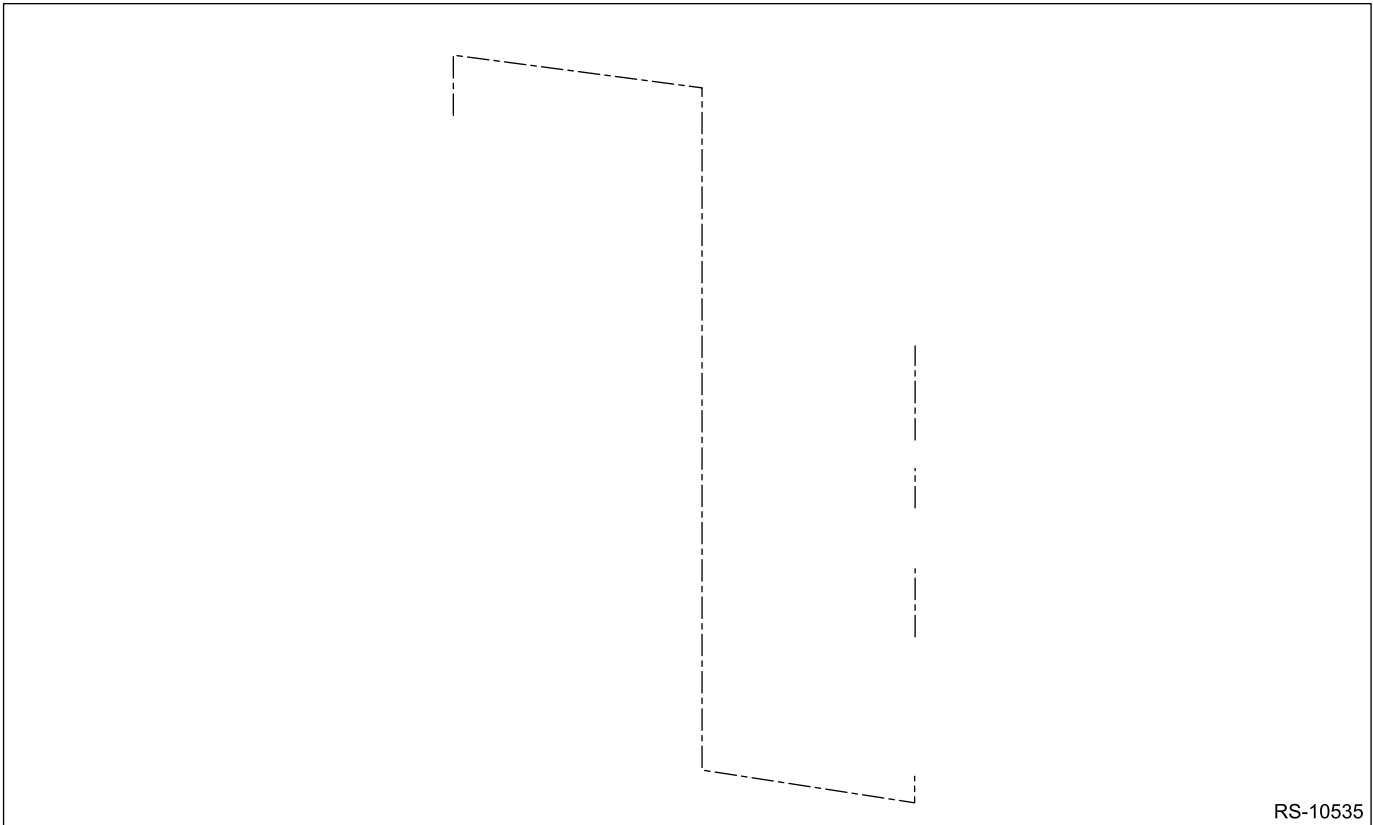

- | | |
|-------------------------------|-------------------------------|
| (1) Plug | (6) Helper rear |
| (2) Self-locking nut | (7) Dust cover rear |
| (3) Flange nut | (8) Coil spring rear |
| (4) Mount shock absorber rear | (9) Shock absorber COMPL rear |
| (5) Rubber seat UPR | |

Tightening torque: N·m (kgf·m, ft·lb)

T1: 25 (2.5, 18.4)

T2: 30 (3.1, 22.1)

3. CONTROL MODULE

For components of the control module, refer to "Control Module" in "FRONT SUSPENSION" section. 
[Ref. to FRONT SUSPENSION>General Description>COMPONENT > CONTROL MODULE.](#)

REAR SUSPENSION > General Description

PREPARATION TOOL

1. SUBARU SPECIAL TOOL

ILLUSTRATION	TOOL NUMBER	DESCRIPTION	REMARKS
 <p data-bbox="305 514 444 535">ST20099AE000</p>	20099AE000	INSTALLER & REMOVER	Used for replacing the rubber bushing lateral link front.
	20099AE010	INSTALLER & REMOVER	Used for replacing the rubber bushing link rear.
	20099FG000	BUSHING REMOVER	<ul style="list-style-type: none"> • Used for replacing the rubber bushing trailing link. • Used together with base part of INSTALLER & REMOVER (20099PA010).
	20099PA010	INSTALLER & REMOVER	<ul style="list-style-type: none"> • Used for replacing the rubber bushing trailing link. • Used together with BUSHING REMOVER (20099FG000).

ILLUSTRATION	TOOL NUMBER	DESCRIPTION	REMARKS
 <p data-bbox="305 512 443 533">ST20399FG000</p>	20399FG000	STRUT MOUNT SOCKET	<ul style="list-style-type: none"> • Used for disassembling and assembling the shock absorber assembly rear. • Used for checking center nut torque of the shock absorber assembly rear.
	—	SUBARU SELECT MONITOR 4	<p>Used for setting of each function and troubleshooting for electrical system.</p> <p>Note:</p> <ul style="list-style-type: none"> • For detailed operation procedures, refer to “Help” of application. • Used together with interface for Subaru Select Monitor (such as DST-i and DST-010).



2. OTHER

	REMARKS
Coil spring compressor	Used for disassembling and assembling the shock absorber assembly rear.
Ball joint puller	Used for disconnecting the rear lateral link assembly front.
Dial gauge	Used for measuring the runout of shock absorber COMPL rear.
Magnet stand	Used for measuring the runout of shock absorber COMPL rear.

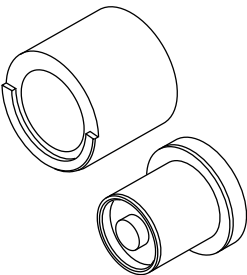
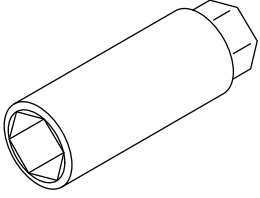
REAR SUSPENSION > Wheel Alignment

NOTE

For wheel alignment, measure or adjust the front and rear wheels at a time. Refer to "Wheel Alignment" in "FRONT SUSPENSION" section for measurement and adjustment procedures of wheel alignment.

- Inspection:  [Ref. to FRONT SUSPENSION>Wheel Alignment>INSPECTION.](#)
- Adjustment:  [Ref. to FRONT SUSPENSION>Wheel Alignment>ADJUSTMENT.](#)

REAR SUSPENSION > Trailing Link

REMOVAL



1. Remove the rear wheels.  [Ref. to WHEEL AND TIRE SYSTEM>Tire and Wheel>REMOVAL.](#)
2. Remove the nut, and remove the adapter cord EPB or the cable assembly hand brake bracket.

VB-HBU

RS-10477

3. Remove the bolts and nuts, and then remove the trailing link assembly rear.

REAR SUSPENSION > Trailing Link

INSTALLATION

Caution:

- **For the non-reusable parts, always use new parts.**
- **Always tighten the bushing in the state where the vehicle is at curb weight and the wheels are in full contact with the ground.**

1. Before installation, inspect the following items and replace any faulty part with a new one.
 - Check trailing link assembly rear for damage and deformation.
 - Check the bushing for abnormal cracks, damage or fatigue.
2. Using new bolts and new nuts, install the trailing link assembly rear.





Tightening torque:

Bolt side: 100 N·m (10.2 kgf-m, 73.8 ft-lb)

3. Install the adapter cord EPB or the cable assembly hand brake bracket.

Tightening torque:

18 N·m (1.8 kgf-m, 13.3 ft-lb)

4. Install the rear wheels.  [Ref. to WHEEL AND TIRE SYSTEM>Tire and Wheel>INSTALLATION.](#)
5. Inspect the wheel alignment and adjust if necessary.
 - Inspection:  [Ref. to FRONT SUSPENSION>Wheel Alignment>INSPECTION.](#)
 - Adjustment:  [Ref. to FRONT SUSPENSION>Wheel Alignment>ADJUSTMENT.](#)
6. Perform VDC sensor midpoint setting mode.  [Ref. to VEHICLE DYNAMICS CONTROL \(VDC\)>VDC Control Module and Hydraulic Control Unit \(VDCCM&H/U\)>ADJUSTMENT > VDC SENSOR MIDPOINT SETTING MODE.](#)
7. Perform the lane keep assist learning value clear.  [Ref. to EyeSight \(DIAGNOSTICS\)>Work Support.](#)

REAR SUSPENSION > Trailing Link

DISASSEMBLY



1. Remove the rubber bushing trailing link using ST1 and ST2.

Preparation tool:

ST1: BUSHING REMOVER (20099FG000)

ST2: INSTALLER & REMOVER (20099PA010)

REAR SUSPENSION > Trailing Link

ASSEMBLY

1. Before assembly, inspect the following items and replace any faulty part with a new one.
 - Check trailing link assembly rear for damage and deformation.
 - Check the bushing for abnormal cracks, damage or fatigue.
2. Press-fit the rubber bushing trailing link using ST1 and ST2.

Caution:

Make sure to press the bushing straight in.

Preparation tool:

ST1: BUSHING REMOVER (20099FG000)

ST2: INSTALLER & REMOVER (20099PA010)

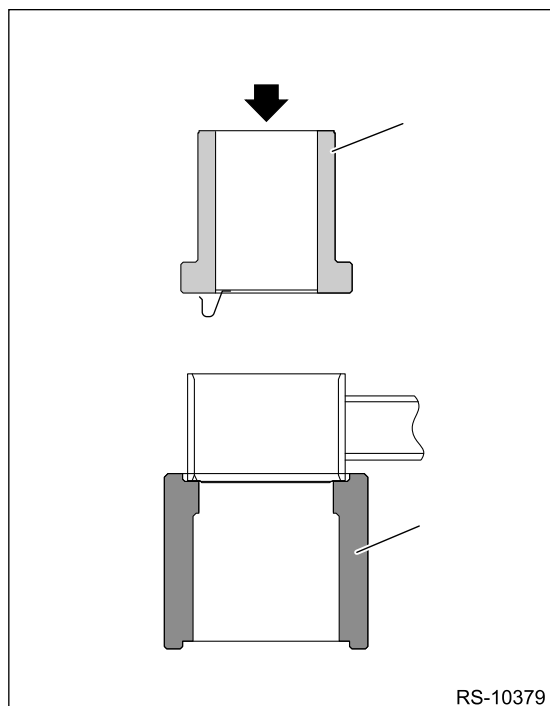



RS-10379

REAR SUSPENSION > Rear Lateral Link (front)

REMOVAL



1. MT MODEL

1. Remove the rear wheels.  [Ref. to WHEEL AND TIRE SYSTEM>Tire and Wheel>REMOVAL.](#)
2. Remove the trailing link assembly rear.  [Ref. to REAR SUSPENSION>Trailing Link>REMOVAL.](#)
3. Remove the rear lateral link assembly front.
 - (1) Remove the snap pin (a) and nut (b).
 - (2) Separate the rear axle housing and the ball joint (c) using the ball joint puller (d).

Caution:

- Be careful not to damage the boot of the ball joint.
- Be careful not to damage the peripheral parts.

Note:



Securely hook the ball joint puller (d) to the rear axle housing.

- (3) Put alignment marks (g) on the adjusting bolt for the rear lateral link assembly front and on the sub frame assembly rear.
- (4) Remove the adjusting bolt (f), and remove the rear lateral link assembly front.

Caution:

When removing the adjusting bolt (f), make sure to fix the bolt side in place and loosen the nut side (e).

2. CVT MODEL

1. Remove the rear wheels.  [Ref. to WHEEL AND TIRE SYSTEM>Tire and Wheel>REMOVAL.](#)
2. Remove the trailing link assembly rear.  [Ref. to REAR SUSPENSION>Trailing Link>REMOVAL.](#)
3. Remove the rear lateral link assembly front.
 - (1) Remove the snap pin (a), nut (b), and washer (c).

(2) Separate the rear axle housing and the ball joint (d) using the ball joint puller (e).

Caution:

- **Be careful not to damage the boot of the ball joint.**
- **Be careful not to damage the peripheral parts.**

Note:

Securely hook the ball joint puller (e) to the collar (f).

(3) Put alignment marks (i) on the adjusting bolt for the rear lateral link assembly front and on the sub frame assembly rear.

(4) Remove the adjusting bolt (h), and remove the rear lateral link assembly front.

Caution:

When removing the adjusting bolt (h), make sure to fix the bolt side in place and loosen the nut side (g).

REAR SUSPENSION > Rear Lateral Link (front)

INSTALLATION

1. MT MODEL

Caution:

- **For the non-reusable parts, always use new parts.**
- **Always tighten the bushing in the state where the vehicle is at curb weight and the wheels are in full contact with the ground.**

- 1.** Before installation, inspect the following items and replace any faulty part with a new one.
 - Check the rear lateral link assembly front for damage and deformation.
 - Check the bushing for abnormal cracks, damage or fatigue.
 - Check the boot on the ball joint for abnormal cracks, damage or fatigue.
- 2.** Install the rear lateral link assembly front.

Caution:







- Do not apply grease, etc. to the tapered portion of ball stud.
- When installing the adjusting bolt (f), make sure to fix the bolt side in place and tighten the nut side (e).
- Align alignment marks (g) on the adjusting bolt for the rear lateral link assembly front and on the sub frame.
- Be careful not to damage the boot of the ball joint.

(1) Install the rear lateral link assembly front.

Tightening torque:

Refer to "COMPONENT" of "General Description" for the tightening torques and non-reusable parts.  [Ref. to REAR SUSPENSION>General Description>COMPONENT > REAR SUSPENSION.](#)

(2) Install a new snap pin (a).

3. Install the trailing link assembly rear.  [Ref. to REAR SUSPENSION>Trailing Link>INSTALLATION.](#)
4. Install the rear wheels.  [Ref. to WHEEL AND TIRE SYSTEM>Tire and Wheel>INSTALLATION.](#)
5. Inspect the wheel alignment and adjust if necessary.
 - Inspection:  [Ref. to FRONT SUSPENSION>Wheel Alignment>INSPECTION.](#)
 - Adjustment:  [Ref. to FRONT SUSPENSION>Wheel Alignment>ADJUSTMENT.](#)
6. Perform VDC sensor midpoint setting mode.  [Ref. to VEHICLE DYNAMICS CONTROL \(VDC\)>VDC Control Module and Hydraulic Control Unit \(VDCCM&H/U\)>ADJUSTMENT > VDC SENSOR MIDPOINT SETTING MODE.](#)
7. Perform the lane keep assist learning value clear.  [Ref. to EyeSight \(DIAGNOSTICS\)>Work Support.](#)

2. CVT MODEL

Caution:

- For the non-reusable parts, always use new parts.
- Always tighten the bushing in the state where the vehicle is at curb weight and the wheels are in full contact with the ground.
- Make sure there is no clearance between rear axle housing and collar.
- If the collar comes off from the rear axle housing, replace the rear axle housing with a new part.

1. Before installation, inspect the following items and replace any faulty part with a new one.

- Check the rear lateral link assembly front for damage and deformation.
- Check the bushing for abnormal cracks, damage or fatigue.
- Check the boot on the ball joint for abnormal cracks, damage or fatigue.

2. Install the rear lateral link assembly front.

Caution:

- Do not apply grease, etc. to the tapered portion of ball stud.
- When installing the adjusting bolt (h), make sure to fix the bolt side in place and tighten the nut side (g).
- Align alignment marks (i) on the adjusting bolt for the rear lateral link assembly front and on the sub frame.
- Be careful not to damage the boot of the ball joint.
- Do not forget to install the washer.



(1) Install the rear lateral link assembly front.

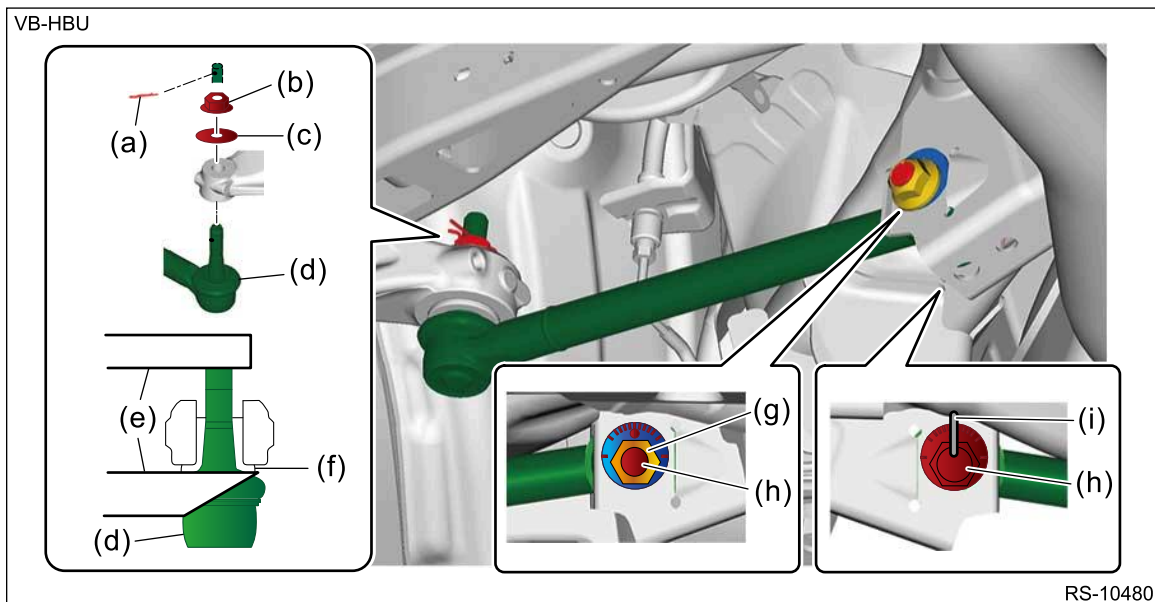

Tightening torque:

Refer to "COMPONENT" of "General Description" for the tightening torques and non-reusable parts.  Ref. to REAR SUSPENSION>General Description>COMPONENT > REAR SUSPENSION.



(2) Install a new snap pin (a).

3. Install the trailing link assembly rear.  Ref. to REAR SUSPENSION>Trailing Link>INSTALLATION.
4. Install the rear wheels.  Ref. to WHEEL AND TIRE SYSTEM>Tire and Wheel>INSTALLATION.
5. Inspect the wheel alignment and adjust if necessary.
- Inspection:  Ref. to FRONT SUSPENSION>Wheel Alignment>INSPECTION.

- Adjustment:  [Ref. to FRONT SUSPENSION>Wheel Alignment>ADJUSTMENT.](#)
6. Perform VDC sensor midpoint setting mode.  [Ref. to VEHICLE DYNAMICS CONTROL \(VDC\)>VDC Control Module and Hydraulic Control Unit \(VDCCM&H/U\)>ADJUSTMENT > VDC SENSOR MIDPOINT SETTING MODE.](#)
 7. Perform the lane keep assist learning value clear.  [Ref. to EyeSight \(DIAGNOSTICS\)>Work Support.](#)

REAR SUSPENSION > Rear Lateral Link (front)

DISASSEMBLY



1. Remove the rubber bushing lateral link front using ST1 and ST2.

Preparation tool:

ST1 & ST2: INSTALLER & REMOVER (20099AE000)

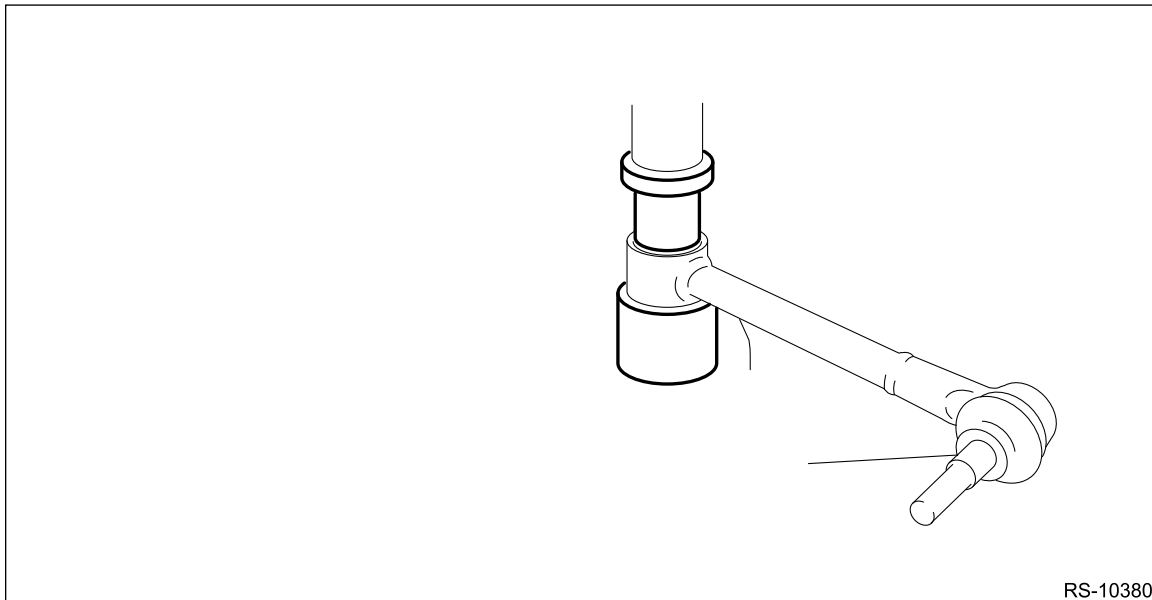

REAR SUSPENSION > Rear Lateral Link (front)

ASSEMBLY

1. Before assembly, inspect the following items and replace any faulty part with a new one.
 - Check the rear lateral link assembly front for damage and deformation.
 - Check the bushing for abnormal cracks, damage or fatigue.
 - Check the boot on the ball joint for damage.
2. Press-fit the rubber bushing lateral link front using ST1 and ST2.

Caution:

Make sure to press the bushing straight in.

Preparation tool:

ST1 & ST2: INSTALLER & REMOVER (20099AE000)

REAR SUSPENSION > Rear Lateral Link (front)

INSPECTION

1. ON THE VEHICLE INSPECTION

1. Check that there is no deformation, cracks or other damages.
2. Check for excessive rusting.
3. Rock the rear lateral link assembly front up and down to check the ball joint for looseness.

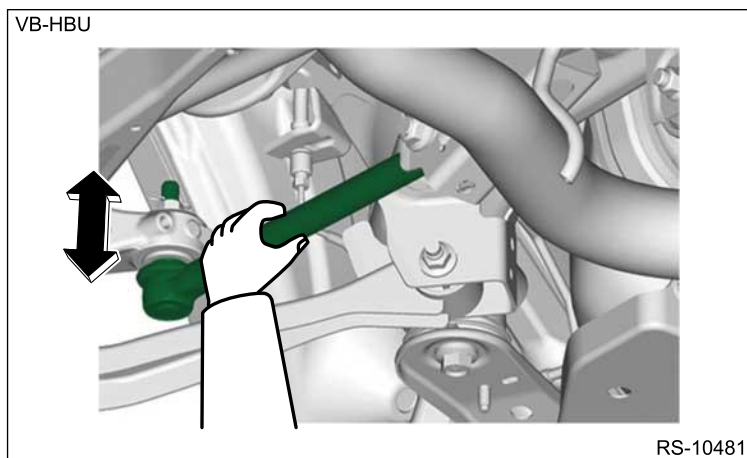

4. If fault is found in the inspection, replace the relevant part.

2. UNIT INSPECTION

1. Move the stud as shown in the figure to check that there is no abnormal interference or play.

-
- 2.** If fault is found in the inspection, replace the relevant part.

REAR SUSPENSION > Rear Lateral Link (rear)

REMOVAL



1. Remove the rear wheels.  [Ref. to WHEEL AND TIRE SYSTEM>Tire and Wheel>REMOVAL.](#)
2. Remove the rear lateral link assembly rear.
 - (1) Remove the bolts and nuts, and disconnect the stabilizer link rear.
 - (2) Remove the bolts and nuts, and remove the lower side of shock absorber assembly rear.
 - (3) Remove the bolts and nuts, and remove the rear lateral link assembly rear.

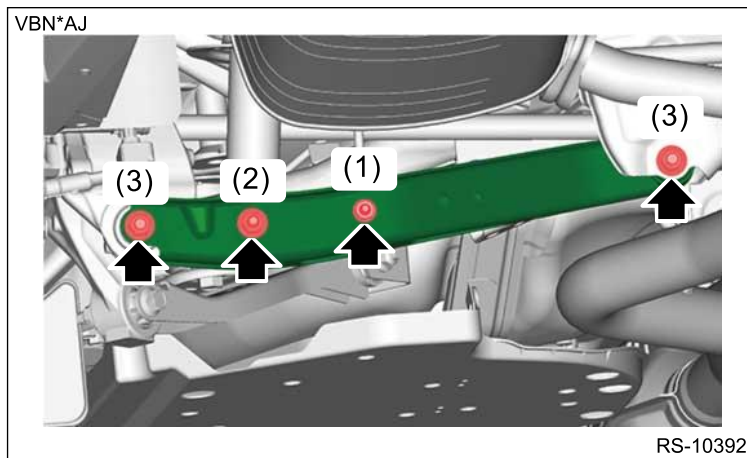





REAR SUSPENSION > Rear Lateral Link (rear)

INSTALLATION

Caution:

- **For the non-reusable parts, always use new parts.**
- **Always tighten the bushing in the state where the vehicle is at curb weight and the wheels are in full contact with the ground.**

1. Before installation, inspect the following items and replace any faulty part with a new one.
 - Check the rear lateral link assembly rear for damage and deformation.
 - Check the bushing for abnormal cracks, damage or fatigue.
2. Using new nuts, install the rear lateral link assembly rear.

Tightening torque:
Refer to "COMPONENT" of "General Description" for the tightening torque.  [Ref. to REAR SUSPENSION>General Description>COMPONENT > REAR SUSPENSION.](#)
3. Install the rear wheels.  [Ref. to WHEEL AND TIRE SYSTEM>Tire and Wheel>INSTALLATION.](#)
4. Inspect the wheel alignment and adjust if necessary.
 - Inspection:  [Ref. to FRONT SUSPENSION>Wheel Alignment>INSPECTION.](#)
 - Adjustment:  [Ref. to FRONT SUSPENSION>Wheel Alignment>ADJUSTMENT.](#)
5. Perform VDC sensor midpoint setting mode.  [Ref. to VEHICLE DYNAMICS CONTROL \(VDC\)>VDC Control Module and Hydraulic Control Unit \(VDCCM&H/U\)>ADJUSTMENT > VDC SENSOR MIDPOINT SETTING MODE.](#)

6. Perform the lane keep assist learning value clear.  [Ref. to EyeSight \(DIAGNOSTICS\)>Work Support.](#)

REAR SUSPENSION > Rear Lateral Link (rear)

DISASSEMBLY



1. Remove the rubber bushing link rear using ST1 and ST2.

Preparation tool:

ST1 & ST2: INSTALLER & REMOVER (20099AE010)

REAR SUSPENSION > Rear Lateral Link (rear)

ASSEMBLY

1. Before assembly, inspect the following items and replace any faulty part with a new one.
- Check the rear lateral link assembly rear for damage and deformation.
 - Check the bushing for abnormal cracks, damage or fatigue.
2. Press-fit the rubber bushing link rear using ST1 and ST2.

Caution:

Make sure to press the bushing straight in.











Preparation tool:

ST1 & ST2: INSTALLER & REMOVER (20099AE010)

REAR SUSPENSION > Sub Frame

REMOVAL



- 1.** Release the parking brake.
- 2.** Execute the brake maintenance mode. (CVT model)  [Ref. to PARKING BRAKE>Parking Brake System>OPERATION > BRAKE MAINTENANCE MODE.](#)
- 3.** Disconnect the ground terminal from battery sensor.  [Ref. to REPAIR CONTENTS>NOTE > BATTERY.](#)
- 4.** Release the shift lock and shift the select lever to the "N range". (CVT model)  [Ref. to CONTROL SYSTEMS>Select Lever>REMOVAL.](#)
- 5.** Remove the rear wheels.  [Ref. to WHEEL AND TIRE SYSTEM>Tire and Wheel>REMOVAL.](#)
- 6.** Remove the fuel tank protector.  [Ref. to FUEL INJECTION \(FUEL SYSTEMS\)\(H4DOTC\)>Fuel Tank Protector>REMOVAL.](#)
- 7.** Remove the rear exhaust pipe.  [Ref. to EXHAUST\(H4DOTC\)>Rear Exhaust Pipe>REMOVAL.](#)
- 8.** Remove the propeller shaft.  [Ref. to PROPELLER SHAFT / DRIVE SHAFT / AXLE>Propeller Shaft>REMOVAL.](#)
- 9.** Remove the disc brake assembly rear and brake disc rear.  [Ref. to BRAKE>Rear Disc Rotor>REMOVAL.](#)
- 10.** Remove the cable assembly hand brake from the parking lever. (MT model)  [Ref. to PARKING BRAKE>Parking Brake Assembly \(Rear Disc Brake\)>REMOVAL.](#)
- 11.** Remove the sensor sub assembly rear or the electric damper harness ABS assembly rear.  [Ref. to VEHICLE DYNAMICS CONTROL \(VDC\)>Rear ABS Wheel Speed Sensor>REMOVAL.](#)
- 12.** Disconnect the cable assembly hand brake. (MT model)
 - (1) Remove the nut and detach the clamp.
 - (2) Remove the nut and detach the clamp.
 - (3) Remove the clamp hand brake cable.

13. Disconnect the adapter cord EPB. (CVT model)

- (1) Remove the nut and detach the clamp.
- (2) Remove the nut and detach the clamp.
- (3) Remove the bolt and detach the clamp.
- (4) Disconnect the connector.

14. Remove the bolt and nut on the lower side of shock absorber assembly rear.

15. Remove the stabilizer rear.  [Ref. to REAR SUSPENSION>Stabilizer>REMOVAL > STABILIZER.](#)

16. Remove the rear suspension assembly.

(1) Support the rear suspension assembly using a transmission jack.

Note:

Since the rear suspension assembly is heavy, make sure that it is firmly supported so that it is level.







(2) Remove the bolts, and remove the support sub frame front and the bracket stabilizer.

(3) Remove the rear suspension assembly.

Note:

While checking there is no dragging of harness, lower it slowly with a transmission jack.

17. As necessary, remove each part from the sub frame assembly rear.

- Trailing link assembly rear:  [Ref. to REAR SUSPENSION>Trailing Link>REMOVAL.](#)
- Rear lateral link assembly front:  [Ref. to REAR SUSPENSION>Rear Lateral Link \(front\)>REMOVAL.](#)
- Rear lateral link assembly rear:  [Ref. to REAR SUSPENSION>Rear Lateral Link \(rear\)>REMOVAL.](#)
- Rear drive shaft:  [Ref. to PROPELLER SHAFT / DRIVE SHAFT / AXLE>Rear Drive Shaft>REMOVAL.](#)
- Rear differential:  [Ref. to DIFFERENTIALS>Rear Differential \(VB-type\)>REMOVAL.](#)
- Arm assembly rear upper:  [Ref. to REAR SUSPENSION>Upper Arm>REMOVAL.](#)
- Rear differential mount bushing:  [Ref. to DIFFERENTIALS>Rear Differential Mount Bushing>REPLACEMENT.](#)

REAR SUSPENSION > Sub Frame



INSTALLATION



Caution:

- **For the non-reusable parts, always use new parts.**
- **Always tighten the bushing in the state where the vehicle is at curb weight and the wheels are in full contact with the ground.**

1. Check the removed parts for wear, damage and crack, and repair or replace them if faulty.

2. Install each part to the sub frame assembly rear.

- Trailing link assembly rear:  [Ref. to REAR SUSPENSION>Trailing Link>INSTALLATION.](#)
- Rear lateral link assembly front:  [Ref. to REAR SUSPENSION>Rear Lateral Link \(front\)>INSTALLATION.](#)
- Rear lateral link assembly rear:  [Ref. to REAR SUSPENSION>Rear Lateral Link \(rear\)>INSTALLATION.](#)
- Rear drive shaft:  [Ref. to PROPELLER SHAFT / DRIVE SHAFT / AXLE>Rear Drive Shaft>INSTALLATION.](#)
- Rear differential:  [Ref. to DIFFERENTIALS>Rear Differential \(VB-type\)>INSTALLATION.](#)

- Arm assembly rear upper:  [Ref. to REAR SUSPENSION>Upper Arm>INSTALLATION.](#)
- Rear differential mount bushing:  [Ref. to DIFFERENTIALS>Rear Differential Mount Bushing>REPLACEMENT.](#)

3. Install the rear suspension assembly.

Caution:

Do not forget to install the stopper upper.

(1) Lift the rear suspension assembly using a transmission jack.

Note:

- **Since the rear suspension assembly is heavy, make sure that it is firmly supported so that it is level.**
- **While checking there is no dragging of harness, raise it slowly with a transmission jack.**

(2) Install the support sub frame front and the bracket stabilizer, and install the rear suspension assembly.

Tightening torque:

Refer to "COMPONENT" of "General Description" for the tightening torques and non-reusable parts.  [Ref. to REAR SUSPENSION>General Description>COMPONENT > REAR SUSPENSION.](#)

4. Install the stabilizer rear.  [Ref. to REAR SUSPENSION>Stabilizer>INSTALLATION > STABILIZER.](#)

5. Install the bolts and new nuts on the lower side of the shock absorber assembly rear.

Tightening torque:

Nut side: 85 N·m (8.7 kgf-m, 62.7 ft-lb)

6. Install the adapter cord EPB, and connect the connector. (CVT model)

Tightening torque:













18 N·m (1.8 kgf-m, 13.3 ft-lb)

7. Install the cable assembly hand brake. (MT model)

Tightening torque:

18 N·m (1.8 kgf-m, 13.3 ft-lb)

8. Install the sensor sub assembly rear or the electric damper harness ABS assembly rear.  [Ref. to VEHICLE DYNAMICS CONTROL \(VDC\)>Rear ABS Wheel Speed Sensor>INSTALLATION.](#)

- 9.** Install the cable assembly hand brake to the parking lever. (MT model)  [Ref. to PARKING BRAKE>Parking Brake Assembly \(Rear Disc Brake\)>INSTALLATION.](#)
- 10.** Install the brake disc rear and the disk brake assembly rear.  [Ref. to BRAKE>Rear Disc Rotor>INSTALLATION.](#)
- 11.** Install the propeller shaft.  [Ref. to PROPELLER SHAFT / DRIVE SHAFT / AXLE>Propeller Shaft>INSTALLATION.](#)
- 12.** Install the rear exhaust pipe.  [Ref. to EXHAUST\(H4DOTC\)>Rear Exhaust Pipe>INSTALLATION.](#)
- 13.** Install the fuel tank protector.  [Ref. to FUEL INJECTION \(FUEL SYSTEMS\)\(H4DOTC\)>Fuel Tank Protector>INSTALLATION.](#)
- 14.** Install the rear wheels.  [Ref. to WHEEL AND TIRE SYSTEM>Tire and Wheel>INSTALLATION.](#)
- 15.** Release the shift lock and shift the select lever to the "P range". (CVT model)  [Ref. to CONTROL SYSTEMS>Select Lever>INSTALLATION.](#)
- 16.** Connect the ground terminal to battery sensor.  [Ref. to REPAIR CONTENTS>NOTE > BATTERY.](#)
- 17.** Exit the brake maintenance mode. (CVT model)  [Ref. to PARKING BRAKE>Parking Brake System>OPERATION > BRAKE MAINTENANCE MODE.](#)
- 18.** After the operation is completed, apply and release the parking brake five times or so, and ensure that the brake operates normally.
- 19.** Inspect the wheel alignment and adjust if necessary.
 - Inspection:  [Ref. to FRONT SUSPENSION>Wheel Alignment>INSPECTION.](#)
 - Adjustment:  [Ref. to FRONT SUSPENSION>Wheel Alignment>ADJUSTMENT.](#)
- 20.** Perform VDC sensor midpoint setting mode.  [Ref. to VEHICLE DYNAMICS CONTROL \(VDC\)>VDC Control Module and Hydraulic Control Unit \(VDCCM&H/U\)>ADJUSTMENT > VDC SENSOR MIDPOINT SETTING MODE.](#)
- 21.** Perform the lane keep assist learning value clear.  [Ref. to EyeSight \(DIAGNOSTICS\)>Work Support.](#)

REMOVAL



1. STABILIZER LINK

Caution:

Be careful not to damage the boot of the ball joint.

1. Remove the bolts and nuts, and remove the stabilizer link rear.

2. STABILIZER BUSHING

1. Remove the rubber bushing stabilizer rear.
 - (1) Remove the bolts and remove the clamp stabilizer.
 - (2) Remove the rubber bushing stabilizer rear.

3. STABILIZER

1. Disconnect the stabilizer link rear (upper part).  [Ref. to REAR SUSPENSION>Stabilizer>REMOVAL > STABILIZER LINK.](#)
2. Remove the stabilizer rear.

- (1) Remove the bolts and remove the clamp stabilizer.
- (2) Remove the stabilizer rear.

REAR SUSPENSION > Stabilizer

INSTALLATION

1. STABILIZER LINK

Caution:

- **For the non-reusable parts, always use new parts.**
- **Always tighten the connecting area of the stabilizer link rear and rear lateral link assembly rear in the state where the vehicle is at curb weight and the wheels are in full contact with the ground.**
- **Be careful not to damage the boot of the ball joint.**

1. Before installation, check the stabilizer link rear for damage.
2. Using new nuts, install the stabilizer link rear.

Tightening torque:

Refer to "COMPONENT" of "General Description" for the tightening torque.  [Ref. to REAR SUSPENSION>General Description>COMPONENT.](#)

2. STABILIZER BUSHING

Caution:

- **Install the rubber bushing stabilizer rear so that the slit does not shift to the right or left.**
- **Install the clamp stabilizer with the peak of triangle facing the front of the vehicle.**

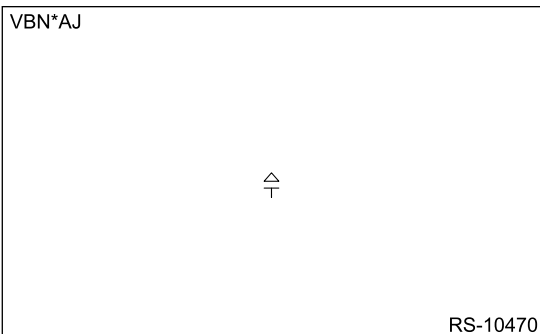

1. Before installation, check the rubber bushing stabilizer rear for abnormal cracks, fatigue or damage.
2. Install the rubber bushing stabilizer rear.
3. Install the clamp stabilizer.

Tightening torque:

30 N·m (3.1 kgf-m, 22.1 ft-lb)

3. STABILIZER

Caution:

- For the non-reusable parts, always use new parts.
- Install the rubber bushing stabilizer rear so that the slit does not shift to the right or left.
- Install the clamp stabilizer with the peak of triangle facing the front of the vehicle.

1. Before installation, inspect the following items and replace any faulty part with a new one.
 - Check the rubber bushing stabilizer rear for abnormal cracks, fatigue or damage.
 - Check the stabilizer link rear for damage.

2. Install the clamp stabilizer.

Tightening torque:

30 N·m (3.1 kgf-m, 22.1 ft-lb)

3. Using new nuts, install the stabilizer link rear (upper part).

Tightening torque:

45 N·m (4.6 kgf-m, 33.2 ft-lb)

REAR SUSPENSION > Stabilizer

INSPECTION

1. STABILIZER LINK

1. Check that there is no deformation, cracks or other damages.
2. Check for excessive rusting.
3. Move the stud as shown in the figure to check that there is no abnormal interference or play.

4. If fault is found in the inspection, replace the relevant part.





REAR SUSPENSION > Upper Arm

REMOVAL



Caution:

Be careful not to damage the boot of the ball joint.

1. Release the parking brake.
2. Execute the brake maintenance mode. (CVT model)  [Ref. to PARKING BRAKE>Parking Brake System>OPERATION > BRAKE MAINTENANCE MODE.](#)
3. Disconnect the ground terminal from battery sensor.  [Ref. to REPAIR CONTENTS>NOTE > BATTERY.](#)
4. Release the shift lock and shift the select lever to the "N range". (CVT model)  [Ref. to CONTROL SYSTEMS>Select Lever>REMOVAL.](#)
5. Remove the rear wheels.  [Ref. to WHEEL AND TIRE SYSTEM>Tire and Wheel>REMOVAL.](#)
6. Remove the rear suspension assembly.  [Ref. to REAR SUSPENSION>Sub Frame>REMOVAL.](#)
7. Remove the bolts and nuts, and remove the arm assembly rear upper.

REAR SUSPENSION > Upper Arm

INSTALLATION

Caution:

- **For the non-reusable parts, always use new parts.**
- **Always tighten the bushing in the state where the vehicle is at curb weight and the wheels are in full contact with the ground.**
- **Check if the collar is protruding from the rear axle housing. (CVT model)**
- **Do not apply grease, etc. to the ball stud shaft portion.**
- **Be careful not to damage the boot of the ball joint.**

1. Before installation, inspect the following items and replace any faulty part with a new one.
 - Check the arm assembly rear upper for damage and deformation.
 - Check the bushing for abnormal cracks, damage or fatigue.

- Check the boot on the ball joint for abnormal cracks, damage or fatigue.
2. Install the arm assembly rear upper.
 - (1) Make the installation sections of the rear lateral link assembly rear (the bolt on the rear axle housing side and the bolt on the sub frame assembly rear side) horizontal.
 - (2) Using new nuts, install the arm assembly rear upper to the sub frame assembly rear.

Tightening torque:

Nut side: 90 N·m (9.2 kgf-m, 66.4 ft-lb)

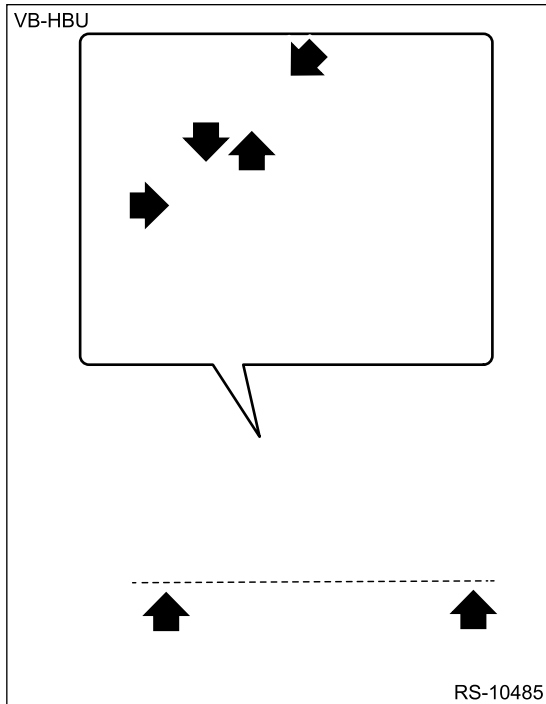







3. Using new bolts and new nuts, connect the arm assembly rear upper and the rear axle housing.

Caution:

The flange bolt length differs between MT model and CVT model. Confirm the part number before installation.

Tightening torque:

Nut side: 80 N·m (8.2 kgf-m, 59.0 ft-lb)

4. Install the rear suspension assembly.  [Ref. to REAR SUSPENSION>Sub Frame>INSTALLATION.](#)
5. Release the shift lock and shift the select lever to the "P range". (CVT model)  [Ref. to CONTROL SYSTEMS>Select Lever>INSTALLATION.](#)
6. Connect the ground terminal to battery sensor.  [Ref. to REPAIR CONTENTS>NOTE > BATTERY.](#)
7. Exit the brake maintenance mode. (CVT model)  [Ref. to PARKING BRAKE>Parking Brake System>OPERATION > BRAKE MAINTENANCE MODE.](#)
8. After the operation is completed, apply and release the parking brake five times or so, and ensure that the brake operates normally.
9. Inspect the wheel alignment and adjust if necessary.
 - Inspection:  [Ref. to FRONT SUSPENSION>Wheel Alignment>INSPECTION.](#)
 - Adjustment:  [Ref. to FRONT SUSPENSION>Wheel Alignment>ADJUSTMENT.](#)
10. Perform VDC sensor midpoint setting mode.  [Ref. to VEHICLE DYNAMICS CONTROL \(VDC\)>VDC Control Module and Hydraulic Control Unit \(VDCCM&H/U\)>ADJUSTMENT > VDC SENSOR MIDPOINT SETTING MODE.](#)

11. Perform the lane keep assist learning value clear.  [Ref. to EyeSight \(DIAGNOSTICS\)>Work Support.](#)

REAR SUSPENSION > Upper Arm

INSPECTION

1. ON THE VEHICLE INSPECTION

1. Check that there is no deformation, cracks or other damages.
2. Check for excessive rusting.
3. Rock the arm assembly rear upper up and down to check the ball joint for looseness.

4. If fault is found in the inspection, replace the relevant part.

2. UNIT INSPECTION



1. Move the stud as shown in the figure to check that there is no abnormal interference or play.

2. If fault is found in the inspection, replace the relevant part.

REAR SUSPENSION > Rear Shock Absorber

REMOVAL



1. Remove the ground terminal from battery sensor. (Electronically-controlled damper model)  [Ref. to REPAIR CONTENTS>NOTE > BATTERY.](#)
2. Remove the mat trunk and the trunk trim panel side.  [Ref. to EXTERIOR/INTERIOR TRIM>Trunk Room Trim>REMOVAL.](#)
3. Remove the rear wheels.  [Ref. to WHEEL AND TIRE SYSTEM>Tire and Wheel>REMOVAL.](#)
4. Disconnect the connector of the electronically-controlled damper, and detach the harness clip. (Electronically-controlled damper model)

5. Disconnect the rear lateral link assembly rear.
 - (1) Remove the bolt and nut on the lower side of stabilizer link rear.
 - (2) Remove the bolt and nut on the lower side of shock absorber assembly rear.
 - (3) Remove the bolt and nut, and disconnect the rear axle housing and the rear lateral link assembly rear.

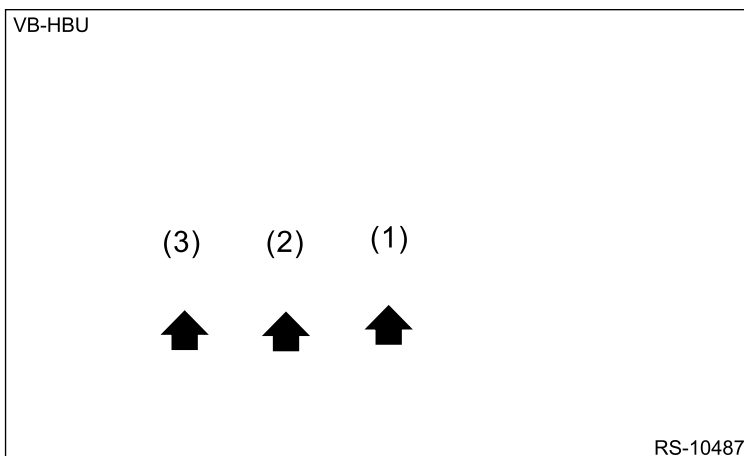

6. Remove the nuts on the upper side of shock absorber assembly rear.

7. Lower the rear lateral link assembly rear, and remove the shock absorber assembly rear.

REAR SUSPENSION > Rear Shock Absorber

INSTALLATION

Caution:





- For the non-reusable parts, always use new parts.
- Always tighten the bushing in the state where the vehicle is at curb weight and the wheels are in full contact with the ground.



1. Install the shock absorber assembly rear.
 - (1) Lower the rear lateral link assembly rear, and place the shock absorber assembly rear in position.
 - (2) Using new nuts, install the upper side of shock absorber assembly rear.

Tightening torque:
30 N·m (3.1 kgf-m, 22.1 ft-lb)
 - (3) Using new nuts, connect the shock absorber assembly rear.

Tightening torque:
Nut side: 85 N·m (8.7 kgf-m, 62.7 ft-lb)
 - (4) Using new nuts, connect the rear lateral link assembly rear.

Tightening torque:
Nut side: 82.5 N·m (8.4 kgf-m, 60.8 ft-lb)
 - (5) Using new nuts, install the lower side of stabilizer link rear.

Tightening torque:
Nut side: 38 N·m (3.9 kgf-m, 28.0 ft-lb)
2. Install the connector and the harness clip of the electronically-controlled damper. (Electronically-controlled damper model)
3. Install the rear wheels.  [Ref. to WHEEL AND TIRE SYSTEM>Tire and Wheel>INSTALLATION.](#)
4. Install the trunk trim panel side and the mat trunk.  [Ref. to EXTERIOR/INTERIOR TRIM>Trunk Room Trim>INSTALLATION.](#)
5. Connect the ground terminal to battery sensor. (Electronically-controlled damper model)  [Ref. to REPAIR CONTENTS>NOTE > BATTERY.](#)
6. Inspect the wheel alignment and adjust if necessary.
 - Inspection:  [Ref. to FRONT SUSPENSION>Wheel Alignment>INSPECTION.](#)
 - Adjustment:  [Ref. to FRONT SUSPENSION>Wheel Alignment>ADJUSTMENT.](#)

7. Perform VDC sensor midpoint setting mode.  [Ref. to VEHICLE DYNAMICS CONTROL \(VDC\)>VDC Control Module and Hydraulic Control Unit \(VDCCM&H/U\)>ADJUSTMENT > VDC SENSOR MIDPOINT SETTING MODE.](#)
8. Perform the lane keep assist learning value clear.  [Ref. to EyeSight \(DIAGNOSTICS\)>Work Support.](#)

REAR SUSPENSION > Rear Shock Absorber

DISASSEMBLY



1. STANDARD DAMPER MODEL

Caution:

- **When installing the coil spring compressor to the coil spring rear, follow the operation manual accompanied with the coil spring compressor during operation.**
- **Do not use an impact wrench to compress the coil spring rear.**

1. Using a coil spring compressor, compress the coil spring rear.
2. Remove the mount shock absorber rear.

Note:

<Example of coil spring compressor installation>

The installing position of coil spring compressor varies depending on the coil spring rear shape and winding number.

- (1) Using a hexagon wrench, prevent the piston rod of shock absorber COMPL rear from turning.
- (2) Using the ST, remove the self-locking nut.

Preparation tool:

ST: STRUT MOUNT SOCKET (20399FG000)

- (3) Remove the mount shock absorber rear from the shock absorber COMPL rear.

3. Gradually decrease the compression pressure of the coil spring compressor, and remove the coil spring rear.
4. Remove the helper rear and the dust cover rear.

2. ELECTRONICALLY-CONTROLLED DAMPER MODEL

Caution:

- When installing the coil spring compressor to the coil spring rear, follow the operation manual accompanied with the coil spring compressor during operation.
- Do not use an impact wrench to compress the coil spring rear.

1. Using a coil spring compressor, compress the coil spring rear.
2. Remove the mount shock absorber rear.

Note:

<Example of coil spring compressor installation>

The installing position of coil spring compressor varies depending on the coil spring rear shape and winding number.

- (1) Using a hexagon wrench, prevent the piston rod of shock absorber COMPL rear from turning.
- (2) Using the ST, remove the self-locking nut.

Preparation tool:

ST: STRUT MOUNT SOCKET (20399FG000)

- (3) Remove the mount shock absorber rear from the shock absorber COMPL rear.
3. Remove the dust cover rear and the rubber seat UPR.
4. Gradually decrease the compression pressure of the coil spring compressor, and remove the coil spring rear.
5. Remove the helper rear from the mount shock absorber rear.

REAR SUSPENSION > Rear Shock Absorber

ASSEMBLY

1. STANDARD DAMPER MODEL

Caution:

- For the non-reusable parts, always use new parts.
- When installing the coil spring compressor to the coil spring rear, follow the operation manual accompanied with the coil spring compressor during operation.
- Do not use an impact wrench to compress the coil spring rear.

1. Before assembly, check each part.  [Ref. to REAR SUSPENSION>Rear Shock Absorber>INSPECTION.](#)
2. Using a coil spring compressor, compress the coil spring rear.
3. Install by aligning the edge surface of the coil spring rear with the stopper portion of the lower side spring seat.

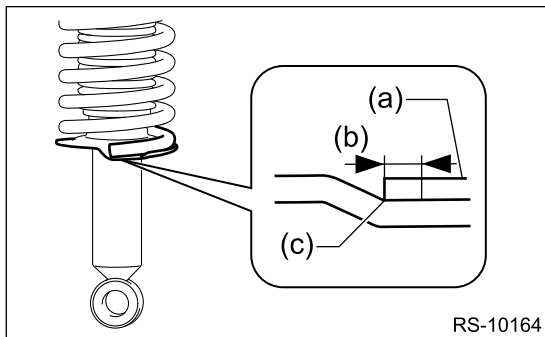

- (a) Coil spring rear
(b) 0 – 10 mm (0 – 0.39 in)
(c) Spring seat stopper portion

4. Install the helper rear and dust cover rear to the piston rod.
5. Fully pull up the piston rod in the upward direction.
6. Install the mount shock absorber rear.
 - (1) Temporarily install the mount shock absorber rear with new self-locking nuts.

Note:

Position the mount shock absorber as shown in the figure.

A LH side

B RH side

- (a) Front side of vehicle
- (b) Vehicle outside
- (c) $10^{\circ} \pm 5^{\circ}$
- (d) End portion of coil spring rear
- (e) Identification paint (Install with the paint facing the vehicle inside.)

- (2) Using a hexagon wrench, prevent the piston rod of shock absorber COMPL rear from turning.
- (3) Using the ST, tighten the self-locking nut to the specified torque.

Preparation tool:

ST: STRUT MOUNT SOCKET (20399FG000)

Tightening torque:

25 N·m (2.5 kgf-m, 18.4 ft-lb)

- 7.** Loosen the coil spring compressor while being careful that the coil spring rear and the spring seat seating surface are not misaligned.

2. ELECTRONICALLY-CONTROLLED DAMPER MODEL

Caution:

- **For the non-reusable parts, always use new parts.**
- **When installing the coil spring compressor to the coil spring rear, follow the operation manual accompanied with the coil spring compressor during operation.**
- **Do not use an impact wrench to compress the coil spring rear.**

- 1.** Before assembly, check each part.  [Ref. to REAR SUSPENSION>Rear Shock Absorber>INSPECTION.](#)

2. Using a coil spring compressor, compress the coil spring rear.
3. Install by aligning the edge surface of the coil spring rear with the stopper portion of the lower side spring seat.

- (a) Coil spring rear
- (b) 0 – 10 mm (0 – 0.39 in)
- (c) Spring seat stopper portion

4. Install the helper rear to the mount shock absorber rear.
5. Set the dust cover rear and the rubber seat UPR to the upper end of the coil spring rear.
6. Fully pull up the piston rod in the upward direction.
7. Install the mount shock absorber rear.
 - (1) Temporarily install the mount shock absorber rear with new self-locking nuts.

Note:

Position the mount shock absorber as shown in the figure.

- A LH side
- B RH side
- (a) Front side of vehicle
- (b) Vehicle outside

- (c) $10^{\circ} \pm 5^{\circ}$
- (d) End portion of coil spring rear
- (e) Identification paint (Install with the paint facing the vehicle inside.)

- (2) Using a hexagon wrench, prevent the piston rod of shock absorber COMPL rear from turning.
- (3) Using the ST, tighten the self-locking nut to the specified torque.

Preparation tool:

ST: STRUT MOUNT SOCKET (20399FG000)

Tightening torque:

25 N·m (2.5 kgf-m, 18.4 ft-lb)

- 8.** Loosen the coil spring compressor while being careful that the coil spring rear and the spring seat seating surface are not misaligned.

REAR SUSPENSION > Rear Shock Absorber

INSPECTION

1. SHOCK ABSORBER COMPL REAR

- 1.** Check for oil leaks.
- 2.** Move the piston rod up and down to check that it operates smoothly without any hitch.
- 3.** Check the piston rod for runout using the dial gauge and magnet stand.
 - (1) Fix the outer shell.
 - (2) Extend the piston rod until it stops retracting, and set the dial gauge at the L position from the end of the piston rod.

Measuring point:

L = 10 mm (0.39 in)

- (3) While applying a force of W_1 [20 N (2 kgf, 4 lbf)] to the arrowed section, read the dial gauge indication P_1 .
- (4) While applying a force of W_2 [20 N (2 kgf, 4 lbf)] from the opposite side of W_1 , read the dial gauge indication P_2 .

Play limit (P1 + P2):

0.8 mm (0.031 in)

- 4.** Replace the shock absorber COMPL rear if a fault is found in the inspection or limit value is exceeded.

2. MOUNT SHOCK ABSORBER REAR

- Check the rubber part for deformation, major cracks or deterioration, and then replace it with a new part if defective. (Standard damper model)
- Check the sealing rubber part for deformation, major cracks or deterioration, and then replace it with a new part if defective. (Electronically-controlled damper model)
- Check the polyurethane section for deformation, major cracks or deterioration, and then replace it with a new part if defective. (Electronically-controlled damper model)

3. COIL SPRING REAR

If major cracks, damage or deformation are found on the spring and the tube, replace them with new parts.

4. HELPER REAR

If major cracks or damage are found, replace it with a new part.

5. DUST COVER REAR

If major cracks or damage are found, replace it with a new part.

6. RUBBER SEAT UPR (ELECTRONICALLY-CONTROLLED DAMPER MODEL)

If major cracks or damage are found, replace it with a new part.

REAR SUSPENSION > Rear Shock Absorber

DISPOSAL

Refer to "Front Strut" in "FRONT SUSPENSION" section for disposal procedures.  [Ref. to FRONT SUSPENSION>Front Strut>DISPOSAL.](#)

REAR SUSPENSION > Suspension Control Module

NOTE

For operation procedures of the control module, refer to "Suspension Control Module" in "FRONT SUSPENSION" section.  [Ref. to FRONT SUSPENSION>Suspension Control Module.](#)

REAR SUSPENSION > General Diagnostic Table

NOTE

For general diagnostic table, refer to "General Diagnostic Table" in "FRONT SUSPENSION" section. 

[Ref. to FRONT SUSPENSION>General Diagnostic Table>INSPECTION.](#)

WHEEL AND TIRE SYSTEM

WT

-
1. General Description
 2. Tire and Wheel
 3. Temporary Tire
 4. Tire Pressure Monitoring System
 5. Tire Repair Kit
 6. General Diagnostic Table

WHEEL AND TIRE SYSTEM > General Description

CAUTION

- When performing service operation, refer to "Repair Contents" in "General Description". [Ref. to REPAIR CONTENTS>Repair Contents.](#)
- When performing any work, always wear work clothes, a work cap and protective shoes. Additionally, wear a helmet, protective goggles, etc. if necessary.
- When performing work on the sensors or modules, be careful of the following.
 - Before disconnecting electrical connectors, be sure to disconnect the ground terminal from the battery sensor. [Ref. to REPAIR CONTENTS>NOTE > BATTERY.](#)
 - Do not apply any impact. If the parts are accidentally dropped, replace with a new part.
 - Do not expose to high-temperature and humidity.
- Refer to "CAUTION" of "General Description" in "AIRBAG SYSTEM" section. [Ref. to AIRBAG SYSTEM>General Description>CAUTION.](#)

WHEEL AND TIRE SYSTEM > General Description

SPECIFICATION

1. NOTE

- (a) Inset
- (b) P.C.D.

Note:

- **Size and inflation pressure of the standard equipment tire, temporary tire and appropriate tire for equipment are described on the "Tire inflation pressure" label attached to the body side of the driver's door.**
- **A temporary tire is equipped instead of the tire puncture repair kit depending on the destination.**

2. STANDARD EQUIPMENT TIRE & WHEEL

Tire size	Wheel size	Inset mm (in)	P.C.D. mm (in)	Tire inflation pressure kPa (kgf/cm ² , psi)	
				Front wheel	Rear wheel
245/40R18 97Y	18 8 ¹ / ₂ J	55 (2.17)	114.3 (4.5)	230 (2.3, 33)	220 (2.2, 32)

Tire size	Wheel size	Inset mm (in)	P.C.D. mm (in)	Tire inflation pressure kPa (kgf/cm ² , psi)	
				Front wheel	Rear wheel
245/35R19 93Y	19 8 ¹ / ₂ J	55 (2.17)	114.3 (4.5)	240 (2.4, 35)	220 (2.2, 32)

3. TEMPORARY TIRE & WHEEL

Tire size	Wheel size	Inset mm (in)	P.C.D. mm (in)	Tire inflation pressure kPa (kgf/cm ² , psi)	
				Front wheel	Rear wheel
205/50R17 89V	17 7J	55 (2.17)	114.3 (4.5)	Not used	250 (2.5, 36)

4. SERVICE DATA

Part	Axial runout	Radial runout
Alloy wheel	1 mm (0.04 in)	

Wheel balancing	Standard	Service limit
Dynamic unbalance	5 g (0.18 oz) or less	

WHEEL AND TIRE SYSTEM > General Description

LOCATION

1. TIRE PRESSURE MONITORING SYSTEM

For location, refer to "Electrical Component Location" for the "TIRE PRESSURE MONITOR (DIAGNOSTICS)" section. [Ref. to TIRE PRESSURE MONITOR\(DIAGNOSTICS\)>Electrical Component Location.](#)

WHEEL AND TIRE SYSTEM > General Description

COMPONENT

- | | | |
|-----------------|--|---|
| (1) TPMS CM | (4) Transmitter (tire inflation pressure sensor) | Tightening torque: N·m (kgf-m, ft-lb)
T1: 1.4 (0.1, 1.0)
T2: 13 (1.3, 9.6) |
| (2) Washer* | (5) Valve | |
| (3) TORX® screw | | |

*: Unnecessary if TPMS CM is reinstalled.

WHEEL AND TIRE SYSTEM > General Description

PREPARATION TOOL

1. SUBARU SPECIAL TOOL

ILLUSTRATION	TOOL NUMBER	DESCRIPTION	REMARKS
	—	SUBARU SELECT MONITOR 4	Used for setting of each function and troubleshooting for electrical system. Note: <ul style="list-style-type: none"> • For detailed operation procedures, refer to “Help” of application. • Used together with interface for Subaru Select Monitor (such as DST-i and DST-010).

2. OTHER

	REMARKS
Air pressure gauge	Used for measuring tire air pressure.
Circuit tester	Used for measuring resistance, voltage and current.
Dial gauge	Used for measuring wheel runout.
Transmitter registration tool	Used to register the transmitter ID.

	REMARKS
	<p>Manufacturer: Latest model of ATEQ Corp. Or, use an ATEQ model with the updated software compatible with Generation6 transmitter.</p> <div style="border: 1px solid black; padding: 5px;"> <p>Note: For details of the software update, registration procedures and retailers, contact ATEQ in your country.</p> </div>
TORX® T10	Used for removing and installing transmitter (tire inflation pressure sensor).
Wheel balancer	Used for adjusting wheel balance.
Magnet stand	Used for measuring wheel runout.

WHEEL AND TIRE SYSTEM > Tire and Wheel

REMOVAL

1. Lift up the vehicle.
2. Remove the wheel nut.
3. Remove the wheels.

Caution:

When removing the wheels, be careful not to damage the hub bolts.

WHEEL AND TIRE SYSTEM > Tire and Wheel

INSTALLATION

1. Install the wheels to vehicle.
2. Temporarily install the wheel nuts.
3. Lower the vehicle.
4. Tighten the wheel nuts to the specified torque.

Tightening torque:

120 N·m (12.2 kgf-m, 88.5 ft-lb)

WHEEL AND TIRE SYSTEM > Tire and Wheel

INSPECTION

1. TIRES

Caution:

When replacing a tire, make sure to use tires of the same size, construction and load range as originally installed.

1. Check the tire size and tire inflation pressure. [Ref. to WHEEL AND TIRE SYSTEM>General Description>SPECIFICATION.](#)
2. Check for cracks, damage and wear.
3. Check the tire runout.
 - (1) Lift up the vehicle.
 - (2) Slowly rotate the wheel to check rim axial and longitudinal runout using a dial gauge and a magnet stand.

Service limit:

1 mm (0.04 in)

(3) After inspection, if the runout of the rim exceeds the limit, check the hub unit bearing.

4. If the rim runout exceeds service limit, perform the following confirmations.

(1) Mark the locations where the service limit is exceeded, move the tire installation position, and perform the inspections above again. Check if the locations that exceed the service limit change.

(2) If the locations do not change, replace the wheel.

(3) If the locations change, check the hub unit bearing.

- Front: [Ref. to PROPELLER SHAFT / DRIVE SHAFT / AXLE>Front Hub Unit Bearing>INSPECTION.](#)
- Rear: [Ref. to PROPELLER SHAFT / DRIVE SHAFT / AXLE>Rear Hub Unit Bearing>INSPECTION.](#)

2. TIRE ROTATION

Note:

Rotate tires periodically (10,000 km (6,000 miles)) in order to prolong life and to prevent uneven wear.

Rotate tires as shown in the figure depending on whether or not the direction of the tire rotation is specified.

- When the direction of tire rotation is not specified

(a) Front side of vehicle

- When the direction of tire rotation is specified

(a) Front side of vehicle

3. WHEEL BALANCING

- 1.** Using the wheel balancer, measure wheel balance.
- 2.** Adjust the wheel balancing.

Note:

- **Unbalance after adjusting the wheel balancing should be 5 g (0.18 oz) or less.**
- **When using the adhesive type weight, degrease the surface where the adhesive type weight will be applied securely.**
- **After applying the adhesive type weight, apply a force to the weight and attain full adhesion.**
- **Using the knock-on type weight, check the size of the knock-on part.**

Service limit L:

5 mm (0.2 in)

WHEEL AND TIRE SYSTEM > Temporary Tire

NOTE

“Temporary” tire for temporary use is equipped as a temporary tire.

Caution:

- **The “Temporary” tire is only for temporary use. Replace with a standard equipment sized tire as soon as possible.**
- **Do not use standard sized tire chains for the “Temporary” tires. Because tire size is small, tire chains cannot be installed properly and will damage the vehicle and tires if they are detached while driving.**
- **Do not drive at a speed greater than 80 km/h (50 MPH).**
- **Drive the vehicle as slowly as possible and avoid bumps on the road.**

WHEEL AND TIRE SYSTEM > Temporary Tire

REPLACEMENT

For replacement procedures, refer to “Tire and Wheel”. [Ref. to WHEEL AND TIRE SYSTEM>Tire and Wheel.](#)

WHEEL AND TIRE SYSTEM > Temporary Tire

INSPECTION

For inspection, refer to “Tire and Wheel”. [Ref. to WHEEL AND TIRE SYSTEM>Tire and Wheel>INSPECTION > TIRES.](#)

WHEEL AND TIRE SYSTEM > Tire Pressure Monitoring System

WIRING DIAGRAM

For the wiring diagram, refer to "Tire Pressure Monitoring System" in the wiring diagram. [Ref. to WIRING SYSTEM>Tire Pressure Monitoring System>WIRING DIAGRAM.](#)

WHEEL AND TIRE SYSTEM > Tire Pressure Monitoring System

REMOVAL

1. TRANSMITTER (TIRE INFLATION PRESSURE SENSOR)

1. Remove the wheels. [Ref. to WHEEL AND TIRE SYSTEM>Tire and Wheel>REMOVAL.](#)
2. Remove the tires from wheels.

Caution:

Use a tire changer when removing the tire from the wheel.

3. Using TORX[®] T10, remove the screw, and then remove the transmitter (tire inflation pressure sensor) from the valve.

Caution:

Do not reuse the valve and screw. Replace the valve and screw with new parts even when reusing the transmitter (tire inflation pressure sensor).

- (a) Transmitter
- (b) Screw
- (c) Valve
- (d) Wheel

4. Remove the valve from the wheel.

2. TPMS CM

Caution:

- **Before handling the airbag system components, refer to "CAUTION" of "General Description" in "AIRBAG SYSTEM". [Ref. to AIRBAG SYSTEM>General Description>CAUTION.](#)**
- **Side impact sensor (under the rear center seat) for the airbag system is located under the front center of the rear seat cushion. Be careful not to apply strong impact to the sensor when working with the rear seat cushion removed.**

- 1.** Disconnect the ground terminal from the battery sensor, and wait for at least 60 seconds before starting work. [Ref. to REPAIR CONTENTS>NOTE > BATTERY.](#)
- 2.** Remove the rear seat cushion assembly and the backrest assembly. [Ref. to SEATS>Rear Seat>REMOVAL.](#)
- 3.** Remove the trim panel assembly C pillar LWR and the trim panel assembly C pillar. [Ref. to EXTERIOR/INTERIOR TRIM>Rear Quarter Trim>REMOVAL.](#)
- 4.** Remove the trim panel assembly rear shelf. [Ref. to EXTERIOR/INTERIOR TRIM>Rear Shelf Trim>REMOVAL.](#)
- 5.** Remove the TPMS CM.
 - (1) Disconnect the connector.
 - (2) Remove the bolts to remove the TPMS CM.

WHEEL AND TIRE SYSTEM > Tire Pressure Monitoring System

INSTALLATION

1. TRANSMITTER (TIRE INFLATION PRESSURE SENSOR)

- 1.** When reusing the transmitter (tire inflation pressure sensor), replace the valve and TORX[®] screw with new parts before installing.

Tightening torque:

1.4 N·m (0.1 kgf-m, 1.0 ft-lb)

- (a) TORX® screw
- (b) Transmitter (tire inflation pressure sensor)
- (c) Valve

2. Install the transmitter (tire inflation pressure sensor) to the wheel by aligning it with valve hole.

Note:

- **When using the jig that pulls the valve cap by hooking its neck part, use another short-type cap.**
- **Install the transmitter as shown in the figure below.**

- (a) Transmitter
- (b) Screw
- (c) Valve
- (d) Wheel

3. Install the tires to wheels.

Caution:

- Use a tire changer when installing tire to wheel.
- To prevent damaging the transmitter (tire inflation pressure sensor), set the tire changer boom in the position as shown in the figure.

- (a) Transmitter (tire inflation pressure sensor)
- (b) Direction of turn table rotation
- (c) 135°
- (d) Tire changer boom
- (e) 90°
- (f) Starting point for fitting the bead to the rim

4. Install the wheel. [Ref. to WHEEL AND TIRE SYSTEM>Tire and Wheel>INSTALLATION.](#)
5. If the transmitter (tire pressure sensor) is replaced, register its ID. [Ref. to WHEEL AND TIRE SYSTEM>Tire Pressure Monitoring System>OPERATION.](#)

2. TPMS CM

Caution:

- Before handling the airbag system components, refer to "CAUTION" of "General Description" in "AIRBAG SYSTEM". [Ref. to AIRBAG SYSTEM>General Description>CAUTION.](#)
- Side impact sensor (under the rear center seat) for the airbag system is located under the front center of the rear seat cushion. Be careful not to apply strong impact to the sensor when working with the rear seat cushion removed.

1. Install the TPMS CM.

Caution:

Do not attach the washer if TPMS CM is reinstalled.

Tightening torque:

13 N·m (1.3 kgf-m, 9.6 ft-lb)

2. Connect the connector to TPMS CM.
3. Install the trim panel assembly rear shelf. [Ref. to EXTERIOR/INTERIOR TRIM>Rear Shelf Trim>INSTALLATION.](#)
4. Install the trim panel assembly C pillar and the trim panel assembly C pillar LWR. [Ref. to EXTERIOR/INTERIOR TRIM>Rear Quarter Trim>INSTALLATION.](#)
5. Install the backrest assembly and rear seat cushion assembly. [Ref. to SEATS>Rear Seat>INSTALLATION.](#)

6. Connect the ground terminal to battery sensor. [Ref. to REPAIR CONTENTS>NOTE > BATTERY.](#)
7. If the TPMS CM is replaced, register the transmitter ID. [Ref. to WHEEL AND TIRE SYSTEM>Tire Pressure Monitoring System>OPERATION.](#)

WHEEL AND TIRE SYSTEM > Tire Pressure Monitoring System

INSPECTION

1. BASIC INSPECTION

For basic inspection, refer to "Basic Diagnostic Procedure" of "TIRE PRESSURE MONITOR (DIAGNOSTICS)". [Ref. to TIRE PRESSURE MONITOR\(DIAGNOSTICS\)>Basic Diagnostic Procedure.](#)

2. SYSTEM BLOCK DIAGRAM

For system block diagram, refer to "System Block Diagram" in "TIRE PRESSURE MONITOR (DIAGNOSTICS)". [Ref. to TIRE PRESSURE MONITOR\(DIAGNOSTICS\)>General Description>SYSTEM BLOCK DIAGRAM.](#)

3. MODULE I/O SIGNAL

For the specification (electrical component), refer to "Control Module I/O Signal" of "TIRE PRESSURE MONITOR (DIAGNOSTICS)". [Ref. to TIRE PRESSURE MONITOR\(DIAGNOSTICS\)>Control Module I/O Signal>ELECTRICAL SPECIFICATION.](#)

WHEEL AND TIRE SYSTEM > Tire Pressure Monitoring System

OPERATION

Perform the registration procedure of the transmitter in the following cases:

- Transmitter is replaced.
- TPMS CM is replaced.

Caution:

Register the transmitter (ID) when rotating tires. If it is not registered, the tire position displayed on the Subaru Select Monitor will be incorrect.

Note:

- **If registration of the transmitter (ID) is not possible after two attempts, replace the TPMS CM. [Ref. to WHEEL AND TIRE SYSTEM>Tire Pressure Monitoring System.](#)**
- **During the registration, turn the ignition switch to OFF and end the Subaru Select Monitor. Or if the registration is not performed for 5 minutes or more, the registration mode is canceled.**

1. Adjust all tire pressures to the specifications.
2. Connect the Subaru Select Monitor and select [Diagnosis] on [Start] display.
3. On [Vehicle selection] screen, input the target vehicle information and select [OK].
4. On [Main Menu] screen, select [Each System].
5. On [Select System] screen, select [Tire Pressure Monitor], and then select [Enter].
6. On [Select Function] screen, select [Work Support].
7. On [Work Support] screen, select [ID registration].

- 8.** When [ID registration mode When execute Registered ID is deleted Continue?] is displayed, select [OK].
- 9.** Contact the transmitter registration tool to the side wall area near the air valve on the front left tire, and press the switch. The transmitter ID is sent to the TPMS CM. (At this time, the tire pressure warning light blinks to confirm that the registration has started.)

(A) Air valve (transmitter)

(B) Transmitter registration tool

Note:

- **The registration order of transmitter ID is not specified.**
- **Use the transmitter registration tool by touching the side wall area near the transmitter.**
- **When registration of each tire is completed, [ID registration completed] is displayed on the Select Monitor screen.**
- **If registration procedure stop in the halfway (turning ignition switch to OFF, wrong registration order, etc), proceed from step 5.**

- 10.** When ID registration is completed, the tire pressure warning light remains lit for approximately 2 seconds, to end the registration. Switch the screen to [Data Monitor] of Subaru Select Monitor. [Ref. to TIRE PRESSURE MONITOR\(DIAGNOSTICS\)>Data Monitor.](#)
- 11.** Check the transmitter ID that was registered, then perform a driving test. [Ref. to TIRE PRESSURE MONITOR\(DIAGNOSTICS\)>Inspection Mode.](#)

WHEEL AND TIRE SYSTEM > Tire Repair Kit

NOTE

- Refer to the owner's manual for the tire puncture repair.
- Replace the expired sealant with a new part.
- The expiration date of a tire puncture repair sealant is shown on the label of the sealant bottle. The expired sealant is not included in the warranty.

(a) Expiration date display

WHEEL AND TIRE SYSTEM > Tire Repair Kit

REPLACEMENT

1. CLEARING THE TIRE PUNCTURE REPAIR SEALANT

Caution:

- **Do not dispose the tire filled with repair sealant.**
- **Expired sealant, recovered sealant, or empty bottles and hoses of sealant used for repair work contains ethylene glycol that is to be treated as industrial waste. Take appropriate measures to these materials at the time of disposal.**
- **Perform this operation in a well-ventilated space.**
- **During the operation, use appropriate protection tools to prevent the sealant from adhering to eyes, skin and clothes.**
- **After work, wash hands, face etc. well to wash away the sealant completely.**
- **If the sealant enters the mouth or eyes, wash it away with plenty of water, and consult a doctor.**

1. Using a tire changer, remove the tire from the wheel.

Note:

Cover the tire changer and floor with cloth, and work while being careful not to spill the sealant.

2. Clear the sealant remaining inside the tire.
3. Wipe off the sealant adhered to the wheel, inside the tire, tire changer and on the floor with cloth carefully.

Caution:

- **Completely wipe off the sealant in the mating surface of wheel rim and bead.**
- **Wheel can be reused even after repaired by using the tire puncture repair kit. Do not reuse the tire repaired with the tire puncture repair kit, the transmitter (tire inflation pressure sensor), and the valve.**

2. REPLACING THE TIRE REPAIR KIT

Caution:

After using the tire puncture repair kit, replace the repair sealant and the speed limit sticker.

Store a compressor (a) and a new repair sealant bottle (b) in the specified position of the vehicle.

WHEEL AND TIRE SYSTEM > General Diagnostic Table

INSPECTION

Symptoms	Possible cause	Corrective action
Vehicle is unstable.	(1) Improperly inflated tire	Adjust to the specified air pressure.
	(2) Uneven wear	Check the tire referring to "Abnormal tire wear" in this table, carry out the procedure and replace the tire.
	(3) Front wheel alignment	Check or adjust the front wheel alignment. <ul style="list-style-type: none"> • Inspection: Ref. to FRONT SUSPENSION>Wheel Alignment>INSPECTION. • Adjustment: Ref. to FRONT SUSPENSION>Wheel Alignment>ADJUSTMENT.
	(4) Rear wheel alignment	Check or adjust the rear wheel alignment. <ul style="list-style-type: none"> • Inspection: Ref. to FRONT SUSPENSION>Wheel Alignment>INSPECTION. • Adjustment: Ref. to FRONT SUSPENSION>Wheel Alignment>ADJUSTMENT.
	(5) Front strut	Check the front strut. Ref. to FRONT SUSPENSION>Front Strut>INSPECTION.
	(6) Rear shock absorber	Check the rear shock absorber. Ref. to REAR SUSPENSION>Rear Shock Absorber>INSPECTION.
	(7) Front axle housing	Check the front axle housing. Ref. to PROPELLER SHAFT / DRIVE SHAFT / AXLE>Front Axle>INSPECTION.
	(8) Front hub unit bearing	Check the front hub unit bearing. Ref. to PROPELLER SHAFT / DRIVE SHAFT / AXLE>Front Hub Unit Bearing>INSPECTION.
	(9) Rear axle housing	Check the rear axle housing. Ref. to PROPELLER SHAFT / DRIVE SHAFT / AXLE>Rear Axle>INSPECTION.
	(10) Rear hub unit bearing	Check the rear hub unit bearing. Ref. to PROPELLER SHAFT / DRIVE SHAFT / AXLE>Rear Hub Unit Bearing>INSPECTION.

Symptoms	Possible cause	Corrective action
Vehicle is abnormally out of balance.	(1) Improperly inflated tire	Adjust to the specified air pressure.
	(2) Uneven wear	Check the tire referring to "Abnormal tire wear" in this table, carry out the procedure and replace the tire.
	(3) Stabilizer	Inspect the stabilizer.
	(4) Front wheel alignment	Check or adjust the front wheel alignment. <ul style="list-style-type: none"> • Inspection: Ref. to FRONT SUSPENSION>Wheel Alignment>INSPECTION. • Adjustment: Ref. to FRONT SUSPENSION>Wheel Alignment>ADJUSTMENT.
	(5) Rear wheel alignment	Check or adjust the rear wheel alignment. <ul style="list-style-type: none"> • Inspection: Ref. to FRONT SUSPENSION>Wheel Alignment>INSPECTION. • Adjustment: Ref. to FRONT SUSPENSION>Wheel Alignment>ADJUSTMENT.
Abnormal wheel vibration	(1) Improperly inflated tire	Adjust to the specified air pressure.
	(2) Uneven wear	Check the tire referring to "Abnormal tire wear" in this table, carry out the procedure and replace the tire.
	(3) Improper wheel balancing	Check the wheel balance. Ref. to WHEEL AND TIRE SYSTEM>Tire and Wheel>INSPECTION > WHEEL BALANCING.
	(4) Front axle housing	Check the front axle housing. Ref. to PROPELLER SHAFT / DRIVE SHAFT / AXLE>Front Axle>INSPECTION.
	(5) Front hub unit bearing	Check the front hub unit bearing. Ref. to PROPELLER SHAFT / DRIVE SHAFT / AXLE>Front Hub Unit Bearing>INSPECTION.
	(6) Rear axle housing	Check the rear axle housing. Ref. to PROPELLER SHAFT / DRIVE SHAFT / AXLE>Rear Axle>INSPECTION.
	(7) Rear hub unit bearing	Check the rear hub unit bearing. Ref. to PROPELLER SHAFT / DRIVE SHAFT / AXLE>Rear Hub Unit Bearing>INSPECTION.

Symptoms	Possible cause	Corrective action
Abnormal tire wear	(1) Improperly inflated tire	Adjust to the specified air pressure.
	(2) Improper wheel balancing	Check the wheel balance. _Ref. to WHEEL AND TIRE SYSTEM>Tire and Wheel>INSPECTION > WHEEL BALANCING.
	(3) Front wheel alignment	Check or adjust the front wheel alignment. <ul style="list-style-type: none"> • Inspection: _Ref. to FRONT SUSPENSION>Wheel Alignment>INSPECTION. • Adjustment: _Ref. to FRONT SUSPENSION>Wheel Alignment>ADJUSTMENT.
	(4) Rear wheel alignment	Check or adjust the rear wheel alignment. <ul style="list-style-type: none"> • Inspection: _Ref. to FRONT SUSPENSION>Wheel Alignment>INSPECTION. • Adjustment: _Ref. to FRONT SUSPENSION>Wheel Alignment>ADJUSTMENT.