



LIGHTING SYSTEM

LI

-
1. General Description
 2. Relay and Fuse
 3. Headlight System
 4. High Beam Assist System
 5. Day Time Running Light System
 6. Clearance Light and Illumination Light System
 7. Front Fog Light System
 8. Turn Signal Light and Hazard Light System
 9. Back-up Light System
 10. Stop Light System
 11. Interior Light System
 12. Auto Headlight Beam Leveler System
 13. Combination Switch (Light)
 14. Light Control Sensor
 15. Headlight Assembly
 16. Clearance/Parking Light Bulb
 17. Front Turn Signal Light Bulb
 18. Front Side Marker Light Bulb
 19. Hazard Switch
 20. Front Fog Light Assembly
 21. Side Turn Signal Light Assembly
 22. Rear Combination Light Assembly
 23. License Plate Light
 24. License Plate Light Bulb
 25. High-mounted Stop Light
 26. Spot Map Light
 27. Room Light
 28. Trunk Room Light
 29. LED Illumination Light
 30. Vanity Mirror Light
 31. Auto Headlight Beam Leveler Control Module
 32. Reflex Reflector
 33. Door Switch

LIGHTING SYSTEM > General Description

CAUTION

- When performing service operation, refer to "Repair Contents" in "General Description".  [Ref. to REPAIR CONTENTS>Repair Contents.](#)
- When performing work on the sensors or modules, be careful of the following.
 - Before disconnecting electrical connectors, be sure to disconnect the ground terminal from the battery sensor.  [Ref. to REPAIR CONTENTS>NOTE > BATTERY.](#)
 - Do not apply any impact. If the parts are accidentally dropped, replace them.
 - Do not expose to high-temperature and humidity.
- When replacing the parts provided with memory functions, record the memory contents before disconnecting the ground terminal from the battery sensor.
- Refer to "CAUTION" of "General Description" in "AIRBAG SYSTEM" section.  [Ref. to AIRBAG SYSTEM>General Description>CAUTION.](#)
- Use a dry clean cloth so that no grease or water adheres to the glass portion of the bulb.
- Always replace with a bulb that is the same model and wattage as those of the old one.

LIGHTING SYSTEM > General Description

SPECIFICATION

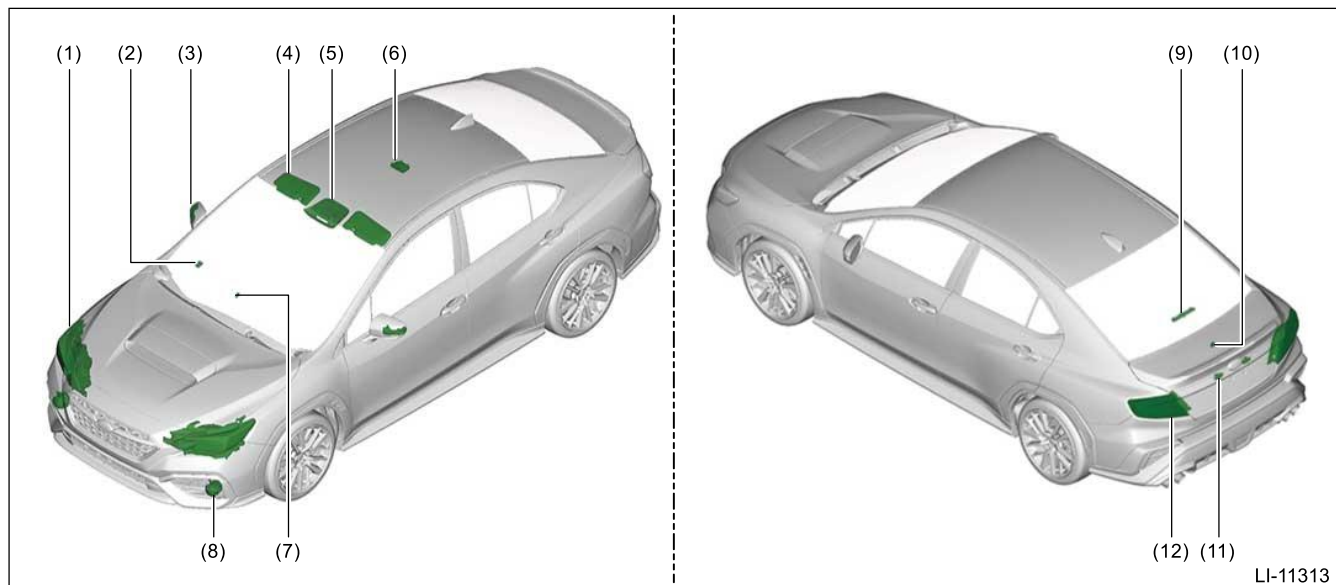

No.	Description	Capacity and wattage	Type	
(1)	Headlight (model without SRH)	Daytime running light / low beam / high beam	12 V – 7/20/25 W (LED)	*
		Parking light / front turn signal light	12 V – 8/28 W	7444NA
		Front side marker lights	12 V – 5 W	W5W
(1)	Headlight (model with SRH)	Low beam / high beam	12 V – 21/26 W (LED)	*
		Front turn signal light	12 V – 6.2 W (LED)	*

No.	Description		Capacity and wattage	Type
		Parking light / accessory light / daytime running light	12 V — 0.4/0.6/4.6 W (LED)	*
		Front side marker lights	12 V — 0.5 W (LED)	*
(2)	Glove box light		12 V (LED)	*
(3)	Side turn signal light		12 V — 0.4 W (LED)	*
(4)	Vanity mirror light		12 V — 2 W	—
(5)	Spot map light		12 V — 8 W	—
(6)	Room light		12 V — 8 W	—
(7)	Pocket light		12 V (LED)	*
(8)	Front fog light		12 V — 5.4 W (LED)	*
(9)	High-mounted stop light		13.5 V — 1.5 W (LED)	*
(10)	Trunk room light		12 V — 3.8 W	SAE#194
(11)	License plate light		12 V — 5 W	W5W
(12)	Rear combination light	Tail light / stop light	12 V — 2.0/3.2 W (LED)	*
		Rear turn signal light	12 V — 21 W	WY21W
		Back-up light	12 V — 2.4 W (LED)	*
		Rear side marker light	12 V — 1.8 W (LED)	*

*: Non-disassembly type

LIGHTING SYSTEM > General Description

COMPONENT

1. HEADLIGHT

- MODEL WITHOUT SRH

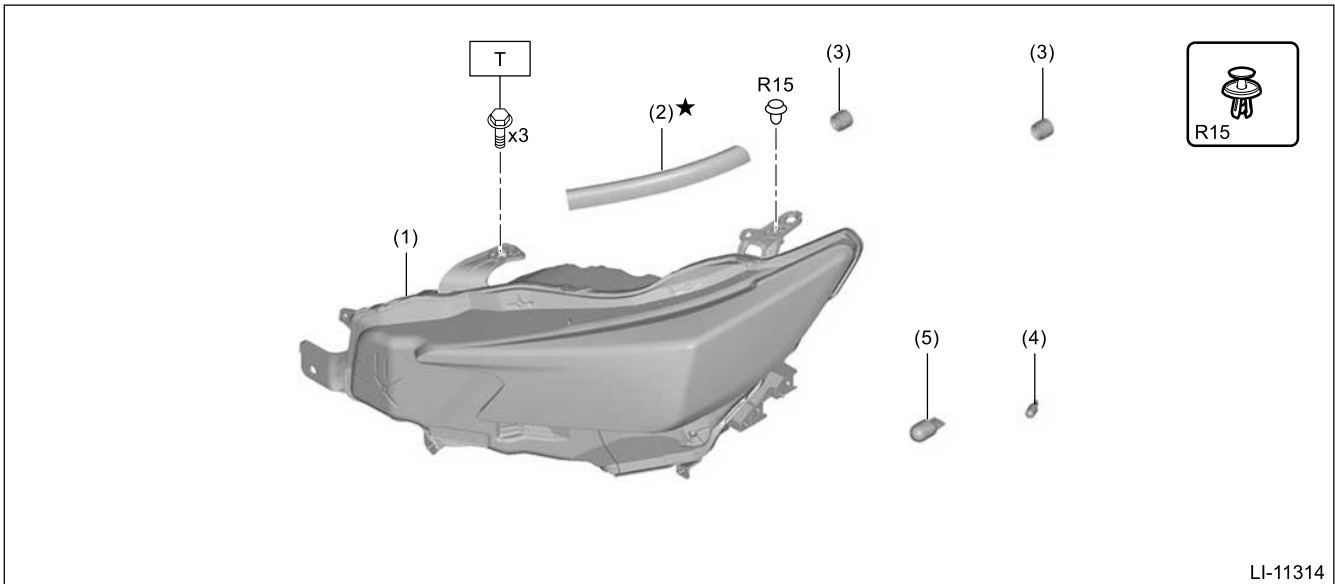

- (1) Light ASSY head
- (2) Hood seal rubber
- (3) Cap

- (4) Front side marker light bulb
- (5) Parking & front turn signal light bulb

Tightening torque: N·m (kgf-m, ft-lb)
T: 7.5 (0.8, 5.5)

● **MODEL WITH SRH**

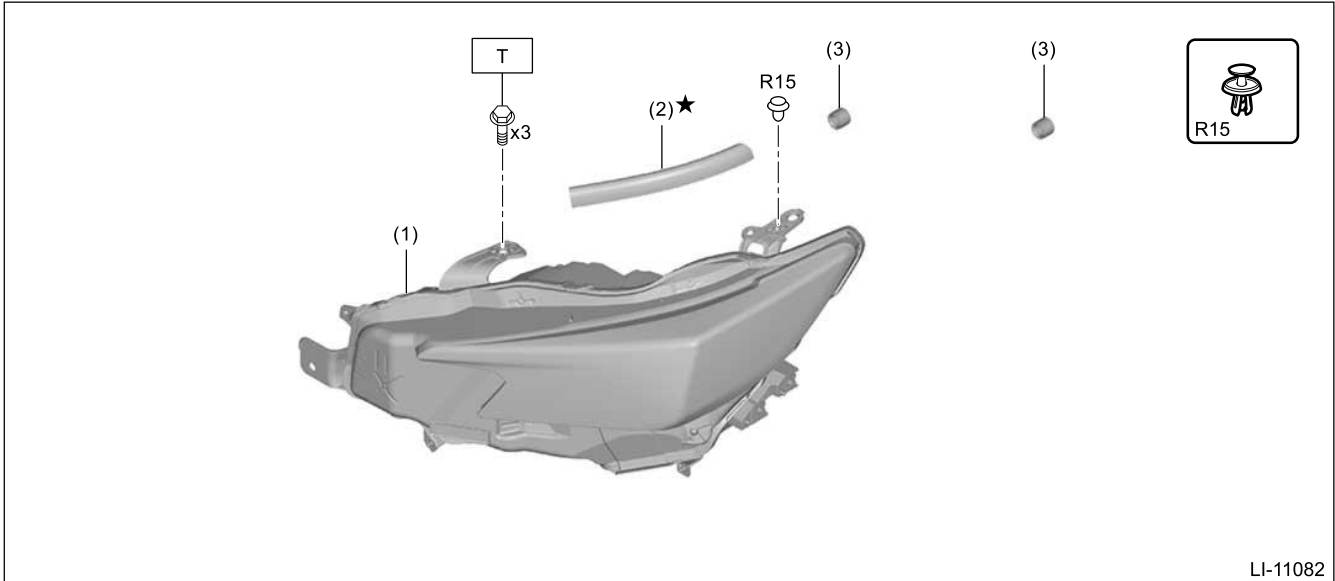

- (1) Light ASSY head
- (2) Hood seal rubber

- (3) Cap

Tightening torque: N·m (kgf-m, ft-lb)
T: 7.5 (0.8, 5.5)

2. REAR COMBINATION LIGHT

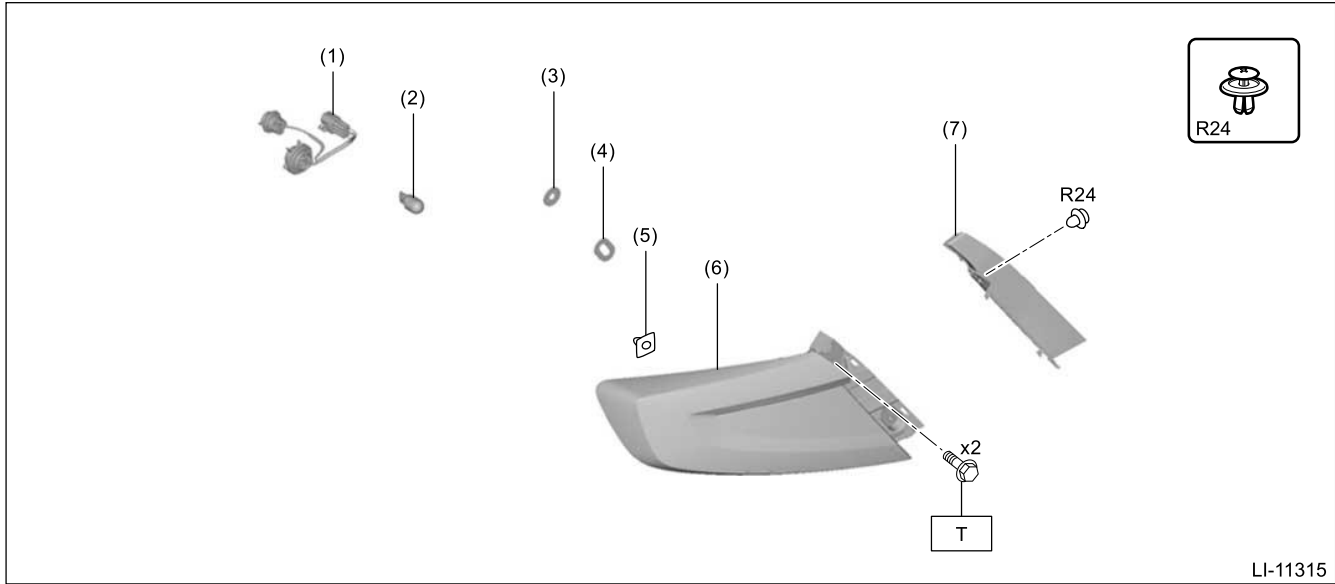

(1) Cord ASSY

(5) Grommet

Tightening torque: N·m (kgf-m, ft-lb)

(2) Turn signal light bulb

(6) Light ASSY rear combination

T: 7.5 (0.8, 5.5)

(3) Gasket

(7) Cover ASSY rear combination

(4) Gasket

LIGHTING SYSTEM > General Description

PREPARATION TOOL

1. SUBARU SPECIAL TOOL

ILLUSTRATION	TOOL NUMBER	DESCRIPTION	REMARKS
 STSSM4	—	SUBARU SELECT MONITOR 4	Used for setting of each function and troubleshooting for electrical system. Note: <ul style="list-style-type: none"> • For detailed operation procedures, refer to "Help" of application. • Used together with interface for Subaru Select Monitor (such as DST-i and DST-010).

2. OTHER

	REMARKS
Circuit tester	Used for measuring resistance, voltage and current.

LIGHTING SYSTEM > Relay and Fuse

LOCATION

For the location, refer to "FUSE AND RELAY" in the wiring diagram.  Ref. to [WIRING SYSTEM>Fuse And Relay>LOCATION](#).

Note:

For details of relay and fuse, refer to "DC POWER SUPPLY CIRCUIT".  Ref. to [WIRING SYSTEM>Power Supply Circuit>WIRING DIAGRAM](#).

LIGHTING SYSTEM > Relay and Fuse

INSPECTION

1. CHECK FUSE

1. Remove the fuse and inspect visually.
2. If the fuse is blown out, replace the fuse.

Note:

If the fuse is blown again, check the system wiring harness.

2. CHECK RELAY

1. Measure the resistance between relay terminals.

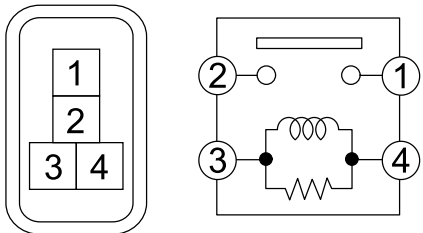
Terminal No.	Inspection conditions	Standard	Circuit
1 – 2	Always	1 MΩ or more	
1 – 2	Apply battery voltage between terminals 4 and 3.	Less than 1 Ω	

LI-01273

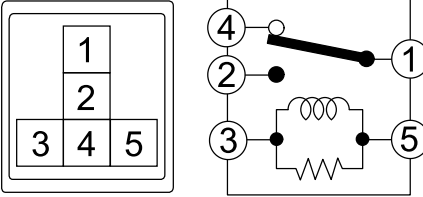
Terminal No.	Inspection conditions	Standard	Circuit
1 – 2	Always	1 MΩ or more	
1 – 4	Always	Less than 1 Ω	
1 – 2	Apply battery voltage between terminals 3 and 5.	Less than 1 Ω	

SL-01566

2. Replace the relay if the inspection result is not within the standard value.

LIGHTING SYSTEM > Headlight System

WIRING DIAGRAM

For the wiring diagram, refer to "Headlight System" in the wiring diagram.  [Ref. to WIRING SYSTEM>Headlight System>WIRING DIAGRAM.](#)

LIGHTING SYSTEM > Headlight System

INSPECTION

1. BASIC INSPECTION

For inspection, refer to "Basic Diagnostic Procedure" of "HEADLIGHT / FOGLIGHT (DIAGNOSTICS)" section.  [Ref. to HEADLIGHT / FOGLIGHT\(DIAGNOSTICS\)>Basic Diagnostic Procedure.](#)





2. SYSTEM BLOCK DIAGRAM

For system block diagram, refer to "System Block Diagram" in "HEADLIGHT / FOGLIGHT (DIAGNOSTICS)" section.  [Ref. to HEADLIGHT / FOGLIGHT\(DIAGNOSTICS\)>General Description>SYSTEM BLOCK DIAGRAM.](#)

3. MODULE I/O SIGNAL

For the specification (electrical component), refer to "Control Module I/O Signal" of "HEADLIGHT / FOGLIGHT (DIAGNOSTICS)" section.  [Ref. to HEADLIGHT / FOGLIGHT\(DIAGNOSTICS\)>Control Module I/O Signal.](#)

4. TROUBLE SYMPTOM

Symptoms	Reference
Headlight does not illuminate, or headlight is weak.	 Ref. to LIGHTING SYSTEM>Headlight System>INSPECTION > CHECK HEADLIGHT SYSTEM.
Light does not illuminate though the surrounding is dark, or it remains illuminating though the surrounding becomes brighter. (Everything except auto headlight operates normally.)	 Ref. to LIGHTING SYSTEM>Headlight System>INSPECTION > AUTO HEADLIGHT SYSTEM CHECK.
Welcome lighting does not illuminate.	 Ref. to LIGHTING SYSTEM>Headlight System>INSPECTION > CHECK OF WELCOME LIGHTING SYSTEM (IF IT DOES NOT ILLUMINATE).
Welcome lighting does not go off.	 Ref. to LIGHTING SYSTEM>Headlight System>INSPECTION > CHECK OF WELCOME LIGHTING SYSTEM (IF IT DOES NOT GO OFF) .
The wiper interlocked headlight does not operate.	 Ref. to LIGHTING SYSTEM>Headlight System>INSPECTION > CHECK WIPER INTERLOCK HEADLIGHT SYSTEM.

5. CHECK HEADLIGHT SYSTEM

● **MODEL WITHOUT SRH**

Wiring diagram:

Headlight system  Ref. to WIRING SYSTEM>Headlight System>WIRING DIAGRAM.

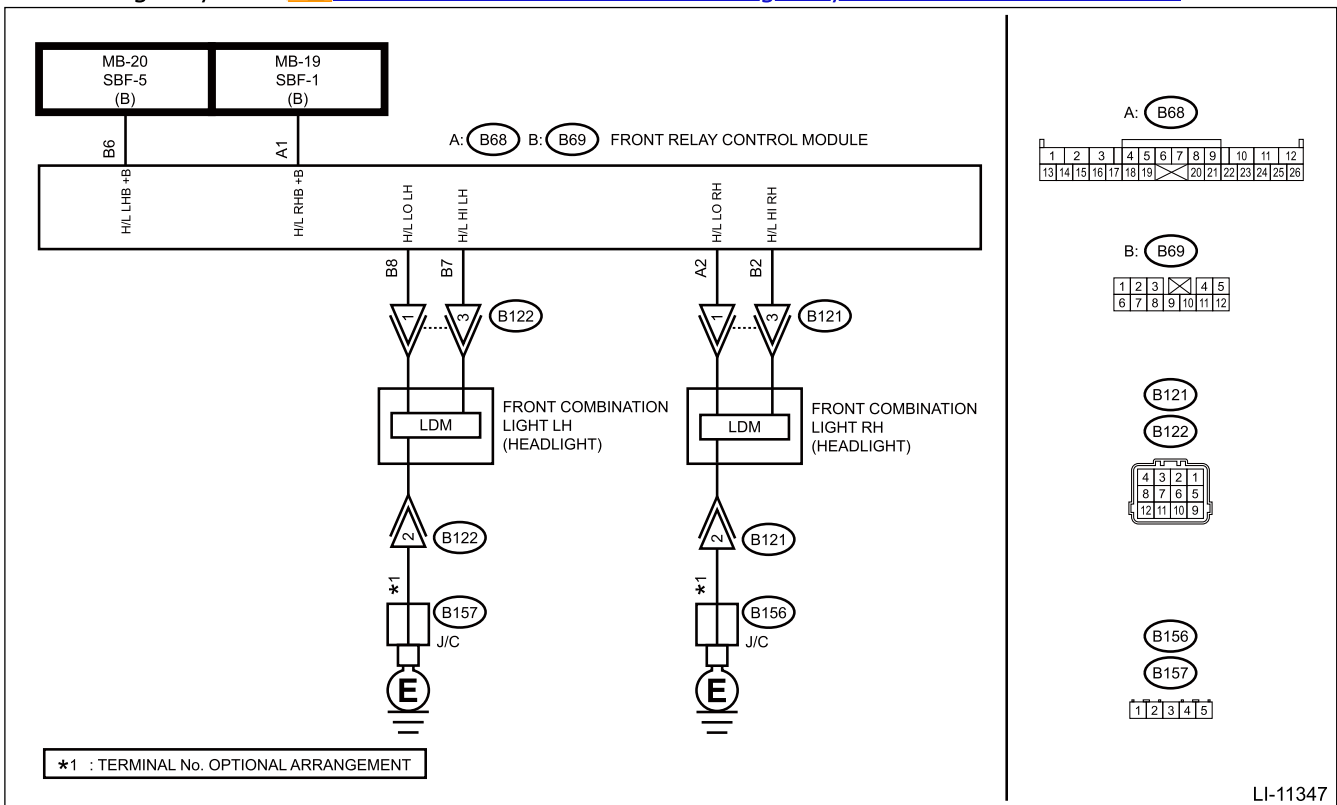

LI-11347

1. CHECK HEADLIGHT ILLUMINATION.

1. Turn the ignition switch to ON.
2. Turn the lighting switch to the switch 2 (HEAD) position and switch UP (HI) position.

Does the headlight (low beam and high beam) come on?

Yes

The headlight system is normal.

No

 [Go to 2.](#)

2. CHECK DTC.

1. Turn the ignition switch to ON.
2. Turn the lighting switch to the switch 2 (HEAD) position and switch UP (HI) position.
3. Read the DTC of [Front Relay Control Module] using the Subaru Select Monitor.  [Ref. to COMMON \(DIAGNOSTICS\)>Diagnostic Trouble Code \(DTC\).](#)

Are any DTCs displayed?

Yes

Perform the diagnosis for the displayed DTCs.  [Ref. to FRONT RELAY CONTROL MODULE \(DIAGNOSTICS\)>Diagnostic Trouble Code \(DTC\)>LIST.](#)

No

 [Go to 3.](#)

3. CHECK POWER SUPPLY.

Using the Subaru Select Monitor, display the following items in the [Data monitor] of [Front Relay Control Module].  [Ref. to COMMON \(DIAGNOSTICS\)>Data Monitor.](#)

- [BATT Voltage (Control)]
- [BATT Voltage (BACKUP)]
- [IGN Voltage]

Is the voltage 9 – 16 V?

Yes

 [Go to 4.](#)

No

Check the front relay control module and replace it if defective.

- Inspection:  [Ref. to FRONT RELAY CONTROL MODULE \(DIAGNOSTICS\)>Basic Diagnostic Procedure.](#)
- Replacement:  [Ref. to BODY CONTROL/COMMUNICATION SYSTEM>Front Relay Control Module.](#)

4. PERFORM ACTIVE TEST.

Using the Subaru Select Monitor, check the following items in the [Active Test] of [Front Relay Control Module].  [Ref. to FRONT RELAY CONTROL MODULE \(DIAGNOSTICS\)>Active Test.](#)

Note:

Check the items where illumination did not occur in step 1.

- [Lighting Low RH Output]
- [Lighting Low LH Output]
- [Lighting High RH Output]
- [Lighting High LH Output]

Does the light illuminate?

Yes



[Go to 9.](#)

No



[Go to 5.](#)

5. CHECK HEADLIGHT POWER SUPPLY CIRCUIT.

1. Turn the ignition switch to OFF.
2. Disconnect the front relay control module connector.
3. Measure the voltage between front relay control module connector and chassis ground.

Connector & terminal

Headlight RH

(B68) No. 1 (+) — Chassis ground (-):

Headlight LH

(B69) No. 6 (+) — Chassis ground (-):

Is the voltage 9 — 16 V?

Yes



[Go to 6.](#)

No

Check the harness of the fuse, connector and power supply circuit. If there are no problems, replace the front relay control module.  [Ref. to BODY CONTROL/COMMUNICATION SYSTEM>Front Relay Control Module.](#)

6. CHECK HARNESS.

1. Disconnect the connector of the light which did not illuminate.
2. Check the harness between the front relay control module and the headlight.

Connector & terminal

Headlight RH (low beam)

(B68) No. 2 — (B121) No. 1:

Headlight RH (high beam)

(B69) No. 2 — (B121) No. 3:

Headlight LH (low beam)

(B69) No. 8 — (B122) No. 1:

Headlight LH (high beam)

(B69) No. 7 — (B122) No. 3:

Is harness normal?

 Yes

 [Go to 7.](#)

 No

Repair or replace the defective part.

7. CHECK HEADLIGHT.

Apply battery voltage between headlight unit connector terminals.

Caution:

- Make sure that the high beam illuminates because the high beam shares the same lighting body with the low beam and they are alternatively lit by switching.
- When applying battery voltage, do not mix up the positive (+) side and the negative (-) side. Incorrect polarity connection may cause internal LED damage.

Connector & terminal

•If the low beam does not illuminate

Headlight RH

(B121) No. 1 (+) – (B121) No. 2 (-):

Headlight LH

(B122) No. 1 (+) – (B122) No. 2 (-):

•If the high beam does not illuminate

Headlight RH

(B121) No. 3 – (B121) No. 2 (-):

Headlight LH

(B122) No. 3 – (B122) No. 2 (-):

Does the headlight (low beam and high beam) come on at normal brightness?

Yes

 [Go to 8.](#)

No

Replace the headlight assembly.  [Ref. to LIGHTING SYSTEM>Headlight Assembly.](#)

• MODEL WITH SRH

Wiring diagram:

Headlight system  [Ref. to WIRING SYSTEM>Headlight System>WIRING DIAGRAM.](#)

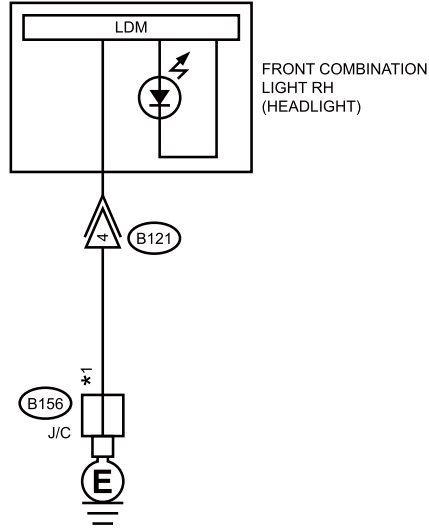
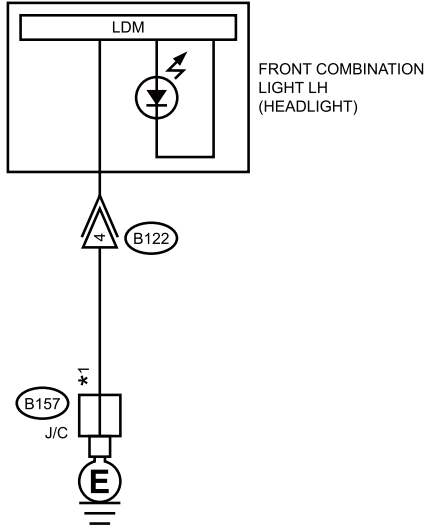

*1 : TERMINAL No. OPTIONAL ARRANGEMENT

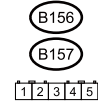
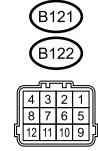

lay

LI-11348

9. CHECK CURRENT DATA. 1. CHECK HEADLIGHT ILLUMINATION.

1. Turn the ignition switch to ON.
2. Turn the ignition switch to ON. Using the Subaru Select Monitor, display the following items in the [Data monitor] of [Body Control]. Ref: to COMMON (DIAGNOSTICS) > Data Monitor.
3. Turn the lighting switch to the switch 2 (HEAD) position.
4. Turn the dimmer & passing switch to the switch UP position.

Does the parking light and headlight (low beam and high beam) come on?
2 (HEAD) and switch UP (HI) positions?

 Yes

The headlight system is normal.

Yes

[Go to 10.](#)

 No

[Go to 2.](#)

No

Check the combination switch or harness for open circuit.



2. CHECK CURRENT DATA.

1. Turn the ignition switch to ON and wait for at least 10 seconds.
2. Bring the Subaru Select Monitor display to the following screen.  [Ref. to COMMON \(DIAGNOSTICS\) > Data Monitor.](#)

- [Lighting Low Request]
- Is DTC displayed?
- [Lighting High Request]

Does the display change to [ON] when the display is turned on?  [Ref. to BODY CONTROL \(DIAGNOSTICS\) > Diagnostic Trouble Code \(DTC\) > LIST.](#)

Yes

 [Locate the front relay control module.](#)  [Ref. to BODY CONTROL/COMMUNICATION SYSTEM > Front Relay Control Module.](#)

No

Replace the body integrated unit.  [Ref. to BODY CONTROL/COMMUNICATION SYSTEM > Body Integrated Unit.](#)

3. CHECK POWER SUPPLY

Using the Subaru Select Monitor, display the following items in the [Data monitor] of [Body Control].  [Ref. to COMMON \(DIAGNOSTICS\) > Data Monitor.](#)

- [BATT voltage (control)]
- [BATT voltage (BACKUP)]
- [IGN voltage]



Is the voltage 9 – 16 V?

Yes

 [Go to 4.](#)

No

Check the body integrated unit and replace it if defective.

- Inspection:  [Ref. to BODY CONTROL \(DIAGNOSTICS\) > Basic Diagnostic Procedure.](#)
- Replacement:  [Ref. to BODY CONTROL/COMMUNICATION SYSTEM > Body Integrated Unit.](#)

4. CHECK CURRENT DATA.

1. Turn the ignition switch to ON.
2. Using the Subaru Select Monitor, display the following items in the [Data monitor] of [Body Control].  [Ref. to COMMON \(DIAGNOSTICS\)>Data Monitor.](#)
 - [Lighting II Switch Input]
 - [Dimmer Hi Switch Input]

Does the display change between [OFF] ↔ [ON] when the lighting switch is moved to the switch 2 (HEAD) and switch UP (HI) positions?

 Yes

 [Go to 5.](#)

 No

Check the combination switch or harness for open circuit.

6. AUTO HEADLIGHT SYSTEM CHECK

Wiring diagram:

Headlight System  [Ref. to WIRING SYSTEM>Headlight System>WIRING DIAGRAM.](#)

1. Turn the ignition switch to ON.
2. Using the Subaru Select Monitor, display the following items in the [Data monitor] of [Body Control].  [Ref. to COMMON \(DIAGNOSTICS\)>Data Monitor.](#)
 - [Lighting II Lamp Output]
 - [Lighting Hi Lamp Output]

Does the display change to [ON] when turning the lighting switch to the switch 2 (HEAD) position and switch UP (HI) position?

 Yes

 [Go to 6.](#)

 No

Replace the body integrated unit.  [Ref. to BODY CONTROL/COMMUNICATION SYSTEM>Body Integrated Unit.](#)

J: i81 K: i82 L: i83 N: B72 BODY INTEGRATED UNIT

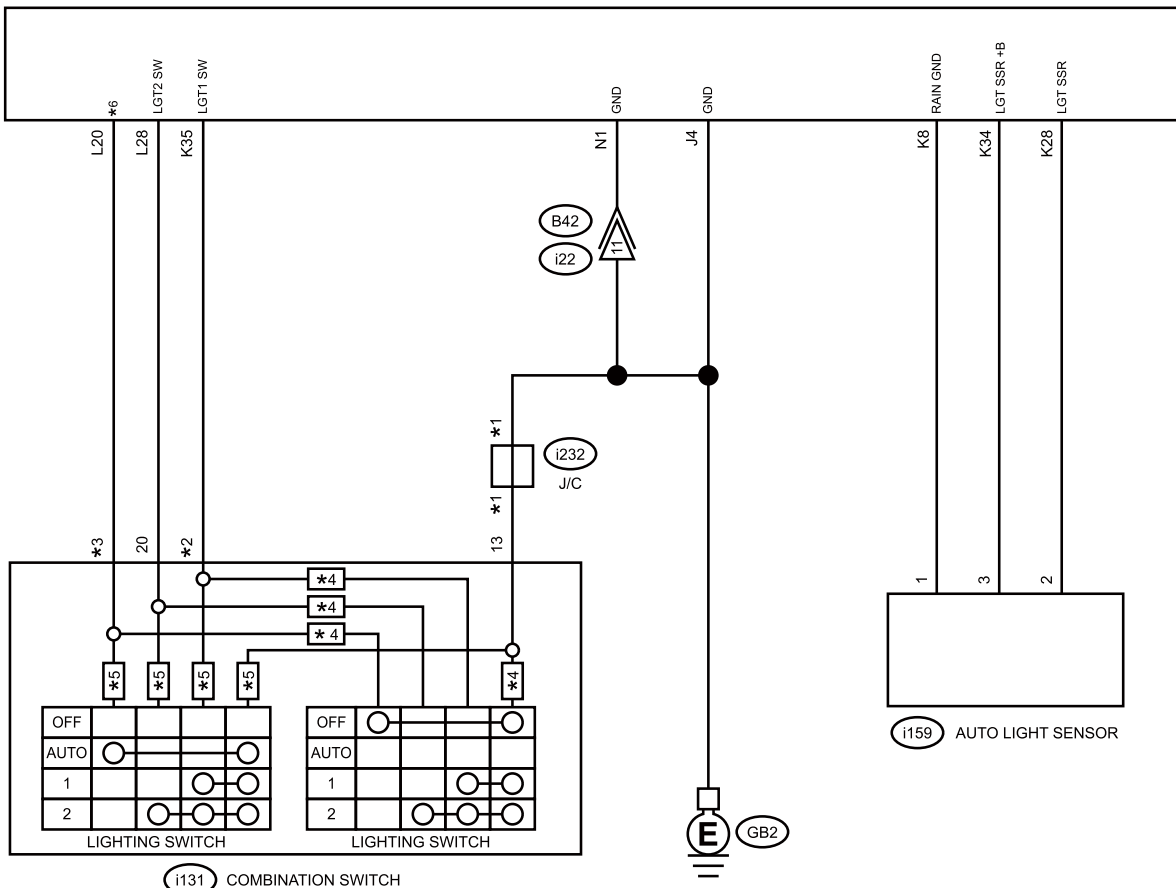

- *1 : TERMINAL No. OPTIONAL ARRANGEMENT
- *2 : C0 MODEL : 19
EXCEPT FOR C0 MODEL : 18
- *3 : C0 MODEL : 18
EXCEPT FOR C0 MODEL : 19
- *4 : C0 MODEL
- *5 : EXCEPT FOR C0 MODEL
- *6 : C0 MODEL : LGT OFF SW
EXCEPT FOR C0 MODEL : LGT AUTO SW

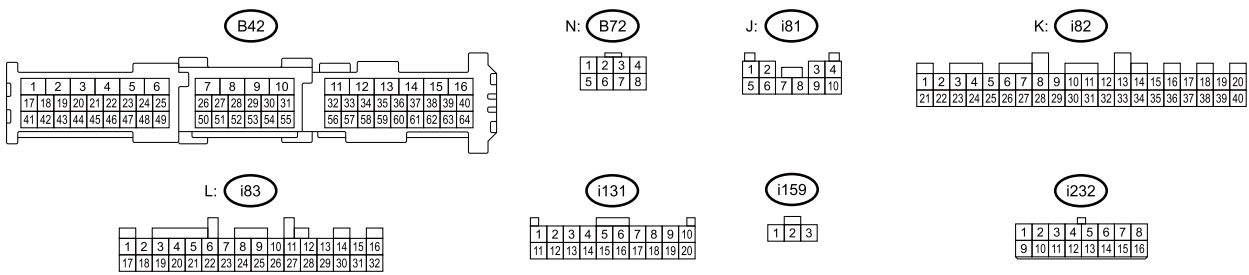

1. CHECK HEADLIGHT AND TAIL LIGHT ILLUMINATION.

1. Turn the ignition switch to ON.
2. Make the light control sensor vicinity dark.
3. Set the lighting switch to AUTO position.
4. Make the light control sensor vicinity bright.
5. Turn the lighting switch to the OFF position and turn to the AUTO position again.

Do the parking light, headlight and tail light illuminate by way of step 3 and go off by step 5?

 Yes

The auto headlight system is normal.

 No

 [Go to 2.](#)

2. CHECK BODY INTEGRATED UNIT SETTING.

Using Subaru Select Monitor, display data of [Illumination Sensor Setting] in [Customize] of [Body Control].  [Ref. to BODY CONTROL\(DIAGNOSTICS\)>Customize.](#)

Is the setting in the [Support]?

 Yes

 [Go to 3.](#)

 No

Turn the setting to [Support].

3. CHECK CURRENT DATA.

1. Using Subaru Select Monitor, display data of [Illumination Sensor Output] in [Data Monitor] of [Body Control].  [Ref. to COMMON \(DIAGNOSTICS\)>Data Monitor.](#)
2. Measure the voltage when the area around the light control sensor, which was dark, becomes bright.

Illumination sensor output

Dark condition: Approx. 0.6 V or less

Bright condition: Approx. 3 V or more

Is the voltage output according to the brightness?

 Yes

 [Go to 6.](#)

 No

 [Go to 4.](#)

4. CHECK LIGHT CONTROL SENSOR.

Check the light control sensor.  [Ref. to LIGHTING SYSTEM>Light Control Sensor>INSPECTION.](#)

Is the light control sensor normal?

Yes

 [Go to 5.](#)

No

Replace the light control sensor.  [Ref. to LIGHTING SYSTEM>Light Control Sensor.](#)

5. CHECK HARNESS.

1. Disconnect the connectors from body integrated unit and light control sensor.
2. Check the harness between body integrated unit and light control sensor.



Connector & terminal

- (i82) No. 8 — (i159) No. 1:
- (i82) No. 28 — (i159) No. 2:
- (i82) No. 34 — (i159) No. 3:

Is harness normal?

Yes

Check the body integrated unit and replace it if defective.

- Inspection:  [Ref. to BODY CONTROL\(DIAGNOSTICS\)>Basic Diagnostic Procedure.](#)
- Replacement:  [Ref. to BODY CONTROL/COMMUNICATION SYSTEM>Body Integrated Unit.](#)

No



Repair or replace the defective part.

6. CHECK CURRENT DATA.

1. Set the lighting switch to AUTO position.
2. Using the Subaru Select Monitor, display the following items in the [Data monitor] of [Body Control].  [Ref. to COMMON \(DIAGNOSTICS\)>Data Monitor.](#)
 - Other than for C0
 - [Lighting AUTO input]
 - For C0
 - [Lighting I Switch Input]
 - [Lighting II Switch Input]
 - [Lighting OFF Switch Input]
 - Is [Lighting AUTO input] set to [ON]? (Except for C0)
 - Are [Lighting I Switch Input], [Lighting II Switch Input] and [Lighting OFF Switch Input] set to [OFF]? (For C0)

Yes

Check the body integrated unit and replace it if defective.

- Inspection:  [Ref. to BODY CONTROL\(DIAGNOSTICS\)>Basic Diagnostic Procedure.](#)
- Replacement:  [Ref. to BODY CONTROL/COMMUNICATION SYSTEM>Body Integrated Unit.](#)

No

 [Go to 7.](#)

7. CHECK COMBINATION SWITCH (LIGHT).

1. Turn the ignition switch to OFF.
2. Check the combination switch (light).  [Ref. to LIGHTING SYSTEM>Combination Switch \(Light\)>INSPECTION.](#)

Is the combination switch (light) normal?

Yes

 [Go to 8.](#)

No

Replace the combination switch (light).  [Ref. to LIGHTING SYSTEM>Combination Switch \(Light\).](#)

8. CHECK HARNESS.

1. Disconnect the connectors of body integrated unit and combination switch (light).
2. Check the harness between body integrated unit and combination switch (light).

Connector & terminal

Other than for C0

- (i82) No. 35 — (i131) No. 18:
- (i83) No. 20 — (i131) No. 19:
- (i83) No. 28 — (i131) No. 20:

For C0

- (i82) No. 35 — (i131) No. 19:
- (i83) No. 20 — (i131) No. 18:
- (i83) No. 28 — (i131) No. 20:

Is harness normal?

Yes

 [Go to 9.](#)

No

Repair or replace the defective part.

9. CHECK HARNESS.

Check the harness between the combination switch (light) connector and the chassis ground.



Connector & terminal

(i131) No. 13 — Chassis ground:

Is the resistance less than 10 Ω ?

Yes

Check the body integrated unit and replace it if defective.

- Inspection:  [Ref. to BODY CONTROL\(DIAGNOSTICS\)>Basic Diagnostic Procedure.](#)
- Replacement:  [Ref. to BODY CONTROL/COMMUNICATION SYSTEM>Body Integrated Unit.](#)

No

Repair or replace the defective part.

7. CHECK OF WELCOME LIGHTING SYSTEM (IF IT DOES NOT ILLUMINATE)

1. CHECK BODY INTEGRATED UNIT SETTING.

1. Turn the ignition switch to ON.
2. Using Subaru Select Monitor, display the data of [Welcome Light Off Delay Time(Approaching)] or [Welcome Light Off Delay Time(Exiting)] in [Customize] of [Body Control].  [Ref. to BODY CONTROL\(DIAGNOSTICS\)>Customize.](#)

Is the setting other than [OFF]?

 [Go to 2.](#)

Turn the setting to other than [OFF].

2. CHECK BODY INTEGRATED UNIT SETTING.

Using Subaru Select Monitor, display data of [Illumination Sensor Setting] in [Customize] of [Body Control].  [Ref. to BODY CONTROL\(DIAGNOSTICS\)>Customize.](#)

Is the setting in the [Exist]?

 [Go to 3.](#)

Turn the setting to [Support].

3. CHECK AUTO HEADLIGHT.

1. Set the lighting switch to AUTO position.
2. Make the light control sensor vicinity dark.
3. Turn the ignition switch to ON.

Do the parking light, tail light and headlight illuminate?

 [Go to 4.](#)

Check the auto headlight system.  [Ref. to LIGHTING SYSTEM>Headlight System>INSPECTION > BASIC INSPECTION.](#)

4. CHECK DOOR LOCK.

Operate the door lock using the access key.

Do the lock and unlock operate properly?

Yes

 [Go to 5.](#)

No

Check the keyless access with push button start system.  [Ref. to KEYLESS ACCESS WITH PUSH BUTTON START\(DIAGNOSTICS\)>Basic Diagnostic Procedure.](#)



5. CHECK BODY INTEGRATED UNIT.

1. Turn the ignition switch to ON.
2. Using the Subaru Select Monitor, display the following items in the [Data monitor] of [Body Control].  [Ref. to COMMON \(DIAGNOSTICS\)>Data Monitor.](#)
 - [IGN voltage]
 - [BATT voltage (BACKUP)]

Is the voltage 10 — 15 V?

Yes

Check the body integrated unit and replace it if defective.

- Inspection:  [Ref. to BODY CONTROL\(DIAGNOSTICS\)>Basic Diagnostic Procedure.](#)
- Replacement:  [Ref. to BODY CONTROL/COMMUNICATION SYSTEM>Body Integrated Unit.](#)

No

Repair or replace the defective part.

8. CHECK OF WELCOME LIGHTING SYSTEM (IF IT DOES NOT GO OFF)

1. CHECK BODY INTEGRATED UNIT SETTING.

1. Turn the ignition switch to ON.
2. Using Subaru Select Monitor, display the data of [Welcome Light Off Delay Time(Approaching)] or [Welcome Light Off Delay Time(Exiting)] in [Customize] of [Body Control].  [Ref. to BODY CONTROL\(DIAGNOSTICS\)>Customize.](#)

Is the illumination time setting correct?

 Yes

 [Go to 2.](#)

 No

Set the illumination time.

2. CHECK THE LIGHTS.

Check if the lights illuminate or go out.

- Does the headlight illuminate when the lighting switch is moved to the switch 2 (HEAD) position?
- Do the parking light, tail light, and headlight go out when the lighting switch is moved to the switch OFF position?

 Yes

 [Go to 3.](#)

 No

Check the combination switch (light) and each light circuit.

3. CHECK BODY INTEGRATED UNIT.

1. Turn the ignition switch to ON.
2. Using the Subaru Select Monitor, display the following items in the [Data monitor] of [Body Control].  [Ref. to COMMON \(DIAGNOSTICS\)>Data Monitor.](#)
 - [IGN voltage]
 - [BATT voltage (BACKUP)]

Is the voltage 10 – 15 V?

 Yes

 [Go to 4.](#)

 No

Repair or replace the defective part.

4. CHECK BODY INTEGRATED UNIT.

Using Subaru Select Monitor, display [Driver's door SW input] in [Data monitor] of [Body Control]. 
[Ref. to COMMON \(DIAGNOSTICS\)>Data Monitor.](#)

Does the display switch between [OFF] ↔ [ON] when driver's door is opened/closed?

Yes

 [Go to 5.](#)

No

Check the door switch.  [Ref. to SECURITY AND LOCKS>Door Lock Control System>INSPECTION > CHECK DOOR SWITCH.](#)

5. CHECK DOOR LOCK.

Operate the door lock using the access key.

Do the lock and unlock operate properly?

Yes

Replace the body integrated unit.  [Ref. to BODY CONTROL/COMMUNICATION SYSTEM>Body Integrated Unit.](#)

No

Check the keyless access with push button start system.  [Ref. to KEYLESS ACCESS WITH PUSH BUTTON START\(DIAGNOSTICS\)>Basic Diagnostic Procedure.](#)

9. CHECK WIPER INTERLOCK HEADLIGHT SYSTEM

Wiring diagram:

Front wiper and washer system  [Ref. to WIRING SYSTEM>Front Wiper and Washer System>WIRING DIAGRAM.](#)

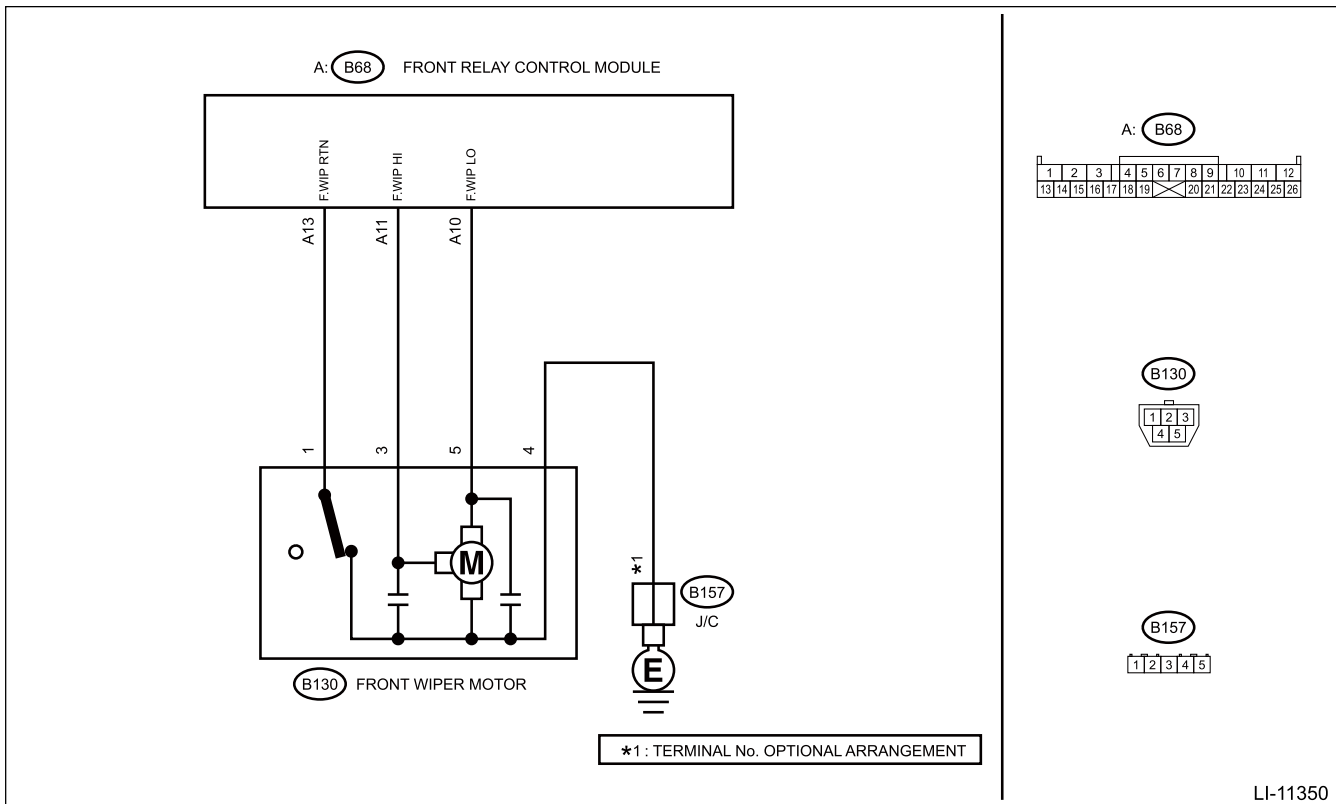

1. AUTO HEADLIGHT SYSTEM CHECK.

1. Turn the ignition switch to ON.
2. Check the operation of auto headlight system.

Is the system normal?

Yes

 [Go to 2.](#)

No

Check and repair the auto headlight system.  [Ref. to LIGHTING SYSTEM>Headlight System>INSPECTION > CHECK HEADLIGHT SYSTEM.](#)

2. CHECK LIGHT CONTROL SENSOR.

Using Subaru Select Monitor, display data of [Wiper Link Auto Light Setup] in [Customize] of [Body Control].  [Ref. to BODY CONTROL\(DIAGNOSTICS\)>Customize.](#)

Is the setting [ON]?

Yes

 [Go to 3.](#)

No

Turn the setting to [ON].



3. CHECK DIAGNOSTIC TROUBLE CODE (DTC).

1. Turn the ignition switch to ON and wait for at least 10 seconds.
2. Read DTCs of the following items using the Subaru Select Monitor.  [Ref. to LAN SYSTEM \(DIAGNOSTICS\)>Diagnostic Trouble Code \(DTC\).](#)
 - [Body Control]
 - [Front Relay Control Module]

Is DTC displayed?

Yes

Perform the diagnosis for the displayed DTCs.

- [Body Control]:  [Ref. to BODY CONTROL\(DIAGNOSTICS\)>Diagnostic Trouble Code \(DTC\)>LIST.](#)
- [Front Relay Control Module]:  [Ref. to FRONT RELAY CONTROL MODULE \(DIAGNOSTICS\)>Diagnostic Trouble Code \(DTC\)>LIST.](#)

No

 [Go to 4.](#)

4. CHECK FRONT RELAY CONTROL MODULE.

Using Subaru Select Monitor, display data of [F Wiper(RTN) Input] in [Data Monitor] of [Front Relay Control Module].  [Ref. to COMMON \(DIAGNOSTICS\)>Data Monitor.](#)

Does the display switch between [OFF] ↔ [ON] when the combination switch (wiper) is operated OFF ↔ INT/LO/HI?

Yes

 [Go to 5.](#)

No

 [Go to 6.](#)

5. CHECK BODY INTEGRATED UNIT.

Using Subaru Select Monitor, display data of [Fr wiper input] in [Data Monitor] of [Body Control]. 
[Ref. to COMMON \(DIAGNOSTICS\)>Data Monitor.](#)



Does the display switch between [OFF] ↔ [ON] when the combination switch (wiper) is operated OFF ↔ INT/LO/HI?

Yes

Check the light control sensor, and then repair or replace it if defective.  [Ref. to LIGHTING SYSTEM>Light Control Sensor.](#)

No

Check the body integrated unit and replace it if defective.

- Inspection:  [Ref. to BODY CONTROL\(DIAGNOSTICS\)>Basic Diagnostic Procedure.](#)
- Replacement:  [Ref. to BODY CONTROL/COMMUNICATION SYSTEM>Body Integrated Unit.](#)

6. CHECK FRONT RELAY CONTROL MODULE.

Measure the voltage between front relay control module connector and chassis ground.

Connector & terminal

(B68) No. 13 (+) — Chassis ground (-):

Does the voltage switch between OFF (less than 1 V) ↔ ON (9 — 16 V) when the combination switch (wiper) is operated OFF ↔ INT/LO/HI?

Yes

Check the front relay control module and replace it if defective.

- Inspection:  [Ref. to FRONT RELAY CONTROL MODULE \(DIAGNOSTICS\)>Basic Diagnostic Procedure.](#)
- Replacement:  [Ref. to BODY CONTROL/COMMUNICATION SYSTEM>Front Relay Control Module.](#)

No

 [Go to 7.](#)

7. CHECK HARNESS.

1. Turn the ignition switch to OFF.
2. Disconnect the connectors of front wiper motor and front relay control module.
3. Check the harness between the front wiper motor and the front relay control module.

Connector & terminal

(B130) No. 1 — (B68) No. 13:

Is the resistance less than 10 Ω ?

Yes

 [Go to 8.](#)

No

Repair or replace the defective part.

8. CHECK HARNESS.

Check the harness between the front wiper motor connector and the chassis ground.

Connector & terminal

(B130) No. 4 — Chassis ground:

Is the resistance less than 10 Ω ?

Yes

 [Go to 9.](#)

No

Repair or replace the defective part.

9. CHECK FRONT WIPER MOTOR.

Check the continuity between front wiper motor terminals.

Connector & terminal

(B130) No. 1 — (B130) No. 5:

Is there continuity?

Yes

Check the front relay control module and replace it if defective.

- Inspection:  [Ref. to FRONT RELAY CONTROL MODULE \(DIAGNOSTICS\)>Basic Diagnostic Procedure.](#)
- Replacement:  [Ref. to BODY CONTROL/COMMUNICATION SYSTEM>Front Relay Control Module.](#)

No

Replace the front wiper motor.  [Ref. to WIPER AND WASHER SYSTEMS>Front Wiper Motor and Link.](#)

10. CHECK STEERING RESPONSIVE HEADLIGHT SYSTEM

For inspection procedures in the steering responsive headlight system, refer to “Basic Diagnostic Procedure” of “HEADLIGHT / FOGLIGHT (DIAGNOSTICS)” section.  [Ref. to HEADLIGHT / FOGLIGHT\(DIAGNOSTICS\)>Basic Diagnostic Procedure.](#)

11. CHECK LIGHTING SWITCH

For the lighting switch inspection, refer to “Combination Switch (Light)”.  [Ref. to LIGHTING SYSTEM>Combination Switch \(Light\)>INSPECTION.](#)





12. CHECK DIMMER & PASSING SWITCH

For the dimmer & passing switch inspection, refer to “Combination Switch (Light)”.  [Ref. to LIGHTING SYSTEM>Combination Switch \(Light\)>INSPECTION.](#)

LIGHTING SYSTEM > Headlight System

NOTE

For operation procedures of components of the headlight system, refer to the following sections.

- Headlight assembly:  [Ref. to LIGHTING SYSTEM>Headlight Assembly.](#)
- Combination switch (light):  [Ref. to LIGHTING SYSTEM>Combination Switch \(Light\).](#)
- Body integrated unit:  [Ref. to BODY CONTROL/COMMUNICATION SYSTEM>Body Integrated Unit.](#)
- Front relay control module:  [Ref. to BODY CONTROL/COMMUNICATION SYSTEM>Front Relay Control Module.](#)
- Light control sensor:  [Ref. to LIGHTING SYSTEM>Light Control Sensor.](#)

LIGHTING SYSTEM > High Beam Assist System

WIRING DIAGRAM

For the wiring diagram, refer to "Headlight System" in the wiring diagram. [🔗 Ref. to WIRING SYSTEM>Headlight System>WIRING DIAGRAM.](#)

LIGHTING SYSTEM > High Beam Assist System

INSPECTION

1. BASIC INSPECTION

For inspection, refer to the "BODY CONTROL (DIAGNOSTICS)" section. [🔗 Ref. to BODY CONTROL\(DIAGNOSTICS\)>Diagnostics with Phenomenon.](#)

2. SYSTEM BLOCK DIAGRAM

Note:

The high beam assist system uses the stereo cameras of the EyeSight system to recognize the conditions in front of the vehicle, and automatically switches the high beam and low beam of the headlight.

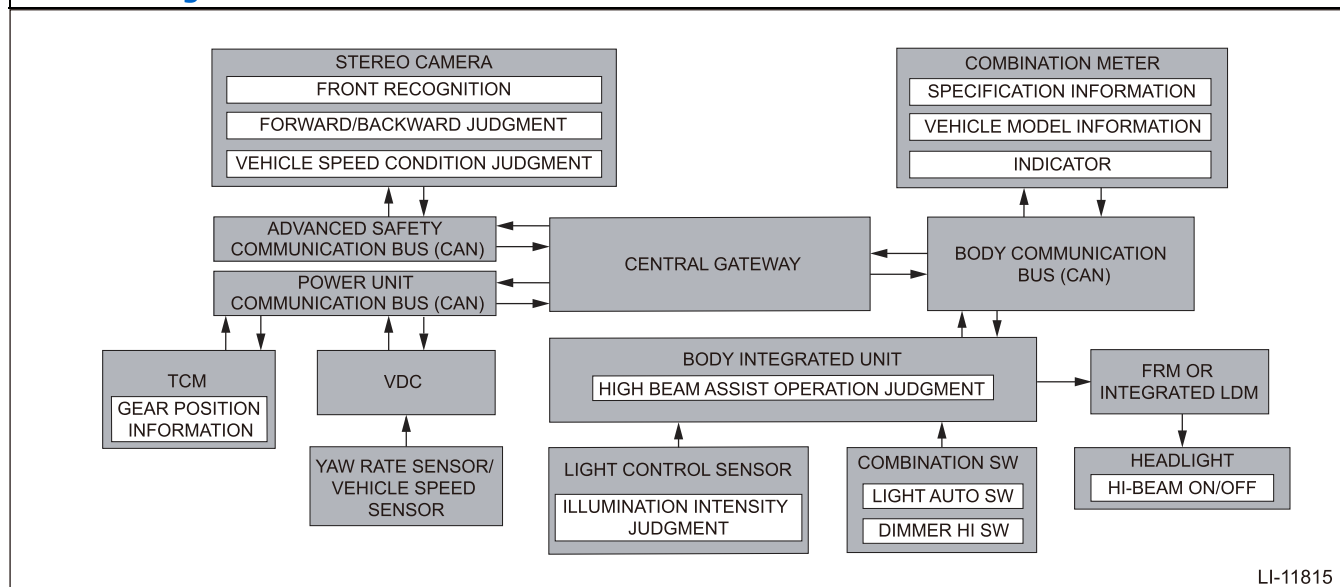

LIGHTING SYSTEM > High Beam Assist System

NOTE

For operation procedures of components in the high beam assist system, refer to the following sections.

- Headlight assembly: [🔗 Ref. to LIGHTING SYSTEM>Headlight Assembly.](#)
- Combination switch (light): [🔗 Ref. to LIGHTING SYSTEM>Combination Switch \(Light\).](#)
- Body integrated unit: [🔗 Ref. to BODY CONTROL/COMMUNICATION SYSTEM>Body Integrated Unit.](#)
- Stereo camera: [🔗 Ref. to EyeSight>Stereo Camera.](#)
- Light control sensor: [🔗 Ref. to LIGHTING SYSTEM>Light Control Sensor.](#)

LIGHTING SYSTEM > Day Time Running Light System

WIRING DIAGRAM

For the wiring diagram, refer to "Daytime Running Light System" in the wiring diagram.  [Ref. to WIRING SYSTEM>Daytime Running Light System>WIRING DIAGRAM.](#)

LIGHTING SYSTEM > Day Time Running Light System

INSPECTION

1. TROUBLE SYMPTOM

Daytime running light does not illuminate.

Wiring diagram:

Daytime running light system  [Ref. to WIRING SYSTEM>Daytime Running Light System>WIRING DIAGRAM.](#)

• MODEL WITHOUT SRH

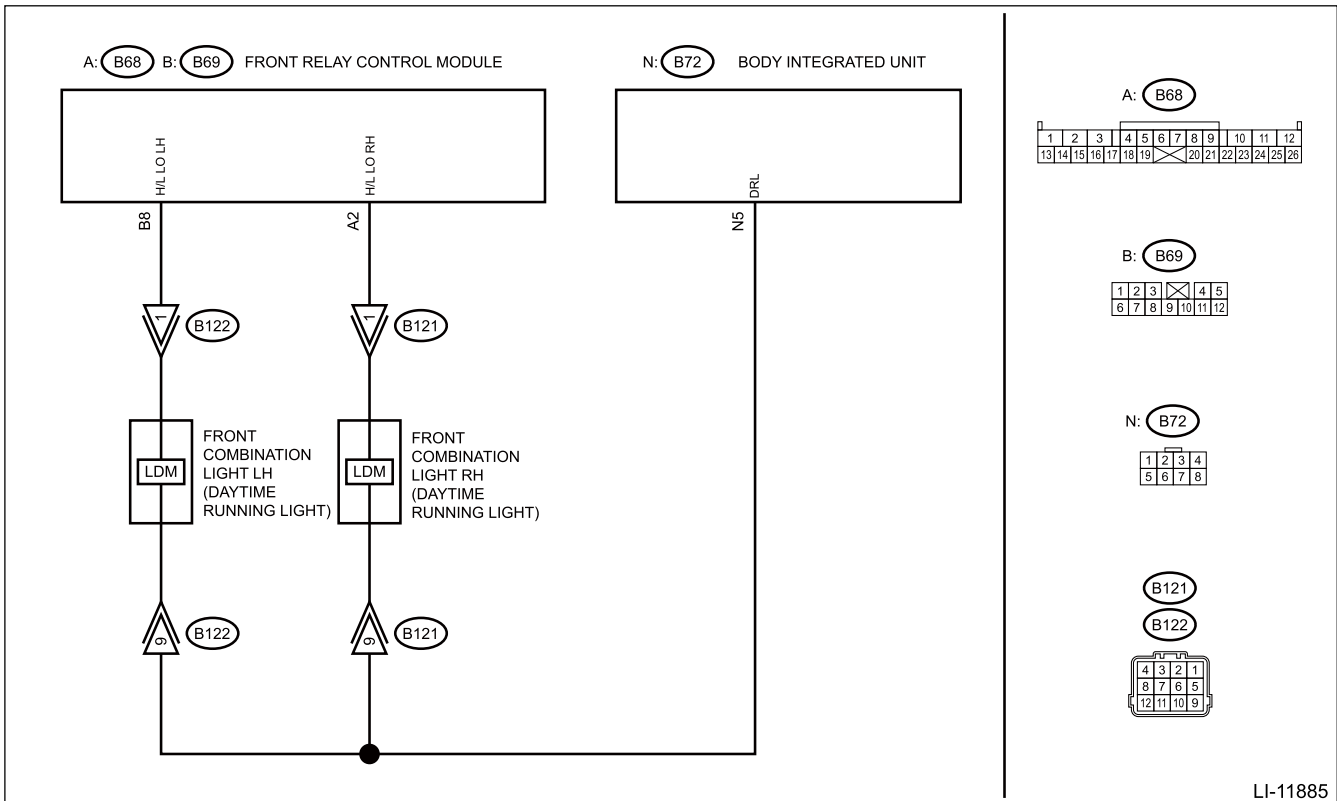

LI-11885

Note:

Operate the appropriate switch according to the inspection condition.



1. CHECK DTC.

1. Turn the ignition switch to ON.
2. Read DTCs of the following items using the Subaru Select Monitor.  [Ref. to LAN SYSTEM \(DIAGNOSTICS\)>Diagnostic Trouble Code \(DTC\).](#)
 - [Body Control]
 - [Front Relay Control Module]

Is DTC displayed?

Yes

Perform the diagnosis for the displayed DTCs.

- [Body Control]:  [Ref. to BODY CONTROL\(DIAGNOSTICS\)>Diagnostic Trouble Code \(DTC\)>LIST.](#)
- [Front Relay Control Module]:  [Ref. to FRONT RELAY CONTROL MODULE \(DIAGNOSTICS\)>Diagnostic Trouble Code \(DTC\)>LIST.](#)

No

 [Go to 2.](#)

2. CHECK DATA MONITOR.

Using the Subaru Select Monitor, display the following items in the [Data monitor] of [Body Control].  [Ref. to COMMON \(DIAGNOSTICS\)>Data Monitor.](#)

- [IGN voltage]
- [Shift Position]
- [EPB operating status]
- [P SW]
- [Lighting II Switch Input]

Is the input signal normal?

Yes

 [Go to 3.](#)

No

Check the defective part.

3. CHECK DAYTIME RUNNING LIGHT.

1. Start the engine.
2. Turn the lighting switch to the OFF position.
3. Release the parking brake.

Does the daytime running light illuminate/go off when the parking brake is operated [ON] ↔ [OFF]?

Yes

Check the headlight assembly and replace it if defective.

No

 [Go to 4.](#)

4. CHECK HARNESS.

1. Turn the ignition switch to OFF.
2. Disconnect the front relay control module and headlight connector.
3. Check the harness between the front relay control module and the headlight.

Connector & terminal

Headlight RH

(B68) No. 2 (+) — (B121) No. 1 (-):

Headlight LH

(B69) No. 8 (+) — (B122) No. 1 (-):

Is harness normal?

Yes

 [Go to 5.](#)

No

Repair or replace the defective part.

5. CHECK HARNESS.

1. Disconnect the body integrated unit and headlight connector.
2. Check the harness between the body integrated unit and headlight.

Connector & terminal

Headlight RH

(B121) No. 9 (+) — (B72) No. 5 (-):

Headlight LH

(B122) No. 9 (+) — (B72) No. 5 (-):

● MODEL WITH SRH

Notes harness normal?

Operate the appropriate switch according to the inspection condition.

Yes

 [Go to 6.](#)

1. CHECK DTC.

No

Repair or replace the defective part.

1. Turn the ignition switch to ON.
2. Read DTCs of the following items using the Subaru Select Monitor.  [Ref. to LAN SYSTEM \(DIAGNOSTICS\)>Diagnostic Trouble Code \(DTC\).](#)

6. CHECK DAYTIME RUNNING LIGHT ILLUMINATION.

[Body Control]

- [Front Relay Control Module]

1. Disconnect the headlight connector.
2. Apply voltage to the DRL terminal input of the headlight unit.

Caution:

When applying battery voltage, do not mix up the positive (+) side and the negative (-) side.  Ref. to BODY CONTROL (DIAGNOSTICS)>Diagnostic Trouble Code (DTC)>LIST.

Connector & terminal

Headlight RH

[Front Relay Control Module]:  [Ref. to FRONT RELAY CONTROL MODULE \(DIAGNOSTICS\)>Diagnostic Trouble Code \(DTC\)>LIST.](#)

Headlight LH

 [Go to 2.](#) — (B122) No. 9 (-):

Does the daytime running light illuminate?

Yes

Replace the body integrated unit.  [Ref. to BODY CONTROL/COMMUNICATION SYSTEM>Body Integrated Unit.](#)

No

Replace the headlight.  [Ref. to LIGHTING SYSTEM>Headlight Assembly.](#)

2. CHECK DATA MONITOR.

Using the Subaru Select Monitor, display the following items in the [Data monitor] of [Body Control].  [Ref. to COMMON \(DIAGNOSTICS\)>Data Monitor.](#)

- [IGN voltage]
- [Shift Position]
- [EPB operating status]
- [P SW]
- [Lighting II Switch Input]

Is the input signal normal?

Yes

 [Go to 3.](#)

No







Check the defective part.

3. CHECK DATA MONITOR.

1. Start the engine.
2. Release the parking brake.
3. Using Subaru Select Monitor, display [Daytime Running Light(Alternate System) Output] in [Data monitor] of [Body Control].  [Ref. to COMMON \(DIAGNOSTICS\)>Data Monitor.](#)

LIGHTING SYSTEM > Day Time Running Light System

NOTE Does the display of [Daytime Running Light(Alternate System) Output] switch between [OFF] ←→ [ON] when the lighting switch is switched from the OFF position to the 2 (HEAD) position? For operation procedures of components of the daytime running light system, refer to the following sections.

- Headlight assembly:  [Ref. to LIGHTING SYSTEM>Headlight Assembly.](#)
Check the headlight assembly and replace it if defective.
- Combination switch (light):  [Ref. to LIGHTING SYSTEM>Combination Switch \(Light\).](#)
- Body integrated unit:  [Ref. to BODY CONTROL/COMMUNICATION SYSTEM>Body Integrated Unit.](#)
Check the body integrated unit and replace it if defective.
- Front relay control module:  [Ref. to BODY CONTROL/COMMUNICATION SYSTEM>Front Relay Control Module.](#)
 - Inspection:  [Ref. to BODY CONTROL\(DIAGNOSTICS\)>Basic Diagnostic Procedure.](#)
 - Replacement:  [Ref. to BODY CONTROL/COMMUNICATION SYSTEM>Body Integrated Unit.](#)

LIGHTING SYSTEM > Clearance Light and Illumination Light System

WIRING DIAGRAM

For the wiring diagram, refer to "Clearance Light and Illumination Light System" in the wiring diagram. 
[Ref. to WIRING SYSTEM>Clearance Light and Illumination Light System>WIRING DIAGRAM.](#)

LIGHTING SYSTEM > Clearance Light and Illumination Light System

INSPECTION

1. TROUBLE SYMPTOM

Parking light and tail light do not illuminate or lights are weak

Wiring diagram:

Clearance light and illumination light system  [Ref. to WIRING SYSTEM>Clearance Light and Illumination Light System>WIRING DIAGRAM.](#)

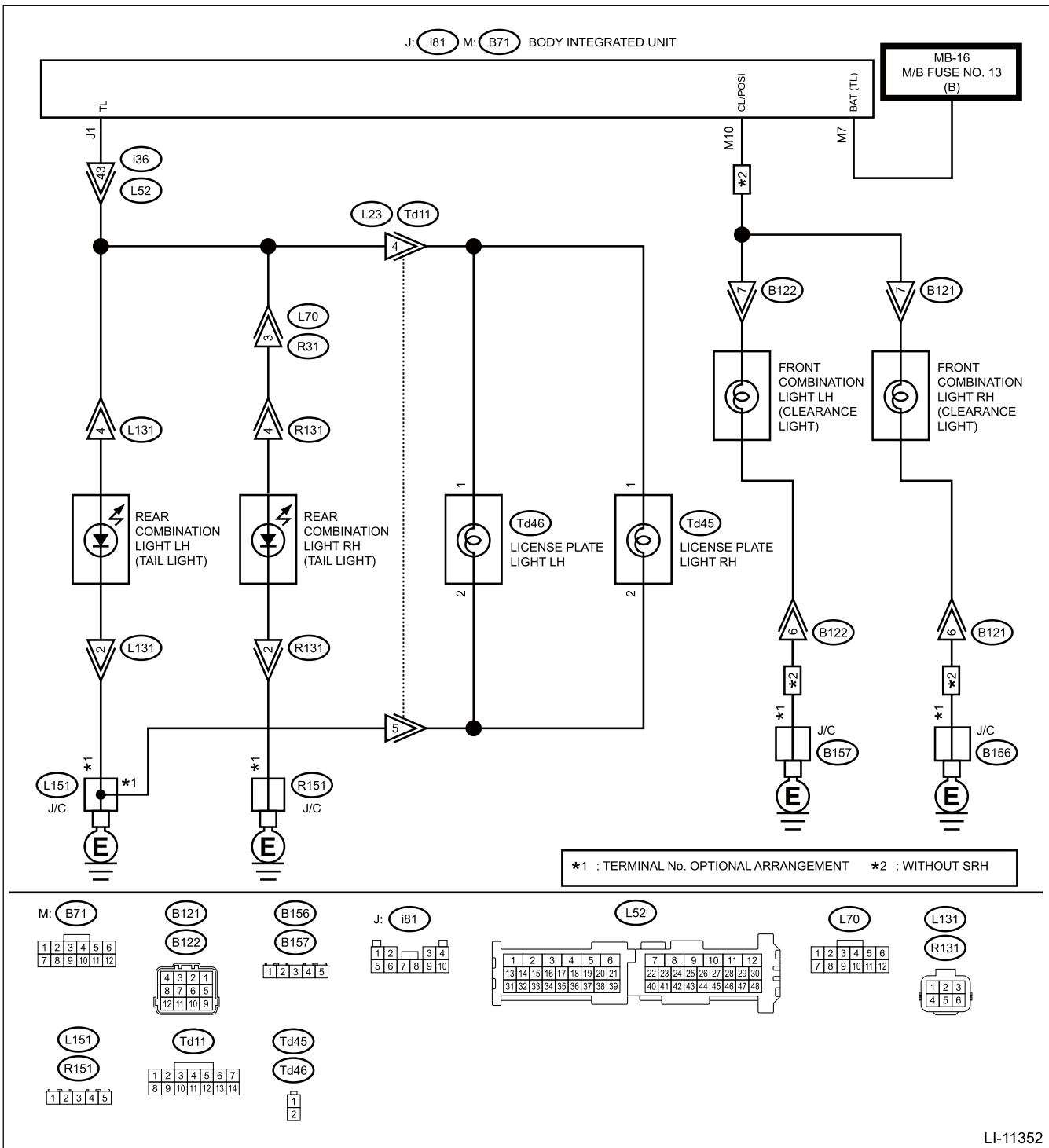

LI-11352

Note:

Perform unit inspection of the combination switch (light) and illumination light to check that there are no problems.

1. CHECK ILLUMINATION LIGHT SYSTEM.

1. Turn the ignition switch to ON.
2. Turn the lighting switch to the switch 1 (TAIL) position.

Does the illumination light come on?

Yes

Illumination light is normal.

No

 [Go to 2.](#)

2. CHECK BODY INTEGRATED UNIT.

Read the DTC of [Body Control] using the Subaru Select Monitor.  [Ref. to COMMON \(DIAGNOSTICS\)>Diagnostic Trouble Code \(DTC\).](#)

Is DTC displayed?

Yes

Perform the diagnosis for the displayed DTCs.  [Ref. to BODY CONTROL\(DIAGNOSTICS\)>Diagnostic Trouble Code \(DTC\)>LIST.](#)

No

 [Go to 3.](#)

3. CHECK POWER SUPPLY.

Using the Subaru Select Monitor, display the following items in the [Data monitor] of [Body Control].
 [Ref. to COMMON \(DIAGNOSTICS\)>Data Monitor.](#)

- [BATT voltage (control)]
- [BATT voltage (BACKUP)]
- [IGN voltage]



Is the voltage 9 – 16 V?

Yes

 [Go to 4.](#)

No

Check the body integrated unit and replace it if defective.

- Inspection:  [Ref. to BODY CONTROL\(DIAGNOSTICS\)>Basic Diagnostic Procedure.](#)
- Replacement:  [Ref. to BODY CONTROL/COMMUNICATION SYSTEM>Body Integrated Unit.](#)

4. CHECK CLEARANCE LIGHT POWER SUPPLY CIRCUIT.

1. Turn the ignition switch to OFF.
2. Disconnect the connector of body integrated unit.
3. Measure the voltage between the body integrated unit connector and chassis ground.

Terminals

(B71) No. 7 (+) — Chassis ground (-):



Is the voltage 9 — 16 V?

Yes

 [Go to 5.](#)

No

Check the body integrated unit and replace it if defective.

- Inspection:  [Ref. to BODY CONTROL\(DIAGNOSTICS\)>Basic Diagnostic Procedure.](#)
- Replacement:  [Ref. to BODY CONTROL/COMMUNICATION SYSTEM>Body Integrated Unit.](#)

5. CHECK HARNESS.

1. Disconnect the connector of the light which did not illuminate.
2. Check the harness between body integrated unit and each light.

Connector & terminal

Headlight RH (model without SRH)

(B71) No. 10 — (B121) No. 7:

Headlight LH (model without SRH)

(B71) No. 10 — (B122) No. 7:

Rear combination light RH

(i81) No. 1 — (R131) No. 4:

Rear combination light LH

(i81) No. 1 — (L131) No. 4:

License plate light RH

(i81) No. 1 — (Td45) No. 1:

License plate light LH

(i81) No. 1 — (Td46) No. 1:

Is harness normal?

Yes

 [Go to 6.](#)

No

Repair or replace the defective part.

6. CHECK THE LIGHTS.

Apply battery voltage between light connector terminals.

Caution:

When applying battery voltage, do not mix up the positive (+) side and the negative (-) side. Incorrect polarity connection may cause internal LED damage.

Connector & terminal

Headlight RH (model without SRH)

(B121) No. 7 (+) – (B121) No. 6 (-):

Headlight LH (model without SRH)

(B121) No. 7 (+) – (B122) No. 6 (-):

Rear combination light RH

(R131) No. 4 (+) – (R131) No. 2 (-):

Rear combination light LH

(L131) No. 4 (+) – (L131) No. 2 (-):

License plate light RH

(Td45) No. 1 (+) – (Td45) No. 2 (-):

License plate light LH

(Td46) No. 1 (+) – (Td46) No. 2 (-):

Does it illuminate?

Yes

 [Go to 7.](#)

No

Repair or replace the defective part.

7. CHECK HARNESS.

Check the harness between each light connector and the chassis ground.

Connector & terminal

Rear combination light RH

(R131) No. 2 — Chassis ground:

Rear combination light LH

(L131) No. 2 — Chassis ground:

License plate light RH

(Td45) No. 2 — Chassis ground:



License plate light LH

(Td46) No. 2 — Chassis ground:

Is the resistance less than 10 Ω?

Yes

Check the body integrated unit and replace it if defective.

- Inspection:  [Ref. to BODY CONTROL\(DIAGNOSTICS\)>Basic Diagnostic Procedure.](#)
- Replacement:  [Ref. to BODY CONTROL/COMMUNICATION SYSTEM>Body Integrated Unit.](#)

No

Repair or replace the defective part.





2. CHECK LIGHTING SWITCH

For the lighting switch inspection, refer to "Combination Switch (Light)".  [Ref. to LIGHTING SYSTEM>Combination Switch \(Light\)>INSPECTION.](#)

LIGHTING SYSTEM > Clearance Light and Illumination Light System

NOTE

For operation procedures of components of the clearance light and illumination light system, refer to the following sections.

- Headlight assembly:  [Ref. to LIGHTING SYSTEM>Headlight Assembly.](#)
- Combination switch (light):  [Ref. to LIGHTING SYSTEM>Combination Switch \(Light\).](#)
- Rear combination light assembly:  [Ref. to LIGHTING SYSTEM>Rear Combination Light Assembly.](#)
- License plate light:  [Ref. to LIGHTING SYSTEM>License Plate Light.](#)
- LED illumination light:  [Ref. to LIGHTING SYSTEM>LED Illumination Light.](#)

LIGHTING SYSTEM > Front Fog Light System

WIRING DIAGRAM

For the wiring diagram, refer to "Front Fog Light System" in the wiring diagram.  [Ref. to WIRING SYSTEM>Front Fog Light System>WIRING DIAGRAM.](#)

LIGHTING SYSTEM > Front Fog Light System

INSPECTION

1. TROUBLE SYMPTOM

Fog light does not illuminate.

Note:

Operate the appropriate switch according to the inspection condition.



1. CHECK DTC.

1. Turn the ignition switch to ON.
2. Turn the lighting switch to the switch 2 (HEAD) position.
3. Turn the front fog light switch of the lighting switch to ON.
4. Read DTCs of the following items using the Subaru Select Monitor.  [Ref. to LAN SYSTEM \(DIAGNOSTICS\)>Diagnostic Trouble Code \(DTC\).](#)
 - [Body Control]
 - [Front Relay Control Module]

Is DTC displayed?

Yes

Perform the diagnosis for the displayed DTCs.

- [Body Control]:  [Ref. to BODY CONTROL\(DIAGNOSTICS\)>Diagnostic Trouble Code \(DTC\)>LIST.](#)
- [Front Relay Control Module]:  [Ref. to FRONT RELAY CONTROL MODULE \(DIAGNOSTICS\)>Diagnostic Trouble Code \(DTC\)>LIST.](#)

No

 [Go to 2.](#)

2. CHECK POWER SUPPLY.

Display data of the following items using Subaru Select Monitor.  [Ref. to COMMON \(DIAGNOSTICS\)>Data Monitor.](#)

- [Body Control]
 - [BATT voltage (control)]
 - [BATT voltage (BACKUP)]
 - [IGN voltage]
- [Front Relay Control Module]
 - [BATT Voltage (Control)]
 - [BATT Voltage (BACKUP)]
 - [IGN Voltage]



Is the voltage 9 – 16 V?

Yes

 [Go to 3.](#)

No

Check the body integrated unit and replace it if defective.

- Inspection:  [Ref. to BODY CONTROL\(DIAGNOSTICS\)>Basic Diagnostic Procedure.](#)
- Replacement:  [Ref. to BODY CONTROL/COMMUNICATION SYSTEM>Body Integrated Unit.](#)

Check the front relay control module and replace it if defective.

- Inspection:  [Ref. to FRONT RELAY CONTROL MODULE \(DIAGNOSTICS\)>Basic Diagnostic Procedure.](#)
- Replacement:  [Ref. to BODY CONTROL/COMMUNICATION SYSTEM>Front Relay Control Module.](#)

3. PERFORM ACTIVE TEST.

Using the Subaru Select Monitor, select [F Fog Light Output] in [Active Test] of [Front Relay Control Module] to turn on the front fog light.  [Ref. to FRONT RELAY CONTROL MODULE \(DIAGNOSTICS\)>Active Test.](#)

Does it illuminate?

Yes

 [Go to 4.](#)

No

Check the harness of the relay and output circuit. If there are no problems, replace the front relay control module.  [Ref. to BODY CONTROL/COMMUNICATION SYSTEM>Front Relay Control Module.](#)

4. CHECK CURRENT DATA.

1. Turn the ignition switch to ON.
2. Using Subaru Select Monitor, display [Front Fog Light SW input] in [Data monitor] of [Body Control].  [Ref. to COMMON \(DIAGNOSTICS\)>Data Monitor.](#)

Does the display change from [OFF] ↔ [ON] when the front fog light switch of the lighting switch is operated?

Yes

 [Go to 5.](#)

No

Check the harnesses of the combination switch, connector and input circuit. If there are no problems, replace the body integrated unit.  [Ref. to BODY CONTROL/COMMUNICATION SYSTEM>Body Integrated Unit.](#)

5. CHECK CURRENT DATA.

1. Turn the ignition switch to ON.
2. Using Subaru Select Monitor, display [F Fog Light Request] in [Data monitor] of [Front Relay Control Module].  [Ref. to COMMON \(DIAGNOSTICS\)>Data Monitor.](#)

Does the display change from [OFF] ↔ [ON] when the front fog light switch of the lighting switch is operated?

Yes

Replace the front relay control module.  [Ref. to BODY CONTROL/COMMUNICATION SYSTEM>Front Relay Control Module.](#)

No

Replace the body integrated unit.  [Ref. to BODY CONTROL/COMMUNICATION SYSTEM>Body Integrated Unit.](#)





2. CHECK FRONT FOG LIGHT SWITCH

For the front fog light switch inspection, refer to "Combination Switch (Light)".  [Ref. to LIGHTING SYSTEM>Combination Switch \(Light\)>INSPECTION.](#)

LIGHTING SYSTEM > Front Fog Light System

NOTE

For operation procedures of components of the front fog light system, refer to the following sections.

- Combination switch (light):  [Ref. to LIGHTING SYSTEM>Combination Switch \(Light\).](#)
- Front fog light assembly:  [Ref. to LIGHTING SYSTEM>Front Fog Light Assembly.](#)
- Body integrated unit:  [Ref. to BODY CONTROL/COMMUNICATION SYSTEM>Body Integrated Unit.](#)
- Front relay control module:  [Ref. to BODY CONTROL/COMMUNICATION SYSTEM>Front Relay Control Module.](#)

LIGHTING SYSTEM > Turn Signal Light and Hazard Light System



WIRING DIAGRAM

For the wiring diagram, refer to "Turn Signal and Hazard Light System" in the wiring diagram.  [Ref. to WIRING SYSTEM>Turn Signal Light and Hazard Light System>WIRING DIAGRAM.](#)

LIGHTING SYSTEM > Turn Signal Light and Hazard Light System

INSPECTION

1. TROUBLE SYMPTOM

Symptoms	Reference
The hazard light does not operate.	 Ref. to LIGHTING SYSTEM>Turn Signal Light and Hazard Light System>INSPECTION > CHECK HAZARD LIGHT OPERATION.
The turn signal light does not operate.	 Ref. to LIGHTING SYSTEM>Turn Signal Light and Hazard Light System>INSPECTION > CHECK TURN SIGNAL LIGHT SYSTEM.
The lane change signal function of the turn signal indicator does not operate.	 Ref. to LIGHTING SYSTEM>Turn Signal Light and Hazard Light System>INSPECTION > CHECK LANE CHANGE SIGNAL FUNCTION.

2. CHECK HAZARD LIGHT OPERATION

Wiring diagram:

Turn signal and hazard light system  [Ref. to WIRING SYSTEM>Turn Signal Light and Hazard Light System>WIRING DIAGRAM.](#)

MB-17
M/B FUSE NO. 14
(B)

M: (B71) N: (B72) BODY INTEGRATED UNIT

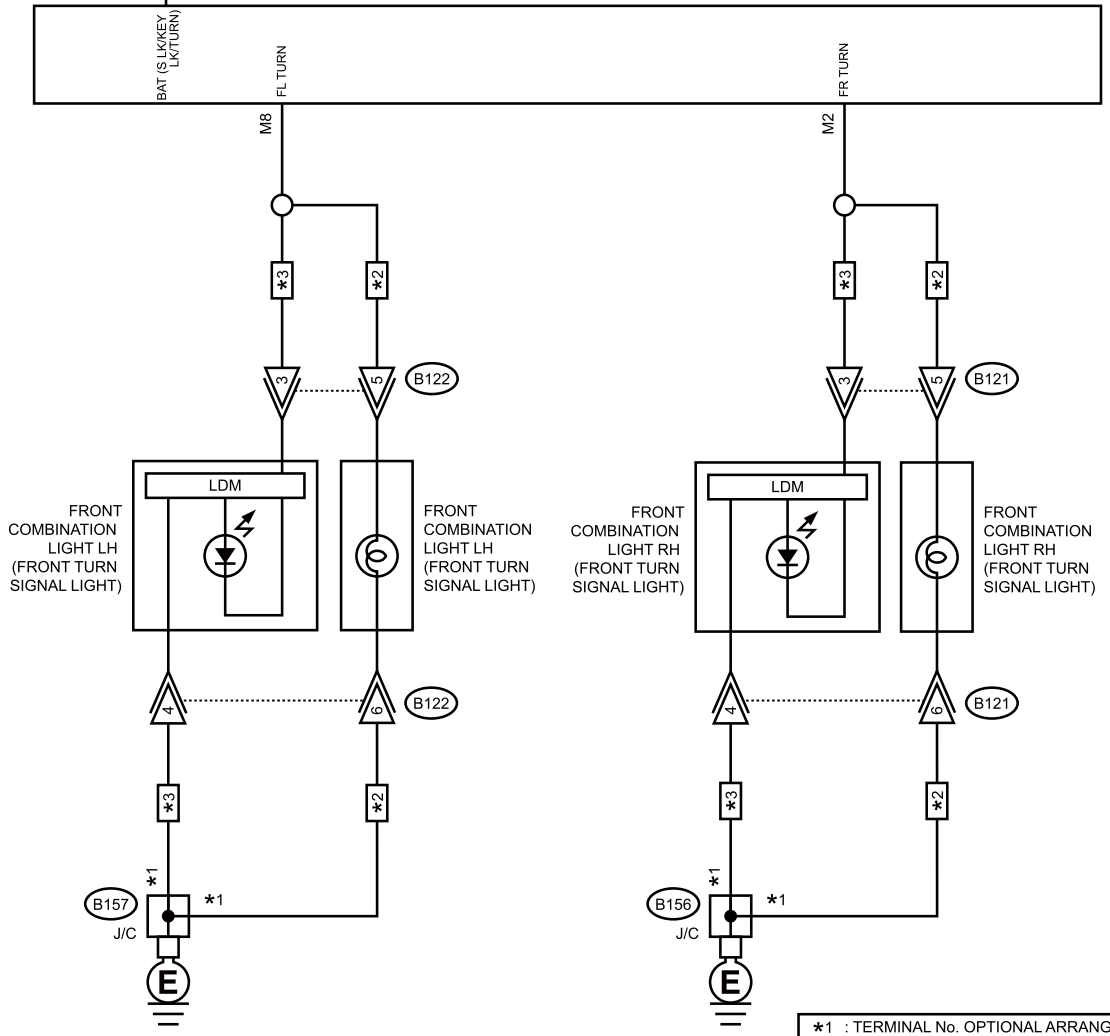

*1 : TERMINAL No. OPTIONAL ARRANGEMENT
*2 : WITHOUT SRH
*3 : WITH SRH

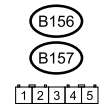
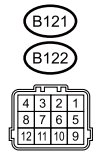
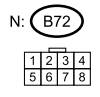
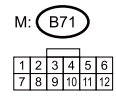

J: i81 K: i82 BODY INTEGRATED UNIT

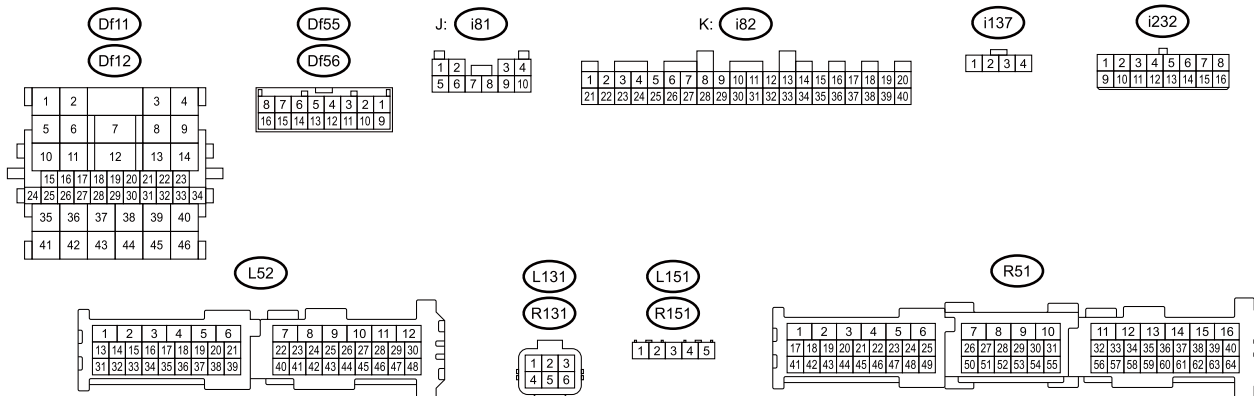
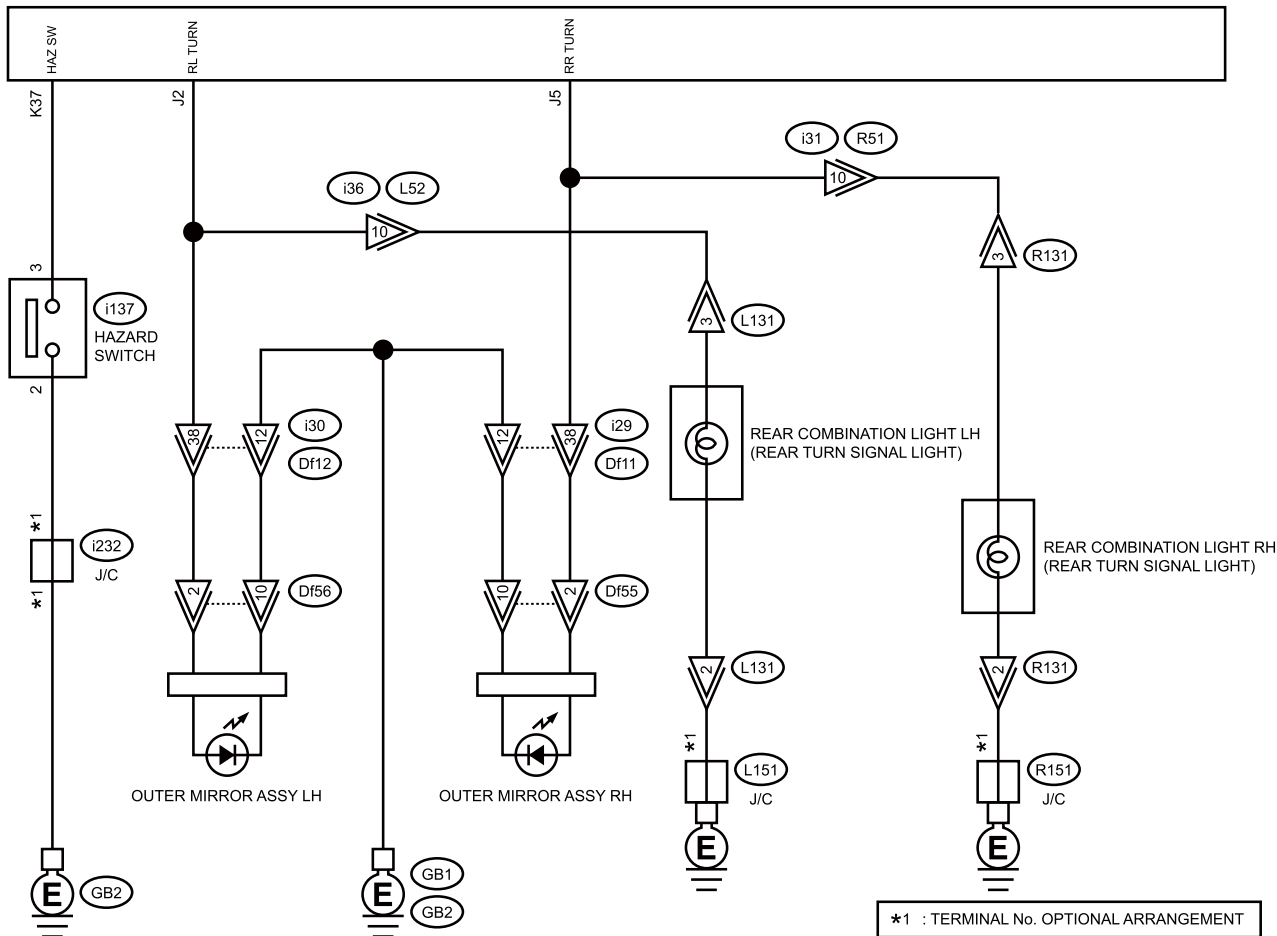

LI-11800

Note:

Operate the appropriate switch according to the inspection condition.

1. CHECK HAZARD LIGHT OPERATION.

1. Turn the hazard switch to ON.
2. Check that the hazard light operates properly.

Does the hazard light blink?

Yes

The hazard light system is normal.

No

 [Go to 2.](#)

2. CHECK BULB.

Check the hazard (turn signal) light bulb.

Is the bulb normal?

Yes

 [Go to 3.](#)

No

Replace the hazard (turn signal) light bulb.

3. CHECK DTC.

1. Turn the ignition switch to ON and wait for at least 10 seconds.
2. Read the DTC of [Body Control] using the Subaru Select Monitor.  [Ref. to COMMON \(DIAGNOSTICS\)>Diagnostic Trouble Code \(DTC\).](#)

Is DTC displayed?

Yes

Perform the diagnosis for the displayed DTCs.  [Ref. to BODY CONTROL\(DIAGNOSTICS\)>Diagnostic Trouble Code \(DTC\)>LIST.](#)

No

 [Go to 4.](#)

4. CHECK CURRENT DATA.

Using Subaru Select Monitor, display [Hazard switch Input] in [Data monitor] of [Body Control]. 
[Ref. to COMMON \(DIAGNOSTICS\)>Data Monitor.](#)

Does the display change as [OFF] ↔ [ON], when the hazard switch is turned from OFF to ON?

Yes

 [Go to 8.](#)

No

 [Go to 5.](#)

5. CHECK HAZARD SWITCH.

1. Turn the ignition switch to OFF.
2. Check the hazard switch.  [Ref. to LIGHTING SYSTEM>Hazard Switch>INSPECTION.](#)

Is the hazard switch normal?

Yes

 [Go to 6.](#)

No

Replace the hazard switch.  [Ref. to LIGHTING SYSTEM>Hazard Switch.](#)

6. CHECK HARNESS.

1. Disconnect the connectors of body integrated unit and hazard switch.
2. Check the harness between body integrated unit and hazard switch.

Connector & terminal

(i82) No. 37 — (i137) No. 3:

Is harness normal?

Yes

 [Go to 7.](#)

No

Repair or replace the defective part.

7. CHECK HARNESS.

Check the harness between the hazard switch connector and the chassis ground.



Connector & terminal

(i137) No. 2 — Chassis ground:

Is the resistance less than 10 Ω?

Yes

Check the body integrated unit and replace it if defective.

- Inspection:  [Ref. to BODY CONTROL\(DIAGNOSTICS\)>Basic Diagnostic Procedure.](#)
- Replacement:  [Ref. to BODY CONTROL/COMMUNICATION SYSTEM>Body Integrated Unit.](#)

No

Repair or replace the defective part.

8. CHECK CURRENT DATA.

Using the Subaru Select Monitor, display the following items in the [Data monitor] of [Body Control].

 [Ref. to COMMON \(DIAGNOSTICS\)>Data Monitor.](#)

- [Left turn signal output]
- [Right turn signal output]



Does the display change as [OFF] ↔ [ON], when the hazard switch is turned from OFF to ON?

Yes

 [Go to 9.](#)

No

Check the body integrated unit and replace it if defective.

- Inspection:  [Ref. to BODY CONTROL\(DIAGNOSTICS\)>Basic Diagnostic Procedure.](#)
- Replacement:  [Ref. to BODY CONTROL/COMMUNICATION SYSTEM>Body Integrated Unit.](#)

9. CHECK POWER SUPPLY.

1. Turn the ignition switch to OFF.
2. Disconnect the connector of body integrated unit.
3. Measure the voltage between the body integrated unit connector and chassis ground.

Connector & terminal

(B72) No. 4 (+) — Chassis ground (-):

Is the voltage 9 — 16 V?

Yes

 [Go to 10.](#)

No

Check the power supply circuit.  [Ref. to BODY CONTROL\(DIAGNOSTICS\)>General Description>INSPECTION.](#)

10. CHECK HARNESS.

1. Disconnect the connectors of body integrated unit and each turn signal light.
2. Check the harness between body integrated unit and each turn signal light.

Connector & terminal

Front turn signal light RH (model without SRH)

(B71) No. 2 — (B121) No. 5:

Front turn signal light LH (model without SRH)

(B71) No. 8 — (B122) No. 5:

Front turn signal light RH (model with SRH)

(B71) No. 2 — (B121) No. 3:

Front turn signal light LH (model with SRH)

(B71) No. 8 — (B122) No. 3:

Side turn signal light RH

(i81) No. 5 — (Df55) No. 2:

Side turn signal light LH

(i81) No. 2 — (Df56) No. 2:

Rear turn signal light RH

(i81) No. 5 — (R131) No. 3:

Rear turn signal light LH

(i81) No. 2 — (L131) No. 3:

Is harness normal?

Yes

 [Go to 11.](#)

No

Repair or replace the defective part.

11. CHECK HARNESS.

Check the harness between each turn light connector and the chassis ground.

Connector & terminal

Front turn signal light RH (model without SRH)

(B121) No. 6 — Chassis ground:

Front turn signal light LH (model without SRH)

(B122) No. 6 — Chassis ground:

Front turn signal light RH (model with SRH)

(B121) No. 4 — Chassis ground:

Front turn signal light LH (model with SRH)

(B122) No. 4 — Chassis ground:

Side turn signal light RH

(Df55) No. 10 — Chassis ground:

Side turn signal light LH

(Df56) No. 10 — Chassis ground:

Rear turn signal light RH

(R131) No. 2 — Chassis ground:



Rear turn signal light LH

(L131) No. 2 — Chassis ground:

Is the resistance less than 10 Ω ?

Yes

Check the body integrated unit and replace it if defective.

- Inspection:  [Ref. to BODY CONTROL\(DIAGNOSTICS\)>Basic Diagnostic Procedure.](#)
- Replacement:  [Ref. to BODY CONTROL/COMMUNICATION SYSTEM>Body Integrated Unit.](#)

No

Repair or replace the defective part.

3. CHECK TURN SIGNAL LIGHT SYSTEM

Wiring diagram:

Turn signal and hazard light system  [Ref. to WIRING SYSTEM>Turn Signal Light and Hazard Light System>WIRING DIAGRAM.](#)

MB-17
M/B FUSE NO. 14
(B)

M: (B71) N: (B72) BODY INTEGRATED UNIT

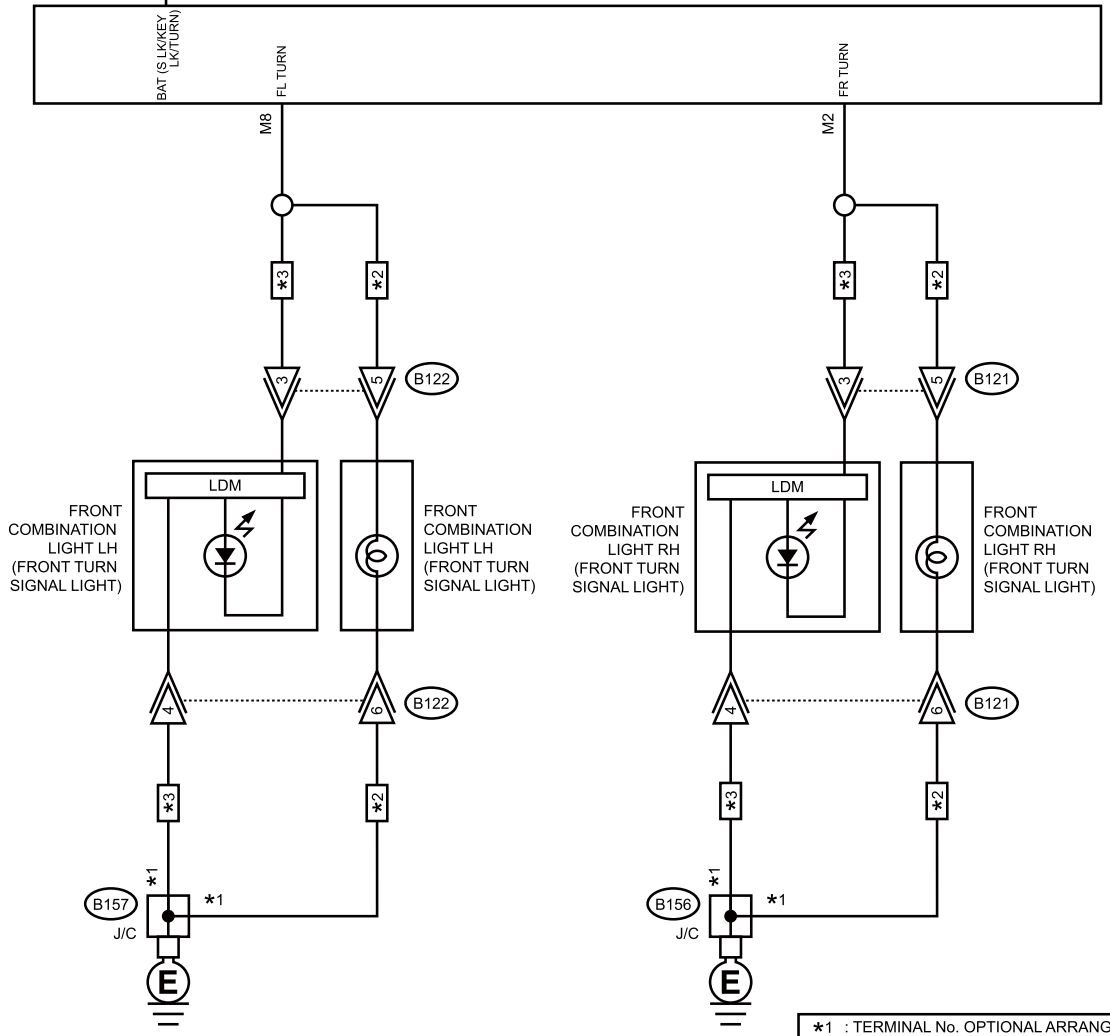

*1 : TERMINAL No. OPTIONAL ARRANGEMENT
*2 : WITHOUT SRH
*3 : WITH SRH

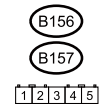
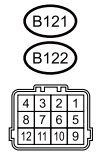
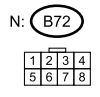
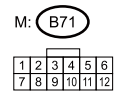

J: i81 BODY INTEGRATED UNIT

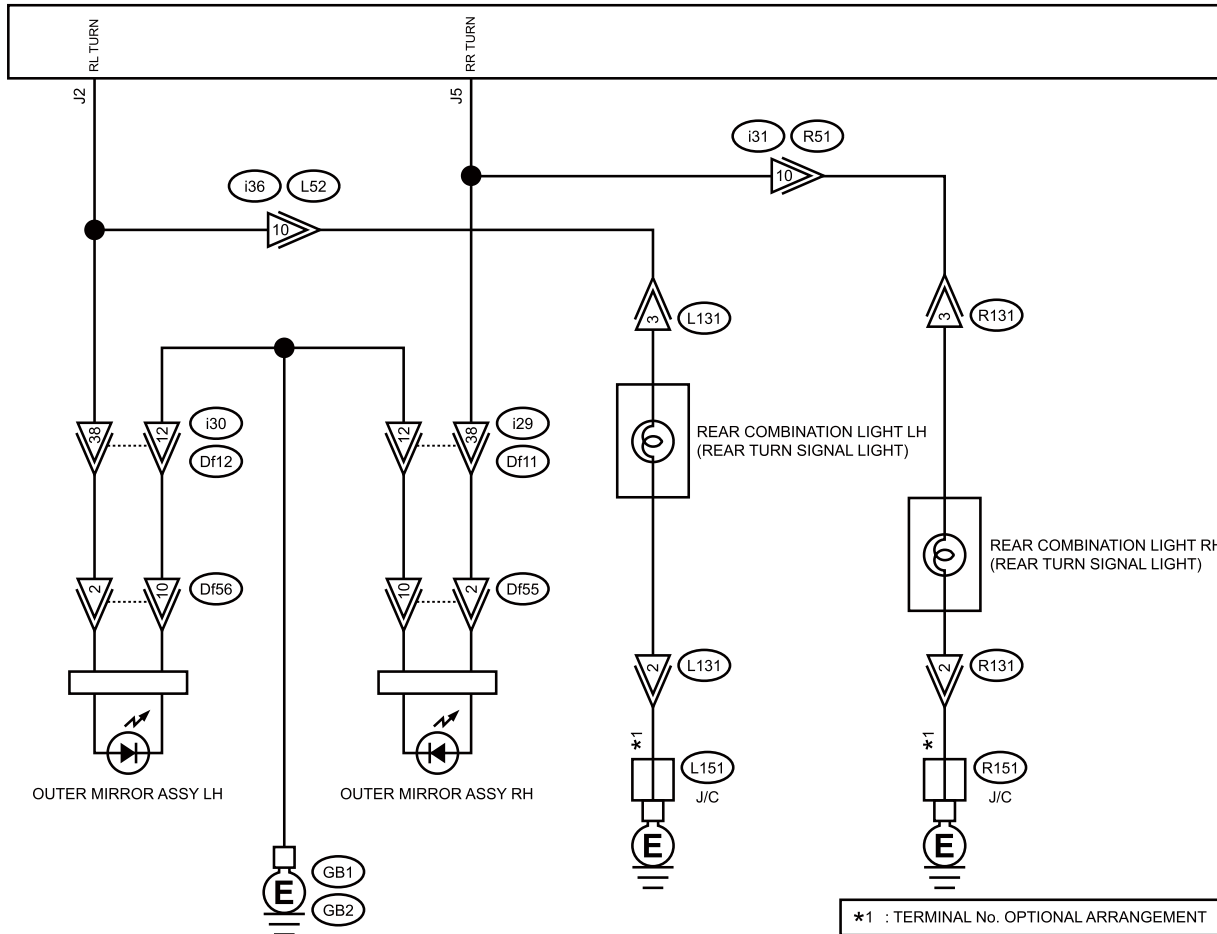

*1 : TERMINAL No. OPTIONAL ARRANGEMENT

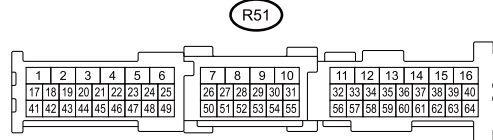
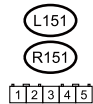
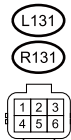
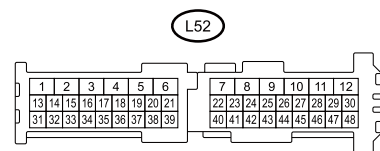
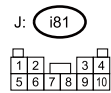
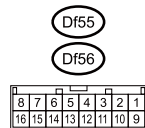
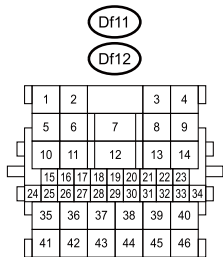

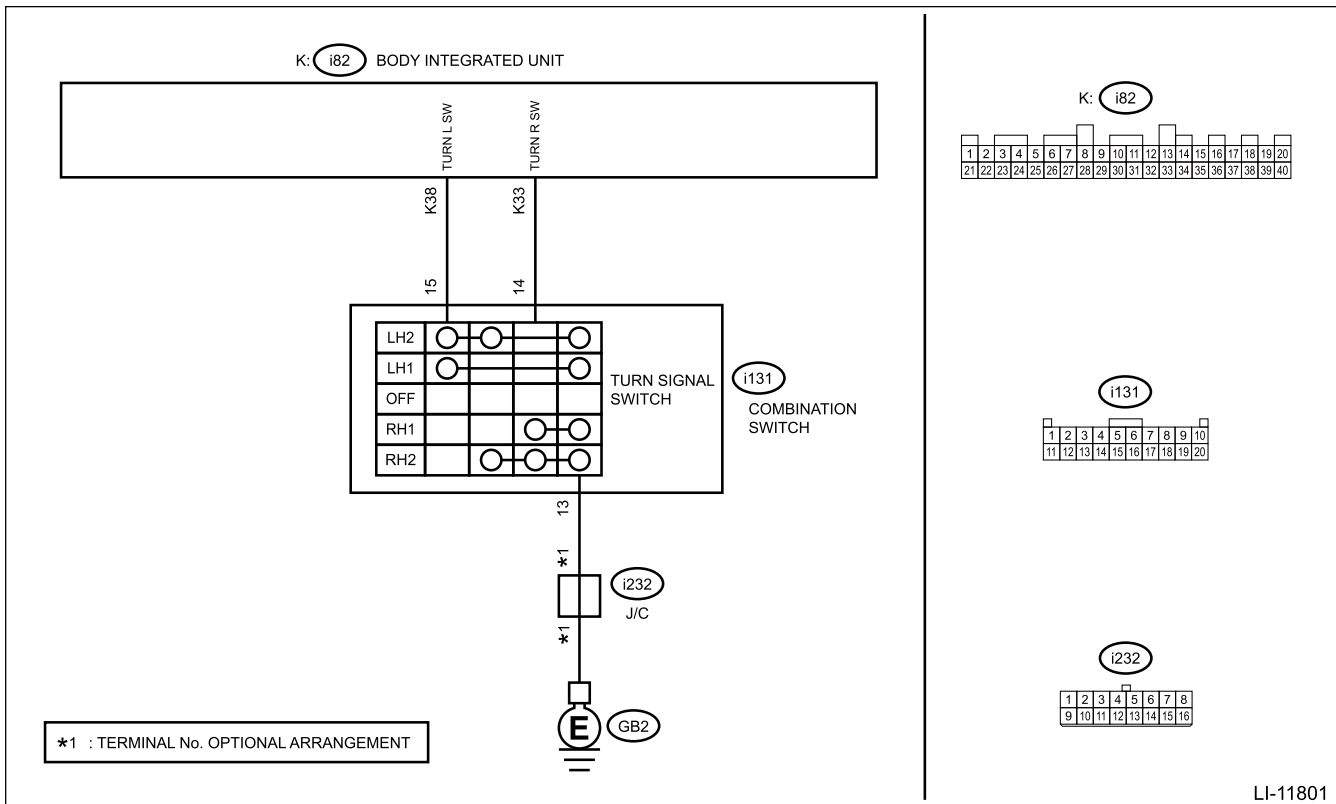

Note:
Operate the appropriate switch according to the inspection condition.

1. CHECK TURN SIGNAL LIGHT OPERATION.

- 1.** Turn the ignition switch to ON.
- 2.** Turn the turn signal light switch LH and RH to ON.

Does the turn signal light blink?

 Yes

The turn signal light system is normal.

 No

[Go to 2.](#)

2. CHECK BULB.

Check the hazard (turn signal) light bulb.

Is the bulb normal?

Yes

 [Go to 3.](#)

No

Replace the hazard (turn signal) light bulb.

3. CHECK POWER SUPPLY.

Using the Subaru Select Monitor, display the following items in the [Data monitor] of [Body Control].

 [Ref. to COMMON \(DIAGNOSTICS\)>Data Monitor.](#)

- [BATT voltage (control)]
- [BATT voltage (BACKUP)]
- [IGN voltage]



Is the voltage 9 – 16 V?

Yes

 [Go to 4.](#)

No

Check the body integrated unit and replace it if defective.

- Inspection:  [Ref. to BODY CONTROL\(DIAGNOSTICS\)>Basic Diagnostic Procedure.](#)
- Replacement:  [Ref. to BODY CONTROL/COMMUNICATION SYSTEM>Body Integrated Unit.](#)

4. CHECK DTC.

1. Turn the ignition switch to ON and wait for at least 10 seconds.

2. Read the DTC of [Body Control] using the Subaru Select Monitor.  [Ref. to COMMON \(DIAGNOSTICS\)>Diagnostic Trouble Code \(DTC\).](#)

Is DTC displayed?

Yes

Perform the diagnosis for the displayed DTCs.  [Ref. to BODY CONTROL\(DIAGNOSTICS\)>Diagnostic Trouble Code \(DTC\)>LIST.](#)

No

 [Go to 5.](#)

5. CHECK CURRENT DATA.

Using the Subaru Select Monitor, display the following items in the [Data monitor] of [Body Control].

 [Ref. to COMMON \(DIAGNOSTICS\)>Data Monitor.](#)

- [Left turn signal input]
- [Right turn signal input]
- [Turn Signal Deep Push Input]

Does the display change as [OFF] ↔ [ON], when the turn signal switch is turned from OFF to ON?

Yes

 [Go to 6.](#)

No

 [Go to 7.](#)

6. CHECK HARNESS.

1. Disconnect the connectors of body integrated unit and each turn signal light.
2. Check the harness between body integrated unit and each turn signal light.

Connector & terminal

Front turn signal light RH (model without SRH)

(B71) No. 2 — (B121) No. 5:

Front turn signal light LH (model without SRH)

(B71) No. 8 — (B122) No. 5:

Front turn signal light RH (model with SRH)

(B71) No. 2 — (B121) No. 3:

Front turn signal light LH (model with SRH)

(B71) No. 8 — (B122) No. 3:

Side turn signal light RH

(i81) No. 5 — (Df55) No. 2:

Side turn signal light LH

(i81) No. 2 — (Df56) No. 2:

Rear turn signal light RH

(i81) No. 5 — (R131) No. 3:

Rear turn signal light LH

(i81) No. 2 — (L131) No. 3:

Is harness normal?

Yes

 [Go to 7.](#)

No

Repair or replace the defective part.

7. CHECK TURN SIGNAL SWITCH.

Check the turn signal switch.  [Ref. to LIGHTING SYSTEM>Combination Switch \(Light\)>INSPECTION.](#)

Is the turn signal switch OK?

Yes

 [Go to 8.](#)

No

Replace the combination switch (light).  [Ref. to LIGHTING SYSTEM>Combination Switch \(Light\).](#)

8. CHECK HARNESS.

1. Turn the ignition switch to OFF.
2. Disconnect the connectors of body integrated unit and combination switch (light).
3. Check the harness between body integrated unit and combination switch (light).

Connector & terminal

(i82) No. 33 — (i131) No. 14:

(i82) No. 38 — (i131) No. 15:

Is harness normal?

Yes

 [Go to 9.](#)

No

Repair or replace the defective part.

9. CHECK HARNESS.

Check the harness between the combination switch (light) connector and the chassis ground.



Connector & terminal

(i131) No. 13 — Chassis ground:

Is the resistance less than 10 Ω ?

Yes

Check the body integrated unit and replace it if defective.

- Inspection:  [Ref. to BODY CONTROL\(DIAGNOSTICS\)>Basic Diagnostic Procedure.](#)
- Replacement:  [Ref. to BODY CONTROL/COMMUNICATION SYSTEM>Body Integrated Unit.](#)

No

Repair or replace the defective part.

4. CHECK LANE CHANGE SIGNAL FUNCTION

Note:

Operate the appropriate switch according to the inspection condition.

1. CHECK HAZARD LIGHT SYSTEM.

Check the hazard light system.  [Ref. to LIGHTING SYSTEM>Turn Signal Light and Hazard Light System>INSPECTION > CHECK HAZARD LIGHT OPERATION.](#)

Is the hazard light system normal?

Yes

 [Go to 2.](#)

No

Repair the hazard light system.

2. CHECK TURN SIGNAL LIGHT SYSTEM.

Check the turn signal light system.  [Ref. to LIGHTING SYSTEM>Turn Signal Light and Hazard Light System>INSPECTION > CHECK TURN SIGNAL LIGHT SYSTEM.](#)

Is the turn signal light system normal?

Yes

 [Go to 3.](#)

No

Repair the turn signal light system.



3. CHECK BODY INTEGRATED UNIT SETTING.

Using Subaru Select Monitor, display data of [Lane change signal setting] in [Customize] of [Body Control].  [Ref. to BODY CONTROL\(DIAGNOSTICS\)>Customize.](#)

Is the setting in the [Support]?

Yes

Check the body integrated unit and replace it if defective.

- Inspection:  [Ref. to BODY CONTROL\(DIAGNOSTICS\)>Basic Diagnostic Procedure.](#)
- Replacement:  [Ref. to BODY CONTROL/COMMUNICATION SYSTEM>Body Integrated Unit.](#)

No

Turn the setting to [Support].

5. CHECK TURN SIGNAL SWITCH

For the turn signal switch inspection, refer to "Combination Switch (Light)".  [Ref. to LIGHTING SYSTEM>Combination Switch \(Light\)>INSPECTION.](#)







6. CHECK HAZARD SWITCH

For the hazard switch inspection, refer to "Hazard Switch".  [Ref. to LIGHTING SYSTEM>Hazard Switch>INSPECTION.](#)

LIGHTING SYSTEM > Turn Signal Light and Hazard Light System

NOTE

For operation procedures of components of the turn signal and hazard light system, refer to the following sections.

- Headlight assembly:  [Ref. to LIGHTING SYSTEM>Headlight Assembly.](#)
- Front turn signal light bulb:  [Ref. to LIGHTING SYSTEM>Front Turn Signal Light Bulb.](#)
- Combination switch (light):  [Ref. to LIGHTING SYSTEM>Combination Switch \(Light\).](#)
- Side turn signal light assembly:  [Ref. to LIGHTING SYSTEM>Side Turn Signal Light Assembly.](#)
- Rear combination light assembly:  [Ref. to LIGHTING SYSTEM>Rear Combination Light Assembly.](#)
- Rear turn signal light bulb:  [Ref. to LIGHTING SYSTEM>Rear Combination Light Assembly>DISASSEMBLY.](#)
- Hazard switch:  [Ref. to LIGHTING SYSTEM>Hazard Switch.](#)

LIGHTING SYSTEM > Back-up Light System

WIRING DIAGRAM

For the wiring diagram, refer to "Back-up Light System" in the wiring diagram.  [Ref. to WIRING SYSTEM>Back-up Light System>WIRING DIAGRAM.](#)

LIGHTING SYSTEM > Back-up Light System

INSPECTION

1. CHECK BACK-UP LIGHT SWITCH (MT model)

For the back-up light switch inspection, refer to "Back-up Light Switch" in the "MANUAL TRANSMISSION & DIFFERENTIAL" section.  [Ref. to MANUAL TRANSMISSION AND DIFFERENTIAL\(TY75\)>Switches and Harness>INSPECTION > BACK-UP LIGHT SWITCH.](#)

2. CHECK INHIBITOR SWITCH (CVT MODEL)

For the inhibitor switch inspection, refer to "Inhibitor Switch" in "CONTINUOUSLY VARIABLE TRANSMISSION" section.  [Ref. to CONTINUOUSLY VARIABLE TRANSMISSION\(TR690\)>Inhibitor Switch>INSPECTION.](#)

LIGHTING SYSTEM > Back-up Light System

NOTE

For operation procedures of components of the back-up light system, refer to "Rear Combination Light Assembly".  [Ref. to LIGHTING SYSTEM>Rear Combination Light Assembly.](#)

LIGHTING SYSTEM > Stop Light System

WIRING DIAGRAM

For the wiring diagram, refer to "Stop Light System" in the wiring diagram.  [Ref. to WIRING SYSTEM>Stop Light System>WIRING DIAGRAM.](#)

LIGHTING SYSTEM > Stop Light System



INSPECTION

1. CHECK STOP LIGHT SWITCH

For the stop light switch inspection, refer to "Stop Light Switch" in the "BRAKE" section.  [Ref. to BRAKE>Stop Light Switch>INSPECTION.](#)

2. STOP LIGHT CHECK



For the stop light inspection, refer to the following sections.

- Rear combination light assembly:  [Ref. to LIGHTING SYSTEM>Rear Combination Light Assembly>INSPECTION.](#)
- High-mounted stop light:  [Ref. to LIGHTING SYSTEM>High-mounted Stop Light>INSPECTION.](#)

LIGHTING SYSTEM > Stop Light System

NOTE

For operation procedures of components of the stop light system, refer to the following sections.

- Rear combination light assembly:  [Ref. to LIGHTING SYSTEM>Rear Combination Light Assembly.](#)
- High-mounted stop light:  [Ref. to LIGHTING SYSTEM>High-mounted Stop Light.](#)
- Stop light switch:  [Ref. to BRAKE>Stop Light Switch.](#)

LIGHTING SYSTEM > Interior Light System

WIRING DIAGRAM

For the wiring diagram, refer to "Interior Light System" in the wiring diagram.  [Ref. to WIRING SYSTEM>Interior Light System>WIRING DIAGRAM.](#)

LIGHTING SYSTEM > Interior Light System

INSPECTION

1. TROUBLE SYMPTOM

Spot map light, room light, trunk room light, or vanity mirror light does not illuminate.

Wiring diagram:

Interior light system  [Ref. to WIRING SYSTEM>Interior Light System>WIRING DIAGRAM.](#)

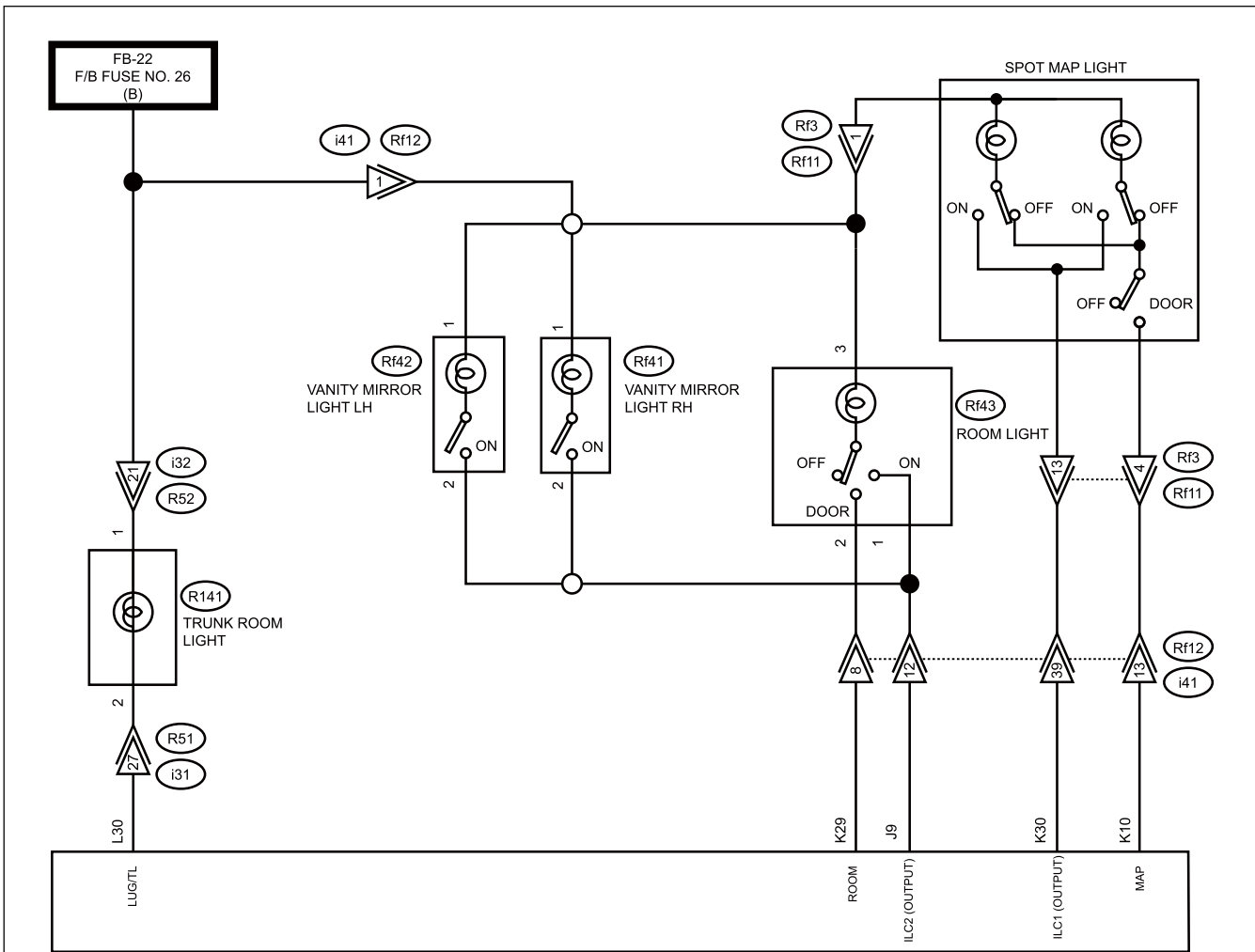

J: i81 K: i82 L: i83 BODY INTEGRATED UNIT

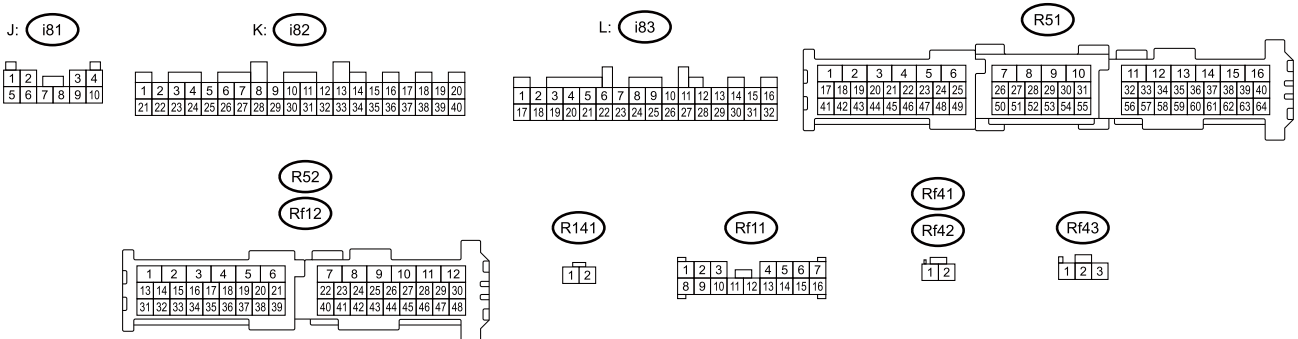

LI-11884

Note:
 Operate the appropriate switch according to the inspection condition.

1. CHECK INTERIOR LIGHT ILLUMINATION.

Note:

Since there is no ON position for the trunk room light, open and close the trunk lid to check the illumination status of the light.

1. Open and close any door.
2. Turn the interior light switch to ON. When checking the vanity mirror light, open the vanity mirror cover.
3. Check that the interior light operates properly.

Does the interior light illuminate?

 Yes [Go to 7.](#) No [Go to 2.](#)

2. CHECK THE LIGHTS.

1. Disconnect the connector of the light which did not illuminate.
2. Check between the connector terminals of the light (ON position).

Connector & terminal

Spot map light

(Rf3) No. 1 — (Rf3) No. 13:

Room light

(Rf43) No. 3 — (Rf43) No. 1:

Vanity mirror light LH

(Rf42) No. 1 — (Rf42) No. 2:

Vanity mirror light RH

(Rf41) No. 1 — (Rf41) No. 2:

3. Check between the connector terminals of light (door position).

Connector & terminal

Spot map light

(Rf3) No. 1 — (Rf3) No. 4:

Room light

(Rf43) No. 3 — (Rf43) No. 2:

4. Check between the connector terminals of trunk room light.

Connector & terminal

(R141) No. 1 — (R141) No. 2:

- Is the resistance less than 1 Ω ? (Except for spot map light)
- Is the resistance approximately 18 Ω ? (Spot map light)

Yes

Spot map light, room light and vanity mirror light:

 [Go to 3.](#)

Trunk room light:

 [Go to 7.](#)

No

Repair or replace the light.

3. CHECK FUSE.

Check the F/B fuse No. 26.  [Ref. to LIGHTING SYSTEM>Relay and Fuse>INSPECTION.](#)

Is the fuse normal?

Yes

 [Go to 4.](#)

No

Replace the fuse.

4. CHECK CONNECTOR.

Check the connecting condition of connector.

Is the connector firmly installed?

Yes

 [Go to 5.](#)

No

Repair or replace the defective part.

5. CHECK HARNESS.

1. Disconnect the connector of the light which did not illuminate.
2. Check the harnesses between light (ON position) connector and body integrated unit.

Connector & terminal

Spot map light

(Rf11) No. 13 — (i82) No. 30:

Room light

(Rf43) No. 1 — (i81) No. 9:

Vanity mirror light LH

(Rf42) No. 2 — (i81) No. 9:

Vanity mirror light RH

(Rf41) No. 2 — (i81) No. 9:

Is harness normal?

Yes

 [Go to 6.](#)

No

Repair or replace the defective part.

6. CHECK HARNESS.

Check the harness between the F/B fuse No. 26 (downstream side) and the light.

Connector & terminal

Spot map light

F/B fuse No. 26 (downstream side) — (Rf11) No. 1:

Room light

F/B fuse No. 26 (downstream side) — (Rf43) No. 3:

Vanity mirror light LH

F/B fuse No. 26 (downstream side) — (Rf42) No. 1:

Vanity mirror light RH

F/B fuse No. 26 (downstream side) — (Rf41) No. 1:

Is harness normal?

Yes

Replace the body integrated unit.  [Ref. to BODY CONTROL/COMMUNICATION SYSTEM>Body Integrated Unit.](#)

No

Repair or replace the defective part.

7. CHECK OPERATION.

1. Turn the interior light switch to the DOOR position.

Note:

The trunk room light is not provided with a switch.

2. Open a door or trunk lid.

- Check the spot map light or interior light: Open any door.
- Check the trunk room light: Open the trunk lid.

Does the interior light illuminate?

Yes

The interior light system is normal.

No

 [Go to 8.](#)

8. CHECK CURRENT DATA.

Using the Subaru Select Monitor, display the following items in the [Data monitor] of [Body Control].

 [Ref. to COMMON \(DIAGNOSTICS\)>Data Monitor.](#)

- [Room lamp output]
- [Map lamp output]
- [Luggage/Trunk lamp output]

Does the display switch between [OFF] ↔ [ON] when a door or trunk lid is opened/closed?

Yes

 [Go to 10.](#)

No

 [Go to 9.](#)

9. CHECK CURRENT DATA.

Using the Subaru Select Monitor, display the following items in the [Data monitor] of [Body Control].

 [Ref. to COMMON \(DIAGNOSTICS\)>Data Monitor.](#)

- [Driver's door SW input]
- [P-door SW input]
- [Rear right door SW input]
- [Rear left door SW input]
- [R Gate SW input]

Does the display switch between [OFF] ↔ [ON] when a door or trunk lid is opened/closed?

Yes

Replace the body integrated unit.  [Ref. to BODY CONTROL/COMMUNICATION SYSTEM>Body Integrated Unit.](#)

No

Check the door switch and harness.  [Ref. to SECURITY AND LOCKS>Door Lock Control System>INSPECTION > CHECK DOOR LOCK SWITCH.](#)

10. CHECK HARNESS.

Check the harnesses between light connector and body integrated unit.

Connector & terminal

Spot map light

(Rf11) No. 4 — (i82) No. 10:

Room light

(Rf43) No. 2 — (i82) No. 29:

Trunk room light

(R141) No. 2 — (i83) No. 30:

Is harness normal?

Yes

Spot map light and room light:

Replace the body integrated unit.  [Ref. to BODY CONTROL/COMMUNICATION SYSTEM>Body Integrated Unit.](#)

Trunk room light:

 [Go to 11.](#)

No

Repair or replace the defective part.

11. CHECK HARNESS.

Check the harness between the F/B fuse No. 26 (downstream side) and the trunk room light.

Connector & terminal

Trunk room light

F/B fuse No. 26 (downstream side) — (R141) No. 1:

Is harness normal?

Yes

Replace the body integrated unit.  [Ref. to BODY CONTROL/COMMUNICATION SYSTEM>Body Integrated Unit.](#)

No

Repair or replace the defective part.

2. CHECK DOOR SWITCH

For the door switch inspection, refer to "Door Switch".  [Ref. to LIGHTING SYSTEM>Door Switch>INSPECTION.](#)







3. CHECK TRUNK LID LATCH SWITCH

For the inspection of the trunk lid latch switch, refer to "Trunk Lid Latch and Actuator Assembly" in the "SECURITY AND LOCKS" section.  [Ref. to SECURITY AND LOCKS>Trunk Lid Latch and Actuator Assembly>INSPECTION.](#)

LIGHTING SYSTEM > Interior Light System

NOTE

For operation procedures of components of the interior light system, refer to the following sections.

- Spot map light:  [Ref. to LIGHTING SYSTEM>Spot Map Light.](#)
- Room light:  [Ref. to LIGHTING SYSTEM>Room Light.](#)
- Trunk room light:  [Ref. to LIGHTING SYSTEM>Trunk Room Light.](#)
- LED illumination light:  [Ref. to LIGHTING SYSTEM>LED Illumination Light.](#)
- Vanity mirror light:  [Ref. to LIGHTING SYSTEM>Vanity Mirror Light.](#)
- Door switch:  [Ref. to LIGHTING SYSTEM>Door Switch.](#)
- Trunk lid:  [Ref. to EXTERIOR BODY PANELS>Trunk Lid.](#)

LIGHTING SYSTEM > Auto Headlight Beam Leveler System

WIRING DIAGRAM

For the wiring diagram, refer to "Headlight Beam Leveler System" in the wiring diagram.  [Ref. to WIRING SYSTEM>Headlight Beam Leveler System>WIRING DIAGRAM.](#)

LIGHTING SYSTEM > Auto Headlight Beam Leveler System

INSPECTION

1. BASIC INSPECTION

For basic inspection, refer to "Basic Diagnostic Procedure" in "HEADLIGHT / FOGLIGHT (DIAGNOSTICS)".  [Ref. to HEADLIGHT / FOGLIGHT\(DIAGNOSTICS\)>Basic Diagnostic Procedure.](#)

2. SYSTEM BLOCK DIAGRAM

For system block diagram, refer to "System Block Diagram" in "HEADLIGHT / FOGLIGHT (DIAGNOSTICS)".  [Ref. to HEADLIGHT / FOGLIGHT\(DIAGNOSTICS\)>General Description>SYSTEM BLOCK DIAGRAM.](#)

3. MODULE I/O SIGNAL

For the specification (electrical component), refer to "Control Module I/O Signal" in "HEADLIGHT / FOGLIGHT (DIAGNOSTICS)".  [Ref. to HEADLIGHT / FOGLIGHT\(DIAGNOSTICS\)>Control Module I/O Signal>ELECTRICAL SPECIFICATION.](#)

LIGHTING SYSTEM > Auto Headlight Beam Leveler System

PROCEDURE

Caution:

If any of the following conditions is met, the headlight beam may deviate. Perform reinitialization or fuse resetting before adjusting the beam level using the aiming screw.

- Difference has occurred to the vehicle posture between when the ignition switch is turned to OFF and when the ignition switch is turned to ON.
- Difference has occurred to the vehicle posture when the ignition switch is ON and the vehicle speed is 0 km/h (0 MPH).



Note:

If the indicator does not flash 3 times or the headlight beam does not operate even if initialization or reinitialization is performed, it can be assumed that there is an open circuit or faulty wiring in the harness of the auto headlight beam leveler CM or the headlight assembly. Perform inspection and repairs according to the inspection results.  Ref. to [LIGHTING SYSTEM>Auto Headlight Beam Leveler System>INSPECTION.](#)

Before performing initialization or reinitialization, check the following:

- The vehicle is parked on a level surface.
- The inflation pressure of tires is correct.
- The vehicle does not have load.
- Vehicle's fuel tank is fully filled.

Perform each work in the following cases.



Operation	Condition	Reference
Initialization	When the auto headlight beam leveler CM was replaced with a new module.	 Ref. to LIGHTING SYSTEM>Auto Headlight Beam Leveler System>PROCEDURE > INITIALIZATION.
Reinitialization	<ul style="list-style-type: none">• When the auto headlight beam leveler CM has been removed and installed.• When rectifying beam level deviation and before adjusting the beam level using the aiming screw.	 Ref. to LIGHTING SYSTEM>Auto Headlight Beam Leveler System>PROCEDURE > REINITIALIZATION.
Fuse reset	When rectifying beam level deviation and before adjusting the beam level using the aiming screw.	 Ref. to LIGHTING SYSTEM>Auto Headlight Beam Leveler System>PROCEDURE > FUSE RESET.

1. INITIALIZATION

1. Install the delivery mode fuse.  Ref. to [PRE-DELIVERY INSPECTION>PRE-DELIVERY INSPECTION \(PDI\) PROCEDURE > DELIVERY MODE.](#)
2. Turn the ignition switch to ON and check that the indicator in the meter is flashing twice repeatedly.
3. Turn the ignition switch to OFF.
4. Bounce the vehicle several times to normalize the suspension.
5. Make certain that someone is seated in the driver's seat.

6. Turn the ignition switch to ON, and within 1.5 to 20 seconds, turn the headlight switch OFF → ON three times.
7. Make sure that the indicator in the meter flashes three times and then turns OFF, indicating that initialization has been successfully completed. (At this time, the headlight beam drops once, and then returns to the original position.)
8. Remove the delivery mode fuse.
9. Perform beam adjustment for the headlight.  [Ref. to LIGHTING SYSTEM>Headlight Assembly>ADJUSTMENT.](#)

2. REINITIALIZATION

1. Install the delivery mode fuse.  [Ref. to PRE-DELIVERY INSPECTION>PRE-DELIVERY INSPECTION \(PDI\) PROCEDURE > DELIVERY MODE.](#)
2. Bounce the vehicle several times to normalize the suspension.
3. Make certain that someone is seated in the driver's seat.
4. Turn the ignition switch to ON, and within 1.5 to 10 seconds, turn the headlight switch OFF → ON five or more successive times.
5. Check that the headlight beam drops once, then returns to normal.
6. After confirming step 5., turn the ignition switch to OFF (ACC OFF) within 30 seconds.
7. Turn the ignition switch to ON again, and within 1.5 to 10 seconds, turn the headlight switch OFF → ON five or more successive times.
8. Make sure that the indicator in the meter flashes three times and then turns OFF, indicating that reinitialization has been successfully completed. (At this time, the headlight beam drops once, and then returns to the original position.)
9. Remove the delivery mode fuse.
10. Perform beam adjustment for the headlight.  [Ref. to LIGHTING SYSTEM>Headlight Assembly>ADJUSTMENT.](#)

3. FUSE RESET

1. Park the vehicle on a level ground.
2. Turn the ignition switch to OFF and remove the delivery mode fuse from the position (1).
3. Install the delivery mode fuse in the position (2) and then turn the ignition switch to ON.
4. Turn the ignition switch to OFF, install the delivery mode fuse in the position (1), and start the engine.

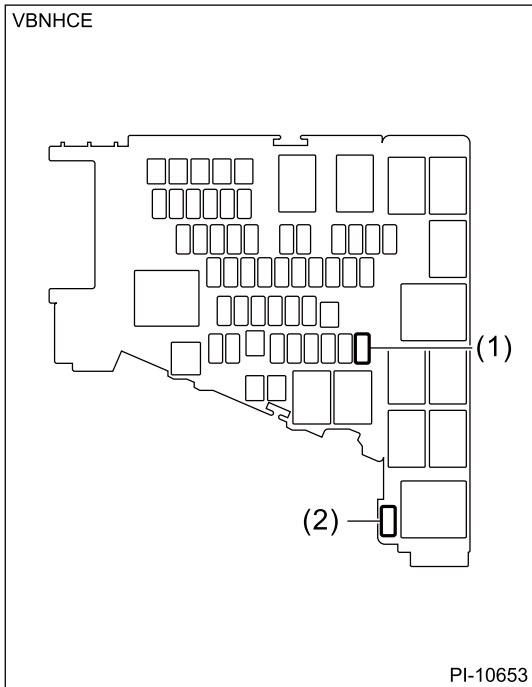



(1) Delivery mode fuse inlet

(2) Delivery mode fuse holder

LIGHTING SYSTEM > Auto Headlight Beam Leveler System

NOTE

For operation procedures of components of the auto headlight beam leveler system, refer to the sections below.







- Headlight assembly:  [Ref. to LIGHTING SYSTEM>Headlight Assembly.](#)
- Auto headlight beam leveler CM:  [Ref. to LIGHTING SYSTEM>Auto Headlight Beam Leveler Control Module.](#)

LIGHTING SYSTEM > Combination Switch (Light)

REMOVAL

Caution:

Before handling the airbag system components, refer to "CAUTION" of "General Description" in "AIRBAG SYSTEM".  [Ref. to AIRBAG SYSTEM>General Description>CAUTION.](#)

1. Set the steering wheel to the straight-ahead position.
2. Disconnect the ground terminal from the battery sensor, and wait for at least 60 seconds before starting work.  [Ref. to REPAIR CONTENTS>NOTE > BATTERY.](#)
3. Remove the driver's airbag module.  [Ref. to AIRBAG SYSTEM>Driver's Airbag Module>REMOVAL.](#)
4. Remove the steering wheel assembly.  [Ref. to POWER ASSISTED SYSTEM \(POWER STEERING\)>Steering Wheel>REMOVAL.](#)
5. Remove the column cover assembly.  [Ref. to POWER ASSISTED SYSTEM \(POWER STEERING\)>Steering Column>REMOVAL.](#)
6. Remove the steering roll connector.  [Ref. to AIRBAG SYSTEM>Roll Connector>REMOVAL.](#)
7. Remove the switch assembly combination wiper.  [Ref. to WIPER AND WASHER SYSTEMS>Combination Switch \(Wiper\)>REMOVAL.](#)
8. Remove the switch assembly combination turn dimmer.
 - (1) Disconnect the connector.
 - (2) Using pliers, loosen the clamp.
 - (3) With the clamp loosened, release the claw using a flat tip screwdriver wrapped with protective tape, and remove the switch assembly combination turn dimmer.

Caution:

Do not pry off forcibly. Otherwise, the claws may be damaged.

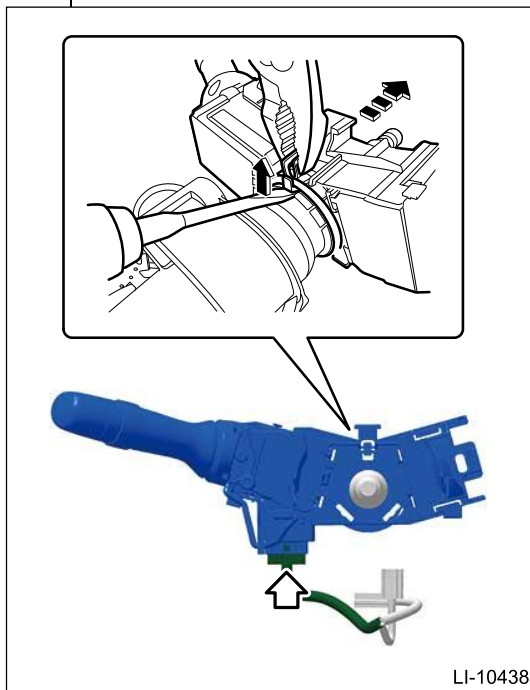

LIGHTING SYSTEM > Combination Switch (Light)

INSTALLATION









Caution:

- Before handling the airbag system components, refer to “CAUTION” of “General Description” in “AIRBAG SYSTEM”.  [Ref. to AIRBAG SYSTEM>General Description>CAUTION.](#)
- Do not allow harness and connectors to interfere or get tangled up with other parts.
- If the steering wheel has been removed, make sure that the steering roll connector is not turned from the original position.

1. Install the switch assembly combination turn dimmer.
 - (1) Using pliers, loosen the clamp.
 - (2) With the clamp loosened, insert so that the cutout of the column assembly steering and the claw of the switch assembly combination turn dimmer are aligned, and then engage them.
 - (3) Install the clamp, and connect the connector.

Note:

When replacing with a new part, engage the claw first, and then pull out the securing pin of the clamp.

2. Install the switch assembly combination wiper.  [Ref. to WIPER AND WASHER SYSTEMS>Combination Switch \(Wiper\)>INSTALLATION.](#)
3. Align the center position of the steering roll connector.  [Ref. to AIRBAG SYSTEM>Roll Connector>ADJUSTMENT.](#)
4. Install the steering roll connector.  [Ref. to AIRBAG SYSTEM>Roll Connector>INSTALLATION.](#)
5. Install the column cover assembly.  [Ref. to POWER ASSISTED SYSTEM \(POWER STEERING\)>Steering Column>INSTALLATION.](#)
6. Install the steering wheel assembly.  [Ref. to POWER ASSISTED SYSTEM \(POWER STEERING\)>Steering Wheel>INSTALLATION.](#)
7. Install the driver’s airbag module.  [Ref. to AIRBAG SYSTEM>Driver’s Airbag Module>INSTALLATION.](#)
8. Connect the ground terminal to battery sensor.  [Ref. to REPAIR CONTENTS>NOTE > BATTERY.](#)
9. Perform “VDC sensor midpoint setting mode”.  [Ref. to VEHICLE DYNAMICS CONTROL \(VDC\)>VDC Control Module and Hydraulic Control Unit \(VDCCM&H/U\)>ADJUSTMENT > VDC SENSOR MIDPOINT SETTING MODE.](#)

LIGHTING SYSTEM > Combination Switch (Light)**INSPECTION**

Measure the resistance between connector terminals. If it is not within the standard value, replace the switch assembly combination turn dimmer.

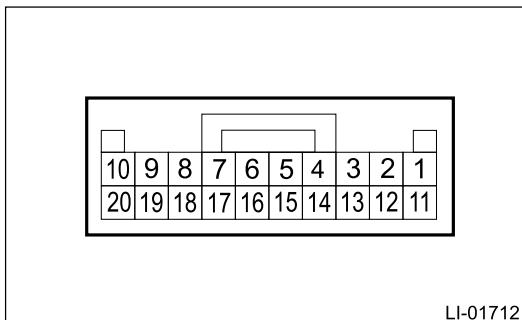
**1. LIGHTING SWITCH**

- Other than for C0

Terminal No.	Inspection conditions	Standard
18 – 13 19 – 13 20 – 13	Switch OFF	1 MΩ or more
19 – 13	Switch AUTO	Less than 1 Ω
18 – 13	Switch 1 (TAIL)	Less than 1 Ω
18 – 13 20 – 13	Switch 2 (HEAD)	Less than 1 Ω

- For C0

Terminal No.	Inspection conditions	Standard
18 – 13	Switch OFF	Less than 1 Ω
18 – 13 19 – 13 20 – 13	Switch AUTO	1 MΩ or more
19 – 13	Switch 1 (TAIL)	Less than 1 Ω
19 – 13 20 – 13	Switch 2 (HEAD)	Less than 1 Ω

2. DIMMER & PASSING SWITCH

Terminal No.	Inspection conditions	Standard
17 – 13	Switch PASS	Less than 1 Ω
16 – 13	Switch UP	Less than 1 Ω

3. TURN SIGNAL SWITCH

Terminal No.	Inspection conditions	Standard
14 – 13	Switch TURN RH	Less than 1 Ω
15 – 13	Switch TURN LH	Less than 1 Ω

4. FRONT FOG LIGHT SWITCH

Terminal No.	Inspection conditions	Standard
4 – 3	Switch OFF	1 MΩ or more
	Switch ON	Less than 1 Ω

LIGHTING SYSTEM > Light Control Sensor

REMOVAL

1. Disconnect the ground terminal from battery sensor.  [Ref. to REPAIR CONTENTS>NOTE > BATTERY.](#)
2. Remove the grille speaker side.  [Ref. to ENTERTAINMENT & MONITORING>Front Speaker>REMOVAL > TWEETER.](#)
3. Remove the grille front defroster.
(1) Release the clips.

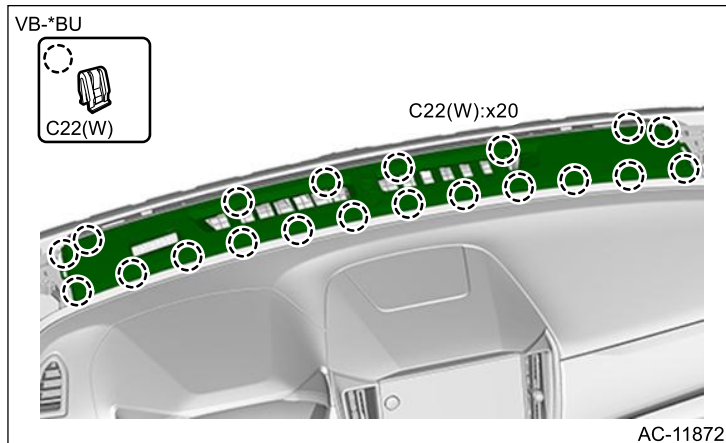

- (2) Disconnect the connector and remove the grille front defroster.
4. Disconnect the claws and then remove the auto light sensor.

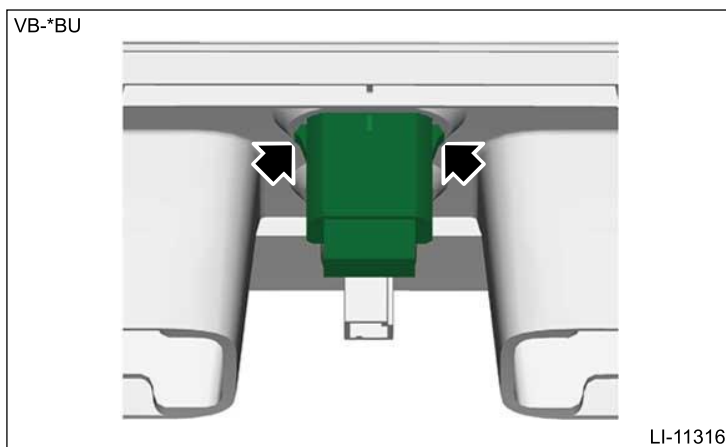

LIGHTING SYSTEM > Light Control Sensor

INSTALLATION

1. Install the auto light sensor.
2. Connect the connector, and install the grille front defroster.
3. Install the grille speaker side.  [Ref. to ENTERTAINMENT & MONITORING>Front Speaker>INSTALLATION > TWEETER.](#)
4. Connect the ground terminal to battery sensor.  [Ref. to REPAIR CONTENTS>NOTE > BATTERY.](#)

LIGHTING SYSTEM > Light Control Sensor

INSPECTION

1. Connect the connector.
2. Turn the ignition switch to ON, and set the lighting switch to the AUTO position.
3. Measure the voltage between connector terminals.

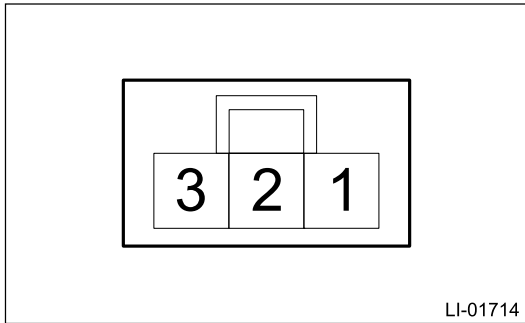

Terminal No.	Inspection conditions	Standard
2 (+) – 1 (-)	Measure the voltage when the area around the auto light sensor, which was dark, becomes bright.	Dark condition: Approx. 0.6 V or less
		Bright condition: Approx. 3 V or more



4. Replace the auto light sensor if the inspection result is not within the standard value.

LIGHTING SYSTEM > Headlight Assembly

REMOVAL

Caution:

- Before handling the airbag system components, refer to "CAUTION" of "General Description" in "AIRBAG SYSTEM".  [Ref. to AIRBAG SYSTEM>General Description>CAUTION.](#)
- Do not perform work with wet hands, because there is a possibility of electrical shock.

1. Disconnect the ground terminal from battery sensor.  [Ref. to REPAIR CONTENTS>NOTE > BATTERY.](#)
2. Remove the air intake duct.  [Ref. to INTAKE \(INDUCTION\)\(H4DOTC\)>Air Intake Duct>REMOVAL.](#)
3. Remove the clips, and remove the cover UPR front.

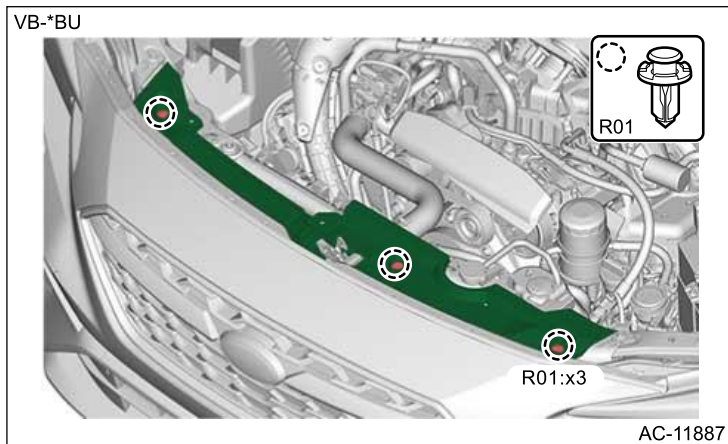

4. Remove the bumper face front.  [Ref. to EXTERIOR/INTERIOR TRIM>Front Bumper>REMOVAL.](#)
5. Remove the bolts and clips, and remove the energy absorber plate UPR.

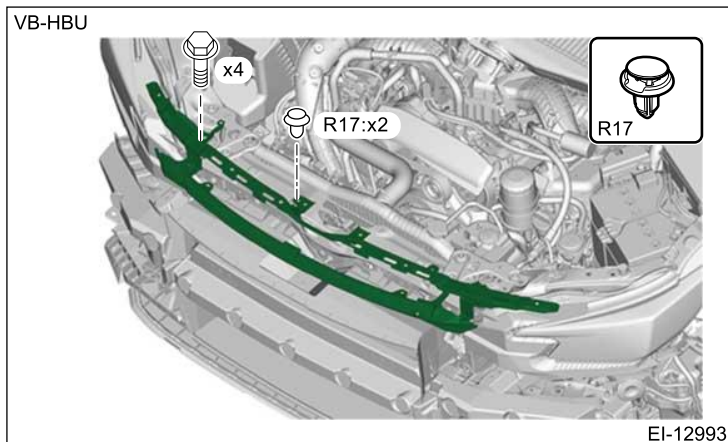

6. Remove the clip, and remove the cover fender UPR.

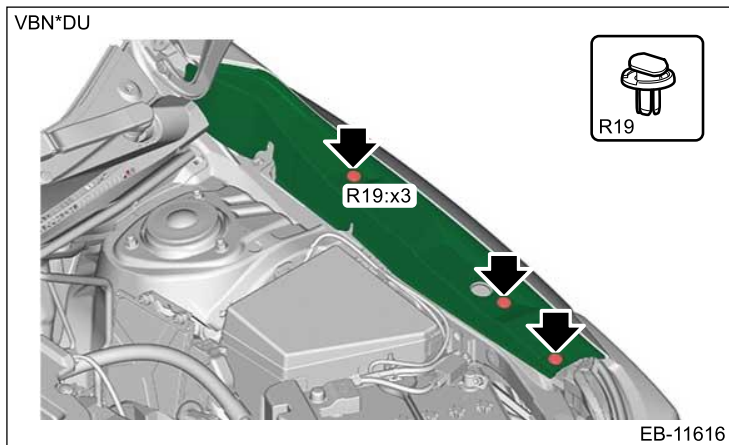

7. Remove the access buzzer. (When the light assembly head on the left side is removed)  [Ref. to SECURITY AND LOCKS>Access Buzzer>REMOVAL.](#)
8. Remove the bolts and clips, and remove the bracket corner front.

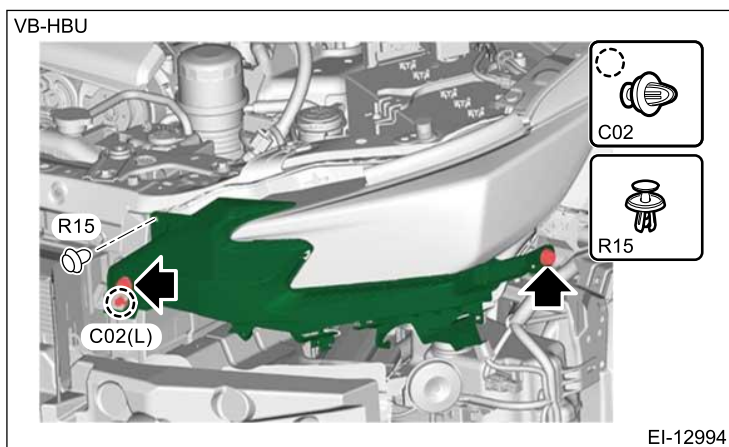

9. Remove the clip of the washer tank hose. (When the light assembly head on the left side is removed)

Note:

In order to make it easier to access the light assembly head connector, place the washer tank hose aside so that it does not interfere with work.

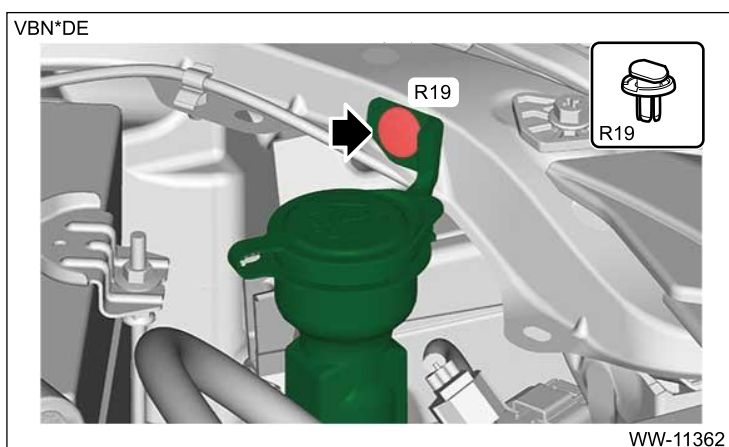

10. Remove the light assembly head.

Caution:

Be careful not to damage the headlight assembly and the fender COMPL front.

- (1) Disconnect the connector.

(2) Remove the bolts and clips, and remove the light assembly head.

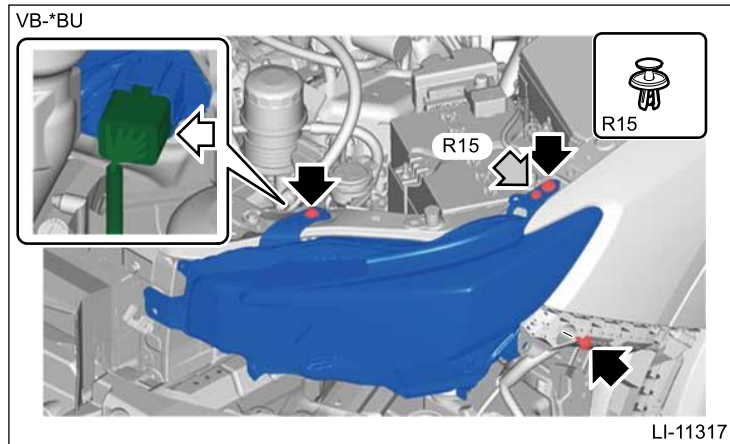

LIGHTING SYSTEM > Headlight Assembly

INSTALLATION

Caution:

- Before handling the airbag system components, refer to "CAUTION" of "General Description" in "AIRBAG SYSTEM". [Ref. to AIRBAG SYSTEM>General Description>CAUTION.](#)
- Before installing the headlight assembly, check the condition of seal rubber and cap. If any damage is found, replace the seal rubber and cap with new parts. [Ref. to LIGHTING SYSTEM>Headlight Assembly>REPLACEMENT.](#)

1. Install the light assembly head, and then connect the connector.

Tightening torque:

7.5 N·m (0.8 kgf-m, 5.5 ft-lb)

2. Install the bracket corner front.

Tightening torque:

7.5 N·m (0.8 kgf-m, 5.5 ft-lb)

3. Install the washer tank hose. (When the light assembly head on the left side is removed)

4. Install the access buzzer. (When the light assembly head on the left side is removed) [Ref. to SECURITY AND LOCKS>Access Buzzer>INSTALLATION.](#)

5. Install the cover fender UPR.

6. Install the energy absorber plate UPR.

Tightening torque:

7.5 N·m (0.8 kgf-m, 5.5 ft-lb)

7. Install the bumper face front. [Ref. to EXTERIOR/INTERIOR TRIM>Front Bumper>INSTALLATION.](#)

8. Install the cover UPR front.

9. Install the air intake duct. [Ref. to INTAKE \(INDUCTION\)\(H4DOTC\)>Air Intake Duct>INSTALLATION.](#)

10. Check and adjust the clearance between the hood COMPL front and the light assembly head. [Ref. to EXTERIOR BODY PANELS>Front Hood>ADJUSTMENT.](#)

11. Connect the ground terminal to battery sensor. [Ref. to REPAIR CONTENTS>NOTE > BATTERY.](#)

12. Adjust the headlight beam and fog light beam.

- Adjust the headlight beam. [Ref. to LIGHTING SYSTEM>Headlight Assembly>ADJUSTMENT > HEADLIGHT BEAM ADJUSTMENT.](#)

- Adjust the fog light beam. [Ref. to LIGHTING SYSTEM>Front Fog Light Assembly>ADJUSTMENT > FOG LIGHT AIMING.](#)

REPLACEMENT

1. SEAL RUBBER

1. Remove the hood seal rubber while pulling the rubber. Be careful not to tear the rubber.

Caution:

- Be careful not to damage the surface of headlight assembly during operation.
- Do not reuse hood seal rubber.

2. Remove the double-sided tape remaining on the headlight assembly side, then clean the adhesive surface.

Caution:

Do not use any solvents that may damage the headlight assembly lenses.

Note:

If even a slight amount of double-sided tape remains on the adhesive surface, it may lead to improper adhesion.

3. Degrease the mounting surface of the hood seal rubber.

4. Attach the hood seal rubber.

Note:

Attach the hood seal rubber so that the double-sided tape does not detach from the headlight assembly.

- (1) Make the hood seal rubber come into contact with the ribs.

- (2) When attaching the hood seal rubber, make sure that the ribs fit in the cutout portions.

Note:

- Attach it in the arrow direction.
- Make sure that the hood seal rubber does not ride on the corner (a) of the attaching surface.

- (3) Attach the hood seal rubber so that it comes in between the two ribs.

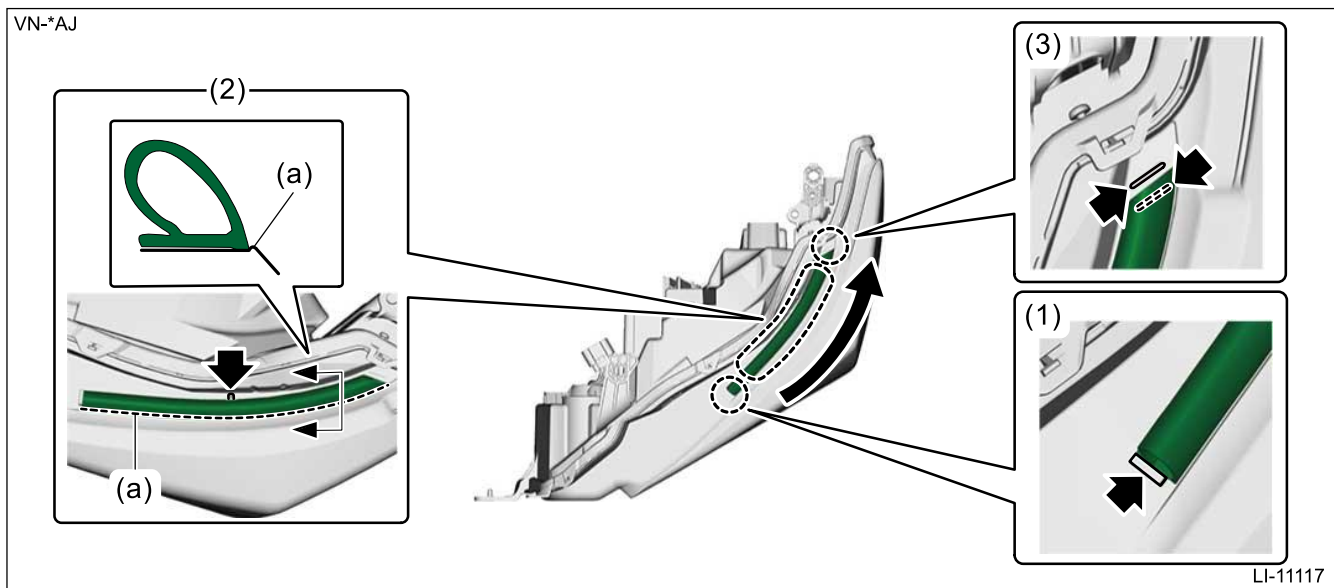

1. HEADLIGHT BEAM ADJUSTMENT

Caution:

- Turn off the light before adjusting the headlight beam level. If it is necessary to inspect the beam level, do not keep the light on for two minutes or more.
- When blocking the light emitted from the headlight, use a light shield or equivalent. Do not apply the tape on the lens or place the cloth over it. It may raise the temperature in the light and cause deformation/bubble formations of the plastic lens.
- If any of the following conditions is met, the headlight beam may deviate. Perform reinitialization or fuse resetting before adjusting the beam level using the aiming screw. 
Ref. to LIGHTING SYSTEM>Auto Headlight Beam Leveler System>PROCEDURE.
 - Difference has occurred to the vehicle posture between when the ignition switch is turned to OFF and when the ignition switch is turned to ON.
 - Difference has occurred to the vehicle posture when the ignition switch is ON and the vehicle speed is 0 km/h (0 MPH).

1. Before checking the headlight beam level, be sure of the following:
 - Check the area around the headlight for any scratches, damage or other type of deformation.
 - The vehicle is parked on a level surface.
 - The inflation pressure of tires is correct.
 - The vehicle does not have load.
 - Vehicle's fuel tank is fully filled.
2. Bounce the vehicle several times to normalize the suspension.
3. Make certain that someone is seated in the driver's seat.
4. Measure the height of the low beam lens center mark.

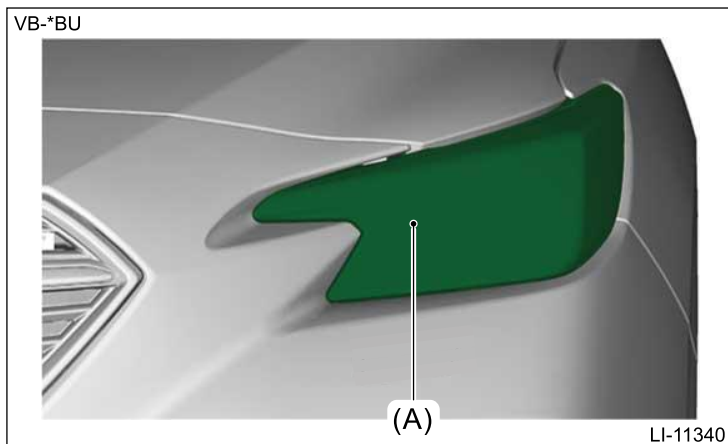

(A) Lens center mark

5. Adjust the headlight beam.
 - (1) Position the vehicle with its front end facing the measuring panel from a distance of 3 m (10 ft).
 - (2) Turn on the low beam headlights, and mark the cut line.
 1. Use a sheet of unruled white paper (B), and highlight the projector shadow (C).
 2. Align the bottom edge of the white paper sheet with the cut line (A) on the projector side.

VB-*CU

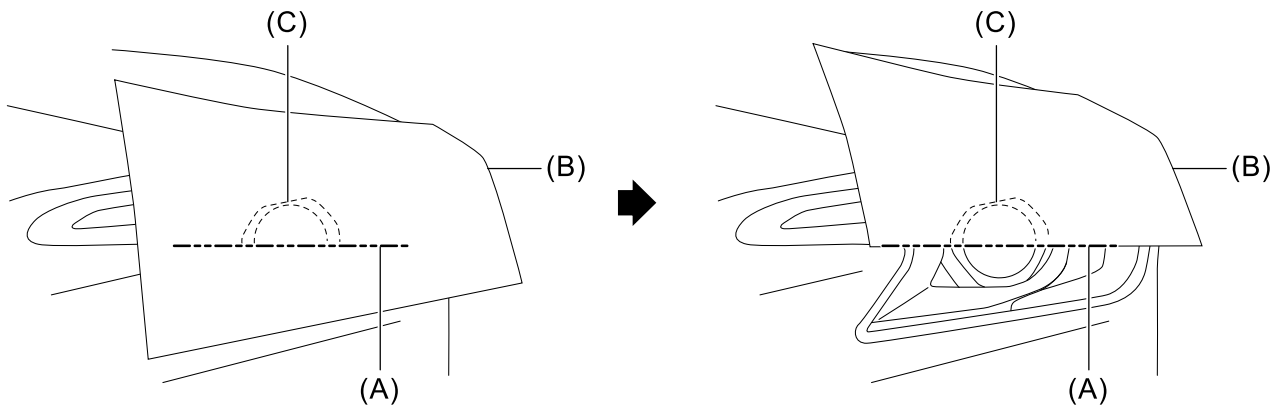

LI-11641

(3) Check the beam level.

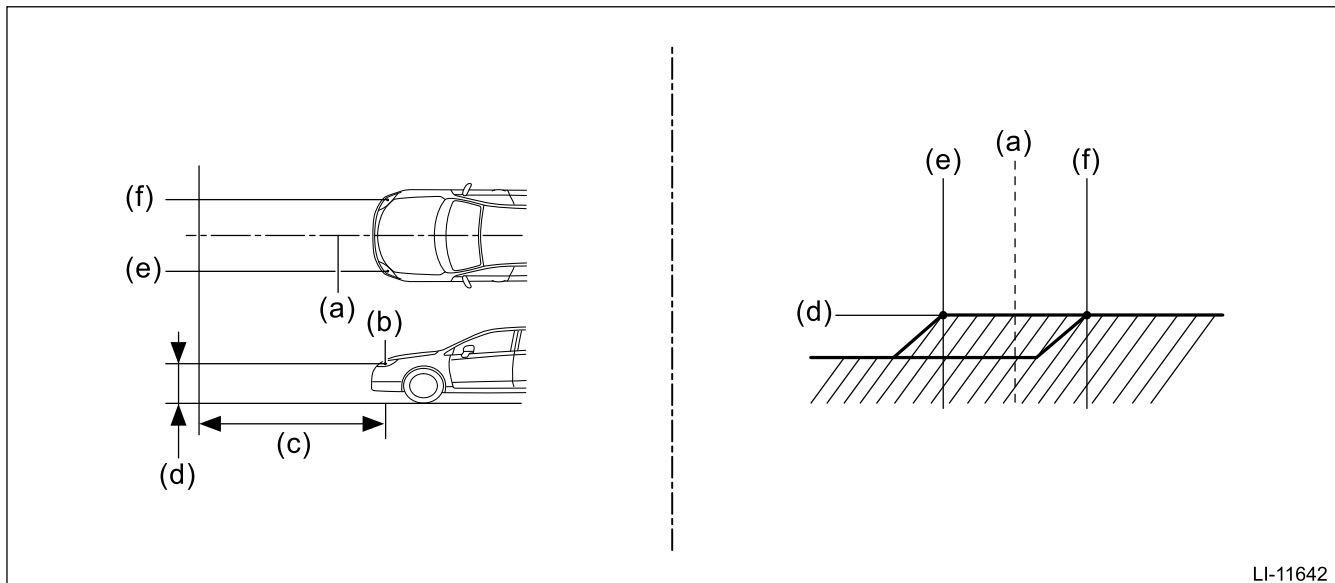

LI-11642

- (a) Vehicle center (c) 3 m (10 ft) (e) Lens center of headlight LH
(b) Lens center mark (d) Height of lens center mark (f) Lens center of headlight RH

(4) Adjust the beam level by turning the aiming screws (A) and (B) in the same direction and by the same number of rotations.

VB-*BU

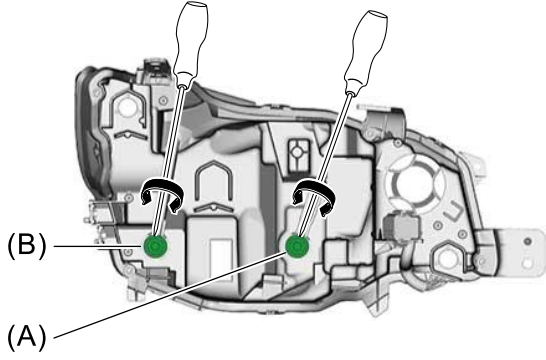

LI-11342

LIGHTING SYSTEM > Clearance/Parking Light Bulb

REMOVAL





Caution:

- Use a dry clean cloth so that no grease or water adheres to the glass portion of the bulb.
- Do not leave the light assembly head without the bulb for a long time. Dust, moisture, etc. entering the light may affect its performance.

Note:

The illustration shows the LH side.

1. HALOGEN TYPE

1. Disconnect the ground terminal from battery sensor.  [Ref. to REPAIR CONTENTS>NOTE > BATTERY.](#)
2. Remove the battery. (When removing the LH side bulb)  [Ref. to STARTING/CHARGING SYSTEMS\(H4DOTC\)>Battery>REMOVAL.](#)
3. Remove the air intake duct. (When removing the RH side bulb)  [Ref. to INTAKE \(INDUCTION\) \(H4DOTC\)>Air Intake Duct>REMOVAL.](#)
4. Remove the air cleaner case. (When removing the RH side bulb)  [Ref. to INTAKE \(INDUCTION\) \(H4DOTC\)>Air Cleaner Case>REMOVAL.](#)
5. Rotate in the direction of arrow shown in the figure to remove the bulb socket.

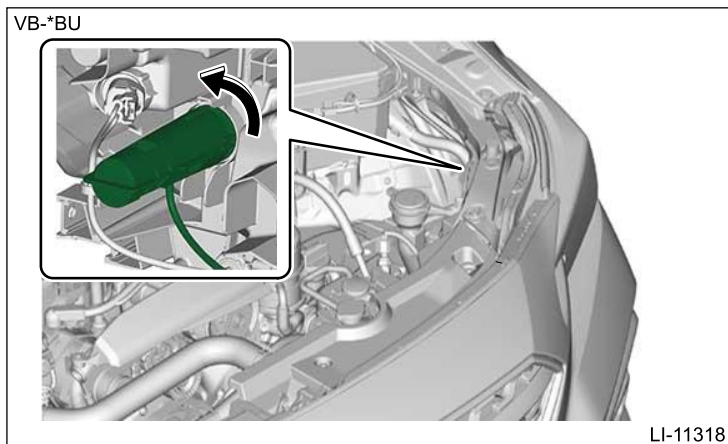

6. Remove the parking light bulb.

2. LED TYPE

Since it is a non-disassembled part, it cannot be removed. Replace the light assembly head if faulty.

LIGHTING SYSTEM > Clearance/Parking Light Bulb



INSTALLATION

Caution:

Use a dry clean cloth so that no grease or water adheres to the glass portion of the bulb.

1. HALOGEN TYPE

1. Install the parking light bulb.
2. Install the air cleaner case. (When the RH side bulb has been removed)  [Ref. to INTAKE \(INDUCTION\)\(H4DOTC\)>Air Cleaner Case>INSTALLATION.](#)

- 3.** Install the air intake duct. (When the RH side bulb has been removed)  [Ref. to INTAKE \(INDUCTION\) \(H4DOTC\)>Air Intake Duct>INSTALLATION.](#)
- 4.** Install the battery. (When the LH side bulb has been removed)  [Ref. to STARTING/CHARGING SYSTEMS\(H4DOTC\)>Battery>INSTALLATION.](#)
- 5.** Connect the ground terminal to battery sensor.  [Ref. to REPAIR CONTENTS>NOTE > BATTERY.](#)

2. LED TYPE

Since it is a non-disassembled part, it cannot be removed. Replace the light assembly head if faulty.

LIGHTING SYSTEM > Front Turn Signal Light Bulb

NOTE

1. HALOGEN TYPE

The front turn signal light bulb is integrated with the parking light.

Replace the parking light bulb if faulty.  [Ref. to LIGHTING SYSTEM>Clearance/Parking Light Bulb.](#)

2. LED TYPE

Since it is a non-disassembled part, it cannot be removed. Replace the light assembly head if faulty.

LIGHTING SYSTEM > Front Side Marker Light Bulb

REMOVAL





Caution:

- Use a dry clean cloth so that no grease or water adheres to the glass portion of the bulb.
- Do not leave the light assembly head without the bulb for a long time. Dust, moisture, etc. entering the light may affect its performance.

Note:

The illustration shows the LH side.

1. HALOGEN TYPE

1. Disconnect the ground terminal from battery sensor.  [Ref. to REPAIR CONTENTS>NOTE > BATTERY.](#)
2. Remove the battery. (When removing the LH side bulb)  [Ref. to STARTING/CHARGING SYSTEMS\(H4DOTC\)>Battery>REMOVAL.](#)
3. Remove the air intake duct. (When removing the RH side bulb)  [Ref. to INTAKE \(INDUCTION\) \(H4DOTC\)>Air Intake Duct>REMOVAL.](#)
4. Remove the air cleaner case. (When removing the RH side bulb)  [Ref. to INTAKE \(INDUCTION\) \(H4DOTC\)>Air Cleaner Case>REMOVAL.](#)
5. Rotate in the direction of arrow shown in the figure to remove the bulb socket.

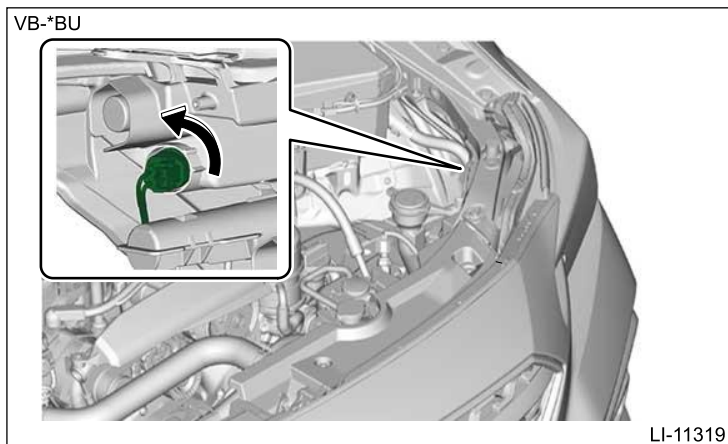

6. Remove the front side marker light bulb.

2. LED TYPE

Since it is a non-disassembled part, it cannot be removed. Replace the light assembly head if faulty.

LIGHTING SYSTEM > Front Side Marker Light Bulb



INSTALLATION

Caution:

Use a dry clean cloth so that no grease or water adheres to the glass portion of the bulb.

1. HALOGEN TYPE

1. Install the front side marker light bulb.
2. Install the air cleaner case. (When the RH side bulb has been removed)  [Ref. to INTAKE \(INDUCTION\)\(H4DOTC\)>Air Cleaner Case>INSTALLATION.](#)



- 3.** Install the air intake duct. (When the RH side bulb has been removed)  [Ref. to INTAKE \(INDUCTION\) \(H4DOTC\)>Air Intake Duct>INSTALLATION.](#)
- 4.** Install the battery. (When the LH side bulb has been removed)  [Ref. to STARTING/CHARGING SYSTEMS\(H4DOTC\)>Battery>INSTALLATION.](#)
- 5.** Connect the ground terminal to battery sensor.  [Ref. to REPAIR CONTENTS>NOTE > BATTERY.](#)

2. LED TYPE

Since it is a non-disassembled part, it cannot be removed. Replace the light assembly head if faulty.

LIGHTING SYSTEM > Hazard Switch

REMOVAL

1. Disconnect the ground terminal from battery sensor.  [Ref. to REPAIR CONTENTS>NOTE > BATTERY.](#)
2. Remove the ornament panel mid passenger and panel assembly center.  [Ref. to EXTERIOR/INTERIOR TRIM>Centor Cluster>REMOVAL.](#)
3. Remove the center information display assembly.  [Ref. to ENTERTAINMENT & MONITORING>Cockpit Display>REMOVAL.](#)
4. Remove the screws and harness clip and remove the switch hazard.

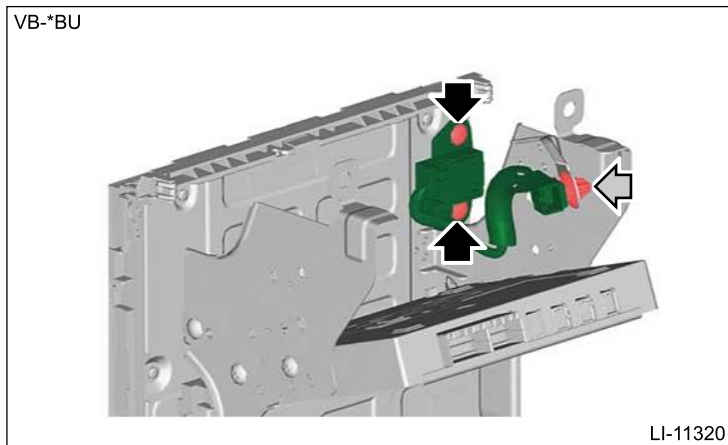



LIGHTING SYSTEM > Hazard Switch

INSTALLATION

Caution:

Before handling the airbag system components, refer to "CAUTION" of "General Description" in "AIRBAG SYSTEM".  [Ref. to AIRBAG SYSTEM>General Description>CAUTION.](#)

1. Install the switch hazard.
2. Install the center information display assembly.  [Ref. to ENTERTAINMENT & MONITORING>Cockpit Display>INSTALLATION.](#)
3. Install the panel assembly center and the ornament panel mid passenger.  [Ref. to EXTERIOR/INTERIOR TRIM>Centor Cluster>INSTALLATION.](#)
4. Connect the ground terminal to battery sensor.  [Ref. to REPAIR CONTENTS>NOTE > BATTERY.](#)

LIGHTING SYSTEM > Hazard Switch

INSPECTION

1. Measure the resistance between connector terminals.

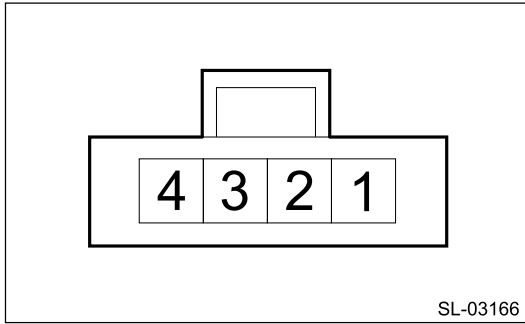

Terminal No.	Inspection conditions	Standard
3 – 2	Switch OFF	1 MΩ or more
	Switch ON	Less than 1 Ω

2. Apply battery voltage between the connector terminals to check lighting condition of illumination inside the switch.

Caution:

When applying battery voltage, do not mix up the positive (+) side and the negative (–) side.

Incorrect polarity connection may cause LED damage inside the switch.

Terminal No.	Inspection conditions	Specification
4 (+) – 1 (–)	Apply battery voltage.	Light ON

3. Replace the switch hazard if it is found defective.

LIGHTING SYSTEM > Front Fog Light Assembly

REMOVAL



1. Disconnect the ground terminal from battery sensor.  [Ref. to REPAIR CONTENTS>NOTE > BATTERY.](#)
2. Lift up the vehicle.
3. Remove the screw and clips, and turn over the mud guard front.

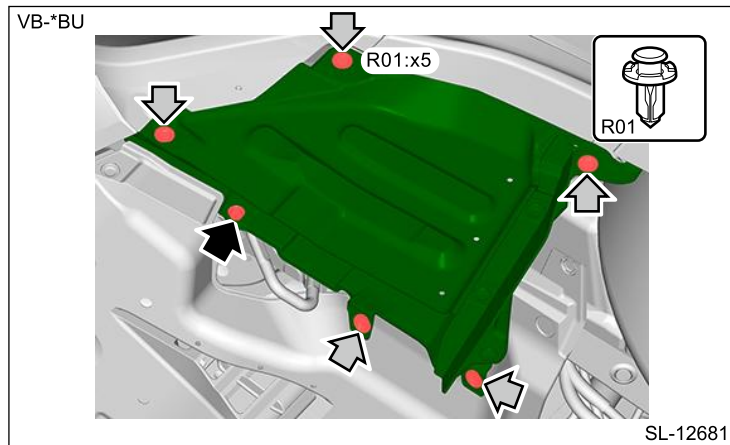

4. Remove the fog light assembly front.
 - (1) Disconnect the connector.
 - (2) Remove the screws and clips, and remove the fog light assembly front.

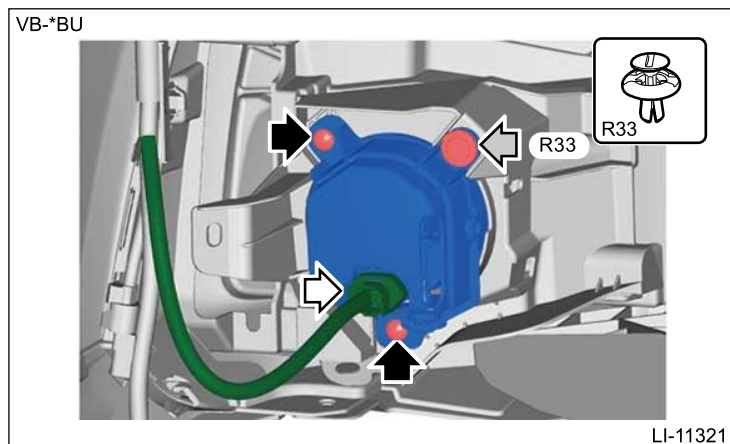

LIGHTING SYSTEM > Front Fog Light Assembly

INSTALLATION

1. Install the fog light assembly front.

Tightening torque:
2 N·m (0.2 kgf-m, 1.5 ft-lb)
2. Lower the vehicle.
3. Connect the ground terminal to battery sensor.  [Ref. to REPAIR CONTENTS>NOTE > BATTERY.](#)
4. Adjust the fog light beam.  [Ref. to LIGHTING SYSTEM>Front Fog Light Assembly>ADJUSTMENT > FOG LIGHT AIMING.](#)

5. Install the mud guard front.  [Ref. to EXTERIOR/INTERIOR TRIM>Mud Guard>INSTALLATION.](#)

LIGHTING SYSTEM > Front Fog Light Assembly

ADJUSTMENT

1. FOG LIGHT AIMING

1. Before checking the fog light beam level, be sure of the following:
 - Check the area around the fog light for any scratches, damage or other type of deformation.
 - The vehicle is parked on a level surface.
 - The inflation pressure of tires is correct.
 - The vehicle does not have load.
 - Vehicle's fuel tank is fully filled.
2. Bounce the vehicle several times to normalize the suspension.
3. Make certain that someone is seated in the driver's seat.
4. Place the vehicle with the front end facing to the measurement panel.

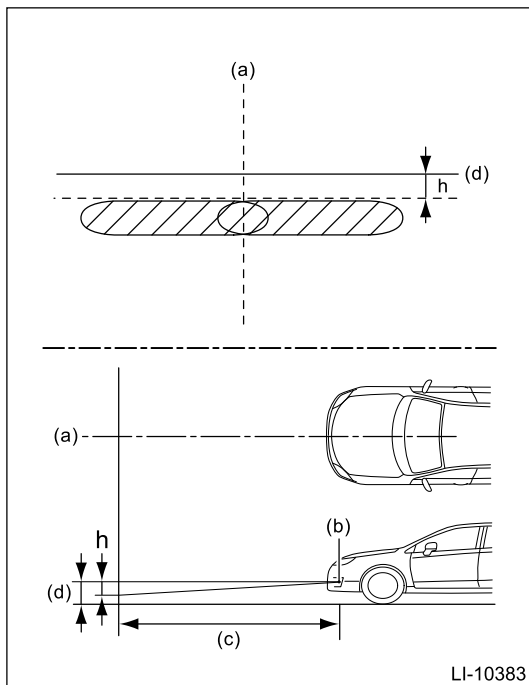

- (a) Vehicle center
- (b) Bulb center marking
- (c) 3 m (10 ft)
- (d) Height of fog light center

h mm (in) at 3 m (10 ft)
40 (1.57)

5. Adjust the fog light beam.
 - (1) Remove the screw and clips, and turn over the mud guard front.

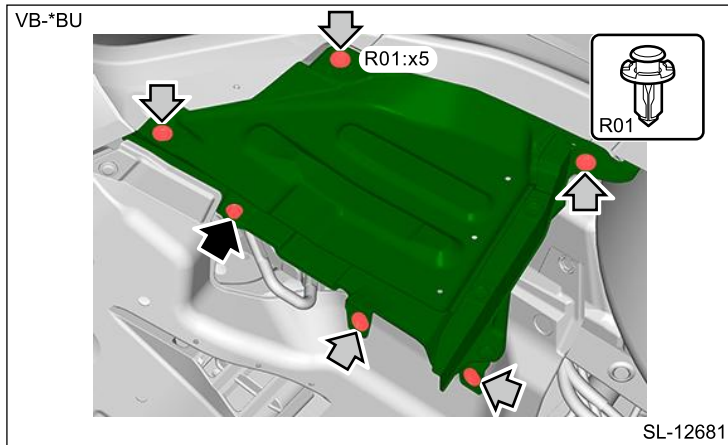

(2) Adjust the beam level by turning the aiming screw.

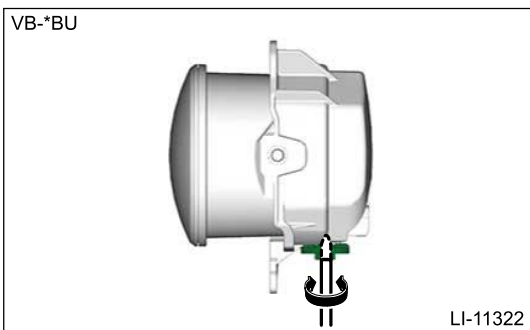

(3) Install the mud guard front.  [Ref. to EXTERIOR/INTERIOR TRIM>Mud Guard>INSTALLATION.](#)

LIGHTING SYSTEM > Front Fog Light Assembly

INSPECTION

1. Apply battery voltage between the connector terminals to check the lighting condition of the light.

Caution:

When applying battery voltage, do not mix up the positive (+) side and the negative (-) side.

Incorrect polarity connection may cause internal LED damage.

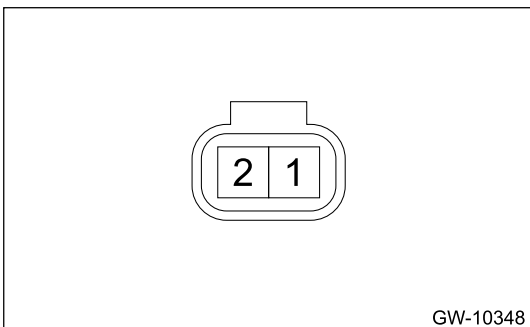

Terminal No.	Inspection conditions	Specification
2 (+) — 1 (-)	Apply battery voltage.	Light ON



2. Replace the fog light assembly front if faulty is found in the inspection.

Note:

Since LED is used for the light, replace the fog light assembly front if the light does not illuminate.



LIGHTING SYSTEM > Side Turn Signal Light Assembly

REMOVAL

1. Disconnect the ground terminal from battery sensor.  [Ref. to REPAIR CONTENTS>NOTE > BATTERY.](#)
2. Remove the light assembly side turn mirror.  [Ref. to GLASS/WINDOWS/MIRRORS>Outer Mirror Assembly>DISASSEMBLY.](#)

LIGHTING SYSTEM > Side Turn Signal Light Assembly

INSTALLATION

1. Install the light assembly side turn mirror.  [Ref. to GLASS/WINDOWS/MIRRORS>Outer Mirror Assembly>ASSEMBLY.](#)
2. Connect the ground terminal to battery sensor.  [Ref. to REPAIR CONTENTS>NOTE > BATTERY.](#)

LIGHTING SYSTEM > Side Turn Signal Light Assembly

INSPECTION

1. Apply battery voltage between the connector terminals to check the lighting condition of the light.

Caution:

When applying battery voltage, do not mix up the positive (+) side and the negative (-) side.

Incorrect polarity connection may cause internal LED damage.

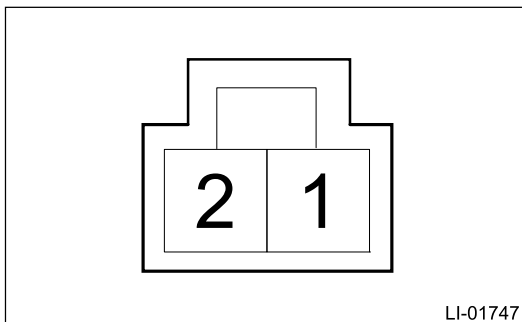

Terminal No.	Inspection conditions	Specification
1 (+) – 2 (-)	Apply battery voltage.	Light ON

2. Replace the light assembly side turn mirror if faulty is found in the inspection.

Note:

Since LED is used for the light, replace the light assembly side turn mirror if the light does not illuminate.

LIGHTING SYSTEM > Rear Combination Light Assembly

REMOVAL

1. Disconnect the ground terminal from battery sensor.  Ref. to REPAIR CONTENTS>NOTE > BATTERY.
2. Release the clips and claws, and then remove the cover assembly rear combination light.

Caution:

- Do not remove the cover forcibly if the cover is not unhooked. Doing so may result in damage of the cover claw or the light assembly rear combination.
- When using a flat tip screwdriver, use an appropriate sized tool for the insertion opening, apply protective tape or cloth around the tool, and be careful not to cause damage.

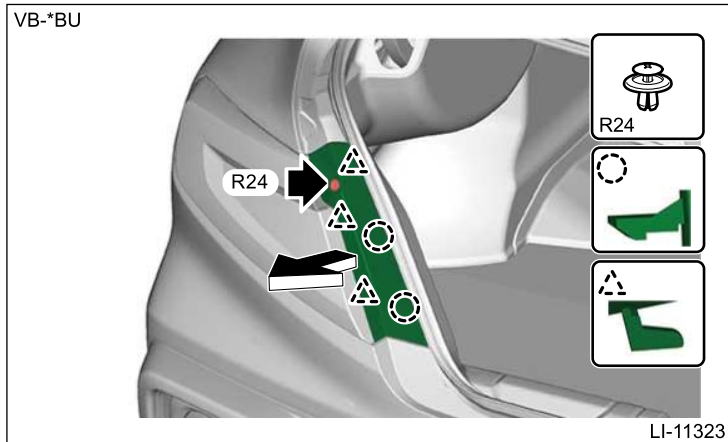

3. Remove the light assembly rear combination.
 - (1) Release the bolts and clips, then pull out the light assembly rear combination toward the rear of the vehicle at an angle as shown in the figure.

Caution:

Be careful not to damage the clips.

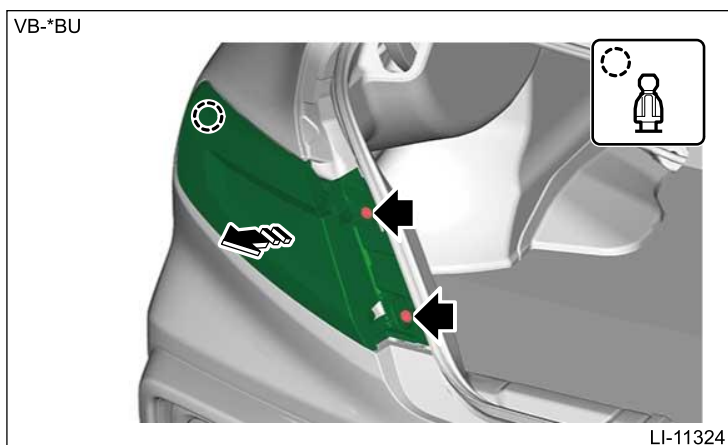

- (2) Disconnect the connector and remove the light assembly rear combination.

LIGHTING SYSTEM > Rear Combination Light Assembly

INSTALLATION

1. Connect the connector, and install the light assembly rear combination.

Caution:

- Be careful not to catch the harness in between the parts.
- Make sure that gaskets are attached on the combination light assembly. If a gasket is not attached, water leakage may occur.

Tightening torque:

7.5 N·m (0.8 kgf-m, 5.5 ft-lb)

2. Install the cover assembly rear combination light.
3. Connect the ground terminal to battery sensor.  [Ref. to REPAIR CONTENTS>NOTE > BATTERY.](#)

LIGHTING SYSTEM > Rear Combination Light Assembly

DISASSEMBLY

1. TAIL LIGHT BULB

Since it is a non-disassembled part, it cannot be removed. Replace the light assembly rear combination if defective.

2. STOP LIGHT BULB

Since it is a non-disassembled part, it cannot be removed. Replace the light assembly rear combination if defective.

3. TURN SIGNAL LIGHT BULB

Caution:

- Use a dry clean cloth so that no grease or water adheres to the glass portion of the bulb.
- Do not leave the light assembly rear combination without the bulb for a long time. Dust, moisture, etc. entering the light may affect its performance.

1. Rotate in the direction of arrow shown in the figure to remove the bulb socket.



2. Remove the turn signal light bulb.

4. BACK-UP LIGHT BULB

Since it is a non-disassembled part, it cannot be removed. Replace the light assembly rear combination if defective.

5. REAR SIDE MARKER LIGHT BULB

Since it is a non-disassembled part, it cannot be removed. Replace the light assembly rear combination if defective.

6. CORD ASSEMBLY

1. Remove the connector clip.
2. Turn the cover in the arrow direction to remove it and disconnect the internal connector.
3. Remove the bulb socket and remove the cord assembly.

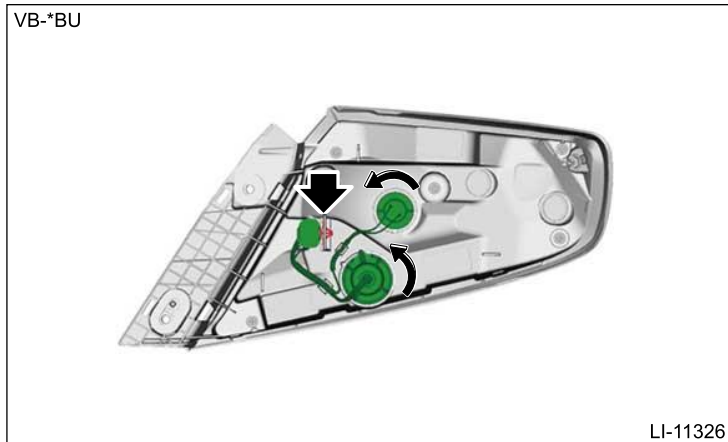

LIGHTING SYSTEM > Rear Combination Light Assembly

ASSEMBLY

1. TAIL LIGHT

Since it is a non-disassembled part, it cannot be removed. Replace the light assembly rear combination if defective.

2. STOP LIGHT BULB

Since it is a non-disassembled part, it cannot be removed. Replace the light assembly rear combination if defective.

3. TURN SIGNAL LIGHT BULB

Caution:

Use a dry clean cloth so that no grease or water adheres to the glass portion of the bulb.

1. Install the turn signal light bulb.
2. Install the bulb socket.

4. BACK-UP LIGHT BULB

Since it is a non-disassembled part, it cannot be removed. Replace the light assembly rear combination if defective.

5. REAR SIDE MARKER LIGHT BULB

Since it is a non-disassembled part, it cannot be removed. Replace the light assembly rear combination if defective.

6. CORD ASSEMBLY

1. Install the cord assembly as shown in the figure.

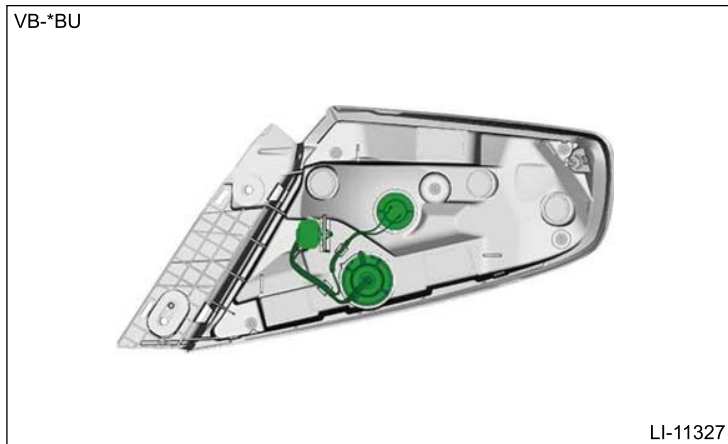

LIGHTING SYSTEM > Rear Combination Light Assembly

INSPECTION

1. Apply battery voltage between the connector terminals to check the lighting condition of the light.

Caution:

When applying battery voltage, do not mix up the positive (+) side and the negative (-) side.

Incorrect polarity connection may cause internal LED damage.

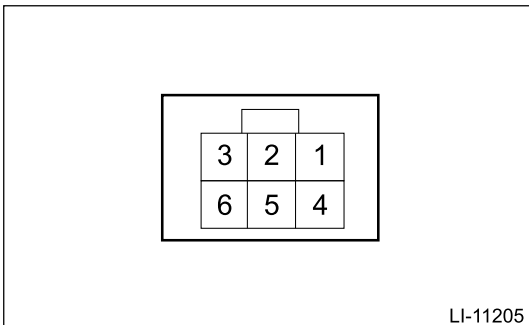

Terminal No.	Inspection conditions	Specification
6 (+) – 2 (-)	Apply battery voltage.	Stop light on
4 (+) – 2 (-)		Tail lights and rear side marker lights on
3 (+) – 2 (-)		Turn signal light on
1 (+) – 2 (-)		Back-up light on

2. Carry out the following procedure if you find any defects.
 - Turn signal light: Check the harness and bulb.
 - Since LED is used for the following lights, replace the combination light assembly if the light does not illuminate.
 - Stop light
 - Tail light
 - Rear side marker light

- Back-up light

LIGHTING SYSTEM > License Plate Light



REMOVAL

Caution:

- Use a dry clean cloth so that no grease or water adheres to the glass portion of the bulb.
- Do not leave the license plate light assembly without the bulb for a long time. Dust, moisture, etc. entering the light may affect its performance.

Note:

Do not remove the license plate light assembly when removing the bulb only.

1. Disconnect the ground terminal from battery sensor.  [Ref. to REPAIR CONTENTS>NOTE > BATTERY.](#)
2. Remove the trim panel trunk lid.  [Ref. to EXTERIOR/INTERIOR TRIM>Trunk Room Trim>REMOVAL.](#)
3. Remove the garnish assembly trunk.  [Ref. to EXTERIOR/INTERIOR TRIM>Trunk Lid Garnish>REMOVAL.](#)
4. Remove the license plate light assembly.
 - (1) Release the claws and pull out the license plate light assembly.
 - (2) Disconnect the connector, and remove the license plate light assembly.

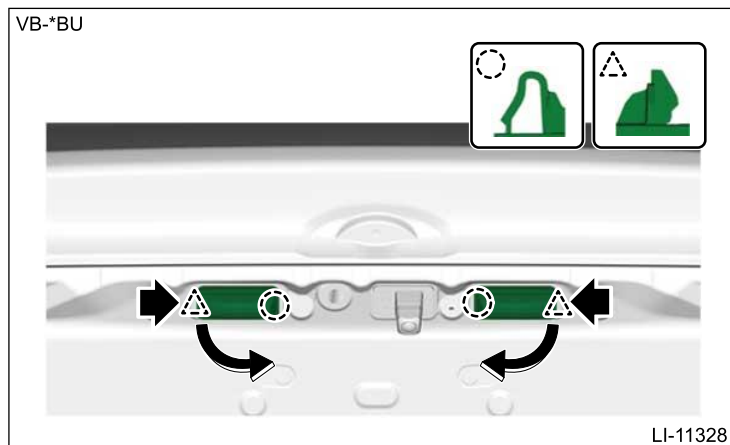

5. Remove the license plate light bulb.

Note:

Perform this procedure only when required.

- (1) Rotate in the direction of arrow shown in the figure to remove the bulb socket.
- (2) Remove the license plate light bulb.

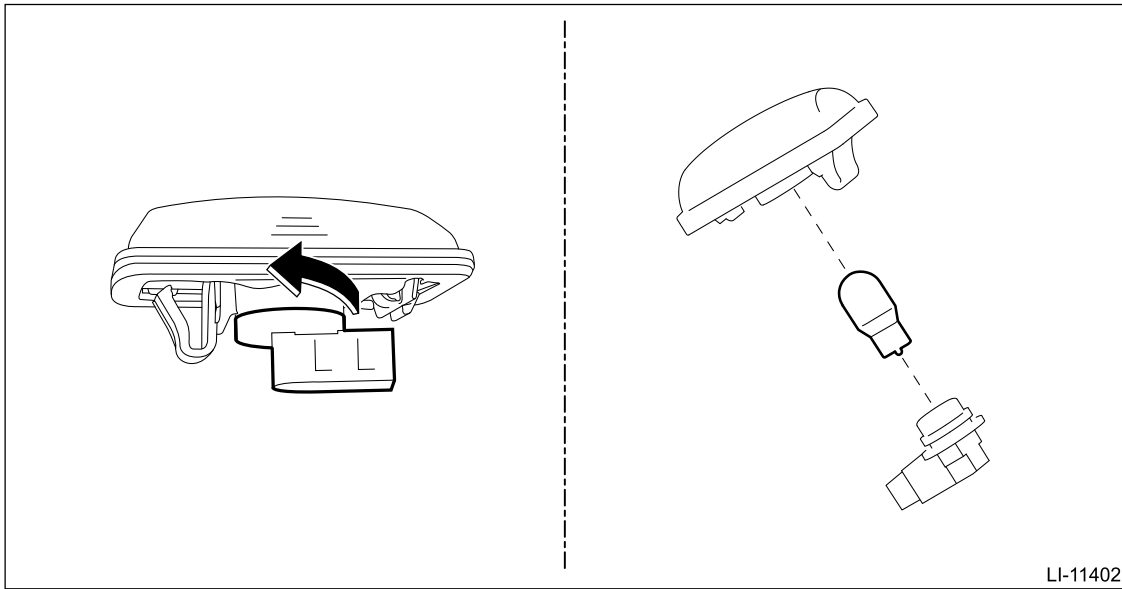



LIGHTING SYSTEM > License Plate Light

INSTALLATION

Caution:

Use a dry clean cloth so that no grease or water adheres to the glass portion of the bulb.

1. Install the license plate light bulb.
2. Connect the connector, and install the license plate light assembly.
3. Install the garnish assembly trunk.  [Ref. to EXTERIOR/INTERIOR TRIM>Trunk Lid Garnish>INSTALLATION.](#)
4. Install the trim panel trunk lid.  [Ref. to EXTERIOR/INTERIOR TRIM>Trunk Room Trim>INSTALLATION.](#)
5. Connect the ground terminal to battery sensor.  [Ref. to REPAIR CONTENTS>NOTE > BATTERY.](#)

LIGHTING SYSTEM > License Plate Light

INSPECTION

1. Apply battery voltage between the connector terminals to check the lighting condition of the light.

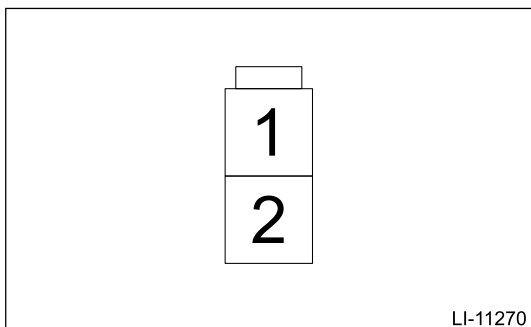

Terminal No.	Inspection conditions	Specification
1 (+) – 2 (-)	Apply battery voltage.	Light ON

2. Replace the harness and bulb if it is found defective.

LIGHTING SYSTEM > License Plate Light Bulb

REMOVAL

Caution:

- Use a dry clean cloth so that no grease or water adheres to the glass portion of the bulb.
- Do not leave the license plate light without the bulb for a long time. Dust, moisture, etc. entering the light may affect its performance.

1. Disconnect the ground terminal from battery sensor. [🔧 Ref. to REPAIR CONTENTS>NOTE > BATTERY.](#)
2. Remove the trim panel trunk lid. [🔧 Ref. to EXTERIOR/INTERIOR TRIM>Trunk Room Trim>REMOVAL.](#)
3. Remove the license plate light bulb.
(1) Rotate in the direction of arrow shown in the figure to remove the bulb socket.

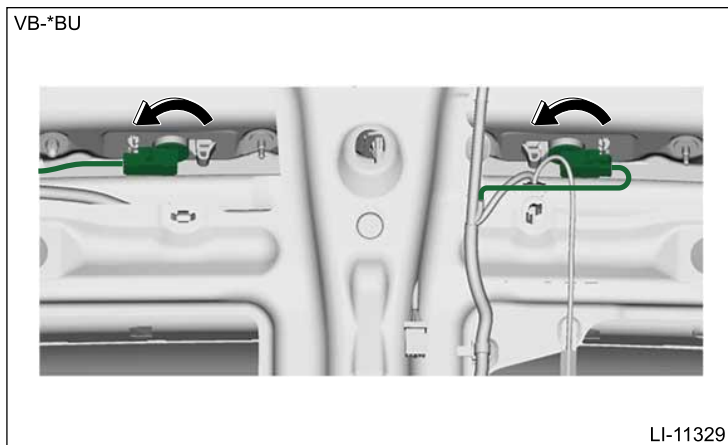

- (2) Remove the license plate light bulb.

LIGHTING SYSTEM > License Plate Light Bulb

INSTALLATION

Caution:

- Use a dry clean cloth so that no grease or water adheres to the glass portion of the bulb.

1. Install the license plate light bulb.
2. Install the bulb socket.
3. Install the trim panel trunk lid. [🔧 Ref. to EXTERIOR/INTERIOR TRIM>Trunk Room Trim>INSTALLATION.](#)
4. Connect the ground terminal to battery sensor. [🔧 Ref. to REPAIR CONTENTS>NOTE > BATTERY.](#)





LIGHTING SYSTEM > High-mounted Stop Light

REMOVAL



Caution:

- Before handling the airbag system components, refer to "CAUTION" of "General Description" in "AIRBAG SYSTEM".  [Ref. to AIRBAG SYSTEM>General Description>CAUTION.](#)
- Side impact sensor (under the rear center seat) for the airbag system is located under the front center of the rear seat cushion. Be careful not to apply strong impact to the sensor when working with the rear seat cushion removed.

1. Disconnect the ground terminal from the battery sensor, and wait for at least 60 seconds before starting work.  [Ref. to REPAIR CONTENTS>NOTE > BATTERY.](#)
2. Remove the rear seat cushion assembly and the backrest assembly.  [Ref. to SEATS>Rear Seat>REMOVAL.](#)
3. Remove the trim panel assembly C pillar LWR and the trim panel assembly C pillar.  [Ref. to EXTERIOR/INTERIOR TRIM>Rear Quarter Trim>REMOVAL.](#)
4. Remove the trim panel assembly rear shelf.  [Ref. to EXTERIOR/INTERIOR TRIM>Rear Shelf Trim>REMOVAL.](#)
5. Remove the cover tape.

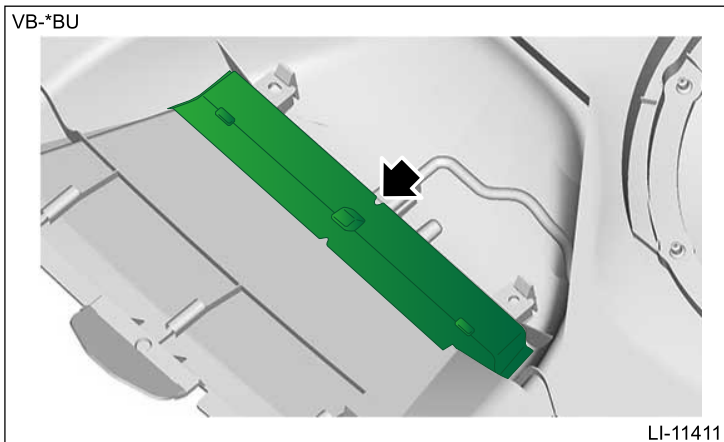

6. Remove the light assembly high-mounted.
 - (1) Release the claws.
 - (2) Disconnect the connector and remove the light assembly high-mounted.



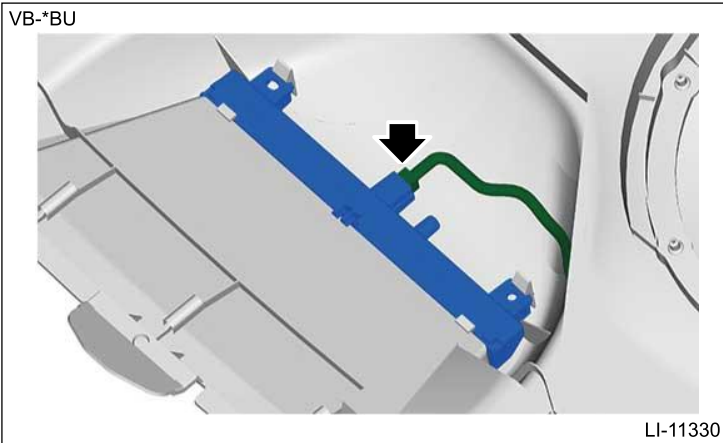

VB-*BU



LIGHTING SYSTEM > High-mounted Stop Light INSTALLATION

Caution:

- Before handling the airbag system components, refer to "CAUTION" of "General Description" in "AIRBAG SYSTEM".  [Ref. to AIRBAG SYSTEM>General Description>CAUTION.](#)
- Side impact sensor (under the rear center seat) for the airbag system is located under the front center of the rear seat cushion. Be careful not to apply strong impact to the sensor when working with the rear seat cushion removed.

1. Connect the connector, and install the light assembly high-mounted.
2. Apply a new cover tape.
3. Install the trim panel assembly rear shelf.  [Ref. to EXTERIOR/INTERIOR TRIM>Rear Shelf Trim>INSTALLATION.](#)
4. Install the trim panel assembly C pillar and the trim panel assembly C pillar LWR.  [Ref. to EXTERIOR/INTERIOR TRIM>Rear Quarter Trim>INSTALLATION.](#)
5. Install the backrest assembly and rear seat cushion assembly.  [Ref. to SEATS>Rear Seat>INSTALLATION.](#)
6. Connect the ground terminal to battery sensor.  [Ref. to REPAIR CONTENTS>NOTE > BATTERY.](#)

LIGHTING SYSTEM > High-mounted Stop Light INSPECTION

1. Apply battery voltage between the connector terminals to check the lighting condition of the light.

Caution:

- When applying battery voltage, do not mix up the positive (+) side and the negative (-) side.
- Incorrect polarity connection may cause internal LED damage.

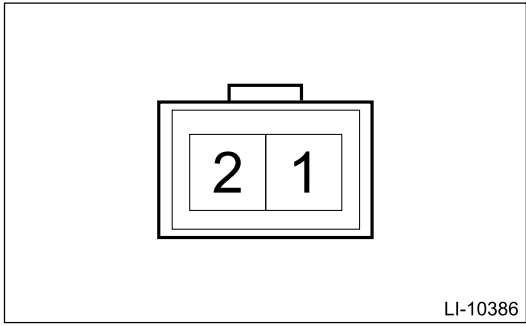

Terminal No.	Inspection conditions	Specification
1 (+) – 2 (-)	Apply battery voltage.	Light ON

2. Replace the light assembly high-mounted if faulty is found in the inspection.

Note:

Since LED is used for the high-mounted stop light, replace the light assembly high-mounted if the light does not illuminate.

LIGHTING SYSTEM > Spot Map Light

REMOVAL

Note:

Do not remove the light assembly map if removing the bulb only.

1. Disconnect the ground terminal from battery sensor.  [Ref. to REPAIR CONTENTS>NOTE > BATTERY.](#)
2. Release the claws, and then remove the cover assembly map light.



3. Remove the light assembly map.
(1) Remove the screws and clips.

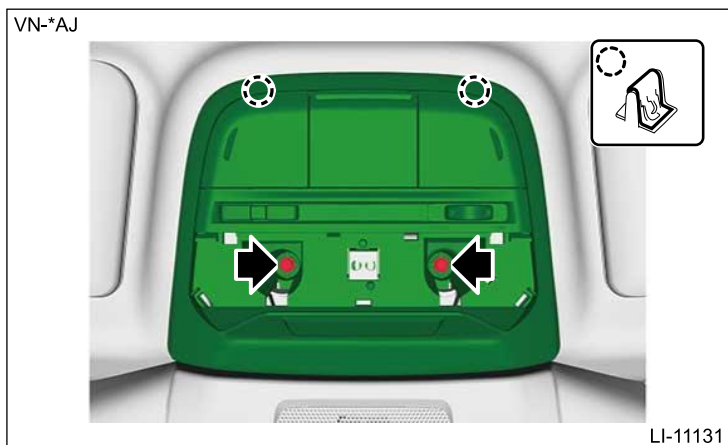

- (2) Disconnect the connector, and remove the light assembly map.
4. Remove the map light bulb.

Caution:

- Use a dry clean cloth so that no grease or water adheres to the glass portion of the bulb.
- When using a flat tip screwdriver, use an appropriate sized tool for the insertion opening, apply protective tape or cloth around the tool, and be careful not to cause damage.

Note:

Perform this procedure only when required.

- (1) Release the claws and remove the lens.
- (2) Remove the map light bulb.

VB-*BU

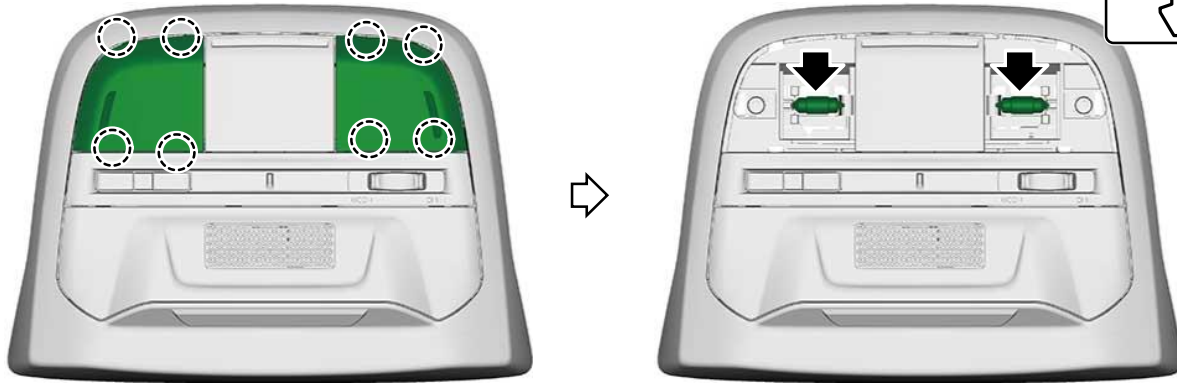

LI-11331

LIGHTING SYSTEM > Spot Map Light

INSTALLATION

1. Install the map light bulb and lens.

Caution:

Use a dry clean cloth so that no grease or water adheres to the glass portion of the bulb.

2. Connect the connector, and install the light assembly map.
3. Install the cover assembly map light.
4. Connect the ground terminal to battery sensor.  [Ref. to REPAIR CONTENTS>NOTE > BATTERY.](#)

LIGHTING SYSTEM > Spot Map Light

INSPECTION

1. Measure the resistance between connector terminals.

7	6	5	4		3	2	1	
16	15	14	13	12	11	10	9	8

LI-10388

- Light switch

Terminal No.	Inspection conditions	Standard
1 – 13	Switch OFF	1 MΩ or more
	Switch ON	Approx. 18 Ω

- Door switch

Terminal No.	Inspection conditions	Specification
1 — 4	Switch door	Continuity exists

2. Replace the harness and bulb if it is found defective.

LIGHTING SYSTEM > Room Light

REMOVAL

Note:

Do not remove the light assembly roof when removing the bulb only.

1. Disconnect the ground terminal from battery sensor.  [Ref. to REPAIR CONTENTS>NOTE > BATTERY.](#)
2. Remove the light assembly roof.
 - (1) Remove the clips, and then remove the hook.

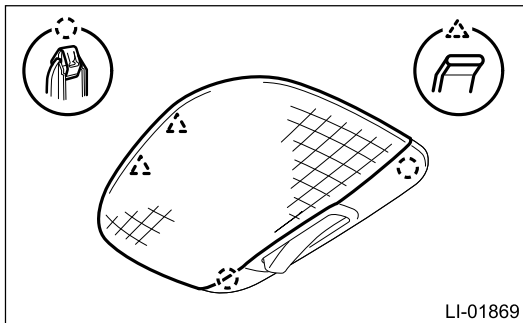

(2) Disconnect the connector and remove the light assembly roof.

3. Release the claws and remove the lens and room light bulb.

Caution:

- Use a dry clean cloth so that no grease or water adheres to the glass portion of the bulb.
- When using a flat tip screwdriver, use an appropriate sized tool for the insertion opening, apply protective tape or cloth around the tool, and be careful not to cause damage.

Note:

Perform this procedure only when required.

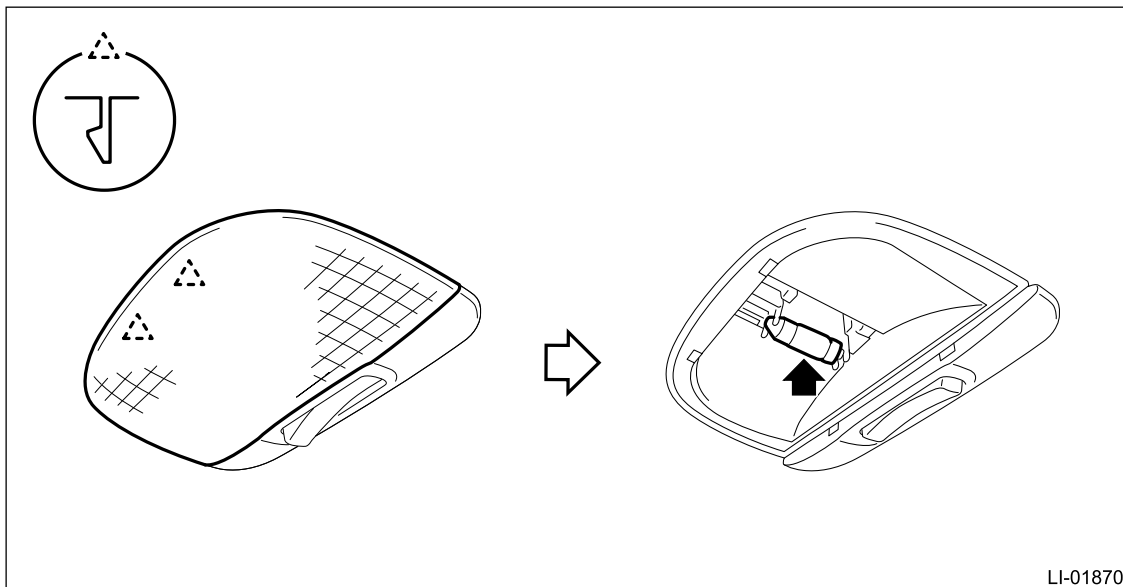

LIGHTING SYSTEM > Room Light

INSTALLATION

1. Install the room light bulb and lens.

Caution:

Use a dry clean cloth so that no grease or water adheres to the glass portion of the bulb.

2. Connect the connector, and install the light assembly roof.

Note:

Hang the hook first, and then insert the clip.

3. Connect the ground terminal to battery sensor.  [Ref. to REPAIR CONTENTS>NOTE > BATTERY.](#)

LIGHTING SYSTEM > Room Light

INSPECTION

1. Measure the resistance between connector terminals.

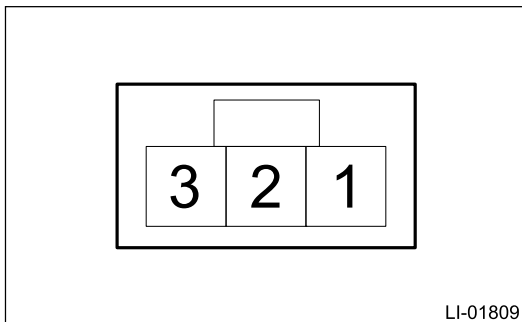

Terminal No.	Inspection conditions	Standard
1 – 3	Switch OFF	1 M Ω or more
	Switch ON	Less than 1 Ω
2 – 3	Switch door	Less than 1 Ω

2. Apply battery voltage between the connector terminals to check the lighting condition of the light.

Terminal No.	Inspection conditions	Specification
3 (+) – 1 (-) 3 (+) – 2 (-)	Switch OFF	Light OFF
	Switch ON	Light ON
	Switch door	Light ON

3. Replace the light assembly roof if faulty is found in the inspection.

LIGHTING SYSTEM > Trunk Room Light

REMOVAL

Note:

Do not remove the light assembly trunk room if removing the bulb only.

1. Disconnect the ground terminal from battery sensor.  [Ref. to REPAIR CONTENTS>NOTE > BATTERY.](#)
2. Remove the light assembly trunk room.
 - (1) Release the claws.
 - (2) Disconnect the connector and remove the light assembly trunk room.

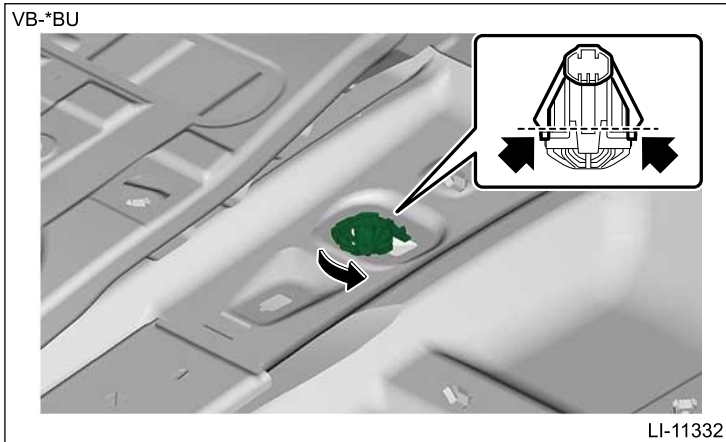

3. Release the claws to open the bulb cover, then remove the bulb.

Caution:

- Use a dry clean cloth so that no grease or water adheres to the glass portion of the bulb.
- When using a flat tip screwdriver, use an appropriate sized tool for the insertion opening, apply protective tape or cloth around the tool, and be careful not to cause damage.

Note:

Perform this procedure only when required.

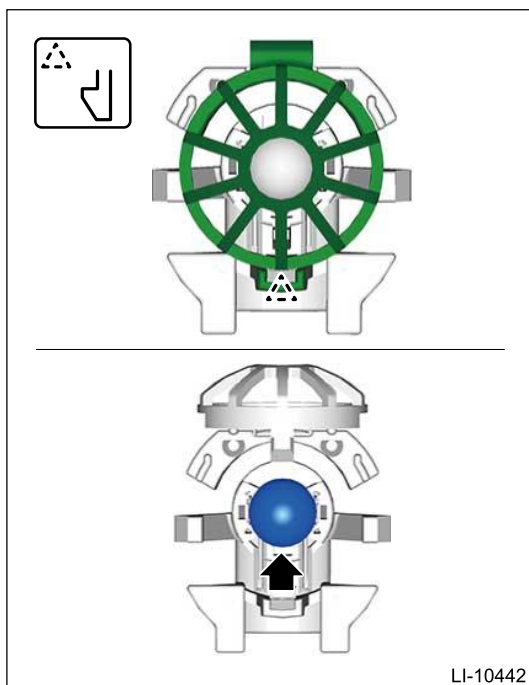

LIGHTING SYSTEM > Trunk Room Light

INSTALLATION

1. Install the bulb and bulb cover.

Caution:



Use a dry clean cloth so that no grease or water adheres to the glass portion of the bulb.

2. Connect the connector, and install the light assembly trunk room.
3. Connect the ground terminal to battery sensor.  [Ref. to REPAIR CONTENTS>NOTE > BATTERY.](#)

LIGHTING SYSTEM > LED Illumination Light

REMOVAL

1. GLOVE BOX LIGHT

1. Disconnect the ground terminal from battery sensor.  [Ref. to REPAIR CONTENTS>NOTE > BATTERY.](#)
2. Remove the pocket COMPL.  [Ref. to EXTERIOR/INTERIOR TRIM>Glove Box>REMOVAL > GLOVE BOX LID.](#)
3. Remove the light pocket cover.

Caution:

When using a flat tip screwdriver, use an appropriate sized tool for the insertion opening, apply protective tape or cloth around the tool, and be careful not to cause damage.

- (1) Release the claws.

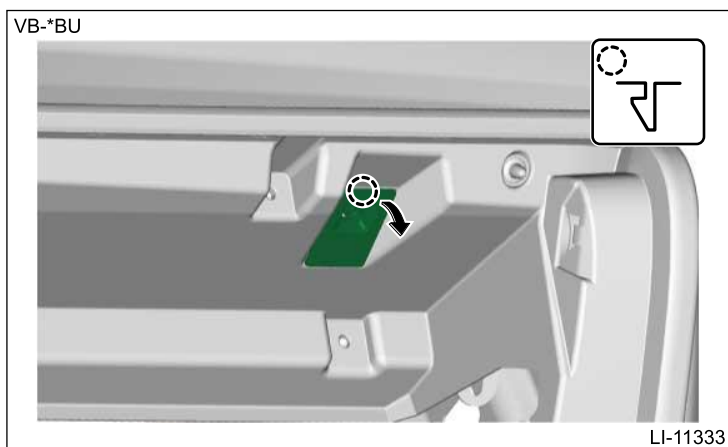

- (2) Disconnect the connector, and remove the light pocket cover.

4. Release the claws, and remove the light pocket.

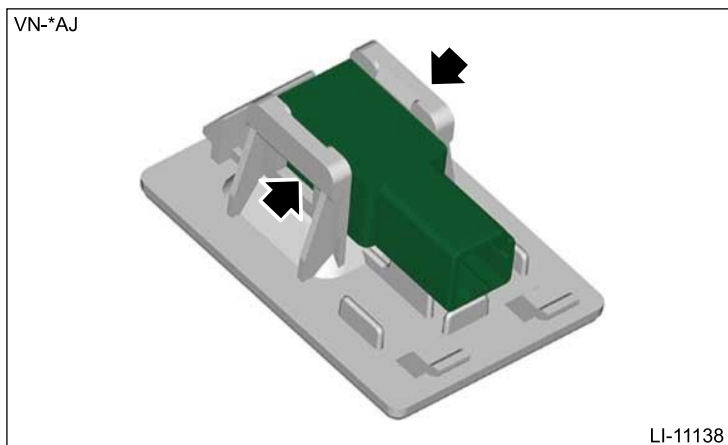







2. POCKET LIGHT

Caution:

Before handling the airbag system components, refer to "CAUTION" of "General Description" in "AIRBAG SYSTEM".  [Ref. to AIRBAG SYSTEM>General Description>CAUTION.](#)

1. Disconnect the ground terminal from the battery sensor, and wait for at least 60 seconds before starting work.  [Ref. to REPAIR CONTENTS>NOTE > BATTERY.](#)

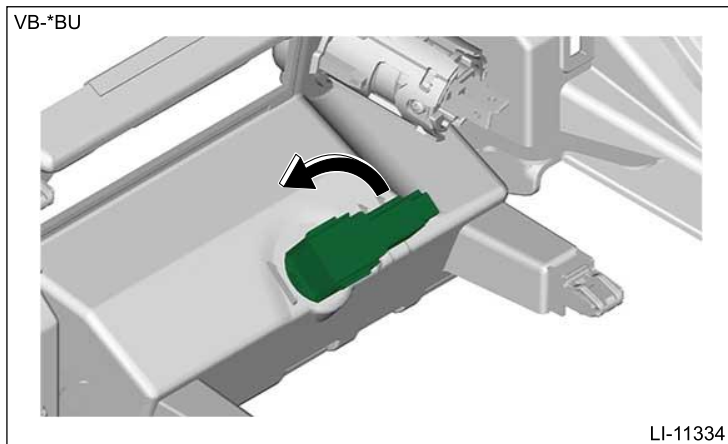

2. Remove the ornament panel mid passenger and panel assembly center.  [Ref. to EXTERIOR/INTERIOR TRIM>Centor Cluster>REMOVAL.](#)
3. Remove the cover LWR driver.  [Ref. to EXTERIOR/INTERIOR TRIM>Instrument Panel Lower Cover>REMOVAL.](#)
4. Remove the panel starter switch.  [Ref. to SECURITY AND LOCKS>Push Button Ignition Switch>REMOVAL.](#)
5. Remove the console box assembly.  [Ref. to EXTERIOR/INTERIOR TRIM>Console Box>REMOVAL.](#)
6. Remove the cover center side.  [Ref. to EXTERIOR/INTERIOR TRIM>Center Console>REMOVAL.](#)
7. Remove the tray center UPR and the AUX unit assembly.  [Ref. to ENTERTAINMENT & MONITORING>External Connection Terminal>REMOVAL > FRONT.](#)
8. Rotate in the direction of arrow shown in the figure to remove the light pocket.



LIGHTING SYSTEM > LED Illumination Light

INSTALLATION





1. GLOVE BOX LIGHT

1. Install the light pocket.
2. Connect the connector and install the light pocket cover.
3. Install the pocket COMPL.  [Ref. to EXTERIOR/INTERIOR TRIM>Glove Box>INSTALLATION > GLOVE BOX LID.](#)
4. Connect the ground terminal to battery sensor.  [Ref. to REPAIR CONTENTS>NOTE > BATTERY.](#)

2. POCKET LIGHT

Caution:

Before handling the airbag system components, refer to "CAUTION" of "General Description" in "AIRBAG SYSTEM".  [Ref. to AIRBAG SYSTEM>General Description>CAUTION.](#)

1. Install the light pocket.
2. Install the AUX unit assembly and the tray center UPR.  [Ref. to ENTERTAINMENT & MONITORING>External Connection Terminal>INSTALLATION > FRONT.](#)
3. Install the cover center side.  [Ref. to EXTERIOR/INTERIOR TRIM>Center Console>INSTALLATION.](#)
4. Install the console box assembly.  [Ref. to EXTERIOR/INTERIOR TRIM>Console Box>INSTALLATION.](#)
5. Install the panel starter switch.  [Ref. to SECURITY AND LOCKS>Push Button Ignition Switch>INSTALLATION.](#)

- 6.** Install the cover LWR driver.  [Ref. to EXTERIOR/INTERIOR TRIM>Instrument Panel Lower Cover>INSTALLATION.](#)
- 7.** Install the panel assembly center and the ornament panel mid passenger.  [Ref. to EXTERIOR/INTERIOR TRIM>Centor Cluster>INSTALLATION.](#)
- 8.** Connect the ground terminal to battery sensor.  [Ref. to REPAIR CONTENTS>NOTE > BATTERY.](#)

LIGHTING SYSTEM > Vanity Mirror Light

REMOVAL

Note:

- The vanity mirror light is integrated into the sun visor assembly. Replace the sun visor assembly if faulty.  Ref. to [EXTERIOR/INTERIOR TRIM>Sun Visor>REMOVAL](#).
- Do not remove the sun visor assembly if removing the bulb only.

1. Disconnect the ground terminal from battery sensor.  Ref. to [REPAIR CONTENTS>NOTE > BATTERY](#).
2. Remove the sun visor assembly.  Ref. to [EXTERIOR/INTERIOR TRIM>Sun Visor>REMOVAL](#).
3. Remove the vanity mirror light bulb.

Caution:

- Use a dry clean cloth so that no grease or water adheres to the glass portion of the bulb.
- When using a flat tip screwdriver, use an appropriate sized tool for the insertion opening, apply protective tape or cloth around the tool, and be careful not to cause damage.

- (1) Release the claws and remove the lens.

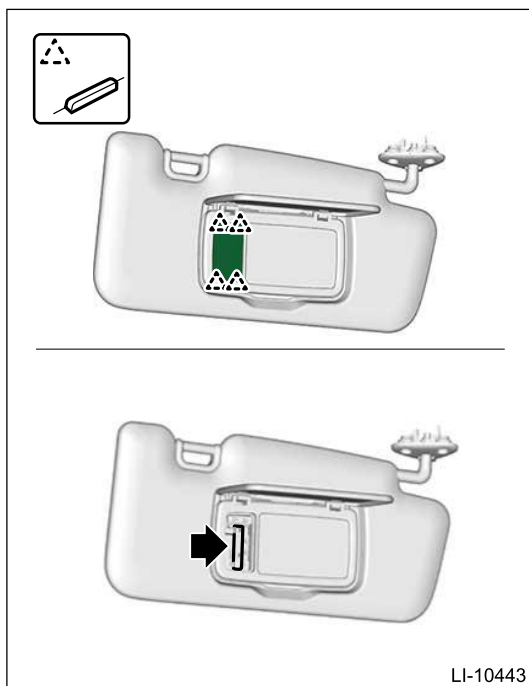

- (2) Remove the vanity mirror light bulb.

LIGHTING SYSTEM > Vanity Mirror Light

INSTALLATION

1. Install the vanity mirror light bulb and lens.

Caution:

Use a dry clean cloth so that no grease or water adheres to the glass portion of the bulb.





2. Install the sun visor assembly.  Ref. to [EXTERIOR/INTERIOR TRIM>Sun Visor>INSTALLATION](#).
3. Connect the ground terminal to battery sensor.  Ref. to [REPAIR CONTENTS>NOTE > BATTERY](#).

LIGHTING SYSTEM > Auto Headlight Beam Leveler Control Module

REMOVAL

Caution:

Before handling the airbag system components, refer to "CAUTION" of "General Description" in "AIRBAG SYSTEM".  [Ref. to AIRBAG SYSTEM>General Description>CAUTION.](#)

1. When replacing the auto headlight beam leveler CM, store the [Headlight / Foglight] customizing information.  [Ref. to COMMON \(DIAGNOSTICS\)>Customize>OPERATION > SAVE SETTINGS/READ SETTINGS.](#)
2. Disconnect the ground terminal from the battery sensor, and wait for at least 60 seconds before starting work.  [Ref. to REPAIR CONTENTS>NOTE > BATTERY.](#)
3. Remove the cover LWR driver.  [Ref. to EXTERIOR/INTERIOR TRIM>Instrument Panel Lower Cover>REMOVAL.](#)
4. Remove the knee airbag module.  [Ref. to AIRBAG SYSTEM>Knee Airbag Module>REMOVAL.](#)
5. Remove the duct foot driver.  [Ref. to AIR CONDITIONER>Air Vent Duct>REMOVAL > FOOT DUCT.](#)
6. Remove the auto headlight beam leveler CM.
 - (1) Disconnect the connector.
 - (2) Remove the bolt.
 - (3) Remove the auto headlight beam leveler CM.

VB-*BU

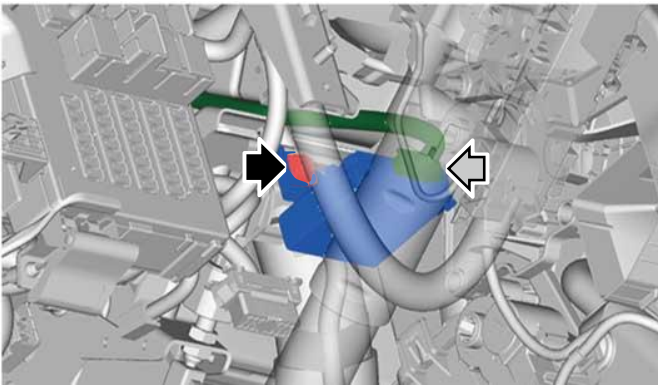

LI-11813



LIGHTING SYSTEM > Auto Headlight Beam Leveler Control Module



INSTALLATION

Caution:

Before handling the airbag system components, refer to "CAUTION" of "General Description" in "AIRBAG SYSTEM".  [Ref. to AIRBAG SYSTEM>General Description>CAUTION.](#)

1. Install the auto headlight beam leveler CM, and connect the connector.

Tightening torque:
7.5 N·m (0.8 kgf-m, 5.5 ft-lb)
2. Install the duct foot driver.  [Ref. to AIR CONDITIONER>Air Vent Duct>INSTALLATION > FOOT DUCT.](#)
3. Install the knee airbag module.  [Ref. to AIRBAG SYSTEM>Knee Airbag Module>INSTALLATION.](#)
4. Install the cover LWR driver.  [Ref. to EXTERIOR/INTERIOR TRIM>Instrument Panel Lower Cover>INSTALLATION.](#)

5. Connect the ground terminal to battery sensor.  [Ref. to REPAIR CONTENTS>NOTE > BATTERY.](#)
6. Perform auto headlight beam leveler system initialization/reinitialization.  [Ref. to LIGHTING SYSTEM>Auto Headlight Beam Leveler System>PROCEDURE.](#)
7. When the auto headlight beam leveler CM has been replaced, read the [Headlight / Foglight] customizing information.  [Ref. to COMMON \(DIAGNOSTICS\)>Customize>OPERATION > SAVE SETTINGS/READ SETTINGS.](#)

REMOVAL

1. REAR REFLEX REFLECTOR

Caution:

The muffler is extremely hot immediately after driving. Be wary of receiving burns from heated parts.

1. Release the claws and then remove the reflex reflector.

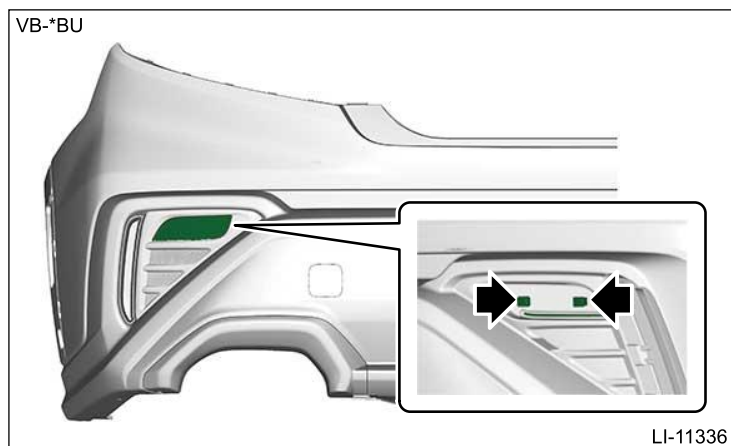

2. REAR SIDE REFLEX REFLECTOR

1. Remove the rear wheels.  [Ref. to WHEEL AND TIRE SYSTEM>Tire and Wheel>REMOVAL.](#)
2. Remove the clips and turn over the mud guard rear.

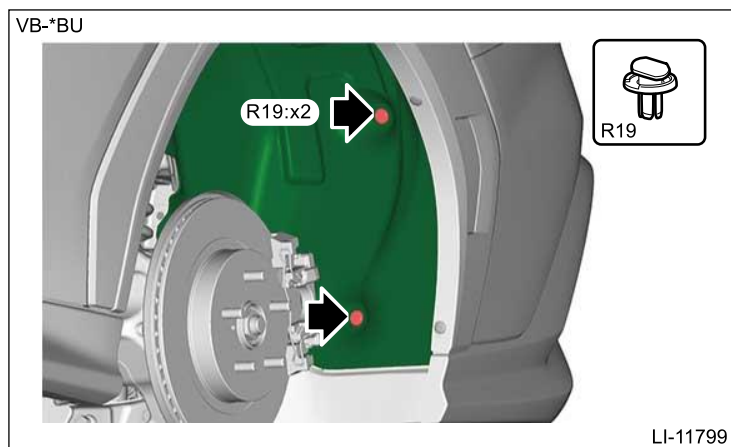

3. Release the clip and claw, then remove the rear side reflex reflector.

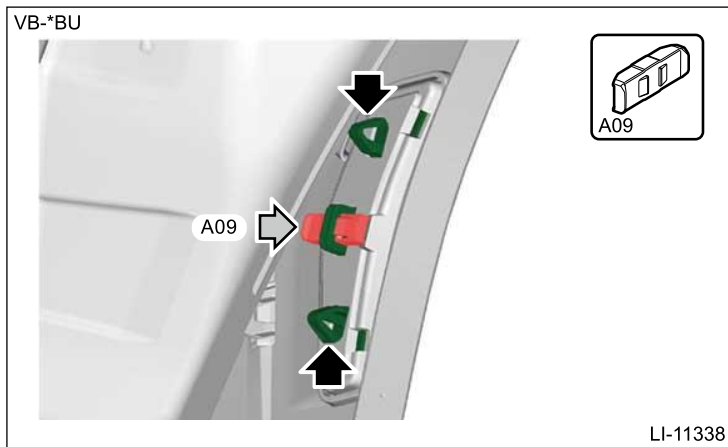

LIGHTING SYSTEM > Reflex Reflector

INSTALLATION



1. REAR REFLEX REFLECTOR

Caution:

The muffler is extremely hot immediately after driving. Be wary of receiving burns from heated parts.

1. Install the reflex reflector.

2. REAR SIDE REFLEX REFLECTOR

1. Install the rear side reflex reflector.
2. Install the mud guard rear.  [Ref. to EXTERIOR/INTERIOR TRIM>Mud Guard>INSTALLATION.](#)
3. Install the rear wheels.  [Ref. to WHEEL AND TIRE SYSTEM>Tire and Wheel>INSTALLATION.](#)

LIGHTING SYSTEM > Door Switch

REMOVAL

1. Disconnect the ground terminal from battery sensor.  [Ref. to REPAIR CONTENTS>NOTE > BATTERY.](#)
2. Remove the door switch assembly.
 - (1) Remove the bolts, and pull out the door switch assembly toward you.

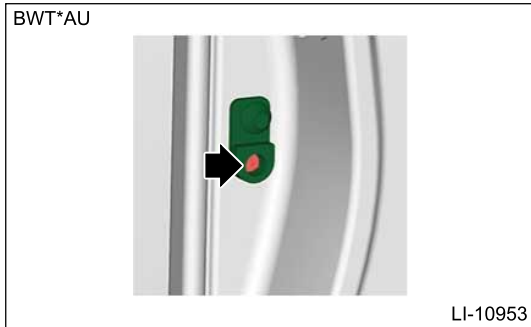

- (2) Disconnect the connector and remove the door switch assembly.

LIGHTING SYSTEM > Door Switch

INSTALLATION

1. Connect the connector and install the door switch assembly.

Tightening torque:
7.5 N·m (0.8 kgf-m, 5.5 ft-lb)
2. Connect the ground terminal to battery sensor.  [Ref. to REPAIR CONTENTS>NOTE > BATTERY.](#)

LIGHTING SYSTEM > Door Switch

INSPECTION

1. Measure the resistance between connector terminals.

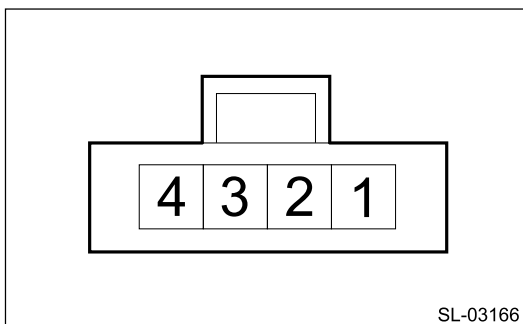

- Front

Terminal No.	Inspection conditions	Standard
2 – 1	When the switch is not pressed	Less than 1 Ω
	When the switch is pressed	1 MΩ or more

- Rear

Terminal No.	Inspection conditions	Standard
2 – 1	When the switch is not pressed	Less than 1 Ω

Terminal No.	Inspection conditions	Standard
	When the switch is pressed	1 MΩ or more

2. Replace the door switch assembly if the inspection result is not within the standard value.



WIPER AND WASHER SYSTEMS



-
1. General Description
 2. Relay and Fuse
 3. Wiper and Washer System
 4. Combination Switch (Wiper)
 5. Washer Tank and Motor
 6. Wiper Blade
 7. Front Wiper Arm
 8. Front Wiper Motor and Link
 9. Front Washer

WIPER AND WASHER SYSTEMS > General Description

CAUTION

- When performing service operation, refer to "Repair Contents" in "General Description".  [Ref. to REPAIR CONTENTS>Repair Contents.](#)
- When performing work on the sensors or modules, be careful of the following.
 - Before disconnecting connectors, be sure to disconnect the ground terminal from the battery sensor.  [Ref. to REPAIR CONTENTS>NOTE > BATTERY.](#)
 - Do not apply any impact. If the parts are accidentally dropped, replace with a new part.
 - Do not expose to high-temperature and humidity.
- When replacing the parts provided with memory functions, record the memory contents before disconnecting the ground terminal from the battery sensor.
- Refer to "CAUTION" of "General Description" in "AIRBAG SYSTEM" section.  [Ref. to AIRBAG SYSTEM>General Description>CAUTION.](#)
- When connecting the washer hoses, be careful not to cause bend or blockage.
- Do not let oil and grease adhere to the washer tank and washer fluid passage. Even a small amount of adherence will form an oil film on the glass, causing the wiper to chatter and judder.

WIPER AND WASHER SYSTEMS > General Description

SPECIFICATION

Front wiper motor	Motor type	Magnet type
	Input	12 V — 72 W or less
Front washer motor	Pump type	Centrifugal
	Input	12 V — 72 W or less

WIPER AND WASHER SYSTEMS > General Description

LOCATION

1. WIPER SYSTEM

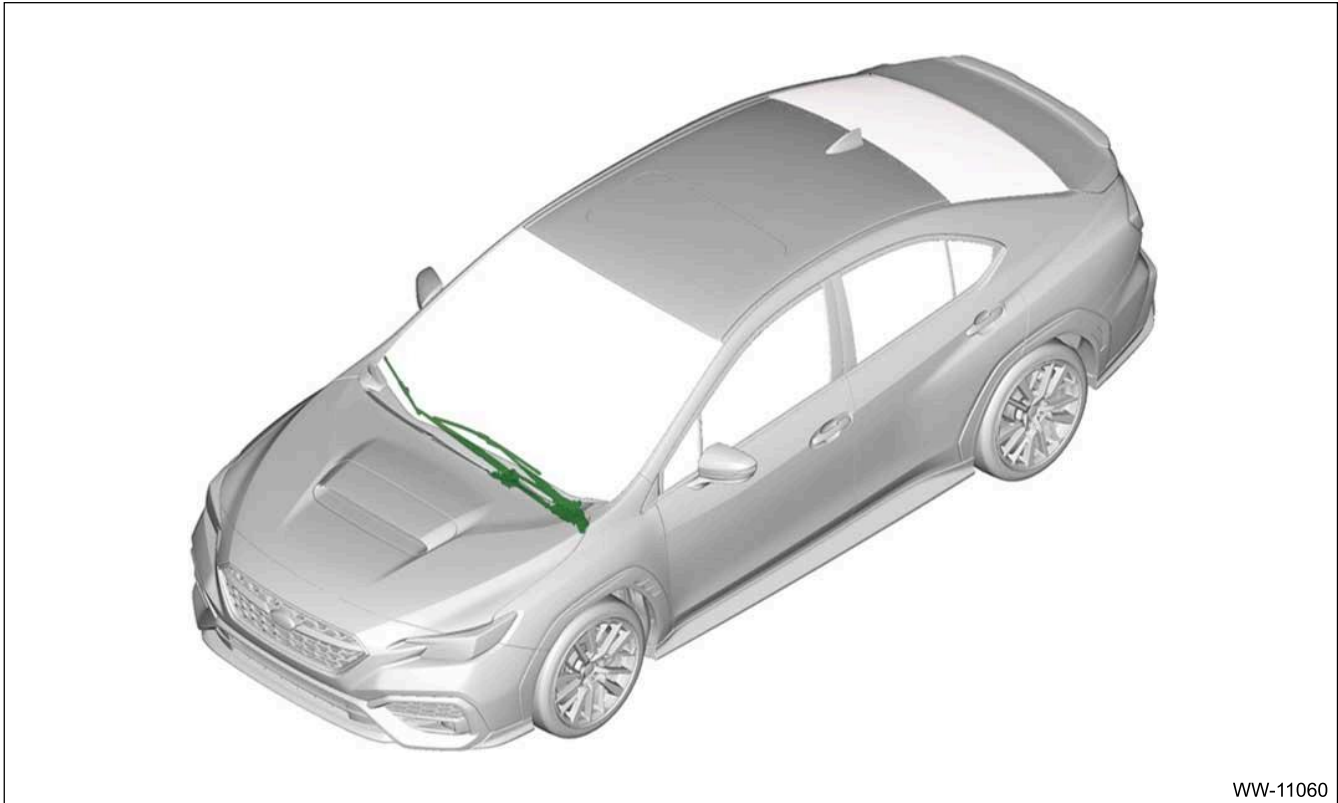

WW-11060

2. WASHER SYSTEM

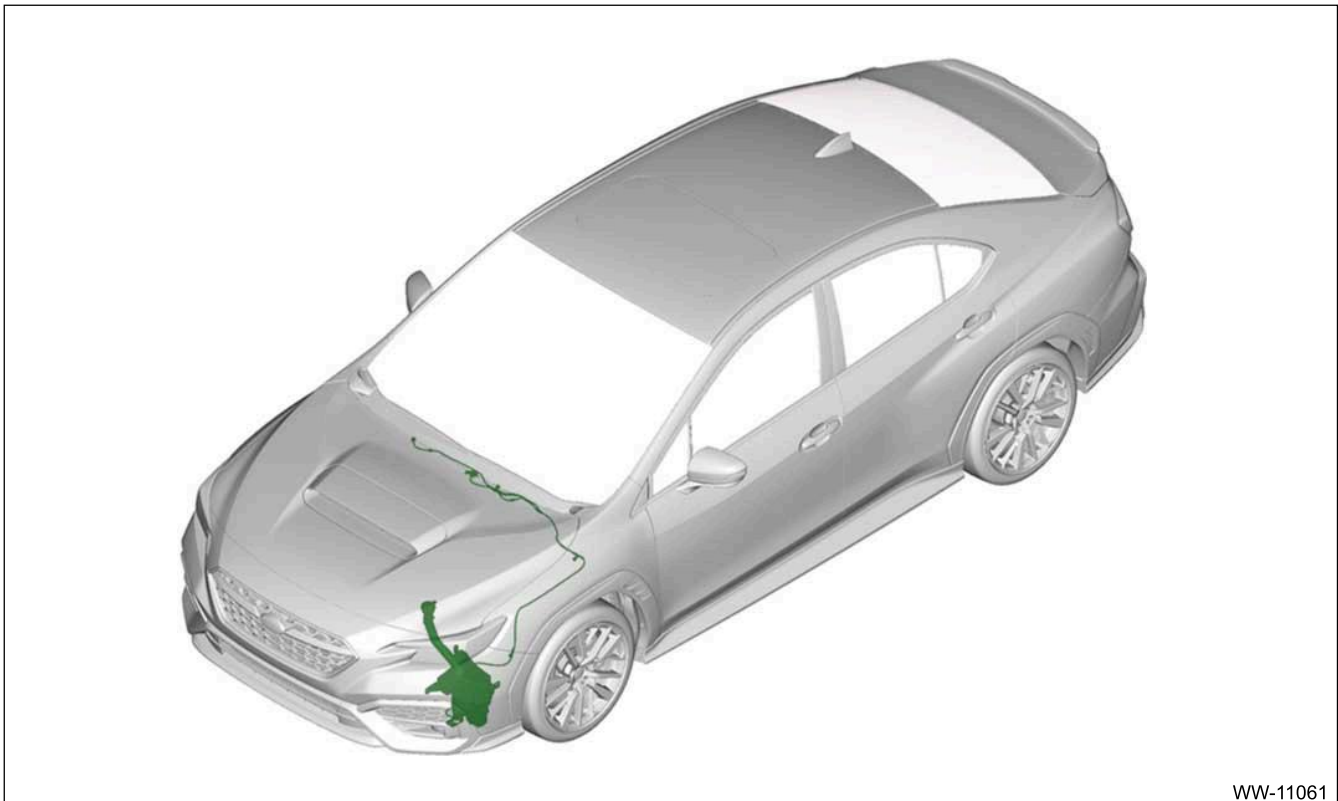

WW-11061

WIPER AND WASHER SYSTEMS > General Description

COMPONENT

1. FRONT WIPER

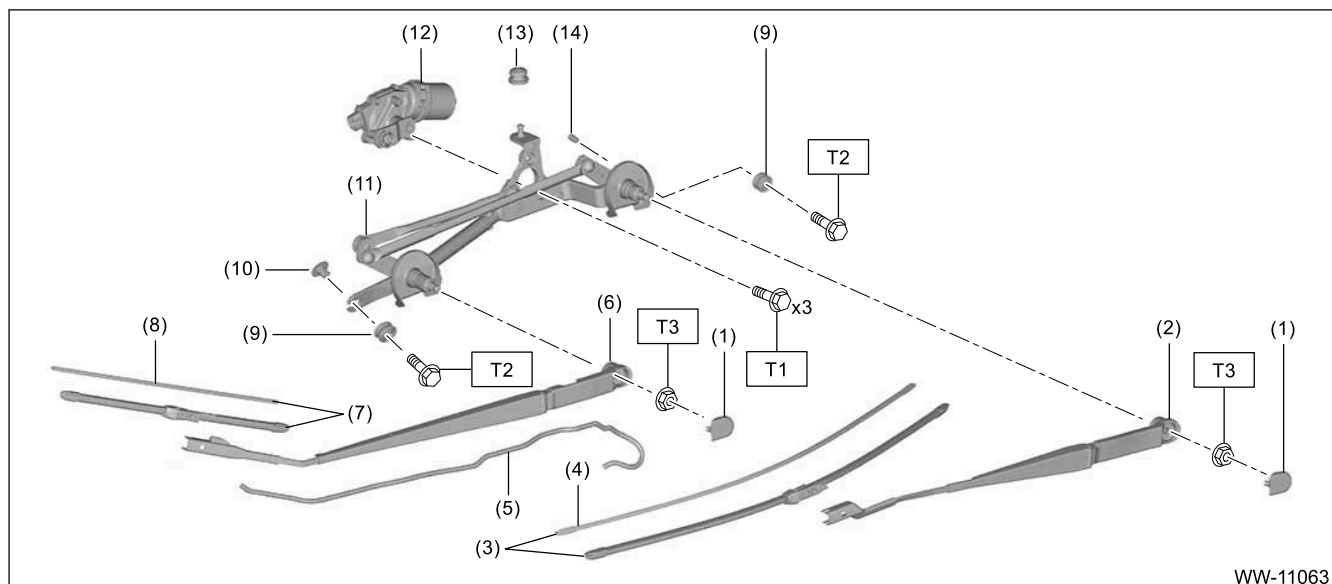

- | | | |
|--|--------------------------------------|--|
| (1) Cover windshield wiper arm | (8) Rubber windshield wiper assistor | Tightening torque: N·m (kgf-m, ft-lb) |
| (2) Arm ASSY windshield wiper driver | (9) Rubber | |
| (3) Blade ASSY windshield wiper driver | (10) Collar RH | T2: 6 (0.6, 4.4) |
| (4) Rubber windshield wiper driver | (11) Link ASSY windshield wiper | T3: 26 (2.7, 19.2) |
| (5) Hose wiper arm washer | (12) Motor ASSY windshield wiper | |
| (6) Arm ASSY windshield wiper assistor | (13) Cushion windshield wiper | |
| (7) Blade ASSY windshield wiper assistor | (14) Collar LH | |

2. WASHER TANK & HOSE

• WASHER TANK

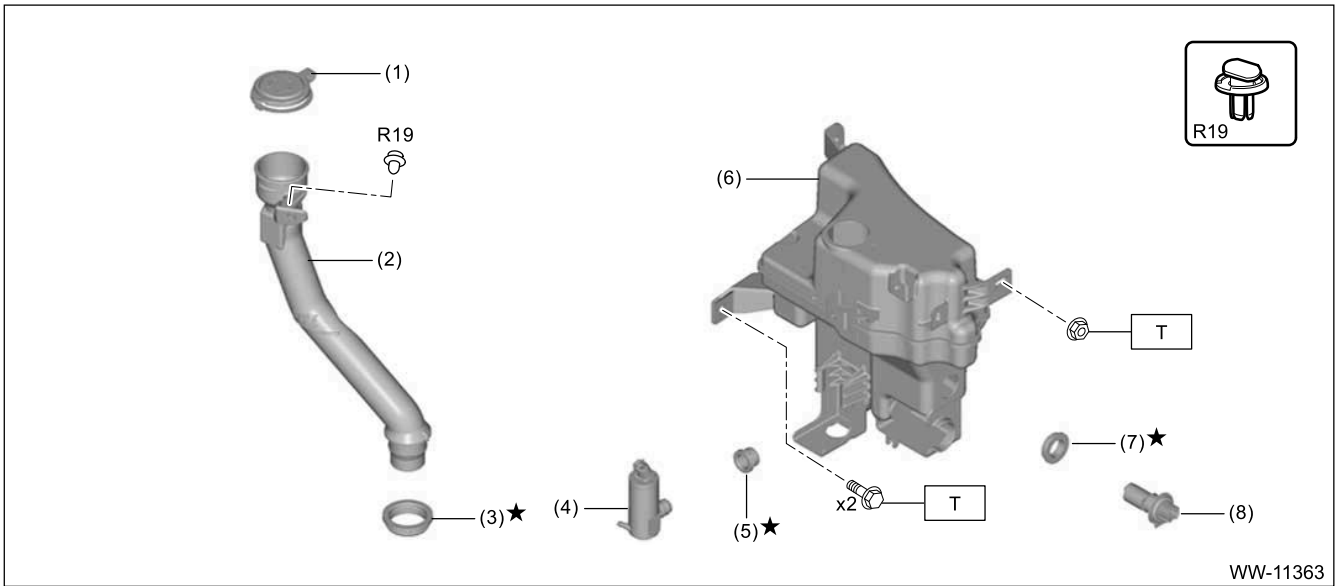

- | | |
|----------------------------|-------------------------------|
| (1) Cap washer tank | (5) Packing |
| (2) Hose inlet | (6) Tank washer |
| (3) Packing inlet | (7) Packing |
| (4) Motor pump ASSY washer | (8) Sensor washer fluid level |

Tightening torque: N·m (kgf·m, ft·lb)
T: 6 (0.6, 4.4)

● **FRONT WASHER HOSE**

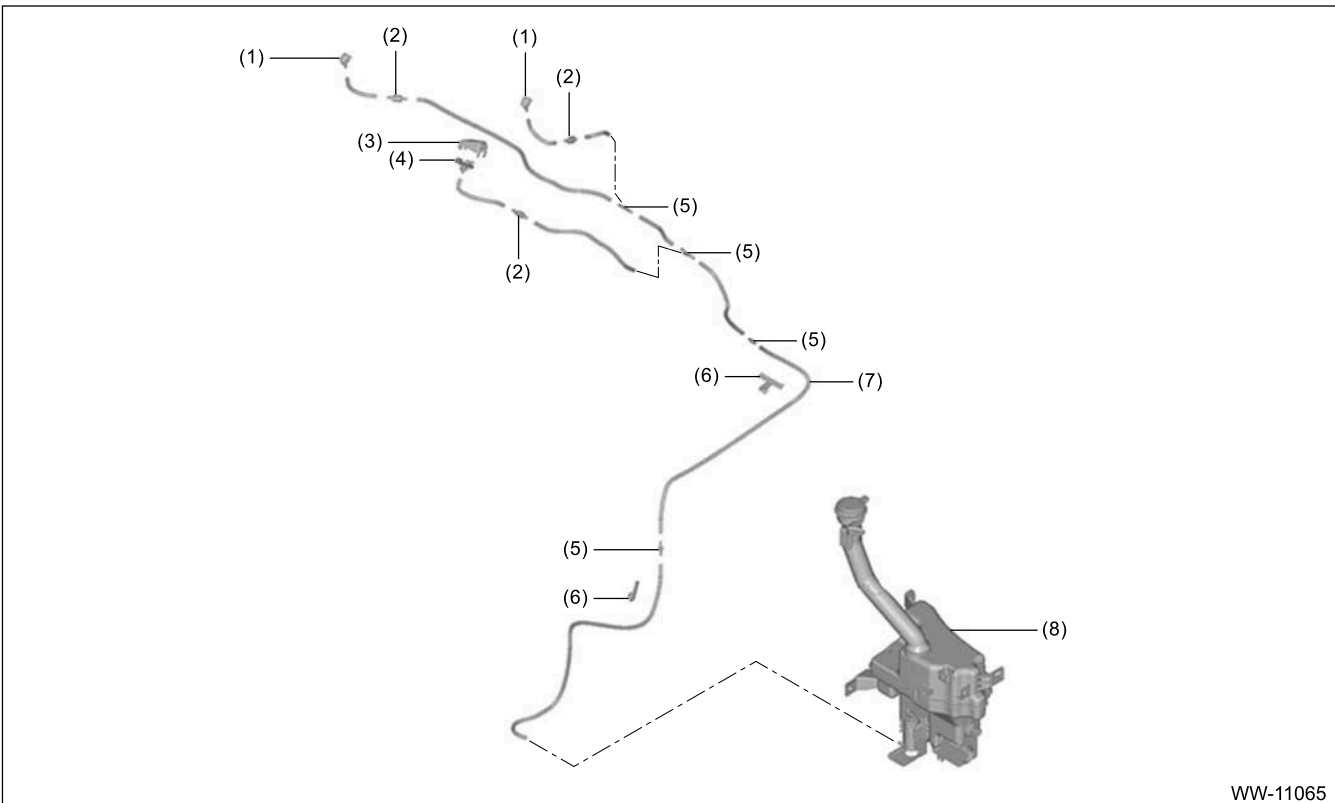

- | | | |
|-----------------------------------|-----------------------|---------------------------------|
| (1) Nozzle windshield washer | (4) Joint washer hose | (7) Hose ASSY windshield washer |
| (2) Check valve windshield washer | (5) Joint | (8) Washer tank ASSY |

(3) Cover joint

(6) Clip

WIPER AND WASHER SYSTEMS > General Description

PREPARATION TOOL

1. SUBARU SPECIAL TOOL

ILLUSTRATION	TOOL NUMBER	DESCRIPTION	REMARKS
 STSSM4	—	SUBARU SELECT MONITOR 4	Used for setting of each function and troubleshooting for electrical system. Note: <ul style="list-style-type: none">• For detailed operation procedures, refer to "Help" of application.• Used together with interface for Subaru Select Monitor (such as DST-i and DST-010).

2. OTHER

	REMARKS
Circuit tester	Used for measuring resistance, voltage and current.

3. HANDMADE TOOL

• WASHER NOZZLE ADJUSTMENT JIG

Note:

Refer to the data described below, prepare the materials to make a washer nozzle adjustment tool.

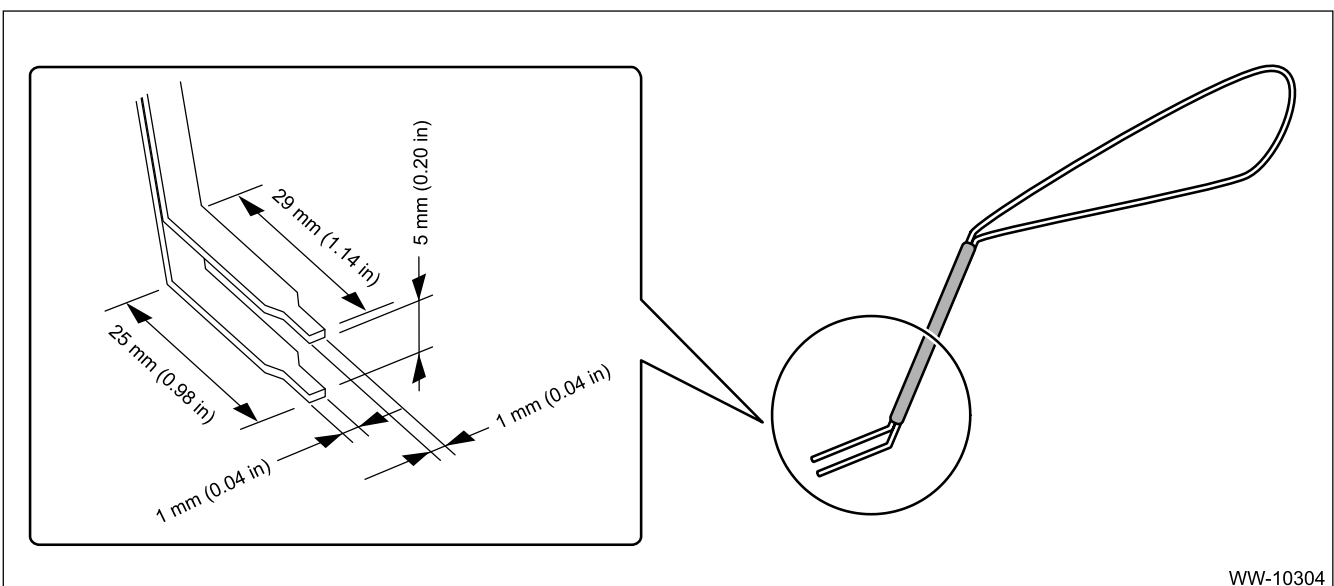

1. Prepare the vertebra of wiper blade which is to be discarded and vinyl tape.
2. Grind the vertebra edge until the width becomes 1 mm (0.04 in).

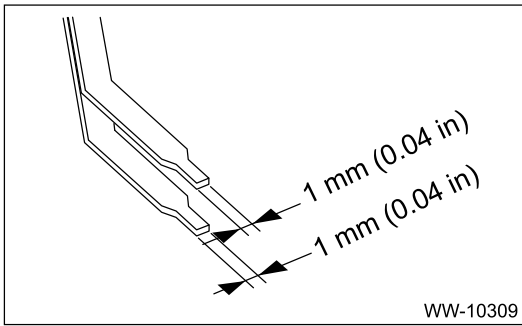

3. Bend the vertebra at the position 25 mm (0.98 in) away from its end by 45°.
4. Bend the vertebra at the position 29 mm (1.14 in) away from the other end by 45°.

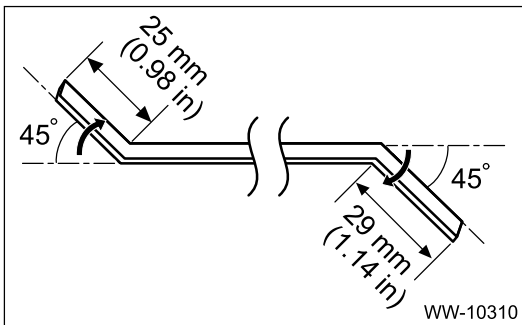

5. Double up the vertebra so that the longer end (29 mm (1.14 in)) comes upward.

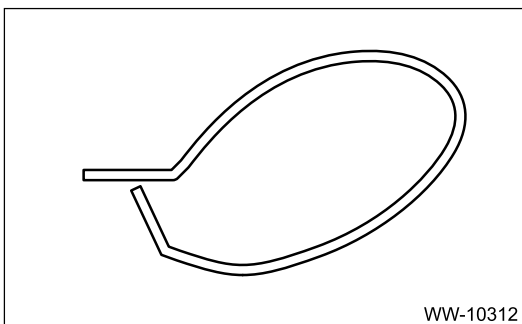
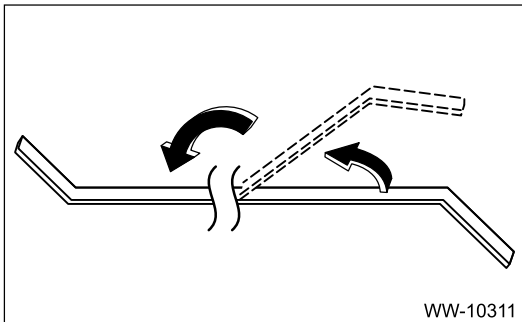

6. Secure the vertebra with a vise (a) so that the tip clearance between upper and lower becomes 5 mm (0.2 in).
7. Bend the vertebra at the position approximately 90 mm (3.54 in) away from the bending point for the longer end.

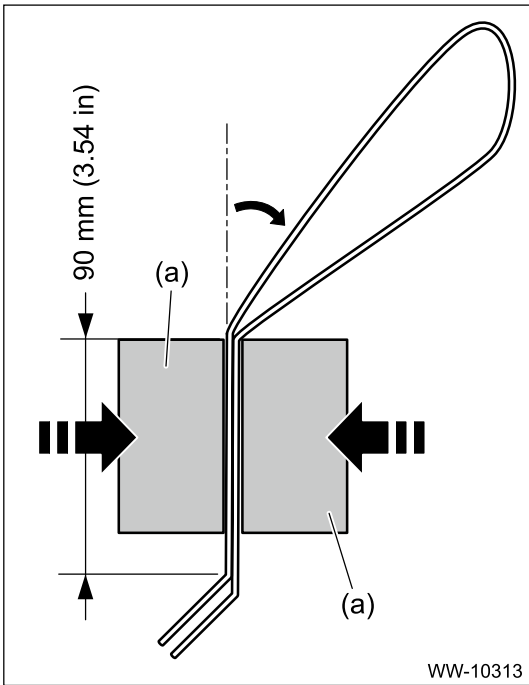

- 8.** Check that the tip clearance between upper and lower is 5 mm (0.2 in), and secure the vertebra with vinyl tape (b).

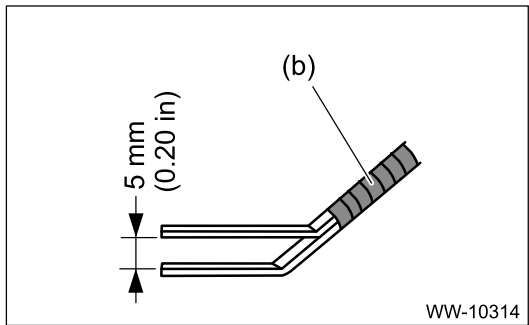

WIPER AND WASHER SYSTEMS > Relay and Fuse

LOCATION

For the location, refer to "FUSE AND RELAY" in the wiring diagram.  [Ref. to WIRING SYSTEM>Fuse And Relay.](#)

Note:

For details of relay and fuse, refer to "DC POWER SUPPLY CIRCUIT".  [Ref. to WIRING SYSTEM>Power Supply Circuit.](#)

WIPER AND WASHER SYSTEMS > Relay and Fuse

INSPECTION

1. CHECK FUSE

1. Remove the fuse and inspect visually.
2. If the fuse is blown out, replace the fuse.

WIPER AND WASHER SYSTEMS > Wiper and Washer System

WIRING DIAGRAM

For the wiring diagram, refer to "Front Wiper and Washer System" in the wiring diagram.  [Ref. to WIRING SYSTEM>Front Wiper and Washer System>WIRING DIAGRAM.](#)

WIPER AND WASHER SYSTEMS > Wiper and Washer System

INSPECTION







1. TROUBLE SYMPTOM

Symptoms	Repair order
Wiper and washers do not operate	<ol style="list-style-type: none">1. Wiper fuse2. Combination switch (wiper)3. Motor assembly wiper4. Wiring harness
Wipers do not operate in LO or HI	<ol style="list-style-type: none">1. Combination switch (wiper)2. Motor assembly wiper3. Wiring harness
Wipers do not operate in INT	<ol style="list-style-type: none">1. Combination switch (wiper)2. Motor assembly wiper3. Wiring harness
Washer motor does not operate	<ol style="list-style-type: none">1. Combination switch (wiper)2. Motor pump assembly washer3. Wiring harness
Wipers do not operate when washer switch is ON	<ol style="list-style-type: none">1. Motor assembly wiper2. Wiring harness
Washer fluid spray does not operate properly	<ol style="list-style-type: none">1. Motor pump assembly washer2. Hose assembly washer3. Nozzle washer
Wiper chatters or judders during operation	<ol style="list-style-type: none">1. Oil film and dirt on the glass2. Arm assembly wiper3. Motor assembly wiper

WIPER AND WASHER SYSTEMS > Wiper and Washer System

NOTE

For procedure of components of the wiper and washer system, refer to the sections below.

- Combination switch (wiper):  [Ref. to WIPER AND WASHER SYSTEMS>Combination Switch \(Wiper\).](#)
- Wiper blade:  [Ref. to WIPER AND WASHER SYSTEMS>Wiper Blade.](#)
- Front wiper arm:  [Ref. to WIPER AND WASHER SYSTEMS>Front Wiper Arm.](#)
- Front wiper motor and link:  [Ref. to WIPER AND WASHER SYSTEMS>Front Wiper Motor and Link.](#)
- Washer tank and motor pump:  [Ref. to WIPER AND WASHER SYSTEMS>Washer Tank and Motor.](#)
- Front washer:  [Ref. to WIPER AND WASHER SYSTEMS>Front Washer.](#)
- Front relay control module:  [Ref. to BODY CONTROL/COMMUNICATION SYSTEM>Front Relay Control Module.](#)



- Body integrated unit:  [Ref. to BODY CONTROL/COMMUNICATION SYSTEM>Body Integrated Unit.](#)

WIPER AND WASHER SYSTEMS > Combination Switch (Wiper)

REMOVAL

Caution:

Before handling the airbag system components, refer to "CAUTION" of "General Description" in "AIRBAG SYSTEM".  [Ref. to AIRBAG SYSTEM>General Description>CAUTION.](#)

1. Disconnect the ground terminal from the battery sensor, and wait for at least 60 seconds before starting work.  [Ref. to REPAIR CONTENTS>NOTE > BATTERY.](#)
2. Turn the steering wheel assembly to right and left, remove the screws, and remove the column cover assembly.  [Ref. to POWER ASSISTED SYSTEM \(POWER STEERING\)>Steering Column>REMOVAL.](#)
3. Remove the switch assembly combination wiper.
 - (1) Disconnect connectors.
 - (2) Press the claw (a), and remove the switch assembly combination wiper.

Caution:

Do not press the claws with excessive force. They may be damaged.

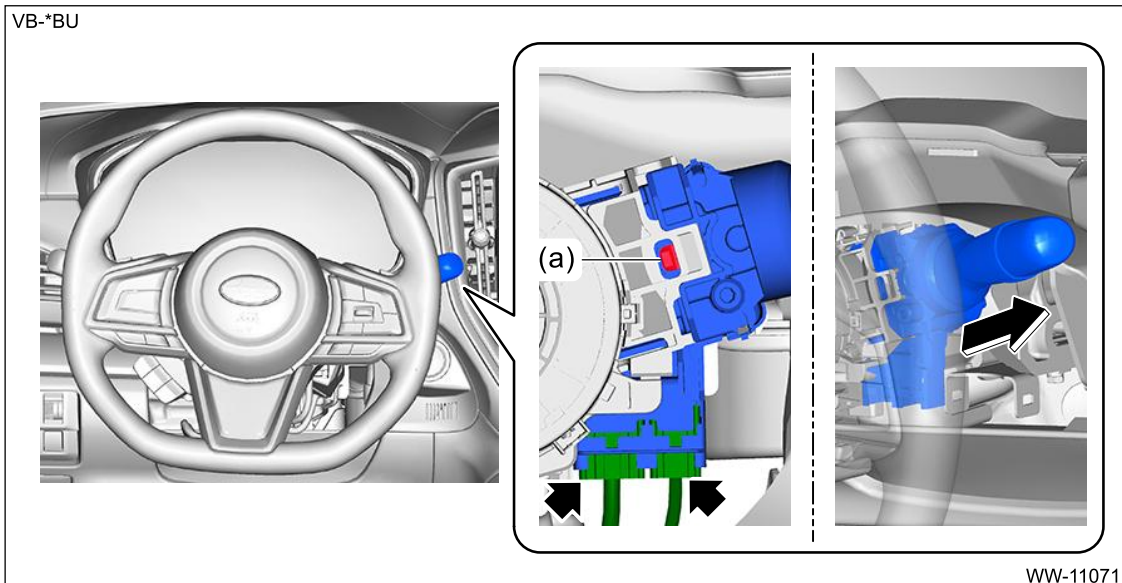



WIPER AND WASHER SYSTEMS > Combination Switch (Wiper)

INSTALLATION

Caution:

Before handling the airbag system components, refer to "CAUTION" of "General Description" in "AIRBAG SYSTEM".  [Ref. to AIRBAG SYSTEM>General Description>CAUTION.](#)

1. Install the switch assembly combination wiper, and connect each connector.
2. Install the column cover assembly.  [Ref. to POWER ASSISTED SYSTEM \(POWER STEERING\)>Steering Column>INSTALLATION.](#)
3. Connect the ground terminal to battery sensor.  [Ref. to REPAIR CONTENTS>NOTE > BATTERY.](#)

WIPER AND WASHER SYSTEMS > Combination Switch (Wiper)

INSPECTION

1. INSPECTION OF SWITCH UNIT

1. Measure the resistance between connector terminals.

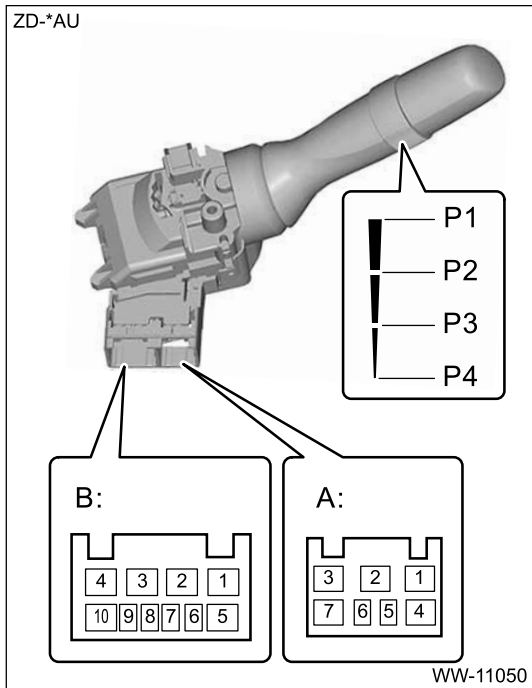

- Front switch

Terminal No.	Inspection conditions	Standard
B2 — B3	MIST	Less than 1 Ω
B2 — B4		Less than 1 MΩ
B1 — B3	OFF	Less than 1 Ω
B1 — B3	INT	Less than 1 Ω
B9 — B10		
B2 — B3	LO	Less than 1 Ω
B2 — B4	HI	Less than 1 Ω

- Washer switch

Terminal No.	Inspection conditions	Standard
A2 — A3	ON	Less than 1 Ω

- INT volume switch

Terminal No.	Inspection conditions	Standard
B7 — B8	P1	Less than 1 Ω
	P2	Approx. 2 kΩ
	P3	Approx. 4 kΩ
	P4	Approx. 6 kΩ

2. Replace the switch assembly combination wiper if the inspection result is not within the standard value.

2. CHECK INTERMITTENT OPERATION OF SWITCH

1. Turn the ignition switch to ON.

2. Operate the combination switch (wiper) to the INT position.
3. Check the stop duration during intermittent operation when intermittent control switch is in FAST and SLOW.

Intermittent stationary time

FAST: Approx. 2 seconds

SLOW: Approx. 16 seconds

- If faulty: Go to step 4.
 - If not faulty: Switch intermittent operation is normal.
4. Inspect the switch assembly combination wiper.
 - If faulty: Replace the switch assembly combination wiper.
 - If not faulty: Go to step 5.
 5. Check the harness.
 - If faulty: Repair or replace the defective part.
 - If not faulty: Replace the body integrated unit.

REMOVAL



1. WASHER TANK

1. Disconnect the ground terminal from battery sensor.  [Ref. to REPAIR CONTENTS>NOTE > BATTERY.](#)
2. Remove the bumper face front.  [Ref. to EXTERIOR/INTERIOR TRIM>Front Bumper>REMOVAL.](#)
3. Remove the screw and clips, and turn over the mud guard front LH.

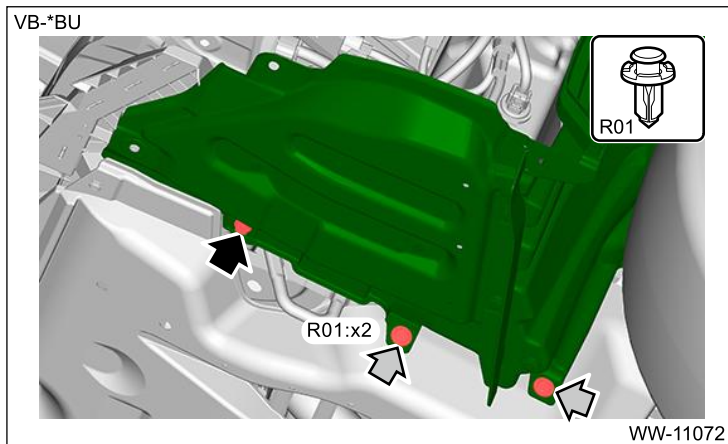

4. Remove the washer tank assembly.
(1) Remove the clip.

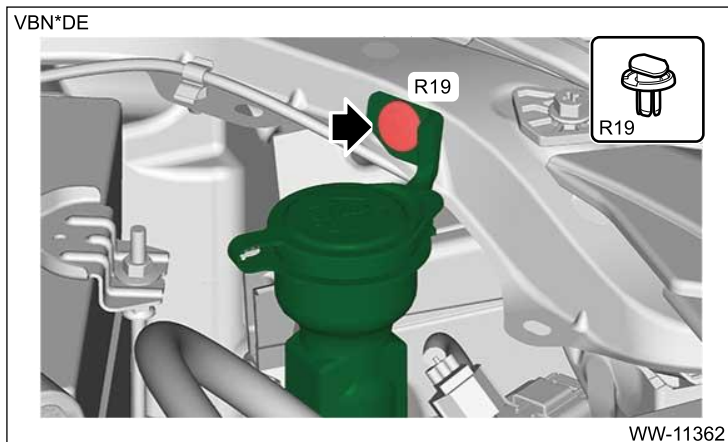

- (2) Disconnect the connector from the motor pump assembly washer and the sensor washer fluid level, and then remove the harness clip.
- (3) Prepare a container before disconnecting the hose assembly windshield washer, and drain all the washer fluid.

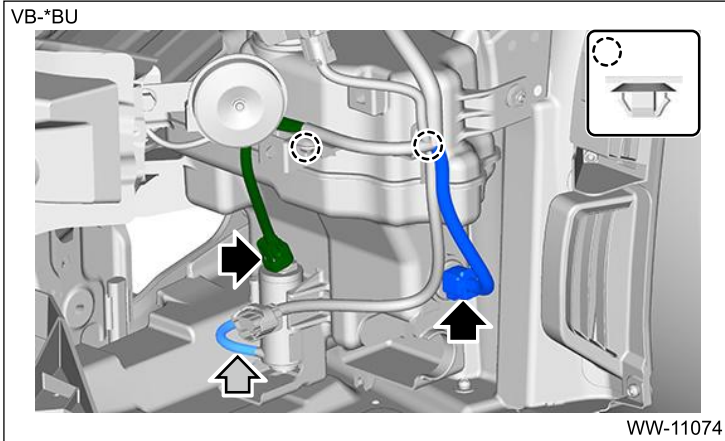

- (4) Disconnect the hose washer from the tank washer hose clamp.
- (5) Remove the bolt and nuts and remove the washer tank assembly.

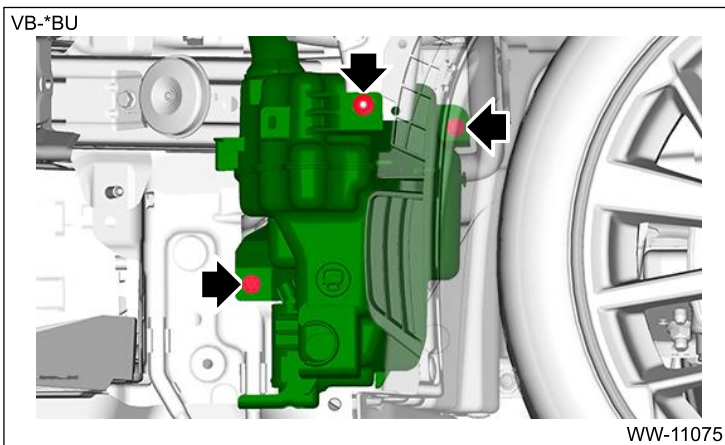

5. Remove the motor pump assembly washer and the sensor washer fluid level.

Note:

Perform this procedure only when required.

- Motor pump assembly washer: Ref. to [WIPER AND WASHER SYSTEMS>Washer Tank and Motor>REMOVAL > WASHER MOTOR PUMP.](#)
- Sensor washer fluid level: Ref. to [WIPER AND WASHER SYSTEMS>Washer Tank and Motor>REMOVAL > WASHER FLUID LEVEL SENSOR.](#)

2. WASHER MOTOR PUMP

1. Disconnect the ground terminal from battery sensor. Ref. to [REPAIR CONTENTS>NOTE > BATTERY.](#)
2. Remove the screw and clips, and turn over the mud guard front LH.

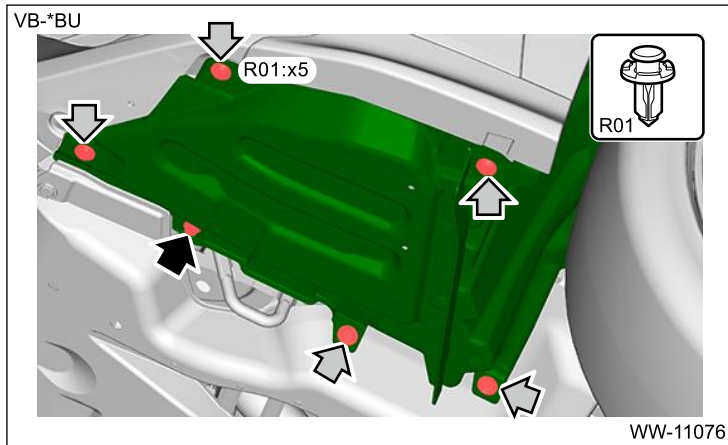

3. Remove the motor pump assembly washer.

- (1) Prepare a container before disconnecting the hose assembly windshield washer, and drain all the washer fluid.
- (2) Disconnect the connector, and remove the motor pump assembly washer.

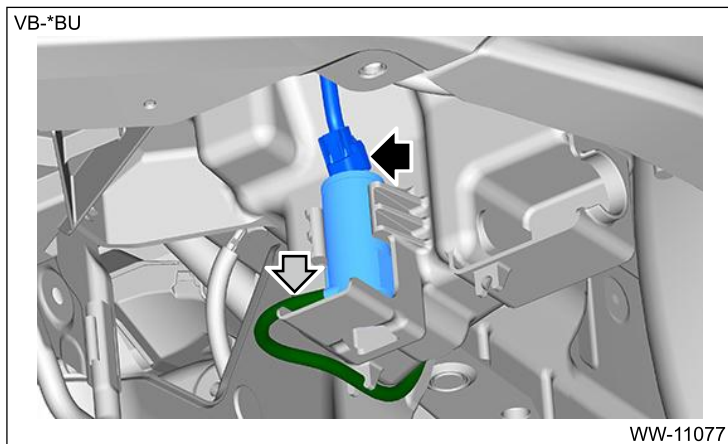

3. WASHER FLUID LEVEL SENSOR

- 1.** Disconnect the ground terminal from battery sensor. [🔧 Ref. to REPAIR CONTENTS>NOTE > BATTERY.](#)
- 2.** Remove the screw and clips, and turn over the mud guard front LH.

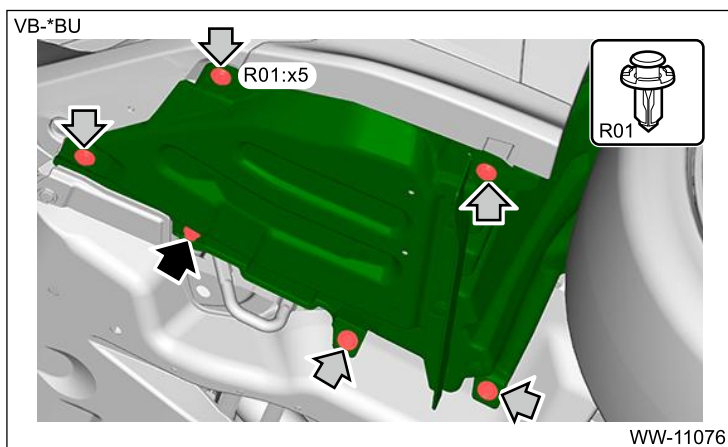

3. Remove the sensor washer fluid level.

- (1) Prepare a container before disconnecting the hose assembly windshield washer, and drain all the washer fluid.

(2) Disconnect the connector, and remove the sensor washer fluid level with a thick towel or the like.

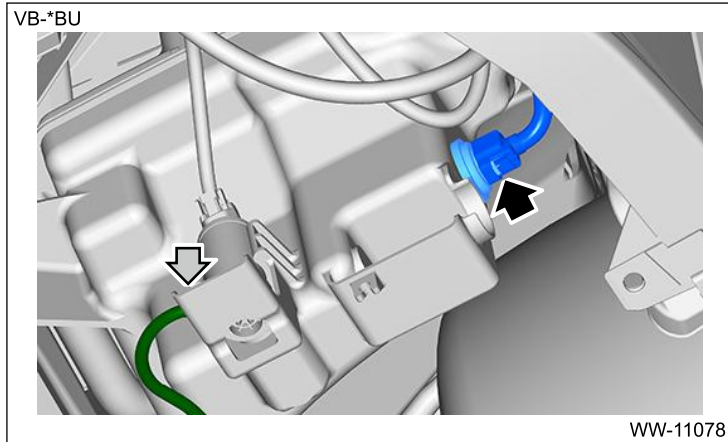

WIPER AND WASHER SYSTEMS > Washer Tank and Motor

INSTALLATION

1. WASHER TANK

Caution:

When the hose inlet assembly is removed, do not reuse the packing inlet. Align the alignment marks on the hose inlet and the tank washer before installation.

1. Install the motor pump assembly washer and the sensor washer fluid level.
 - Motor pump assembly washer: [🔗 Ref. to WIPER AND WASHER SYSTEMS>Washer Tank and Motor>INSTALLATION > WASHER MOTOR PUMP.](#)
 - Sensor washer fluid level: [🔗 Ref. to WIPER AND WASHER SYSTEMS>Washer Tank and Motor>INSTALLATION > WASHER FLUID LEVEL SENSOR.](#)
2. Install the washer tank assembly.

Tightening torque:
6 N·m (0.6 kgf-m, 4.4 ft-lb)
3. Connect the hose assembly windshield washer.
4. Connect each connector and install the harness clip.
5. Add new washer fluid.
6. Install the mud guard front LH. [🔗 Ref. to EXTERIOR/INTERIOR TRIM>Mud Guard>INSTALLATION.](#)
7. Install the bumper face front. [🔗 Ref. to EXTERIOR/INTERIOR TRIM>Front Bumper>INSTALLATION.](#)
8. Connect the ground terminal to battery sensor. [🔗 Ref. to REPAIR CONTENTS>NOTE > BATTERY.](#)

2. WASHER MOTOR PUMP

1. Using new packing, install the motor pump assembly washer.
2. Connect the hose assembly windshield washer.
3. Connect the connector.
4. Add new washer fluid.
5. Install the mud guard front LH. [🔗 Ref. to EXTERIOR/INTERIOR TRIM>Mud Guard>INSTALLATION.](#)
6. Connect the ground terminal to battery sensor. [🔗 Ref. to REPAIR CONTENTS>NOTE > BATTERY.](#)

3. WASHER FLUID LEVEL SENSOR

1. Install the sensor washer fluid level.

- (1) Using new packing, align the protrusion (a) of the sensor washer fluid level with a center position of double line marks (b) on the tank washer side, and push the flat surface (c) to install.

Caution:

- **Do not hit or apply any impact to the sensor washer fluid level when it is reused, because it has a poor resistance to impact.**
- **When the installation is difficult, apply washer fluid to the packing. Do not use silicone oil.**

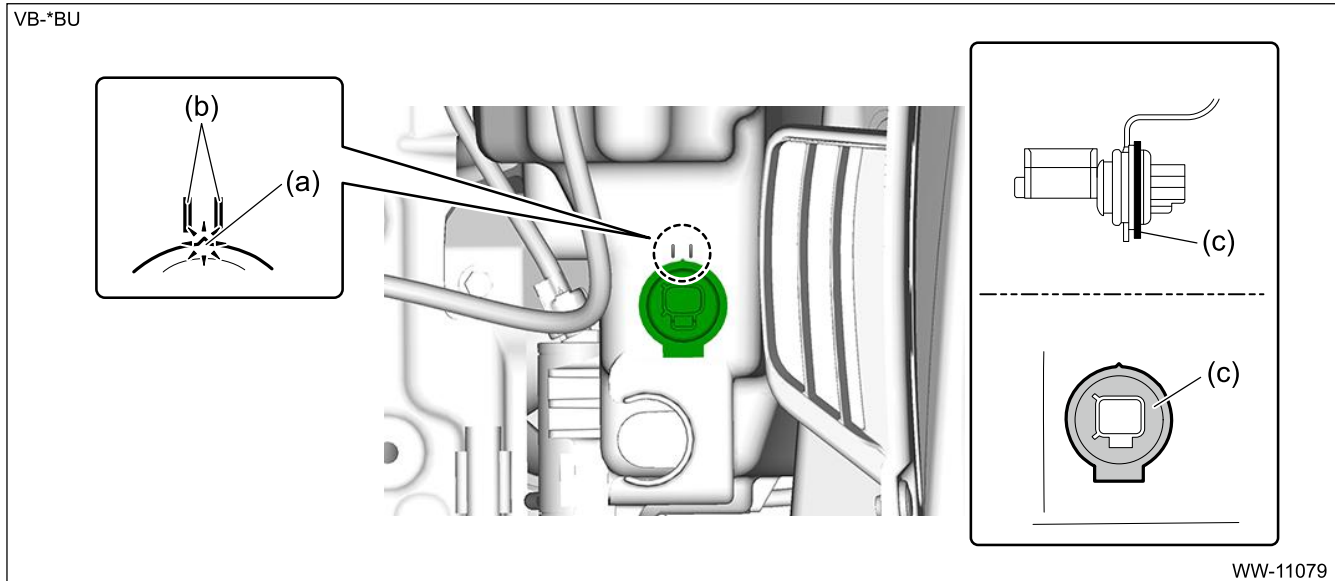

- (2) After installing the sensor washer fluid level, perform the following confirmations.

- There is no gap between the tank washer and the packing.
- There is no gap between the packing and the sensor washer fluid level.
- There is no turn over to the packing and its peripheral area.

2. Connect the hose assembly windshield washer.

3. Connect the connector.

4. Add new washer fluid.

5. Install the mud guard front LH.  [Ref. to EXTERIOR/INTERIOR TRIM>Mud Guard>INSTALLATION.](#)

6. Connect the ground terminal to battery sensor.  [Ref. to REPAIR CONTENTS>NOTE > BATTERY.](#)

WIPER AND WASHER SYSTEMS > Washer Tank and Motor

INSPECTION

1. WASHER MOTOR PUMP

- 1.** Check the motor operation when battery voltage is applied between the connector terminals.

VN-*AJ

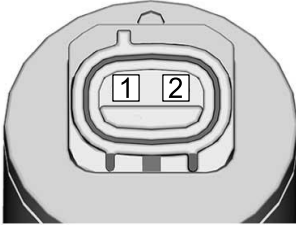

WW-10890

Terminal No.	Inspection conditions	Specification
1 (+) – 2 (-)	Apply battery voltage.	Rotation

2. If it does not operate normally, replace the motor pump assembly washer.

2. WASHER FLUID LEVEL SENSOR

Wiring diagram:

Front wiper and washer system  [Ref. to WIRING SYSTEM>Front Wiper and Washer System>WIRING DIAGRAM.](#)

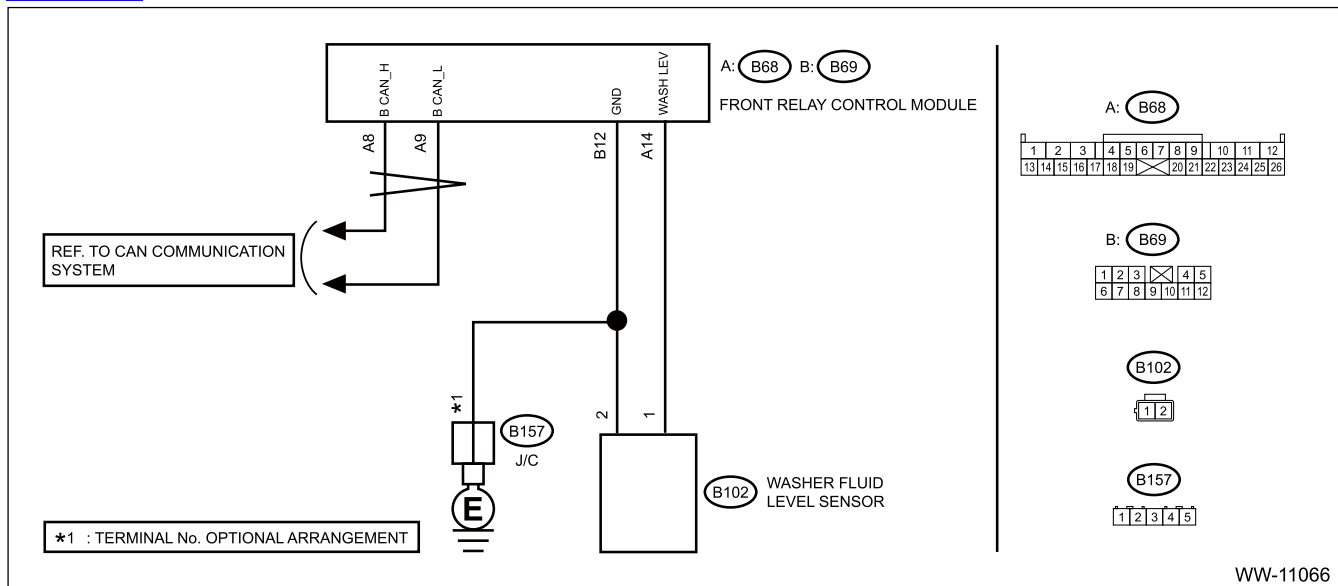

1. CHECK CONNECTION STATUS.

1. Turn over the mud guard front LH.
2. Check the connection status of the washer fluid level sensor connector.

Does the low washer fluid warning light illuminate after draining the washer fluid? And does the low washer fluid warning light go off after refilling the washer fluid?

 Yes

Washer fluid level sensor is normal.

 No

 [Go to 2.](#)

2. CHECK INPUT VOLTAGE.

1. Disconnect the washer fluid level sensor connector.
2. Measure the voltage between the washer fluid level sensor connector and chassis ground.

Connector & terminal

(B102) No. 1 (+) — Chassis ground (–):

Is the voltage approx. 8.5 V or more?

 Yes

 [Go to 3.](#)

 No

Check the harness, combination meter, and front relay control module, and repair or replace the defective parts.

3. CHECK WARNING LIGHT.

Short the washer fluid level sensor connector, and check the combination meter display.

Does the low warning light illuminate?

 Yes

 [Go to 4.](#)

 No

Check the combination meter and front relay control module, and repair or replace the defective parts.

4. CHECK WASHER FLUID LEVEL SENSOR.

Measure the resistance between the washer fluid level sensor terminals.

Terminals

No. 1 — No. 2:

Is the resistance within the following standard?

- No remaining amount of washer fluid in the tank (ON): Less than 10 Ω
- There is remaining amount of washer fluid in the tank (OFF): 1 M Ω or more

Yes

Check the connection status of the harness and connector that may have a temporary poor contact.

No

Replace the washer level sensor.  [Ref. to WIPER AND WASHER SYSTEMS>Washer Tank and Motor>REMOVAL > WASHER FLUID LEVEL SENSOR.](#)

WIPER AND WASHER SYSTEMS > Wiper Blade

REMOVAL

Caution:

When standing up the arm assembly windshield wiper, make sure to hold the arm portion. Holding the blade portion may cause the blade deformation due to warpage.

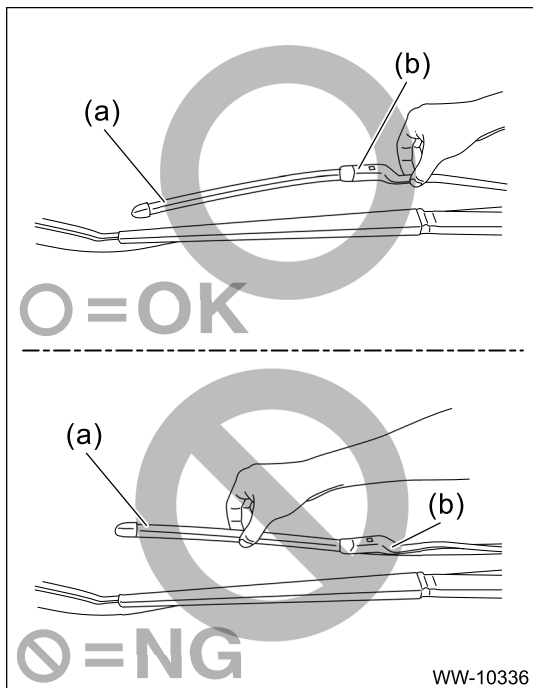

(a) Blade ASSY windshield wiper

(b) Arm ASSY windshield wiper

Note:

When standing up the arm assembly windshield wiper, perform the driver's side first in order not to interfere the arms with each other.

1. Press the lock button ①.
2. Pull the blade assembly windshield wiper in the arrow direction ② to remove the arm assembly windshield wiper.

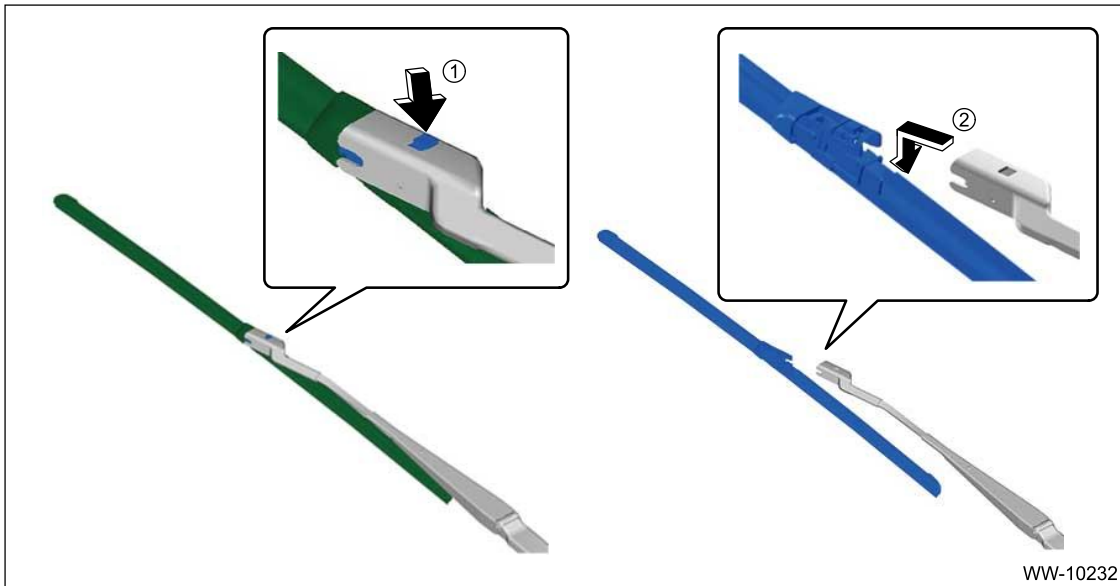

WIPER AND WASHER SYSTEMS > Wiper Blade

INSTALLATION

1. Align the protrusion section of arm inner and the groove on the blade side.

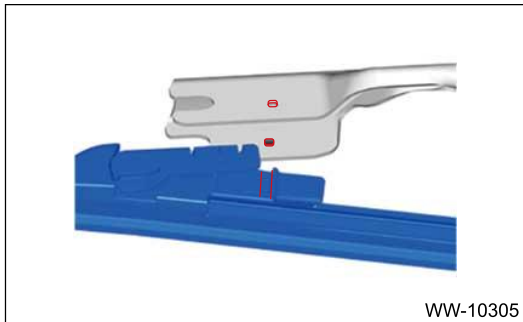

2. Slide until the lock button is locked and install the blade assembly windshield wiper.

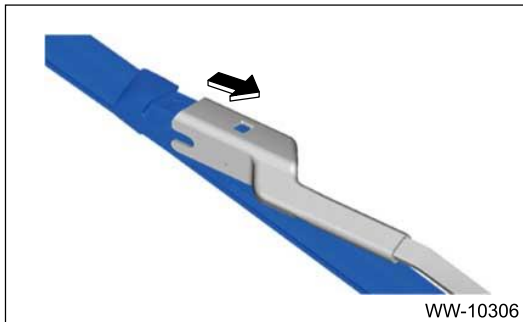

WIPER AND WASHER SYSTEMS > Wiper Blade

DISASSEMBLY

1. Hold the rubber windshield wiper, and pull it in the arrow ① direction to the slit position ② of the blade assembly windshield.
2. Pull out the rubber windshield wiper from the slit of the blade assembly windshield as shown in ③.

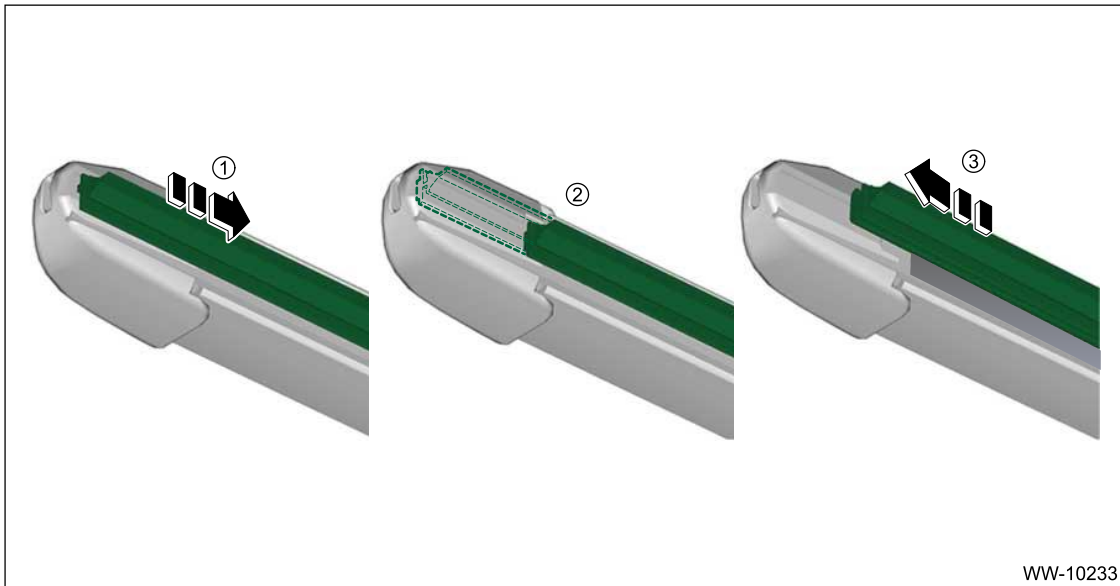

Note:

For an easier procedure, shorten the entire rubber windshield wiper in the arrow direction at three or four places.

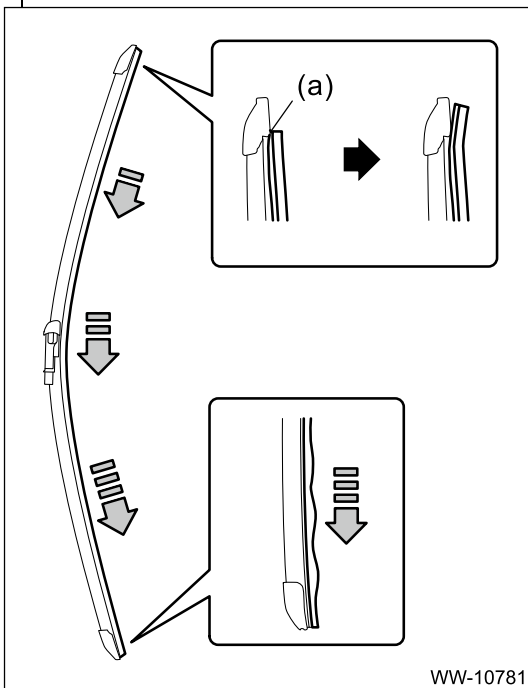

(a) Slit of blade ASSY windshield

WIPER AND WASHER SYSTEMS > Wiper Blade

ASSEMBLY

Install the rubber windshield wiper in the reverse order.

WIPER AND WASHER SYSTEMS > Wiper Blade

INSPECTION

1. Check and clean the rubber windshield wiper.

Caution:

- **Do not use organic solvent-based cleaner when cleaning rubber parts in order to avoid rubber part deterioration.**
- **Do not use the cleaner that includes silicone oil. Failure to do so can cause chattering sound.**
- **Clean rubber edge (a) using a soft cloth or a sponge dampened with washer fluid or mild synthetic detergent that is diluted two times or more. Wiping rubber lip (b) results in peeling of the black coating component, causing wiper chattering.**

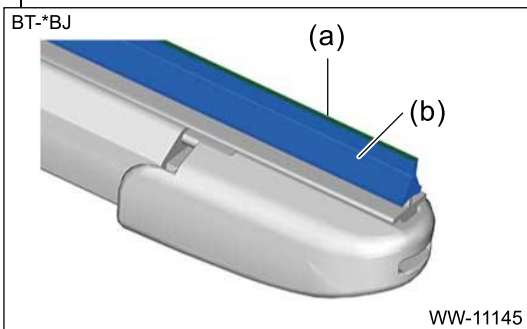

- **Check that the rubber is firmly attached after cleaning.**

Replace the rubber windshield wiper if rubber part hardening, deformation or damage is found.

2. Operate the washer system to check if a chattering sound or insufficient wiping occurs.

3. If a chattering sound or insufficient wiping occurs, perform the following procedures.

- (1) Make sure that the blade assembly windshield wiper is not deformed and the movable part moves smoothly.
- (2) Remove oil film and dirt from the glass.

Caution:

- **When powder-type glass cleaner is used, use after having been dissolved in water sufficiently. If it is used in less water, the glass surface may be damaged.**
- **Clean the glass surface using a soft cloth or sponge with glass cleaner.**

(3) Operate the wiper again. If a chattering sound or insufficient wiping occurs, perform the procedures again.

4. If defective is not improved after performing step 1 without replacing the rubber windshield wiper, replace the rubber windshield wiper with a new part.

5. If defective is still not improved after operating the washer system again, replace the blade assembly windshield wiper with a new part.

WIPER AND WASHER SYSTEMS > Front Wiper Arm

REMOVAL

1. Release the claw and remove the cover windshield wiper arm.

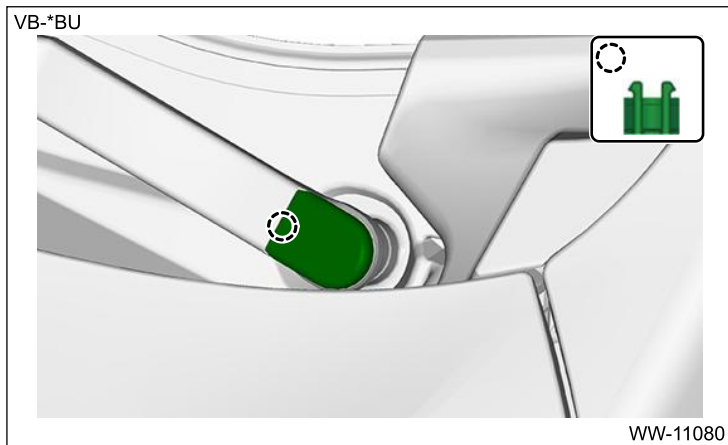

2. Remove the arm assembly windshield wiper.
 - (1) Remove the nuts, and remove the arm assembly windshield wiper.

Caution:

- Do not disconnect the hose wiper arm washer from the joint washer hose.
- When standing up the arm assembly windshield wiper, make sure to hold the arm portion. Holding the blade portion may cause the blade deformation.

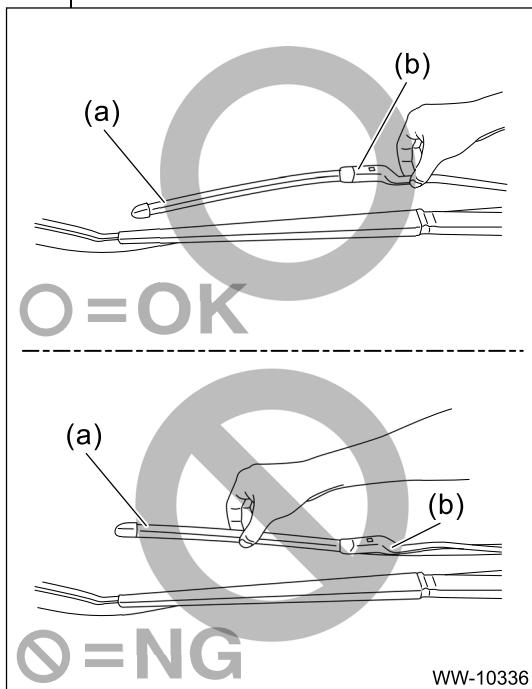

- (a) Blade ASSY windshield wiper
(b) Arm ASSY windshield wiper

Note:

When standing up the arm assembly windshield wiper, perform the driver's side first in order not to interfere the arms with each other.

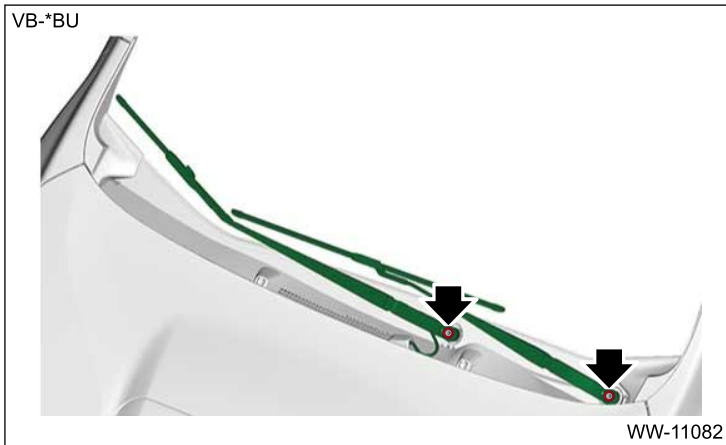

- (2) Put alignment marks (a) at two places on the arm assembly windshield wiper assistor and disconnect the hose wiper arm washer from the nozzle.

Caution:

Do not remove the nozzle from the arm assembly windshield wiper assistor. If nozzle replacement is required, replace the arm assembly windshield wiper assistor as a unit.

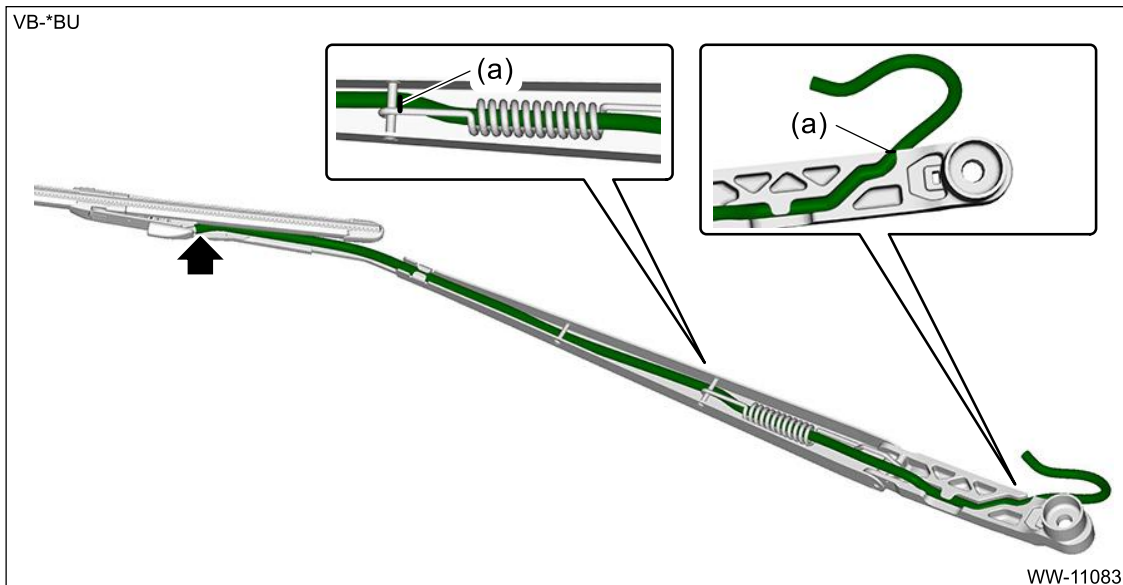

- (3) Pull out the hose wiper arm washer from the arm assembly windshield wiper assistor.

WIPER AND WASHER SYSTEMS > Front Wiper Arm

INSTALLATION

Note:

Since the arm assembly windshield wiper on the left and right sides can interfere with each other, install the passenger's side first.

- 1.** When the hose wiper arm washer is removed from the joint washer hose, refer to "INSTALLATION" of "Front Washer". [Ref. to WIPER AND WASHER SYSTEMS>Front Washer>INSTALLATION > WIPER ARM WASHER NOZZLE.](#)
- 2.** Install the arm assembly windshield wiper.

- (1) Align the alignment marks (a), and install the hose wiper arm washer to the arm assembly windshield wiper assistor.

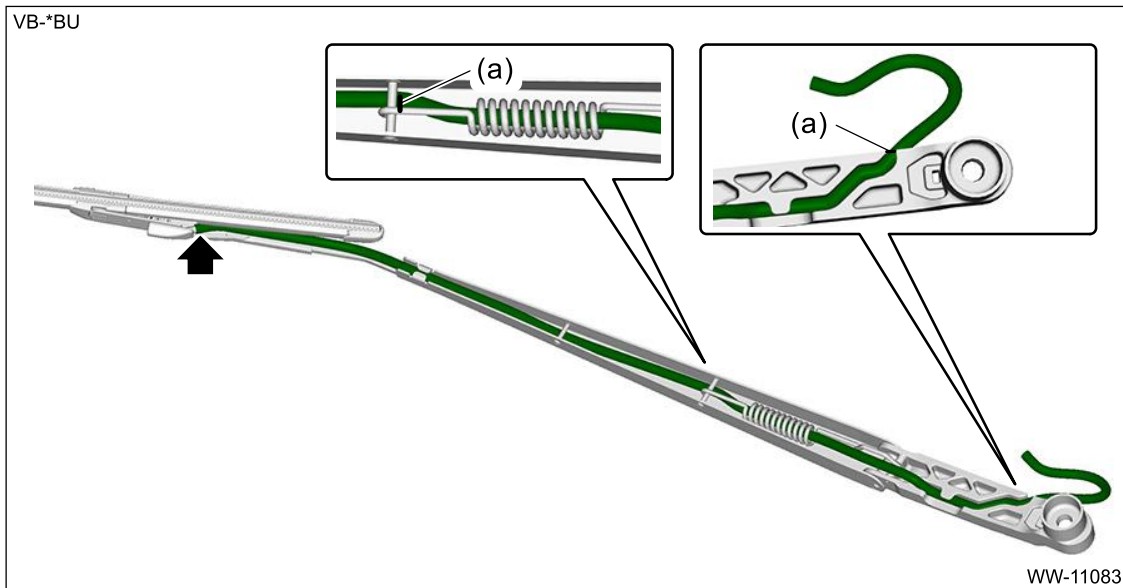

- (2) Align the blade assembly windshield wiper with the wiper set mark of the windshield glass to install the arm assembly windshield wiper.

Tightening torque:

26 N·m (2.7 kgf-m, 19.2 ft-lb)

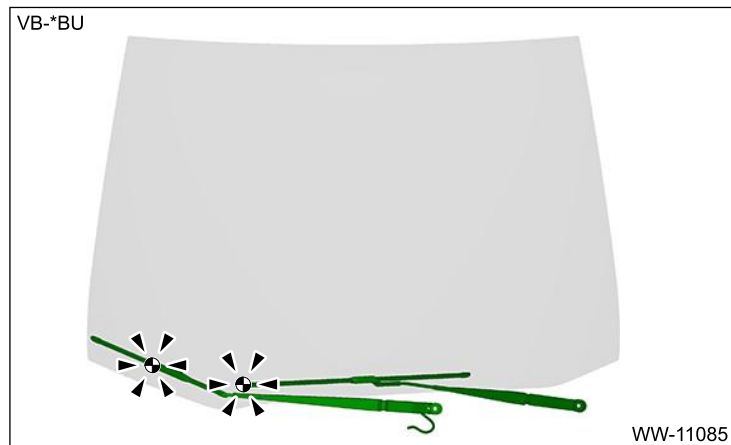

- 3.** Install the cover windshield wiper arm.
- 4.** Operate the windshield wiper once to check that the stop position is aligned with the wiper set mark.
- 5.** Make sure that the hose wiper arm washer and the cover joint do not interfere during windshield wiper operation.

VB-*BU

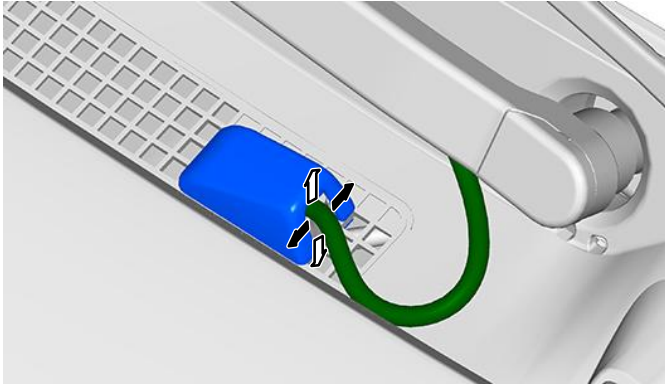

WW-11086



WIPER AND WASHER SYSTEMS > Front Wiper Arm

ADJUSTMENT

1. Operate the windshield wiper once.
2. If the stop position is not aligning with the wiper set mark, remove the arm assembly windshield wiper, and install by aligning with the wiper set mark.  [Ref. to WIPER AND WASHER SYSTEMS>Front Wiper Arm.](#)

WIPER AND WASHER SYSTEMS > Front Wiper Motor and Link

REMOVAL

1. Disconnect the ground terminal from battery sensor.  [Ref. to REPAIR CONTENTS>NOTE > BATTERY.](#)
2. Remove the arm assembly windshield wiper.  [Ref. to WIPER AND WASHER SYSTEMS>Front Wiper Arm>REMOVAL.](#)
3. Remove the cowl panel assembly.  [Ref. to EXTERIOR/INTERIOR TRIM>Cowl Panel>REMOVAL.](#)
4. Remove the link assembly windshield wiper.
 - (1) Remove the bolt.
 - (2) Slide the link assembly windshield wiper in the arrow direction to release the cushion windshield wiper and the body bracket.
 - (3) Disconnect the connector, and remove the link assembly windshield wiper.

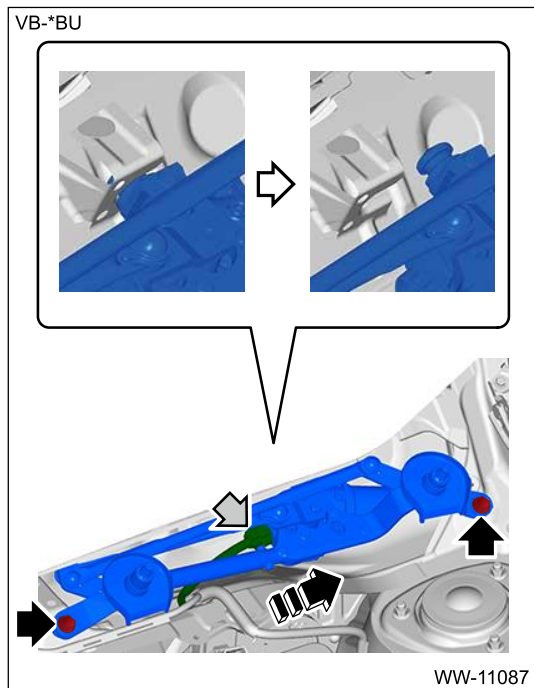

5. Remove the motor assembly windshield wiper.
 - (1) Using a crowbar wrapped with protective tape, disconnect the rod of the link assembly windshield wiper from the link plate.

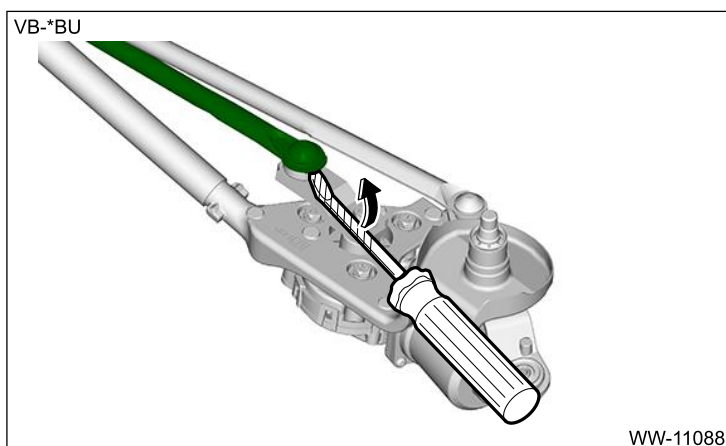

- (2) Using pliers, etc. wrapped with protection tape, pinch the link plate at the tool holding position (a), and turn the link plate clockwise until the installation bolt is seen.

Caution:

When turning the link plate, be careful not to let the tool contact the fixing portion (b) of the link plate.

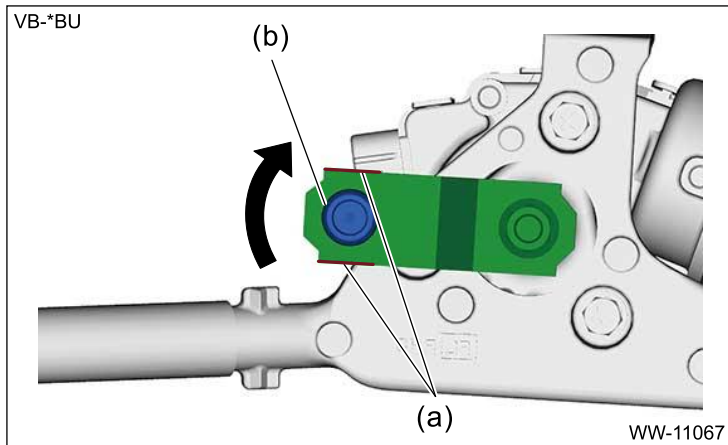

(3) Remove the bolts, and remove the motor assembly windshield wiper.

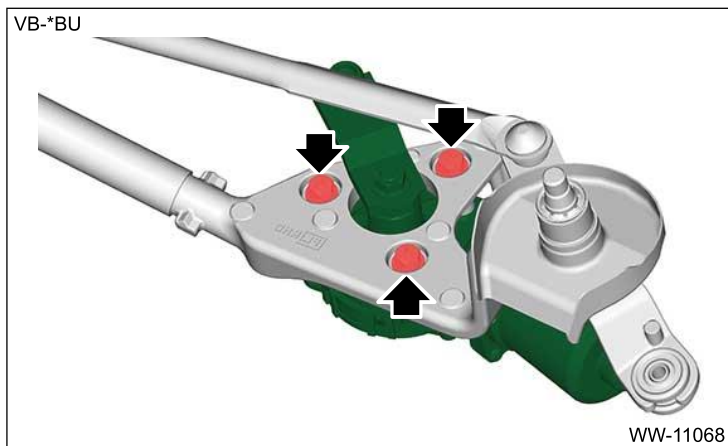

WIPER AND WASHER SYSTEMS > Front Wiper Motor and Link

INSTALLATION

1. Install the link assembly windshield wiper.
 - (1) Check the link plate position of the motor assembly windshield wiper. When the bolts cannot be installed, adjust the position by turning the link plate clockwise using pliers, etc. wrapped with protection tape.
 - (2) Install the motor assembly windshield wiper.

Tightening torque:
5.4 N·m (0.6 kgf-m, 4.0 ft-lb)
 - (3) Install the link assembly windshield wiper rod to the link plate.
 - (4) Connect the connector, and engage the cushion windshield wiper with the body bracket to install the link assembly windshield wiper.

Tightening torque:
6 N·m (0.6 kgf-m, 4.4 ft-lb)

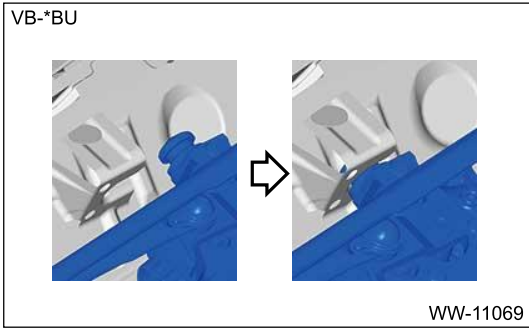

2. Connect the ground terminal to battery sensor. [Ref. to REPAIR CONTENTS>NOTE > BATTERY.](#)
3. Operate the front wiper switch of the switch assembly combination wiper once, and stop the motor assembly windshield wiper at the automatic stop position.
4. Install the cowl panel assembly. [Ref. to EXTERIOR/INTERIOR TRIM>Cowl Panel>INSTALLATION.](#)
5. Install the arm assembly windshield wiper. [Ref. to WIPER AND WASHER SYSTEMS>Front Wiper Arm>INSTALLATION.](#)

WIPER AND WASHER SYSTEMS > Front Wiper Motor and Link

INSPECTION

1. CHECK MOTOR OPERATION

1. Turn the front wiper switch of the switch assembly combination wiper to ON.
2. Turn the front wiper switch of the switch assembly combination wiper to OFF, and check that the motor stops at the automatic stop position.
3. Check or replace the front relay control module if it is found defective.
 - Inspection: [Ref. to FRONT RELAY CONTROL MODULE \(DIAGNOSTICS\)>Basic Diagnostic Procedure.](#)
 - Replacement: [Ref. to BODY CONTROL/COMMUNICATION SYSTEM>Front Relay Control Module.](#)

2. CHECK MOTOR UNIT

1. Check the motor operation when battery voltage is applied between the connector terminals.

Caution:

Fix the motor to prevent the motor from being shorted by moving during operation.

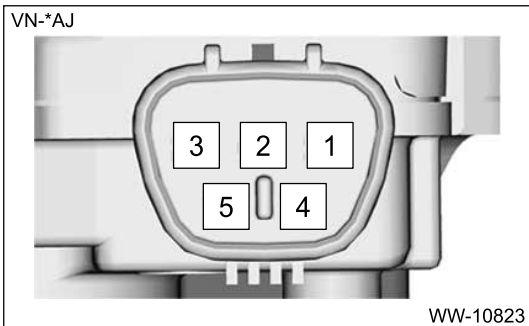

Terminal No.	Inspection conditions	Specification
5 (+) - 4 (-)	Apply battery voltage.	At low speed
3 (+) - 4 (-)		At high speed

2. If it does not operate normally, replace the motor assembly windshield wiper.

WIPER AND WASHER SYSTEMS > Front Washer

REMOVAL

1. WINDSHIELD WASHER NOZZLE

1. Remove the arm assembly windshield wiper. [🔗 Ref. to WIPER AND WASHER SYSTEMS>Front Wiper Arm>REMOVAL.](#)
2. Remove the cowl panel assembly. [🔗 Ref. to EXTERIOR/INTERIOR TRIM>Cowl Panel>REMOVAL.](#)
3. Remove the nozzle windshield washer.
 - (1) Release the claws as shown in the figure, using a flat tip screwdriver or similar tool wrapped with protection tape.

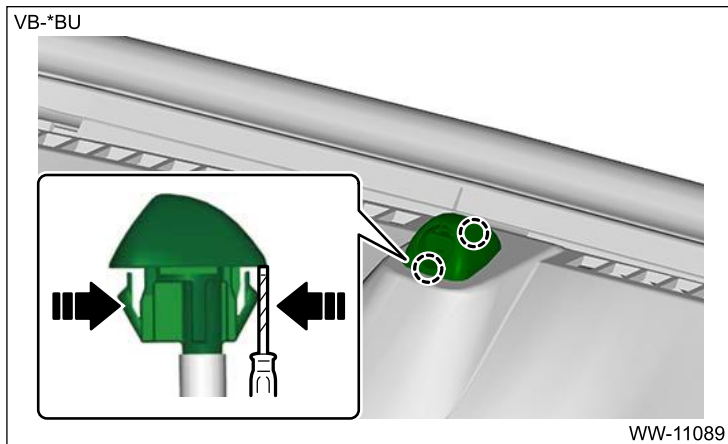

- (2) Pull out the nozzle windshield washer.
- (3) Remove the nozzle windshield washer from the hose assembly windshield washer.

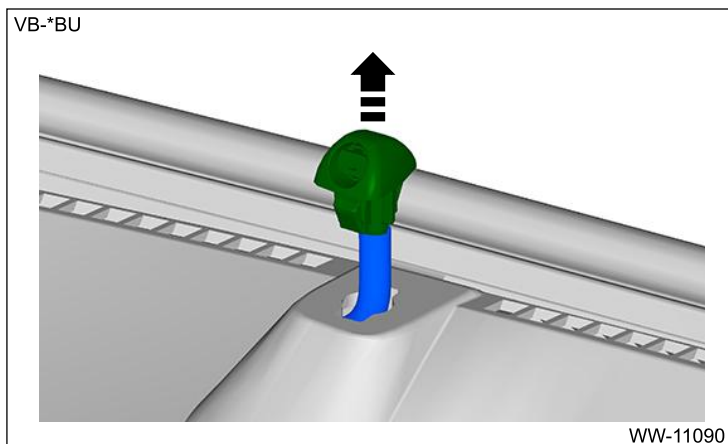

4. Remove the hose assembly windshield washer from the cowl panel assembly clamps, and disconnect it. [🔗 Ref. to WIPER AND WASHER SYSTEMS>General Description>LOCATION > WASHER SYSTEM.](#)

Note:

Perform this procedure only when required.

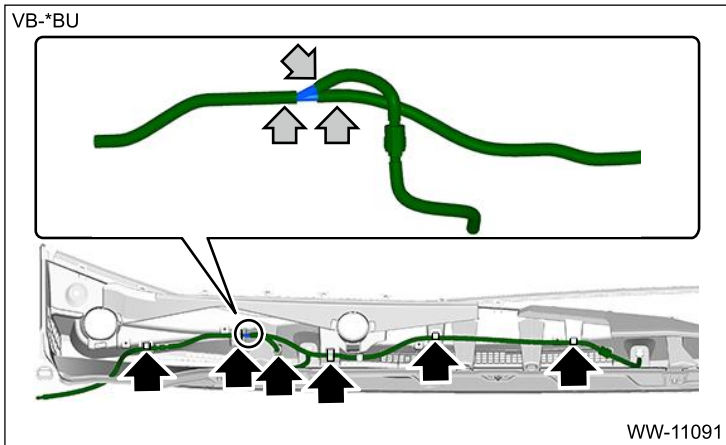

2. WIPER ARM WASHER NOZZLE

Caution:

Do not remove the nozzle from the arm assembly windshield wiper assistor. If nozzle replacement is required, replace the arm assembly windshield wiper assistor as a unit.

1. Remove the arm assembly windshield wiper. [Ref. to WIPER AND WASHER SYSTEMS>Front Wiper Arm>REMOVAL.](#)
2. Remove the cowl panel assembly. [Ref. to EXTERIOR/INTERIOR TRIM>Cowl Panel>REMOVAL.](#)
3. Release the claws, and then remove the cover joint.

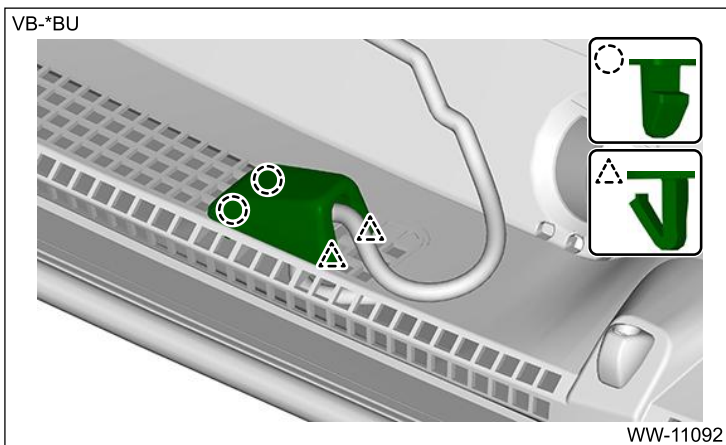

4. Remove the hose wiper arm washer from the joint washer hose.

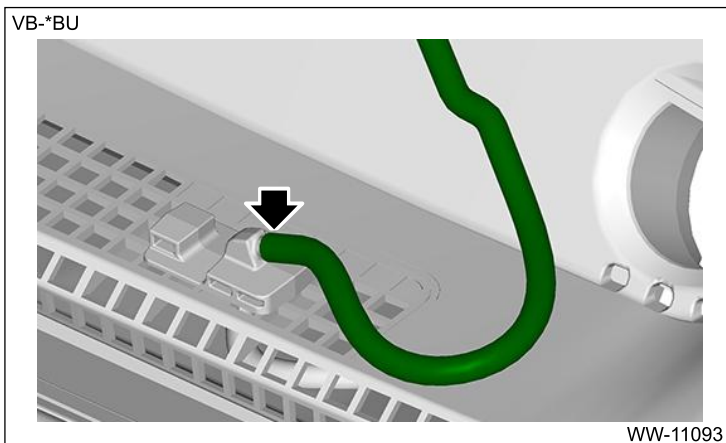

5. Remove the hose assembly windshield washer from the cowl panel assembly clamps, and disconnect it.

 [Ref. to WIPER AND WASHER SYSTEMS>General Description>LOCATION > WASHER SYSTEM.](#)

Note:



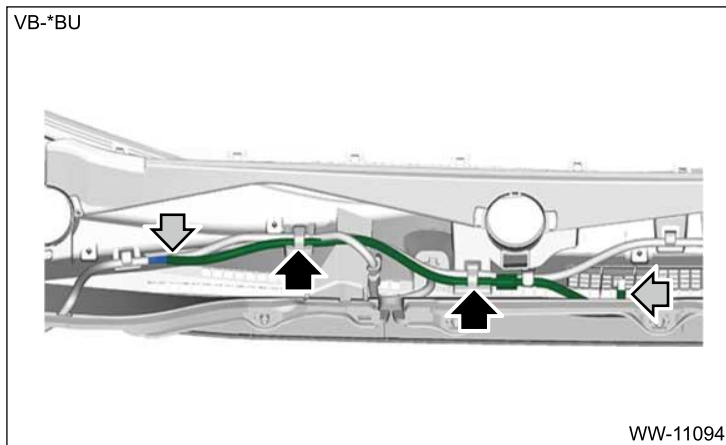

Perform this procedure only when required.







WIPER AND WASHER SYSTEMS > Front Washer

INSTALLATION

1. WINDSHIELD WASHER NOZZLE

1. Install the hose assembly windshield washer.  [Ref. to WIPER AND WASHER SYSTEMS>General Description>LOCATION > WASHER SYSTEM.](#)
2. Install the nozzle windshield washer.
 - (1) Connect the nozzle windshield washer to the hose assembly windshield washer.
 - (2) Install the nozzle windshield washer to the cowl panel assembly.
3. Install the cowl panel assembly.  [Ref. to EXTERIOR/INTERIOR TRIM>Cowl Panel>INSTALLATION.](#)
4. Install the arm assembly windshield wiper.  [Ref. to WIPER AND WASHER SYSTEMS>Front Wiper Arm>INSTALLATION.](#)
5. Check the position of the nozzle windshield washer.  [Ref. to WIPER AND WASHER SYSTEMS>Front Washer>INSPECTION > INSPECTING THE SPRAY POSITION.](#)

2. WIPER ARM WASHER NOZZLE

1. Install the hose assembly windshield washer.  [Ref. to WIPER AND WASHER SYSTEMS>General Description>LOCATION > WASHER SYSTEM.](#)
2. Install the hose wiper arm washer.
3. Install the cover joint.
4. Install the cowl panel assembly.  [Ref. to EXTERIOR/INTERIOR TRIM>Cowl Panel>INSTALLATION.](#)
5. Install the arm assembly windshield wiper.  [Ref. to WIPER AND WASHER SYSTEMS>Front Wiper Arm>INSTALLATION.](#)
6. Check the position of the nozzle windshield washer.  [Ref. to WIPER AND WASHER SYSTEMS>Front Washer>INSPECTION > INSPECTING THE SPRAY POSITION.](#)

WIPER AND WASHER SYSTEMS > Front Washer

INSPECTION

1. VISUAL INSPECTION

Check for the following items, and if any malfunction is found, replace the corresponding part.

- Make sure the nozzle windshield washer, hose assembly windshield washer and hose wiper arm washer are not clogged.
- Make sure the hose assembly windshield washer and hose wiper arm washer are not bent.

2. INSPECTING THE SPRAY POSITION

• WINDSHIELD WASHER NOZZLE

1. Turn the front wiper switch of the switch assembly combination wiper to the OFF position.
2. While the vehicle is running, check that the washer spray position is as shown in the figure.
 - (1) Route a piece of string or similar from the outside of the glass so that it passes through the center of the inner mirror mounting portion and the center of the sunload sensor, and then fix it on the glass with adhesive tape.
 - (2) Make adjustment marks shown in the figure using a water-based pen.
 - (3) Remove the string or similar, then spray washer fluid.

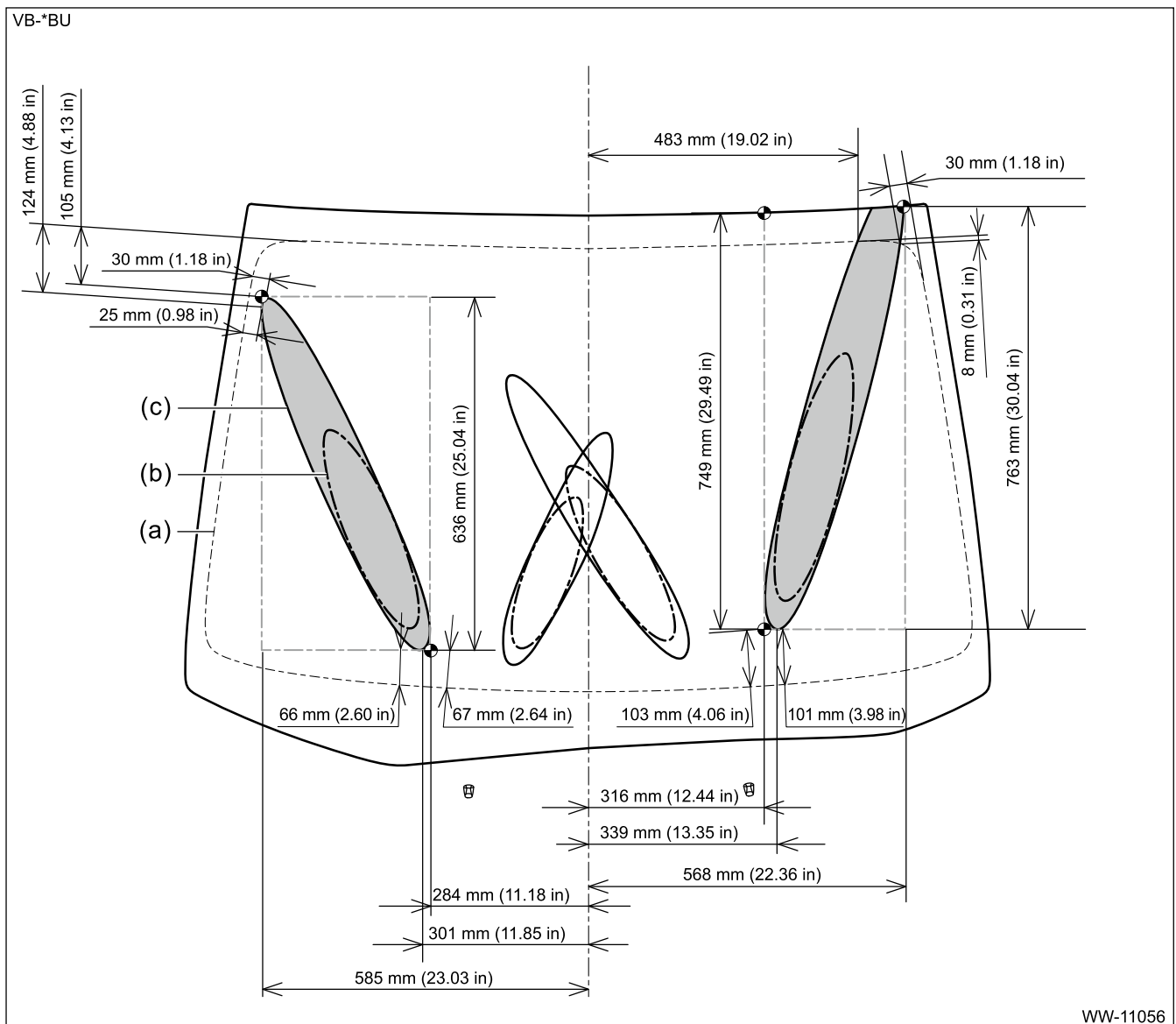

(a) Ceramic line

(b) Standard range

(c) Spray area

3. After inspection, if the spray position is significantly out of the specified range, adjust the nozzle windshield washer.
- (1) Create the washer nozzle adjustment tool. [🔗 Ref. to WIPER AND WASHER SYSTEMS>General Description>PREPARATION TOOL > HANDMADE TOOL.](#)
 - (2) Insert the washer nozzle adjustment tool (a) into the upper side (b) and lower side (c) of the nozzle windshield washer, and adjust the spray position.

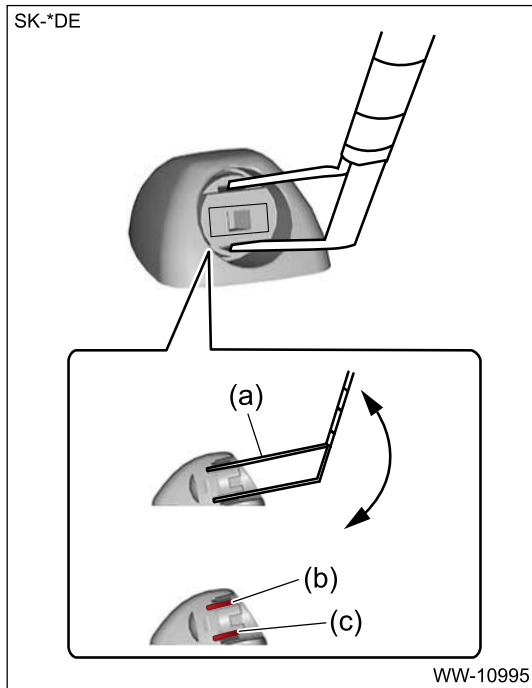

Caution:

Washer nozzle is made of resin. Do not insert the precision screwdriver (a) or equivalent into the discharge port. If it is inserted, the discharge port can be deformed, and washer fluid cannot be sprayed.

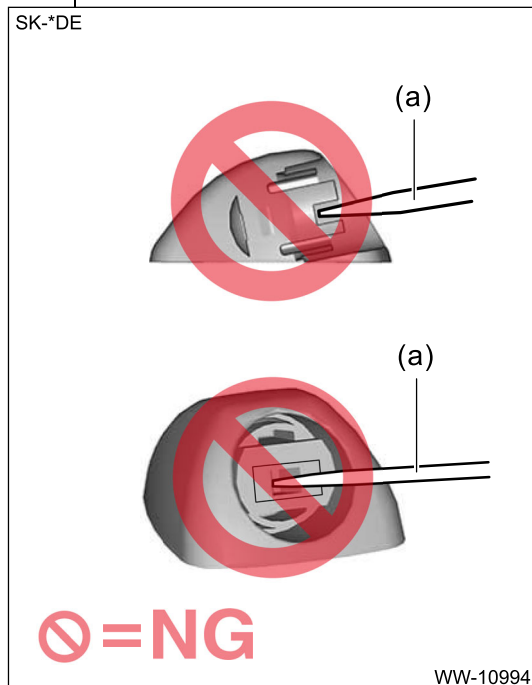

(3) When the spray position cannot be adjusted, replace the nozzle windshield washer.

4. When adjustment is completed, thoroughly clean the glass.

● **WIPER ARM WASHER NOZZLE**

1. Turn the front wiper switch of the switch assembly combination wiper to the OFF position.

2. While the vehicle is running, check that the washer spray position is as shown in the figure.

Caution:
Check the spray position of the washer nozzle at the position where the wiper arm stops.

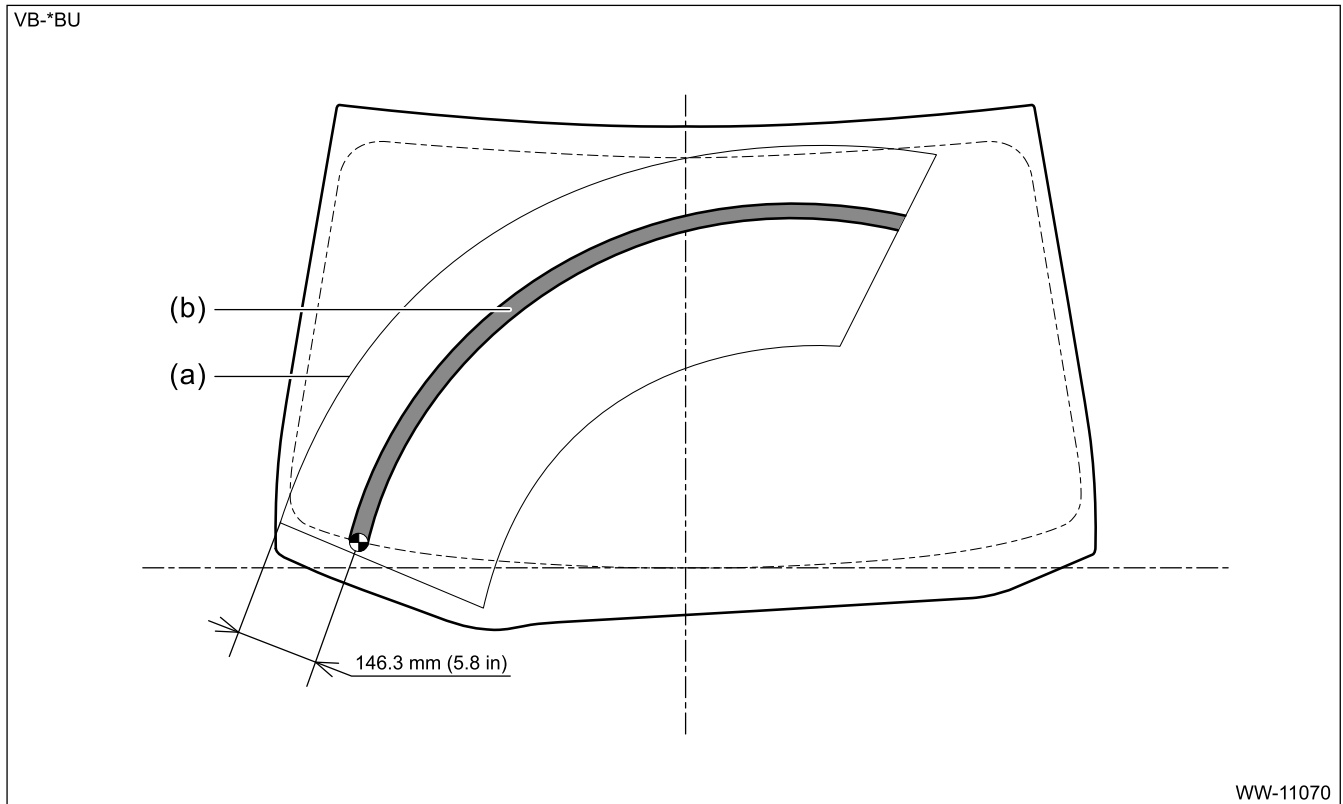

(a) Wiping area of arm ASSY windshield wiper assistor (b) Spray area

3. After inspection, if the spray position is really out of the specified range, replace the arm assembly windshield wiper assistor.

4. Thoroughly clean the glass.

HORN

HORN

1. General Description
2. Relay and Fuse
3. Horn System
4. Horn
5. Horn Switch

HORN > General Description

CAUTION

- When performing service operation, refer to "Repair Contents" in "General Description". [🔗 Ref. to REPAIR CONTENTS>Repair Contents.](#)
- When performing work on the sensors or modules, be careful of the following.
 - Before disconnecting electrical connectors, be sure to disconnect the ground terminal from the battery sensor. [🔗 Ref. to REPAIR CONTENTS>NOTE > BATTERY.](#)
 - Do not apply any impact. If the parts are accidentally dropped, replace them.
 - Do not expose to high-temperature and humidity.
- Refer to "CAUTION" of "General Description" in "AIRBAG SYSTEM" section. [🔗 Ref. to AIRBAG SYSTEM>General Description>CAUTION.](#)

HORN > General Description

COMPONENT

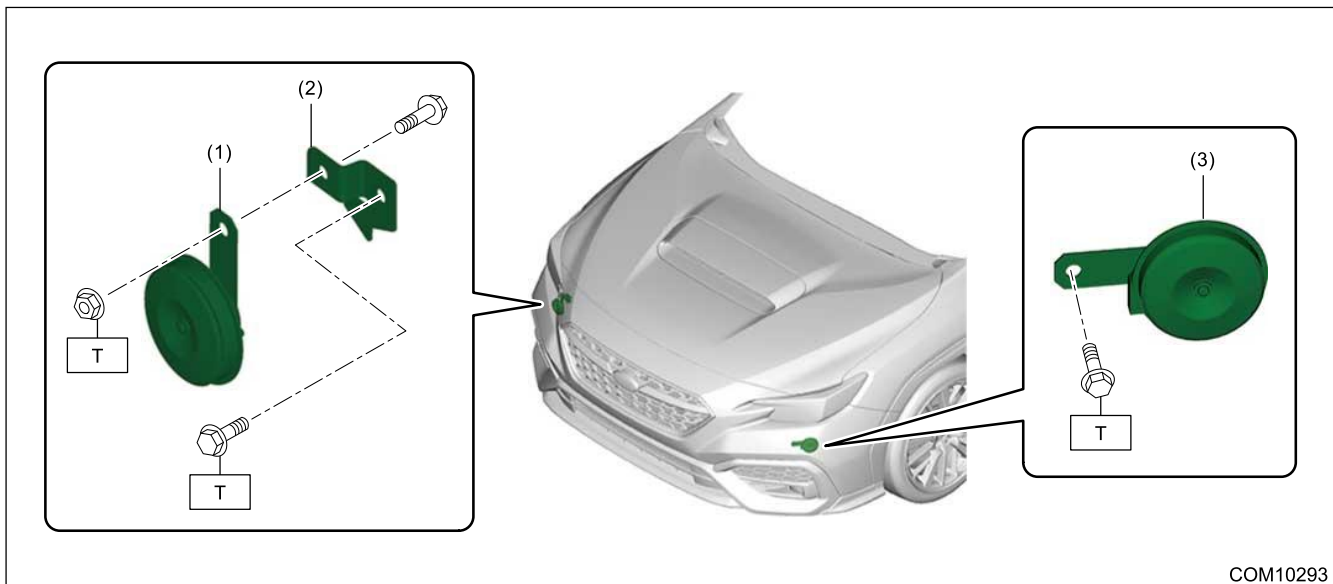

(1) Horn ASSY Lo

(3) Horn ASSY Hi

Tightening torque: N·m (kgf-m, ft-lb)

(2) Horn bracket

T: 18 (1.8, 13.3)

HORN > General Description

PREPARATION TOOL

1. SUBARU SPECIAL TOOL

ILLUSTRATION	TOOL NUMBER	DESCRIPTION	REMARKS
 <p data-bbox="349 506 427 527">STSSM4</p>	—	SUBARU SELECT MONITOR 4	<p data-bbox="933 195 1416 258">Used for setting of each function and troubleshooting for electrical system.</p> <p data-bbox="933 268 1013 296">Note:</p> <ul data-bbox="954 310 1422 531" style="list-style-type: none"> <li data-bbox="954 310 1422 415">• For detailed operation procedures, refer to “Help” of application. <li data-bbox="954 426 1422 531">• Used together with interface for Subaru Select Monitor (such as DST-i and DST-010).

2. OTHER

	REMARKS
Circuit tester	Used for measuring resistance, voltage and current.

HORN > Relay and Fuse

LOCATION

For the location, refer to "FUSE AND RELAY" in the wiring diagram.  [Ref. to WIRING SYSTEM>Fuse And Relay.](#)

Note:

For details of relay and fuse, refer to "DC POWER SUPPLY CIRCUIT".  [Ref. to WIRING SYSTEM>Power Supply Circuit.](#)

HORN > Relay and Fuse

INSPECTION

1. CHECK FUSE

1. Remove the fuse and inspect visually.
2. If the fuse is blown out, replace the fuse.

2. CHECK RELAY

1. Check the resistance between relay terminals.

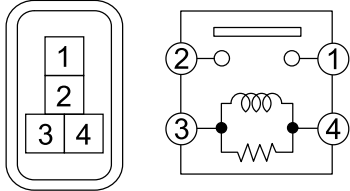
Terminal No.	Inspection conditions	Standard	Circuit
1 – 2	Always	1 M Ω or more	 SR-00180
1 – 2	Apply battery voltage between terminals 4 and 3.	Less than 1 Ω	

2. Replace the relay if the inspection result is not within the standard value.

HORN > Horn System

WIRING DIAGRAM

For the wiring diagram, refer to "Horn System" in the wiring diagram.  [Ref. to WIRING SYSTEM>Horn System>WIRING DIAGRAM.](#)

HORN > Horn System

INSPECTION

1. TROUBLE SYMPTOM

Horn does not sound

Wiring diagram:

Horn system  [Ref. to WIRING SYSTEM>Horn System>WIRING DIAGRAM.](#)

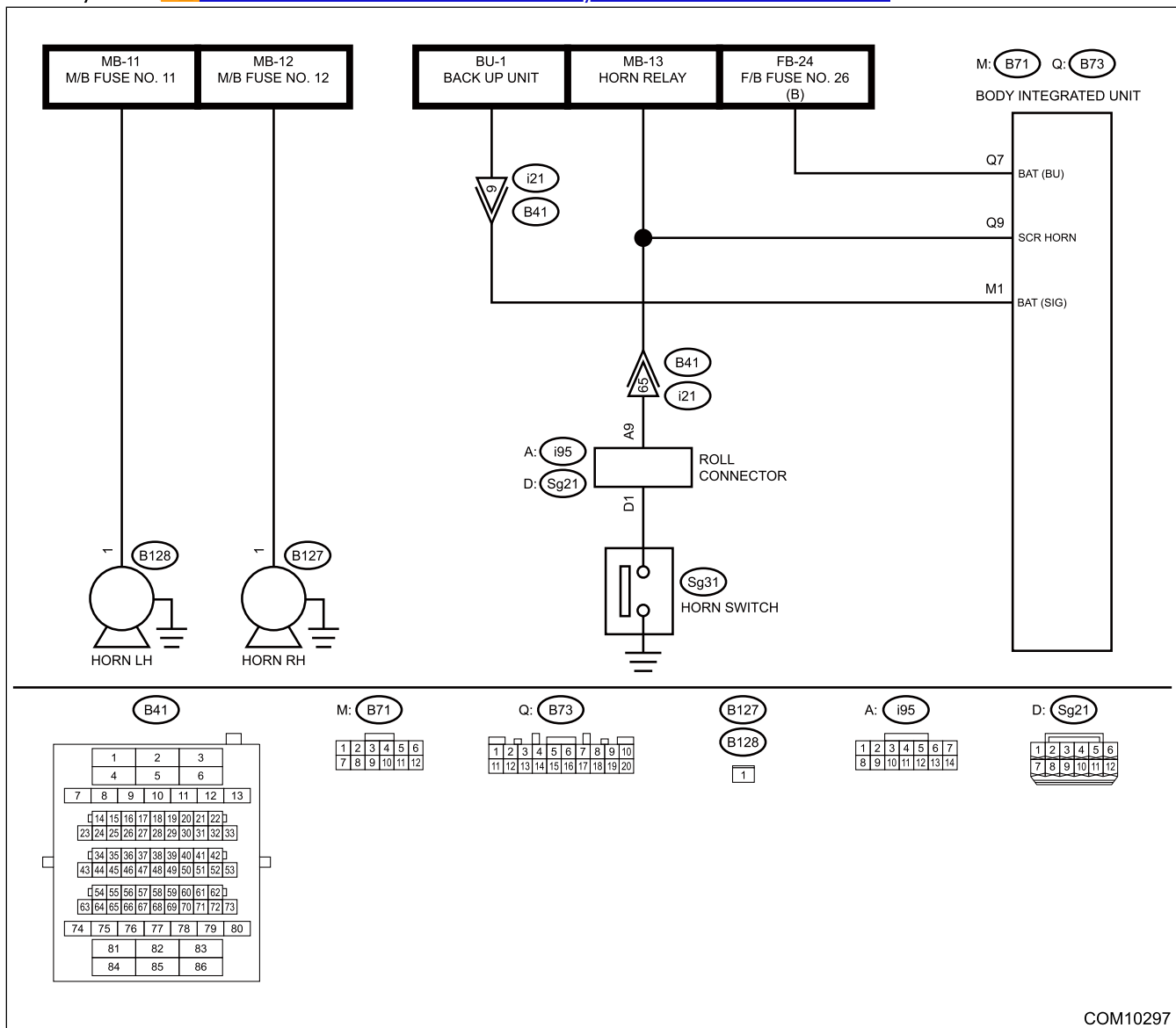

1. CHECK FUSE.

Check the horn fuse inside the fuse box.  [Ref. to HORN>Relay and Fuse>INSPECTION > CHECK FUSE.](#)

Is the fuse blown out?

Yes

Replace the appropriate fuse.

No

 [Go to 2.](#)

2. CHECK HORN RELAY.

Check the relay inside the fuse box.  [Ref. to HORN>Relay and Fuse>INSPECTION > CHECK RELAY.](#)

Is the relay OK?

Yes

 [Go to 3.](#)

No

Replace the horn relay.

3. CHECK STEERING ROLL CONNECTOR.

Check the steering roll connector.  [Ref. to AIRBAG SYSTEM>Roll Connector>INSPECTION>UNIT INSPECTION>STEERING ROLL CONNECTOR CIRCUIT \(EXCEPT FOR AIRBAG CIRCUIT\).](#)

Is the steering roll connector OK?

Yes

 [Go to 4.](#)

No

Replace the steering roll connector.  [Ref. to AIRBAG SYSTEM>Roll Connector.](#)

4. CHECK HORN SWITCH.

Check the horn switch.  [Ref. to HORN>Horn Switch>INSPECTION > CHECK HORN SWITCH.](#)



Is the horn switch normal?

Yes

 [Go to 5.](#)

No

Replace the satellite switch assembly or the driver's airbag module.

- Satellite switch assembly:  [Ref. to POWER ASSISTED SYSTEM \(POWER STEERING\)>Steering Wheel.](#)
- Driver's airbag module:  [Ref. to AIRBAG SYSTEM>Driver's Airbag Module.](#)

5. CHECK HORN.

1. Turn the ignition switch to ON.
2. Using the Subaru Select Monitor, perform [Active Test] in [Body Control], and check the horn sound.  [Ref. to BODY CONTROL\(DIAGNOSTICS\)>Active Test.](#)

Does the horn operate properly?

Yes

 [Go to 6.](#)

No

 [Go to 7.](#)

6. CHECK HORN.

1. Turn the ignition switch to OFF.
2. Check the horn assembly.  [Ref. to HORN>Horn>INSPECTION.](#)

Is the horn normal?

Yes

Check the harness and body integrated unit.

No

Replace the horn assembly.  [Ref. to HORN>Horn.](#)

7. CHECK HARNESS.

1. Remove the steering roll connector.  [Ref. to AIRBAG SYSTEM>Roll Connector>REMOVAL.](#)
2. Measure the resistance between the horn relay and steering roll connector.

Connector & terminal

(B128) No. 1 — Fuse No. 11:

(B127) No. 1 — Fuse No. 12:

Is the resistance less than 10 Ω ?

Yes

Check body integrated unit.  [Ref. to BODY CONTROL\(DIAGNOSTICS\)>Basic Diagnostic Procedure.](#)

No

Repair or replace the defective part.

HORN > Horn System

NOTE

For operation procedures of components of the horn system, refer to the following sections.

- Horn assembly:  [Ref. to HORN>Horn.](#)
- Horn switch:  [Ref. to HORN>Horn Switch.](#)

REMOVAL



1. HORN ASSEMBLY LO

1. Disconnect the ground terminal from battery sensor.  [Ref. to REPAIR CONTENTS>NOTE > BATTERY.](#)
2. Lift up the vehicle.
3. Remove the screw and clips, and turn over the mud guard front RH.

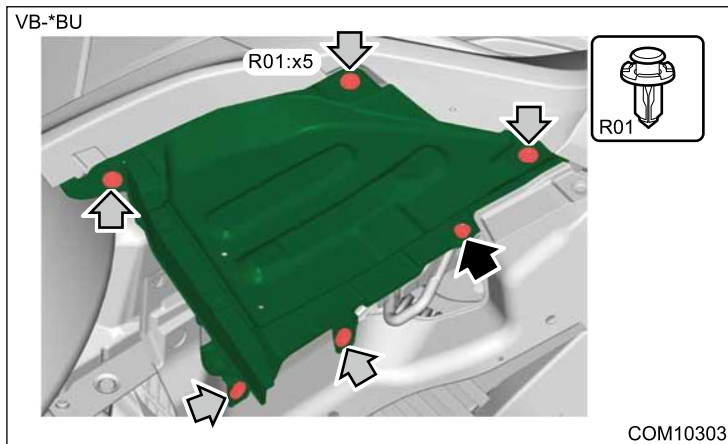

4. Remove the horn sub assembly Lo.
 - (1) Disconnect the connector.
 - (2) Remove the bolt, and remove the horn sub assembly Lo.

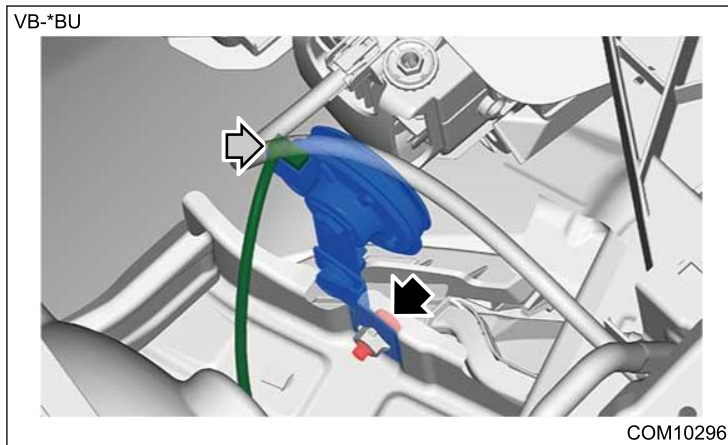

5. Remove the bolt and nut, and then remove the horn assembly Lo from the horn bracket.

Note:

Perform this procedure only when required.

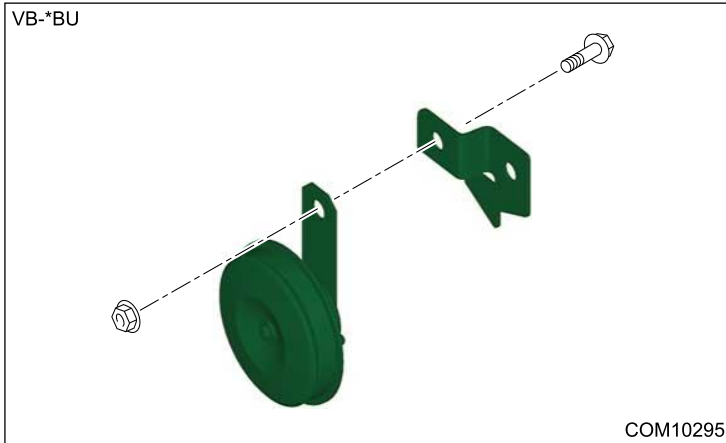

2. HORN ASSEMBLY HI

1. Disconnect the ground terminal from battery sensor.  [Ref. to REPAIR CONTENTS>NOTE > BATTERY.](#)
2. Lift up the vehicle.
3. Remove the screw and clips, and turn over the mud guard front LH.

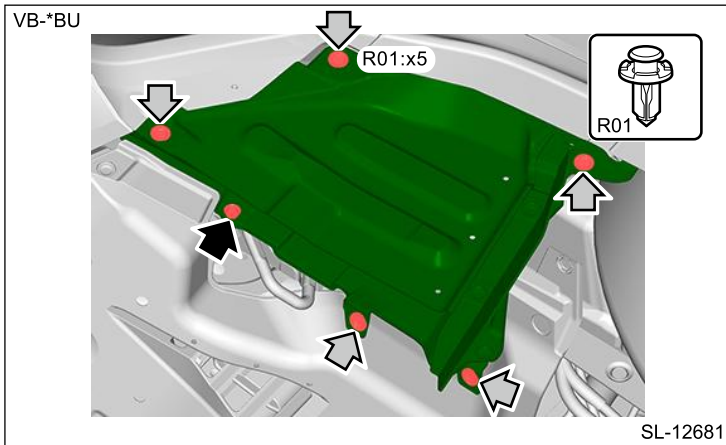

4. Remove the horn assembly Hi.
 - (1) Disconnect the connector.
 - (2) Remove the bolt, and remove the horn assembly Hi.

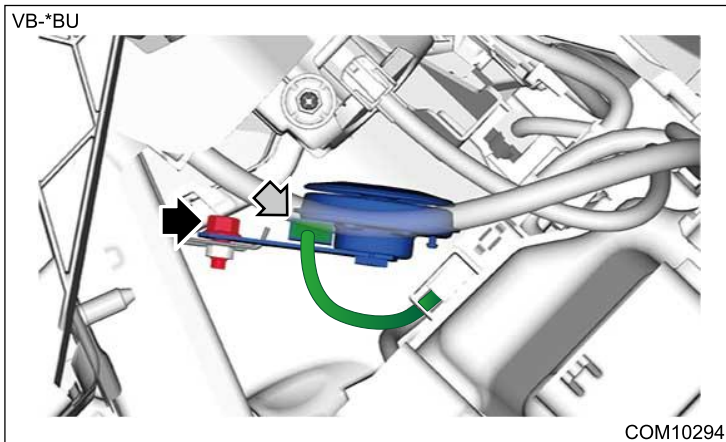

INSTALLATION

1. Install the horn assembly Lo to the horn bracket. (Horn assembly Lo)

Note:

Install the horn assembly Lo and the horn bracket as shown in the figure.

VB-*BE

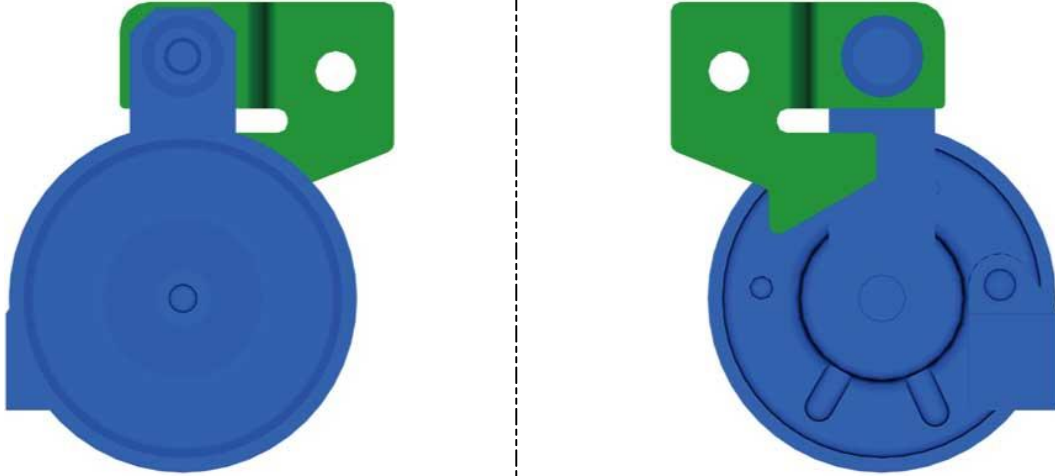

COM10307

Tightening torque:

18 N·m (1.8 kgf-m, 13.3 ft-lb)

2. Install the horn assembly, and connect the connector.

Tightening torque:

18 N·m (1.8 kgf-m, 13.3 ft-lb)

3. Install the mud guard front.  [Ref. to EXTERIOR/INTERIOR TRIM>Mud Guard>INSTALLATION.](#)
4. Lower the vehicle.
5. Connect the ground terminal to battery sensor.  [Ref. to REPAIR CONTENTS>NOTE > BATTERY.](#)

HORN > Horn

INSPECTION

1. Check the horn sounds when applying the battery voltage to the horn assembly.
 - Horn assembly Lo side

VB-*BE

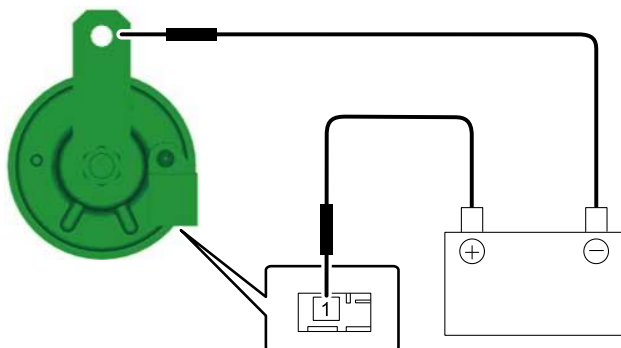

COM10309

- Horn assembly Hi side

VB-*BU

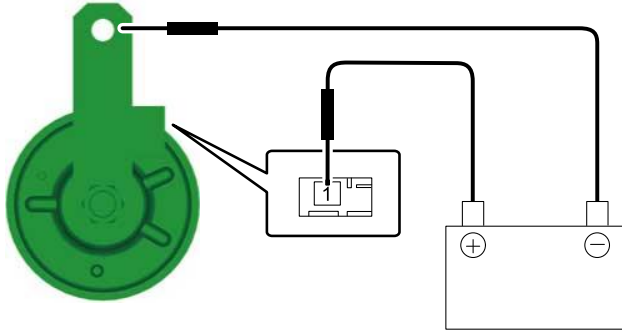

COM10317

Terminal No.	Inspection conditions	Specification
1 (+) — Horn case (-)	Apply battery voltage.	Sounds

2. If it does not operate normally, replace the horn assembly.

HORN > Horn Switch

NOTE

Horn switch is a unit with the driver's airbag module.

For the horn switch operation procedure, refer to "Driver's Airbag Module" in the "AIRBAG SYSTEM" section.

 [Ref. to AIRBAG SYSTEM>Driver's Airbag Module.](#)

HORN > Horn Switch



INSPECTION

1. CHECK HORN SWITCH

Caution:

Before handling the airbag system components, refer to "CAUTION" of "General Description" in "AIRBAG SYSTEM".  [Ref. to AIRBAG SYSTEM>General Description>CAUTION.](#)

1. CHECK HORN SWITCH TERMINAL.

1. Turn the ignition switch to OFF.
2. Disconnect the ground terminal from the battery sensor, and wait for at least 60 seconds before starting work.  [Ref. to REPAIR CONTENTS>NOTE > BATTERY.](#)
3. Remove the driver's airbag module.  [Ref. to AIRBAG SYSTEM>Driver's Airbag Module>REMOVAL.](#)
4. Check the connecting condition of horn switch connector.
5. Measure the resistance between connectors.

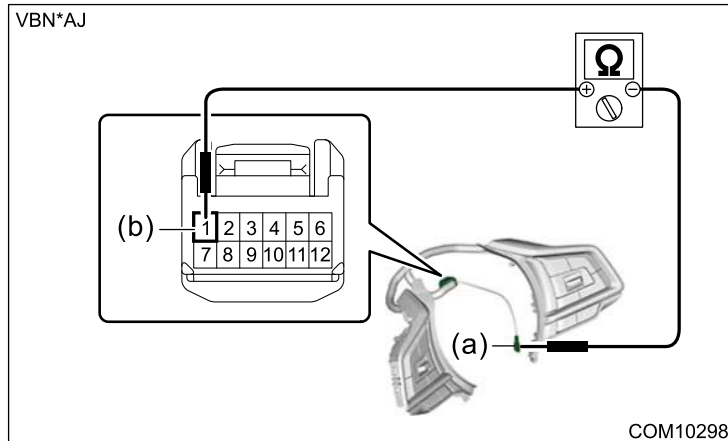

(a) Ground terminal

(b) Horn switch terminal

Terminals	Standard
Horn switch terminal – ground terminal	Less than 1 Ω

Is the measured value within the standard value?

Yes

 [Go to 2.](#)

No

It is possible that there is an open circuit between horn switch terminal and ground terminal. Replace the satellite switch assembly.  [Ref. to POWER ASSISTED SYSTEM \(POWER STEERING\)>Steering Wheel.](#)

2. CHECK DRIVER'S AIRBAG MODULE.

Measure the resistance between horn plate and snap pin hook.

Caution:

Measure the resistance while lifting the snap pin hook so that it does not come in contact with the horn plate.

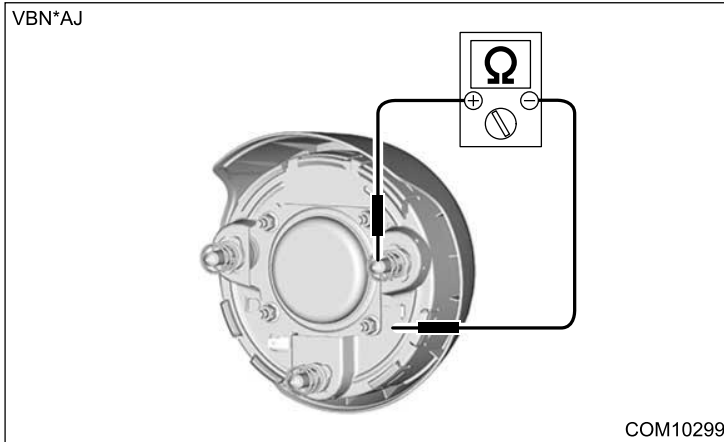

Terminals	Standard
Horn plate — Snap pin hook	1 MΩ or more

Is the measured value within the standard value?

Yes

 [Go to 3.](#)

No

Replace the driver's airbag module.  [Ref. to AIRBAG SYSTEM>Driver's Airbag Module.](#)

3. CHECK DRIVER'S AIRBAG MODULE.

Measure the resistance between horn plate and snap pin hook with the snap pin hook in contact with the horn plate.

Caution:

Measure at all three positions of the snap pin hook.

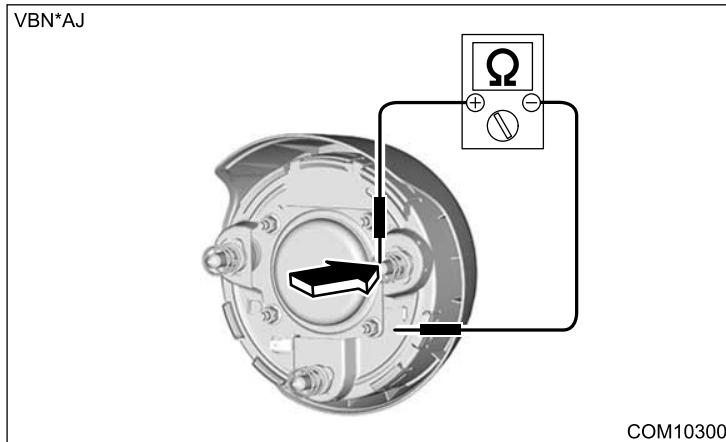

Terminals	Standard
Horn plate — Snap pin hook	Less than 1 Ω

Is the measured value within the standard value?

Yes

Driver's airbag module is normal.



No

Replace the driver's airbag module.  [Ref. to AIRBAG SYSTEM>Driver's Airbag Module.](#)

1. General Description
2. Relay and Fuse
3. Cockpit Display System
4. Cockpit Display
5. Front Speaker
6. Rear Speaker
7. Woofer
8. Power Amplifier
9. Antenna
10. Switches and Harness
11. Microphone
12. Telematics System
13. Data Communication Module
14. Camera
15. Accessory Power Supply Socket
16. External Connection Terminal
17. Diagnostics with Phenomenon
18. Dealership Mode

ENTERTAINMENT & MONITORING > General Description

CAUTION

- When performing service operation, refer to "Repair Contents" in "General Description".  [Ref. to REPAIR CONTENTS>Repair Contents.](#)
- When performing work on the sensors or modules, be careful of the following.
 - Before disconnecting connectors, be sure to disconnect the ground terminal from the battery sensor.  [Ref. to REPAIR CONTENTS>NOTE > BATTERY.](#)
 - Do not apply any impact. If the parts are accidentally dropped, replace with a new part.
 - Do not expose to high-temperature and humidity.
- When replacing the parts provided with memory functions, record the memory contents before disconnecting the ground terminal from the battery sensor.
- Refer to "CAUTION" of "General Description" in "AIRBAG SYSTEM" section.  [Ref. to AIRBAG SYSTEM>General Description>CAUTION.](#)
- If any immobilizer related part has been replaced, make sure to register the immobilizer.

ENTERTAINMENT & MONITORING > General Description

LOCATION

1. COCKPIT DISPLAY SYSTEM

For location, refer to "Electrical Component Location" in the "COCKPIT CONTROL (DIAGNOSTICS)" section.

 [Ref. to COCKPIT CONTROL \(DIAGNOSTICS\)>Electrical Component Location.](#)

2. TELEMATICS SYSTEM

For locations, refer to "Electrical Component Location" of "TELEMATICS (DIAGNOSTICS)" section.  [Ref. to](#)

[TELEMATICS SYSTEM \(DIAGNOSTICS\)>Electrical Component Location.](#)

ENTERTAINMENT & MONITORING > General Description

COMPONENT

1. CENTER INFORMATION DISPLAY ASSEMBLY

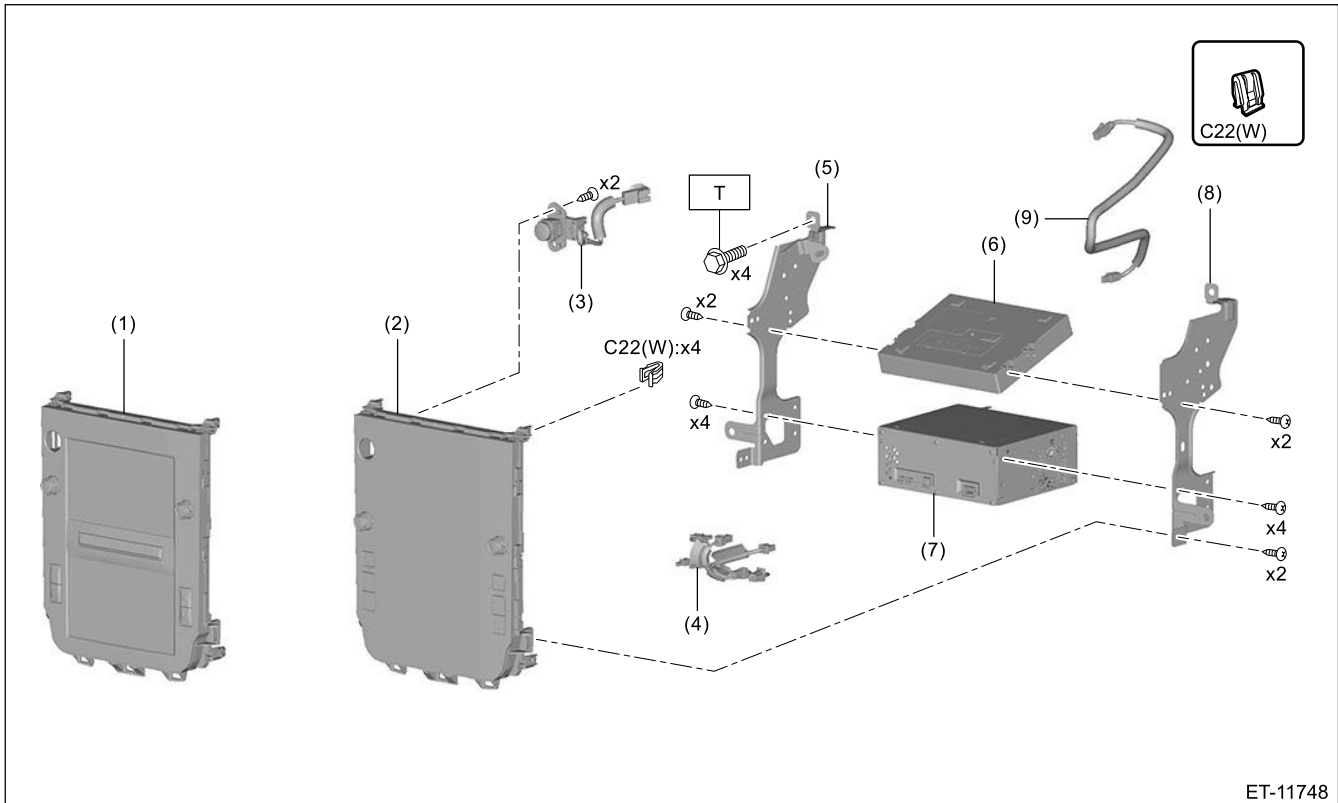

- (1) Center information display (model with dual 7.0-inch display)
- (2) Center information display (model with 11.6-inch display)
- (3) Switch hazard
- (4) Cord ASSY CCM

- (5) Unit bracket LH
- (6) Data communication module
- (7) Cockpit control module
- (8) Unit bracket RH

- (9) Cable CCM

Tightening torque: N·m (kgf-m, ft-lb)
T: 7.5 (0.8, 5.5)

4. ROOF ANTENNA

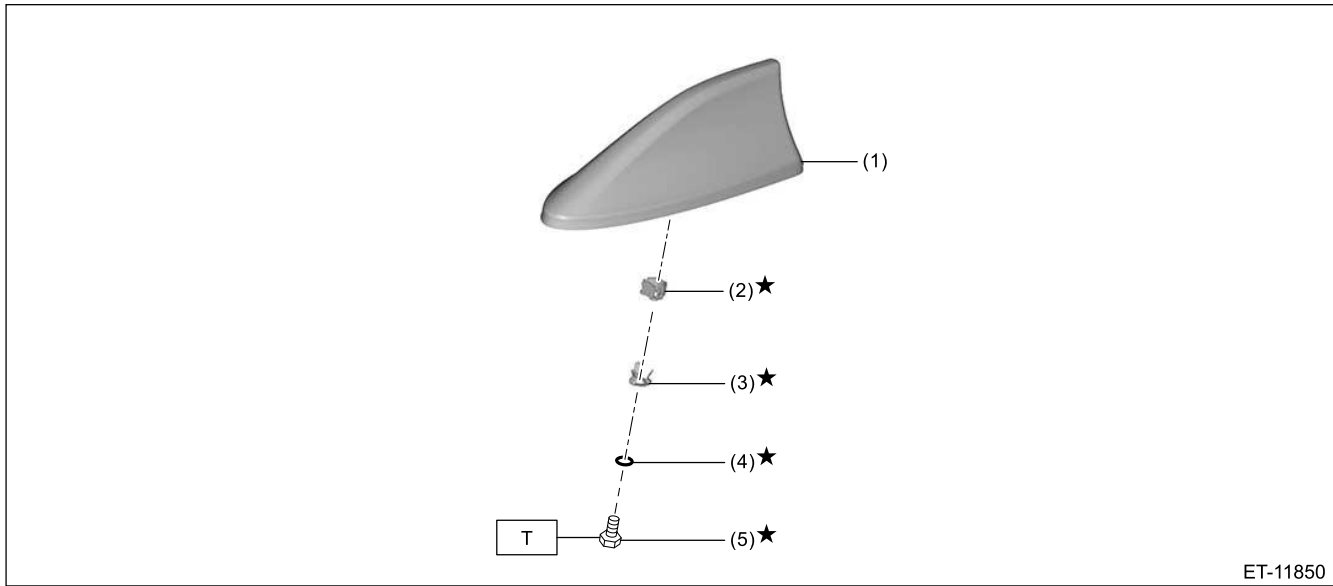

(1) Antenna ASSY roof

(4) Washer

Tightening torque: N·m (kgf·m, ft·lb)

(2) Clip

(5) Bolt

T: 4.5 ±1 (0.5±0.1, 3.3±0.7)

(3) Spring

ENTERTAINMENT & MONITORING > General Description

PREPARATION TOOL

1. SUBARU SPECIAL TOOL

ILLUSTRATION	TOOL NUMBER	DESCRIPTION	REMARKS
 <p>STSSM4</p>	—	SUBARU SELECT MONITOR 4	Used for setting of each function and troubleshooting for electrical system. Note: <ul style="list-style-type: none"> For detailed operation procedures, refer to "Help" of application. Used together with interface for Subaru Select Monitor (such as DST-i and DST-010).

2. OTHER

	REMARKS
Circuit tester	Used for measuring resistance, voltage and current.
TORX® T10	Used for removing and installing the backup battery.

ENTERTAINMENT & MONITORING > Relay and Fuse

LOCATION

For the location, refer to "FUSE AND RELAY" in the wiring diagram.  [Ref. to WIRING SYSTEM>Fuse And Relay>LOCATION.](#)

Note:

For details of relay and fuse, refer to "DC POWER SUPPLY CIRCUIT".  [Ref. to WIRING SYSTEM>Power Supply Circuit>WIRING DIAGRAM.](#)

ENTERTAINMENT & MONITORING > Relay and Fuse

INSPECTION

1. CHECK FUSE

1. Remove the fuse and inspect visually.
2. If the fuse is blown out, replace the fuse.

Note:

If the fuse is blown again, check the system wiring harness.

ENTERTAINMENT & MONITORING > Cockpit Display System

WIRING DIAGRAM

For the wiring diagram, refer to "Audio and Navigation System" in the wiring diagram.  [Ref. to WIRING SYSTEM>Audio and Navigation System>WIRING DIAGRAM.](#)

ENTERTAINMENT & MONITORING > Cockpit Display System

INSPECTION

1. BASIC INSPECTION

For the basic inspection, refer to "Basic Diagnostic Procedure" of "COCKPIT CONTROL (DIAGNOSTICS)".  [Ref. to COCKPIT CONTROL \(DIAGNOSTICS\)>Basic Diagnostic Procedure.](#)

2. SYSTEM BLOCK DIAGRAM

For system block diagram, refer to "System Block Diagram" in "COCKPIT CONTROL (DIAGNOSTICS)".  [Ref. to COCKPIT CONTROL \(DIAGNOSTICS\)>General Description>SYSTEM BLOCK DIAGRAM.](#)

3. MODULE I/O SIGNAL

For the electrical specification, refer to "Control Module I/O Signal" of "COCKPIT CONTROL (DIAGNOSTICS)".  [Ref. to COCKPIT CONTROL \(DIAGNOSTICS\)>Control Module I/O Signal>ELECTRICAL SPECIFICATION.](#)





ENTERTAINMENT & MONITORING > Cockpit Display System

NOTE

For operation procedures of components of the cockpit display system, refer to the following sections.





Note:

For the CAN communication system, refer to the LAN system.  [Ref. to LAN SYSTEM \(DIAGNOSTICS\)>Electrical Component Location.](#)



- Cockpit display:  [Ref. to ENTERTAINMENT & MONITORING>Cockpit Display.](#)
- Front speaker:  [Ref. to ENTERTAINMENT & MONITORING>Front Speaker.](#)
- Rear speaker:  [Ref. to ENTERTAINMENT & MONITORING>Rear Speaker.](#)
- Woofer:  [Ref. to ENTERTAINMENT & MONITORING>Woofer.](#)
- Power amplifier:  [Ref. to ENTERTAINMENT & MONITORING>Power Amplifier.](#)
- Antenna:  [Ref. to ENTERTAINMENT & MONITORING>Antenna.](#)
- Audio steering switch:  [Ref. to ENTERTAINMENT & MONITORING>Switches and Harness.](#)
- External connection terminal:  [Ref. to ENTERTAINMENT & MONITORING>External Connection Terminal.](#)
- Microphone:  [Ref. to ENTERTAINMENT & MONITORING>Microphone.](#)

ENTERTAINMENT & MONITORING > Cockpit Display

REMOVAL

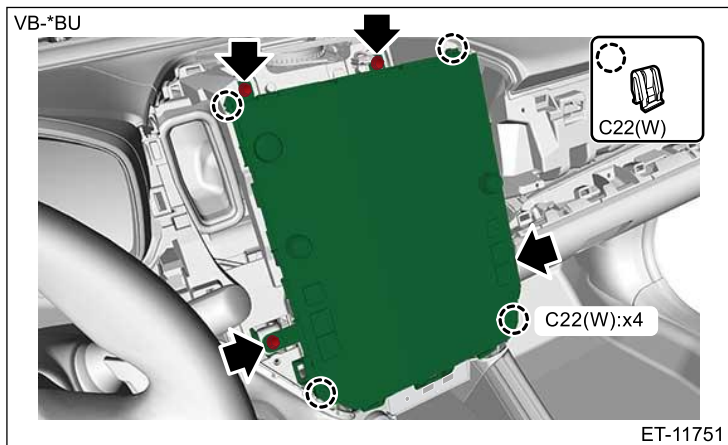

1. When replacing the cockpit control module, store the [Cockpit Control] customizing information.  [Ref. to COMMON \(DIAGNOSTICS\)>Customize>OPERATION > SAVE SETTINGS/READ SETTINGS.](#)
2. Disconnect the ground terminal from battery sensor.  [Ref. to REPAIR CONTENTS>NOTE > BATTERY.](#)
3. Remove the driver monitoring unit.  [Ref. to INSTRUMENTATION/DRIVER INFO>Driver Monitoring Unit>REMOVAL.](#)
4. Remove the ornament panel mid passenger and panel assembly center.  [Ref. to EXTERIOR/INTERIOR TRIM>Centor Cluster>REMOVAL.](#)
5. Remove the center information display assembly.
(1) Remove the bolt and release the clip.



- (2) Disconnect the connectors, and then remove the center information display assembly.
6. Remove the data communication module. (Model with telematics)  [Ref. to ENTERTAINMENT & MONITORING>Data Communication Module>REMOVAL > DATA COMMUNICATION MODULE.](#)
7. Remove the cockpit control module.  [Ref. to ENTERTAINMENT & MONITORING>Cockpit Display>DISASSEMBLY.](#)

ENTERTAINMENT & MONITORING > Cockpit Display

INSTALLATION



1. Install the cockpit control module.  [Ref. to ENTERTAINMENT & MONITORING>Cockpit Display>ASSEMBLY.](#)
2. Install the data communication module. (Model with telematics)  [Ref. to ENTERTAINMENT & MONITORING>Data Communication Module>INSTALLATION > DATA COMMUNICATION MODULE.](#)
3. Connect each connector, and install the center information display assembly.

Caution:

Do not allow the harnesses and cords to interfere with or get caught by other parts.

Tightening torque:

7.5 N·m (0.8 kgf·m, 5.5 ft·lb)

4. Install the panel assembly center and the ornament panel mid passenger.  [Ref. to EXTERIOR/INTERIOR TRIM>Centor Cluster>INSTALLATION.](#)
5. Install the driver monitoring unit.  [Ref. to INSTRUMENTATION/DRIVER INFO>Driver Monitoring Unit>INSTALLATION.](#)
6. Connect the ground terminal to battery sensor.  [Ref. to REPAIR CONTENTS>NOTE > BATTERY.](#)

7. When the cockpit control assembly has been replaced, read the [Cockpit Control] customizing information.  [Ref. to COMMON \(DIAGNOSTICS\)>Customize>OPERATION > SAVE SETTINGS/READ SETTINGS.](#)

ENTERTAINMENT & MONITORING > Cockpit Display

DISASSEMBLY

1. Remove the center information display.
(1) Remove the connector clips, and disconnect each connector.

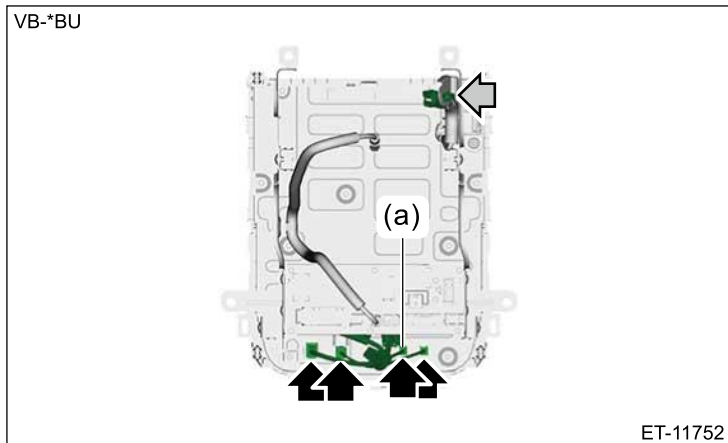

(a) Model with 11.6-inch display

- (2) Remove the screws and remove the center information display.

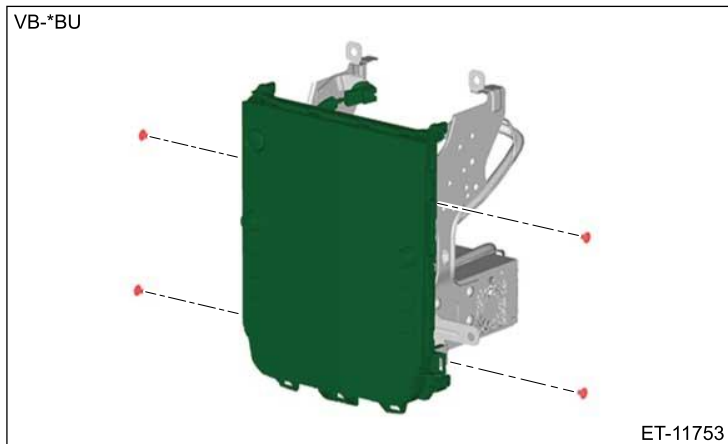

2. Remove the switch hazard.  [Ref. to LIGHTING SYSTEM>Hazard Switch>REMOVAL.](#)
3. Disconnect the connectors, and remove the cord assembly CCM.

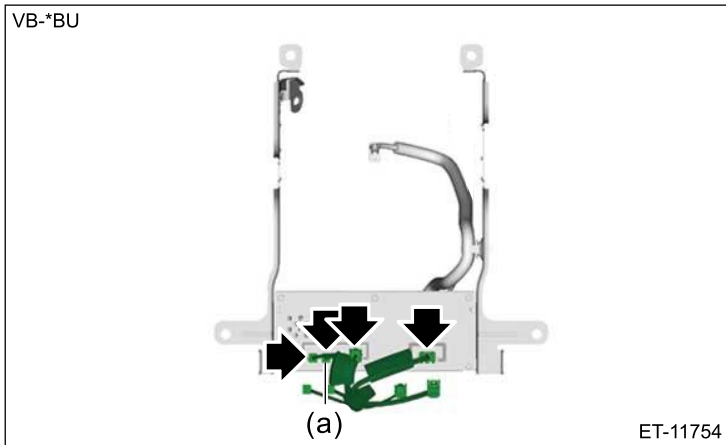

(a) Model with 11.6-inch display

4. Remove the connector and cable clip and remove the cable CCM.

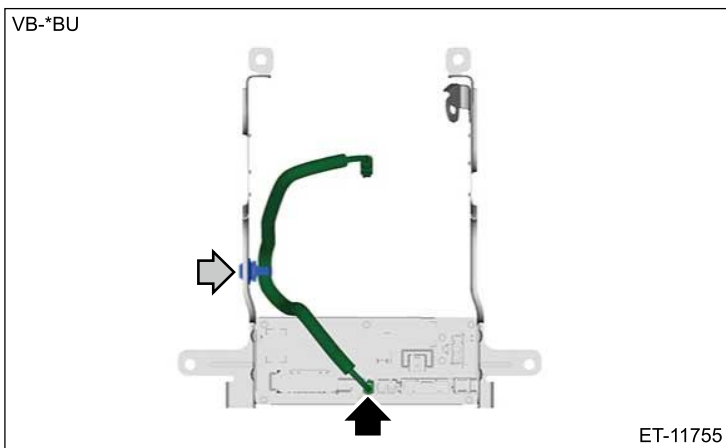

5. Remove the screws and remove the unit bracket from the cockpit control module.

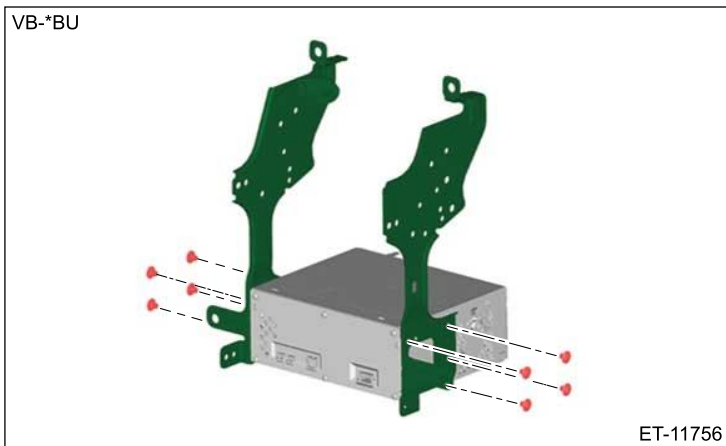

ENTERTAINMENT & MONITORING > Cockpit Display

ASSEMBLY

1. Install the unit bracket to the cockpit control module.
2. Connect the connector, and install the cable CCM.
3. Connect each connector, and install the cord assembly CCM.

- 4.** Install the switch hazard.  [Ref. to LIGHTING SYSTEM>Hazard Switch>INSTALLATION.](#)
- 5.** Install the center information display and connect each connector.

REMOVAL

1. TWEETER

1. Disconnect the ground terminal from battery sensor.  [Ref. to REPAIR CONTENTS>NOTE > BATTERY.](#)
2. Release the clips and claws, then detach the grille speaker side.

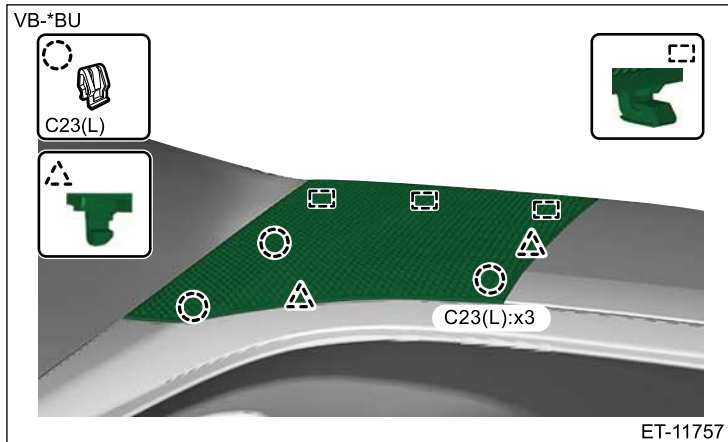

3. Remove the speaker assembly tweeter.

Caution:

Do not touch the cone.

- (1) Remove the screws.

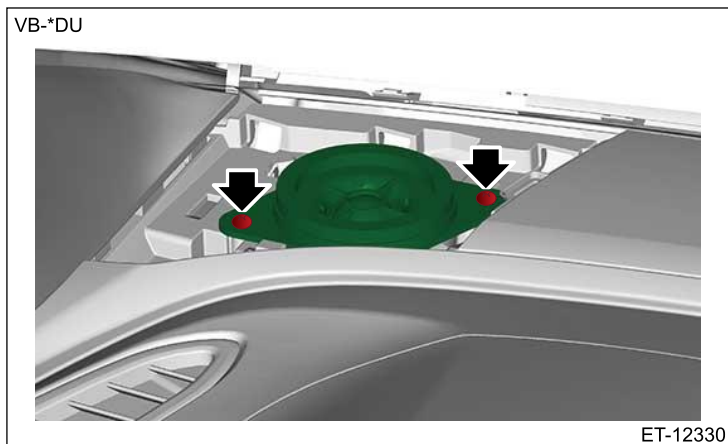



- (2) Disconnect the connector and remove the speaker assembly tweeter.

2. DOOR

Caution:

Before handling the airbag system components, refer to "CAUTION" of "General Description" in "AIRBAG SYSTEM".  [Ref. to AIRBAG SYSTEM>General Description>CAUTION.](#)

1. Disconnect the ground terminal from the battery sensor, and wait for at least 60 seconds before starting work.  [Ref. to REPAIR CONTENTS>NOTE > BATTERY.](#)
2. Remove the trim panel front door.  [Ref. to EXTERIOR/INTERIOR TRIM>Door Trim>REMOVAL > FRONT DOOR.](#)
3. Remove the speaker assembly front.

Caution:

Do not touch the cone.

- (1) Disconnect the connector.
- (2) Remove the screws and remove the speaker assembly front.

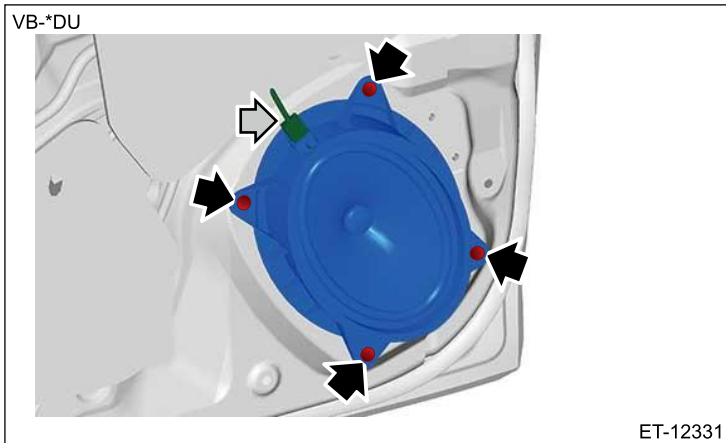

ENTERTAINMENT & MONITORING > Front Speaker

INSTALLATION

1. TWEETER

1. Connect the connector, and install the speaker assembly tweeter.

Caution:

Do not touch the cone.

2. Install the grille speaker side.
3. Connect the ground terminal to battery sensor.  [Ref. to REPAIR CONTENTS>NOTE > BATTERY.](#)

2. DOOR

Caution:

Before handling the airbag system components, refer to "CAUTION" of "General Description" in "AIRBAG SYSTEM".  [Ref. to AIRBAG SYSTEM>General Description>CAUTION.](#)

1. Install the speaker assembly front, and connect the connector.

Caution:

Do not touch the cone.

Note:

If the threaded portion of grommet is faulty, replace the grommet with a new part.

2. Install the trim panel front door.  [Ref. to EXTERIOR/INTERIOR TRIM>Door Trim>INSTALLATION.](#)
3. Connect the ground terminal to battery sensor.  [Ref. to REPAIR CONTENTS>NOTE > BATTERY.](#)

ENTERTAINMENT & MONITORING > Front Speaker

INSPECTION

1. TWEETER

- **MODEL WITHOUT POWER AMPLIFIER**

1. Check that no foreign matter has entered the speaker and that the speaker cone is not torn, deformed, or otherwise damaged.
2. Measure the resistance between the speaker terminals.

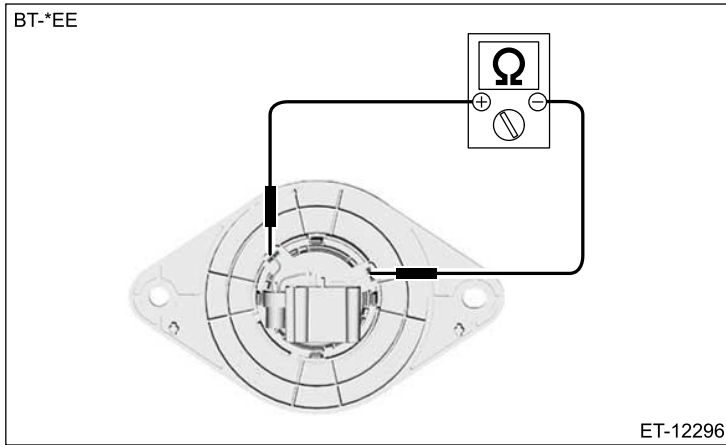

Specification:

3.15 — 3.85 Ω

3. Replace the speaker assembly tweeter if fault is found in the inspection.

● **MODEL WITH POWER AMPLIFIER**

1. Check that no foreign matter has entered the speaker and that the speaker cone is not torn, deformed, or otherwise damaged.
2. Measure the resistance between the speaker terminals.

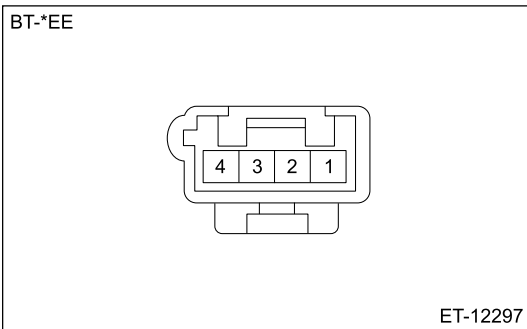

Terminal No.	Inspection conditions	Standard
4 — 3	Always	3.05 — 4.65 Ω

3. Replace the speaker assembly tweeter if fault is found in the inspection.

2. DOOR

1. Check that no foreign matter has entered the speaker and that the speaker cone is not torn, deformed, or otherwise damaged.
2. Measure the resistance between connector terminals.

- Model without power amplifier

Terminal No.	Inspection conditions	Standard
1 – 2	Always	2.97 – 3.63 Ω

- Model with power amplifier

Terminal No.	Inspection conditions	Standard
1 – 2	Always	4.0 – 6.0 Ω

3. Replace the speaker assembly front if fault is found in the inspection.

ENTERTAINMENT & MONITORING > Rear Speaker

REMOVAL

1. Disconnect the ground terminal from battery sensor.  [Ref. to REPAIR CONTENTS>NOTE > BATTERY.](#)
2. Remove the trim panel rear door.  [Ref. to EXTERIOR/INTERIOR TRIM>Door Trim>REMOVAL > REAR DOOR.](#)
3. Remove the speaker assembly rear.

Caution:

Do not touch the cone.

- (1) Disconnect the connector.
- (2) Remove the screws and remove the speaker assembly rear.

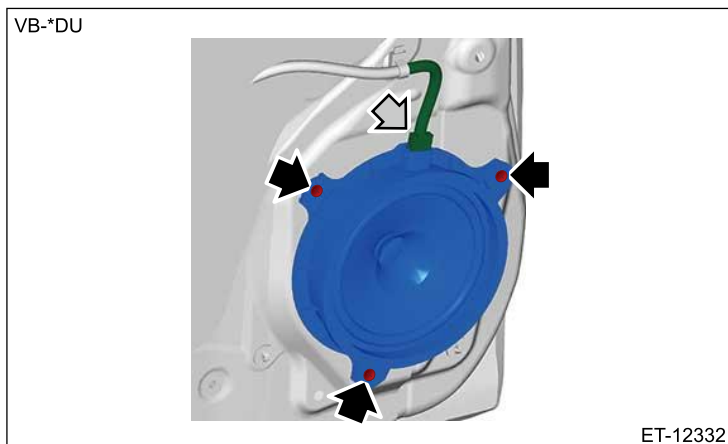

ENTERTAINMENT & MONITORING > Rear Speaker

INSTALLATION

1. Install the speaker assembly rear, and connect the connector.

Caution:

Do not touch the cone.

Note:

If the threaded portion of grommet is faulty, replace the grommet with a new part.

2. Install the trim panel rear door.  [Ref. to EXTERIOR/INTERIOR TRIM>Door Trim>INSTALLATION.](#)
3. Connect the ground terminal to battery sensor.  [Ref. to REPAIR CONTENTS>NOTE > BATTERY.](#)

ENTERTAINMENT & MONITORING > Rear Speaker

INSPECTION

1. Check that no foreign matter has entered the speaker and that the speaker cone is not torn, deformed, or otherwise damaged.
2. Measure the resistance between the speaker terminals.

BT-*EE

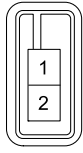

ET-12300

- Model without power amplifier

Terminal No.	Inspection conditions	Standard
1 – 2	Always	2.97 – 3.63 Ω

- Model with power amplifier

Terminal No.	Inspection conditions	Standard
1 – 2	Always	2.6 – 4.4 Ω

3. Replace the speaker assembly rear if fault is found in the inspection.

ENTERTAINMENT & MONITORING > Woofer

REMOVAL

Caution:

- Before handling the airbag system components, refer to "CAUTION" of "General Description" in "AIRBAG SYSTEM". [🔗 Ref. to AIRBAG SYSTEM>General Description>CAUTION.](#)
- Side impact sensor (under the rear center seat) for the airbag system is located under the front center of the rear seat cushion. Be careful not to apply strong impact to the sensor when working with the rear seat cushion removed.

1. Disconnect the ground terminal from the battery sensor, and wait for at least 60 seconds before starting work. [🔗 Ref. to REPAIR CONTENTS>NOTE > BATTERY.](#)
2. Remove the rear seat cushion assembly and the backrest assembly. [🔗 Ref. to SEATS>Rear Seat>REMOVAL.](#)
3. Remove the trim panel assembly C pillar LWR and the trim panel assembly C pillar. [🔗 Ref. to EXTERIOR/INTERIOR TRIM>Rear Quarter Trim>REMOVAL.](#)
4. Remove the trim panel assembly rear shelf. [🔗 Ref. to EXTERIOR/INTERIOR TRIM>Rear Shelf Trim>REMOVAL.](#)
5. Remove the speaker assembly woofer.

Caution:

Do not touch the cone.

- (1) Disconnect the connector.
- (2) Remove the bolts and remove the speaker assembly woofer.

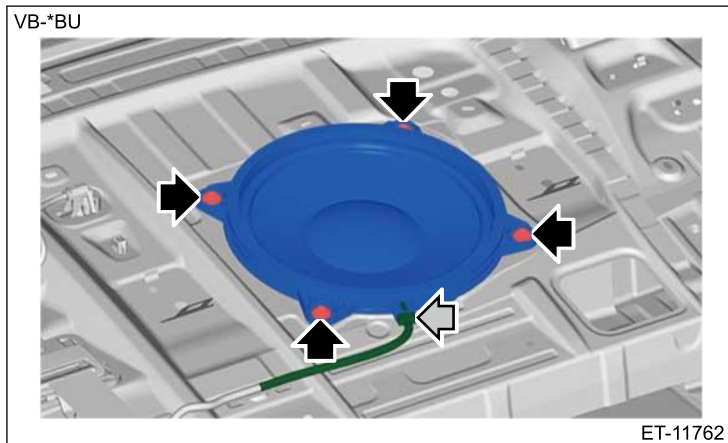

ENTERTAINMENT & MONITORING > Woofer

INSTALLATION





Caution:

- Before handling the airbag system components, refer to "CAUTION" of "General Description" in "AIRBAG SYSTEM". [🔗 Ref. to AIRBAG SYSTEM>General Description>CAUTION.](#)
- Side impact sensor (under the rear center seat) for the airbag system is located under the front center of the rear seat cushion. Be careful not to apply strong impact to the sensor when working with the rear seat cushion removed.

1. Install the speaker assembly woofer, and connect the connector.

Caution:**Do not touch the cone.****Tightening torque:**

7.5 N·m (0.8 kgf-m, 5.5 ft-lb)

2. Install the trim panel assembly rear shelf.  [Ref. to EXTERIOR/INTERIOR TRIM>Rear Shelf Trim>INSTALLATION.](#)
3. Install the trim panel assembly C pillar and the trim panel assembly C pillar LWR.  [Ref. to EXTERIOR/INTERIOR TRIM>Rear Quarter Trim>INSTALLATION.](#)
4. Install the backrest assembly and rear seat cushion assembly.  [Ref. to SEATS>Rear Seat>INSTALLATION.](#)
5. Connect the ground terminal to battery sensor.  [Ref. to REPAIR CONTENTS>NOTE > BATTERY.](#)

ENTERTAINMENT & MONITORING > Woofer**INSPECTION**

1. Check that no foreign matter has entered the speaker and that the speaker cone is not torn, deformed, or otherwise damaged.
2. Measure the resistance between the speaker terminals.

Terminal No.	Inspection conditions	Standard
4 — 3	Always	3.4 — 5.2 Ω
2 — 1	Always	3.4 — 5.2 Ω

3. Replace the speaker assembly woofer if fault is found in the inspection.

REMOVAL

Caution:

Before handling the airbag system components, refer to "CAUTION" of "General Description" in "AIRBAG SYSTEM".  Ref. to AIRBAG SYSTEM>General Description>CAUTION.

Note:

The power amplifier assembly is installed under the front seat RH. Remove the power amplifier assembly after sliding the front seat RH back and forth as necessary.

1. Disconnect the ground terminal from the battery sensor, and wait for at least 60 seconds before starting work.  Ref. to REPAIR CONTENTS>NOTE > BATTERY.
2. Remove the power amplifier assembly.
 - (1) Remove the nut and harness clip.

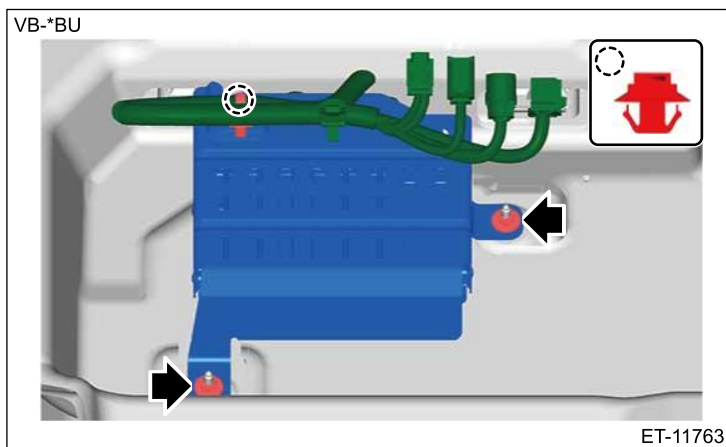

- (2) Disconnect the connector (a).
- (3) Move the lock lever in the arrow direction as shown in the figure and disconnect the connector (b) and remove the power amplifier assembly.

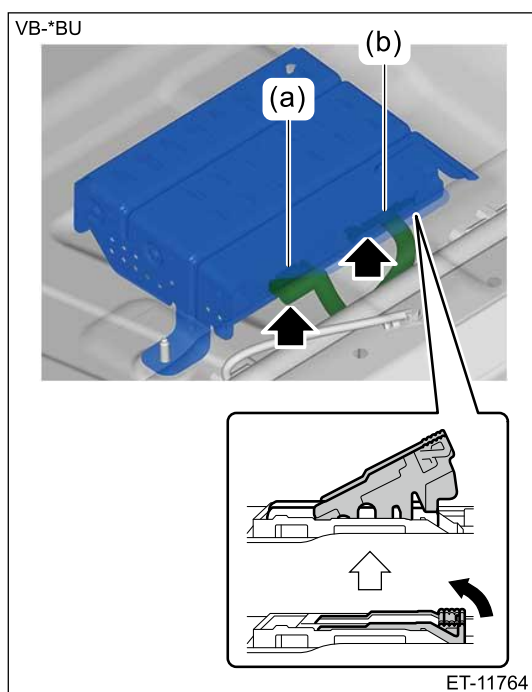

INSTALLATION

Caution:

Before handling the airbag system components, refer to "CAUTION" of "General Description" in "AIRBAG SYSTEM".  [Ref. to AIRBAG SYSTEM>General Description>CAUTION.](#)

Note:

The power amplifier assembly is installed under the front seat RH. Install the power amplifier assembly after sliding the front seat RH back and forth as necessary.

1. Connect each connector, and install the power amplifier assembly.

Tightening torque:

7.5 N·m (0.8 kgf-m, 5.5 ft-lb)

2. Connect the ground terminal to battery sensor.  [Ref. to REPAIR CONTENTS>NOTE > BATTERY.](#)



REMOVAL



1. ROOF ANTENNA (SXM/TELEMATICS)

Caution:

Before handling the airbag system components, refer to "CAUTION" of "General Description" in "AIRBAG SYSTEM".  [Ref. to AIRBAG SYSTEM>General Description>CAUTION.](#)

1. Disconnect the ground terminal from the battery sensor, and wait for at least 60 seconds before starting work.  [Ref. to REPAIR CONTENTS>NOTE > BATTERY.](#)
2. Lower the trim panel roof assembly.  [Ref. to EXTERIOR/INTERIOR TRIM>Roof Trim>REMOVAL.](#)

Note:

Procedures for the roof trim is performed inside the vehicle.

3. Remove the antenna assembly roof.
 - (1) Disconnect the connector.



Note:

For models with telematics, disconnect the telematics antenna connector.

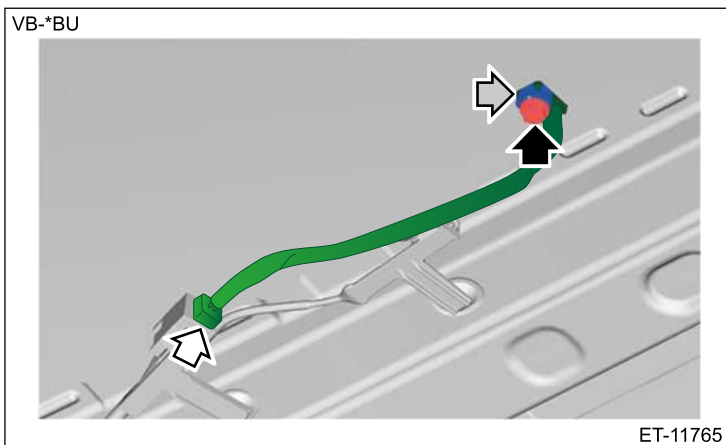
- (2) Remove the bolts and washers.
- (3) Remove the spring and clip, and then remove the antenna assembly roof.



2. GPS ANTENNA

1. Disconnect the ground terminal from battery sensor.  [Ref. to REPAIR CONTENTS>NOTE > BATTERY.](#)
2. Remove the grille speaker side.  [Ref. to ENTERTAINMENT & MONITORING>Front Speaker>REMOVAL > TWEETER.](#)
3. Remove the grille front defroster.  [Ref. to AIR CONDITIONER>Sunload Sensor \(Auto A/C Model\)>REMOVAL.](#)
4. Remove the GPS antenna assembly.
 - (1) Remove the screws.

VB-*BU

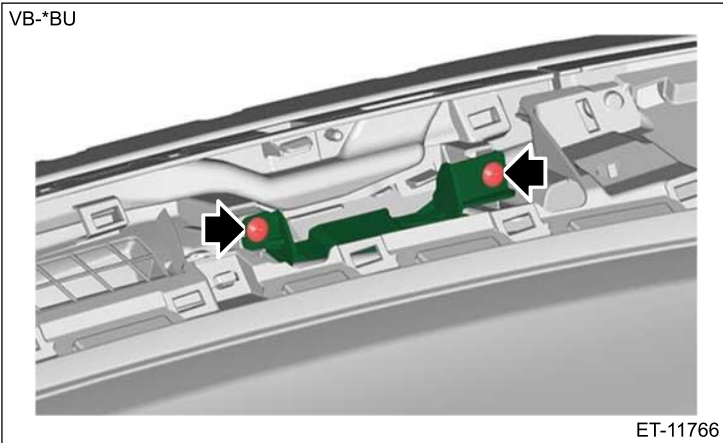







(2) Disconnect the connector and remove the GPS antenna assembly.

3. TELEMATICS SUB ANTENNA

Caution:

Before handling the airbag system components, refer to "CAUTION" of "General Description" in "AIRBAG SYSTEM".  [Ref. to AIRBAG SYSTEM>General Description>CAUTION.](#)

1. Disconnect the ground terminal from the battery sensor, and wait for at least 60 seconds before starting work.  [Ref. to REPAIR CONTENTS>NOTE > BATTERY.](#)
2. Remove the driver monitoring unit.  [Ref. to INSTRUMENTATION/DRIVER INFO>Driver Monitoring Unit>REMOVAL.](#)
3. Remove the cover assembly instrument panel side LH and the ornament panel mid driver.  [Ref. to AIR CONDITIONER>Air Vent Grille>REMOVAL > SIDE GRILLE.](#)
4. Remove the cover LWR driver.  [Ref. to EXTERIOR/INTERIOR TRIM>Instrument Panel Lower Cover>REMOVAL.](#)
5. Remove the ornament panel mid passenger and panel assembly center.  [Ref. to EXTERIOR/INTERIOR TRIM>Centor Cluster>REMOVAL.](#)
6. Remove the panel starter switch.  [Ref. to SECURITY AND LOCKS>Push Button Ignition Switch>REMOVAL.](#)
7. Remove the combination meter assembly.  [Ref. to INSTRUMENTATION/DRIVER INFO>Combination Meter>REMOVAL.](#)
8. Remove the telematics sub antenna assembly.
 - (1) Disconnect the connector.
 - (2) Remove the screws and then remove the telematics sub antenna assembly.

VB-*BU

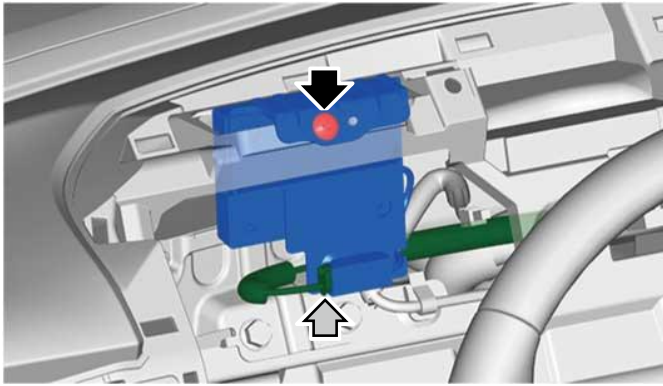

ET-11767

4. FEEDER CORD

● STEERING BEAM

– Combination meter

Note:

The cord assembly meter is integrated with the GPS antenna assembly and with the telematics sub antenna assembly. For the operation procedure, refer to "GPS & Telematics Sub Antenna".



– GPS & telematics sub antenna

Caution:

Before handling the airbag system components, refer to "CAUTION" of "General Description" in "AIRBAG SYSTEM".  [Ref. to AIRBAG SYSTEM>General Description>CAUTION.](#)

Note:

The part is integrated with the cord assembly meter.

1. Disconnect the ground terminal from the battery sensor, and wait for at least 60 seconds before starting work.  [Ref. to REPAIR CONTENTS>NOTE > BATTERY.](#)
2. Remove the instrument panel assembly.  [Ref. to EXTERIOR/INTERIOR TRIM>Instrument Panel Assembly>REMOVAL.](#)
3. Disconnect the GPS assembly cord from the cord clamp of the instrument panel harness.
4. Remove the cord clips and remove the GPS assembly cord.

VBN*EE

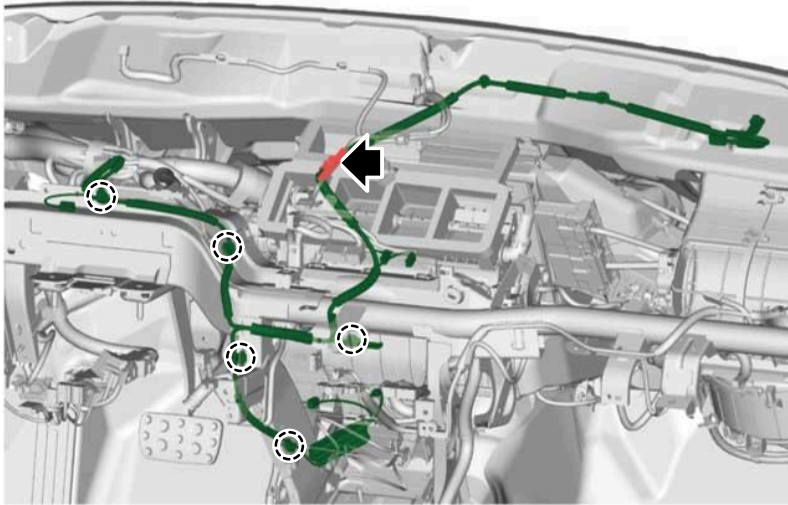



ET-11954

- Roof antenna

Caution:

Before handling the airbag system components, refer to "CAUTION" of "General Description" in "AIRBAG SYSTEM".  [Ref. to AIRBAG SYSTEM>General Description>CAUTION.](#)

1. Disconnect the ground terminal from the battery sensor, and wait for at least 60 seconds before starting work.  [Ref. to REPAIR CONTENTS>NOTE > BATTERY.](#)
2. Remove the instrument panel assembly.  [Ref. to EXTERIOR/INTERIOR TRIM>Instrument Panel Assembly>REMOVAL.](#)
3. Disconnect the feeder assembly cord from the cord clamp of the instrument panel harness.
4. Remove the connectors and cord clips, and then remove the feeder assembly cord.

VB-*BU

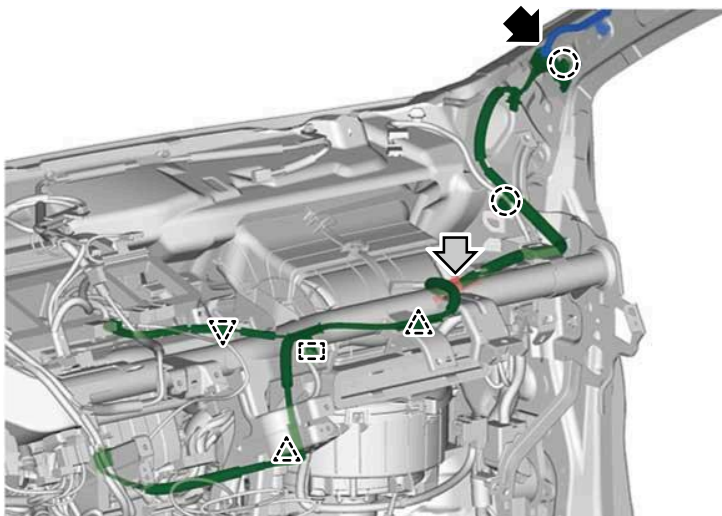

ET-11770

● ROOF TRIM

For work procedures for the cord assembly antenna and cord assembly roof, refer to "Roof Trim" of the "EXTERIOR/INTERIOR TRIM" section.  [Ref. to EXTERIOR/INTERIOR TRIM>Roof Trim>REMOVAL.](#)

INSTALLATION

1. ROOF ANTENNA (SXM/TELEMATICS)

Caution:

Before handling the airbag system components, refer to "CAUTION" of "General Description" in "AIRBAG SYSTEM".  [Ref. to AIRBAG SYSTEM>General Description>CAUTION.](#)



1. Using new clips, springs, washers and bolts, install the antenna assembly roof and connect the connector.

Tightening torque:

4.5 ±1 N·m (0.5±0.1 kgf-m, 3.3±0.7 ft-lb)

2. Install the trim panel roof assembly.  [Ref. to EXTERIOR/INTERIOR TRIM>Roof Trim>INSTALLATION.](#)
3. Connect the ground terminal to battery sensor.  [Ref. to REPAIR CONTENTS>NOTE > BATTERY.](#)







2. GPS ANTENNA

1. Connect the connector, and install the GPS antenna assembly.
2. Install the grille front defroster.  [Ref. to AIR CONDITIONER>Sunload Sensor \(Auto A/C Model\)>INSTALLATION.](#)
3. Install the grille speaker side.  [Ref. to ENTERTAINMENT & MONITORING>Front Speaker>INSTALLATION > TWEETER.](#)
4. Connect the ground terminal to battery sensor.  [Ref. to REPAIR CONTENTS>NOTE > BATTERY.](#)

3. TELEMATICS SUB ANTENNA

Caution:

Before handling the airbag system components, refer to "CAUTION" of "General Description" in "AIRBAG SYSTEM".  [Ref. to AIRBAG SYSTEM>General Description>CAUTION.](#)

1. Install the telematics sub antenna assembly and connect the connector.
2. Install the combination meter assembly.  [Ref. to INSTRUMENTATION/DRIVER INFO>Combination Meter>INSTALLATION.](#)
3. Install the panel starter switch.  [Ref. to SECURITY AND LOCKS>Push Button Ignition Switch>INSTALLATION.](#)
4. Install the panel assembly center and the ornament panel mid passenger.  [Ref. to EXTERIOR/INTERIOR TRIM>Centor Cluster>INSTALLATION.](#)
5. Install the cover LWR driver.  [Ref. to EXTERIOR/INTERIOR TRIM>Instrument Panel Lower Cover>INSTALLATION.](#)
6. Install the ornament panel mid driver and cover assembly instrument panel side LH.  [Ref. to AIR CONDITIONER>Air Vent Grille>INSTALLATION > SIDE GRILLE.](#)
7. Install the driver monitoring unit.  [Ref. to INSTRUMENTATION/DRIVER INFO>Driver Monitoring Unit>INSTALLATION.](#)
8. Connect the ground terminal to battery sensor.  [Ref. to REPAIR CONTENTS>NOTE > BATTERY.](#)

4. FEEDER CORD

- **STEERING BEAM**
 - **Combination meter**

Note:

The cord assembly meter is integrated with the GPS antenna assembly and with the telematics sub antenna assembly. For the operation procedure, refer to "GPS & Telematics Sub Antenna".



- **GPS & telematics sub antenna**

Caution:

Before handling the airbag system components, refer to "CAUTION" of "General Description" in "AIRBAG SYSTEM".  [Ref. to AIRBAG SYSTEM>General Description>CAUTION.](#)

Note:



The part is integrated with the cord assembly meter.

1. Install the GPS assembly cord.
2. Install the instrument panel assembly.  [Ref. to EXTERIOR/INTERIOR TRIM>Instrument Panel Assembly>INSTALLATION.](#)
3. Connect the ground terminal to battery sensor.  [Ref. to REPAIR CONTENTS>NOTE > BATTERY.](#)

- **Roof antenna**

Caution:

Before handling the airbag system components, refer to "CAUTION" of "General Description" in "AIRBAG SYSTEM".  [Ref. to AIRBAG SYSTEM>General Description>CAUTION.](#)

1. Install the feeder assembly cord and connect the connector.
2. Install the instrument panel assembly.  [Ref. to EXTERIOR/INTERIOR TRIM>Instrument Panel Assembly>INSTALLATION.](#)
3. Connect the ground terminal to battery sensor.  [Ref. to REPAIR CONTENTS>NOTE > BATTERY.](#)

● **ROOF TRIM**





For work procedures for the cord assembly antenna and cord assembly roof, refer to "Roof Trim" of the "EXTERIOR/INTERIOR TRIM" section.  [Ref. to EXTERIOR/INTERIOR TRIM>Roof Trim>INSTALLATION.](#)

REMOVAL



1. AUDIO STEERING SWITCH

Caution:

Before handling the airbag system components, refer to "CAUTION" of "General Description" in "AIRBAG SYSTEM".  [Ref. to AIRBAG SYSTEM>General Description>CAUTION.](#)

1. Set the steering wheel to the straight-ahead position.
2. Disconnect the ground terminal from the battery sensor, and wait for at least 60 seconds before starting work.  [Ref. to REPAIR CONTENTS>NOTE > BATTERY.](#)
3. Remove the driver's airbag module.  [Ref. to AIRBAG SYSTEM>Driver's Airbag Module>REMOVAL.](#)
4. Remove the steering wheel assembly.  [Ref. to POWER ASSISTED SYSTEM \(POWER STEERING\)>Steering Wheel>REMOVAL.](#)
5. Remove the audio steering switch.  [Ref. to POWER ASSISTED SYSTEM \(POWER STEERING\)>Steering Wheel>DISASSEMBLY.](#)

2. TELEMATICS BUTTON

1. Disconnect the ground terminal from battery sensor.  [Ref. to REPAIR CONTENTS>NOTE > BATTERY.](#)
2. Remove the light assembly map.  [Ref. to LIGHTING SYSTEM>Spot Map Light>REMOVAL.](#)
3. Remove the telematics button.
 - (1) Release the claws and remove the front side of the frame.

Caution:

Be careful not to pull the harness.

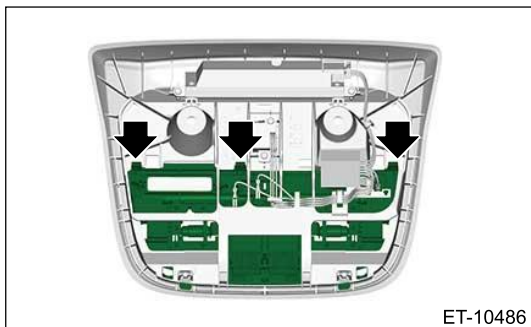

Note:

The frame cannot be removed.



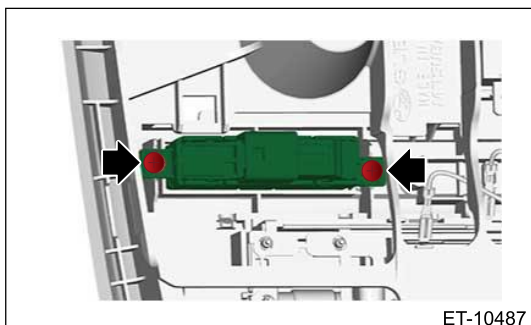

- (2) Remove the screws from the frame clearance, and remove the telematics button.



INSTALLATION

1. AUDIO STEERING SWITCH

Caution:
Before handling the airbag system components, refer to "CAUTION" of "General Description" in "AIRBAG SYSTEM".  **Ref. to AIRBAG SYSTEM>General Description>CAUTION.**

1. Install the audio steering switch.  [Ref. to POWER ASSISTED SYSTEM \(POWER STEERING\)>Steering Wheel>ASSEMBLY.](#)
2. Align the center position of the steering roll connector.  [Ref. to AIRBAG SYSTEM>Roll Connector>ADJUSTMENT.](#)
3. Install the steering wheel assembly.  [Ref. to POWER ASSISTED SYSTEM \(POWER STEERING\)>Steering Wheel>INSTALLATION.](#)
4. Install the driver's airbag module.  [Ref. to AIRBAG SYSTEM>Driver's Airbag Module>INSTALLATION.](#)
5. Connect the ground terminal to battery sensor.  [Ref. to REPAIR CONTENTS>NOTE > BATTERY.](#)

2. TELEMATICS BUTTON

1. Install the telematics button.
2. Install the light assembly map.  [Ref. to LIGHTING SYSTEM>Spot Map Light>INSTALLATION.](#)
3. Connect the ground terminal to battery sensor.  [Ref. to REPAIR CONTENTS>NOTE > BATTERY.](#)

INSPECTION

1. AUDIO STEERING SWITCH

1. Measure the resistance between connector terminals.

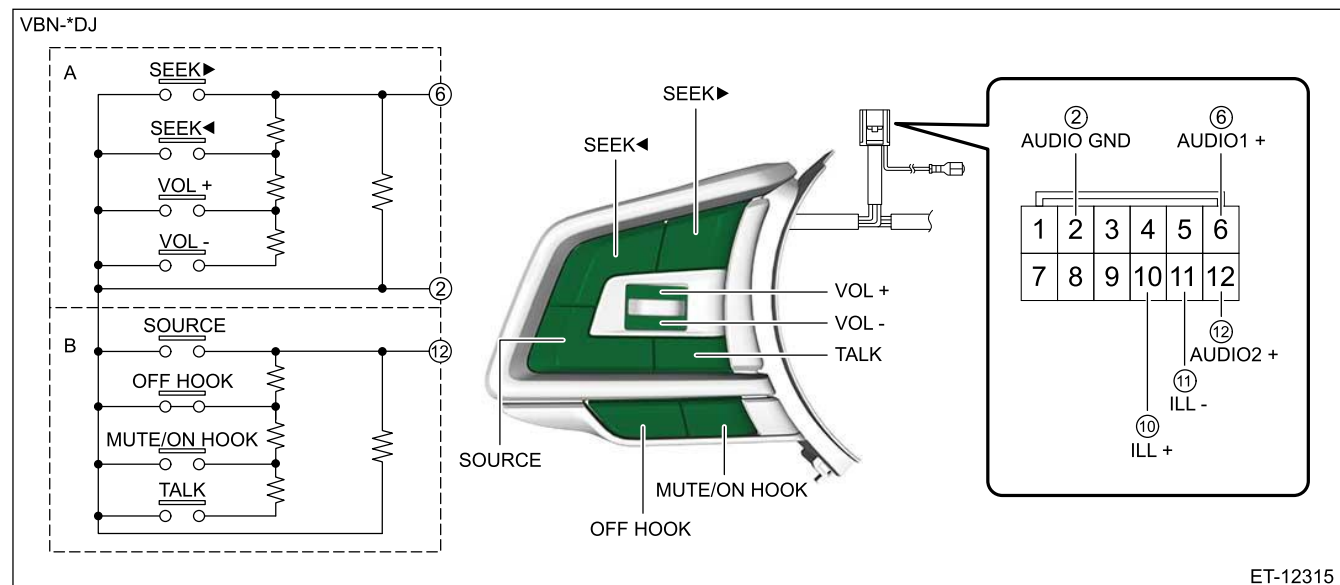

Terminal No.	Inspection conditions	Standard
6 - 2	SEEK (>) SEEK (<)	A circuit is all OFF. Approx. 100 kΩ

Terminal No.	Inspection conditions		Standard
	VOL (+)		
	VOL (-)		
	SEEK (>)	ON	Less than 1 Ω
	SEEK (<)	ON	Approx. 330 Ω
	VOL (+)	ON	Approx. 1,000 Ω
	VOL (-)	ON	Approx. 3,110 Ω
12 – 2	SOURCE OFF HOOK MUTE / ON HOOK TALK	B circuit is all OFF.	Approx. 100 k Ω
	SOURCE	ON	Less than 1 Ω
	OFF HOOK	ON	Approx. 330 Ω
	MUTE / ON HOOK	ON	Approx. 1,000 Ω
	TALK	ON	Approx. 3,110 Ω

2. Apply battery voltage between the connector terminals to check lighting condition of illumination inside the switch.

Caution:

When applying battery voltage, do not mix up the positive (+) side and the negative (-) side.

Incorrect polarity connection may cause LED damage inside the switch.

Terminal No.	Inspection conditions	Specification
10 (+) – 11 (-)	Apply battery voltage	Light On

3. Replace the audio steering switch if it is found defective as a result of the measurement.

2. TELEMATICS BUTTON

1. Check the button.
(1) Measure the resistance between connector terminals.

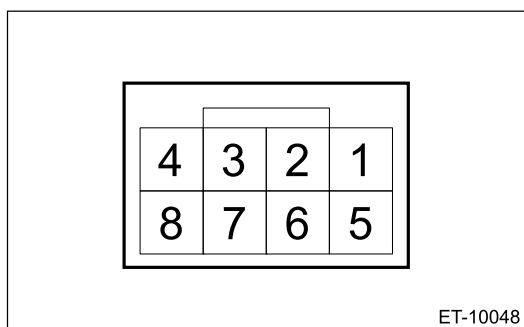

- SOS button

Terminal No.	Inspection conditions	Standard
6 – 1	OFF	Approx. 1.6 k Ω
	ON	Less than 1 Ω

- i-button

Terminal No.	Inspection conditions	Standard
3 – 1	OFF	Approx. 1.6 k Ω
	ON	Less than 1 Ω

(2) Apply battery voltage between the connector terminals to check lighting condition of illumination inside the switch.

Caution:

When applying battery voltage, do not mix up the positive (+) side and the negative (-) side.

Incorrect polarity connection may cause LED damage inside the switch.

Terminal No.	Inspection conditions	Specification
8 (+) – 2 (-)	Apply battery voltage	Light On

2. Check the indicator.

(1) Apply battery voltage between the connector terminals to check the lighting condition of the indicator.

Caution:

When applying battery voltage, do not mix up the positive (+) side and the negative (-) side.

Incorrect polarity connection may cause LED damage inside the switch.

Terminal No.	Inspection conditions	Specification
4 (+) – 1 (-)	Apply battery voltage	Illuminating in green
7 (+) – 1 (-)		Illuminating in red
4 (+) – 1 (-) and 8 (+) – 2 (-)	Apply battery voltage simultaneously.	Indicator turns on in dimmed condition at one level.
7 (+) – 1 (-) and 8 (+) – 2 (-)		

3. Replace the telematics button if it is found defective.

ENTERTAINMENT & MONITORING > Microphone

NOTE

The microphone is integrated into the light assembly map.

For operation procedures for the microphone, refer to "Spot Map Light" in the "LIGHTING SYSTEM" section.

 [Ref. to LIGHTING SYSTEM>Spot Map Light.](#)

ENTERTAINMENT & MONITORING > Microphone

INSPECTION

- 1.** Perform the microphone check.  [Ref. to COCKPIT CONTROL \(DIAGNOSTICS\)>Dealership Mode.](#)
- 2.** Replace the light assembly map if it is found defective.

ENTERTAINMENT & MONITORING > Telematics System

WIRING DIAGRAM

For the wiring diagram, refer to "Telematics System" in the wiring diagram.  [Ref. to WIRING SYSTEM>Telematics System>WIRING DIAGRAM.](#)

ENTERTAINMENT & MONITORING > Telematics System

INSPECTION

1. BASIC INSPECTION

For basic inspection, refer to "Basic Diagnostic Procedure" in "TELEMATICS SYSTEM (DIAGNOSTICS)".  [Ref. to TELEMATICS SYSTEM \(DIAGNOSTICS\)>Basic Diagnostic Procedure.](#)

2. SYSTEM BLOCK DIAGRAM

For system block diagram, refer to "System Block Diagram" in "TELEMATICS SYSTEM (DIAGNOSTICS)".  [Ref. to TELEMATICS SYSTEM \(DIAGNOSTICS\)>General Description>SYSTEM BLOCK DIAGRAM.](#)

3. MODULE I/O SIGNAL

For the specification (electrical component), refer to "Control Module I/O Signal" in "TELEMATICS SYSTEM (DIAGNOSTICS)".  [Ref. to TELEMATICS SYSTEM \(DIAGNOSTICS\)>Control Module I/O Signal>SPECIFICATION.](#)

ENTERTAINMENT & MONITORING > Telematics System

OPERATION

1. REGISTRATION (COMM CHECK)

Caution:

Do not press and hold the i-button for more than two seconds during communication check, or settings will return to factory mode in poor radio wave environment. If the settings has returned to factory mode, perform the communication check again. To check the mode status, see "Subscription Status" in the current data display on Subaru Select Monitor.

1. If Subaru Select Monitor is connected, disconnect it from the data link connector.
2. Replace the data communication module with a new part.
3. Check that the LED of the telematics button illuminates green.
4. Register the immobilizer. For detailed operation procedure, refer to "Type H" described in "REGISTRATION MANUAL FOR IMMOBILIZER".
5. Press and hold the i-button for 2 seconds or more.

Note:

- When the subscription is completed, the telematics system will automatically activate.
- During Comm Check, LED blinks in green and red alternately.

6. After the LED stops blinking, select [Subscription Status] in [Data monitor] of [Telematics] using Subaru Select Monitor, and check that [Subscribed] or [Unsubscribed] is set.  [Ref. to COMMON \(DIAGNOSTICS\)>Data Monitor.](#)

Caution:

If [Subscription Status] is [Comm Check] or [Factory Mode], Comm Check was not completed successfully. Check radio wave environment and that the diagnostic trouble code (DTC) is not detected, and then perform the following procedures.

- [Comm Check]: Turn the ignition switch to OFF and check that the LED is off, and then turn the ignition switch to ON. After Comm Check is automatically performed, check [Subscription Status] again.
- [Factory Mode]: Turn the ignition switch to OFF and check that LED is off, and then perform Comm Check again.

7. Turn the ignition switch to OFF and perform the opening → closing of the driver's door.
8. Wait for 5 minutes with all doors (including the front hood) closed and then check the link status with the server system.

Caution:

If the server has a malfunction, it may not operate normally.

- At normal condition

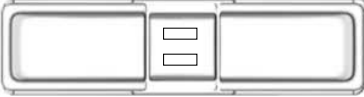
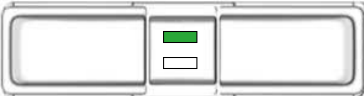
LED status	Subscription contents	Contents
<p>VN-*AJ</p>  <p>ET-11474</p>	<p>Without subscription of SUBARU STARLINK</p>	<p>Comm Check and communication establishment completed</p>
<p>VN-*AJ</p>  <p>ET-11475</p>	<p>With subscription of SUBARU STARLINK</p>	

- In malfunction

LED status	Cause	Corrective action
<p data-bbox="121 401 188 422">VN-*AJ</p>  <p data-bbox="550 695 636 716">ET-11476</p>	<p data-bbox="651 405 959 548">Comm Check cannot be performed normally due to poor radio wave environment.</p>	<p data-bbox="980 191 1403 296">Perform Comm Check again in a location with good radio wave environment.</p> <div data-bbox="980 302 1440 457" style="border: 1px solid black; padding: 5px;"> <p data-bbox="980 308 1062 333">Note:</p> <p data-bbox="1005 346 1430 451">Radio wave reception condition can be checked using Subaru Select Monitor.</p> </div> <ol data-bbox="992 464 1430 762" style="list-style-type: none"> <li data-bbox="992 464 1430 531">1. Turn the ignition switch from OFF to ON. <li data-bbox="992 541 1430 762">2. Press and hold the i-button for 2 seconds or more to set to Factory mode, and press and hold the i-button for 2 seconds or more again to perform Comm Check.
	<p data-bbox="651 779 959 921">Comm Check cannot be performed normally as the server has a malfunction.</p>	<p data-bbox="980 779 1430 921">Call an authorized workshop and check that the serial number, IMEI number, and chassis number are correct.</p>

ENTERTAINMENT & MONITORING > Telematics System

NOTE

For operation procedures of components in the telematics system, refer to the following sections.

Note:





For the CAN communication system, refer to the LAN system.  **[Ref. to LAN SYSTEM \(DIAGNOSTICS\)>Electrical Component Location.](#)**

- Data communication module:  [Ref. to ENTERTAINMENT & MONITORING>Data Communication Module.](#)
- Antenna:  [Ref. to ENTERTAINMENT & MONITORING>Antenna.](#)
- Telematics button:  [Ref. to ENTERTAINMENT & MONITORING>Switches and Harness.](#)
- Front speaker:  [Ref. to ENTERTAINMENT & MONITORING>Front Speaker.](#)

ENTERTAINMENT & MONITORING > Data Communication Module

REMOVAL

1. DATA COMMUNICATION MODULE

1. Disconnect the ground terminal from battery sensor.  [Ref. to REPAIR CONTENTS>NOTE > BATTERY.](#)
2. Remove the driver monitoring unit.  [Ref. to INSTRUMENTATION/DRIVER INFO>Driver Monitoring Unit>REMOVAL.](#)
3. Remove the ornament panel mid passenger and panel assembly center.  [Ref. to EXTERIOR/INTERIOR TRIM>Centor Cluster>REMOVAL.](#)
4. Remove the center information display assembly.  [Ref. to ENTERTAINMENT & MONITORING>Cockpit Display>REMOVAL.](#)
5. Remove the data communication module.
 - (1) Disconnect the cable CCM connector.
 - (2) Remove the screws and remove the data communication module.

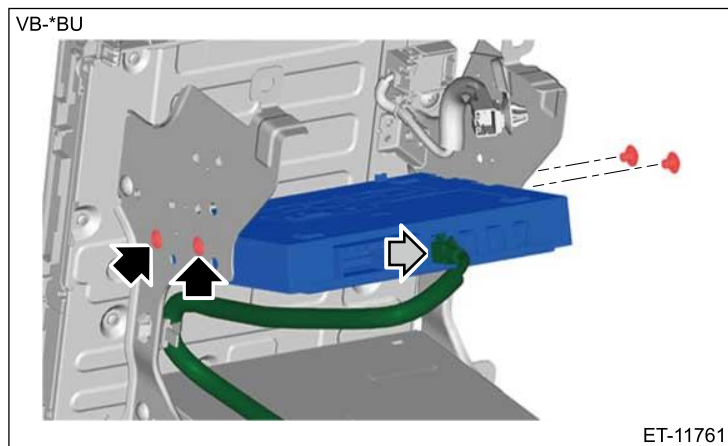



- (3) Remove the backup battery.  [Ref. to ENTERTAINMENT & MONITORING>Data Communication Module>REMOVAL > BACKUP BATTERY.](#)

Note:

Perform this procedure only when required.

2. BACKUP BATTERY

1. Disconnect the ground terminal from battery sensor.  [Ref. to REPAIR CONTENTS>NOTE > BATTERY.](#)
2. Remove the data communication module.  [Ref. to ENTERTAINMENT & MONITORING>Data Communication Module>REMOVAL > DATA COMMUNICATION MODULE.](#)
3. Remove the backup battery.
 - (1) Using TORX® T10, remove the cap screw, and then remove the battery cover.
 - (2) Disconnect the connector and remove the backup battery.

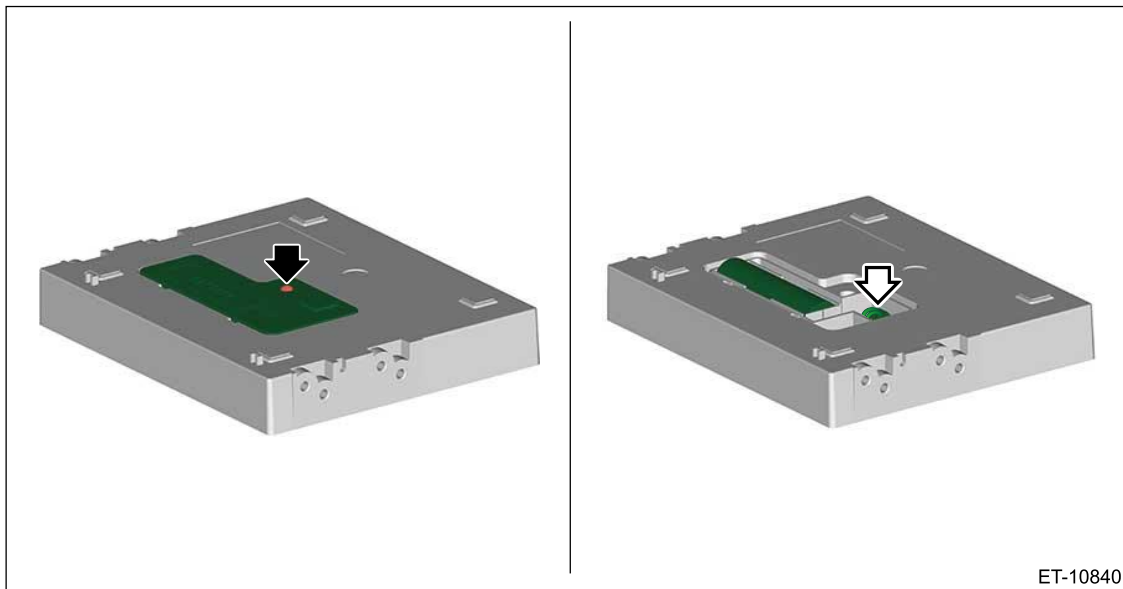

ET-10840

ENTERTAINMENT & MONITORING > Data Communication Module







INSTALLATION

1. DATA COMMUNICATION MODULE



1. Install the backup battery.  [Ref. to ENTERTAINMENT & MONITORING>Data Communication Module>INSTALLATION > BACKUP BATTERY.](#)
2. Install the data communication module and connect the cable CCM connector.

Caution:

Never install a data communication module from another vehicle. It may disable recognition of vehicle information and cause communication error.

3. Install the center information display assembly.  [Ref. to ENTERTAINMENT & MONITORING>Cockpit Display>INSTALLATION.](#)
4. Install the panel assembly center and the ornament panel mid passenger.  [Ref. to EXTERIOR/INTERIOR TRIM>Centor Cluster>INSTALLATION.](#)
5. Install the driver monitoring unit.  [Ref. to INSTRUMENTATION/DRIVER INFO>Driver Monitoring Unit>INSTALLATION.](#)
6. Connect the ground terminal to battery sensor.  [Ref. to REPAIR CONTENTS>NOTE > BATTERY.](#)
7. Perform the registration if the data communication module is replaced with a new part.  [Ref. to ENTERTAINMENT & MONITORING>Telematics System>OPERATION.](#)
8. Check the LED illumination status of the telematics button.  [Ref. to TELEMATICS SYSTEM \(DIAGNOSTICS\)>Check List for Interview>CHECK > LED ILLUMINATION STATUS LIST.](#)

2. BACKUP BATTERY

1. Install the backup battery, and connect the connector.
2. Install the battery cover using TORX® T10.
3. Install the data communication module.  [Ref. to ENTERTAINMENT & MONITORING>Data Communication Module>INSTALLATION > DATA COMMUNICATION MODULE.](#)
4. Connect the ground terminal to battery sensor.  [Ref. to REPAIR CONTENTS>NOTE > BATTERY.](#)

INSPECTION

1. BACKUP BATTERY

1. Measure the voltage between connector terminals.

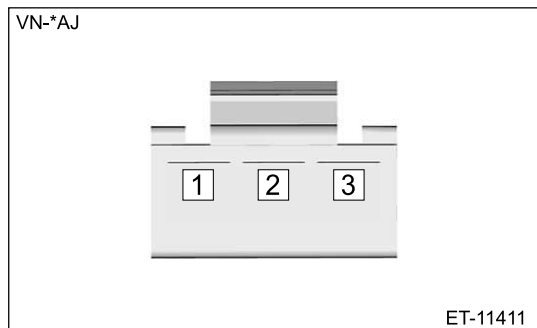

Terminal No.	Standard
1 (+) — 3 (-)	2 V or more

2. Replace the backup battery if the inspection result is not within the standard value.



ENTERTAINMENT & MONITORING > Camera

WIRING DIAGRAM

For the wiring diagram, refer to "Rearview Camera System" in the wiring diagram.  [Ref. to WIRING SYSTEM>Rearview Camera System>WIRING DIAGRAM.](#)

ENTERTAINMENT & MONITORING > Camera



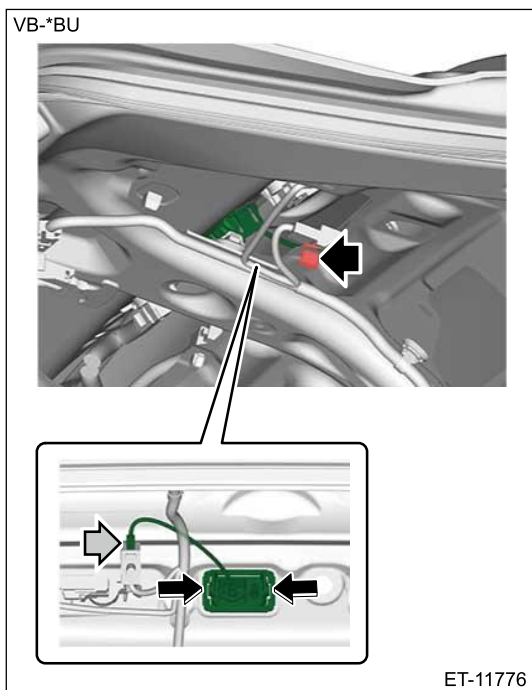

REMOVAL

1. Disconnect the ground terminal from battery sensor.  [Ref. to REPAIR CONTENTS>NOTE > BATTERY.](#)
2. Remove the trim panel trunk lid.  [Ref. to EXTERIOR/INTERIOR TRIM>Trunk Room Trim>REMOVAL.](#)
3. Remove the garnish assembly trunk.  [Ref. to EXTERIOR/INTERIOR TRIM>Trunk Lid Garnish>REMOVAL.](#)
4. Remove the rearview camera assembly.
 - (1) Remove the connector clip, and disconnect the connector.
 - (2) Disconnect the claws and then remove the rearview camera assembly.



ENTERTAINMENT & MONITORING > Camera

INSTALLATION

1. Install the rearview camera assembly and connect the connector.
2. Install the garnish assembly trunk.  [Ref. to EXTERIOR/INTERIOR TRIM>Trunk Lid Garnish>INSTALLATION.](#)
3. Install the trim panel trunk lid.  [Ref. to EXTERIOR/INTERIOR TRIM>Trunk Room Trim>INSTALLATION.](#)
4. Connect the ground terminal to battery sensor.  [Ref. to REPAIR CONTENTS>NOTE > BATTERY.](#)
5. Confirm the display and the guide line position, and adjust them as necessary.
 - Screen display check:  [Ref. to COCKPIT CONTROL \(DIAGNOSTICS\)>Customize.](#)

- Guide line position check: The rearview camera or its installation location on the vehicle may be deformed. Check the rearview camera assembly and its installation location on the vehicle, and repair or replace if necessary.

ENTERTAINMENT & MONITORING > Accessory Power Supply Socket

WIRING DIAGRAM

1. FRONT ACCESSORY POWER SUPPLY SOCKET

For the wiring diagram, refer to "Front Accessory Power Supply Socket System" in the wiring diagram. 
[Ref. to WIRING SYSTEM>Front Accessory Power Supply Socket System>WIRING DIAGRAM.](#)

2. REAR ACCESSORY POWER SUPPLY SOCKET

For the wiring diagram, refer to "Rear Accessory Power Supply Socket System" in the wiring diagram. 
[Ref. to WIRING SYSTEM>Rear Accessory Power Supply Socket System>WIRING DIAGRAM.](#)







ENTERTAINMENT & MONITORING > Accessory Power Supply Socket

REMOVAL

1. FRONT

Caution:

Before handling the airbag system components, refer to "CAUTION" of "General Description" in "AIRBAG SYSTEM".  [Ref. to AIRBAG SYSTEM>General Description>CAUTION.](#)

- 1.** Disconnect the ground terminal from the battery sensor, and wait for at least 60 seconds before starting work.  [Ref. to REPAIR CONTENTS>NOTE > BATTERY.](#)
- 2.** Remove the driver monitoring unit.  [Ref. to INSTRUMENTATION/DRIVER INFO>Driver Monitoring Unit>REMOVAL.](#)
- 3.** Remove the ornament panel mid passenger and panel assembly center.  [Ref. to EXTERIOR/INTERIOR TRIM>Centor Cluster>REMOVAL.](#)
- 4.** Remove the cover LWR driver.  [Ref. to EXTERIOR/INTERIOR TRIM>Instrument Panel Lower Cover>REMOVAL.](#)
- 5.** Remove the panel starter switch.  [Ref. to SECURITY AND LOCKS>Push Button Ignition Switch>REMOVAL.](#)
- 6.** Remove the console box assembly.  [Ref. to EXTERIOR/INTERIOR TRIM>Console Box>REMOVAL.](#)
- 7.** Remove the cover center side.  [Ref. to EXTERIOR/INTERIOR TRIM>Center Console>REMOVAL.](#)
- 8.** Remove the tray center UPR.
 - (1) Release the clips.
 - MT model

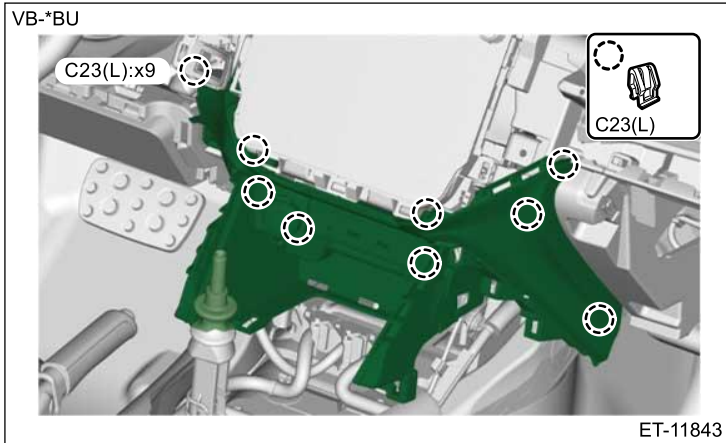

- CVT model

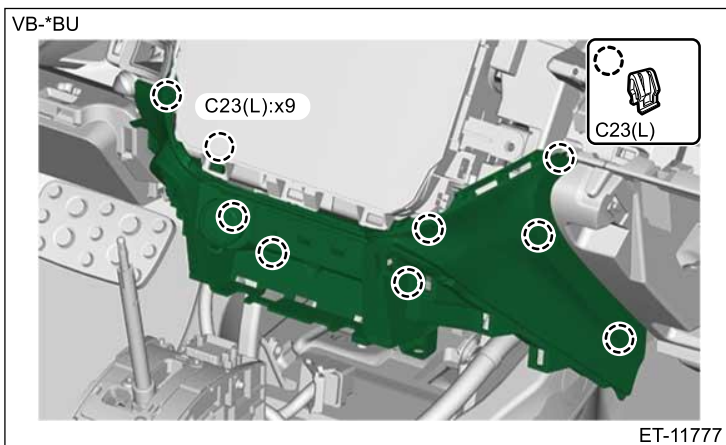

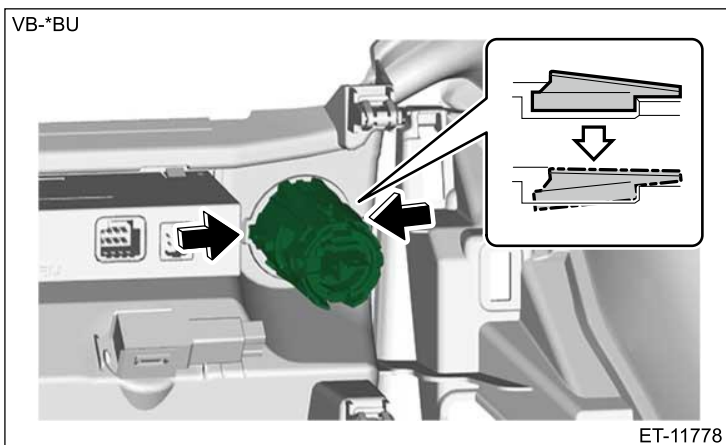

(2) Disconnect each connector and remove the tray center UPR.

9. While releasing the claw, press it in from the rear to remove the socket assembly.



2. REAR

1. Disconnect the ground terminal from battery sensor.  [Ref. to REPAIR CONTENTS>NOTE > BATTERY.](#)
2. Remove the cover assembly front.  [Ref. to EXTERIOR/INTERIOR TRIM>Console Box>REMOVAL.](#)
3. Remove the socket assembly.
 - (1) Disconnect the connector.
 - (2) While releasing the claw, press it in from the rear to remove the socket assembly.

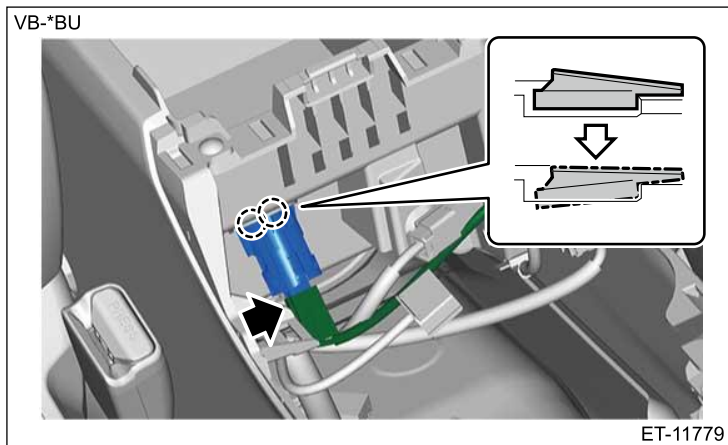









ENTERTAINMENT & MONITORING > Accessory Power Supply Socket

INSTALLATION



1. FRONT

Caution:

Before handling the airbag system components, refer to "CAUTION" of "General Description" in "AIRBAG SYSTEM".  [Ref. to AIRBAG SYSTEM>General Description>CAUTION.](#)

1. Align the claw of the socket assembly with the groove of the tray center UPR, and install the socket assembly.
2. Connect each connector and install the tray center UPR.
3. Install the cover center side.  [Ref. to EXTERIOR/INTERIOR TRIM>Center Console>INSTALLATION.](#)
4. Install the console box assembly.  [Ref. to EXTERIOR/INTERIOR TRIM>Console Box>INSTALLATION.](#)
5. Install the panel starter switch.  [Ref. to SECURITY AND LOCKS>Push Button Ignition Switch>INSTALLATION.](#)
6. Install the cover LWR driver.  [Ref. to EXTERIOR/INTERIOR TRIM>Instrument Panel Lower Cover>INSTALLATION.](#)
7. Install the panel assembly center and the ornament panel mid passenger.  [Ref. to EXTERIOR/INTERIOR TRIM>Centor Cluster>INSTALLATION.](#)
8. Install the driver monitoring unit.  [Ref. to INSTRUMENTATION/DRIVER INFO>Driver Monitoring Unit>INSTALLATION.](#)
9. Connect the ground terminal to battery sensor.  [Ref. to REPAIR CONTENTS>NOTE > BATTERY.](#)

2. REAR







1. Install the socket assembly.
 - (1) Align the claw of the socket assembly with the groove of the console box assembly.
 - (2) Install the socket assembly and connect the connector.
2. Install the cover assembly front.  [Ref. to EXTERIOR/INTERIOR TRIM>Console Box>INSTALLATION.](#)
3. Connect the ground terminal to battery sensor.  [Ref. to REPAIR CONTENTS>NOTE > BATTERY.](#)

REMOVAL

1. FRONT

Caution:

Before handling the airbag system components, refer to "CAUTION" of "General Description" in "AIRBAG SYSTEM".  [Ref. to AIRBAG SYSTEM>General Description>CAUTION.](#)

1. Disconnect the ground terminal from the battery sensor, and wait for at least 60 seconds before starting work.  [Ref. to REPAIR CONTENTS>NOTE > BATTERY.](#)
2. Remove the driver monitoring unit.  [Ref. to INSTRUMENTATION/DRIVER INFO>Driver Monitoring Unit>REMOVAL.](#)
3. Remove the ornament panel mid passenger and panel assembly center.  [Ref. to EXTERIOR/INTERIOR TRIM>Centor Cluster>REMOVAL.](#)
4. Remove the cover LWR driver.  [Ref. to EXTERIOR/INTERIOR TRIM>Instrument Panel Lower Cover>REMOVAL.](#)
5. Remove the panel starter switch.  [Ref. to SECURITY AND LOCKS>Push Button Ignition Switch>REMOVAL.](#)
6. Remove the console box assembly.  [Ref. to EXTERIOR/INTERIOR TRIM>Console Box>REMOVAL.](#)
7. Remove the cover center side.  [Ref. to EXTERIOR/INTERIOR TRIM>Center Console>REMOVAL.](#)
8. Remove the tray center UPR.
 - (1) Release the clips.
 - MT model

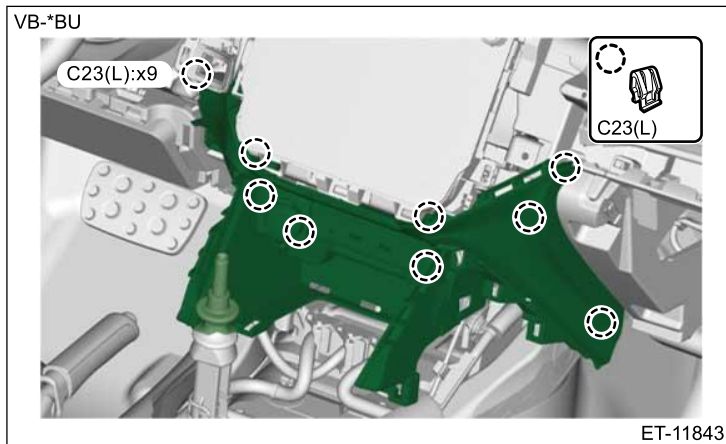

- CVT model

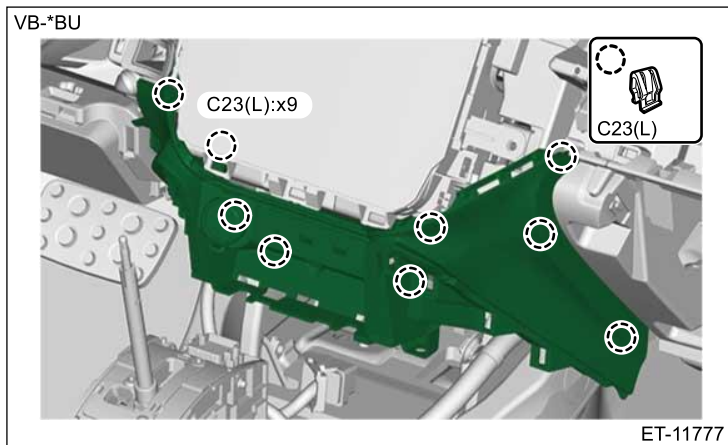

(2) Disconnect each connector and remove the tray center UPR.

9. While removing the claw, press it in from the rear to remove the AUX unit assembly.

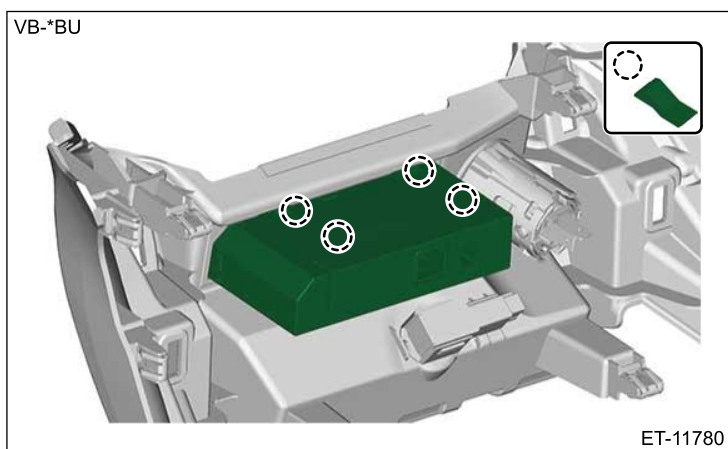

2. REAR

1. Disconnect the ground terminal from battery sensor. [🔧 Ref. to REPAIR CONTENTS>NOTE > BATTERY.](#)
2. Remove the console box assembly. [🔧 Ref. to EXTERIOR/INTERIOR TRIM>Console Box>REMOVAL.](#)
3. Remove the AUX unit assembly power. [🔧 Ref. to EXTERIOR/INTERIOR TRIM>Console Box>DISASSEMBLY.](#)

ENTERTAINMENT & MONITORING > External Connection Terminal





INSTALLATION

1. FRONT



Caution:

Before handling the airbag system components, refer to "CAUTION" of "General Description" in "AIRBAG SYSTEM". [🔧 Ref. to AIRBAG SYSTEM>General Description>CAUTION.](#)

1. Install the AUX unit assembly.
2. Connect each connector and install the tray center UPR.
3. Install the cover center side. [🔧 Ref. to EXTERIOR/INTERIOR TRIM>Center Console>INSTALLATION.](#)
4. Install the console box assembly. [🔧 Ref. to EXTERIOR/INTERIOR TRIM>Console Box>INSTALLATION.](#)

5. Install the panel starter switch.  [Ref. to SECURITY AND LOCKS>Push Button Ignition Switch>INSTALLATION.](#)
6. Install the cover LWR driver.  [Ref. to EXTERIOR/INTERIOR TRIM>Instrument Panel Lower Cover>INSTALLATION.](#)
7. Install the panel assembly center and the ornament panel mid passenger.  [Ref. to EXTERIOR/INTERIOR TRIM>Center Cluster>INSTALLATION.](#)
8. Install the driver monitoring unit.  [Ref. to INSTRUMENTATION/DRIVER INFO>Driver Monitoring Unit>INSTALLATION.](#)
9. Connect the ground terminal to battery sensor.  [Ref. to REPAIR CONTENTS>NOTE > BATTERY.](#)



2. REAR

1. Install the AUX unit assembly power.  [Ref. to EXTERIOR/INTERIOR TRIM>Console Box>ASSEMBLY.](#)
2. Install the console box assembly.  [Ref. to EXTERIOR/INTERIOR TRIM>Console Box>INSTALLATION.](#)
3. Connect the ground terminal to battery sensor.  [Ref. to REPAIR CONTENTS>NOTE > BATTERY.](#)

ENTERTAINMENT & MONITORING > Diagnostics with Phenomenon

INSPECTION

For the diagnosis of each phenomenon, refer to the following sections.

- Refer to “Diagnostics with Phenomenon” of “COCKPIT CONTROL (DIAGNOSTICS)” section.  [Ref. to COCKPIT CONTROL \(DIAGNOSTICS\)>Diagnostics with Phenomenon.](#)
- Refer to “Diagnostics with Phenomenon” of “TELEMATICS (DIAGNOSTICS)” section.  [Ref. to TELEMATICS SYSTEM \(DIAGNOSTICS\)>Diagnostics with Phenomenon.](#)

ENTERTAINMENT & MONITORING > Dealership Mode

NOTE

For dealership mode, refer to “Dealership Mode” of “COCKPIT CONTROL (DIAGNOSTICS)” section.  [Ref. to COCKPIT CONTROL \(DIAGNOSTICS\)>Dealership Mode.](#)

1. General Description
2. Relay and Fuse
3. Power Window System
4. Power Window Control Switch
5. Front Door Glass
6. Front Regulator and Motor Assembly
7. Remote Control Mirror System
8. Outer Mirror Assembly
9. Remote Control Mirror Switch
10. Rearview Mirror
11. Rear Door Glass
12. Rear Regulator and Motor Assembly
13. Windshield Glass
14. Rear Window Glass
15. Rear Window Defogger System
16. Wiper Deicer System

GLASS/WINDOWS/MIRRORS > General Description

CAUTION

- When performing service operation, refer to "Repair Contents" in "General Description". [Ref. to REPAIR CONTENTS>Repair Contents.](#)
- Refer to "CAUTION" of "General Description" in "AIRBAG SYSTEM" section. [Ref. to AIRBAG SYSTEM>General Description>CAUTION.](#)
- When performing work on the sensors or modules, be careful of the following.
 - Before disconnecting electrical connectors, be sure to disconnect the ground terminal from the battery sensor. [Ref. to REPAIR CONTENTS>NOTE > BATTERY.](#)
 - Do not apply any impact. If the parts are accidentally dropped, replace with a new part.
 - Do not expose to high-temperature and humidity.
- When replacing the parts provided with memory functions, record the memory contents before disconnecting the ground terminal from the battery sensor.
- Apply grease onto sliding or revolving surfaces before installation.
- Avoid impact and damage to the glass.

GLASS/WINDOWS/MIRRORS > General Description

COMPONENT

1. FIXED GLASS

- | | | |
|-----------------------------|------------------------------|----------------------------|
| (1) Dam rubber windshield | (5) Seal upper | (8) Molding rear window |
| (2) Seal lower | (6) Molding windshield | (9) Dam rubber rear window |
| (3) Glass windshield | (7) Locating pin rear window | (10) Glass rear window |
| (4) Locating pin windshield | | |

Note:

Inner mirror base cannot be removed from the windshield glass.

2. FRONT DOOR GLASS

(1) Glass front door partition	(5) Sash ASSY partition	<i>Tightening torque: N·m (kgf-m, ft-lb)</i>
(2) Glass ASSY front door	(6) Regulator & motor ASSY front	<i>T1: 2.2 (0.2, 1.6)</i>
(3) Weather strip front door partition	(7) Sash ASSY front door LWR	<i>T2: 7.5 (0.8, 5.5)</i>
(4) Running channel front door		

3. REAR DOOR GLASS

(1) Glass ASSY rear door	(4) Weather strip rear door partition	<i>Tightening torque: N·m (kgf-m, ft-lb)</i>
(2) Running channel rear door	(5) Regulator & motor ASSY rear	<i>T1: 2.2 (0.2, 1.6)</i>
(3) Glass rear door partition	(6) Sash ASSY rear door partition	<i>T2: 7.5 (0.8, 5.5)</i>

4. OUTER MIRROR

- | | | |
|--|--|---|
| (1) Blind Spot Detection/Rear Cross Traffic Alert system indicator (model with Blind Spot Detection/Rear Cross Traffic Alert system) | (5) Light ASSY side turn mirror (model with side turn light) | <i>Tightening torque: N·m (kgf-m, ft-lb)</i> |
| (2) Mirror repair | (6) Cover cap outer mirror LWR (model with side turn light) | <i>T: 7.5 (0.8, 5.5)</i> |
| (3) Mirror unit door | (7) Cover cap outer mirror LWR (model without side turn light) | |
| (4) Cover cap outer mirror | (8) Cover mirror body | |

5. REAR VIEW MIRROR

(1) Mirror ASSY inner rearview

GLASS/WINDOWS/MIRRORS > General Description

PREPARATION TOOL

1. SUBARU SPECIAL TOOL

ILLUSTRATION	TOOL NUMBER	DESCRIPTION	REMARKS
	—	SUBARU SELECT MONITOR 4	Used for setting of each function and troubleshooting for electrical system. Note: <ul style="list-style-type: none">• For detailed operation procedures, refer to "Help" of application.• Used together with interface for Subaru Select Monitor (such as DST-i and DST-010).

2. OTHER

	REMARKS
Circuit tester	Used for measuring resistance, voltage and current.
Piano wire	Used for removing the fixed glass.
Cutter knife	Used for removing the fixed glass.
Windshield glass knife	Used for removing the fixed glass.

GLASS/WINDOWS/MIRRORS > Relay and Fuse

LOCATION

For the location, refer to "FUSE AND RELAY" in the wiring diagram. [Ref. to WIRING SYSTEM>Fuse And Relay.](#)

Note:

For details of relay and fuse, refer to "DC POWER SUPPLY CIRCUIT". [Ref. to WIRING SYSTEM>Power Supply Circuit.](#)

GLASS/WINDOWS/MIRRORS > Relay and Fuse

REMOVAL

1. CIRCUIT BREAKER

Caution:

Before handling the airbag system components, refer to "CAUTION" of "General Description" in "AIRBAG SYSTEM". [Ref. to AIRBAG SYSTEM>General Description>CAUTION.](#)

1. Disconnect the ground terminal from the battery sensor, and wait for at least 60 seconds before starting work. [Ref. to REPAIR CONTENTS>NOTE > BATTERY.](#)
2. Remove the cover LWR driver. [Ref. to EXTERIOR/INTERIOR TRIM>Instrument Panel Lower Cover>REMOVAL.](#)
3. Remove the circuit breaker.
 - (1) Disconnect the connector.
 - (2) Release the clip, and remove the circuit breaker.

Caution:

Be careful not to apply excessive force when pulling the clip, as the clip may become damaged.

GLASS/WINDOWS/MIRRORS > Relay and Fuse

INSTALLATION

1. CIRCUIT BREAKER

Caution:

Before handling the airbag system components, refer to "CAUTION" of "General Description" in "AIRBAG SYSTEM". [Ref. to AIRBAG SYSTEM>General Description>CAUTION.](#)

1. Install the circuit breaker and connect the connector.
2. Install the cover LWR driver. [Ref. to EXTERIOR/INTERIOR TRIM>Instrument Panel Lower Cover>INSTALLATION.](#)
3. Connect the ground terminal to battery sensor. [Ref. to REPAIR CONTENTS>NOTE > BATTERY.](#)

GLASS/WINDOWS/MIRRORS > Relay and Fuse

INSPECTION

1. CHECK FUSE

1. Remove the fuse and inspect visually.
2. If the fuse is blown out, replace the fuse.

2. CHECK RELAY

1. Check the resistance between relay terminals.

Terminal No.	Inspection conditions	Standard	Circuit
1 – 2	Always	1 MΩ or more	
1 – 2	Apply battery voltage between terminals 4 and 3.	Less than 1 Ω	

2. Replace the relay if the inspection result is not within the standard value.

3. CHECK CIRCUIT BREAKER

1. Check the continuity between the circuit breaker terminals.

Terminal No.	Inspection conditions	Specification	Circuit
1 – 2	Always	Continuity exists	

2. Replace the circuit breaker if it is found defective.

GLASS/WINDOWS/MIRRORS > Power Window System

WIRING DIAGRAM

For the wiring diagram, refer to "Power Window System" in the wiring diagram. [Ref. to WIRING SYSTEM>Power Window System>WIRING DIAGRAM.](#)

GLASS/WINDOWS/MIRRORS > Power Window System

INSPECTION

1. BASIC INSPECTION

For basic inspection, refer to "Basic Diagnostic Procedure" of "POWER WINDOW (DIAGNOSTICS)" section. [Ref. to POWER WINDOW\(DIAGNOSTICS\) >Basic Diagnostic Procedure.](#)

2. SYSTEM BLOCK DIAGRAM

For system block diagram, refer to "System Block Diagram" in "POWER WINDOW (DIAGNOSTICS)" section. [Ref. to POWER WINDOW\(DIAGNOSTICS\) >General Description>SYSTEM BLOCK DIAGRAM.](#)

3. MODULE I/O SIGNAL

For the specification (electrical component), refer to "Control Module I/O Signal" of "POWER WINDOW (DIAGNOSTICS)" section. [Ref. to POWER WINDOW\(DIAGNOSTICS\) >Control Module I/O Signal.](#)

GLASS/WINDOWS/MIRRORS > Power Window System

OPERATION

1. INITIAL SETTING

This procedure performs settings of the following data.

- Top dead position
- Bottom dead position
- Sliding resistance value

Note:

- **Always perform the initialization with the vehicle parked. (Initialization cannot be operated during driving)**
- **Perform initialization for one seat at a time.**
- **Do not hit or apply impact or vibration to the glass, since the sliding resistance of door glass is being learned during the initialization.**
- **Do not perform the ignition operation during the initialization.**
- **The initialization is not required for the rear seats if the auto function is unavailable.**

Perform the initialization according to the procedures by items below.

Item	Procedure
When the regulator and motor assembly is replaced with a new part	A
When the motor power supply is lost due to removing and installing of the battery terminals and the regulator & motor assembly connector during the power window operation	A
When the power window system was initialized by the Subaru Select Monitor	A

Item	Procedure
When a power window related part such as glass and running channel was replaced	B
When the phenomenon that the door glass does not close fully (incorrect reverse operation) occurred	B
When the phenomenon that the door glass does not open fully (incorrect stop operation) occurred	B

● **PROCEDURE A**

1. Turn the ignition switch to ON.
2. Operate the driver's side, passenger's side, rear right or rear left power window switch and hold the manual down operation, or hold the automatic down operation to fully open the relevant window. Continuously from that point, hold the switch for one second or longer.

Note:

- Wherever the glass is at any position, operate the switch in "DOWN" direction.
- For initialization for other than driver's seat, this can be done with the driver's side power window switch, or power window switch of each seat.

3. Operate the driver's side, passenger's side, rear right or rear left power window switch and hold the automatic up operation to fully close the relevant window. Continuously from that point, hold the switch for one second or longer.

Note:

- At this time, do not move the vehicle.
- For initialization for other than driver's seat, this can be done with the driver's side power window switch, or power window switch of each seat.

4. Perform the automatic down operation with the driver's side, passenger's side, rear right or rear left power window switch to check whether the window fully opens properly. Also, perform the automatic up operation to check whether the window fully closes properly.

Note:

- If the window does not fully open/close properly, repeat steps 1 to 4.
- For initialization for other than driver's seat, this can be done with the driver's side power window switch, or power window switch of each seat.

● **PROCEDURE B**

1. Turn the ignition switch to ON.
2. Using the Subaru Select Monitor, perform [System Initialization] in [Work Support] of [Power Window (Driver)], [Power Window (Passenger)], [Power Window (Rear Right)], or [Power Window (Rear Left)]. [Ref. to COMMON \(DIAGNOSTICS\)>Work Support.](#)
3. Operate the driver's side, passenger's side, rear right or rear left power window switch and hold the manual down operation, or hold the automatic down operation to fully open the relevant window. Continuously from that point, hold the switch for one second or longer.

Note:

- Wherever the glass is at any position, operate the switch in "DOWN" direction.
- For initialization for other than driver's seat, this can be done with the driver's side power window switch, or power window switch of each seat.

4. Operate the driver's side, passenger's side, rear right or rear left power window switch and hold the automatic up operation to fully close the relevant window. Continuously from that point, hold the switch for one second or longer.

Note:

- **At this time, do not move the vehicle.**
- **For initialization for other than driver's seat, this can be done with the driver's side power window switch, or power window switch of each seat.**

- 5.** Perform the automatic down operation with the driver's side, passenger's side, rear right or rear left power window switch to check whether the window fully opens properly. Also, perform the automatic up operation to check whether the window fully closes properly.

Note:

- **If the window does not fully open/close properly, repeat steps 1 to 4.**
- **For initialization for other than driver's seat, this can be done with the driver's side power window switch, or power window switch of each seat.**

GLASS/WINDOWS/MIRRORS > Power Window System

NOTE

For procedure of the components in the power window system, refer to the sections below.

- Power window control switch: [Ref. to GLASS/WINDOWS/MIRRORS>Power Window Control Switch.](#)
- Front door glass: [Ref. to GLASS/WINDOWS/MIRRORS>Front Door Glass.](#)
- Front regulator and motor assembly: [Ref. to GLASS/WINDOWS/MIRRORS>Front Regulator and Motor Assembly.](#)
- Rear door glass: [Ref. to GLASS/WINDOWS/MIRRORS>Rear Door Glass.](#)
- Rear regulator and motor assembly: [Ref. to GLASS/WINDOWS/MIRRORS>Rear Regulator and Motor Assembly.](#)

REMOVAL

1. MAIN SWITCH

Caution:

Before handling the airbag system components, refer to "CAUTION" of "General Description" in "AIRBAG SYSTEM". [Ref. to AIRBAG SYSTEM>General Description>CAUTION.](#)

1. Disconnect the ground terminal from the battery sensor, and wait for at least 60 seconds before starting work. [Ref. to REPAIR CONTENTS>NOTE > BATTERY.](#)
2. Remove the trim panel front door. [Ref. to EXTERIOR/INTERIOR TRIM>Door Trim>REMOVAL > FRONT DOOR.](#)
3. Remove the screws and remove the switch power window main.

2. SUB-SWITCH

● **SWITCH POWER WINDOW SUB FRONT**

For removal of the switch power window sub front on the passenger's seat, refer to the removal procedure of the switch power window main. [Ref. to GLASS/WINDOWS/MIRRORS>Power Window Control Switch>REMOVAL > MAIN SWITCH.](#)

● **SWITCH POWER WINDOW SUB REAR**

1. Disconnect the ground terminal from battery sensor. [Ref. to REPAIR CONTENTS>NOTE > BATTERY.](#)
2. Remove the trim panel rear door. [Ref. to EXTERIOR/INTERIOR TRIM>Door Trim>REMOVAL > REAR DOOR.](#)
3. Remove the screws and remove the switch power window sub rear.

GLASS/WINDOWS/MIRRORS > Power Window Control Switch

INSTALLATION

1. MAIN SWITCH

Caution:

- Before handling the airbag system components, refer to "CAUTION" of "General Description" in "AIRBAG SYSTEM". [Ref. to AIRBAG SYSTEM>General Description>CAUTION.](#)
- Use protective paper to avoid damage to the trim panel.

1. Install the switch power window main to the trim panel front door.
2. Install the trim panel front door. [Ref. to EXTERIOR/INTERIOR TRIM>Door Trim>INSTALLATION > FRONT DOOR.](#)
3. Connect the ground terminal to battery sensor. [Ref. to REPAIR CONTENTS>NOTE > BATTERY.](#)
4. Perform the initial setting of the power window system. [Ref. to GLASS/WINDOWS/MIRRORS>Power Window System>OPERATION.](#)

2. SUB-SWITCH

Caution:

Use protective paper to avoid damage to the trim panel.

● SWITCH POWER WINDOW SUB FRONT

For installation of the switch power window sub front on the passenger's seat, refer to the installation procedure of the switch power window main. [Ref. to GLASS/WINDOWS/MIRRORS>Power Window Control Switch>INSTALLATION > MAIN SWITCH.](#)

● SWITCH POWER WINDOW SUB REAR

1. Install the switch power window sub rear to the trim panel rear door.
2. Install the trim panel rear door. [Ref. to EXTERIOR/INTERIOR TRIM>Door Trim>INSTALLATION > REAR DOOR.](#)
3. Connect the ground terminal to battery sensor. [Ref. to REPAIR CONTENTS>NOTE > BATTERY.](#)
4. Perform the initial setting of the power window system. [Ref. to GLASS/WINDOWS/MIRRORS>Power Window System>OPERATION.](#)

GLASS/WINDOWS/MIRRORS > Power Window Control Switch

INSPECTION

Caution:

Since the power window switch is controlled by CPU, do not check continuity for switch alone with the circuit tester, except for the specified terminals. Performing continuity check with circuit tester may damage the power window switch circuit.

For power window system inspection, refer to "Basic Diagnostic Procedure" of "POWER WINDOW (DIAGNOSTICS)" section. [Ref. to POWER WINDOW\(DIAGNOSTICS\) >Basic Diagnostic Procedure.](#)

1. MAIN SWITCH

1. Measure the resistance between terminals of the switch power window main.

- Front seats auto specification
– Driver's seat main

Terminal No.	Inspection conditions	Standard
11 – 12	OFF	Less than 1 Ω
7 – 11		1 MΩ or more
7 – 12		
7 – 12	Manual up	Less than 1 Ω
7 – 11		1 MΩ or more
11 – 12		
7 – 11	Manual down	Less than 1 Ω
7 – 12		1 MΩ or more
11 – 12		

- Rear seat remote right (window lock OFF)

Terminal No.	Inspection conditions	Standard
1 – 7	OFF	Less than 1 Ω
2 – 7		

Terminal No.	Inspection conditions	Standard
7 – 16		1 MΩ or more
1 – 16 2 – 7	Manual up	Less than 1 Ω
1 – 2		1 MΩ or more
2 – 16 1 – 7	Manual down	Less than 1 Ω
1 – 2		1 MΩ or more

- Rear seat remote right (window lock ON)

Terminal No.	Inspection conditions	Standard
1 – 2	OFF	Less than 1 Ω
7 – 16		1 MΩ or more
1 – 16	Manual up	Less than 1 Ω
1 – 2 2 – 7		1 MΩ or more
2 – 16	Manual down	Less than 1 Ω
1 – 2 1 – 7		1 MΩ or more

- Rear seat remote left (window lock OFF)

Terminal No.	Inspection conditions	Standard
9 – 7 8 – 7	OFF	Less than 1 Ω
16 – 7		1 MΩ or more
16 – 9 8 – 7	Manual up	Less than 1 Ω
8 – 9		1 MΩ or more
16 – 8 9 – 7	Manual down	Less than 1 Ω
8 – 9		1 MΩ or more

- Rear seat remote left (window lock ON)

Terminal No.	Inspection conditions	Standard
9 – 8	OFF	Less than 1 Ω
16 – 7		1 MΩ or more
16 – 9	Manual up	Less than 1 Ω
8 – 7 9 – 8		1 MΩ or more
16 – 8	Manual down	Less than 1 Ω
9 – 8 9 – 7		1 MΩ or more

- All seats auto specification
 - Driver's seat main

Terminal No.	Inspection conditions	Standard
12 – 11	OFF	Less than 1 Ω
7 – 11		1 MΩ or more
7 – 12		
12 – 7	Manual up	Less than 1 Ω
7 – 11		1 MΩ or more
12 – 11		
11 – 7	Manual down	Less than 1 Ω
7 – 12		1 MΩ or more
11 – 12		

2. If the inspection result is not within the standard, replace the switch power window main.

2. SUB-SWITCH

SWITCH POWER WINDOW SUB FRONT

1. Measure the resistance between terminals of the switch power window sub front.

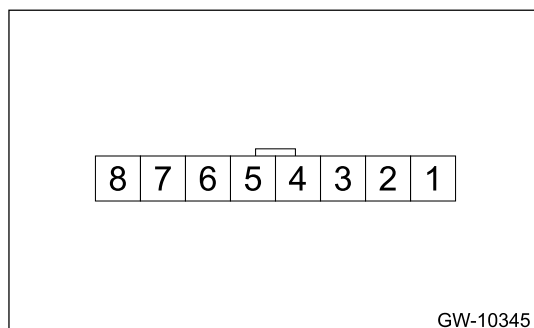

Terminal No.	Inspection conditions	Standard
6 – 5	OFF	Less than 1 Ω
2 – 1		1 MΩ or more
2 – 5		
2 – 6	Manual up	Less than 1 Ω
5 – 6		1 MΩ or more
2 – 5		
1 – 2	Auto up	Less than 1 Ω
2 – 6		1 MΩ or more
1 – 2		
5 – 6	Manual down	Less than 1 Ω
2 – 5		1 MΩ or more
2 – 6		
1 – 2	Auto down	Less than 1 Ω
2 – 5		1 MΩ or more
1 – 2		
5 – 6		1 MΩ or more

Terminal No.	Inspection conditions	Standard
2 – 6		

2. Apply battery voltage between the switch power window sub front terminals to check lighting condition of illumination inside the switch.

Caution:

When applying battery voltage, do not mix up the positive (+) side and the negative (-) side.

Incorrect polarity connection may cause LED damage inside the switch.

Terminal No.	Inspection conditions	Specification
7 (+) – 2 (-)	Apply battery voltage	Light ON

3. Replace the switch power window sub front if it is found defective from the inspection result.

SWITCH POWER WINDOW SUB REAR

1. Measure the resistance between terminals of the switch power window sub rear.
- Front seats auto specification

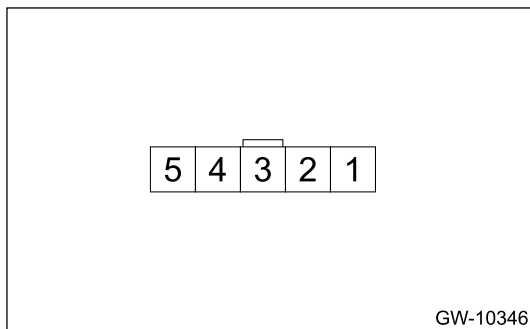

Terminal No.	Inspection conditions	Standard
1 – 4 5 – 2	OFF	Less than 1 Ω
2 – 3 3 – 4 1 – 3 3 – 5		1 MΩ or more
3 – 4 5 – 2	Manual up	Less than 1 Ω
1 – 4		1 MΩ or more
1 – 4 3 – 2	Manual down	Less than 1 Ω
5 – 2		1 MΩ or more

- All seats auto specification

Terminal No.	Inspection conditions	Standard
6 – 5	OFF	Less than 1 Ω
2 – 1		1 MΩ or more
2 – 5		
2 – 6		
2 – 6	Manual up	Less than 1 Ω
5 – 6		1 MΩ or more
2 – 5		
1 – 2		
2 – 6	Auto up	Less than 1 Ω
1 – 2		1 MΩ or more
5 – 6		
2 – 5		
2 – 5	Manual down	Less than 1 Ω
5 – 6		1 MΩ or more
2 – 6		
1 – 2		
2 – 5	Auto down	Less than 1 Ω
1 – 2		1 MΩ or more
5 – 6		
2 – 6		

2. Apply battery voltage between the switch power window sub rear terminals to check lighting condition of illumination inside the switch. (All seats auto specification)

Caution:

When applying battery voltage, do not mix up the positive (+) side and the negative (-) side.

Incorrect polarity connection may cause LED damage inside the switch.

Terminal No.	Inspection conditions	Specification
7 (+) – 2 (-)	Apply battery voltage	Light ON

3. Replace the switch power window sub rear if it is found defective from the inspection result.

REMOVAL

1. FRONT DOOR GLASS

Caution:

Before handling the airbag system components, refer to "CAUTION" of "General Description" in "AIRBAG SYSTEM". [Ref. to AIRBAG SYSTEM>General Description>CAUTION.](#)

- 1.** Operate the switch power window to move the glass assembly front door to the lowest position.
- 2.** Disconnect the ground terminal from the battery sensor, and wait for at least 60 seconds before starting work. [Ref. to REPAIR CONTENTS>NOTE > BATTERY.](#)
- 3.** Remove the trim panel front door. [Ref. to EXTERIOR/INTERIOR TRIM>Door Trim>REMOVAL > FRONT DOOR.](#)
- 4.** Remove the sealing cover door front. [Ref. to EXTERIOR BODY PANELS>Sealing_Cover>REMOVAL > FRONT SEALING COVER.](#)
- 5.** Release the clips, and remove the plate door and the pad front door inner.

Caution:

If it is removed with an excessive force, the door panel assembly may be deformed. Also, if the clip is damaged, replace it with a new clip.

- 6.** Remove the glass assembly front door.
 - (1) Remove the mounting bolts from the glass assembly front door.
 - (2) While tilting the glass, remove the glass assembly front door.

2. FRONT DOOR PARTITION GLASS

Caution:

Before handling the airbag system components, refer to "CAUTION" of "General Description" in "AIRBAG SYSTEM". [Ref. to AIRBAG SYSTEM>General Description>CAUTION.](#)

1. Disconnect the ground terminal from the battery sensor, and wait for at least 60 seconds before starting work. [Ref. to REPAIR CONTENTS>NOTE > BATTERY.](#)
2. Remove the glass assembly front door. [Ref. to GLASS/WINDOWS/MIRRORS>Front Door Glass>REMOVAL > FRONT DOOR GLASS.](#)
3. Remove the glass front door partition.

Caution:

Do not damage the sash or the sash molding while removing.

- (1) Remove the bolts and screws, and then remove the running channel front door and the sash assembly partition.

- (2) Remove the glass front door partition.

GLASS/WINDOWS/MIRRORS > Front Door Glass

INSTALLATION

1. FRONT DOOR GLASS

Caution:

Before handling the airbag system components, refer to "CAUTION" of "General Description" in "AIRBAG SYSTEM". [Ref. to AIRBAG SYSTEM>General Description>CAUTION.](#)

1. Install the glass assembly front door.

Tightening torque:

7.5 N·m (0.8 kgf-m, 5.5 ft-lb)

2. Install the plate door and the pad front door inner.
3. Install the sealing cover door front. [Ref. to EXTERIOR BODY PANELS>Sealing Cover>INSTALLATION > FRONT SEALING COVER.](#)
4. Install the trim panel front door. [Ref. to EXTERIOR/INTERIOR TRIM>Door Trim>INSTALLATION > FRONT DOOR.](#)
5. Connect the ground terminal to battery sensor. [Ref. to REPAIR CONTENTS>NOTE > BATTERY.](#)
6. Perform the initial setting of the power window system. [Ref. to GLASS/WINDOWS/MIRRORS>Power Window System>OPERATION.](#)

2. FRONT DOOR PARTITION GLASS

Caution:

Before handling the airbag system components, refer to "CAUTION" of "General Description" in "AIRBAG SYSTEM". [Ref. to AIRBAG SYSTEM>General Description>CAUTION.](#)

1. Install the glass front door partition.
2. Install the running channel front door and the sash assembly partition.

Note:

Check that the running channel is securely fixed to the door panel assembly and to the sash assembly.

Tightening torque:

Refer to "COMPONENT" of "General Description" for the tightening torque. [Ref. to GLASS/WINDOWS/MIRRORS>General Description>COMPONENT > FRONT DOOR GLASS.](#)

- 3.** Install the glass assembly front door. [Ref. to GLASS/WINDOWS/MIRRORS>Front Door Glass>INSTALLATION > FRONT DOOR GLASS.](#)
- 4.** Connect the ground terminal to battery sensor. [Ref. to REPAIR CONTENTS>NOTE > BATTERY.](#)
- 5.** Perform the initial setting of the power window system. [Ref. to GLASS/WINDOWS/MIRRORS>Power Window System>OPERATION.](#)

GLASS/WINDOWS/MIRRORS > Front Regulator and Motor Assembly

REMOVAL

Caution:

Before handling the airbag system components, refer to "CAUTION" of "General Description" in "AIRBAG SYSTEM". [Ref. to AIRBAG SYSTEM>General Description>CAUTION.](#)

1. Operate the switch power window to move the glass assembly front door to the lowest position.
2. Disconnect the ground terminal from the battery sensor, and wait for at least 60 seconds before starting work. [Ref. to REPAIR CONTENTS>NOTE > BATTERY.](#)
3. Remove the trim panel front door. [Ref. to EXTERIOR/INTERIOR TRIM>Door Trim>REMOVAL > FRONT DOOR.](#)
4. Remove the sealing cover door front. [Ref. to EXTERIOR BODY PANELS>Sealing Cover>REMOVAL > FRONT SEALING COVER.](#)
5. Remove the glass assembly front door. [Ref. to GLASS/WINDOWS/MIRRORS>Front Door Glass>REMOVAL > FRONT DOOR GLASS.](#)
6. Remove the regulator & motor assembly front.
 - (1) Disconnect the connector.
 - (2) Remove the bolts, and then remove the regulator & motor assembly front.



GLASS/WINDOWS/MIRRORS > Front Regulator and Motor Assembly

INSTALLATION

Caution:

Before handling the airbag system components, refer to "CAUTION" of "General Description" in "AIRBAG SYSTEM". [Ref. to AIRBAG SYSTEM>General Description>CAUTION.](#)

1. Install the regulator & motor assembly front, and connect the connector.

Tightening torque:
7.5 N·m (0.8 kgf-m, 5.5 ft-lb)
2. Install the glass assembly front door. [Ref. to GLASS/WINDOWS/MIRRORS>Front Door Glass>INSTALLATION > FRONT DOOR GLASS.](#)
3. Install the sealing cover door front. [Ref. to EXTERIOR BODY PANELS>Sealing Cover>INSTALLATION > FRONT SEALING COVER.](#)

4. Install the trim panel front door. [Ref. to EXTERIOR/INTERIOR TRIM>Door Trim>INSTALLATION > FRONT DOOR.](#)
5. Connect the ground terminal to battery sensor. [Ref. to REPAIR CONTENTS>NOTE > BATTERY.](#)
6. Perform the initial setting of the power window system. [Ref. to GLASS/WINDOWS/MIRRORS>Power Window System>OPERATION.](#)

GLASS/WINDOWS/MIRRORS > Front Regulator and Motor Assembly

INSPECTION

For inspection of regulator & motor assembly front, refer to "Active Test" of "POWER WINDOW (DIAGNOSTICS)" section. [Ref. to POWER WINDOW\(DIAGNOSTICS\) >Active Test.](#)

GLASS/WINDOWS/MIRRORS > Remote Control Mirror System

WIRING DIAGRAM

For the wiring diagram, refer to "Remote Control Mirror System" in the wiring diagram. [Ref. to WIRING SYSTEM>Remote Control Mirror System.](#)

GLASS/WINDOWS/MIRRORS > Remote Control Mirror System

INSPECTION

1. TROUBLE SYMPTOM

Note:

The mirror heater operates with the rear window defogger at the same time. Refer to "INSPECTION" of "Rear Window Defogger System" for inspection. [Ref. to GLASS/WINDOWS/MIRRORS>Rear Window Defogger System>INSPECTION.](#)

Symptoms	Inspection order
All functions do not operate.	<ol style="list-style-type: none">1. Check the fuse2. Check the remote control mirror switch3. Check the wiring harness
One side of the mirror motor does not operate	<ol style="list-style-type: none">1. Check the remote control mirror switch2. Check the mirror motor3. Check the wiring harness
Mirror heater does not operate	<ol style="list-style-type: none">1. Check the rear defogger switch2. Check the rear defogger relay3. Check the mirror heater4. Check the wiring harness5. Check body integrated unit

GLASS/WINDOWS/MIRRORS > Remote Control Mirror System

NOTE

For procedure of components in the remote control mirror system, refer to the sections below.

- Outer mirror assembly: [Ref. to GLASS/WINDOWS/MIRRORS>Outer Mirror Assembly.](#)
- Remote control mirror switch: [Ref. to GLASS/WINDOWS/MIRRORS>Remote Control Mirror Switch.](#)

GLASS/WINDOWS/MIRRORS > Outer Mirror Assembly

REMOVAL

Caution:

Before handling the airbag system components, refer to "CAUTION" of "General Description" in "AIRBAG SYSTEM". [Ref. to AIRBAG SYSTEM>General Description>CAUTION.](#)

Note:

Refer to "DISASSEMBLY" for removal procedures of outer mirror cover and mirror face. [Ref. to GLASS/WINDOWS/MIRRORS>Outer Mirror Assembly>DISASSEMBLY.](#)

1. Operate the switch power window to move the glass assembly front door to the lowest position.
2. Disconnect the ground terminal from the battery sensor, and wait for at least 60 seconds before starting work. [Ref. to REPAIR CONTENTS>NOTE > BATTERY.](#)
3. Remove the trim panel front door. [Ref. to EXTERIOR/INTERIOR TRIM>Door Trim>REMOVAL > FRONT DOOR.](#)
4. Turn over the sealing cover door front.

Caution:

- Carefully remove the butyl tape. Excessive force will easily break the front sealing cover.
- If the front sealing cover gets broken, replace it with a new part.
- Be careful not to allow the butyl tape to contact any trims and seats because the butyl tape, which has a strong adhesive force, is difficult to remove once it adhered.

- (1) Disconnect the outer mirror assembly connector.
- (2) Carefully remove and turn over the sealing cover door front within the area where the operation can be performed.

5. Remove the outer mirror assembly.
 - (1) Remove the harness clip.
 - (2) Remove the bolts to remove outer mirror assembly.

GLASS/WINDOWS/MIRRORS > Outer Mirror Assembly

INSTALLATION

Caution:

- Before handling the airbag system components, refer to "CAUTION" of "General Description" in "AIRBAG SYSTEM". [Ref. to AIRBAG SYSTEM>General Description>CAUTION.](#)
- Be careful not to catch the harness in between the parts.

1. Install the outer mirror assembly, and connect the connector.

Tightening torque:

7.5 N·m (0.8 kgf-m, 5.5 ft-lb)

2. Install the sealing cover door front. [Ref. to EXTERIOR BODY PANELS>Sealing Cover>INSTALLATION > FRONT SEALING COVER.](#)
3. Install the trim panel front door. [Ref. to EXTERIOR/INTERIOR TRIM>Door Trim>INSTALLATION > FRONT DOOR.](#)
4. Connect the ground terminal to battery sensor. [Ref. to REPAIR CONTENTS>NOTE > BATTERY.](#)

GLASS/WINDOWS/MIRRORS > Outer Mirror Assembly

DISASSEMBLY

1. Perform the following procedures to remove the cover mirror body.
 - Store the outer mirror assembly.
 - Lower the glass assembly front door to the lowest position.
2. Operate the remote control mirror switch to face the mirror repair inside.
3. Disconnect the ground terminal from battery sensor. [Ref. to REPAIR CONTENTS>NOTE > BATTERY.](#)
4. Remove the mirror repair.
 - (1) Insert a flat tip screwdriver or similar tool wrapped with protection tape into the tool insertion opening shown in the figure, release the engagement and take the mirror repair outward to remove.

Caution:

When removing the mirror repair, be careful not to damage the back surface of mirror repair with a flat tip screwdriver.

(2) Disconnect the connector. (Model with mirror heater)

5. Release the claws, and then remove the cover cap outer mirror.

Caution:

Be careful not to apply excessive force when removing the outer mirror cover, as the lower hooks may become damaged.

6. Remove the screws and release the claws, and then remove the cover cap outer mirror LWR.

7. Remove the Blind Spot Detection/Rear Cross Traffic Alert system indicator. (Model with Blind Spot Detection/Rear Cross Traffic Alert system)

- (1) Disconnect the connector.
- (2) Release the claws and then remove the Blind Spot Detection/Rear Cross Traffic Alert system indicator.

8. Remove the light assembly side turn mirror. (Model with side turn signal light)
 - (1) Release the screws and claws.

(2) Disconnect the connector and remove the light assembly side turn mirror.

9. Remove the screw and detach the cover mirror body.

GLASS/WINDOWS/MIRRORS > Outer Mirror Assembly

ASSEMBLY

Caution:

Be careful not to catch the harness in between the parts.

1. Install the cover mirror body.
2. Connect the connector, and install the light assembly side turn mirror. (Model with side turn signal light)
3. Install the Blind Spot Detection/Rear Cross Traffic Alert system indicator and connect the connector. (Model with Blind Spot Detection/Rear Cross Traffic Alert system)
4. Install the cover cap outer mirror LWR.
5. Install the cover cap outer mirror.
6. Install the mirror repair.

Note:

Make sure that the connector and clips are inserted securely.

- (1) Connect the connector. (Model with mirror heater)
- (2) Install the mirror repair.
7. Connect the ground terminal to battery sensor. [Ref. to REPAIR CONTENTS>NOTE > BATTERY.](#)
8. For models with Blind Spot Detection/Rear Cross Traffic Alert system, perform operation check of Blind Spot Detection/Rear Cross Traffic Alert system. [Ref. to Blind Spot Detection/Rear Cross Traffic Alert \(DIAGNOSTICS\)>Basic Diagnostic Procedure.](#)

GLASS/WINDOWS/MIRRORS > Outer Mirror Assembly

INSPECTION

1. CHECK MOTOR OPERATION

1. Apply battery voltage between the outer mirror connector terminals and check the mirror operation.

Terminal No.	Inspection conditions	Operating position
—	—	OFF
13 (+) — 12 (—)	Apply battery voltage between terminals.	UP
12 (+) — 13 (—)	Apply battery voltage between terminals.	DOWN
11 (+) — 13 (—)	Apply battery voltage between terminals.	LEFT
13 (+) — 11 (—)	Apply battery voltage between terminals.	RIGHT

2. CHECK OPERATION OF Blind Spot Detection/Rear Cross Traffic Alert SYSTEM INDICATOR (MODEL WITH Blind Spot Detection/Rear Cross Traffic Alert SYSTEM)

- 1.** Check the Blind Spot Detection/Rear Cross Traffic Alert system. [Ref. to Blind Spot Detection/Rear Cross Traffic Alert \(DIAGNOSTICS\)>Basic Diagnostic Procedure.](#)
- 2.** Check the outer mirror assembly.
 - (1) Check that the Blind Spot Detection/Rear Cross Traffic Alert system indicator of the outer mirror assembly illuminates normally when the BSD/RCTA is turned ON while it is installed to the vehicle.
 - (2) If it does not illuminate normally as a result of inspection, replace the Blind Spot Detection/Rear Cross Traffic Alert system indicator.
 - (3) Check that it illuminates normally again. If it does not illuminate normally, replace the outer mirror assembly.

GLASS/WINDOWS/MIRRORS > Remote Control Mirror Switch

NOTE

The remote control mirror switch is integrated into the power window control switch.

For the operation procedures for the remote control mirror switch, refer to "Power Window Control Switch".

[Ref. to GLASS/WINDOWS/MIRRORS>Power Window Control Switch>REMOVAL > MAIN SWITCH.](#)

GLASS/WINDOWS/MIRRORS > Remote Control Mirror Switch

INSPECTION

1. Check the resistance between switch door mirror terminals.

- Changeover switch RH

Terminal No.	Inspection conditions	Standard
12 - 1 12 - 18	OFF	1 M Ω or more
12 - 18 17 - 1	UP	Less than 1 Ω
12 - 17 18 - 1	DOWN	Less than 1 Ω
12 - 16 18 - 1	LEFT	Less than 1 Ω
12 - 18 16 - 1	RIGHT	Less than 1 Ω

- Changeover switch LH

Terminal No.	Inspection conditions	Standard
12 - 1 12 - 21	OFF	1 M Ω or more

Terminal No.	Inspection conditions	Standard
12 – 20 21 – 1	DOWN	Less than 1 Ω
12 – 21 20 – 1	UP	Less than 1 Ω
12 – 19 21 – 1	LEFT	Less than 1 Ω
12 – 21 19 – 1	RIGHT	Less than 1 Ω

2. Apply battery voltage between the switch door mirror terminals to check lighting condition of illumination inside the switch.

Caution:

When applying battery voltage, do not mix up the positive (+) side and the negative (–) side.

Incorrect polarity connection may cause LED damage inside the switch.

Terminal No.	Inspection conditions	Specification
24 (+) – 13 (–)	Apply battery voltage	Light ON

3. Replace the switch power window main if it is found defective from the inspection result.

GLASS/WINDOWS/MIRRORS > Rearview Mirror

INSTALLATION

Caution:

Be careful not to damage the mirror surface and the glass windshield.

- 1.** Install the mirror assembly inner rearview.
 - (1) Slide the mirror assembly inner rearview to install.
 - (2) Install the mount section cover.

GLASS/WINDOWS/MIRRORS > Rearview Mirror

INSPECTION

1. VISUAL INSPECTION

Check that the mirror assembly inner rearview and base inner mirror for damage.

GLASS/WINDOWS/MIRRORS > Rear Door Glass

REMOVAL

1. Operate the switch power window to move the glass assembly rear door to the lowest position.
2. Disconnect the ground terminal from battery sensor. [Ref. to REPAIR CONTENTS>NOTE > BATTERY.](#)
3. Remove the trim panel rear door. [Ref. to EXTERIOR/INTERIOR TRIM>Door Trim>REMOVAL > REAR DOOR.](#)
4. Remove the sealing cover door rear. [Ref. to EXTERIOR BODY PANELS>Sealing Cover>REMOVAL > REAR SEALING COVER.](#)
5. Remove the glass assembly rear door.

Caution:

Do not damage the sash or the sash molding while removing.

- (1) Remove the bolts and screws, and then remove the running channel rear door and the sash assembly rear door partition.

- (2) Remove the glass rear door partition.

- (3) Remove the bolts, and remove the glass assembly rear door.

GLASS/WINDOWS/MIRRORS > Rear Door Glass

INSTALLATION

1. Install the running channel rear door up to the roof center position (a) of the panel COMPL door rear.

Caution:

Check that the running channel is securely fixed to the door panel COMPL.

2. Install the glass assembly rear door.

Caution:

Avoid impact and damage to the door glass assembly.

Tightening torque:

7.5 N·m (0.8 kgf-m, 5.5 ft-lb)

3. Install the glass rear door partition.
4. Install the sash assembly rear door partition.
 - (1) Install the running channel rear door to the sash assembly rear door partition.

Caution:

Align the rib (a) of the running channel with the sash assembly upper end (b).

(2) Install the sash assembly rear door partition.

Tightening torque:

Refer to "COMPONENT" of "General Description" for the tightening torque. [_Ref. to GLASS/WINDOWS/MIRRORS>General Description>COMPONENT > REAR DOOR GLASS.](#)

5. Install the rest of the running channel rear door.

Note:

After installation, check that there is no warpage, gap or scratch.

- 6.** Install the sealing cover door rear. [_Ref. to EXTERIOR BODY PANELS>Sealing Cover>INSTALLATION > REAR SEALING COVER.](#)
- 7.** Install the trim panel rear door. [_Ref. to EXTERIOR/INTERIOR TRIM>Door Trim>INSTALLATION > REAR DOOR.](#)
- 8.** Connect the ground terminal to battery sensor. [_Ref. to REPAIR CONTENTS>NOTE > BATTERY.](#)
- 9.** Perform the initial setting of the power window system. [_Ref. to GLASS/WINDOWS/MIRRORS>Power Window System>OPERATION.](#)

GLASS/WINDOWS/MIRRORS > Rear Regulator and Motor Assembly

REMOVAL

1. Operate the switch power window to move the glass assembly rear door to the lowest position.
2. Disconnect the ground terminal from battery sensor. [Ref. to REPAIR CONTENTS>NOTE > BATTERY.](#)
3. Remove the trim panel rear door. [Ref. to EXTERIOR/INTERIOR TRIM>Door Trim>REMOVAL > REAR DOOR.](#)
4. Remove the sealing cover door rear. [Ref. to EXTERIOR BODY PANELS>Sealing Cover>REMOVAL > REAR SEALING COVER.](#)
5. Remove the speaker assembly rear. [Ref. to ENTERTAINMENT & MONITORING>Rear Speaker>REMOVAL.](#)
6. Remove the glass assembly rear door. [Ref. to GLASS/WINDOWS/MIRRORS>Rear Door Glass>REMOVAL.](#)
7. Remove the regulator and motor assembly rear.
 - (1) Disconnect the connector.
 - (2) Remove the bolts, and then remove the regulator and motor assembly rear.

GLASS/WINDOWS/MIRRORS > Rear Regulator and Motor Assembly

INSTALLATION

1. Install the regulator & motor assembly rear, and connect the connector.

Tightening torque:
7.5 N·m (0.8 kgf-m, 5.5 ft-lb)
2. Install the glass assembly rear door. [Ref. to GLASS/WINDOWS/MIRRORS>Rear Door Glass>INSTALLATION.](#)
3. Install the speaker assembly rear. [Ref. to ENTERTAINMENT & MONITORING>Rear Speaker>INSTALLATION.](#)
4. Install the sealing cover door rear. [Ref. to EXTERIOR BODY PANELS>Sealing Cover>INSTALLATION > REAR SEALING COVER.](#)
5. Install the trim panel rear door. [Ref. to EXTERIOR/INTERIOR TRIM>Door Trim>INSTALLATION > REAR DOOR.](#)
6. Connect the ground terminal to battery sensor. [Ref. to REPAIR CONTENTS>NOTE > BATTERY.](#)
7. Perform the initial setting of the power window system. [Ref. to GLASS/WINDOWS/MIRRORS>Power Window System>OPERATION.](#)

GLASS/WINDOWS/MIRRORS > Rear Regulator and Motor Assembly

INSPECTION

1. FRONT SEATS AUTO SPECIFICATION

1. Check the motor operation when battery voltage is applied between terminals of the regulator & motor assembly rear connector.

- LH side

Terminal No.	Inspection conditions	Specification
2 (+) – 1 (–)	Apply battery voltage between terminals.	Increase
1 (+) – 2 (–)	Apply battery voltage between terminals.	Decrease

- RH side

Terminal No.	Inspection conditions	Specification
2 (+) – 1 (–)	Apply battery voltage between terminals.	Increase
1 (+) – 2 (–)	Apply battery voltage between terminals.	Decrease

2. If the regulator and motor do not operate properly as a result of inspection, replace the regulator and motor assembly rear.

2. ALL SEATS AUTO SPECIFICATION

For inspection of regulator & motor assembly rear, refer to "Active Test" of "POWER WINDOW (DIAGNOSTICS)" section. [Ref. to POWER WINDOW\(DIAGNOSTICS\) >Active Test.](#)

REMOVAL

1. WHEN USING WINDSHIELD GLASS KNIFE

Caution:

- Before handling the airbag system components, refer to "CAUTION" of "General Description" in "AIRBAG SYSTEM". [Ref. to AIRBAG SYSTEM>General Description>CAUTION.](#)
- Use the Subaru genuine windshield glass specially designed for EyeSight. (If the windshield glass other than the glass specially designed for EyeSight is used, the visibility of the camera is blocked or the distortion of the glass prevents the correct measurement of the object, resulting in the EyeSight abnormal operation.)
- If the windshield glass is installed after removal or replaced, perform the "Inspection" and "Adjustment and check" of the stereo camera.
Inspection: [Ref. to EyeSight \(DIAGNOSTICS\)>General Description>INSPECTION.](#)
Adjustment and check: [Ref. to EyeSight>Camera Adjustment, Inspection.](#)
- If the damage is found in the glass repair prohibited area, always replace the glass. Damage, dirt, aftermarket part installation or sticker attachment in the prohibited area can affect the recognition of camera, and thereby the EyeSight function may not operate properly. [Ref. to CAUTION > CHECK WINDSHIELD GLASS INCLUDING PROHIBITED AREA.](#)

1. Disconnect the ground terminal from the battery sensor, and wait for at least 60 seconds before starting work. [Ref. to REPAIR CONTENTS>NOTE > BATTERY.](#)
2. Remove the trim panel assembly A pillar. [Ref. to EXTERIOR/INTERIOR TRIM>Upper Inner Trim>REMOVAL > A PILLAR TRIM.](#)
3. Remove the arm assembly windshield wiper. [Ref. to WIPER AND WASHER SYSTEMS>Front Wiper Arm>REMOVAL.](#)
4. Remove the cowl panel assembly. [Ref. to EXTERIOR/INTERIOR TRIM>Cowl Panel>REMOVAL.](#)
5. Disconnect the wiper deicer connector.
6. Remove the light assembly map. [Ref. to LIGHTING SYSTEM>Spot Map Light>REMOVAL.](#)
7. Remove the stereo camera. [Ref. to EyeSight>Stereo Camera>REMOVAL.](#)
8. Remove the mirror assembly inner rearview. [Ref. to GLASS/WINDOWS/MIRRORS>Rearview Mirror>REMOVAL.](#)
9. Remove the lens hood. [Ref. to EyeSight>Lens Hood>REMOVAL.](#)
10. Remove the molding windshield from the glass windshield, and attach protective tape on the body side of the circumference of the glass windshield.

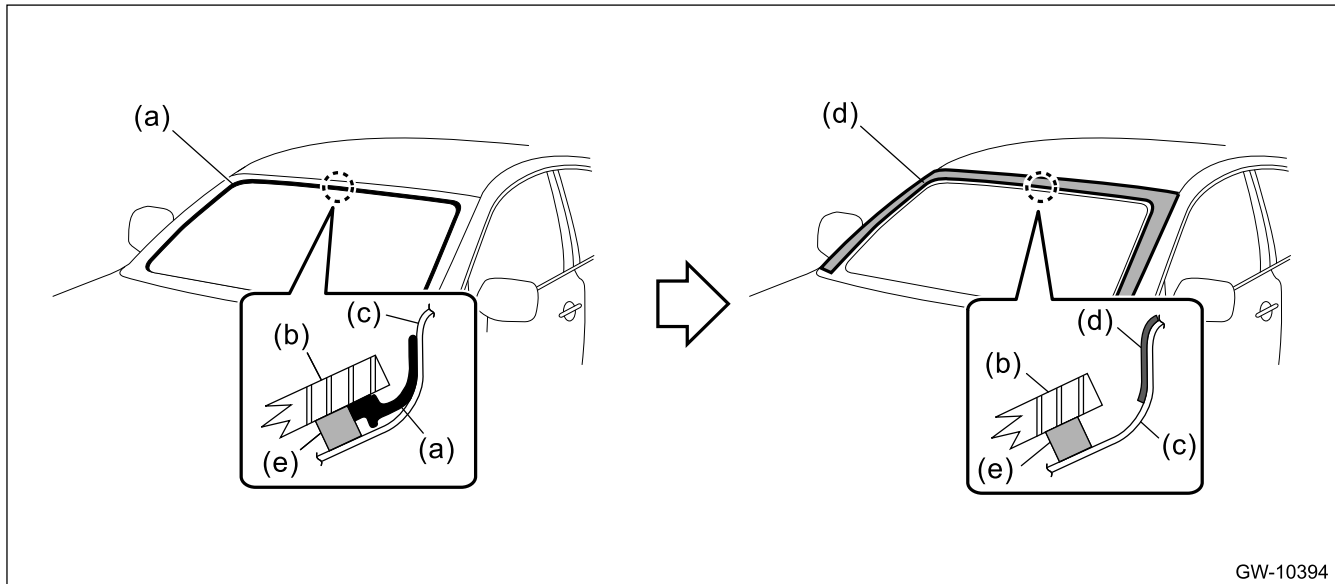

GW-10394

- | | | |
|------------------------|---------------------|--------------|
| (a) Molding windshield | (c) Body panel | (e) Adhesive |
| (b) Glass windshield | (d) Protective tape | |

11. Remove the glass windshield.

- (1) Apply sufficient amount of soapy water to the adhesive part and insert the windshield glass knife.
- (2) While holding the edges of the knife and the glass windshield at a right angle, move the windshield glass knife parallel to the edge of the glass windshield, and cut the adhesive along the surface and the edge of the glass windshield.

Caution:

- **Cutting of adhesive part should be started from an area with wider gap between the windshield glass and the body.**
- **Never twist the windshield glass knife.**

- | | | |
|----------------------------|----------------------|----------------|
| (a) Windshield glass knife | (c) Adhesive | (e) Body panel |
| (b) Protective tape | (d) Glass windshield | |

- (3) Disconnect the locating pin windshield and remove the glass windshield.

Note:

The locating pin windshield is bonded to the corners of glass windshield. Use piano wire to disconnect the pins.

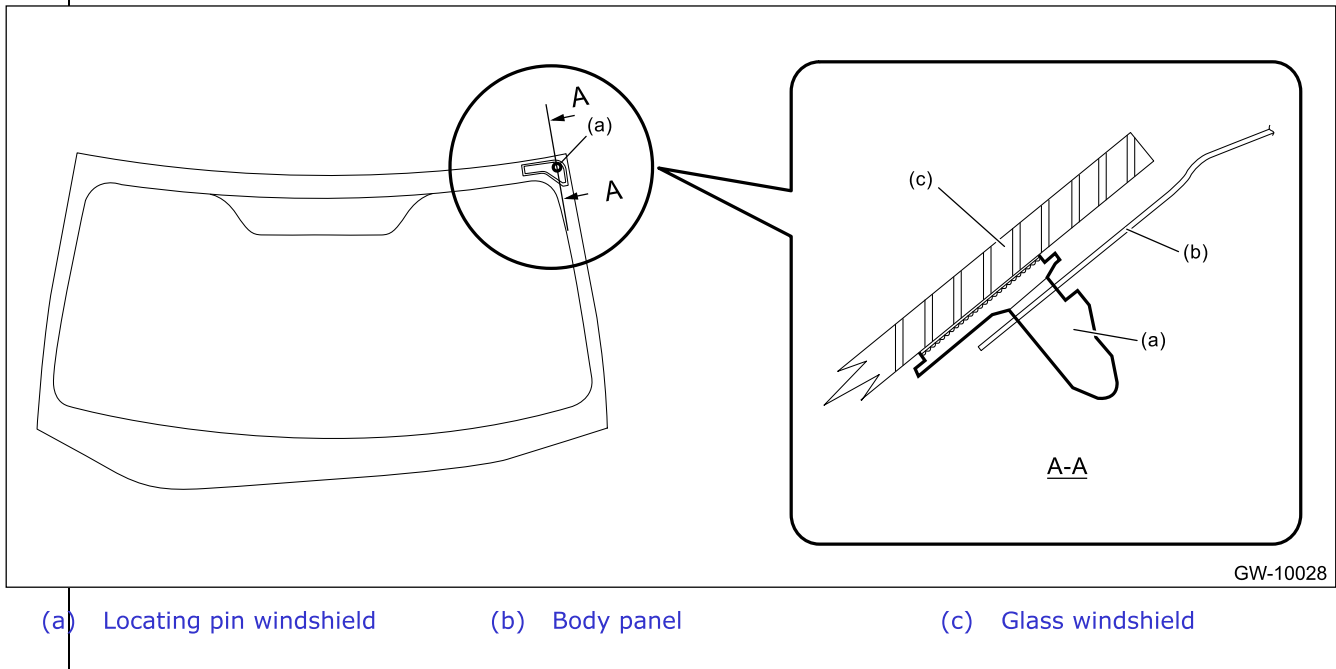

12. Remove the locating pin windshield. (When reusing the glass)

(1) Attach tape to the locating pin windshield outer surface to identify the installation position.

(2) Using a scraper, etc., remove locating pin windshield (two places).

Note:

Do not remove the tape because it is used to refer to the installation position.

2. WHEN USING PIANO WIRE

Caution:

- Before handling the airbag system components, refer to "CAUTION" of "General Description" in "AIRBAG SYSTEM". [Ref. to AIRBAG SYSTEM>General Description>CAUTION.](#)
- Use the Subaru genuine windshield glass specially designed for EyeSight. (If the windshield glass other than the glass specially designed for EyeSight is used, the visibility of the camera is blocked or the distortion of the glass prevents the correct measurement of the object, resulting in the EyeSight abnormal operation.)
- If the windshield glass is installed after removal or replaced, perform the "Inspection" and "Adjustment and check" of the stereo camera.
Inspection: [Ref. to EyeSight \(DIAGNOSTICS\)>General Description>INSPECTION.](#)
Adjustment and check: [Ref. to EyeSight>Camera Adjustment, Inspection.](#)
- If the damage is found in the glass repair prohibited area, always replace the glass. Damage, dirt, aftermarket part installation or sticker attachment in the prohibited area can affect the recognition of camera, and thereby the EyeSight function may not operate properly. [Ref. to CAUTION > CHECK WINDSHIELD GLASS INCLUDING PROHIBITED AREA.](#)
- Do not tightly pull the piano wire against the windshield glass edge.
- Do not cross piano wires. Otherwise they may be cut.

1. Disconnect the ground terminal from the battery sensor, and wait for at least 60 seconds before starting work. [Ref. to REPAIR CONTENTS>NOTE > BATTERY.](#)
2. Remove the trim panel assembly A pillar. [Ref. to EXTERIOR/INTERIOR TRIM>Upper Inner Trim>REMOVAL > A PILLAR TRIM.](#)
3. Remove the arm assembly windshield wiper. [Ref. to WIPER AND WASHER SYSTEMS>Front Wiper Arm>REMOVAL.](#)
4. Remove the cowl panel assembly. [Ref. to EXTERIOR/INTERIOR TRIM>Cowl Panel>REMOVAL.](#)
5. Disconnect the wiper deicer connector.
6. Remove the light assembly map. [Ref. to LIGHTING SYSTEM>Spot Map Light>REMOVAL.](#)
7. Remove the stereo camera. [Ref. to EyeSight>Stereo Camera>REMOVAL.](#)
8. Remove the mirror assembly inner rearview. [Ref. to GLASS/WINDOWS/MIRRORS>Rearview Mirror>REMOVAL.](#)
9. Remove the lens hood. [Ref. to EyeSight>Lens Hood>REMOVAL.](#)
10. Remove the molding windshield from the glass windshield, and attach protective tape on the body side of the circumference of the glass windshield.

- (a) Molding windshield
- (b) Glass windshield
- (c) Body panel
- (d) Protective tape
- (e) Adhesive

11. Remove the glass windshield.

- (1) Pass a piano wire through the adhesive part.
- (2) Pull the piano wire ends alternately to cut off the adhesive part and locating pin windshield.

Caution:

Attach a piece of wood to both piano wire ends.

- (a) Piano wire
- (b) Glass windshield
- (c) Adhesive
- (d) Body panel
- (e) Protective tape

12. Remove the locating pin windshield. (When reusing the glass)

- (1) Attach tape to the locating pin windshield outer surface to identify the installation position.

(2) Using a scraper, etc., remove locating pin windshield (two places).

Note:

Do not remove the tape because it is used to refer to the installation position.

GLASS/WINDOWS/MIRRORS > Windshield Glass

INSTALLATION

Caution:

- **Before handling the airbag system components, refer to "CAUTION" of "General Description" in "AIRBAG SYSTEM". [Ref. to AIRBAG SYSTEM>General Description>CAUTION.](#)**
- **Always use the Subaru genuine windshield glass specially designed for EyeSight. (If the windshield glass other than the glass specially designed for EyeSight is used, the visibility of the camera is blocked or the distortion of the glass prevents the correct measurement of the object, resulting in the EyeSight abnormal operation.)**
- **For installation of the stereo camera, refer to "INSTALLATION", "Stereo Camera" in the "EyeSight" section and observe the precautions for installation. [Ref. to EyeSight>Stereo Camera>INSTALLATION.](#)**
- **If the damage is found in the glass repair prohibited area, always replace the glass. Damage, dirt, aftermarket part installation or sticker attachment in the prohibited area can affect the recognition of camera, and thereby the EyeSight function may not operate properly. [Ref. to CAUTION > CHECK WINDSHIELD GLASS INCLUDING PROHIBITED AREA.](#)**

1. Fabricate the cartridge nozzle tip as shown and set the sealant gun with the adhesive.

(a) 10 mm (0.39 in)

(b) 8 mm (0.31 in)

(c) Sealant gun

2. Remove the adhesive layer on the body using cutter knife to obtain smooth face of 2 mm (0.08 in) thick.

Caution:

- **Be careful not to damage the body and paint surface.**
- **Be sure to keep some amount of old adhesive.**

(a) Adhesive

(b) Body panel

(c) 2 mm (0.08 in)

3. Clean the glass windshield and body.
 - (1) Using a scraper, remove adhesive and double-sided tape left on the glass windshield.
 - (2) Clean the glass windshield and the body with alcohol or appropriate cleaning solvent to completely eliminate cutting powder, dust and dirt.
4. Install a new locating pin windshield. (When reusing the glass)
 - (1) Using a sponge, apply primer to the locating pin windshield installation position on the glass windshield.

Note:

- **Let primer dry for about one hour before installing the locating pin windshield.**
- **Do not touch the surface coated with primer.**

Preparation items

Glass primer: Dow Automotive ESSEX U-401, U-402 or equivalent

(2) Apply adhesive to the locating pin windshield adhesive surface.

Preparation items:

Adhesive: Dow Automotive ESSEX U-400HV or equivalent

(3) Install a new locating pin windshield to the positions marked with tapes (two places), and remove the tapes.

5. Attach a new dam rubber front to the glass windshield.

Note:

Attach the dam rubber straight between the dam rubber set marks while aligning with the dam rubber set mark.

- | | | |
|-----------------------------|----------------------------|-----------------------|
| (a) Locating pin windshield | (d) Seal lower | (g) 14.8 mm (0.58 in) |
| (b) Dam rubber front upper | (e) Dam rubber front lower | (h) 0+5 mm (0+0.2 in) |
| (c) Dam rubber front side | (f) Dam rubber set mark | |

6. Install a new molding windshield to the glass windshield.

Caution:

Be careful to attach the windshield molding so that the molding has no loose or undulating part.

(1) Using a sponge, apply primer to the molding installation surface in the glass windshield side.

Note:

- **Let primer dry for about ten minutes before installing the windshield molding.**
- **Do not touch the surface coated with primer.**

Preparation items

Glass primer: Dow Automotive ESSEX U-401, U-402 or equivalent

- (2) Align the molding windshield (A) with both ends of the upper edge (a) of the glass windshield (C).
- (3) Install the molding windshield from both corners of the upper edge toward the center (b).
- (4) Install the molding windshield from both corners of the upper edge toward the lower side (c).
- (5) Firmly apply the double sided tape (B) of the molding windshield evenly to the glass windshield surface.

7. Attach the seal upper to the molding windshield.

- | | | |
|-----------------------------|------------------------|---------------------------|
| (a) Locating pin windshield | (d) Molding windshield | (g) Dam rubber front side |
| (b) Dam rubber front upper | (e) 0+5 mm (0+0.2 in) | (h) 0+0.5 mm (0+0.02 in) |
| (c) Seal upper | (f) 165 mm (6.5 in) | |

8. Install the glass windshield.

- (1) Using a sponge, apply primer to the adhesive surfaces of glass windshield side and the body side.

Caution:

Do not apply primer to adhesive remaining on the body side.

Note:

- **Primer once attached to the painted surface of the body and internal trim is hard to wipe off. Mask the circumference of such area.**
- **Let primer dry for about ten minutes before installing the glass windshield.**
- **Do not touch the surface coated with primer.**

Preparation items:

Glass primer: Dow Automotive ESSEX U-401, U-402 or equivalent

Painted surface primer: Dow Automotive ESSEX U-413 or equivalent

(2) Apply adhesive to the glass windshield end back surface along to the dam rubber.

Preparation items:

Adhesive: Dow Automotive ESSEX U-400HV or equivalent

VB-*BU

GW-11154

- | | | |
|--|------------------------|-----------------------|
| (a) Application of primer (glass side) | (c) Adhesive | (e) Dam rubber front |
| (b) Application of primer (body side) | (d) Molding windshield | (f) 14.8 mm (0.58 in) |

(3) Fit the locating pin windshield to the vehicle body using suction rubber cups, and install the glass windshield.

(4) Lightly press the entire perimeter of the glass windshield for tight fit.

(5) Make flush the adhesive surface jugged out using spatula.

9. After completion of all work, allow the vehicle to stand for about 24 hours.

Note:

- **When opening/closing the door after the windshield glass was bonded, always lower the door glass assembly first, and then open/close it carefully.**
- **Move the vehicle slowly.**
- **For minimum drying time and vehicle standing time before driving after bonding, follow instructions or instruction manual from the adhesive manufacturer.**

10. Install the lens hood. [Ref. to EyeSight>Lens Hood>INSTALLATION.](#)

11. Install the mirror assembly inner rearview. [Ref. to GLASS/WINDOWS/MIRRORS>Rearview Mirror>INSTALLATION.](#)

12. Install the stereo camera. [Ref. to EyeSight>Stereo Camera>INSTALLATION.](#)

13. Install the light assembly map. [Ref. to LIGHTING SYSTEM>Spot Map Light>INSTALLATION.](#)

14. Connect the wiper deicer connector.

15. Install the cowl panel assembly. [Ref. to EXTERIOR/INTERIOR TRIM>Cowl Panel>INSTALLATION.](#)

16. Install the arm assembly windshield wiper. [Ref. to WIPER AND WASHER SYSTEMS>Front Wiper Arm>INSTALLATION.](#)

17. Install the trim panel assembly A pillar. [Ref. to EXTERIOR/INTERIOR TRIM>Upper Inner Trim>INSTALLATION > A PILLAR TRIM.](#)

18. Connect the ground terminal to battery sensor. [Ref. to REPAIR CONTENTS>NOTE > BATTERY.](#)

19. After curing of adhesive, pour the water on external surface of vehicle to check that there are no water leaks.

Caution:

When a vehicle is returned to the user, tell him or her that the vehicle should not be subjected to heavy impact for at least three days.

20. Perform the inspection, and adjustment and check of the stereo camera.

- Inspection: [Ref. to EyeSight \(DIAGNOSTICS\)>General Description>INSPECTION.](#)
- Adjustment and check: [Ref. to EyeSight>Camera Adjustment, Inspection.](#)

GLASS/WINDOWS/MIRRORS > Rear Window Glass

REMOVAL

Caution:

- **Before handling the airbag system components, refer to "CAUTION" of "General Description" in "AIRBAG SYSTEM". [Ref. to AIRBAG SYSTEM>General Description>CAUTION.](#)**
- **Side impact sensor (under the rear center seat) for the airbag system is located under the front center of the rear seat cushion. Be careful not to apply strong impact to the sensor when working with the rear seat cushion removed.**

- 1.** Disconnect the ground terminal from the battery sensor, and wait for at least 60 seconds before starting work. [Ref. to REPAIR CONTENTS>NOTE > BATTERY.](#)
- 2.** Remove the rear seat cushion assembly and the backrest assembly. [Ref. to SEATS>Rear Seat>REMOVAL.](#)
- 3.** Remove the trim panel assembly C pillar LWR and the trim panel assembly C pillar. [Ref. to EXTERIOR/INTERIOR TRIM>Rear Quarter Trim>REMOVAL.](#)
- 4.** Remove the trim panel assembly rear shelf. [Ref. to EXTERIOR/INTERIOR TRIM>Rear Shelf Trim>REMOVAL.](#)
- 5.** Disconnect the rear defogger connector and the antenna connector.
- 6.** Remove the glass rear window in the same procedure as for the glass windshield. [Ref. to GLASS/WINDOWS/MIRRORS>Windshield Glass>REMOVAL.](#)

GLASS/WINDOWS/MIRRORS > Rear Window Glass

INSTALLATION

Caution:

- **Before handling the airbag system components, refer to "CAUTION" of "General Description" in "AIRBAG SYSTEM". [Ref. to AIRBAG SYSTEM>General Description>CAUTION.](#)**
- **Side impact sensor (under the rear center seat) for the airbag system is located under the front center of the rear seat cushion. Be careful not to apply strong impact to the sensor when working with the rear seat cushion removed.**

- 1.** Fabricate the cartridge nozzle tip as shown and set the sealant gun with the adhesive.

(a) 10 mm (0.39 in)

(b) 8 mm (0.31 in)

(c) Sealant gun

2. Smoothen and clean the adhesive surfaces of the glass rear window side and the body side, with the same procedures as for the glass windshield. [Ref. to GLASS/WINDOWS/MIRRORS>Windshield Glass>INSTALLATION.](#)

Caution:

Use a new locating pin rear window.

3. Install a new molding rear window to the glass rear window.

Caution:

Be careful to attach the rear window molding so that the molding has no loose or undulating part.

- (1) Align the molding rear window (A) with both ends of the upper edge (a) of the glass rear window (C).
- (2) Install the molding rear window from both corners of the upper edge toward the center (b).
- (3) Install the molding rear window from both corners of the upper edge toward the lower side (c).
- (4) Firmly apply the double sided tape (B) of the molding rear window evenly to the surface of the glass rear window.

4. Install a new dam rubber rear to the glass rear window.

- | | | |
|------------------------------|---------------------|----------------------------|
| (a) Locating pin rear window | (d) 17 mm (0.67 in) | (g) Dam rubber set mark |
| (b) Molding rear window | (e) 15 mm (0.59 in) | (h) 3 mm (0.12 in) or less |
| (c) Dam rubber rear window | (f) 3 mm (0.12 in) | |

5. Install the glass rear window in the same procedure as for the glass windshield. [Ref. to GLASS/WINDOWS/MIRRORS>Windshield Glass>INSTALLATION.](#)

(1) Apply the primer to the adhesive surface of glass rear window side and body side using sponge.

Caution:

Do not apply primer to adhesive remaining on the body side.

(2) Apply adhesive to the end back surface of the glass rear window.

- | | | |
|--|---------------------------------------|---------------------|
| (a) Molding rear window | (d) Application of primer (body side) | (g) 11 mm (0.43 in) |
| (b) Application of primer (glass side) | (e) Dam rubber rear window | (h) 12 mm (0.47 in) |
| (c) Adhesive | (f) 13 mm (0.51 in) | |

(3) Insert the locating pins rear window into the rear panel holes, and install the glass rear window.

(4) Lightly press the entire perimeter of the glass rear window for tight fit.

(5) Make flush the adhesive surface juttred out using spatula.

6. After completion of all work, allow the vehicle to stand for about 24 hours.

Note:

- **When opening/closing the door after the windshield glass was bonded, always lower the door glass assembly first, and then open/close it carefully.**
- **Move the vehicle slowly.**
- **For minimum drying time and vehicle standing time before driving after bonding, follow instructions or instruction manual from the adhesive manufacturer.**

7. Connect the rear defogger connector and the antenna connector.

8. Install the trim panel assembly rear shelf. [_Ref. to EXTERIOR/INTERIOR TRIM>Rear Shelf Trim>INSTALLATION.](#)

9. Install the trim panel assembly C pillar and the trim panel assembly C pillar LWR. [_Ref. to EXTERIOR/INTERIOR TRIM>Rear Quarter Trim>INSTALLATION.](#)

10. Install the backrest assembly and rear seat cushion assembly. [_Ref. to SEATS>Rear Seat>INSTALLATION.](#)

11. Connect the ground terminal to battery sensor. [_Ref. to REPAIR CONTENTS>NOTE > BATTERY.](#)

12. After curing of adhesive, pour the water on external surface of vehicle to check that there are no water leaks.

Caution:

When a vehicle is returned to the user, tell him or her that the vehicle should not be subjected to heavy impact for at least three days.

GLASS/WINDOWS/MIRRORS > Rear Window Defogger System

WIRING DIAGRAM

For the wiring diagram, refer to "Rear Defogger System" in the wiring diagram. [Ref. to WIRING SYSTEM>Rear Defogger System>WIRING DIAGRAM.](#)

GLASS/WINDOWS/MIRRORS > Rear Window Defogger System

INSPECTION

Trouble symptom:

Rear window defogger does not operate

Note:

System name	Initial setting	Customize setting
Rr Defogger op. mode	Normal	Continuous*

*: When one of the following conditions occurs, the continuous operation is suspended and turned to the normal operation.

- Battery voltage remains at 10 V or less for 30 seconds.
- Body integrated unit custom setting, [Auto A/C Setting], is set to No.

1. CHECK WITH SUBARU SELECT MONITOR

1. CHECK DTC.

1. Turn the ignition switch to ON.
2. Read DTCs of the following items using the Subaru Select Monitor. [Ref. to LAN SYSTEM \(DIAGNOSTICS\)>Diagnostic Trouble Code \(DTC\).](#)
 - [Body Control]
 - [Front Relay Control Module]
 - [Cockpit Control]
 - [Air Conditioner]

Is DTC displayed?

Yes

Perform the diagnosis for the displayed DTCs.

No

[Go to 2.](#)

2. CHECK BODY INTEGRATED UNIT SETTING.

Using the Subaru Select Monitor, check setting of [Auto A/C Setting]. [Ref. to BODY CONTROL\(DIAGNOSTICS\)>Customize.](#)

Is it set to [Support]?

Yes

[Go to 3.](#)

No

Change the customize setting to [Support].

3. CHECK SWITCH.

Operate the rear defogger switch on the center information display.

Does the rear defogger switch light illuminate or go off corresponding to the switch operation?

Yes

[Go to 4.](#)

No

[Go to 8.](#)

4. CHECK POWER SUPPLY CIRCUIT.

Display data of the following items using Subaru Select Monitor. [Ref. to COMMON \(DIAGNOSTICS\)>Data Monitor.](#)

- [Front Relay Control Module]
 - [BATT Voltage (Control)]
 - [BATT Voltage (BACKUP)]
 - [IGN Voltage]
- [Body control]
 - [BATT voltage (control)]
 - [BATT voltage (BACKUP)]
 - [IGN voltage]

Is the voltage 9 – 16 V?

Yes

[Go to 5.](#)

No

Check the harnesses of the battery, fuse, connector and power supply circuit.

5. CHECK REAR DEFOGGER SYSTEM OPERATION.

Using Subaru Select Monitor, perform [R Defogger Output] in the [Active Test] of [Front Relay Control Module]. [Ref. to FRONT RELAY CONTROL MODULE \(DIAGNOSTICS\)>Active Test.](#)

Does the rear defogger system operate normally?

Yes

[Go to 6.](#)

No

Check the harnesses of the heat wire, relay and output circuit.

6. CHECK FRONT RELAY CONTROL MODULE.

Using Subaru Select Monitor, display [R Defogger Request] in [Data monitor] of [Front Relay Control Module]. [Ref. to COMMON \(DIAGNOSTICS\)>Data Monitor.](#)

Does the display change between [OFF] ↔ [ON], when the rear defogger switch is operated?

Yes

Replace the front relay control module. [Ref. to BODY CONTROL/COMMUNICATION SYSTEM>Front Relay Control Module.](#)

No

[Go to 7.](#)

7. CHECK BODY INTEGRATED UNIT.

Using Subaru Select Monitor, display [Rr Defogger output] in [Data monitor] of [Body Control]. [Ref. to COMMON \(DIAGNOSTICS\)>Data Monitor.](#)

Does the display change between [OFF] ↔ [ON], when the rear defogger switch is operated?

Yes

Replace the front relay control module. [Ref. to BODY CONTROL/COMMUNICATION SYSTEM>Front Relay Control Module.](#)

No

Replace the body integrated unit. [Ref. to BODY CONTROL/COMMUNICATION SYSTEM>Body Integrated Unit.](#)

8. CHECK INPUT CIRCUIT.

1. Switch to dealership mode. [Ref. to COCKPIT CONTROL \(DIAGNOSTICS\)>Dealership Mode>OPERATION.](#)
2. Select [Function Check]. [Ref. to COCKPIT CONTROL \(DIAGNOSTICS\)>Dealership Mode>OPERATION > DEALERSHIP MODE.](#)
3. Check [Rr DEF] and [Push] are displayed when the rear defogger switch is pressed.
4. Check [Push] is switched to [Release] when the rear defogger switch is released.

Does it operate normally?

Yes

It is considered that trouble symptom was improved. Reproduce the failure, and then perform the inspection again.

No

Replace the center information display. [Ref. to ENTERTAINMENT & MONITORING>Cockpit Display.](#)

2. HEAT WIRE INSPECTION

Caution:

When wiping off the stain on glass with cloth, use a dry and soft cloth and move it in the direction of the heat wire extension to avoid damage to the heat wire.

1. Prepare the following checking items.
 - Liquid crystal thermograph sheet (approximate size: 300 × 300 mm (11.8 × 11.8 in) and thermal temperature: 35 — 40 °C (95 — 104 °F))
 - Aluminum foil
2. Turn the ignition switch to ON.
3. Turn the defogger switch to ON.
4. Push the liquid crystal thermograph sheet from the outside of the glass.

Note:

Use the liquid crystal thermograph sheet every range it is separated with the separate line.

(A) Liquid crystal thermograph sheet

(B) Separate line

5. Determine the faulty heat wire by checking the color of the liquid crystal thermograph sheet.

Note:

- Check from the inside of the glass rear window if the liquid crystal thermograph sheet does not change.
- The time for the color change may differ depends on the surface temperature of the glass.

Liquid crystal thermograph sheet	Criteria
Change occurred (red → blue)	Normal
No change (black)	Open

6. Wrap a piece of aluminum foil around the tip of tester probe and press it against the heat wire with your finger.

- (A) Tester probe
(B) Aluminum foil
(C) Heat wire

7. Fasten the tester probe on the positive (+) side and negative (-) side to end of positive side of the section that has been found to include an open in the step 5.
8. Move the tester probe on the negative (-) side slowly along the heat wire. If voltage changes from zero while moving the tester probe, heat wire is open at the voltage change point.

9. Repair the heat wire that determines the place of the open circuit. [Ref. to GLASS/WINDOWS/MIRRORS>Rear Window Defogger System>REPAIR.](#)

GLASS/WINDOWS/MIRRORS > Rear Window Defogger System

REPAIR

1. Clean the broken portion with alcohol or appropriate cleaning solvent.
2. Mask both side of wire with masking tape.
3. Apply the repairing material to the broken portion.

Preparation items:

Repairing material: DUPONT No. 4817 or equivalent

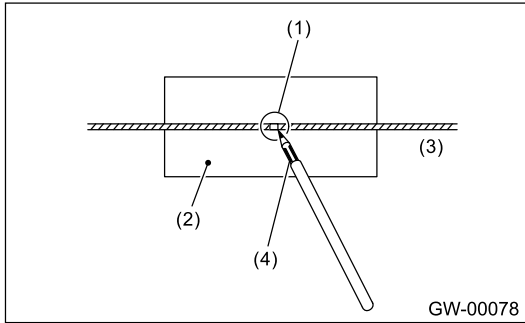

- (1) Broken portion
- (2) Masking tape
- (3) Broken wire
- (4) Conductive silver composition

4. After repair, check the wire.

GLASS/WINDOWS/MIRRORS > Wiper Deicer System

WIRING DIAGRAM

For the wiring diagram, refer to "Wiper Deicer System" in the wiring diagram. [Ref. to WIRING SYSTEM>Wiper Deicer System>WIRING DIAGRAM.](#)

GLASS/WINDOWS/MIRRORS > Wiper Deicer System

INSPECTION

Trouble symptom:

Wiper deicer does not operate.

Note:

System name	Initial setting	Customize setting
Rr Defogger op. mode	Normal	Continuous*

*: When one of the following conditions occurs, the continuous operation is suspended and turned to the normal operation.

- Ambient temperature at 5°C (41°F) or more continues for 10 seconds.
- Ambient temperature sensor malfunction continues for 10 seconds.
- Vehicle speed less than 15 km/h (9 MPH)
- CAN communication malfunction continues for 10 seconds.
- Battery voltage remains at 10 V or less for 30 seconds.
- SI-DRIVE [I] mode driving continues for 10 seconds.

1. CHECK WITH SUBARU SELECT MONITOR

1. CHECK DTC.

1. Turn the ignition switch to ON.
2. Read DTCs of the following items using the Subaru Select Monitor. [Ref. to LAN SYSTEM \(DIAGNOSTICS\)>Diagnostic Trouble Code \(DTC\).](#)
 - [Body Control]
 - [Front Relay Control Module]
 - [Cockpit Control]
 - [Air Conditioner]

Is DTC displayed?

Yes

Perform the diagnosis for the displayed DTCs.

No

[Go to 2.](#)

2. CHECK BODY INTEGRATED UNIT SETTING.

Using the Subaru Select Monitor, check setting of [wiperdeicer]. [Ref. to BODY CONTROL\(DIAGNOSTICS\)>Customize.](#)

Is it set to [Support]?

Yes

[Go to 3.](#)

No

Change the customize setting to [Support].

3. CHECK SWITCH.

Operate the rear defogger switch on the center information display.

Does the rear defogger switch light illuminate or go off corresponding to the switch operation?

Yes

[Go to 4.](#)

No

[Go to 8.](#)

4. CHECK POWER SUPPLY CIRCUIT.

Display data of the following items using Subaru Select Monitor. [Ref. to COMMON \(DIAGNOSTICS\)>Data Monitor.](#)

- [Front Relay Control Module]
 - [BATT Voltage (Control)]
 - [BATT Voltage (BACKUP)]
 - [IGN Voltage]
- [Body control]
 - [BATT voltage (control)]
 - [BATT voltage (BACKUP)]
 - [IGN voltage]

Is the voltage 9 – 16 V?

Yes

[Go to 5.](#)

No

Check the harnesses of the battery, fuse, connector and power supply circuit.

5. CHECK WIPER DEICER SYSTEM OPERATION.

Using Subaru Select Monitor, perform [Wiper Deicer Output] in the [Active Test] of [Front Relay Control Module]. [Ref. to FRONT RELAY CONTROL MODULE \(DIAGNOSTICS\)>Active Test.](#)

Does the wiper deicer system operate normally?

Yes

[Go to 6.](#)

No

Check the harnesses of the heat wire, relay and output circuit.

6. CHECK FRONT RELAY CONTROL MODULE.

Using Subaru Select Monitor, display [Wiper Deicer Request] in [Data monitor] of [Front Relay Control Module]. [Ref. to COMMON \(DIAGNOSTICS\)>Data Monitor.](#)

Does the display change between [OFF] ↔ [ON], when the rear defogger switch is operated?

Yes

Replace the front relay control module. [Ref. to BODY CONTROL/COMMUNICATION SYSTEM>Front Relay Control Module.](#)

No

[Go to 7.](#)

7. CHECK BODY INTEGRATED UNIT.

Using Subaru Select Monitor, display [wiper deicer output] in [Data monitor] of [Body Control]. [Ref. to COMMON \(DIAGNOSTICS\)>Data Monitor.](#)

Does the display change between [OFF] ↔ [ON], when the rear defogger switch is operated?

Yes

Replace the front relay control module. [Ref. to BODY CONTROL/COMMUNICATION SYSTEM>Front Relay Control Module.](#)

No

Replace the body integrated unit. [Ref. to BODY CONTROL/COMMUNICATION SYSTEM>Body Integrated Unit.](#)

8. CHECK INPUT CIRCUIT.

1. Switch to dealership mode. [Ref. to COCKPIT CONTROL \(DIAGNOSTICS\)>Dealership Mode>OPERATION.](#)
2. Select [Function Check]. [Ref. to COCKPIT CONTROL \(DIAGNOSTICS\)>Dealership Mode>OPERATION > DEALERSHIP MODE.](#)
3. Check [Rr DEF] and [Push] are displayed when the rear defogger switch is pressed.
4. Check [Push] is switched to [Release] when the rear defogger switch is released.

Does it operate normally?

Yes

It is considered that trouble symptom was improved. Reproduce the failure, and then perform the inspection again.

No

Replace the center information display. [Ref. to ENTERTAINMENT & MONITORING>Cockpit Display.](#)

2. HEAT WIRE INSPECTION

For inspection of the heat wire, refer to "HEAT WIRE INSPECTION" of "Rear Window Defogger System". [Ref. to GLASS/WINDOWS/MIRRORS>Rear Window Defogger System>INSPECTION > HEAT WIRE INSPECTION.](#)

Note:

Heat wire inspection needs removing/installing procedure of instrument panel assembly.

GLASS/WINDOWS/MIRRORS > Wiper Deicer System

REPAIR

For repair of the heat wire, refer to "REPAIR" of "Rear Window Defogger System". [Ref. to GLASS/WINDOWS/MIRRORS>Rear Window Defogger System>REPAIR.](#)

Note:

Heat wire repair needs removing/installing procedure of instrument panel assembly.