

3. Tools for Diagnostics

CAUTION:

Be sure to use specified test harness A, B or C when measuring voltage, resistance, etc. of AIRBAG system component parts.

A: TEST HARNESS A

PN 98299PA000

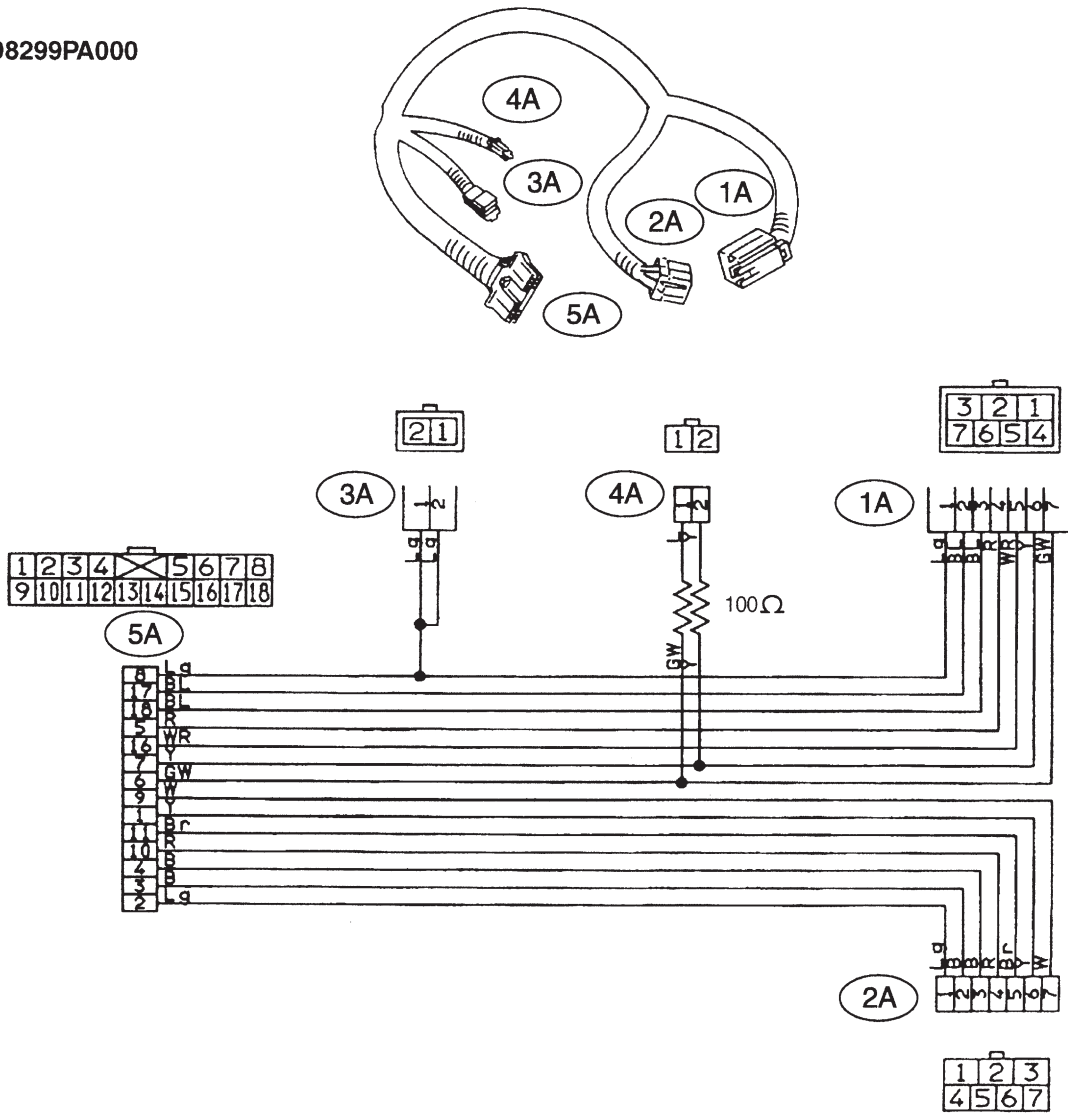

B5M0112A

B: TEST HARNESS B2

PN 98299PA011

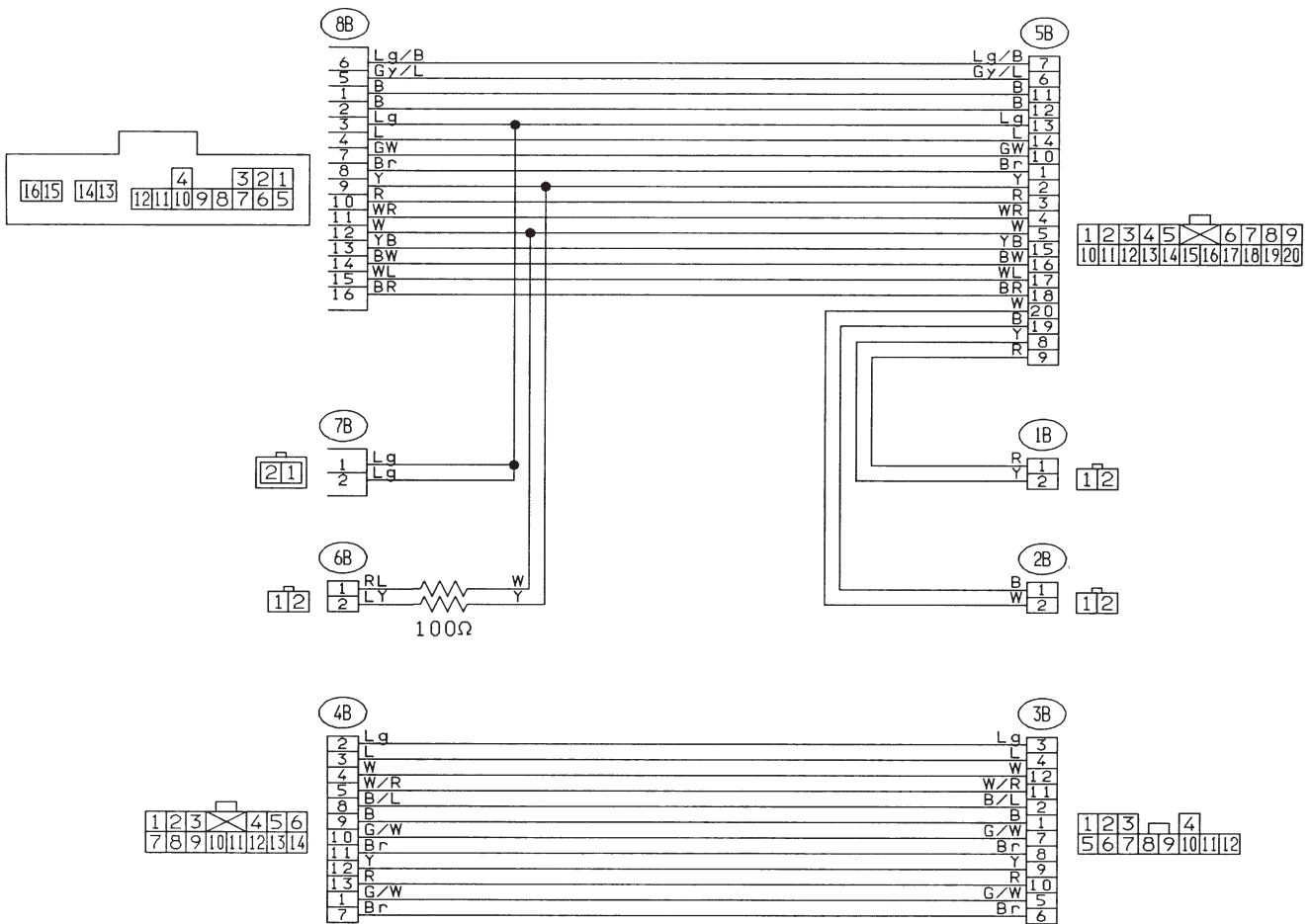
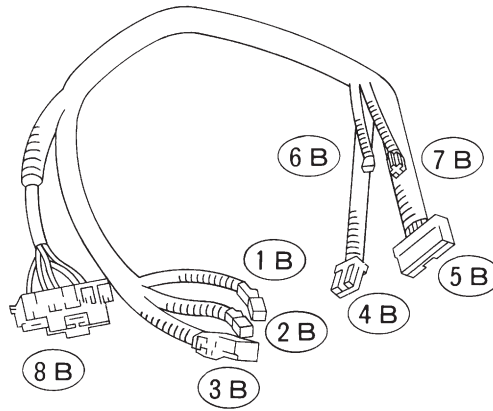

G5M0593

C: TEST HARNESS C

PN 98299PA020

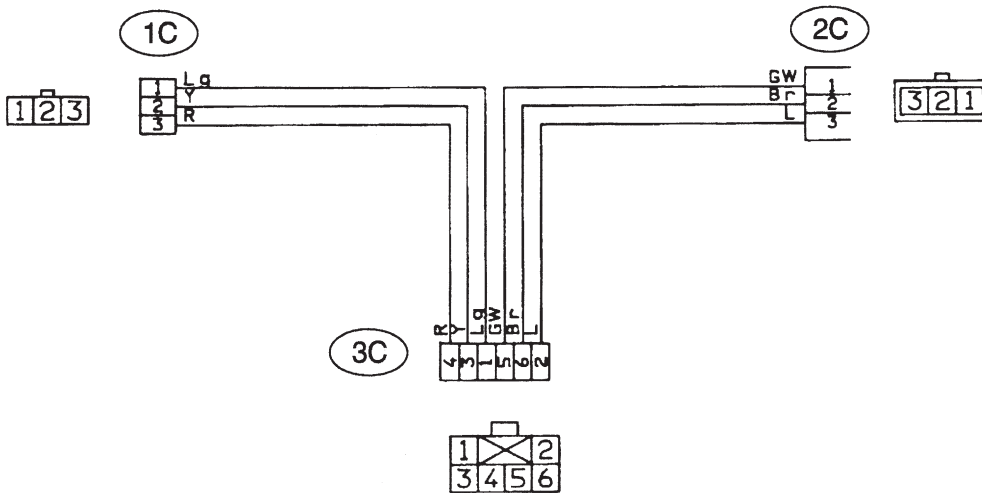
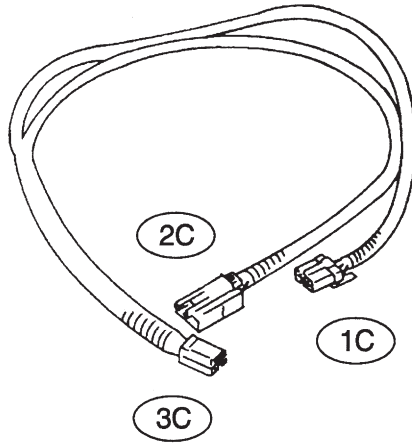

B5M0113A

D: AIRBAG RESISTOR

The airbag resistor is used during diagnostics. The airbag resistor has the same resistance as the airbag module and thus provides safety when used instead of the airbag module. It also makes it possible to finish, diagnostics in less time.

PN 98299PA040

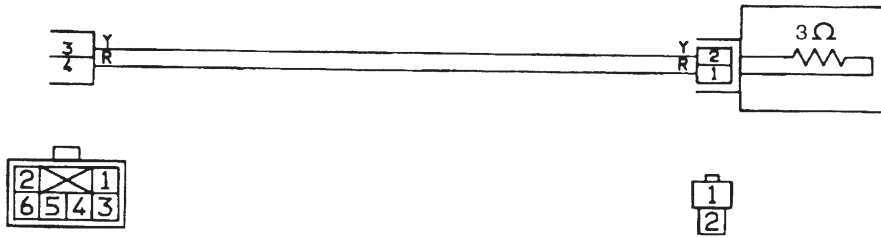
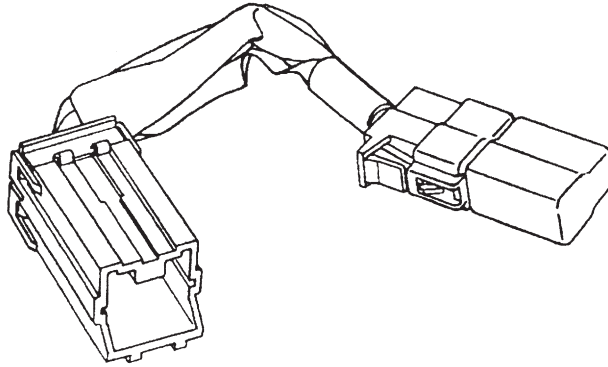

B5M0114A