

30. Turn Signal Light and Hazard Light System

A: WIRING DIAGRAM

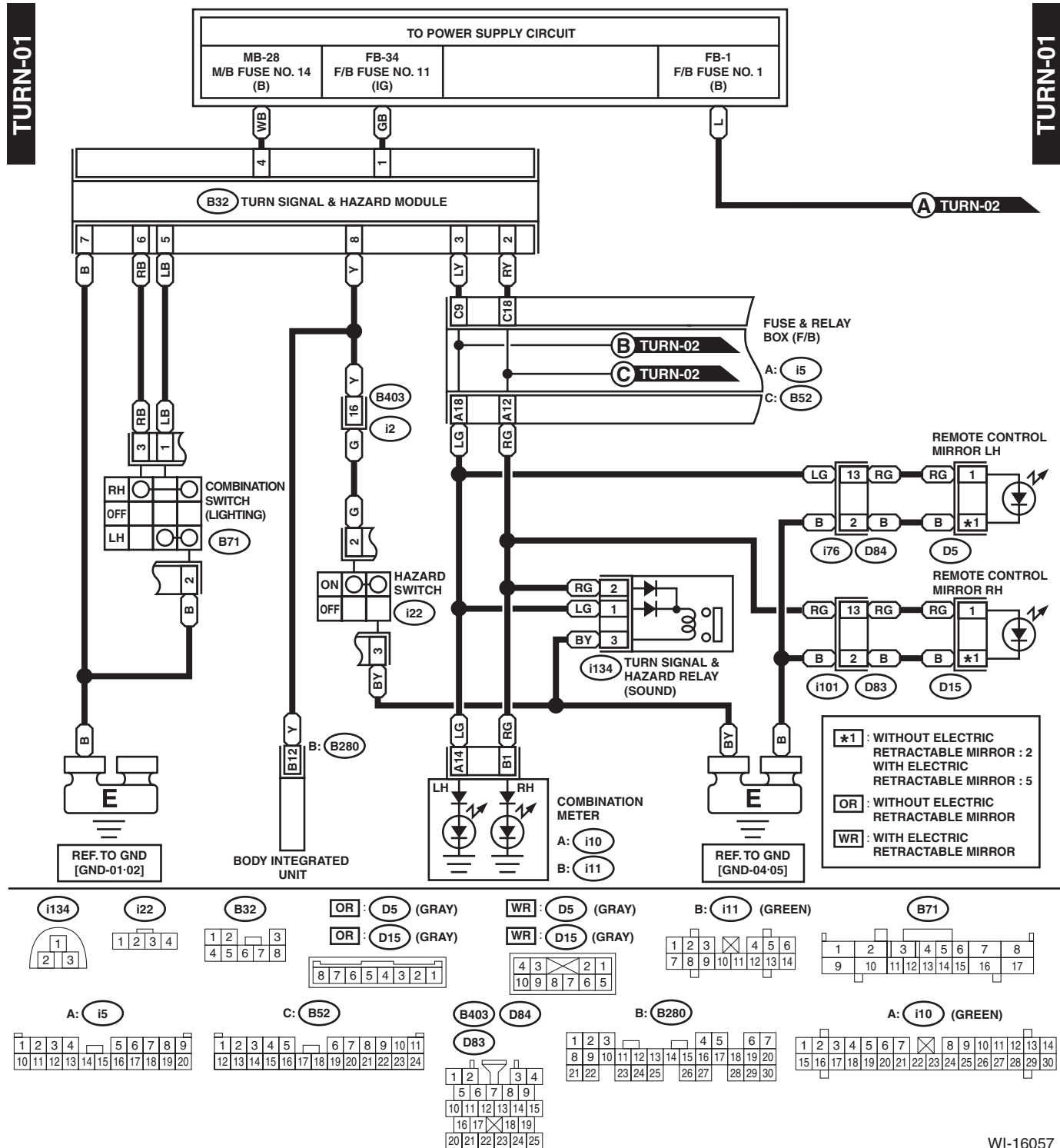

WI-16057

Turn Signal Light and Hazard Light System

WIRING SYSTEM

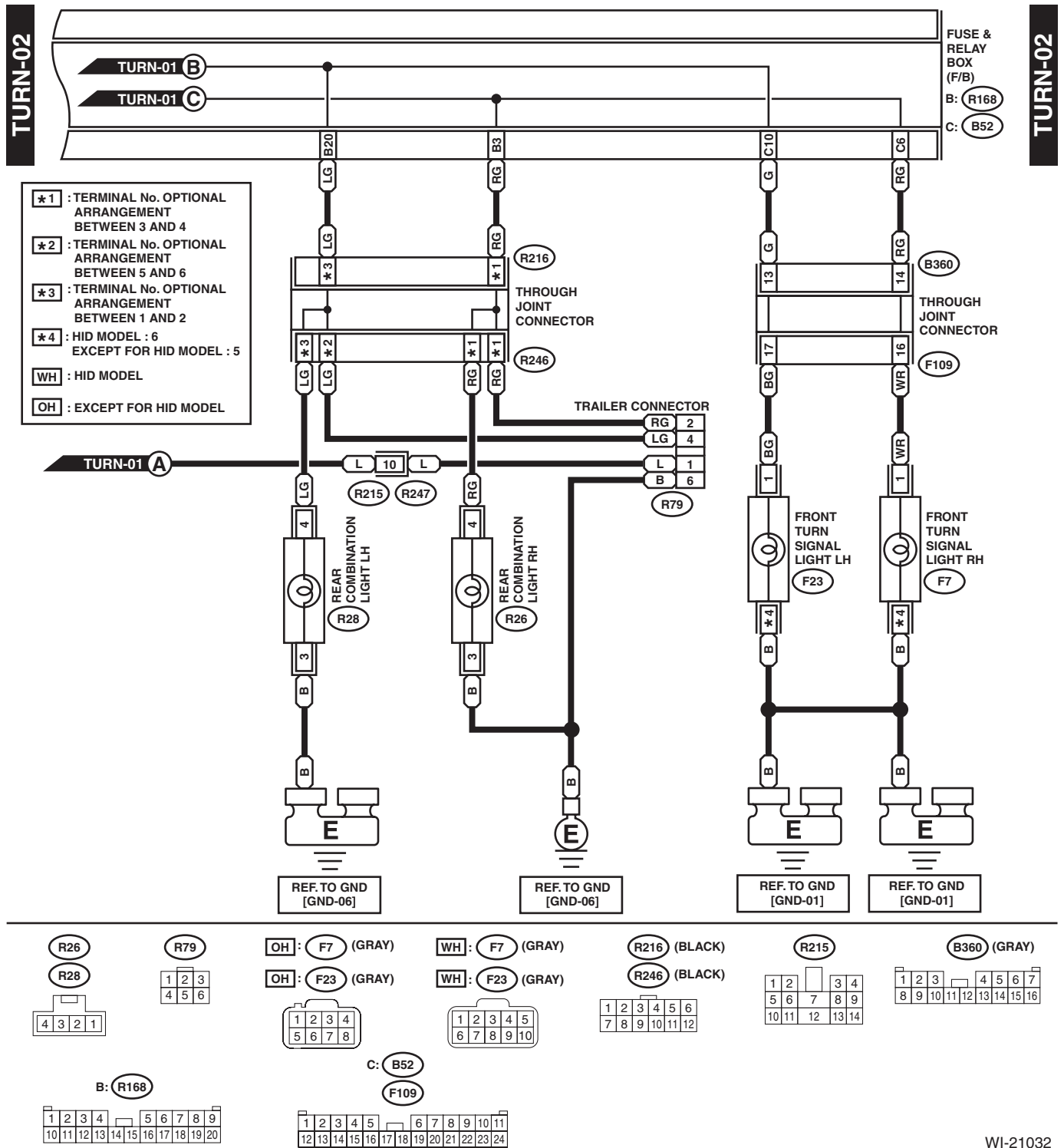

WI-21032