

## 40.Rear Entertainment System

### A: WIRING DIAGRAM

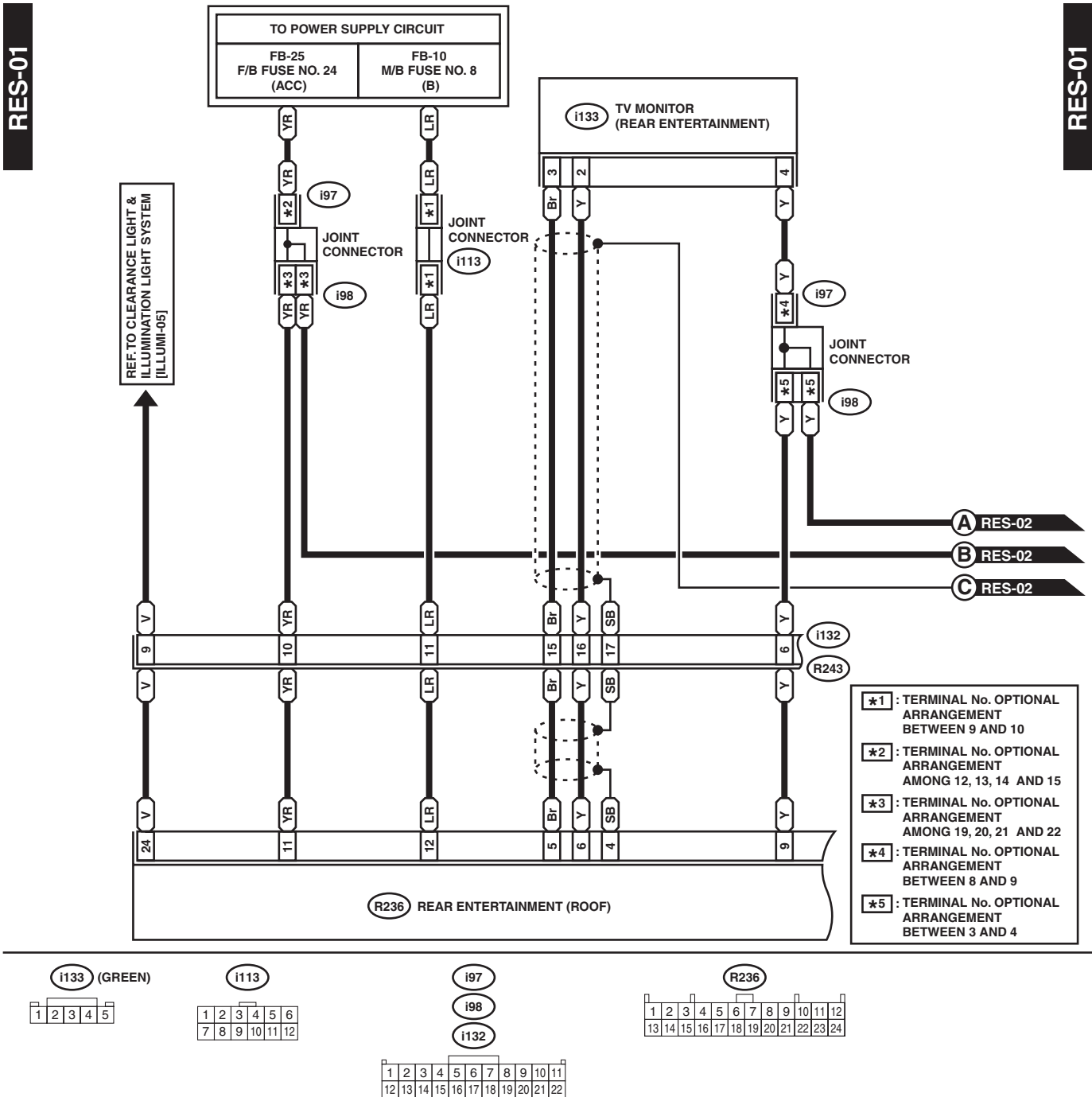

# Rear Entertainment System

WIRING SYSTEM

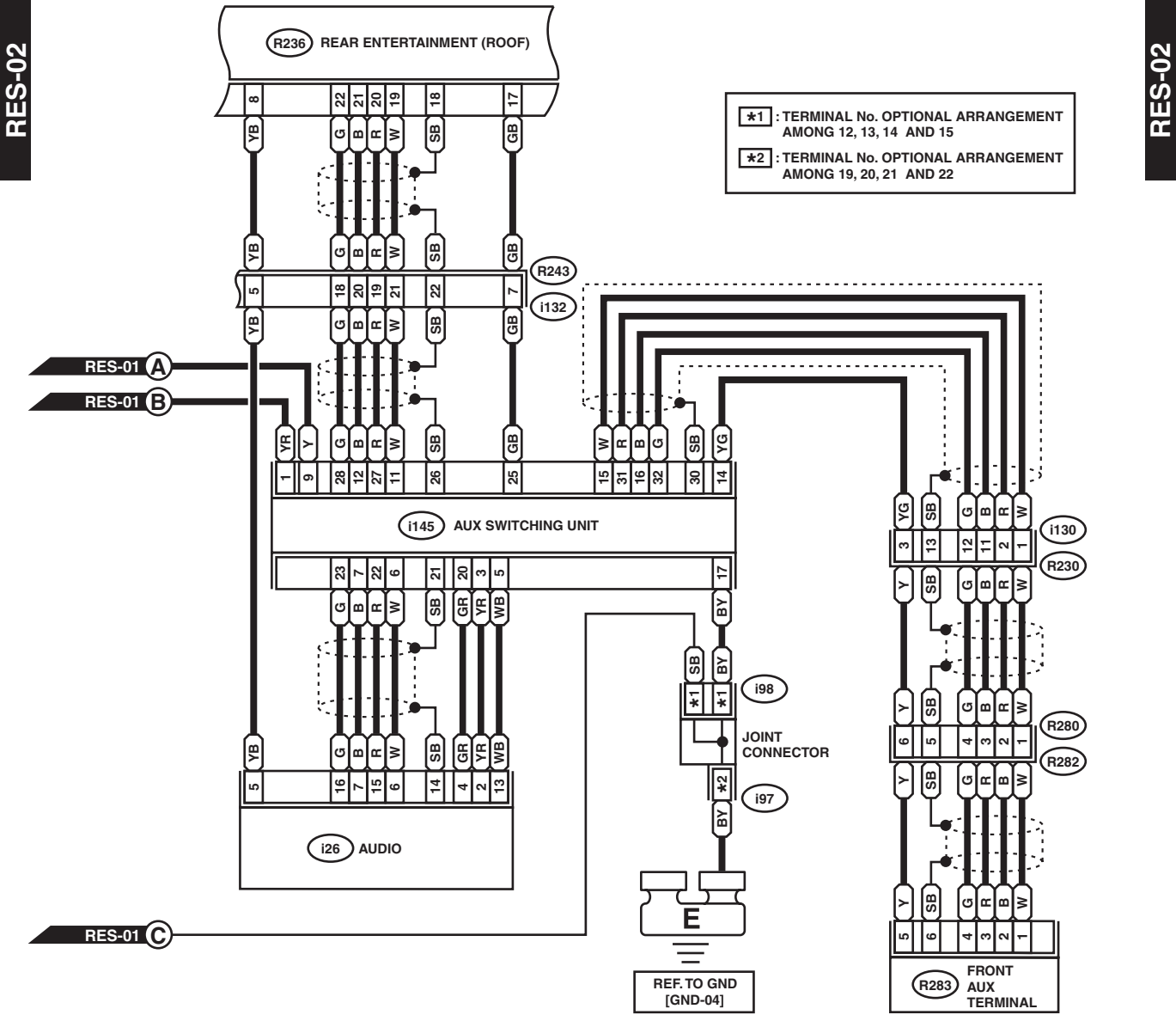

\*1 : TERMINAL No. OPTIONAL ARRANGEMENT AMONG 12, 13, 14 AND 15  
 \*2 : TERMINAL No. OPTIONAL ARRANGEMENT AMONG 19, 20, 21 AND 22

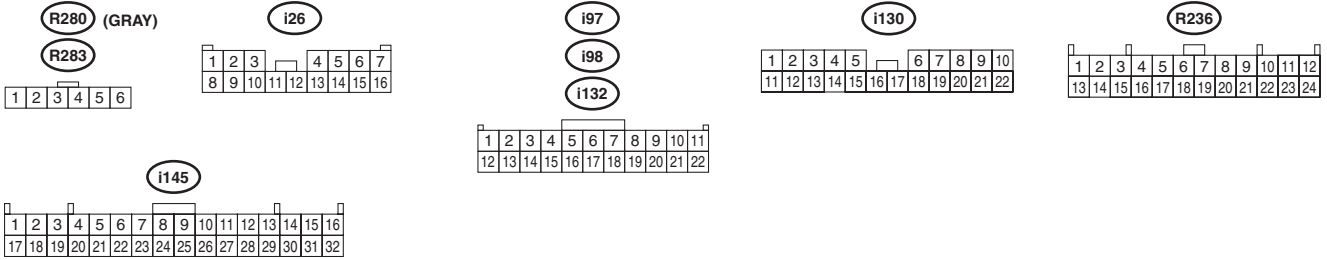

WI-16081

# Rear Entertainment System

WIRING SYSTEM

RES-03

RES-03

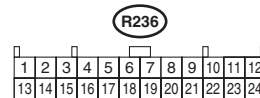
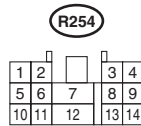
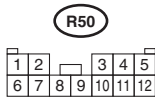
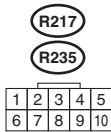
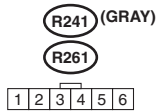
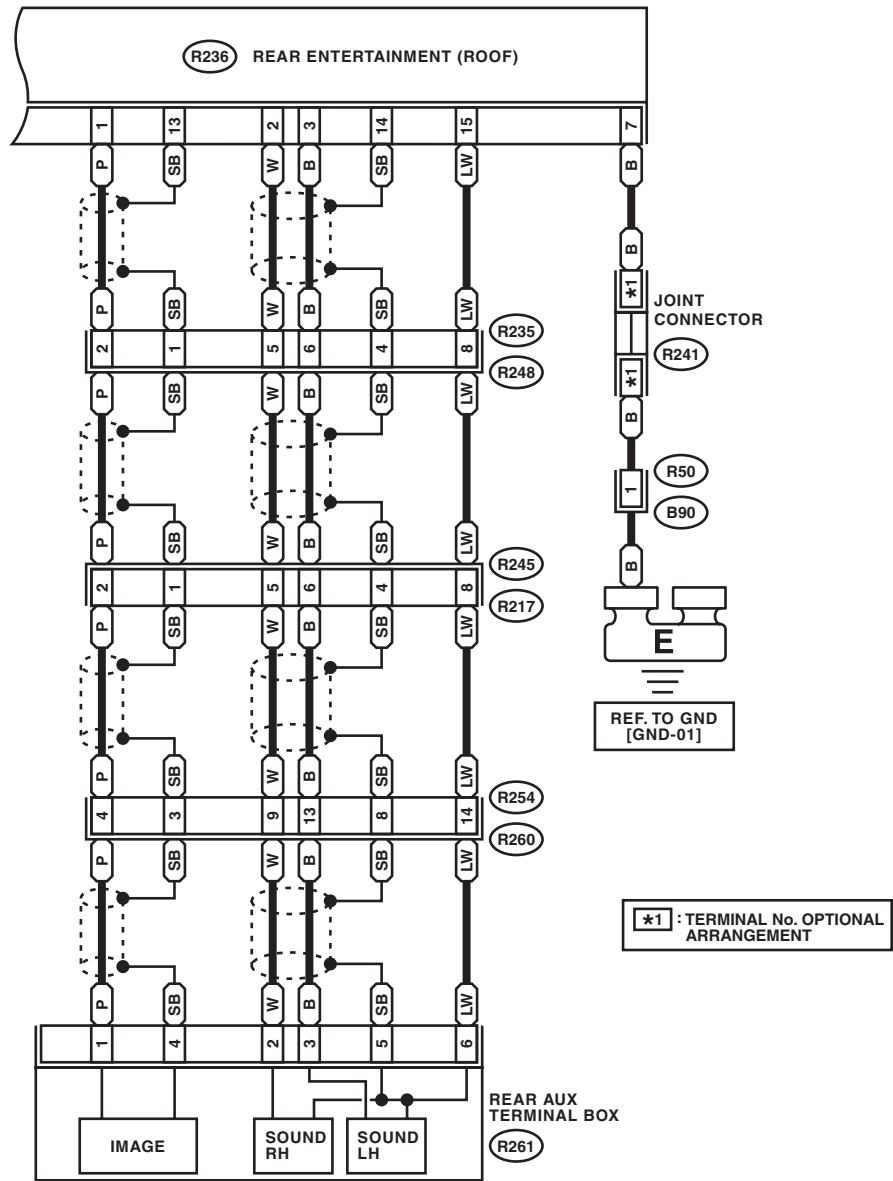

WI-16082