

Vehicle Dynamics Control System

WIRING SYSTEM

9. Vehicle Dynamics Control System

A: WIRING DIAGRAM

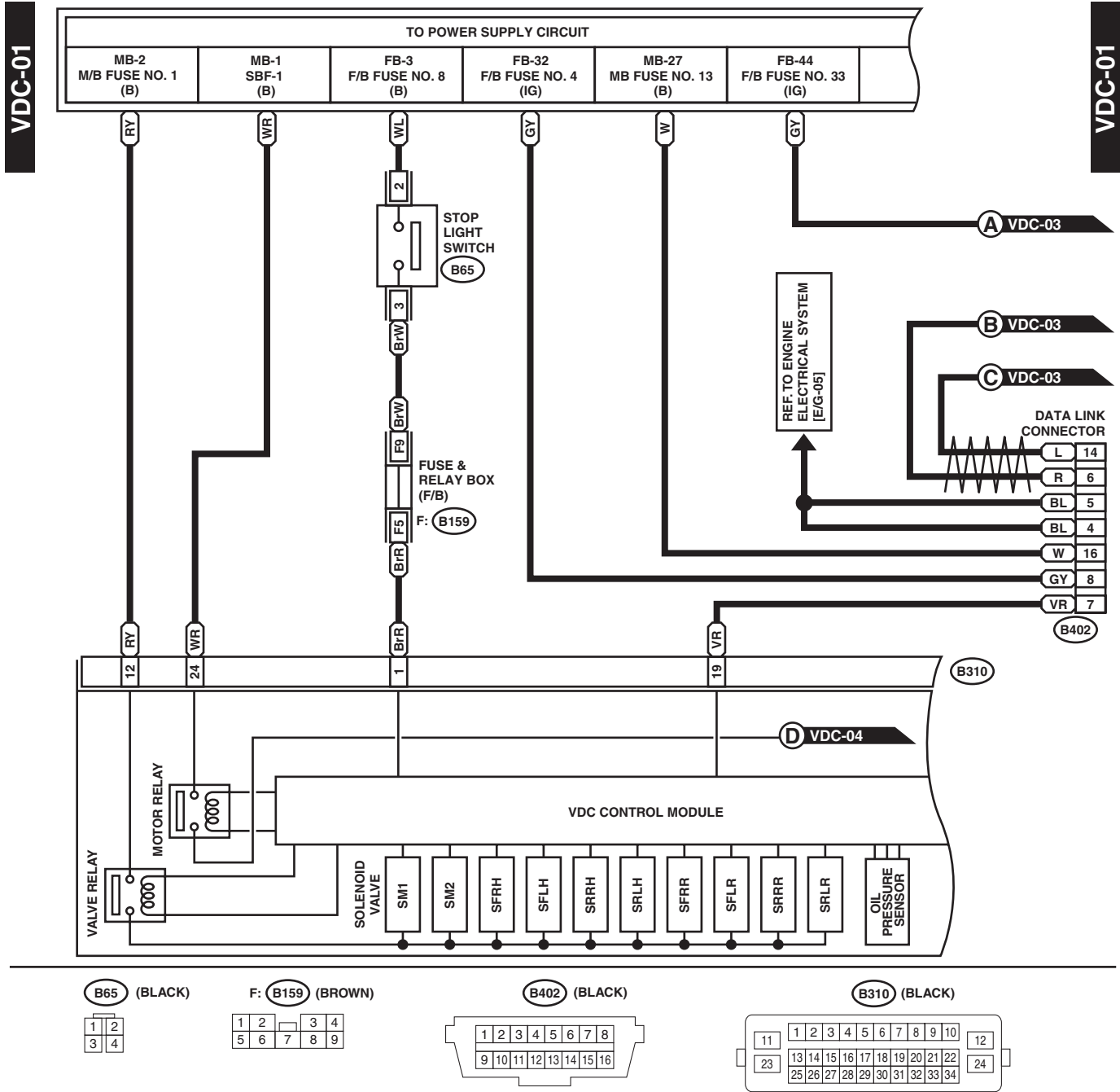

WI-19708

Vehicle Dynamics Control System

WIRING SYSTEM

VDC-02

VDC-02

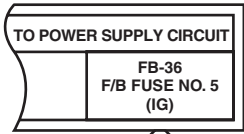

★1 : TERMINAL No. OPTIONAL ARRANGEMENT AMONG 10, 11 AND 12
 ★2 : TERMINAL No. OPTIONAL ARRANGEMENT AMONG 7, 8 AND 9

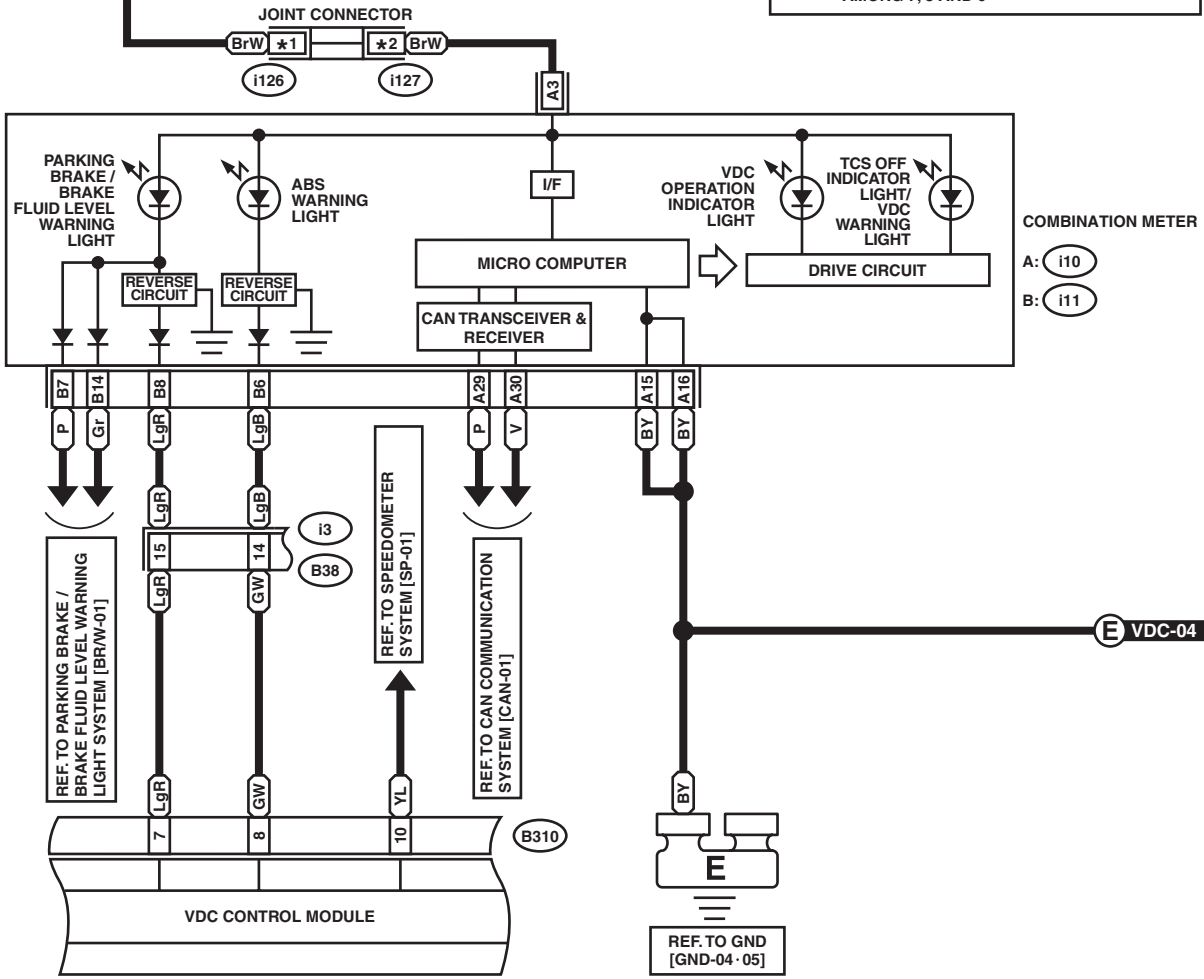

i126 (BLACK)
 i127 (BLACK)

B: i11 (GREEN)

B38

A: i10 (GREEN)

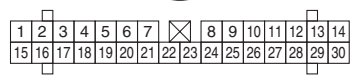
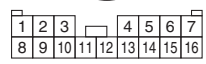
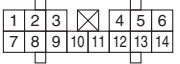
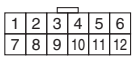

B310 (BLACK)

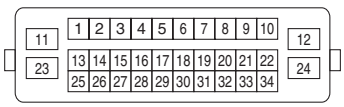

WI-19709

Vehicle Dynamics Control System

WIRING SYSTEM

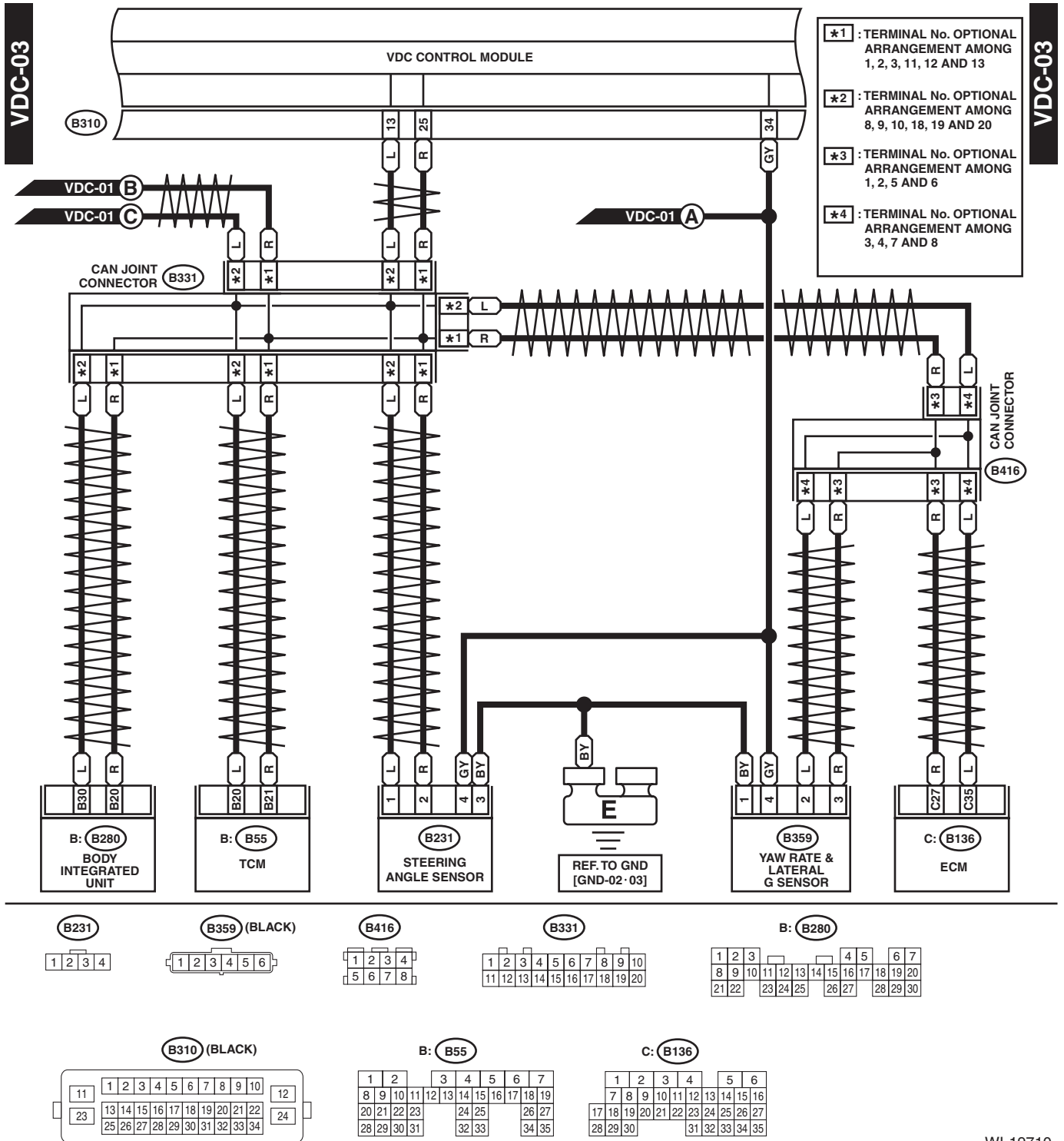

Vehicle Dynamics Control System

WIRING SYSTEM

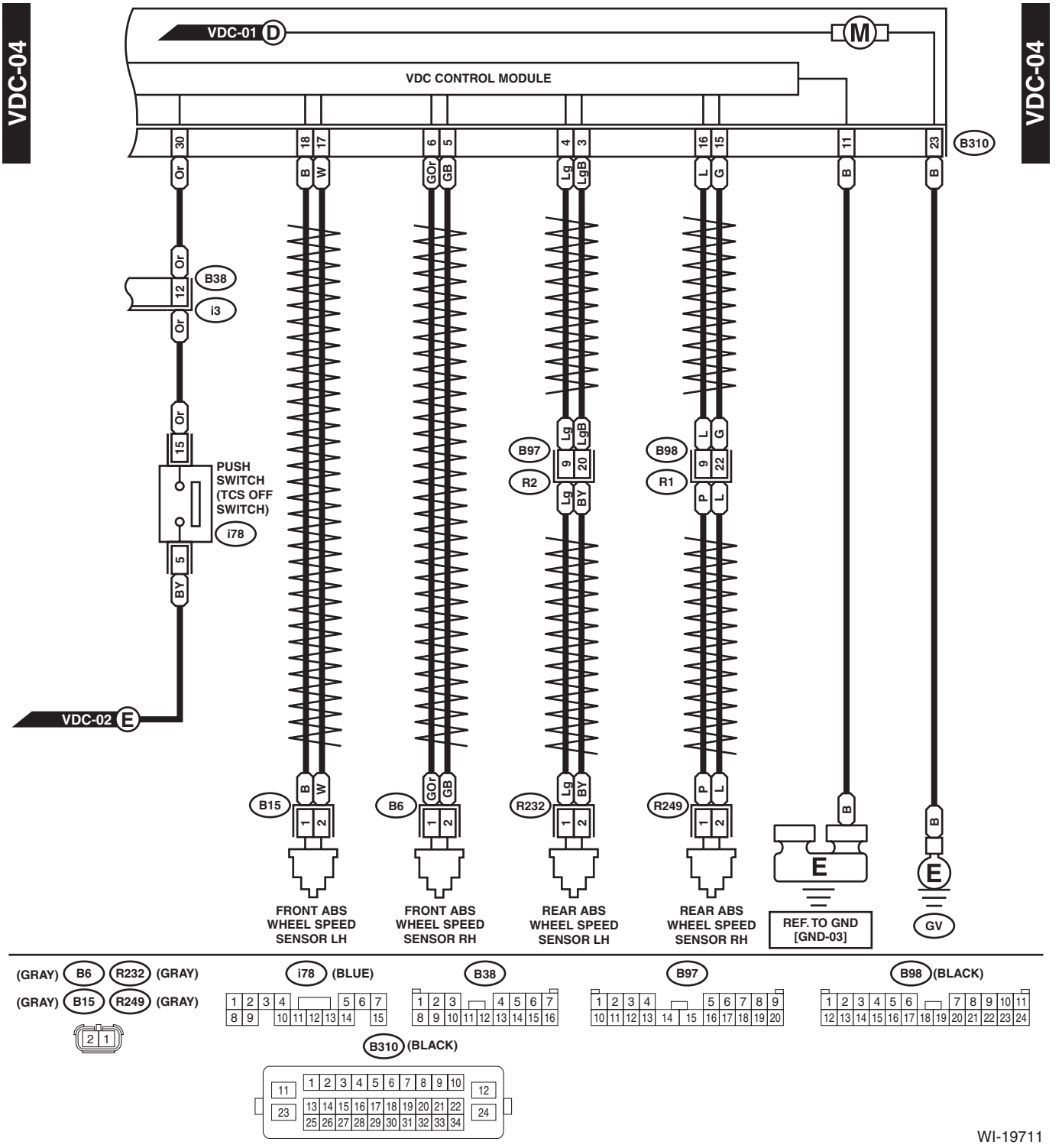

WI-19711