

11. Preparation for Overhaul

A: REMOVAL

1) Remove the engine from vehicle. <Ref. to ME(H6DO)-36, REMOVAL, Engine Assembly.>

2) Set the engine on ST.

ST 18232AA000 ENGINE STAND

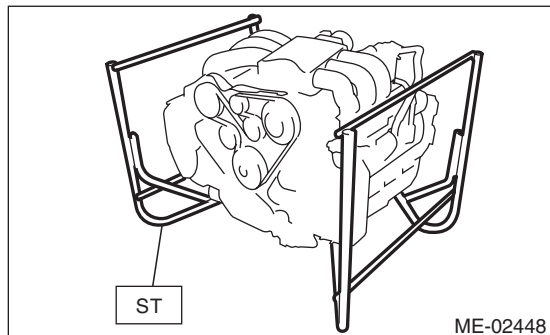

3) Before servicing overhaul, remove the sensor, pipe and hose that installed to engine.

(1) Remove the intake manifold. <Ref. to FU(H6DO)-22, REMOVAL, Intake Manifold.>

(2) Remove the generator. <Ref. to SC(H6DO)-12, REMOVAL, Generator.>

(3) Remove the A/C compressor. <Ref. to AC-33, REMOVAL, Compressor.>

(4) Disconnect the water pipe and hose.

(5) Disconnect the engine harness.

(6) Remove the spark plug. <Ref. to IG(H6DO)-4, REMOVAL, Spark Plug.>

(7) Remove the camshaft position sensor. <Ref. to FU(H6DO)-34, REMOVAL, Camshaft Position Sensor.>

(8) Remove the crankshaft position sensor. <Ref. to FU(H6DO)-31, REMOVAL, Crankshaft Position Sensor.>

(9) Remove the knock sensor. <Ref. to FU(H6DO)-37, REMOVAL, Knock Sensor.>

(10) Remove the engine coolant temperature sensor. <Ref. to FU(H6DO)-30, REMOVAL, Engine Coolant Temperature Sensor.>

(11) Remove the oil temperature sensor. <Ref. to FU(H6DO)-47, REMOVAL, Oil Temperature Sensor.>

(12) Remove the oil flow control solenoid valve. <Ref. to FU(H6DO)-45, REMOVAL, Oil Flow Control Solenoid Valve.>

(13) Remove the oil pressure switch. <Ref. to LU(H6DO)-15, REMOVAL, Oil Pressure Switch.>

(14) Remove the oil filter. <Ref. to LU(H6DO)-16, REMOVAL, Engine Oil Filter.>

(15) Remove the oil cooler. <Ref. to LU(H6DO)-17, REMOVAL, Oil Cooler.>