

CIRCUIT INSPECTION

DTC	C0200 / 31 to C0215 / 34	Speed Sensor Circuit
------------	---------------------------------	-----------------------------

CIRCUIT DESCRIPTION

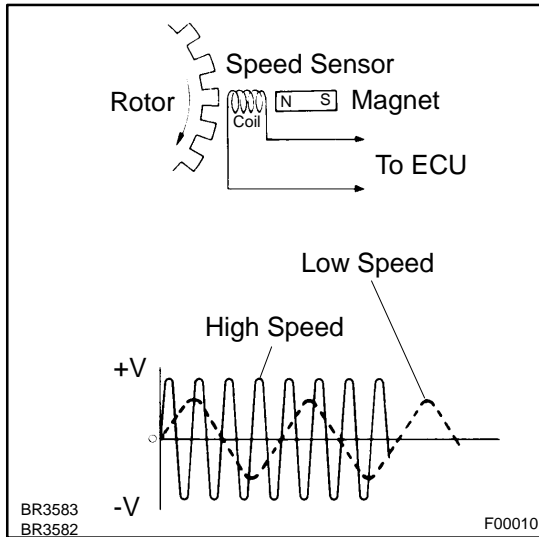

The speed sensor detects wheel speed and sends the appropriate signals to the ECU. These signals are used to control of the ABS system. The front and rear rotors each have 48 serrations.

When the rotors rotate, the magnetic field emitted by the permanent magnet in the speed sensor generates an AC voltage. Since the frequency of this AC voltage changes in direct proportion to the speed of the rotor, the frequency is used by the ECU to detect the speed of each wheel.

DTC No.	DTC Detecting Condition	Trouble Area
C0200 / 31 C0205 / 32 C0210 / 33 C0215 / 34	Detection of any of conditions from 1. through 4.: 1. With vehicle speed at 10 km/h or more, sensor signal circuit of faulty wheel is open or short for 30 sec. or longer. 2. Momentary interruption of sensor signal of faulty wheel has occurred 7 times or more. 3. Sensor signal circuit is open for 0.2 sec. or longer.	<ul style="list-style-type: none"> • Right front, left front, right rear, left rear speed sensor • Each speed sensor circuit • Sensor installation • Sensor rotor

HINT:

- DTC No. C0200 / 31 is for the right front speed sensor.
- DTC No. C0205 / 32 is for the left front speed sensor.
- DTC No. C0210 / 33 is for the right rear speed sensor.
- DTC No. C0215 / 34 is for the left rear speed sensor.

WIRING DIAGRAM

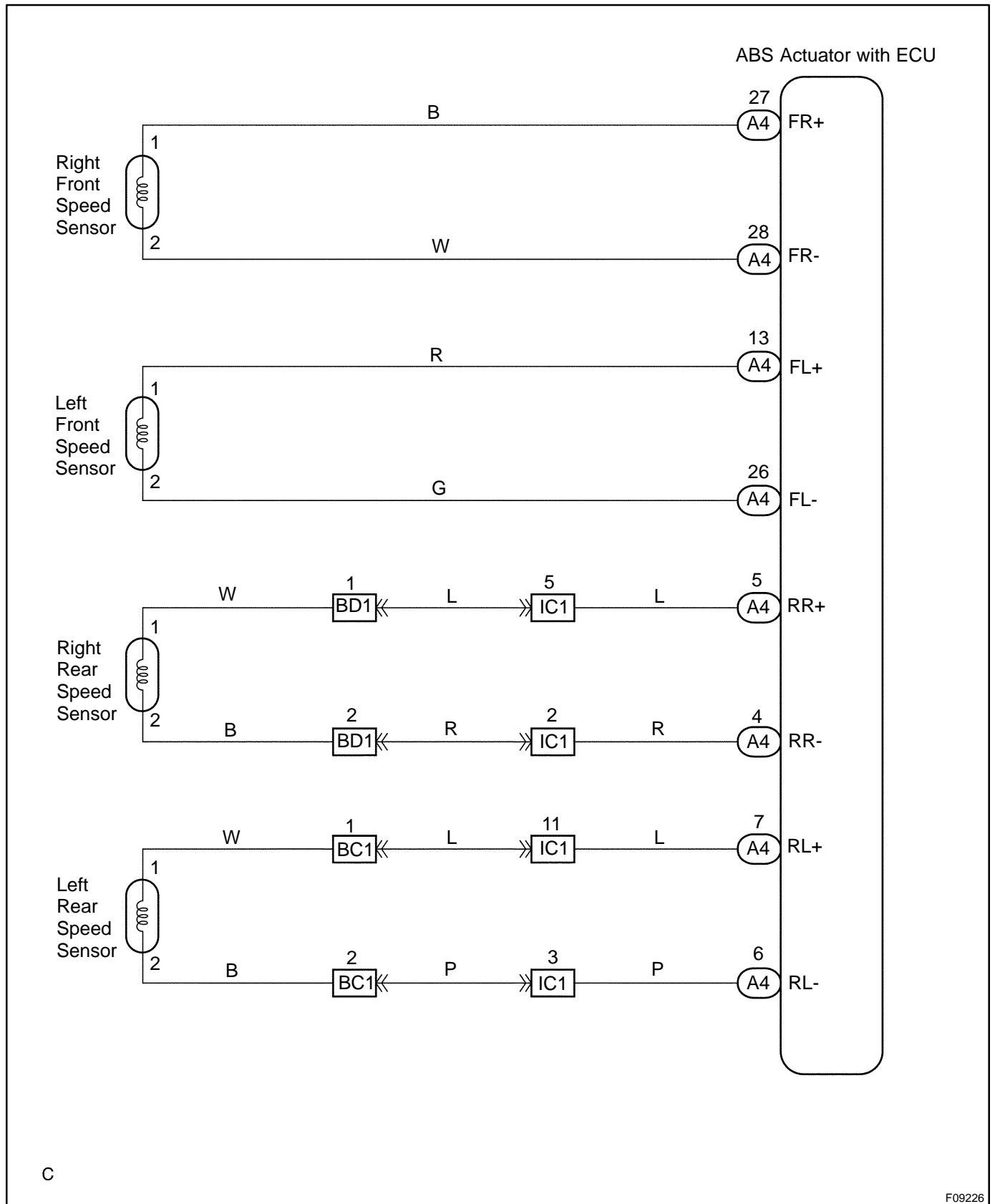

INSPECTION PROCEDURE

HINT:

Start the inspection from step 1 in case of using the TOYOTA hand-held tester and start from step 2 in case of not using the TOYOTA hand-held tester.

1	Check output value of speed sensor.
----------	--

PREPARATION:

- (a) Connect the TOYOTA hand-held tester to the DLC3.
- (b) Turn the ignition switch ON and push the TOYOTA hand-held tester main switch ON.
- (c) Select the DATALIST mode on the TOYOTA hand-held tester.

CHECK:

Check that there is no difference between the speed value output from the speed sensor displayed on the TOYOTA hand-held tester and the speed value displayed on the speedometer when driving the vehicle.

OK:

There is almost no difference from the displayed speed value.

HINT:

There is tolerance of $\pm 10\%$ in the speedometer indication.

OK	Check and replace ABS actuator assembly.
-----------	---

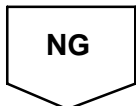

2	Check speed sensor.
----------	----------------------------

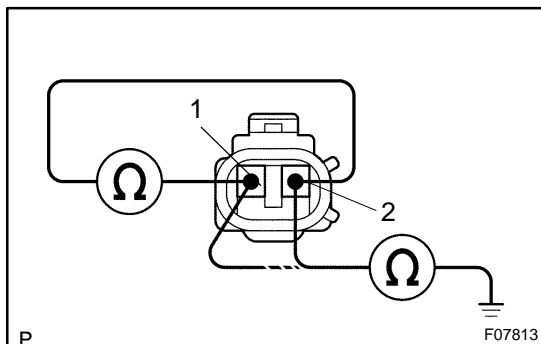

Front:

PREPARATION:

Disconnect the speed sensor connector.

CHECK:

Measure resistance between terminals 1 and 2 of speed sensor connector.

OK:

Resistance: 1.4 - 1.8 k Ω

CHECK:

Measure resistance between each of terminals 1 and 2 of speed sensor connector and body ground.

OK:

Resistance: 1 M Ω or higher

NG	Replace front speed sensor.
-----------	------------------------------------

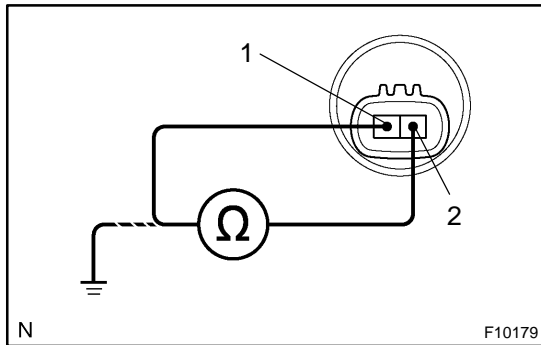
**Rear speed sensor:****PREPARATION:**

- Make sure that there is no looseness at the connector lock part and connecting part of the connector.
- Disconnect the speed sensor connector at hub bearing .

CHECK:

Measure resistance between terminals 1 and 2 of speed sensor connector.

OK:

Resistance: 0.9 - 1.3 kΩ at 25 ± 5 °C

CHECK:

Measure resistance between terminals 1 and 2 of speed sensor connector at hub bearing and body ground.

OK:

Resistance: 1 MΩ or higher

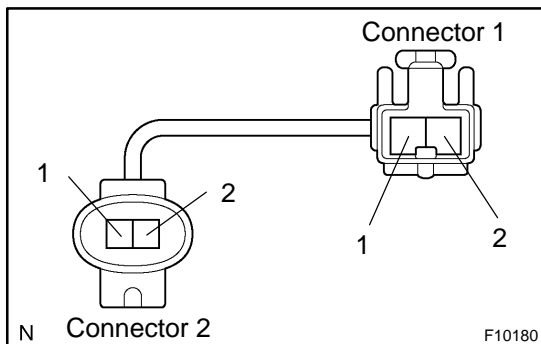
**Rear speed sensor sub-wire harness:****PREPARATION:**

- Remove the seat cushion and seatback.
- Make sure that there is no looseness at the connector lock part and connecting part of the connector.
- Disconnect the speed sensor connector inside vehicle.

CHECK:

- Measure resistance between terminal 1 of connector 1 and terminal 2 of connector 2.
- Measure resistance between terminal 2 of connector 1 and terminal 1 of connector 2.

OK:

Resistance: below 1 Ω

CHECK:

Measure resistance between terminals 1 and 2 of speed sensor connector 1 and body ground.

OK:

Resistance: 1 MΩ or higher

NG

Replace speed sensor or sub-wire harness.

NOTICE:

Check the speed sensor signal last (See page [DI-201](#)).

OK

3 Check for open and short circuit in harness and connector between each speed sensor and ABS ECU (See page [IN-29](#)).

NG Repair or replace harness or connector.

OK

4 Check speed sensor installation.

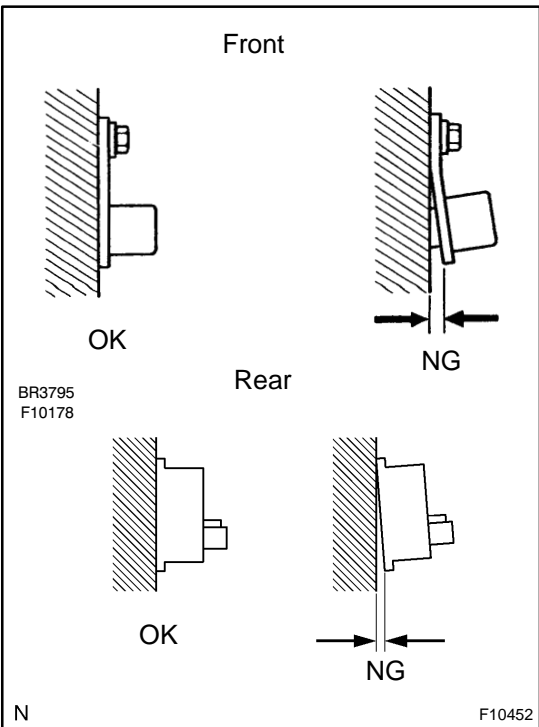

CHECK:

Check the speed sensor installation.

OK:

The installation bolt is tightened properly and there is no clearance between the sensor and steering knuckle or rear axle hub.

NG Replace speed sensor.

NOTICE:

Check the speed sensor signal last (See page [DI-201](#)).

OK

5 Check speed sensor and sensor rotor serrations.

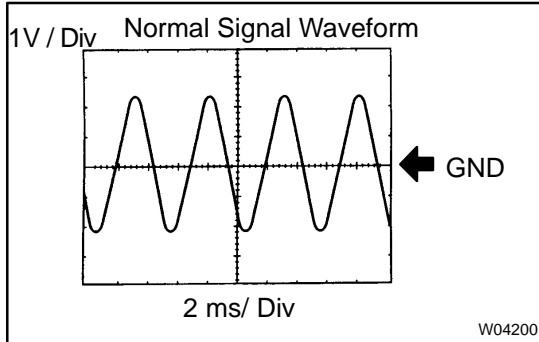

(REFERENCE) INSPECTION USING OSCILLOSCOPE

PREPARATION:

Connect the oscilloscope to the terminals FR+, FL+, RR+, or RL+ and GND of the ABS actuator assembly.

CHECK:

Drive the vehicle at 20 km/h (12 mph), and check the signal waveform.

OK

Check and replace ABS actuator.

NG

6 Check sensor rotor and sensor tip.

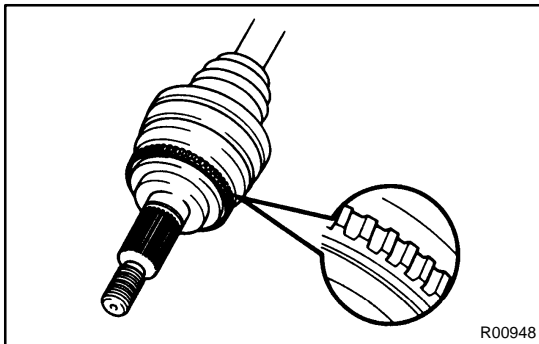

Front:

PREPARATION:

Remove the front drive shaft (See page [SA-18](#)).

CHECK:

Check the sensor rotor serrations.

OK:

No scratches, missing teeth or foreign objects.

PREPARATION:

Remove the front speed sensor (See page [BR-39](#)).

CHECK:

Check the sensor tip.

OK:

No scratches or foreign objects on the sensor tip.

NG

Replace sensor rotor or speed sensor.

NOTICE:

Check the speed sensor signal last (See page [DI-201](#)).

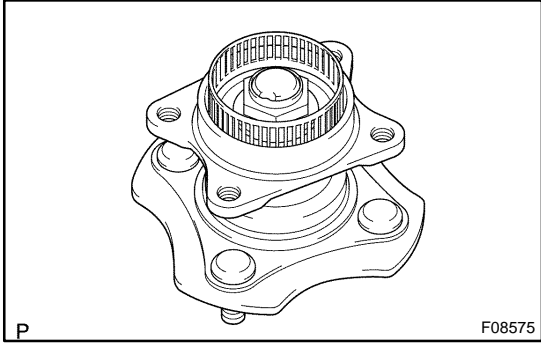

Rear:

PREPARATION:

Remove the axle hub and disconnect the rear speed sensor (See page [BR-42](#)).

CHECK:

Check the sensor rotor serrations.

OK:

No scratches or missing teeth or foreign objects.

CHECK:

Check the sensor tip.

OK:

No scratches or foreign objects on the sensor tip.

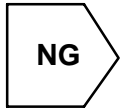

Replace sensor rotor or speed sensor.

NOTICE:

Check the speed sensor signal last (See page [DI-201](#)).

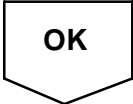

Check and replace ABS actuator assembly.